

THE LIBRARY
BRIGHAM YOUNG UNIVERSITY
PROV~~U~~ UTAH

Digitized by the Internet Archive
in 2011 with funding from
Brigham Young University

If Our agents
see at this office of the
American Specimen Book
of Type, in our letter

A 1037

Taking care of the Establis. We have entered the name
of address of the recipient to which we will send supplement
of other printed material issued from time to time
AMERICAN TYPE FOUNDRY COMPANY

COPYRIGHTED 1912
BY THE AMERICAN TYPE FOUNDERS COMPANY
JERSEY CITY, NEW JERSEY

ORIGINATOR OF TYPE FASHIONS

AMERICAN
SPECIMEN
BOOK OF
TYPE STYLES

*Complete
Catalogue of Printing Machinery
and Printing Supplies*

1912

American Type Founders
Company

EVERYTHING FOR THE PRINTER

American Type Founders Co.

Largest Type Foundry in the World



Selling Houses

BOSTON
270 Congress Street

NEW YORK
Rose and Duane Streets

PHILADELPHIA, PA.
17-19 South Sixth Street

RICHMOND, VA.
1320 East Franklin Street

BALTIMORE, MD.
213-215-217 Guilford Avenue

BUFFALO, N. Y.
45 North Division Street

PITTSBURGH, PA.
323 Third Avenue

CLEVELAND, OHIO
15 St. Clair Avenue, N. E.

CINCINNATI, OHIO
124-126-128 East Sixth Avenue

CHICAGO, ILL.
210 West Monroe Street

DETROIT, MICH.
43-45 W. Congress Street

ST. LOUIS, MO.
Ninth and Walnut Streets

MINNEAPOLIS, MINN.
419-423 Fourth Street, South

KANSAS CITY, MO.
602 Delaware Street

DENVER, COLO.
1621 Blake Street

PORTLAND, ORE.
92-94 Front Street

SAN FRANCISCO, CAL.
820-822 Mission Street

VANCOUVER, B. C.
Homer and Helmcken Streets

SEATTLE, WASH.
317 Second Avenue, South

SPOKANE, WASH.
Sprague Avenue and Browne Street

LOS ANGELES, CAL.
121 North Broadway

DALLAS, TEXAS
2024-2026 Commerce Street

Selling Agents

NEW YORK CITY
Conner, Fendler & Co.
96 Beekman Street

ATLANTA, GEORGIA
Dodson Printers Supply Co.
55 South Forsyth Street

MILWAUKEE, WIS.
Milwaukee Printers Supply House
125 Second Street

LOUISVILLE, KY.
Robert Rowell Company
441 West Main Street

NEW ORLEANS, LA.
E. C. Palmer & Company, Ltd.
433 Camp Street

TORONTO, CANADA
Toronto Type Foundry Co., Ltd.

MONTREAL, CANADA
Toronto Type Foundry Co., Ltd.

WINNIPEG, CANADA
Toronto Type Foundry Co., Ltd.

CALGARY, CANADA
Toronto Type Foundry Co. Ltd.

MELBOURNE, AUSTRALIA
S. Cooke, Proprietary, Ltd.
225 Queen Street

LONDON, E. C., ENGLAND
Linotype & Machinery, Ltd.
188 and 189 Fleet Street

CITY OF MEXICO, D. F., MEXICO
National Paper & Type Co.
7a De Nuevo Mexico 122

GUADALAJARA, MEXICO
National Paper & Type Co..
183 Avenida Colon

MONTERREY, N. L., MEXICO
National Paper & Type Co.
Dr Mier No. 107

HAVANA, CUBA
National Paper & Type Co.
Calle O'Reilly No. 46

NEW YORK CITY, N. Y., U. S. A.
National Paper & Type Co.
31 Burling Slip



TO THE PROGRESSIVE PRINTER

The contents of the American Specimen Book of Type Styles represent the fruits of the constant policy of the American Type Founders Company to design and manufacture Type Faces and Decorative Materials which broaden the printers' field of profits by thoroughly satisfying the buyers of printing and increasing the use and popularity of printed salesmanship.

THE DECISIVE CRITICS OF TYPE FACES

It may not be proper that we praise the beauty, symmetry, dignity, attractiveness and serviceability of the type designs of the American Type Founders Company; such praise may be suspected of bias, and adds no value to the type faces; but both the American Type Founders Company and the printers must defer to the opinions of the ultimate, decisive critics of type faces—the customers of the printers. The verdict of the buyers of printing is indicated by the almost exclusive use in the better class of commercial and periodical printing of type faces originated by the American Type Founders Company. To say that any printed work or advertisement is excellent and attractive is usually equivalent to saying that it is set in type made by the American Type Founders Company.

PROFITABLE vs. UNPROFITABLE TYPES

This Specimen Book contains no item which has outlived its usefulness and profitableness. Another specimen book as big as this one might be compiled of type faces which were in regular demand a few years ago, but which cannot now be used profitably. Not the least service the American Type Founders Company has rendered to the printers is that of discarding hundreds of series of type faces which do not conform to the present higher standard of typographic taste which has been created and fostered by the "Originator of Type Fashions."

If original and good type designs do not attract new business to the printer it is waste of time to produce them. If printers were restricted to the use of the old-fashioned type faces current at the beginning of this century the buyers of printing would now, as they did then, restrict their expenditures to the obviously necessary kinds of printing. The great expansion of the printing business began when printed salesmanship was made attractive and dignified and convincing by the original type designs of the American Type Founders Company. The commercial world took up the use of the great dominating type designs with the same alacrity with which it welcomed the telephone as a substitute for the messenger boy, and for the same reasons, better results and more profits. The narrow, old-fashioned superstition that the buyers of printing should be kept in ignorance of type faces is rapidly being superseded by a policy of advertising the printers' chief business-producing asset, well-selected type faces. To buy new type faces for the purpose of retaining, attracting and increasing business is as obviously necessary in the printing plant as a new stock of wares is necessary to maintain the prestige of any other dealer in merchandise. The printer who uses type faces made by the American Type Founders Company ranges himself with a great majority of the successful printers.

Set in Bodoni and Bodoni Italic



TYPE DESIGNING DEPARTMENT

The upper picture on page nine shows a section of the main Type Designing Room, in which the designs of the various members of the great type families are first worked out on paper, and then by ingenious mechanical devices transformed into metal patterns by a method, first used by the American Type Founders Company, which has revolutionized the art of producing patterns and matrices for casting types.

After the patterns are prepared they are used on the Benton Matrix Cutting Machines shown in the lower picture on page nine. These machines cut the matrices into the solid metal with a degree of accuracy impracticable by the hand processes which these machines have made obsolete in the Central Plant. These matrix cutting machines, and the machines for sharpening the cutters and measuring the work, are made and used exclusively by the American Type Founders Company.

The various inventions used in this department have made matrix-making an almost infallible science, where before it was the least scientific of type-making processes. In this connection the fact of real importance to the printer is that these inventions have considerably improved the quality of types, both artistically and mechanically.

TYPE CASTING DEPARTMENT

It would require a fair-sized volume to illustrate and describe all the departments of the Central Plant. We pass with a bare mention the Departments of Mould-making, of Brass Types and of Casting Machine Building and Repairs; the Matrix Vault, the Power House with its Electric Generating Plant, the Metal House, the Chemical Laboratory, the Shipping Department (illustrated on page eleven), and last, though not least, the extensive Specimen Printing Department in which this Specimen Book was printed.

On page ten will be found views of two Type Casting Bays, and a picture of the Barth Automatic Casting Machine made and used exclusively by the American Type Founders Company. There are six of these bays, each a large-sized type foundry in itself, lighted and ventilated on all sides and in the roofs. Each Barth Automatic Type Casting Machine requires electricity for power, gas for melting the metal, cold water for cooling the mould, and cooled air for regulating the temperature; and all the conduits for supplying these forces are under the floor.

In addition to the six Casting Bays, a section of the main floor more than thirty feet wide and extending one-half the width of the front of the building and two-thirds of the length of the building is occupied by various steam and hand casting machines, dressing machines, kerning machines and by various hand processes used in making type.

THE DIVIDING DEPARTMENT

The upper picture on page eleven is a view in the Main Dividing Room, which extends almost the entire length of the building. Above this room there is another Dividing Room of nearly the same extent. The Dividing Rooms are splendidly lighted and systematically arranged to take care of the product of the casting machines in adjoining rooms.

Millions of pounds of type are handled here annually.

Set in Bodoni



AMERICAN TYPE FAMILIES

The American Type Founders Company originated the policy of developing its dominating type designs into extensive type families. The printers were quick to appreciate the economy and other great advantages of purchasing related series as compared with the purchase of the same number of unrelated series. The related family series produce harmonious effects and may always be successfully used together in one composition. The addition of another related family series to previous purchases of the same family strengthens, freshens, reinvigorates and adds additional value to the previous purchases. This Specimen Book contains a splendid collection of Type Families and it is the policy of the American Type Founders Company to constantly add to the members of its many successful Type Families.

A COMPENDIUM OF TYPOGRAPHIC STYLE

A large proportion of the series shown in this Specimen Book are displayed in colors, with suitable decorative effects. These compositions are intended to be educational, not only to printers but to their customers. They are not printed so much to please as to profit. The aim has been to make this Specimen Book a gold mine for the printers, knowing that their prosperity is the prime essential to the prosperity of the American Type Founders Company.

The American Specimen Book of Type Styles is expected to be the printers' Typographic Guide Book, a source of profit and inspiration, a chief aid toward achieving good reputation and success in business.

THE CENTRAL PLANT

The major part of the type sold by the American Type Founders Company is made in the Central Plant, photographically illustrated on page eight. This building is entirely devoted to the manufacture of types and brass rules, for which purposes it was carefully and specially designed.

While it is a fact that the Central Plant is the most extensive type foundry in existence, none other nearly approaching it in size, the American Type Founders Company prides itself less on this fact than on the fact more important to its customers, that in every detail, small and large, the machines, the tools, the gauges and the manufacturing processes are perfected to a degree unknown in the typefoundry art as recently as ten years ago. Types were never before made so accurately or of such good quality as those now produced by the American Type Founders Company.

DISTRIBUTION OF PRODUCT

The staff and working force at the Central Plant do not deal directly with the buyers, but with the various Branches of the Company doing business in the various locations pictured on the four pages in this section of the catalogue and with agents in Europe, Canada, Mexico, Cuba, Central and South America and other countries. In each of these Branch Houses all the resources of the American Type Founders Company are available.

No printer is at any disadvantage on account of location. At no time have printers been afforded such perfect facilities.

Set in Bodoni

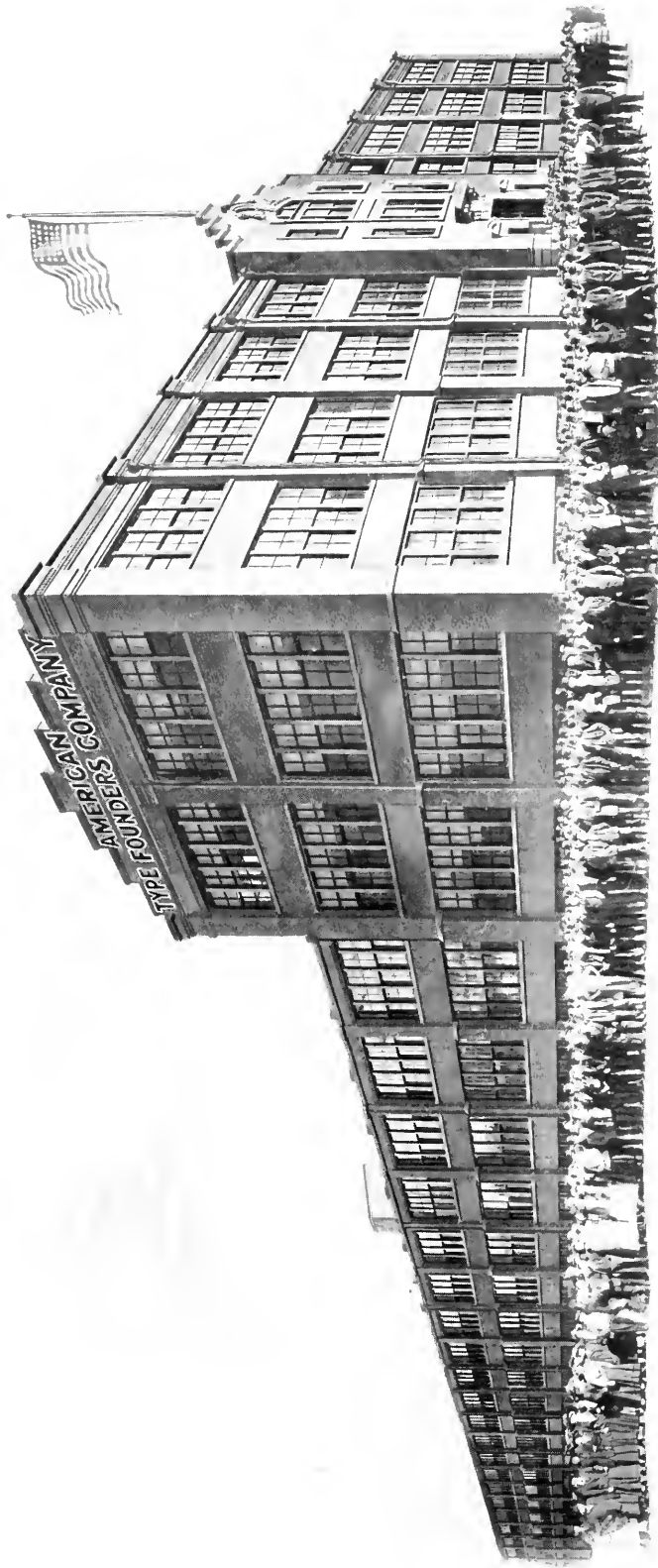

THE CENTRAL PLANT OF THE AMERICAN TYPE FOUNDERS COMPANY, JERSEY CITY, NEW JERSEY.

INTERIOR VIEWS OF A PART OF THE CENTRAL PLANT OF THE AMERICAN TYPE FOUNDERS COMPANY LOCATED AT NUMBER THREE HUNDRED COMMUNIPAW AVENUE E. JERSEY CITY, U. S. A.

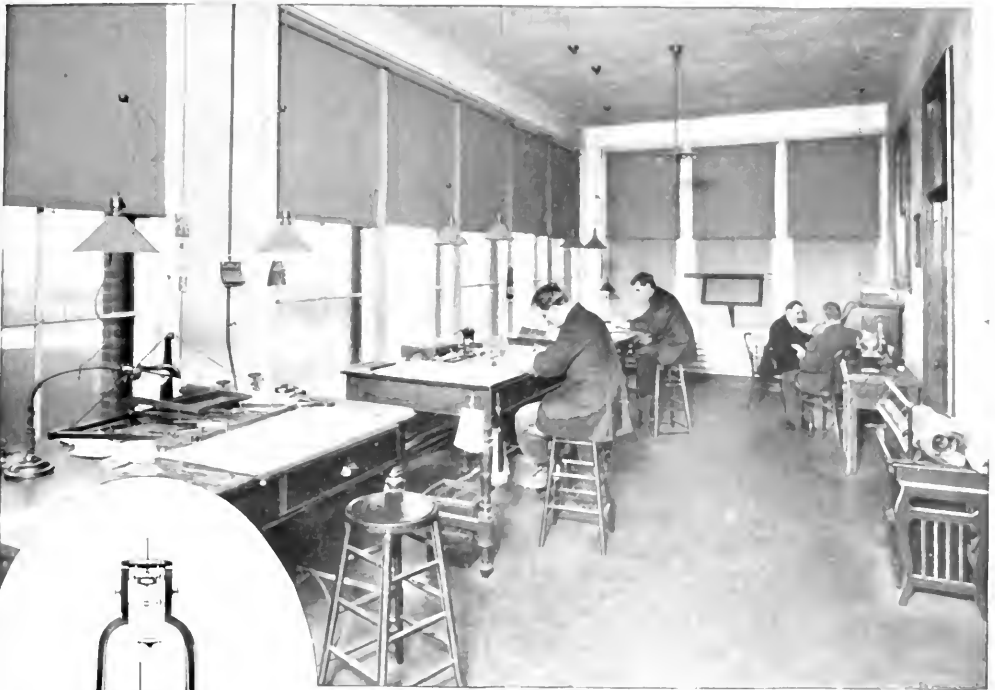

A CORNER OF THE DESIGNING ROOM



A VIEW OF THE MATRIX CUTTING MACHINES

INTERIOR VIEWS OF A PART OF THE CENTRAL PLANT OF THE AMERICAN TYPE FOUNDERS COMPANY LOCATED AT NUMBER THREE HUNDRED COMMUNIPAW AVENUE, JERSEY CITY, U. S. A.

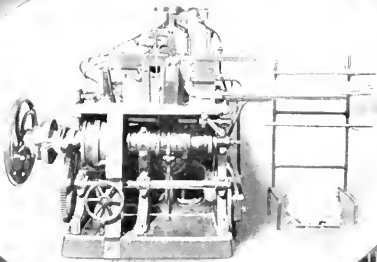
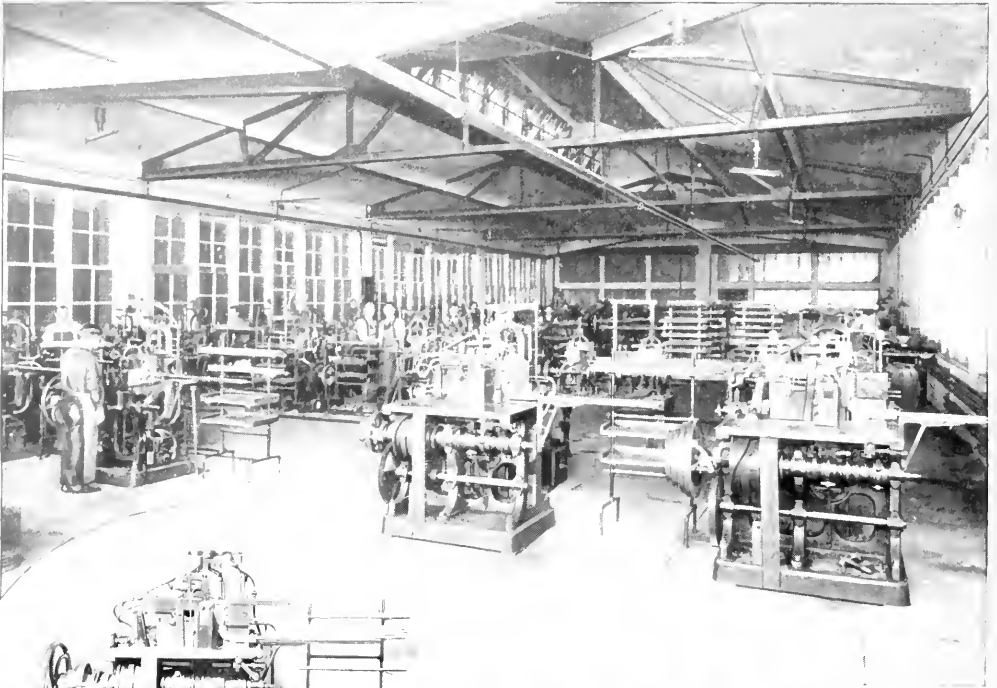

AUTOMATIC BAY



AUTOMATIC BAY

INTERIOR VIEWS OF A PART OF THE CENTRAL PLANT OF THE AMERICAN TYPE FOUNDERS COMPANY LOCATED AT NUMBER THREE HUNDRED COMMUNIPAW AVENUE, JERSEY CITY, U.S. A.



THE MAIN DIVIDING ROOM



CORNER OF THE SHIPPING ROOM

SELLING HOUSES OF THE AMERICAN TYPE FOUNDERS COMPANY



RICHMOND



NEW YORK

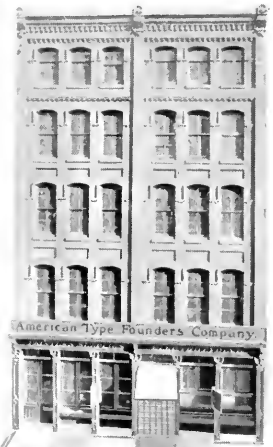

PHILADELPHIA



BALTIMORE



BOSTON

SELLING HOUSES OF THE AMERICAN TYPE FOUNDERS COMPANY



CLEVELAND



CINCINNATI



BUFFALO



DETROIT



PITTSBURG

SELLING HOUSES OF THE AMERICAN TYPE FOUNDERS COMPANY

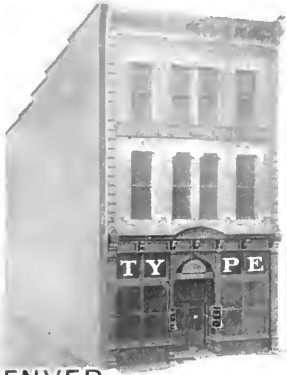

DENVER



MINNEAPOLIS



ST. LOUIS

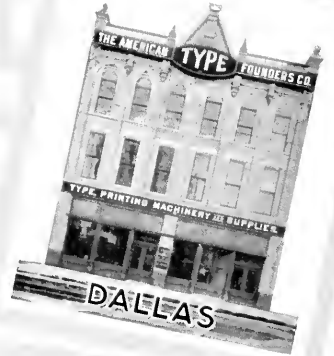

DALLAS

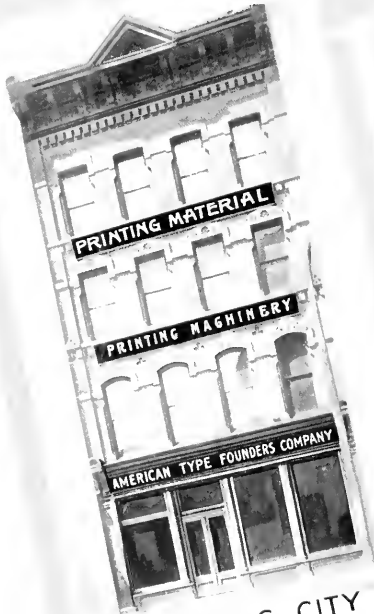

KANSAS CITY

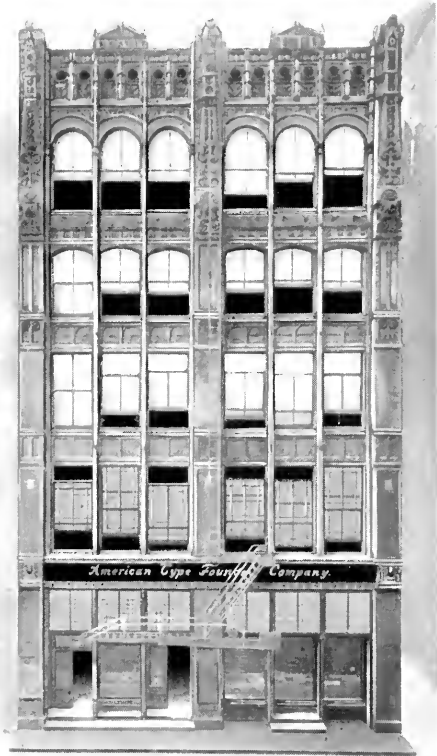

CHICAGO

SELLING HOUSES OF THE AMERICAN TYPE FOUNDERS COMPANY



LOS ANGELES



SEATTLE



VANCOUVER



PORTLAND



SPokane



SAN FRANCISCO

PROFITABLE FOR PRINTERS

*Study This Book—It is a Gold Mine
for the Progressive Printer*

IT IS MOST PROFITABLE and important that a PRINTER should acquire a thorough knowledge of Good Type Faces. Such knowledge is gained only by a careful study of Good Type Faces, and never before has there been such an opportunity for the effective study of Good Type Faces as is afforded by this book.

Study this Book page by page. It is not a mere price list, but a veritable Encyclopedia of Typographic Styles. Here are the Type Faces which have established the typographic fashions, and also beautiful examples of how these Type Faces can be used to please the Printer's Customers. These examples are not shown in this book to beautify it, but to demonstrate to Printers that Extra Profits may easily be obtained if the printing is done with Type Faces of Extra Quality in their Designs, which impart Extra Quality to the Printing.

Study this Book in the Interests of your own Customers.

After all is said and done, the Printer's work is judged chiefly by the Type Faces used in it. A Good Type Face may make poor paper and cheap inks passable, but the best qualities of papers and of inks are incapable of giving even a semblance of quality to Printing executed with Type Faces of inferior design.

Show your customers these beautiful Examples of Printing with Good Type Faces. These models will demonstrate to them the superior business-attracting power of Printing done with Good Type Faces, and persuade them to use More Printing and pay Better Prices.

Study *this* Specimen Book of Type Styles with the sole object of making it Profitable to yourself.

American Type Founders Company

INDEX

TO

American Specimen Book of Type Styles

AND

CATALOGUE OF PRINTERS' MACHINERY AND SUPPLIES

Subdivided and Alphabetically Indexed as follows: (*Index No. 1*) Type, Borders, Initials, Ornaments, etc.; (*Index No. 2*) Cast and Electrotyped Cuts; (*Index No. 3*) Brass Rules, Brass Braces and Dashes, Ovals and Circles, Round, Square and Slotted Corners, Cutting and Scoring Rule, etc.; (*Index No. 4*) Printers' Machinery, Tools, Miscellaneous Supplies and Wood Composing Room Furniture; (*Index No. 5*) Iron and Steel Printing Office Equipment

Index No. 1—TYPE, BORDERS, INITIALS AND ORNAMENTS

	PAGE
ABBOTT BORDER	1079
Acanthine Florets	1004
Accents	886, 887, 914
Accents, Piece	914
Acme Borders	1070, 1071
Adcuts	934-936
Adtype	572-575
Adtype Border	1030
Adver Border	1075
Adver Condensed	492, 493
ADVERTISING FIGURES	915-923
Series No. 50	921
Series No. 51	921
Series No. 53	920
Series No. 54	920
Series No. 60	922
Series No. 61	919
Series No. 62	919
Series No. 63	913
Series No. 64	923
Series No. 65	922
Series No. 66	918
Series No. 67	917
Series No. 68	917
Series No. 69	916
Series No. 70	916
Series No. 71	923
Series No. 72	915
Series No. 73	915
Aerial Cuts	956
Algebraic Signs	895
Alternate Gothic No. 1	722, 723, 726
Alternate Gothic No. 2	724-726
Alternate Gothic No. 3	727-729
American Extra Condensed	715
American Indians	1014
American Line Leaders, Brass	1108
American Line Leaders, Metal	890, 891
American Line Leads	890, 891
American Lining System (Diagram)	38
American Script No. 2, Lining	843
American Thin Spaces	1131
American Typewriter (Six and Ten Point)	858, 859
Antique No. 524, Lining	625
Antique No. 525, Lining	624
Anti-Tuberculosis Emblems	1002
Arithmetical Signs No. 150	898
Arlington Borders	1079
Armenian	877
Army and Navy Cuts	957, 1009
Arrow Ornaments and Arrows	929, 992
Art Borders	1024, 1025, 1042
Art Nouveau Border	1039
Art Ornaments	998, 999
Art-tiles and Outline Art-tiles	1096
Art-tile Tint Formers	1093
Astronomical Signs	893
Athletes	1013
Auxiliaries, Miscellaneous	898
Auxiliaries for New Caslon	905
Avil	416-419

	PAGE
BALLET DANCERS	1014
Baseball Blanks	930
Baseball Figures	930
Baseball Series No. 1	955
Baseball Series No. 2	954
Baseball Series No. 3	955
Basket Pieces, Floral	995
Beacon Border	1031
Beacon Ornaments	993
Beardsley Ornaments	993
Becker	825
Beveled Column Rules	1112
Bewick Borders	1034
Bewick Paragraph Marks	933
Bewick Roman	494-497
Bill of Fare Cuts	1144
Blair	686, 687
Blair Condensed	688, 689
Blanchard	530, 531
Blanchard Condensed	534, 535
Blanchard Italic	532, 533
Blanks for Baseball Scores and Engravers	930
Bodoni	68-71, 378-381
Bodoni Bold	390-393
Bodoni Book	72-75, 386, 387
Bodoni Book Italic	388, 389
Bodoni Italic	382-385
Bodoni Quotation Marks	899
BODY TYPE	43-144
Bodoni	68-71
Bodoni Book	72-75
Caslon Oldstyle No. 530	116-119
Century Expanded	60-67
Century Oldstyle	110-116
French Oldstyle No. 552	142, 143
Norwood Roman	84, 85
Oldstyle No. 523	134, 135
Oldstyle No. 550	136, 137
Oldstyle No. 579	124-127
Oldstyle No. 581	128-131
Oldstyle No. 583	132, 133
Recut Caslon	120-123
Roman No. 510	82, 83
Roman No. 524	89
Roman No. 527	89
Roman No. 590	86-88
Roman No. 596	40-93
Roman No. 599	91, 95
Ronaldson Oldstyle No. 551	138-141
Scotch Roman	76-79
Wayside	80, 81
Body Type Price List	44-143
Body Type Shown by Series	43-53, 92-103
Body Type Shown by Sizes	43-53, 92-103
BODY TYPE SUNDRIES	888-891
Accented Letters	886, 887, 914
American Line Leaders	890, 891
Braces and Dashes	888, 892, 905
Commercial Marks	888
Fractions	893, 894

INDEX

Index No. 1—TYPE, BORDERS, INITIALS AND ORNAMENTS—Continued

	PAGE		PAGE
BODY TYPE SUNDRIES—Continued	888-891		937-1096
Reference Marks	885, 888, 902		1070
Spaces and Quads, Price List	41		1082
Body Type Synopsis	44, 45, 96, 97		1041
Bold Antique	606-609		1043
Bold Antique Condensed	610-613		1042
Boldface Fractions	911		1065
Boldface Italic No. 520, Lining	651		1083
Boldface No. 520, Lining	651		1083
Bold Litho	366-369		945
Bold Pen Print	792, 793		1069
Bond Script	847		1077
BOOKLET AND CATALOGUE FACES			1066
Avil	416-419		1084
Bewick Roman	494-497		1079
Bodoni	68-71, 378-381		1053-1055
Bodoni Bold	390-393		1055
Bodoni Book	72-75, 386, 387		992 ^a
Bold Litho	366-369		1056
Bookman Oldstyle	420-423		1057-1064
Bulfinch	398-401		1031
Camelot Oldstyle	455		1045
Caslon No. 540	116-119, 314-319		1028
Century Bold	264-269		1080
Century Bold Condensed	274-277		1021
Century Bold Extended	278-281		1072
Century Expanded	60-67, 254-259		1071
Century Oldstyle	110-115, 234-237		1085
Century Oldstyle Bold	242-247		1073
Cheltenham Bold	178-181		1032
Cheltenham Medium	164-169		1041
Cheltenham Oldstyle	146-149		1032
Cheltenham Oldstyle Condensed	154-159		1018-1020, 1031, 1074
Cheltenham Wide	160-163		1026, 1027
Clearface	282-287		1039
Clearface Bold	292-297		1041
Condensed Caslon	342-347		1022, 1023
Condensed Dorsey	438-441		1081
Condensed MacFarland	476-479		1048
Della Robbia	406-409		1078
De Vinne Roman	604		1032
Dorsey	434-437		1068
Dorsey, Light	430, 431		1084
French Oldstyle No. 552, Lining	142, 143, 452, 453		992 ^b
Heavy Caslon	348-353		1017
Jenson Oldstyle No. 2, Lining	456-459		1048
Light Litho	370, 371		1084
Lining Cushing Monotone No. 553	451		1029
Lining Cushing No. 2	450		1076
Lining Florentine Oldstyle No. 502	584, 585		1047
Litho Roman	354-357		1047
MacFarland	470-473		1033
Meriontype	402, 408		1085
New Caslon	332-337		1085
Pabst Oldstyle	410-413		1016
Recut Caslon	120-123, 324-327		1072
Scotch Roman	76-79, 394-397		1067
Strathmore Oldstyle	614-617		1074
Winchel	508-511		1017
Booklet Ornaments	1011		1021
Bookman Italic	424-427		1095
Bookman Oldstyle	420-423		1043
Bookman Ornaments	1007		1087-1088, 1091
BORDERS	937-1096		1089, 1090
Abbot	1079		1069
Acme	1070, 1071		1145-1152
Adtype	1030		1053-1055
Adver	1075		540-543
Arlington	1079		1033
Art	1024, 1025-1042		544-547
Art Nouveau	1069		548-551
Art-tiles and Outline Art-tiles	1086		Boston Script No. 2, Lining
Art-tile Tint Formers	1086		844
Beacon	1031		Bowlers
Bewick	1034		Boxhead Gothic
Boston Breton Cast Squares	1093		Braces and Dashes No. 1
Bridal	1040		Braces and Dashes No. 2
Brier	1083		Braces, Brass
Brockton	1080		Braces, New Metal
Bruce Embellishers	1071		Braces, Six Point
Bulfinch	1046		Brackets (and Parentheses)
Cast Panel Pieces	1092		Bradley Initials
Cast Squares	1094		Brandon and Brandon Gothic
Celebration	1086		Brands
Century	1049-1052		Brass Rule (See Brass Rule Index No. 3)
Chap Book	1035		Brass Type
Chaucer	1036		Brier Border
Cheltenham	1037		Brockton Borders
Cloister	1038		Bulfinch
Colonial	1048		Bulfinch Attractors
Curtis	1048		Bulfinch Borders
Dainty Border No. 1	992 ^c		Burford Initials
Della Robbia	1044		Busha Mortised Initials
			Busha Ornaments
			1006

INDEX

Index No. 1—TYPE, BORDERS, INITIALS AND ORNAMENTS—Continued

	PAGE
C	
CALENDAR FIGURES	885, 925-928
Calendar Logotypes	926, 927
Camelot Oldstyle	455
Campaigners	1013
Cancelled Figures	892
Card Indicators	929
Card Mercantile	660, 661
Card Ends	929
CASLON FAMILY	116-123, 314-353
Caslon Italic No. 540, Lining	320-323
Caslon No. 540, Lining	116-119, 314-319
Caslon Text	814-815
Condensed Caslon	342-347
Heavy Caslon	848-853
New Caslon	332-337
New Caslon Italic	338-341
Recut Caslon	120-123, 324-327
Recut Caslon Italic	328-331
Cast Corners for Rule	1095
Cast Initials	937, 940-949
Cast Panel Pieces	1092
Cast Squares	1094
Cast Squares, French	945
CATALOGUE AND BOOKLET FACES	
Avil	416-419
Bewick Roman	494-497
Bodoni	68-71, 378-381
Bodoni Bold	390-393
Bodoni Book	72-75, 386, 387
Bold Litho	363, 369
Bookman Oldstyle	420-423
Bulfinch	393-401
Camelot Oldstyle	455
Caslon No. 540	116-119, 314-319
Century Bold	264-269
Century Bold Condensed	274-277
Century Bold Extended	278-281
Century Expanded	60-67, 254-259
Century Oldstyle	110-115, 234-237
Century Oldstyle Bold	242-247
Cheltenham Bold	176-181
Cheltenham Medium	164-169
Cheltenham Oldstyle	146-149
Cheltenham Oldstyle Condensed	154-159
Cheltenham Wide	160-163
Clearface	282-287
Clearface Bold	292-297
Condensed Caslon	342-347
Condensed Dorsey	438-441
Condensed McFarland	476-479
Della Robbia	406-409
De Vinne Roman	604
Dorsey	434-437
Dorsey, Light	430, 431
French Oldstyle No. 552, Lining	142, 143, 452, 453
Heavy Caslon	343-353
Jensen Oldstyle No. 2, Lining	456-459
Light Litho	370, 371
Lining Cushing Monotone No. 553	451
Lining Cushing No. 2	450
Lining Florentine Oldstyle No. 502	584, 585
Litho Roman	354-357
MacFarland	470-473
Meriontype	402, 403
New Caslon	332-337
Pabst Oldstyle	410-413
Recut Caslon	120-123, 324-327
Scotch Roman	76-79, 394-397
Strathmore Oldstyle	614-617
Winchell	508-511
Cathedral Text	820, 821
Cattle Brands	930
Caxton Initials	944
Celebration Border	1086
Cent and Per Cent Marks	859
Central Antique No. 2, Lining	622, 623
Century Border	1049-1052
CENTURY FAMILY	232-281
Century Bold	264-269
Century Bold Condensed	274-277
Century Bold Extended	278-281
Century Bold Italic	270-273
Century Expanded	60-67, 254-259
Century Expanded Italic	260-263
Century Oldstyle	110-115, 234-237
Century Oldstyle Bold	242-247
Century Oldstyle Bold Italic	245-253
Century Oldstyle Italic	238-241
Chap-Book Borders	1035
Chap-Book Cuts	990
Chap-Book Directors	989

Chap-Book Guidons	988
Chaucer Borders	1036
Chaucer Text	816, 817
Chefs and Waiters	1012
CHELTENHAM FAMILY	146-231
Cheltenham Bold	176-181
Cheltenham Bold Condensed	186-189
Cheltenham Bold Condensed Greek Characters	880
Cheltenham Bold Condensed Italic	190-198
Cheltenham Bold Extended	204-207
Cheltenham Bold Extra Condensed	194-199
Cheltenham Bold Extra Condensed Title	200-203
Cheltenham Bold Fractions	906
Cheltenham Bold Italic	182-185
Cheltenham Bold Outline	208-211
Cheltenham Bold Extrabold	226-231
Cheltenham Fractions	906
Cheltenham Inline	212-215
Cheltenham Inline Extended	220-223
Cheltenham Inline Extra Condensed	216-219
Cheltenham Italic	150-153
Cheltenham Medium	164-169
Cheltenham Medium Italic	170-175
Cheltenham Oldstyle	146-149
Cheltenham Oldstyle Condensed	154-159
Cheltenham Wide	160-163
Cheltenham Borders	1037
Chessmen and Checkers	924
Christmas Ornaments	1015
Church Text	818, 819
Cincinnati Initials	943
Circles, Ovals, Diamonds (See Brass Rule Index No. 3)	
Circular Quads	1222
CLEARFACE FAMILY	282-313
Clearface	282-287
Clearface Bold	292-297
Clearface Bold Italic	298-301
Clearface Gothic	310-313
Clearface Heavy	302-305
Clearface Heavy Italic	306-309
Clearface Italic	288-291
Cloister Black	810, 811
Cloister Borders	1038
Collins Florets	1002, 1003
Colonial Border	1048
Colonials	1010
Column Rules	1112
Combination Ornaments No. 63	997
Commerce Ornaments, 64 Point	992
Commerce Ornaments 36 Point	992 ^a
Commercial Gothic	711
Commercial Marks, Fractions and References	888, 889
Commercial Script	840, 841
Commercial Signs	895, 898
Compact	634, 635
Comparative Sizes Modern Roman Book Type	46-59
Comparative Sizes Oldstyle Roman Book Type	93-109
Compressed Litho	372, 373
Comstock	780, 781
Comstock Condensed	782, 783
Condensed Adver	492, 498
Condensed Blair	638, 639
Condensed Blanchard	534, 535
Condensed Bold Antique	610-613
Condensed Boston Breton	544-547
Condensed Caslon	342-347
Condensed Cheltenham Bold	138-153
Condensed Cheltenham Bold Italic	150-183
Condensed Cheltenham Oldstyle	154-159
Condensed Comstock	782, 783
Condensed Copperplate Gothic, Heavy	671-673
Condensed Copperplate Gothic, Light	670, 672, 673
Condensed Corbit	500, 501
Condensed De Vinne Fractions	907
Condensed De Vinne No. 2	594, 595
Condensed Dorsey	438-441
Condensed Florentine Bold	575-581
Condensed Foster	556-559
Condensed Franklin Gothic	740-743
Condensed Globe Gothic	766-769
Condensed Gothic Fractions No. 1	914
Condensed Gothic No. 4, Inland	713
Condensed Gothic No. 10	760, 761
Condensed Gothic No. 521, Lining	734
Condensed Gothic No. 523, Lining	735
Condensed Gothic No. 524, Lining	712, 713
Condensed Gothic No. 529, Lining	733
Condensed Jensen	462-465
Condensed Jensen Bold	466-469
Condensed Latin No. 550, Lining	654
Condensed Litho	360-363
Condensed MacFarland	476-479

INDEX

Index No. 1—TYPE, BORDERS, INITIALS AND ORNAMENTS—Continued

	PAGE		PAGE
Condensed Matthews	588, 589	Dorsey Italic, Light	432, 433
Condensed News Gothic	702-705	Dorsey, Light	430-431
Condensed Oldstyle No. 520, Lining	642	Druggists	1012
Condensed Oldstyle No. 522, Lining	643	Dutch Initials	946, 947
Condensed Post	522, 523		
Condensed Studley	482, 483		
Condensed Studley Fractions	909		
Condensed Title Gothic No. 3	736, 737		
Condensed Title Gothic No. 11	732		
Condensed Title Litho	364, 365		
Condensed Title No. 523, Lining	646		
Condensed Title No. 524, Lining	650		
Condensed Title No. 525, Lining	647		
Condensed Title Star Gothic	719		
Condensed Webb	564-567		
Condensed Winchell	512-515		
Contour Pointers	1007		
Copper Alloy Take Slugs	1223		
Copper and Brass Thin Spaces	1131		
COPPERPLATE GOTHIC FAMILY	670-685		
Copperplate Gothic Bold	683-685		
Copperplate Gothic Italic	682, 684		
Heavy Copperplate Gothic	675-677		
Heavy Copperplate Gothic Condensed	671-673		
Heavy Copperplate Gothic Extended	679-681		
Light Copperplate Gothic	674, 676		
Light Copperplate Gothic Condensed	670, 672		
Light Copperplate Gothic Extended	678, 680		
Copperplate, Inland	790, 791		
Copperplate Roman, Lining	663		
Coppers	1014		
Copyright Signs	902		
Corbitt	498, 499		
Corbitt Condensed	500, 501		
Corner Quads, Brass and Metal	1111, 1222		
Corners, Brazed Brass (See Brass Goods Index No. 3)			
Corners, Cast for Uniform Rule	1095		
Crosses and Stars	931		
Curtis Border	1048		
Curtis Post	796, 797		
Cushing Antique	618-621		
Cushing Fractions	912		
Cushing Italic No. 2, Lining	450		
Cushing Monotone No. 553, Lining	451		
Cushing No. 2, Lining	450		
Cushing Oldstyle Italic, Lining	446-449		
Cushing Oldstyle No. 2, Lining	442-445		
Cuts and Initials	937-1015		
Cuts, Electrotyped	1142, 1143		
Cutting and Scoring Rule, Steel and Brass	1111		
DASHES AND BRACES	883, 892, 905		
Dashes, Brass (See Brass Rule Index No. 3)			
Dashes, Lining Heavy Face	905		
Date Lines	1136		
DECORATIVE MATERIAL	937-1096		
Borders	1016-1091		
Cuts	954-1015		
Initials	937-953		
Definitions and Signs	895		
Della Robbia	406-409		
Della Robbia Borders	1044		
Della Robbia Festoons	1000		
Della Robbia Initials	937		
Della Robbia Ornaments	1000		
Della Robbia Paragraph Marks	933		
Delmonico Chefs and Waiters	1012		
Department Store Initials	945		
De Vinne Condensed Fractions	907		
DE VINNE FAMILY	590-605		
De Vinne Roman	604		
De Vinne Slope	605		
Lining De Vinne Condensed No. 2	594, 595		
Lining De Vinne Extended No. 2	600, 601		
Lining De Vinne Extra Condensed No. 2	596, 597		
Lining De Vinne Italic No. 2	598, 599		
Lining De Vinne Italic Outline No. 2	603		
Lining De Vinne No. 2	590-593		
Lining De Vinne Open No. 2	602		
De Vinne Fractions	907		
Dewey Ornaments	1005		
Diagonal Brass Corners	1111		
Diagonal Fraction Marks	892		
Dixon Ornaments	1000		
Domestics	1015		
Doric Fractions	911		
Doric No. 520, Lining	656		
Dorsey	434-437		
Dorsey Condensed	438-441		
EASTER BORDER	1082		
Efficiency Printing Plants (See Iron and Steel Printing Office Equipment Index No. 5)	1285-1304		
Egyptian Ornaments	1006		
Election Signs	932		
Electric Ornaments	1001		
Electrotyped Cuts	1137-1144		
Electrotyped Date Lines	1136		
Electrotyped Newspaper Headings	1134, 1135		
Electrotyped Running Titles	1133		
Electrotyped Sub Heads	1133		
Electrotyped Take Slugs	1223		
Elite Border	1041		
Elite Oliver Typewriter	853		
Elzevir Florets	1004		
Emblems, U. S.	1139		
Empire Borders	1040		
End Wood Borders	1150-1152		
Engravers Blanks	930		
Engravers Bold	658, 659		
Engravers Old English	804, 805		
Engravers Old English Bold	806, 809		
Engravers Old English Open	799		
Engravers Shaded	784, 785		
Esperanto	881		
Extended Cheltenham Bold	204-207		
Extended Cheltenham Inline	220-223		
Extended Copperplate Gothic Heavy	679-681		
Extended Copperplate Gothic Light	678-680		
Extended De Vinne No. 2	600, 601		
Extended Globe Gothic	768, 769, 772, 773		
Extended Studley	486, 487		
Extra Condensed Boston Breton	548-551		
Extra Condensed Cheltenham Bold	194-199		
Extra Condensed Cheltenham Bold Title	200-203		
Extra Condensed Cheltenham Inline	216-219		
Extra Condensed De Vinne No. 2	596, 597		
Extra Condensed Florentine Bold	582, 583		
Extra Condensed Franklin Gothic	744-747		
Extra Condensed Globe Gothic	768-771		
Extra Condensed Gothic No. 1	720		
Extra Condensed Miehle	626-629		
Extra Condensed Miehle Title	630-633		
Extra Condensed News Gothic	706, 707		
Extra Condensed News Gothic Title	708, 709		
Extra Condensed Studley	484, 485		
Extra Condensed Title Gothic No. 12	721		
FIGURES, ADVERTISING	915-923		
Figures, Calendar	885, 925, 928		
Figures, Cancelled	892		
Figures, Outline	917		
Figures, Special	894		
Figures, Time-Table	903		
Firecracker Borders	1043		
Fists	936		
Five Pointed Stars	931		
Flags	1138		
Flags, U. S. Signal	932		
Flame Borders	1042		
Flemish Black	812, 813		
Flemish Borders	1065		
Floral Basket Pieces	995		
Floral Borders No. 1 and No. 2	1083		
Florentine Bold	576, 577-580, 581		
Florentine Bold Condensed	578-581		
Florentine Bold Extra Condensed	582, 583		
Florentine Oldstyle No. 502, Lining	584, 585		
Florets, Acanthine	1004		
Florets, Collins	1002, 1003		
Florets, Elzevir	1004		
Florets, Haggood	1005		
Footnote Indicators	885		
Foot Slugs	1223		
Foreign Faces	869-881		
Foster	552-555		
Foster Condensed	556-559		
FRACTIONS			
Fraction Marks, Diagonal	892		
Fractions, Antique	906, 912		
Fractions, Body Type	889, 893, 894		
Fractions for Bold Face	911		
Fractions for Cheltenham Bold	906		
Fractions for Cheltenham Oldstyle	906		
Fractions for Condensed Gothic No. 1	914		
Fractions for Cushing	912		

INDEX

Index No. 1—TYPE, BORDERS, INITIALS AND ORNAMENTS—Continued

	PAGE
FRACTIONS—Continued	
Fractions for Doric	911
Fractions for Globe Gothic	912
Fractions for Gothic	910, 911
Fractions for Ionic	914
Fractions for Job Fonts	906-914
Fractions for New Caslon	908
Fractions for Oldstyle Antique	911
Fractions for Oldstyle Faces	906
Fractions for Roman	908
Fractions for Roycroft	913
Fractions, Piece	893, 894, 906-914
Fractions, Self-Spacing	893
Fractions, Special	894
Fractions, Superior and Inferior	894
Franklin Gothic	738, 739
Franklin Gothic Condensed	740-743
Franklin Gothic Extra Condensed	741-747
French Cast Squares	945
French Oldstyle Italic No. 552, Lining	454
French Oldstyle No. 552, Lining	142, 143, 452, 453
FURNITURE	
Composing Room, Etc	1233-1269
Iron	1202
Metal	1223
Quotation	1223
Reversible	1223
Steel	1223
Wood	1268
G	
GAELIC	877
Galt Borders	1069
GERMAN FACES	
German Full Face	874
German No. 571	876
German Text No. 10	869
German Title Condensed No. 150	875
German Title Extra Condensed	876
Heintzemann	874
Ihlenburg	870
Ihlenburg Extended	871
Schwabacher	872
Schwabacher No. 2	873
German Full Face	874
German No. 571	876
German Text No. 10	869
German Title Condensed No. 150	875
German Title Extra Condensed	876
Glad Hands	1007
Globe Gothic	764, 765, 768, 769
Globe Gothic Bold	774-777
Globe Gothic Bold Italic	776-779
Globe Gothic Condensed	766-769
Globe Gothic Extended	768, 769, 772, 773
Globe Gothic Extra Condensed	768-772
Globe Gothic Fractions	958, 959, 1015
Golfers	907
Gothic Condensed Fractions	713
Gothic Condensed No. 4	760, 761
Gothic Condensed No. 10	734
Gothic Condensed No. 521, Lining	735
Gothic Condensed No. 523, Lining	712, 713
Gothic Condensed No. 524, Lining	733
Gothic Condensed No. 529, Lining	720
Gothic Extra Condensed No. 1	910, 911
Gothic Fractions	911
Gothic Fractions No. 4	763
Gothic Inclined	763
Gothic Italic No. 512, Lining	763
Gothic Italic No. 524, Lining	714
Gothic No. 6	748, 749
Gothic No. 8	711
Gothic No. 513 to 529, Lining	731
Gothic No. 520 to 526, Lining	710
Gothic No. 544, Lining	730
Gothic No. 545, Lining	730
GOTHICS	
Alternate No. 1	722, 723, 726
Alternate No. 2	724, 726
Alternate No. 3	727, 729
American Extra Condensed	715
Blair	686, 687
Blair Condensed	688, 689
Boxhead	798
Clearface	310-313
Commercial	711
Condensed No. 10	760, 761
Condensed Title No. 3	736, 737
Condensed Title No. 11	732

	PAGE
GOTHICS—Continued	
Condensed Title Star	719
Copperplate Bold	683-685
Copperplate Italic	682-684
Extra Condensed No. 1	720
Extra Condensed Title No. 12	721
Franklin	738, 739
Franklin Condensed	740-743
Franklin Extra Condensed	744-747
Globe	764, 765, 768, 769
Globe Bold	774-777
Globe Bold Italic	776-779
Globe Condensed	766-769
Globe Extended	768, 769, 772, 773
Globe Extra Condensed	768, 770, 771
Heavy Copperplate	675-677
Heavy Copperplate Condensed	671-673
Heavy Copperplate Extended	679-681
Herald Extra Condensed	716, 717
Inclined	763
Inland Condensed No. 4	718
Inland No. 6	714
Inland No. 8	748, 749
Light Copperplate	674-676
Light Copperplate Condensed	670, 672, 673
Light Copperplate Extended	678-680
Lightline	668, 669
Light Litho	376
Lining Condensed No. 521	734
Lining Condensed No. 523	735
Lining Condensed No. 524	712, 713
Lining Condensed No. 529	733
Lining Inclined	763
Lining Italic No. 512	763
Lining Italic No. 524	763
Lining Mid	762
Lining Nos. 519, 527, 528, 529	711
Lining Nos. 520 to 526	731
Lining No. 544	710
Lining No. 545	730
Mercantile	693
Mitchell	692
Monotone	694, 695
Monotone Title	696, 697
News	698-701
News Condensed	702-705
News Extra Condensed	706, 707
News Extra Condensed Title	708, 709
Offset Light Litho	798
Railroad	758, 759
Times	752, 753, 756, 757
Times Italic	754-757
Title No. 7	714
Title No. 9	750, 751
Title Offset Light Litho	798
Typo	666, 667
Wedding	690, 691
Graphic Border	1077
Gray Borders, No. 1 and No. 2	1066
Greek Heavy Face	880
Greek Letters	880
Greek No. 2	880
Greek, Porson	880
Greek Type	880
Grille Border	1084
H	
HAPGOOD FLORETS	1005
Happy Thoughts	1001
Heading Condensed	636, 637
Headings for Newspapers (Electrotyped)	1134, 1135
Head Rules	1110
Hearst	536, 537
Hearst Initials	941
Hearst Italic	538, 539
Heavy Caslon	848-853
Heavy Copperplate Gothic	875-877
Heavy Copperplate Gothic Condensed	871-873
Heavy Copperplate Gothic Extended	679-681
Heavy Face Dashes Nos. 1, 2, 3, 4	905
Heavy Face Greek	880
Heavy Face Quotation Marks	899
Hebrew	878, 879
Heintzemann	874
Hello Cuts	1009
Herald Borders	1079
Herald Extra Condensed	716, 717
Hobo Series	568, 569
Hoboes	1012
Holiday Borders	1053-1055
Holiday Decorators	961-968, 1015
Holly Borders	1054, 1055
Hylite Borders	992
Hyphen Leaders	890

INDEX

Index No. 1—TYPE, BORDERS, INITIALS AND ORNAMENTS—Continued

	PAGE		PAGE
I			
Ihlenburg	870	Laurel Borders	1028
Ihlenburg Extended	871	Laurel Ornaments	996
Illustrations and Definitions of Signs	835	Law Italic No. 520, Lining	653
Imitation Typewriter Faces	849-868	Law Italic No. 522, Lining	653
Imprints	897	Leaders, American Line, Brass	1108
Imprint Matrices	897	Leaders, American Line, Metal	890, 891
Improved Calendar Figures	926, 927	Leads, American Line	1222
Improved Metal Braces and Dashes	892	Leads and Slugs, Brass	1111
Inclined Gothic	763	Leads and Slugs, Metal	1222
Index Cuts	936	Light Copperplate Gothic	674, 676
Indian Borders	1056	Light Copperplate Gothic Condensed	670, 672, 673
Indicators, Footnote	885	Light Copperplate Gothic Extended	678, 680
Industrial Ornaments, 54 Point	992	Light Dorsey	430, 431
Industrial Ornaments, 36 Point	992*	Light Dorsey Italic	432, 433
Inferior and Superior Letters and Figures	894	Lightface No. 558, Lining	649
Information for Buyers	40-42	Lightline	668, 669
		Light Litho	370, 371
INITIALS		Light Litho Gothic	798
Bradley	949	Light Litho Gothic Offset	798
Busha	948	Linear Borders	1021, 1080
Caxton	944	Lining American Script No. 2	843
Cincinnati	943	Lining Antique No. 524, 526	625
Della Robbia	937	Lining Antique No. 525	624
Department Store	945	Lining Boldface Italic No. 520	651
Durford	940	Lining Boldface No. 520	651
Dutch	846, 947	Lining Boston Script No. 2	844
Hearst	941	Lining Caslon Italic No. 540	320-323
Jenson	948	Lining Caslon No. 540	116-119, 314-319
Missal	944	Lining Central Antique No. 2	622, 623
Renaissance Mortised	951	Lining Condensed Title No. 523	646
Schoeffer	942	Lining Condensed Title No. 524	650
Sectional	953	Lining Condensed Title No. 525	647
Squares	949, 952	Lining Copperplate Roman	663
Strathmore Mortised	950, 951	Lining Cushing Italic No. 2	450
Versatile	938, 939	Lining Cushing Monotone No. 553	451
Versatile Mortised	949	Lining Cushing No. 2	450
Wood Cut Mortised	952	Lining Cushing Oldstyle Italic	446-449
Initial Squares, Mortised	952	Lining Cushing Oldstyle No. 2	442-445
		Lining De Vinne Condensed No. 2	594, 595
INITIALS—TWO COLOR		Lining De Vinne Extended No. 2	600, 601
Burford	940	Lining De Vinne Extra Condensed No. 2	596, 597
Busha Mortised	948	Lining De Vinne Italic No. 2	598, 599
Cincinnati	943	Lining De Vinne Italic Outline No. 2	603
Della Robbia	937	Lining De Vinne No. 2	590-593
Department Store	945	Lining De Vinne Open No. 2	602
Hearst	941	Lining Doric No. 520	656
Renaissance Mortised	951	Lining Florentine Oldstyle No. 502	584, 585
Sectional Initial Formers	953	Lining French Oldstyle Italic No. 552	454
Strathmore Mortised	950, 951	Lining French Oldstyle No. 552	142, 143, 452, 453
Versatile	938, 939	Lining Gothic Condensed No. 521	734
Versatile Mortised	949	Lining Gothic Condensed No. 523	735
Wood Cut Mortised	952	Lining Gothic Condensed No. 524	712, 713
Initial Squares, Mortised	952	Lining Gothic Condensed No. 529	733
Inland Borders	1057-1064	Lining Gothic Italic No. 512	763
Inland Condensed Gothic No. 4	718	Lining Gothic Italic No. 524	763
Inland Condensed Gothic No. 10	760, 761	Lining Gothic No. 519 to 523	711
Inland Copperplate	790, 791	Lining Gothic No. 520 to 526	711
Inland Extra Condensed Gothic No. 1	720	Lining Gothic No. 544	710
Inland Gothic No. 6	714	Lining Gothic No. 545	763
Inland Gothic No. 8	748, 749	Lining Inclined Gothic	625
Inland Gothic Nos. 1 and 3 Fractions	910	Lining Ionic No. 522	625
Ionic Fractions	914	Lining Jenson Italic No. 2	460, 461
Ionic Fractions No. 122	914	Lining Jenson Oldstyle No. 2	456-459
Ionic No. 522, Lining	625	Lining Latin Antique No. 520	655
Iron and Steel Printing Office Equipment	1285-1304	Lining Latin Condensed No. 550	654
		Lining Law Italic No. 520	653
J		Lining Law Italic No. 522	653
Jenson Bold Condensed	466-469	Lining Lightface No. 558	649
Jenson Condensed	462-465	Lining Livermore No. 2	846
Jenson Initials	948	Lining Mid-Gothic No. 2	762
Jenson Italic No. 2, Lining	460, 461	Lining Modern Antique No. 2	657
Jenson Oldstyle No. 2, Lining	456-459	Lining Oldstyle Antique No. 560	423, 429
Job Type Commercial Signs	898	Lining Oldstyle Condensed No. 520	642
Job Type Fractions	906-914	Lining Oldstyle Condensed No. 522	643
Job Type Price List	40, 41	Lining Oldstyle Italic No. 523	644
Job Type Weight Prices	40, 41	Lining Oldstyle No. 523	134, 135, 644
		Lining Oldstyle No. 550	136, 137
K		Lining Oldstyle Title No. 2	645
Kate Greenaway Mignonettes	1008	Lining Open Title No. 520	650
Klondikers	1009	Lining Quentell No. 2	640, 641
Knickerbocker Borders	1045	Lining Regal Italic No. 2	652
Knickerbocker Ornaments	982, 983	Lining Remington Typewriter No. 2	863
		Lining Roman No. 524 and 527	89
L		Lining Ronaldson Oldstyle No. 551	138-141
Labor-Saving Material		Lining Royal Script	838, 839
Brass Rule (See Brass Rule Index No. 3)		Lining Schoeffer Oldstyle No. 2	490, 491
Leads and Slugs	1222	Lining Smith-Premier Typewriter No. 2	864
Metal Furniture	1223	Lining Steelplate Script	842
Quotation Furniture	1223	Lining Title Nos. 524 and 534	648
Reversible Furniture	1223	Lining Title No. 551	649
Labor-Saving Metal Furniture	1223	Lining Tudor Black No. 2	822, 823
Labor-Saving Quotation Furniture	1223	Lining Victoria Italic	652
Lady Speakers (Large and Small)	1009	Linotype Column Rules	1112
Latin Antique Fractions	907	Listeners	1015
Latin Antique No. 520, Lining	655		
Latin Condensed No. 550, Lining	654		

INDEX

Index No. 1—TYPE, BORDERS, INITIALS AND ORNAMENTS—Continued

	PAGE
List of Quads, Prices	41
LITHO FAMILY	354-377, 786, 787, 798
Condensed Litho	360-363
Condensed Title Litho	364, 365
Light Litho	370, 371
Light Litho Gothic	376
Litho Antique	374, 375
Litho Bold	366-369
Litho Compressed	372, 373
Litho Gothic	377
Litho Roman	354-357
Offset Light Litho Gothic	798
Title Litho Roman	358, 359
Title Offset Light Litho Gothic	798
Title Shaded Litho	786, 787
Livermore No. 2, Lining	846
Locus Signili	931

LOGOTYPES	
Calendar	926-928
Mail List	904
Railroad	902
Theatre	932
Time-Table	902

M	
MacFarland	470-473
MacFarland Condensed	476-479
MacFarland Italic	474, 476
Machinery for Printers (See Index 4)	1153-1216
Magazine Borders	1072
Mail List Type and Logotypes	904
Maltese Crosses	981
Manila Border	1071
Margin Ornaments	1011
Matrices	897
Matthews	586, 587
Matthews Condensed	588, 589
McClure	488, 489
Meadow Border	1085
Medical Signs	896
Mercantile	662
Mercantile Bold	662
Mercantile Borders	662
Mercantile Gothic	1073
Meriontype	402, 403
Metal Braces and Dashes	892
Metal Corners for Brass Rule	945, 1067, 1092-1096
Metal Furniture	1223
Metal Leads and Slugs	1222
Mid-Gothic No. 2, Lining	762
Miehle Extra Condensed	626-629
Miehle Extra Condensed Title	630-633
Miniature Calendar Figures	885
Minimum Sort Rules for Type	41
Miscellaneous Electrotyped Cuts	1142, 1143
Miscellaneous Signs and Definitions	895
Miscellaneous Signs and Imprints	897
Missal Initials	944
Mission Toys	994, 995
Mitchell	692
Modern Antique No. 2, Lining	657
Modern Body Type	44-143
Monotone Border	1032
Monotone Gothic	694, 696
Monotone Title	696, 697
Mortised Initials	948-953
Mural Ornaments	996
Music Type	882-884
Myrtle Border	1041

N	
Nautical Signs	898
Navajo Border	1032
New Caslon	332-337
New Caslon Auxiliaries	905
New Caslon Fractions	908, 909
New Caslon Italic	338-341
New Metal Braces	892
New Model Elite Remington Typewriter	849
New Model Remington Typewriter	851
New Model Remington Typewriter No. 3	852
New Model Smith Premier Typewriter	856
New Model Smith Premier Typewriter No. 3	856
New Model Underwood Typewriter	857
News Gothic	698-701
News Gothic Condensed	702-705
News Gothic Extra Condensed	706, 707
News Gothic Extra Condensed Title	708, 709
Newspaper Borders	1018-1020, 1031, 1074
Newspaper Headings	1134, 1135
Newspaper Sub-Headings	1133
Norwood Roman	84, 85

	PAGE
OFFSET LIGHT LITHO GOTHIC	798
Offset Light Litho Gothic Title	798
Old English Borders	1026, 1027
Oldstyle Antique Fractions	911
Oldstyle Antique No. 560, Lining	423, 429
Oldstyle Body Type	96-143
Oldstyle Condensed No. 520, Lining	642
Oldstyle Condensed No. 522, Lining	648
Oldstyle Fractions	906
Oldstyle Italic No. 523, Lining	134, 135, 644
Oldstyle No. 523, Lining	136, 137
Oldstyle No. 550, Lining	124-127
Oldstyle No. 579	123-131
Oldstyle No. 581	132, 133
Oldstyle No. 583	98-109
Oldstyle Roman (shown by sizes)	645
Oldstyle Title No. 2, Lining	41
Old Type and Other Metals	862
Oliver Printtype	854
Oliver Typewriter	850
Open Title No. 520, Lining	850

ORNAMENTS	
Acanthine Florets	1004
Aerial Cuts	956
American Indians	1014
Anti-Tuberculosis	1002
Army and Navy	957, 1009
Arrow	992
Art	993, 999
Art-tiles and Outline Art-tiles	1096
Art-tile Tint Formers	1096
Athletes	1013
Ballet Dancers	1014
Baseball	954-955
Beacon	993
Beardsley	993
Bill of Fare Cuts	1144
Booklet	1011
Bookman	1007
Bowlera	1012
Bulfinch	960
Busha	1006
Campaigners	1013
Chap-Book	990
Chap-Book Directors	989
Chap-Book Guidons	953
Christmas	1016
Collins Florets	1002, 1003
Colonials	1010
Combination	997
Commerce, 36 Point	992*
Commerce, 54 Point	992
Coppers	1014
Della Robbia	1000
Delmonico Chefs and Waiters	1012
Dewey	1005
Dixon	1000
Domestics	1015
Druggists	1012
Egyptian	1008
Electric	1001
Elzevir Florets	1004
Flags, U. S.	1138
Floral Basket Pieces	995
Glad Hands	1007
Golf	958, 959, 1015
Happod Florets	1006
Happy Thoughts	1001
Hello Cuts	1009
Hoboes	1012
Holiday	961-963
Industrial, 36 Point	992*
Industrial, 54 Point	992
Kate Greenaway Mignonettes	1008
Klondikers	1009
Knickerbocker Ornaments	982, 983
Lady Speakers	1009
Laurel	996
Listeners	1015
Margin	1011
Midget Tailpieces	1004
Miscellaneous Cuts	1142, 1143
Mission Toys	994, 995
Mural	996
Page	1007
Pickups	1013
Printers	1007
Renaissance	991
Rigs and Traps	1018
Rogers Embellishments	1004
Rounders	1014
Scorchers	1010
Schull	992*

INDEX

Index No. 1—TYPE, BORDERS, INITIALS AND ORNAMENTS—Continued

	PAGE		PAGE
ORNAMENTS—Continued			
Shoppers	1010	Recut Caslon	120-123, 324-327
Silhouettes	1012	Recut Caslon Italic	328-331
Society Emblems	1140, 1141	References, Body Type	888
Speakers	1013	Regal Italic No. 2, Lining	652
State Seals	1137	Remington Typewriter, New Model	851
Strathmore	978-981	Remington Typewriter No. 2, Lining	863
Swastika	989	Remington Typewriter No. 3, New Model	852
Tailpieces	1044	Renaissance Mortised Initials	951
Trade Cuts	984	Renaissance Ornaments	991
Trees	997	Reproducing Typewriter	860, 861
Twentieth Century	969-971	Reversible Metal Furniture	1223
U. S. Emblems	1139	Ribbon Face Typewriter	868
Valentine	1007	Rigs and Traps	1013
Versatile	972-977	Rogers Embellishments	1004
Warships	957	Roman Fractions	908
Wayside	985-987	Roman No. 510	82, 83
Outline Art-tiles	1096	Roman No. 590	86-88
OUTLINE FACES			
Cheltenham Bold Outline	208-211	Roman No. 596	90-93
De Vinne Italic Outline	603	Roman No. 599	94-95
De Vinne Open	602	Ronaldson Oldstyle No. 551, Lining	138-141
Engravers Old English Open	799	Rose Borders	1068
Roycroft Open	506, 507	Round Corners, Brass	1118-1120
P			
PABST BORDERS	1039	Rounders	1014
Pabst Italic	414, 415	Royal Script, Lining	838, 839
Pabst Oldstyle	410-413	Roycroft	502-505
Page Ornaments	1007	Roycroft Fractions	913
Palm Borders	1041	Roycroft Open	506, 507
Panel Borders	1022, 1023	Roycroft Tinted	794, 795
Panel Brass Rule	1113	Russian	881
Panel Pieces	1092	S	
PARAGRAPH MARKS			
Bewick	933	SAINT JOHN	824
Caslon	933	Sansom Border	1084
Chap-Book Guidons	988	Scheme for Weight Fonts	42
Cheltenham	933	Schoeffer Oldstyle Initials	942
Della Robbia	933	Schoeffer Oldstyle No. 2, Lining	490, 491
Dorsey	933	Schuil Border	992 ^b
Priory	933	Schwabacher	872
Priory Open	933	Schwabacher No. 2	873
Parentheses	898, 900, 901	Scorchers (Large and Small)	1010
Parentheses and Brackets	896, 898, 900, 901	Scoring Rule, Brass and Steel	1111
Parts of Body Letter Fonts	41	Scott Roman	76-79, 394-397
Patriotic Borders	1081	SCRIPT FACES	
Pen Print	404, 405	American	843
Pen Print Bold	792, 793	Bond	847
Per Cent and Cent Marks	899	Boston	844
Perforated Rule, Brass and Steel	1111	Commercial	840, 841
Perpetual Calendar Logotypes	926-928	Livermore	846
Pickups	1013	Royal	838, 839
Piece Accents	914	Steelplate	842
Piece Fractions	893, 894	Typo (Name changed from Tiffany)	828, 829
Piece Root Signs	894	Typo Extended (Name changed from Tiffany)	830, 831
Pips for Cards	929	Typo Shaded (Name changed from Tiffany)	826, 827
Plain Face Rule, Brass	1098-1103	Typo Slope (Name changed from Tiffany)	834, 835
Pointers, Black, Shaded, Contour	1007	Typo Upright (Name changed from Tiffany)	832, 833
Point Leads, Labor Saving	1222	Typo Upright Bold	836, 837
Pontiac	638, 639	University	845
Porson Greek	880	Seals	930-931
Post Borders	1078	Seals, State	1137
Post Condensed	522, 523	Sectional Calendars	928
Post Monotone	526, 527	Sectional Initial Formers	953
Post Monotone No. 2	528, 529	Self-Spacing Piece Fractions	893
Post Oldstyle Italic	524, 525	Shaded Litho Title	786, 787
Post Oldstyle Roman No. 1	516, 517	Shaded Pointers	1007
Post Oldstyle Roman No. 2	518-521	Shaded Stars	831
Presses, Paper Cutters, etc. (See Index No. 4)		Shaw Text	802, 803
Price List of Body Type	40	Shoppers	1010
Price List of Brass Rule	1108-1112	SIGNS	
Price List of Job Type	40, 41	Algebraic	895
Price List of Spaces and Quads	41	Arithmetical	895, 898
Primrose Border	1032	Astronomical	895, 896, 898
QUADRUPLE CAST SQUARES			
Quads and Spaces	41	Commercial	895, 898
Quads and Spaces (Price List Job Fonts)	41	Ecclesiastical	895
Quads, Angular and Circular	1222	Job and Commercial	898
Quads, Corner	1111, 1223	Mathematical	895, 898
Quads, Quotation	1223	Medical	895, 898
Quentell Fractions	910	Miscellaneous	897, 898
Quentell No. 2, Lining	640, 641	Nautical	898
Quotation Furniture	1223	Piece Root	894
Quotation Marks	899	Radical, Special	893
R			
RABBINIC	881	Weather	932
Radical Signs	898	Signs and Definitions	895
Railroad Gothic	758, 759	Signs and Logotypes for Time-Tables	902
Recipe Marks	929	Silhouettes	1012
		Silk Remington Typewriter	850
		Six Point American Typewriter	858
		Six Point Borders	1017
		Six Point Braces and Dashes	888, 892
		Sizes of Minimum Weight Fonts	40
		Slocum Seals	930
		Slugs and Leads, Metal	1222
		Slugs, Brass	1111

INDEX

Index No. 1—TYPE, BORDERS, INITIALS AND ORNAMENTS—Continued

	PAGE
Slugs, Foot	1223
Slugs, Take	1223
Smith-Premier Typewriter	856, 864
Smith-Premier Typewriter No. 2, Lining	864
Smith-Premier Typewriter No. 3, New Model	856
Society Cuts, Electrotyped	1140, 1141
Spaces and Quads	41
Spaces and Quads, Price List, Job Fonts	41
Spaces, Thin	1231
Speakers	1013
Special Brackets	898
Special Figures	894
Special Parentheses	898
Special Signs	893-902
Square Brass Corners	1121
Squares, Cast	1094
Standard Typewriter	866
Star Borders	1048
Star Rule, Wood	1152
Stars and Maltese Crosses	931
Stars, Five Pointed	931, 1048
State Seals	1137
Steel and Brass Perforating Rules	1111
Steel and Iron Printing Office Equipment	1285-1304
Steel Cutting and Scoring Rule	1111
Steelplate Script, Lining	842
Stenograf	867
Strand Borders	1084
Strathmore Borders	1029
Strathmore Mortised Initials	950, 951
Strathmore Oldstyle	614-617
Strathmore Ornaments	978-981
Strip Rule	1098-1104
Studley	480, 481
Studley Condensed	482, 483
Studley Condensed Fractions	909
Studley Extended	486, 487
Studley Extra Condensed	484, 485
Stylus Border	1076
Sub Heads for Newspapers	1133
Sundries for Body Type	888-891
Superior and Inferior Letters	894
Swastika Borders (Black and Outline)	1047
Swastika Ornaments	989
Synopsis of Lining Modern Roman	44-48
Synopsis of Lining Oldstyle Roman	96-97
T ABARD	570, 571
Tabard Borders	1033
Tables giving Brass Rule Prices	1108-1112
Tailpieces	1004, 1144
Take Slugs	1223
Tariff Signs	602
Teasel Border	1065
Ten Point American Typewriter	859
TEXT FACES	
Becker	825
Caslon	814, 815
Cathedral	820, 821
Chaucer	816, 817
Church	818, 819
Cloister Black	810, 811
Engravers Old English	804, 805
Engravers Old English Bold	806-809
Engravers Old English Open	799
Flemish Black	812, 813
Saint John	824
Shaw	802, 803
Tudor Black	822, 823
Typo Text	788, 789
Wedding	800, 801
Theatre Logotypes	932
Thin Spaces, Brass and Copper	1231
Thistle Border	1085
Three Point Borders	1016
Tiffany Faces (name changed to Typo)	788, 789, 826, 827, 830-837
Time-Saving Mail List Type and Logos	904
Times Borders	1072
Times Gothic	752, 753, 756, 757
Times Gothic Italic	754-757
Time-Table Figures	903
Time-Table Logotypes, Signs and References	902
Title Gothic Condensed No. 3	736
Title Gothic Extra Condensed No. 12	721
Title Gothic No. 7	714
Title Gothic No. 9	750, 751
Title Light Litho	370
Title Litho Roman	358, 359
Title No. 551, Lining	649
Title Offset Light Litho Gothic	798
Title Shaded Litho	786, 787

Trade Cuts	964
Trade Marks	934-986
Tree Ornaments	977
Tricky Borders	1067
Triple Line Borders	1074
Tudor Black No. 2, Lining	822, 823
Twelve Point Borders	1017
Twentieth Century Ornaments	969-971
TWO COLOR INITIALS	
Burford	940
Bush Mortised	948
Cincinnati	943
Della Robbia	937
Department Store	945
Hearst	941
Renaissance Mortised	951
Sectional Initial Formers	953
Strathmore Mortised	950, 951
Versatile	938, 939
Versatile Mortised	949
Wood Cut Mortised	952
Type for Mail Lists	904
TYPEWRITER FACES	
Eight Point Reproducing	860
Six Point American	858
Six Point Reproducing	860
Ten Point American	859
Ten Point Elite Oliver	833
Ten Point New Model Elite Remington	849
Ten Point Reproducing	861
Twelve Point Lining Remington No. 2	863
Twelve Point Lining Smith-Premier No. 2	864
Twelve Point New Model Remington	851
Twelve Point New Model Remington No. 3	852
Twelve Point New Model Smith-Premier	855
Twelve Point New Model Smith-Premier No. 3	856
Twelve Point New Model Underwood	857
Twelve Point Oliver	854
Twelve Point Oliver Printype	862
Twelve Point Ribbonface	868
Twelve Point Silk Remington	850
Twelve Point Standard	866
Twelve Point Stenograf	867
Twelve Point Yost	865
Typo Gothic (Name changed from Tiffany)	666, 667
Typo Script (Name changed from Tiffany)	628, 629
Typo Script Extended (Name changed from Tiffany)	830, 831
Typo Shaded (Name changed from Tiffany)	826, 827
Typo Slope (Name changed from Tiffany)	834, 835
Typotect Borders	1021
Typo Text (Name changed from Tiffany)	788, 789
Typo Upright (Name changed from Tiffany)	832, 833
Typo Upright Bold	836, 837
UNIFORM RULE CAST CORNERS	1096
Unit Borders	1043
University Script	845
U. S. Emblems	1139
U. S. Flags	1138
U. S. Signal Flags	932
VERSATILE BORDERS	1087-1091
Versatile Initials	933, 939
Versatile Mortised Ornaments	949
Versatile Ornaments	972-977
Victoria Italic, Lining	852
Victory Border	1069
WARSHIPS	957
Wayside Ornaments	955-957
Wayside Series	80, 81
Weather Indicators	932
Webb	560-564
Webb Condensed	564-567
Wedding Gothic	690, 691
Wedding Text	800, 801
Weight Fonts of Type	42
Whist Markers	929
Winchell	608-511
Winchell Condensed	512-515
Wood Borders	1150-1152
Wood Cut Mortised Initials	952
Wood Goods for Printers (See Index No. 4)	
Wood Rule	1150-1152
Wood Type	1146-1149
YOST TYPEWRITER	865

INDEX

Index No. 2—ELECTROTYPED CUTS

NO.	PAGE	PRICE	NO.	PAGE	PRICE	NO.	PAGE	PRICE	NO.	PAGE	PRICE
1	1137	\$0.75	2052	1143	\$0.60	2968	1139	\$0.40	3867C	1144	\$0.40
26	1142	.25	2054	1143	.60	2969C	1138	.15	3872C	1144	.40
61C	1142	.25	2055	1143	.60	2997C	1144	.60	3878C	1144	.50
164	1141	.30	2062	1142	.60	3023C	1139	.25	3881C	1144	.50
170	1142	.25	2078	1140	.60	3037C	1143	.40	3885C	1144	.30
173	1141	.25	2080	1141	.35	3054C	1143	.75	3886C	1144	.30
177	1141	.25	2102	1141	.35	3055C	1143	.40	3887C	1144	.30
179	1141	.25	2113	1141	.35	3092A	1141	.30	3902C	1142	.75
183	1140	.20	2116	1141	.30	3095C	1142	.50	3938C	1142	.75
191	1141	.30	2158C	1139	1.25	3127C	1137	.75	3944C	1143	.15
267	1141	.35	2213 1/2 C	1139	.65	3137C	1137	.75	3949C	1142	.50
272	1142	.35	2240C	1137	1.00	3138A	1140	.30	3952C	1141	.75
203	1140	.50	2241C	1137	1.00	3139A	1140	.40	3957C	1144	.40
204	1140	.40	2290 1/2 C	1139	.60	3142A	1141	.40	3972C	1141	.50
217	1140	.30	2356C	1142	.40	3146C	1144	.40	4042	1143	.15
224	1140	.50	2385C	1139	.50	3172A	1140	.40	4054C	1144	.50
225	1140	.40	2425C	1142	.30	3188C	1139	1.00	4056C	1144	.50
228	1140	.50	2435C	1142	.75	3198A	1140	.50	4058C	1144	.50
229	1140	.35	2443C	1139	.30	3293C	1141	.30	4060C	1144	.50
232	1140	.40	2444C	1139	.40	3407C	1140	.40	4065C	1144	.60
234	1140	.50	2466C	1142	.35	3410C	1142	.60	4069C	1144	.50
242	1140	.35	2471C	1139	.40	3453C	1139	.75	4070C	1144	.50
247	1141	.30	2646C	1140	.40	3455C	1140	.35	4092C	1142	.50
256	1141	.40	2695C	1142	.50	3460C	1139	.25	4099	1143	.30
259	1140	.50	2708C	1142	.75	3498C	1142	.75	4120C	1141	.60
264	1141	.35	2709C	1138	.40	3354C	1140	.30	4140C	1141	.50
402C	1142	.25	2711C	1138	.40	3355C	1140	.30	4144C	1141	.40
507	1142	.25	2712C	1138	.65	3356C	1140	.40	4149	1143	.40
857C	1139	.25	2713C	1138	.65	3359C	1140	.25	4191C	1137	.75
868	1142	.30	2727C	1139	.25	3501C	1144	.50	5000C	1137	.75
901	1141	.25	2730C	1137	.75	3503C	1144	.50	5107C	1140	.75
902	1141	.30	2734C	1137	.75	3535C	1144	.35	5127C	1138	3.00
904	1141	.25	2735C	1137	.75	3559	1143	.40	5127 1/2 C	1138	1.50
916	1141	.25	2751C	1137	1.50	3656C	1140	.25	5142C	1138	.75
1207	1140	.40	2752C	1139	.45	3658C	1140	.30	5143C	1138	1.50
1225C	1140	.30	2755C	1137	.75	3659C	1141	.30	5144C	1138	1.00
1324	1140	.50	2766C	1137	.75	3750C	1143	.60	5145C	1138	2.00
1336	1141	.40	2778C	1137	.75	3790C	1139	.65	6003C	1142	.50
1341	1141	.35	2780C	1137	.75	3795C	1142	.50	12137C	1140	.50
1344	1141	.50	2785C	1137	.75	3800C	1143	.30			
1750	1143	.35	2929C	1143	.60	3816C	1143	.75			
2016	1141	.30	2943C	1141	.25	3866C	1144	.40			

For Baseball Cast Cuts, Aerial Cast Cuts, Army and Navy and Warship Cast Cuts, Golfers, Holiday Decorators, Twentieth Century Ornaments, Trade Cuts, Chap Book Cuts, Commerce and Industrial Cuts, Mission Toys and all other Cuts and Ornaments cast in type molds, see Type Index No. 1 on preceding pages.

Index No. 3—BRASS RULES, BRASS BRACES AND DASHES, OVALS AND CIRCLES, ROUND, SQUARE AND SLOTTED CORNERS, CUTTING AND SCORING RULE, Etc.

	PAGE		PAGE
Adjustable Dotted Rule	1129	Leaders, Specimens of	1105
Advertising Rules	1110	Leads and Slugs, Brass	1111
American Thin Spaces	1131	Linotype Column Rule	1112
Beveled Linotype Column Rule	1112	Linotype Tabular Rule, Rogers	1111
Braces, Brass	1124	Metal Corner Quads	1111
Brass and Copper Spaces	1131	Miters, fonts of Panel Rule, Price List	1109
Brass Galleys	1204, 1205	Miters, fonts of Panel Rule, Specimen	1113
Brass Rule for Metal Borders	1130	Miters in fonts, Price List (Table D)	1108
Brazed Corners	1114-1117	Miters in sets, Price List (Table E)	1108
Center Pieces	1121	Miters, Interlocking	1129
Circles and Ovals	1126-1128	Miters, page, Price List (Table F)	1108
Column Rule	1112	Ovals, Brass	1128
Copper Spaces	1131	Panel Rule	1113
Corner Quads, Brass and Metal	1111	Perforating Rule, Brass and Steel	1111
Creasing Rule, Brass and Steel	1111	Rogers Linotype Tabular Rules	1111
Cross Rules	1110	Round Corners	1118, 1119
Cut Rule, Price List	1109	Round Corners, for full face rules	1120
Cutting Rule, Steel	1111	Rugged Rules	1122, 1123
Dashes, Newspaper	1125	Scoring Rule, Brass and Steel	1111
Dash Rules, Regular	1112	Shaded Rules	1104
Diagonal Corners	1121	Slotted Corners	1113
Diamonds	1128	Sorts of Brass Rule, Price List (Tables H and F)	1109
Dotted and Hyphen Rule	1101	Space Rule, Price List (Table K)	1108
Foot Slugs, Brass and Metal	1112	Square Corners, for plain face rules	1113
Head Rules	1110	Squares, Brass	1121
Labor Saving Rule, Price List	1108	Stipple Rules	1104
Labor Saving Rule, Specimen of	1105-1107	Strip Rule, Price List	1108
Leaders, Price List	1108	Strip Rule, Specimen of	1098-1104
Leaders, Price List of Short Pieces (Table K)	1108	Wave Rule	1100

For Printing Presses, Paper Cutters, Printers' Wood Goods and Supplies, Galleys, Chases and all Supplies, see Index No. 4 following.

For Iron and Steel Composing Room Furniture and other special items, see Index No. 5.

INDEX

Index No. 4—PRINTERS' MACHINERY, TOOLS, MISCELLANEOUS SUPPLIES AND WOOD GOODS AND WOOD COMPOSING ROOM FURNITURE

	PAGE		PAGE
A			
ACME MAILING MACHINE	1188	Boston Staple Binder	1171
Acme Staple Binder	1171	Boston Staple Binder Work Table Extension	1174
Acme Staples	1229	Boston Wetter Numbering Machine	1230
Addressing Machines	1188	Boston Wire Staples	1230
Ad-Foramen's Desk	1255	Boston Wire Stitching Machines	1172, 1173
Ad-Man's Cabinet	1210	Boston Wire Stitcher Work Table Extension	1173
Adjustable Hangers	1209	Boxwood Type Measures	1211
Adjustable Lead and Slug Case	1277	Brackets	1284*
Advance Paper Cutters	1169	Brackets, Case	1281*
Advertising Measures	1210, 1211	Brackets, Galley	1281*
Adzit Galley Lock	1205	Brackets, Patent Tilting	1284
Algoma Imposing Stone Frame	1256	Brackets, Roller	1284
All-Brass Galleys	1204	Brake for Job Presses	1215
All-Brass Graduated Galleys	1204	Brass and Copper Thin Spaces	1191
All-Brass Linotype Galleys	1205	Brass and Metal Corner Quads	1111, 1215
All-Brass Monotype Galleys	1204	Brass Eyelets	1180, 1215
All-Brass News Sticks	1210	Brass Galleys	1204, 1205
American Bookbinders' Steel Wire	1229	Brass Goods (See <i>Brass Rule Index No. 3</i>)	1097-1130
American Brass Label Holders	1253	Brass Label Holders	1253
American Brazed Steel Chases	1221	Brass Leader Case, Ideal	1283
American Counting Machine	1193	Brass Leaders, American Line	1108
American Drying Rack and Stock Table	1265	Brass Leads, American Line	1111
American Job Press Brake	1215	Brass Lined Galleys	1205
American Job Press Counter	1193	Brass Type Measures	1210, 1211
American Lead and Rule Cutters	1191	Brayers	1228
American Lettering Pallet	1215	Brazed Steel Chases	1221
American Line Leads	1222	Breech Loader Staple Binder	1175
American Numbering Machines	1197	Bright Steel Chases	1221
American Patent All-Brass Galleys	1204	Bright Steel Galleys	1206
American Press Seats	1192	Bronzing Mittens	1224
American Roller Spray	1227	Bronzing Pads	1221
American Roughing Machine	1170	Brower Drum Cylinder Press	1157
American Steel Run Cabinet No. 2	1238	Brown & Carver and Oswego Cutters	1165, 1168
American Thin Spaces	1131	Brushes	1216, 1221
American Type Measures	1211	Buckeye Composing Sticks	1210
Angular Quads	1222	Buckeye Ink Fountain	1186
Atlas Hand Numbering Machines	1197	Bullock Ejector Press Punch	1189
		Burbank's Embossing Composition	1227
		Burch Perforators	1161
		Byerly Figure Cases	1277
B			
BASES AND BLOCKS		C	
Cast Iron	1200	CABINETS	
Challenge	1200	Ad-Man's	1240
Mills	1201	American Steel Run No. 2	1238
Rabbeted	1200	Bookbinders'	1272
Rouse	1198, 1201	Border and Script Type	1253
Suddard	1199	Cardboard and Paper Stock	1265, 1272
Wesel	1200	Cut	1248
Wilson	1200	Dorsey Combination Pressroom	1254
Rates Hand Numbering Machines	1197	Dorsey Compositors' Working	1252
Beating Brushes, Stereotype	1216	Electro and Cut	1248
Bellows	1214	Extension Front	1238
Bench Cutters	1170	Furniture, Metal	1266, 1269
Benzine Brushes	1224	Galley	1252, 1254
		Grand	1235
BENZINE CANS		Handy Letter Board	1261
Imperial Non-Explosive	1224	Handy Sort	1239
Steel Clad	1224	Indexed Electrotypes	1248
Success Safety	1224	Ink and Roller	1250
Bettis Lead and Slug Cases	1279, 1280	Iron (See <i>Index No. 5</i>)	
Bettis Space and Quad Case	1279	Job Press	1250
Beveled Furniture	1268	Lead and Slug	1269
Binders, Staple	1174, 1175	Letter Board	1264
Bindery Tables	1173	Linotype Ejector Blade	1251
Bindery Tables, Boston	1173	Linotype Magazine	1250
Bindery Trucks	1190	Linotype Matrix	1251
Blankbook Sewing Bench	1271	Masterman	1239
Blankets, Felt and Rubber	1228	Metal Furniture	1266, 1269
Blocks and Bases	1198-1200	Monotype	1251
Bodkins	1214	New Departure	1241
Book and Job Galley Cabinets	1254	Page Form Storage	1254
Book Chases	1218	Paper and Card Stock	1272
Bookbinders' Boards	1271	Polhemus	1231
Bookbinders' Cabinets	1272	Porter Extension Front, Steel-Run	1238
Bookbinders' Cutting Gauges	1272	Pressman's Register	1265
Bookbinders' Sewing Benches	1271	Pressroom, Dorsey	1254
Bookbinders' Finishing Stands	1272	Reversible Unit	1236, 1237
Bookbinders' Gilding Presses	1270	Roller	1950
Bookbinders' Gold Cushions	1215	Rowen Border and Script	1253
Bookbinders' Lettering Pallet	1215	Specimen	1249
Bookbinders' Materials and Supplies	1270, 1273	Stationery and Cardboard	1272
Bookbinders' Ploer and Press	1270	Steel (See <i>Index No. 5</i>)	
Bookbinders' Press Boards	1271	Steel Run New Departure	1241
Bookbinders' Rubbing-up Sticks	1270	Steel Run Porter	1238
Bookbinders' Sewing Bench	1270	Steel Run Stands (see <i>case stands</i>)	
Bookbinders' Straight Edge	1272	Strip Lead and Rule	1240
Bookbinders' Tables	1272	Tracy	1240
Bookbinders' Wire	1229	Tympan Paper	1265
Border Cases	1283	Wisconsin Hard Wood	1243
Border and Script Type Cabinets	1253	Wisconsin Window	1242
Boston Benzine Brush	1224	Wood Type	1249
Boston Bindery Tables	1173		
Boston Lead Rack	1266		

INDEX

Index No. 4—PRINTERS' MACHINERY, TOOLS, MISCELLANEOUS SUPPLIES AND WOOD GOODS AND WOOD COMPOSING ROOM FURNITURE—Continued

	PAGE		PAGE
California Job Cases	1274		
Cans, Benzine	1224		
Cap Case	1274, 1276		
Carborundum Knife Stones	1170		
Card Cutters	1207		
Card Index Punch Heads	1176, 1182		
Card Stock Cabinets	1272		
Carpenter Quarter Case	1283		
Case Brackets	1284 ^a , 1284 ^b		
Case Pulls	1214		
Case Racks	1247, 1248		
CASES			
Accent	1283		
Accent, Dearing	1275		
Accent, One-Quarter	1283		
Adjustable Lead and Slug	1277		
All Right Space and Quad	1283		
Bettis Lead and Slug	1279, 1280		
Bettis Space and Quad	1279		
Border	1277		
Boston Lead Rack	1266		
Brass Leader	1279, 1283		
Byerly Figure	1277		
California Job	1274, 1279		
Cap	1274, 1276		
Cap and Lower	1274, 1276		
Carpenter Quarter	1283		
Cast Iron Furniture	1228, 1279		
Combination Job	1275		
Compact Rule	1281		
Dearing Accent	1275		
Dearing Job	1275, 1278		
Double Lower	1274		
Double Yankee Job	1275		
Duplex Job	1276, 1279		
Figure	1277, 1283		
Figure, One-Quarter	1283		
Fractions	1283		
Furieux Rule	1278		
Furniture, Metal	1278, 1289		
Furniture, Wood	1268		
German Upper and Lower	1276		
Greek Upper and Lower	1276		
Hamilton Blank	1281		
Hamilton Job	1275		
Hamilton Lead and Slug	1278, 1279		
Hamilton Leader Box	1214		
Hamilton New Rule	1282, 1283		
Happy Border	1283		
Harris Border	1281		
Harris Rule	1281		
Hebrew Upper and Lower	1276		
Ideal Brass Leader	1283		
Improved Cap	1276		
Improved Job	1274, 1279		
Improved New York Job	1275		
Improved Space and Quad	1277		
Individual Lead or Rule	1281-1283		
Italic or Job	1274		
Job, Paterson	1275		
Jones Metal Furniture	1279		
Labor-Saving Reglet	1266, 1267		
Labor-Saving Wood Furniture	1268		
Lead and Slug	1277-1280		
Lead and Slug, Two Rivers	1278		
Leader	1283		
Lead or Rule	1278, 1279, 1281-1283		
Lower	1274, 1276, 1277		
Mammoth Labor-Saving Furniture	1268		
May Leader Box	1214		
Metal Furniture	1278, 1279		
Music	1277		
Neshota Rule	1278		
New Departure	1273		
News (Cap and Lower)	1274		
Patent Clasp	1273		
Paterson Job	1275		
Perfection Rule	1281		
Porson Greek	1276		
Practical Space and Quad	1277		
Price List of Cases	1273		
Quadruple	1274		
Quarter	1281-1283		
Reglet, Labor-Saving	1267		
Rule	1281, 1282		
Rule, Harris	1281		
Rule, Neshota	1278		
Russell Tabular	1276		
Sanspareil Rule	1281		
Script or Wood	1253, 1278		
CASES—Continued			
Sign	1283		
Space and Quad	1277, 1279, 1283		
Space and Quad, All Right	1283		
Spaceless Job	1274, 1279		
Steel Composing Rule	1211		
Steel Furniture	1228		
Tabular	1276, 1283		
Thin Spaces	1231		
Three-Quarter	1279		
Time-Table Quarter	1283		
Triple	1274		
Two Rivers Cap	1274		
Two Rivers Lead and Slug	1278		
Two-Third	1278, 1279		
Wells Two-Font Job	1275		
Wheeler Job	1275		
Wisconsin Lead Rack	1266		
Wisconsin Quarter	1283		
Wood Furniture	1268		
Wood-Type	1278		
Yankee Job	1275, 1278		
Zenobia	1278		
CASE STANDS			
City	1243		
Iron and Steel (See Index No. 5)			
New York	1247		
Polhemus	1243		
Price List	1247		
Steel Run	1244, 1245		
Tracy Steel Run	1246		
Case Stands and Racks	1247		
Cast Iron Chases	1221		
Cast Iron Furniture	1202		
Cast Iron Sectional Blocks	1200		
Cast Rollers	1228		
Cement Brush	1216		
Cement, Padding	1216		
Challenge Cast Iron Sectional Blocks	1200		
Challenge Hempel Quoins	1208		
Challenge Mammoth Iron Furniture	1202		
Challenge Metal Sectional Blocks	1200		
Challenge Proof Press	1186		
Challenge Steel Sectional Blocks	1200		
Challenge Type-High Gauges	1192		
Chandler & Price Gordon Presses	1159, 1160		
Chandler & Price Ink Fountains	1186		
Chandler & Price New Series Presses	1159		
Chandler & Price Paper Cutters	1169		
Chandler & Price Proof Presses	1185		
Chase and Form Racks	1189		
CHASES, Electric-Welded			
Book	1218		
Brazed Steel	1221		
Bright Steel	1221		
Cast Iron	1221		
Cast Steel	1221		
Electrotype	1220		
For Job Presses	1219		
Heading	1221		
McGreal Combination	1221		
Newspaper, Folio	1218		
Newspaper, Quarto	1220		
Poster	1219		
Quadruple	1220		
Spider, for Job Presses	1221		
Steel Screw	1221		
Stereotype	1220		
Twin or Folio	1218		
Twin or Quarto with Bars	1220		
Check Numbering Machine	1194		
Chesapeake Economy Compound	1227		
Chicago Drying Racks	1284		
Circular and Angular Quads	1222		
City Double Case Stands	1243		
City Single Case Stands	1243		
Climax Register Hooks	1198		
Cloth Cutting Machine	1270		
Cloth, Roller	1228		
Colt's Armory Presses	1161-1163		
Combination Chase, McGreal	1221		
Combination Job Case	1275		
Combination Paper Jogger	1209		
Combination Pressroom Cabinet	1250, 1254, 1265		
Combination Quoin Keys	1207		
Combination Shute-Board and Type-High Machine	1192		
Combined Eyelet and Punch Set	1215		
Common Screw Composing Stick	1210		
Compact Rule Case	1281		
Composing Room Cabinet	1239		

INDEX

Index No. 4—PRINTERS' MACHINERY, TOOLS, MISCELLANEOUS SUPPLIES AND WOOD GOODS AND WOOD COMPOSING ROOM FURNITURE *Continued*

	PAGE		PAGE
Composing Room Cylinder Proof Press	1185	E CONOMIC IMPOSING STONE FRAME	1260
Composing Rule Case	1211	Ejector Blade Cabinet	1251
Composing Rules	1211	Ejector Press Punch, Bullock	1182
COMPOSING STICKS		Electric Proof Press	1184
All Brass News	1210	Electric-Welded Chases	1217, 1221
Buckeye	1210	Electrotype Cabinet	1248
Common Screw	1210	Electrotype Chases	1220
French Pattern	1210	Electrotyped Newspaper Headings	1134, 1135
Grover	1210	Electrotyped Newspaper Sub-Headings	1133
Improved Standard	1210	Electrotyped Take Slugs	1223
Perfect News	1210	Embossed, Orro	1207
Poster	1210	Embossing Composition	1227
Rouse Job	1210	Embossing Press, Gally Universal	1163
Star	1210	End Wood Borders	1150, 1152
Yankee Job	1210	Engravers' Wood	1230
Composition, Embossing	1227	Engraving Tools	1230
Composition, Roller	1228	Eureka Lead Rack	1266
Compositors' Working Cabinet	1252	Eureka Type Wash	1227
Copper Alloy Take Slugs	1223	Extension Feed Guides	1212
Copper and Brass Thin Spaces	1131	Extension Front Cabinets	1238-1240
Copy Cutters' Desk	1255	Extension Stud Gauge	1212
Copy Holders	1225	Eyelets and Punches	1215
Corner Quads, Brass and Metal	1111, 1223	Eyeletting Sets for Southworth Punches	1180
Correcting Bank	1253	Eye Shades	1230
Correcting Case, Monotype	1251	F AVORITE QUOINS	1208
Cott's Improved Tablet Holder and Clamp	1216	Feed Guides	1212, 1213
Counter, Paper	1216	Felt Blankets	1228
COUNTERS		Felt Roller Cloth	1228
American	1193	Figure Cases	1276, 1277, 1283
Durant	1193	Files, Hamilton Newspaper	1230
Redington	1193	Finishing Benches for Bookbinders	1271
Sheppard	1193	Finishing Stand for Bookbinders	1270, 1272
Couplers, Tape	1215	Fixtures, Overhead	1209
Cranston Cylinder Presses	1158	Flicker Combined Benzine Can and Brush	1224
Crawford's Ink Reducer	1227	Fly Sticks	1243
Cut Cabinets	1248	Folding Machines	1232
Cutters, Card	1207	Folio Chases	1218
Cutters, Lead and Rule	1147	Foot Power Attachment Sterling Round Cornering Machine	1182
Cutters, Matych Plate	1192	Foot Slugs	1223
Cutters, Paper	1155-1170	Foot Sticks, Iron	1226
Cutting and Creasing Presses	1163	Form Racks	1189
Cutting Attachments for Portland Punching Machines	1178	Form Storage Cabinets	1254
Cutting Blocks, Sterling	1182	Form Trucks	1189
Cutting Gauge for Bookbinders	1272	Fountains	1185
Cutting Rule, Steel	1111	Four-Tier Wisconsin Lead Rack	1266
Cylinder Bellows	1214	Fraction Cases	1283
Cylinder Press Counters	1193	Furneaux Rule Case	1278
CYLINDER PRESSES		Furneaux Storage Cabinet	1269
Brower	1157	FURNITURE	1268
Cranston	1158	Beveled	1262
Diamond	1158	Labor-Saving Cast Iron	1223
Premier	1153-1155	Labor-Saving Metal	1223
Stonemetz	1158	Labor-Saving Quotation	1223
Whitlock	1155, 1156	Labor-Saving Reversible Metal	1223
Cylinder Press Feed Guides	1212, 1213	Labor-Saving Steel	1228
Cylinder Press Locks	1203	Labor-Saving Wood	1268
Cylinder Press Rollers	1228	Mammoth Iron	1202
D EARING ACCENT CASE	1275	Furniture Cabinet	1260
Dearing Job Cases	1278	Furniture Cases	1268
Desks	1255	Furniture, Yard Lengths	1230
Detachable Case Brackets	1284 ^a , 1284 ^b	G ALLEY BRACKETS	1284 ^a , 1284 ^b
Detachable Galley Bracket	1284 ^a , 1284 ^b	Galley Cabinets	1252, 1254
Diamond Cylinder Press	1158	Galley Lock	1205
Diamond Paper Cutters	1168	Galley Lock-up	1205
Die Cutting Press, Oswego	1166	Galley Proof Presses	1185, 1186
Dillingham Punch	1182	Galley Racks	1246
Dixie Hand Cleaner	1227	GALLEYS	
Donnell's Ink Regulator	1227	All-Brass	1204, 1205
Dorsey Combination Pressroom Cabinet	1254	All-Brass, Graduated	1204
Dorsey Compositor's Working Cabinet	1252	All-Brass Monotype	1204
Dorsey Imposing Stone Frame	1257	American Patented One-piece Rim	1201
Double Case Brackets	1284 ^a , 1284 ^b	Brass Lined	1205
Double Case Stands	1243	Bright Steel	1206
Double Grip Gauge	1213	Galvanized Steel	1206
Double Lower Case	1274	Half Lined	1205
Double Yankee Job Case	1275	Job	1204, 1206
Drills for Paper	1181	Lincoln, All-Brass	1205
Drum Cylinder Presses	1157	Linotype	1205
DRYING RACKS		Mailing	1206
American	1265	McFatrigh	1206
Chicago	1281	Mercantile Addressing	1202
Koerner's Interlocking	1284	Milholland	1205
New York	1281	Mustang Mailing	1206
Duplex Job Case	1276	Plate Zinc	1206
Durant Counters	1193	Pressed Brass	1206
		Pressed Steel Storage	1206

INDEX

Index No. 4—PRINTERS' MACHINERY, TOOLS, MISCELLANEOUS SUPPLIES AND WOOD GOODS AND WOOD COMPOSING ROOM FURNITURE—*Continued*

	PAGE		PAGE
GALLEYS—Continued		Imposing Surfaces, Iron	1203
Riveted Zinc	1206	Improved Cap Case	1276
Unlined	1205	Improved Hempel Quoins	1208
Zinc	1206	Improved Job Case	1274
Gally Cutting and Creasing Presses	1163	Improved New York Job Case	1275
Gally Universal Embossing Press	1163	Improved Space and Quad Case	1277
Gauge, Brass Line	1210	Improved Standard Job Sticks	1210
Gauge Pin Drawer	1212	Improved Tablet Holder and Clamp	1216
Gauge Pins and Guides	1212, 1213	Inclined Truck, Millers	1190
Gauges for Bookbinders	1272	Indexed Electrotyping Cabinets	1248
Gauges, Practical Height	1192	Index Punch Heads	1177, 1182
Gem Lever Paper Cutter, Peerless	1170	Individual Lead or Rule Case	1281
Genuine Hempel Quoins	1208	Ink and Roller Cabinets	1250
German Upper and Lower Cases	1276	Ink Cabinets	1250
Gilding Presses	1270	Ink for Numbering Machines	1197
Glasses	1230	Ink Fountains	1186
Glue, Liquid Padding	1216	Ink Knives	1211
Glue Pot	1216	Inkoleum	1227
Gold Cushions for Bookbinders	1159, 1160	Ink, Printing (<i>Write for Complete Ink Book</i>)	1227
Gordon Presses	1159, 1160	Ink Reducers	1227
Grand Cabinets	1235	Ink Regulators	1227
Greek Upper and Lower Cases	1276	Ink Slabs	1211
Gripper Cross Bar	1213	Ink Spade	1214
Grover Composing Stick	1210	Interlocking Drying Racks, Koerner's	1284
Guides	1212, 1213	Iron and Steel Equipment	1284-1304
HALF LINED GALLEYS	1205	Iron Furniture	1202
Half-tone Benzine Brush	1224	Iron Gauge Pin Drawers	1212
Hamilton Blank Case	1281	Iron Newspaper Bases	1201
Hamilton Case Brackets	1284 ⁴ , 1284 ⁴	Iron Pulleys	1209
Hamilton Correcting Bank	1253	Iron Sectional Blocks	1200
Hamilton Form Truck	1190	Iron Side and Foot Sticks	1226
Hamilton Imposing Stone Frames	1258	Iron Top Imposing Surfaces	1203
Hamilton Job Cases	1275	Italic or Job Case	1274
Hamilton Lead and Slug Case	1278	J	
Hamilton Leader Box	1214	JOB BANK	1252
Hamilton Newspaper Files	1230	Job Chases	1219
Hamilton Patent Tilting Brackets	1284 ⁴ , 1284 ⁴	Job Galley Cabinets	1254
Hamilton Rule Cases	1282, 1283	Job Galleys	1204-1206
Hamilton Side Sticks	1226	Job Press Brake	1215
Hamilton Single Case Detachable Brackets	1284 ⁴ , 1284 ⁴	Job Press Cabinet	1250
Hamilton Transfer Imposing Stone Frames	1261	Job Press Chases	1219
Hand Cleaners	1227	Job Press Counters	1193
Hand Cylinder Presses	1157, 1158	Job Presses	1159-1163
Hand Lever Press, Pilot	1160	Job Sticks	1201
Hand Numbering Machines	1197	Joggers	1209
Hand Paper Cutters	1168-1170	Jones Metal Furniture Case	1279
Hand Perforators	1183	Justrite Oily Rag Can	1164
Hand Power Punch Presses	1181	K	
Hand Press, Washington	1183	KAUFMAN IMPOSING STONE FRAME	1256
Hand Rollers	1128	Keys and Quoins	1208, 1209
Handy Letter-Board Cabinets	1264	Kleenu	1227
Handy Sort Cabinet	1239	KNIVES	
Hangers, Adjustable	1209	Ink	1211
Hansen Mitering Machine	1191	Overlay	1211
Happy Border Case	1283	Pallet	1211
Hardwood Letter Boards	1263	Paper Cutter	1170
Harris Border Case	1281	Pressman's	1211
Harris Rule Case	1281	Tablet	1216
Heading Chases	1221	Koerner's Patent Interlocking Drying Racks	1284
Headings for Newspapers	1183-1185	L	
Heads for Index Printing	1182	LABEL HOLDERS	1253
Hebrew Upper and Lower Case	1276	Labor-Saving Cast Iron Furniture	1202
Hempel Improved Quoins	1208	Labor-Saving Furniture Cases	1268
Hercules Steel Rule Cutter	1203	Labor-Saving Furniture Cases	1266
High Side Arm Proof Press	1185	Labor-Saving Leads, American	1222
Hill & Webb Galley Lock	1205	Labor-Saving Metal Furniture	1223
Hoeerner's Combination Shute Board	1192	Labor-Saving Quotation Furniture	1223
Hummer Punching Machine	1181	Labor-Saving Reglet	1267
I		Labor-Saving Reglet Cases	1267
IDEAL BRASS LEADER CASE	1283	Labor-Saving Steel Furniture	1228
Ideal Form Trucks	1188	Labor-Saving Wood Furniture	1268
Illustrations of Cases	1273-1283	Labor-Saving Wood Furniture Cases	1268
Imperial Non-Explosive Benzine Cans	1224	Laureate Platen Printing Press	1161
IMPOSING STONE FRAMES		Lead and Rule Cases	1278, 1281
Algora	1256	Lead and Rule Cutters	1191
Dorsey	1257	Lead and Slug Bank	1269
Economic	1260	Lead and Slug Cases	1279
Hamilton	1258	Leader Box	1214
Hamilton Transfer	1261	Leader Case	1283
Kaufman	1256	Leaders, American Line, Brass	1108
Metropolitan	1257	Lead Racks	1266
Ramaley	1258	Leads, American Line	1222
Savage	1260	Leads and Slugs	1222
Texas	1259	Leather Pocket Rule Case	1211
Two Rivers	1259	Letter Board Cabinets	1264
Universal	1259	Letter Boards	1262, 1263
Wisconsin	1261	Lettering Pallet	1215
With Letter Boards	1260, 1262, 1263	Lever Paper Cutters	1168-1170
With Square Legs	1261		

INDEX

Index No. 4—PRINTERS' MACHINERY, TOOLS, MISCELLANEOUS SUPPLIES AND WOOD GOODS AND WOOD COMPOSING ROOM FURNITURE—Continued

	PAGE		PAGE
Lever Press, Pilot	1160	News Cases	1274
Lincoln All-Brass Galley	1205	New Series Chandler & Price Press	1159
Lincoln Type Measure	1211	Newspaper Chasers	1218-1221
Line Measures	1240	Newspaper Files	1230
Lining Leads	1222	Newspaper Folders	1232
Linotype Liner and Ejector Blade Cabinet	1251	Newspaper Galleys	1201-1206
Linotype Galleys	1205	Newspaper Headings	1134, 1135
Linotype Magazine Cabinet	1254	Newspaper Presses	1153-1158
Linotype Matrix Cabinet	1251	Newspaper Sub-Headings	1133
Linotype Planers	1187	News Sticks	1210
Linotype Saw	1187	New Star Adjustable Lockup	1208
Liquid Corner Brush	1216	New Star Line Measure	1210
Liquid Padding Glue	1216	New Wedge Star Composing Stick	1210
Locks, Galley	1205	New Wing-Horton Mailers	1188
Long Wood Quoins	1226	New York Case Brackets	1284 ^a -1284 ^b
Loose Leaf Punching Attachment	1176, 1182	New York Double Case Stands	1247
Low Case Bracket	1284 ^a , 1284 ^b	New York Drying Racks	1284
Lye Brushes	1224	New York Improved Job Case	1275
		New York Quadruple Case Stands	1247
		New York Single Case Stands	1247
		Non Explosive Benzine Cans	1224
M ACHINERY FOR PRINTERS	1153-1187		
Magazine Cabinet, Linotype	1270	NUMBERING MACHINES	1194-1197
Magnifying Glasses	1230	American	1197
Mailing Galleys	1206	Atlas	1197
Make-up Rules	1211	Bates	1197
Make-up Tables	1269	Boston Model	1194
		Mammoth	1195
MAILING MACHINES		Midget	1195
Acme	1188	One Inch	1194
Mercantile	1188	Roberts	1197
Mustang	1188	Wetter, All Kinds	1194-1197
New Wing-Horton	1188	Numbering Machine Ink	1197
Mallets, All Kinds	1225		
Mammoth Iron Furniture	1202	O ILY RAG CANS, JUSTRITE	1164
Mammoth Labor-Saving Furniture Case	1268	Old Style News Cases	1274
Mammoth Wetter Numbering Machines	1195	One Inch Wide Wetter Numbering Machine	1194
Mammoth Wood Type Cases	1278	Ontario Paper Cutters	1167
Manufacturers' Card Cutter	1207	Open Hole Punch Sets	1178
Marble Imposing Tables	1256-1263	Orro Embosser	1207
Marble Ink Slabs	1214	Oswego Die Cutting Press	1166
Marvel Punching Machine	1181	Oswego Paper Cutters	1165-1168
Masterman Composing Room Cabinet	1239	Overhead Fixtures	1209
Materials and Supplies for Bookbinders	1270-1273	Overlay Knife	1211
Matrix Cabinet, Linotype	1251		
Matych Plate Cutter	1192	P ADDING GLUE	1216
May Leader Box	1214	Page Form Storage Cabinets	1251
McFatrigh Galleys	1206	Pallet for Lettering	1215
McGreal Combination Chases	1221	Pallet Ink Knives	1211
Measures, Type	1210, 1211		
Megill Automatic Register Gauge	1213	PAPER CUTTERS	
Mercantile Addressing Machine	1188	Advance Lever	1169
Mercantile Addressing Machine Galleys	1206	Advance Pony Lever	1169
Mercantile Quoins	1188	Chandler & Price	1169
Metal Cleaner	1227	Chandler & Price Lever	1169
Metal Corner Quads	1223	Diamond	1163
Metal Furniture	1223	Ontario	1167
Metal Furniture Cabinet	1266, 1269	Oswego Automatic	1165
Metal Furniture Case	1278, 1279	Oswego Bench	1170
Metal Furniture Storage Cabinet	1266-1269	Oswego Combination Hand and Power	1166
Metal Leads and Slugs	1222	Oswego Die Cutting	1166
Metal Sectional Blocks	1200	Oswego Hand Lever	1168
Metallic Tape Couplers	1215	Oswego Hand Wheel Drive	1166
Metropolitan Imposing Stone Frames	1257	Oswego Paper Mill	1165
Midget Safety Quoins	1208	Oswego Power, Hand Clamp	1166
Midget Labor Saving Case	1222	Oswego Semi-Automatic	1165, 1166
Midget Wetter Numbering Machines	1195	Peerless Gem	1170
Miholland Linotype Galleys	1205	Paper and Card Stock Cabinets	1265, 1272
Miller Incline Truck	1190	Paper Box Cutting and Creasing Presses	1163
Miller Universal Saw-Trimmer	1187	Paper Counter	1216
Mills Ad Forman's Desk No. 1	1255	Paper Cutter Knives	1170
Mills Copy Cutter's Desk	1255	Paper Drill	1181
Mills Proofreader's Desk	1255	Paper Folders	1282
Mills Three-Height Gauge	1192	Paper Jogger	1209
Mills Two-Height Iron Newspaper Bases	1201	Paper Punches	1176-1181
Miter Boxes	1214	Paper Roll Trucks	1190
Mitering Machines	1191	Patent All-Brass Galleys	1204
Monarch Hemp Quoins	1208	Paterson Job Case	1275
Monotype Cabinets	1251	Pebling Machines	1170
Monotype Correcting Case	1251	PeDESTAL Foot Power Attachment	1182
Monotype Galleys	1204	Peerless Gem Lever Paper Cutters	1170
Movable Drying Racks	1284	Peerless Job Printing Presses	1160
Movable Galley Racks	1246	Perfecting Rule Set	1211
Music Cases	1277	Perfection Patent Clasp Cases	1273
Mustang Mailer	1188	Perfection Rule Case	1281
Mustang Mailing Galley	1206	Perfection Steel Tableting Press	1216
		Perfect News Stick	1210
		Perfect Register Gauge	1212
		Perforating and Scoring Machines	1183
N ATIONAL CARD CUTTER	1207		
National Rotary Perforator	1183		
Neshota Rule Case	1278		
New Century Ink Fountain	1186		
New Departure Cabinets	1241		
New Departure Type Cases	1273		

INDEX

Index No. 4—PRINTERS' MACHINERY, TOOLS, MISCELLANEOUS SUPPLIES AND WOOD GOODS AND WOOD COMPOSING ROOM FURNITURE—*Continued*

	PAGE		PAGE
PERFORATORS	1164, 1183	PUNCHING MACHINES	1176-1181
Burch	1164	Hummer	1181
Hand	1183	Marvel	1181
National Rotary	1183	Portland	1176-1178
Tatum	1183	Southworth	1179, 1180
Pilot Hand Lever Press	1160	Standard	1181
Pins, Gauge	1212, 1213	Punching Machines, Hand Power	1181
Planers	1225	Punch Sets	1180
Plate Cutter	1192	Pyramid Lead and Slug Bank	1269
Plate Zinc Galleys	1206		
Plow and Press for Bookbinders	1270	Q UAD CASES	1283
Pocket Magnifying Glasses	1230	Quadruple Cases	1274
Pocket Rule Case, Leather	1211	Quadruple Chases	1220
Polhemus Cabinets	1234	Quads (<i>See Type Index</i>)	
Polhemus Case Stands	1243	Quads, Circular and Angular	1222
Popular Card Cutter	1207	Quads, Corner	1223
Porson Greek Case	1276	Quarter Cases	1281-1283
Porter Extension Front Cabinets	1238	Quarto Cases	1220
Portland Multiple Punching Machine	1176-1178	Quoin Keys	1209
Poster Chases	1219		
Poster Sticks, Wood	1210	Q UOINS	
Potter Proof Presses	1184	Challenge Hempel	1208
Power Paper Cutters	1165-1169	Favorite	1208
Power Perforators	1183	Improved Hempel	1208
Practical Height Gauge	1192	Long Wood	1226
Premier Presses	1153-1155	Mercantile	1188
Premium Card Cutter	1207	Midget	1208
Press Boards	1226, 1271	Monarch	1208
Press Brake	1215	New Star	1208
Press Counters	1193	Register	1208
Press, Die Cutting	1163	Wickersham	1208
Pressed Brass Galleys	1206	Wooden, in Boxes, Barrels and Bags	1226
Pressed Steel Storage Galleys	1206	Quotation Furniture	1223
Press Guides	1213	Quotation Quads	1223
Press Locks, Cylinder	1208		
Pressman's Cabinet	1254	R ABBETED BASES	1200
Pressman's Combination Quoin Key	1209	Racks and Case Stands	1247
Pressman's Knife	1211	Racks, Drying	1284
Pressman's Quoin Key	1209	Racks, Lead	1266
Pressman's Register Cabinet	1285	Racks, Movable Galley	1246
Press Points	1209	Radio-Iron Imposing Surfaces	1203
Press Punch Ejectors	1182	Railroad, or Reversible Metal Furniture	1228
Press Rollers	1228	Ramaley Imposing Stone Frames	1258
Pressroom Cabinet, Dorsey	1251	Rawhide Mallets	1225
Pressroom Trucks	1190	Redington Counter	1193
Press Seats	1192	Reducers, Crawford's	1227
Price List of Brackets	1284 ^a	Reducing Glasses	1230
Price List of Cases	1273	Register Gauge, Perfect	1212
Price List of New Departure Type Cases	1273	Register Hooks	1198
Price List of Wood Type	1145	Register Quoins	1208
Printers' Quoins	1226	Reglet	1230, 1267
Printers' Saw Table	1187	Reglet Cases, Labor-Saving	1267
Printers' Tweezers	1214	Regulators, Ink	1227
Printers' Wood Goods	1234-1284	Reversible Metal Furniture	1223
Printing Ink. (<i>Write for Complete Ink Book.</i>)		Reversible Unit Cabinet	1236, 1237
		Richter's Metal Cleaner	1227
PRINTING PRESSES	1153, 1163	Right Angle Pressman's Quoin Key	1209
Brower Drum Cylinder	1157	Riveted Galleys, Brass and Zinc	1204-1206
Chandler & Price Gordon	1160	Roberts Numbering Machines	1197
Chandler & Price New Series	1159	Roll Cloth Cutting Machine	1270
Colt's Armory	1161-1163	Roller Brackets	1284 ^a , 1284 ^a
Cranston	1158	Roller Cabinet	1350
Diamond	1158	Roller Cloth	1228
Gally Cutting and Creasing	1163	Roller Composition	1228
Gally Universal Embossing	1163	Roller Cores	1228
Laureate Models J and T	1161	Roller Spray	1227
Peerless	1160	Roller Supporters	1215
Pilot Lever	1160	Rollers, Press	1228
Pilot Lever Hand Press	1160	Rollers, Prices for Casting	1228
Premier	1153-1155	Roll Front Case Racks	1248
Premier Two-Revolution Press	1153-1155	Rotary Perforators	1183
Stonemetz	1158	Roughing Machines	1170
Washington Hand	1186	Round Cornering Machines	1182
Whitlock Newspaper Press	1156	Round End Spatulas	1211
Whitlock Three Roller	1156	Round Hole Punch Heads	1177
Whitlock Two-Revolution Pony	1155, 1156	Rouse Composing Sticks	1210
Proof Planers	1225	Rouse Copy Holder	1225
		Rouse Lino-Slug Cutter	1191
		Rouse Mitering Machines	1191
		Rouse Register Hooks	1198
		Rouse Unit System Bases	1200
		Rouse Universal Block System	1198
		Rowen Border and Script Type Cabinets	1253
		Rubber Blankets	1228
		Rule Cases	1231, 1282
		Rule Cutters	1191
		Rule, Cutting and Scoring, Steel	1111
		Rules, Composing and Make-up	1211
		Ruling Machines	1232
		Ruling Pen Cabinet	1245
		Russell Tabular Case	1276
PROOF PRESSES			
Challenge	1186		
Chandler & Price	1185		
Potter	1184		
Vandercook	1185		
Washington Hand	1186		
Wesol Patent Electric	1184		
Proofreaders' Desks	1255		
Pulleys, Wood and Iron	1209		
Punches and Eyelets	1215		
Punching Attachment Sterling Round Cornering Machine	1182		
Punching Heads	1177		

INDEX

Index No. 4—PRINTERS' MACHINERY, TOOLS, MISCELLANEOUS SUPPLIES AND WOOD GOODS AND WOOD COMPOSING ROOM FURNITURE—Continued

	PAGE		PAGE
S			
Safety Benzine Can	1224	Straight Edges for Bookbinders	1272
Sanspareil Rule Case	1281	Strip Lead and Rule Cabinet	1240
Savage Imposing Stone Frame	1260	Stuart Finishing Stands	1270
Saw, Miller Universal	1187	Studio Card Cutter	1207
Saws, Miter	1214	Success Benzine Can	1224
Scoring and Creasing Presses	1163	Success Form Truck	1189
Scoring and Cutting Rule	1111	Suddard Block System	1199
Screw Composing Stick	1210	Superior Steel Tableting Press	1216
Script Type Cabinets	1253	Sure Shot Binder	1175
Script Type Case (see Wood Type Case)	1249, 1278		
Seats, Press	1192	T	
Sectional Blocks	1200	TABLES, BINDERY	1272
Sectional Chase and Form Rack	1189	Tables, Stock	1265
Security Roller Cabinets	1164	Tab Cutting Attachment	1178
Self Inking Proof Press	1184	Tablet Holder and Clamp	1216
Sengbusch Beveled Furniture	1268	Tablet Knife	1216
Sewing Benches for Blank Book Makers	1270	Tablet Presses	1216
Shades, Eye	1230	Take Slugs	1223
Shafting	1209	Tape	1115
Sheppard Counters	1193	Tape Couplers	1215
Shooting Sticks	1226	Tape, Steel, Type Measare	1211
Side and Foot Sticks, Iron	1226	Tatum Paper Drill	1181
Side Sticks, Wood	1226	Tatum Perforator	1183
Slauson Cylinder Press Locks	1203	Tatum Punching Machines	1181
Slug and Lead Cases	1277	Texas Imposing Stone Frames	1259
Slugs, Foot	1223	Thin Spaces, Brass and Copper	1181
Slugs, Take, Copper Alloy	1223	Three-Case Brackets	1284*, 1284*
Solid Brass Gauges	1213	Three-quarter California Job Case	1279
Sort Cabinet, Handy	1239	Tilting Case Brackets	1184*, 1284*
Sort Drawers, Handy	1239	Tracy Cabinets	1240
Southworth Punching Machines	1179, 1180	Tracy Steel Run Stands	1246
Space and Quad Case, All-right	1283	Transfer Imposing Stone Frame	1261
Space and Quad Cases	1277, 1279, 1283	Triangular Type Measure	1211
Spaceless Job Case	1174	Triple Case	1274
Spaces, Brass and Copper Thin	1131	Triumph Eyelet Punch and Set	1215
Special Numbering Machines	1195, 1197	Truck for Paper Rolls	1190
Special Punch Heads	1249	Trucks, Pressroom and Bindery	1189, 1190
Specimen Cabinet	1221	Tweezers	1214
Spider Chases	1227	Twin Chases	1218
Spray, American Roller	1211	Two-Font Job Case, Wells	1275
Square End Pallets	1211	Two-Revolution Presses	1153, 1156-1158
Square End Spatulas	1211	Two Rivers Cap Case	1274
Square Leg Imposing Table	1261	Two Rivers Imposing Stone Frames	1259
Standard Punches	1181	Two Rivers Lead and Slug Case	1278
Standing Galley with Letter Boards	1263	Two-Third Cases (See Index to Cases)	1278, 1279
Stands, Case	1247	Two-Tier Wisconsin Lead Rack	1266
STAPLE BINDERS	1174, 1175	Tympan Paper Cabinet	1265
Acme	1175	Tympan Press Boards	1226
Boston	1174	Type Cabinets (See Index to Cabinet)	1234-1243
Breech Loader	1175	Type Cases (See Index to Cases)	1273-1279
Sure Shot	1175	Type-High Gauges	1192
Yarger	1174, 1175	Type-High Machine	1192
Staples, Wire	1174, 1175, 1229	Type-High Numbering Machines	1193-1197
Staples, Wire, Table giving number to the pound	1229	Type Measures	1210, 1211
Star Composing Stick	1210	Type Wash, Eureka	1227
Stationery and Cardboard Cabinet	1265		
Steel Chases	1217-1221	U	
Steel Clad Safety Benzine Can	1224	UNIT TYPE CABINET	1236, 1237
Steel Composing Rules	1211	Universal Imposing Stone Frame	1259
Steel Cutting and Scoring Rule	1111	Unlined Newspaper Gallies	1205
Steel Furniture	1228	Upright Mitering Machine	1191
Steel Gallies	1206	Utility Lead Cutter	1191
Steel Keys for Register Hook	1199		
Steel Make-up Rules	1211	V	
Steel Roller Supporters	1215	VANDERCOOK COMPOSING ROOM CYLINDER PROOF PRESS	1185
Steel Rule Cutter	1203	Vandercok High Side Arm Proof Press	1185
Steel Run Cabinets	1234-1243	Vandercok Roller Series Proof Press	1185
Steel Run Stands	1244-1246	Vibrating Rollers for Chandler & Price Presses	1186
Steel Scoring and Cutting Rule	1111		
Steel Screw Chases	1221	W	
Steel Tape Type Measure, Lincoln	1211	WASHINGTON HAND PRESS	1186
Steel Wire	1229	Wells Job Case	1275
Stereotype Beating Brushes	1224	Wells Long Wood Quoins	1226
Stereotype Chases	1220	Wesol Brass Sectional Blocks	1200
Stereotype Plate Cutter	1192	Wesol Electric Self-Inking Proof Press	1184
Sterling Cornering Knives, Extra	1182	Wetter Baggage Check Numbering Machine	1184
Sterling Cutting Blocks	1182	Wetter Special Numbering Machines	1186
Sterling Pedestal Foot-Power Attachment	1182	Wetter Type-High Numbering Machines	1275
Sterling Punching Attachment	1176-1178	Wheeler Job Case	1156
Sterling Round Cornering Machine	1182	Whitlock Newspaper Presses	1155
Stick Rest	1230	Whitlock Two-Revolution Presses	1155, 1156
Sticks, Composing	1210	Wickersham Pressman's Quoin Key	1209
Sticks, Iron Side and Foot	1226	Wickersham Quoins	1208
Stitching Machines, Boston	1171-1173	Wilson Adjustable Patent Blocks	1200
Stock Cabinets, Paper and Card	1265	Wilson Solid Iron Blocks	1200
Stock Tables	1265	Window Cabinets	1242
Stonemetz Two-Revolution Press	1153	Wing-Horton Mailer	1188
Stones, Imposing	1256, 1263	Wire Staples	1175, 1229
Storage Cabinets	1254	Wire Staples, Table giving number to pound wire	1229
Storage Cabinets for Leads, Slugs and Furniture	1269	Wire Stitchers, Boston	1171-1173
Storage Gallies	1206	Wisconsin Combination Quarter Cases	1283
		Wisconsin Hard Wood Cabinets	1243

INDEX

Index No. 4—PRINTERS' MACHINERY, TOOLS, MISCELLANEOUS SUPPLIES AND WOOD GOODS AND WOOD COMPOSING ROOM FURNITURE—*Continued*

	PAGE		PAGE
Wisconsin Imposing Stone Frame	1261	Wood Type, Price List and Schemes	1145
Wisconsin Lead Rack	1266	Wood Type	1146-1149
Wisconsin Printer's Trucks	1190	Wood-Type Cabinets	1249
Wisconsin Quarter Cases	1283	Wood-Type Case	1249, 1278
Wisconsin Steel Run Cabinets	1242	Working Cabinet, Dorsey Compositor's	1252
Wisconsin Window Cabinet	1242	Working Galleys	1252
Wood and Brass Type Measures	1210, 1211	Y	
Wooden Mallets	1225	YANKEE COMPOSING STICK	1210
Wooden Poster Stick	1210	Yankee Job Cases	1275
Wooden Shooting Sticks	1226	Yankee Side Sticks	1226
Wood Foot Sticks	1226	Yarger Staple Binder	1174, 1175
Wood Furniture and Wood Furniture Cases	1268	Yarger Staples	1174, 1175, 1229
Wood Goods	1234-1284	Z	
Wood Quoins	1226	ZENOBIA RULE CASE	1278
Wood Reglet	1230, 1267	Zinc-Bound Press Boards	1271
Wood Rule	1150-1152	Zinc Galleys	1206
Wood Split Pulleys	1209		

Index No. 5—IRON AND STEEL PRINTING OFFICE EQUIPMENTS

	PAGE		PAGE
AMERICAN COMBINATION DUMPING AND CORRECTING TABLES	1292	Hamilton Linotype Correcting Table	1293
American Dumping Banks	1292	Hamilton Make-up and Storage Table	1293
American Dumping Table	1291	Hamilton Page Storage Cabinet	1296
American Galley Receiving and Storage Table	1291	IMPORTANT TO BUYERS	1285
American Linotype Correcting Table	1291	Imposing and Storage Table No. 725	1294
American Make-up Table No. 415	1291	IMPOSING TABLES—	
American Make-up or Transfer Trucks	1293	Hamilton No. 700	1296
American Matrix Tissue Holder	1299	Hamilton Nos. 725, 726	1294
American Newspaper Make-up Tables	1290	Imposing Tables, Nos. 717, 730-738	1295
BINDERY WORK TABLES	1298	Imposing Tables with Storage Trucks	1295
CABINETS—		Mills Extra Strong	1295
Cut Cabinets	1289	Ingot Casters	1301
Extension Front	1287	LETTER BOARD CABINETS	1296
Flat Top Galley	1297	Linolite Lamps and Reflectors	1300
Flush Front	1287	Linotype Correcting Table	1291, 1293
Galley Storage or Mail List	1297	MAKE-UP AND STORAGE TABLES—	
Hamilton Page Storage	1296	American Newspaper Nos. 410, 411	1290
Letterboard	1296	American No. 415	1291
Mail List	1297	American Make-up Trucks	1293
Mills Extra Strong	1288	Hamilton Make-up and Storage No. 801	1293
Mills Head Letter	1289	Make-up Trucks	1293
Page Storage	1296	Matrix Flongs	1300
Rogers	1286	Matrix Tissue Holder	1299
Tracy	1286	Metal Trucks, Self Dumping	1299
Case Racks, Wrought Iron	1297	Mills Extra Strong Case Cabinets	1288
CASE STANDS—		Mills Head Letter Case Cabinets	1289
Extension Front	1288	Mills Imposing Tables	1295
Wrought Iron	1297	NATIONAL INGOT CASTERS	1301
CORRECTING TABLES—		Newspaper Make-up Tables	1290
American Combination Dumping and Correcting	1292	PAGE STORAGE CABINETS	1296
American Linotype	1291	ROGERS STEEL CABINET	1286
Hamilton Linotype	1293	SELF-DUMPING METAL TRUCKS	1299
Cut Cabinets	1289	Stands, Case	1288, 1297
DRYING RACK AND STOCK TABLE NO. 917	1298	Steel Cabinets	1286-1289
Dumping Table	1291	Stereotype Matrix Flongs	1300
DUMPING TABLES AND BANKS—		Stock Table No. 917	1298
American Combination No. 450	1292	STORAGE TABLES AND CABINETS—	
American Dumping Bank	1292	American Galley Receiving and Storage	1291
American No. 800	1291	Galley Storage or Mail List	1297
EFFICIENCY DEPARTMENT ANNOUNCEMENT	36, 37	Hamilton Make-up and Storage	1293
Extension Front Cabinets	1287	Hamilton Page Storage	1296
Extension Front Case Stands	1288	Imposing and Storage No. 725	1294
FLAT TOP GALLEY CABINETS	1297	Page Storage	1296
Flexityp Dry Cold Stereotype Flongs	1310	Storage Trucks	1295
Flongs, Stereotype Matrix	1300	TRACY STEEL CABINET	1286
Flush Front Cabinets	1287	Transfer Trucks	1293
Form Rack No. 935	1298	TRUCKS—	
GALLEY CABINETS—		American Self-Dumping	1299
Flat Top	1297	Hamilton Self-Dumping	1299
Hamilton No. 655	1296	Make-up or Transfer	1293
Mail List	1297	Metal Trucks	1299
Storage or Mail List	1297	Storage Trucks	1293, 1295
Galley Receiving and Storage Table	1291	Transfer or Make-up	1293
Galley Storage or Mail List Cabinets	1297	WORK TABLES	1298
HAMILTON FORM RACK NO. 935	1298	Wrought Iron Case Racks	1297
Hamilton Galley Cabinet No. 655	1296	Wrought Iron Case Stands	1297
Hamilton Imposing Table No. 700	1296		
Hamilton Imposing Table No. 726	1294		

Why Buy Old Type Faces When New Ones Cost No More?

IN this American Specimen Book of Type Styles are shown a great many new and beautiful type faces not heretofore printed in specimen book form. The American Type Founders Company's world-wide reputation for originality in its selection of popular and stylish type designs remains unchallenged, and the foremost printing offices of the world are now rapidly equipping with its latest and best products. The question now arises: "*Why buy Old type faces when New ones cost no more?*" Why continue the use of old-fashioned type faces when new faces make your work more attractive; when the new faces are carried in stock for prompt delivery, while the old faces are invariably cast to order, necessitating delay and increased cost? Let the printer seriously consider this and realize how much more profitable he could make his business were he to discard the old, worn-out type and select his requirements from the many useful and profit-making series of American type shown in this specimen book. Keep the plant young through infusion of variety.

American Type Founders Company

ORIGINATOR OF TYPE STYLES

The American Type Founders Company is the largest manufacturer in the world of *Type, Borders, Ornaments, Brass Rule and Brass Type, etc.*, as well as the most important dealer in:

Job Type
Body Type
Borders
Ornaments
Spaces and Quads
Cast Cuts
Cast Initials
Brass Rule
Brass Corners
Brass Leads
Brass Slugs

Brass Galleys
Galvanized Galleys
Zinc Galleys
Special Galleys
Leads and Slugs
Copper Thin Spaces
Electric Welded Chases
Bright Steel Chases
Radio Iron Surfaces
Steel Furniture
Iron Furniture

The above list comprises only a few of the many products sold by this Company to printers throughout the world. The variety and extent of its manufactures is not equaled by any other type foundry and none can render as efficient service

AMERICAN TYPE FOUNDERS COMPANY

The American Type Founders Company in addition to manufacturing many of the prime essentials required in the art of printing, is in the best possible position to supply *Everything for the Printer*, as it represents, among others, the following manufacturers, who rank highest in their special lines:

CYLINDER PRESSES

Premier Printing Press Co.
Whitlock Printing Press Co.
Challenge Machinery Co.
Cranston Printing Press Co.
A. T. H. Brower Co.

JOB PRESSES

Chandler & Price Co.
John Thompson Co.
Peerless Printing Press Co.
National Machine Co.
Golding Manufacturing Co.
Boston Printing Press Co.

STAPLING MACHINES

Boston Wire Stitcher Co.
Acme Staple Co.
Samuel J. Yarger

PRINTERS' WOOD GOODS

Hamilton Manufacturing Co.

PAPER CUTTERS

Chandler & Price Co.
Oswego Machinery Co.
Challenge Machinery Co.
Peerless Printing Press Co.
Paul Shniedewend & Co.

**ROUND CORNERING
MACHINES**

Southworth Machinery Co.
Samuel C. Tatum Co.
F. P. Rosback Co.

PUNCHING MACHINES

Southworth Machinery Co.
Samuel C. Tatum Co.
F. P. Rosback Co.

PERFORATING MACHINES

Southworth Machinery Co.
Samuel C. Tatum Co.
National Machinery Co.
F. P. Rosback Co.

WIRE STITCHERS

Boston Wire Stitcher Co.
F. Wesel Manufacturing Co.
F. P. Rosback Co.

PROOF PRESSES

A. F. Wanner Co.
Eastern Sales Co.
Chandler & Price Co.
Challenge Machinery Co.
F. Wesel Manufacturing Co.
Paul Shniedewend & Co.

It is impossible to enumerate here many other machines and supplies in which we are extensive dealers. It will at all times afford us pleasure to furnish details and prices of any appliances manufactured, if you will let us know your requirements

AMERICAN TYPE FOUNDERS COMPANY

EFFICIENCY PRINTING PLANTS

To Those about to Equip New Plants or Re-Equip Established Plants:

The American Type Founders Company has a staff of experienced Printing Plant Efficiency Engineers, at 300 Communipaw Avenue, Jersey City, N. J., for the purpose of laying out complete printing plants or departments of printing plants with the object of securing the greatest Efficiency in Operation and the greatest Economies in Space and in Production.

Our Efficiency Engineers are experienced practical printers, and also fully conversant with the details of photo-engraving, electrotyping and stereotyping, and competent to advise in the selection and the arrangement of plants for these processes, as well as composing rooms.

WHEN SPECIALIZATION OF PRINTING PLANTS BECOMES PROFITABLE

When the work done in any printing plant is of a special character, and is done in large enough quantities to bring it into the class of regular manufacturing, the time has arrived when the subject of specialization of equipments to facilitate and to economize production can be profitably considered.

Nearly all of the larger periodical and newspaper plants and most of the commercial plants, especially the self-contained plants (which combine engraving and electrotyping with printing), are in the class which needs the services of our Expert Designers and Efficiency Engineers.

NEW PRINTING EDIFICES

The time to call in our Efficiency Engineers is when the architect is ready to commence his work. It is not to be expected that architects, however eminent, have sufficient knowledge of printing practice to enable them to plan the work rooms so that they will afford all possible economies in handling the work from start to finish. A thorough knowledge of all details of all the printing operations is required to enable one to properly locate and advise upon the construction of the stairways, elevators, dummy elevators, copy chutes, automatic copy carriers, windows, skylights, ventilators (to maintain the necessary equable temperature in pressrooms as well as to provide satisfactory sanitary conditions), water inlets and outlets, gas inlets, conduits for electric wiring, radiators, etc. Our Efficiency Engineers work in connection with the architects, and the more eminent the architect the more ready he is to welcome such assistance. A large proportion of factory buildings are put up in advance of knowing for what purposes the tenants will use them. In

such instances one can only make the best of what is provided by the landlord; but when a building or part of a building is constructed specially for printing purposes there is an opportunity for incorporating in the building very important and constant economies or (as too often happens) for establishing decidedly uneconomical conditions equally constant.

SPECIALIZED EQUIPMENTS FOR PLANTS THAT ARE PERMANENTLY ESTABLISHED

When a printing business has reached the manufacturing stage (whether of periodicals, newspapers, books or commercial work) it has usually proved that it is established on foundations which insure its permanency. Its every purchase should then be made with a view to the longest service and the greatest efficiency. In the composing-room no equipments are so economical as those well made in iron and steel, which are practically indestructible, and preserve their style and finish and dignity while being handed down from one generation to another.

ECONOMY

Modern buying is advancing from the effort to cheapen to the demand for greatest value. Permanency is coming to be recognized as a chief consideration in purchasing equipments. Hence the present tremendous rebuilding of railroads and business edifices, the sole motive for which outlay is to realize permanent economies. The larger printing plants cannot be fully efficient with ready-made composing-room equipments designed for the average plant. Our Specially Designed Iron and Steel Composing Room Equipments are practically indestructible and economize in space and time.

EFFICIENCY

Labor Cost is increasing, and will inevitably continue to increase. The apparatus for doing business is constantly becoming more intricate and expensive. One field of economy still remains uncultivated: the Increase of Efficiency in the use of business apparatus—men, equipments and machines—by the elimination of Waste Time, Waste Movements and Waste Space. Our efficiency department designs and manufactures Equipments for Composing Rooms which prevent such waste. It plans and installs Economies, as distinguished from those methods which perpetuate Inefficiency.

For further information address

EFFICIENCY DEPARTMENT AMERICAN TYPE FOUNDERS COMPANY

NUMBER THREE HUNDRED COMMUNIPAW AVENUE
JERSEY CITY, NEW JERSEY

72 Point

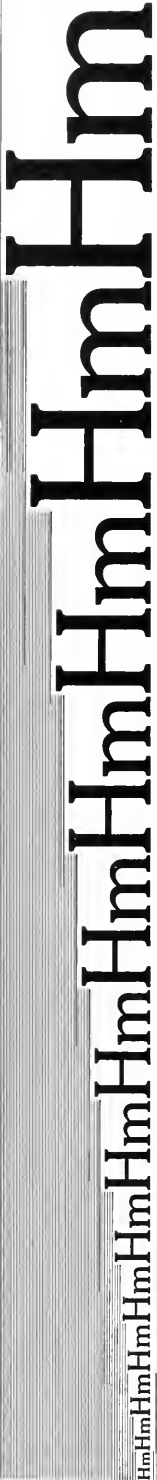

72 Point

AMERICAN TYPE SYSTEM

Point Adjustments of Body, Widths and Line

AMERICAN POINT BODIES

American types are manufactured accurately on interchangeable point bodies, and so are the brass rules, leads and slugs, metal furniture and cast cuts shown in this catalogue.

AMERICAN POINT SET

To facilitate accurate and easy justification, American types are cast to widths that are multiples of a typographic point or fractions thereof.

AMERICAN POINT LINE

- I. **American Common Line**—the line common to the majority of faces.
- II. **American TITLE LINE**—chiefly used for Title faces.
- III. **American Script Line**—embraces Script and other faces with long descenders.

The **American Lining System** is the perfection of the systems adopted by the type founders of this country. The use of the **American Lining System** is here exemplified in the use, *without justification*, of different type faces cast on the **American Common Line**—a feature that must commend itself to **Printers** for its simplicity and **practical use**.

Every face on **Common Line** will line at the bottom with all faces cast on the same body; and by using point leads each size will line with all other sizes cast on either **Common, Title or Script Lines**.

The example on this page illustrates practically the 6, 8, 10, 12, 14, 18, 24, 30, 36, 48, 54, 60 and 72 Point sizes of Cheltenham Medium aligned with point justification. To better illustrate the system, one-point brass rule was used in aligning the thirteen sizes—each fine line representing a one-point lead.

American Type Founders Co.

ORIGINATOR OF TYPE FASHIONS

Important to Buyers

The Demand Determines the Supply

THE progressive printers have in reality selected the type faces and decorative materials shown in this Book. Here and there are printers who for one reason or another cling to old-fashioned job type faces, now rapidly becoming obsolete, but the demand for the old-fashioned type faces is so small and dwindling that they cannot profitably be carried in stock.

There is no kind of printing that cannot be done better with the newer progressive type faces than with old-fashioned job type faces.

Printing done with the fashionable, popular and progressive type faces shown in this Book is more valuable to the printers' customers than if set in type faces which are old-fashioned relics of the past



American Type Founders Company

ORIGINATOR OF TYPE STYLES

Information for Buyers

SIZES OF MINIMUM WEIGHT FONTS

Weight Fonts of caps, lower case, figures and points, with small caps, if made, of one body, face and line ordered at one time cast to regular scheme.

- 5 lbs. and multiples, 3 to 4½ Point inclusive.
- 10 lbs. and multiples, 5 and 5½ Point.
- 20 lbs. and multiples, 6 to 18 Point inclusive.
- 25 lbs. and multiples, 20 to 36 Point inclusive.
- 50 lbs. and multiples, 42 to 72 Point inclusive.
- 75 lbs. and multiples, 84 to 96 Point inclusive.
- 100 lbs. and multiples, 120 and 144 Point.

Weight Fonts of Title line faces, caps, figures and points, of one body, face and line, ordered at one time, cast to regular scheme.

- 5 lbs. and multiples, 4 to 5½ Point inclusive.
- 10 lbs. and multiples, 6 to 18 Point inclusive.
- 15 lbs. and multiples, 20 to 36 Point inclusive.
- 20 lbs. and multiples, 42 and 48 Point.
- 25 lbs. and multiples, 54 to 72 Point inclusive.
- 40 lbs. and multiples, 84 and 96 Point.
- 50 lbs. and multiples, 120 and 144 Point.

FIRST CLASS PRICES

Table 1

SIZE POINT	5 LBS.	25 LBS.	100 LBS.	500 LBS.	1000 LBS.	2000 LBS.	3000 LBS.	4000 LBS. & OVER
3.....	\$2.50	\$2.40	\$2.35	\$2.30	\$2.25	\$2.20	\$2.15	\$2.10
3½.....	2.00	1.90	1.85	1.80	1.75	1.70	1.65	1.60
3½ on 4½	1.50	1.40	1.35	1.30	1.25	1.20	1.15	1.10
4.....	1.50	1.40	1.35	1.30	1.25	1.20	1.15	1.10
4½.....	1.20	1.10	1.05	1.00	.98	.96	.94	.92
5.....	1.05	1.00	.97	.95	.94	.92	.90	.88
5½.....	.92	.91	.90	.88	.86	.84	.82	.80
6.....	.79	.78	.77	.76	.74	.72	.70	.68
7.....	.69	.68	.66	.64	.63	.62	.61	.60
8.....	.64	.63	.62	.60	.58	.56	.54	.52
9.....	.60	.59	.58	.56	.55	.54	.52	.50
10.....	.56	.55	.54	.53	.52	.50	.48	.46
11.....	.55	.53	.52	.51	.50	.48	.46	.44
12.....	.52	.51	.49	.48	.47	.46	.45	.44
14.....	.50	.49	.48	.47	.46	.45	.44	.43
18.....	.50	.49	.48	.47	.46	.45	.44	.43
20.....	.49	.49	.48	.47	.46	.45	.44	.43
24.....	.49	.49	.48	.47	.46	.45	.44	.43
30.....	.49	.49	.48	.47	.46	.45	.44	.43
36.....	.49	.49	.48	.47	.46	.45	.44	.43
42.....	.49	.49	.48	.47	.46	.45	.44	.43
48.....	.49	.49	.48	.47	.46	.45	.44	.43
54.....	.49	.49	.48	.47	.46	.45	.44	.43
60.....	.49	.49	.48	.47	.46	.45	.44	.43
72.....	.48	.48	.47	.46	.45	.44	.43	.42
84.....	.46	.46	.45	.44	.43	.42	.41	.40
96.....	.44	.44	.43	.42	.41	.40	.39	.38
100.....	.40	.40	.39	.38	.37	.36	.35	.34
144.....	.38	.38	.37	.36	.35	.34	.33	.32

Items Covered by Table 1

Weight Fonts of minimum weights or multiples thereof of all faces shown in this book excepting Scripts, Rimmed and Shaded faces, Music, Greek, Armenian, Rabbic and Gaelic.

All parts of such Weight Fonts.

All sorts of those faces of one pound or over per character. (For less than one pound see Table 2.)

All fonts of Leaders (3 pound and 5 pound and larger) and all sorts of same of one pound and over per set or character.

All fonts or sorts of Spaces (en space and thinner) excepting Script Spaces and Quads.

Subject to Minimum Sort Rules on page 41.

SECOND CLASS PRICES

Table 2

SIZE POINT	5 LBS.	25 LBS.	100 LBS.	500 LBS.	1000 LBS.	2000 LBS.	3000 LBS.	4000 LBS. & OVER
3.....	\$3.00	\$2.90	\$2.85	\$2.80	\$2.75	\$2.70	\$2.65	\$2.60
3½.....	2.50	2.40	2.35	2.30	2.25	2.20	2.15	2.10
4.....	2.00	1.90	1.85	1.80	1.75	1.70	1.65	1.60
4½.....	1.90	1.80	1.75	1.70	1.65	1.60	1.55	1.50
5.....	1.80	1.60	1.40	1.20	1.10	1.05	1.00	.95
5½.....	1.44	1.20	1.00	.95	.90	.88	.86	.84
6.....	1.16	1.00	.90	.85	.80	.78	.76	.74
7.....	1.00	.85	.80	.75	.70	.68	.66	.64
8.....	.90	.75	.70	.65	.60	.58	.56	.54
9.....	.80	.70	.65	.60	.58	.56	.54	.52
10.....	.74	.65	.60	.58	.56	.54	.52	.50
11.....	.70	.62	.58	.56	.54	.52	.50	.48
12.....	.66	.60	.56	.54	.52	.50	.48	.46
14.....	.62	.58	.56	.54	.52	.50	.48	.46
18.....	.60	.56	.54	.52	.50	.48	.46	.44
20.....	.60	.56	.54	.52	.50	.48	.46	.44
24.....	.56	.54	.52	.51	.50	.48	.46	.44
30.....	.56	.54	.52	.51	.50	.48	.46	.44
36.....	.56	.54	.52	.51	.50	.48	.46	.44
42.....	.54	.52	.51	.50	.49	.48	.46	.44
48.....	.54	.52	.51	.50	.49	.48	.46	.44
54.....	.54	.52	.51	.50	.49	.48	.46	.44
60.....	.54	.52	.51	.50	.49	.48	.46	.44
72.....	.52	.51	.50	.49	.48	.47	.46	.44
84.....	.50	.50	.49	.48	.47	.46	.45	.44
96.....	.48	.48	.47	.46	.45	.44	.43	.42
100.....	.44	.44	.43	.42	.41	.40	.39	.38
144.....	.40	.40	.39	.38	.37	.36	.35	.34

Items Covered by Table 2

Weight Fonts of minimum weights or multiples thereof of Scripts, Rimmed and Shaded faces, Greek, Armenian, Rabbic and Gaelic shown in this book.

All parts of such Weight Fonts.

All sorts of those faces one pound or over per character. (For less than one pound see Table 3.)

All sorts of faces listed in Table 1 where quantity is less than one pound per character.

All fonts or sorts of Script Spaces and Quads.

All Body Italic fonts of less than minimum quantities. Subject to Minimum Sort Rules on page 41.

Information for Buyers

Table 3 THIRD CLASS PRICES

SIZE POINT	PER POUND	PER POINT	PER LINE	PER COLUMN	PER PAGE
3	\$5.00	10	\$1.30	48	\$9.72
3½	5.00	11	1.22	54	9.72
4	3.60	12	1.16	60	9.72
4½	3.20	14	1.12	72	68
5	2.80	18	1.00	84	64
5½	2.40	20	.94	96	60
6	2.00	24	.90	120	56
7	1.80	30	.86	144	52
8	1.60	36	.82		
9	1.44	42	.78		

Items Covered by Table 3

All Music Type fonts and sorts.
 All Piece Fraction fonts and sorts.
 All sorts of faces listed in Table 2 where quantity is less than one pound per character.
 Subject to Minimum Sort Rules on page 41.

SPACES AND QUADS IN JOB AND FIVE AND TEN POUND FONTS

Table 4

WEIGHT (LBS.)	SIZE POINT	PRICE PER POINT	PRICE PER LINE	PRICE PER COLUMN	
1	0	3	\$2.15	\$10.65	\$21.25
1	0	3½	1.80	9.00	18.00
1	0	4	1.40	7.00	14.00
1	0	4½	1.10	5.50	11.00
1	0	5	1.00	4.90	9.50
1	0½	5½	.85	4.15	7.70
0	15	6	.70	3.60	6.65
1	1	7	.80	3.15	5.95
1	1	8	.75	2.90	5.45
1	2½	9	.75	2.70	5.10
1	3¼	10	.75	2.55	4.80
1	2¼	11	.65	2.50	4.65
1	3¼	12	.65	2.35	4.40
1	6	14	.75	2.25	4.30
1	14	16	1.00	2.25	4.30
1	14	18	1.00	2.25	4.30
1	14	20	1.00	2.25	4.25
1	14	24	1.00	2.25	4.25
1	14	30	1.00	2.25	4.25
2	2	36	1.15	2.25	4.25
2	6	42	1.30		4.25
2	12	48	1.50		4.25
3	2	54	1.70		4.25
3	6	60	1.80		4.25
4	0	72	2.15		4.20
4	10	84	2.00		4.10
5	6	96	2.30		4.00
6	10	120	2.65		3.80
8	0	144	3.20		3.70

42 Point and larger, not sold in 5-lb. fonts

Items Covered by Table 4

All Job and five and ten pound fonts of Spaces and Quads (excepting Script Spaces and Quads.)

QUAD PRICES

Table 5

SIZE POINT	LESS THAN 5 LBS.	5 LBS. AND OVER	10 LBS. AND OVER	50 LBS. AND OVER	100 LB. AND OVER
3	\$1.75				
3½	1.60				
4	1.30				
4½	1.00				
5	.90	\$0.85	\$0.80	\$0.70	\$0.60
5½	.74	.62	.53	.45	.40
6	.64	.54	.47	.40	.36
7	.56	.50	.44	.38	.34
8	.52	.45	.40	.36	.32
9	.48	.42	.38	.34	.31
10	.46	.40	.36	.32	.30
11	.44	.38	.34	.30	.28
12	.42	.36	.32	.28	.26
14	.40	.36	.31	.26	.24

Items Covered by Table 5

All fonts and sorts of Quads (em and thicker) excepting Script Quads.
 Regular stock, point body, 1, 2 and 3 em Quads (high or low) of one body, ordered at one time, assorted sets or separately.
 Larger than 14 Point at same price per pound as 14 Point
 Subject to Minimum Sort Rules on page 41.

Body Type is put up in packages of the following approximate weights. This table applies only to faces shown on pages 15 to 443.

Table 6

FACE	5 LBS.	10 LBS.	15 LBS.	20 LBS.	25 LBS.	30 LBS.	35 LBS.	40 LBS.	45 LBS.	50 LBS.				
1	8	1	8	1	1	1	0	14	11	7	8	7	5	
2	0	1	8	2	2	2	0	9	6	4	0	1	0	
3	10	0	2	0	1	1	1	0	5	12	10	0	10	0

Where the face does not show Small Caps, the weight of the Cap package is increased.

Weight fonts of other faces are put up to count schemes and the weight of the separate packages of Caps, lower case, figures and points vary with each face.

Body Type Italic is put up in small fonts of the following approximate weights and is sold at prices given in table 2:

1 to 7 point inclusive 2½ pounds and multiples.
 8 to 18 point inclusive 5 pounds and multiples.

MINIMUM SORT RULES—TYPE

The minimum Sort Charge for one body, face and line is 60 cents. For a sort order which includes spaces or quads of the same body as the letter, the charge shall be for the weight ordered at the proportionate pound price, but in no case shall the minimum charge be less than 60 cents.

No sort order will be filled for a less amount per character (or set of spaces or quads) than

Two ounces of each character in bodies 3 Point to 5½ Point inclusive; 4 ounces of each character in bodies 6 Point to 18 Point inclusive; 6 ounces of each character in bodies 20 Point to 48 Point inclusive; 8 ounces of each character in bodies 54 Point and larger.

OLD METALS TAKEN IN EXCHANGE

Old type made by regular typefounders; printers' old brass; electros, stereotypes, leads and slugs; metal furniture; linotype slugs and Lanston type, if packed separately, unmixed with other metals (particularly zinc), in their original manufactured condition (not melted down), and shipped prepaid or delivered to nearest selling branch or foundry will be accepted at current prices in exchange for new type and other printing materials at our regular discounts as advertised by this Company from time to time.

As old metal cannot be easily identified when several shipments arrive at about the same time, it is necessary to put shipper's name on each package, and advise us promptly of shipment, sending us a copy of freight receipt showing number of boxes or other packages, the gross weight thereof and a memorandum giving exact weights of each class of metal.

Stereotype plates and bases made by The American Press Association, Newspaper Unions or similar manufacturers, being the property of these concerns, are not accepted.

ACCENTED LETTERS FOR BODY AND JOB TYPE

For list prices of fonts of accented letters for various languages see page 887.

Accented letters, when ordered with the font, whether for body or job faces, are sold at the same price per pound as the font.

A table of all accents regularly made, with their designating numbers, is shown on page 886.

Information for Buyers

SCHEME FOR 100-LB. FONT BODY TYPE

	LB.	OZ.	LB.	OZ.	LB.	OZ.	LB.	OZ.	
a	4	6	A	8½	A	2½	1	8	
b	1		B	5	B	1½	2	6½	
c	1	14	C	7½	C	2	3	5½	
d	3		D	6½	D	2	4	5	
e	6	8	E	10	E	3½	2	6½	
f	1		F	5	F	1½	5	5	
g	1	4	G	5½	G	1½	2	7	
h	3	8	H	6½	H	1½	2	8	
i	2	12	I	4	I	1½	9	5	
j	5	8	J	6	J	1½	0	10	
k	1	8	K	4	K	1½	2	2	
l	2	10	L	6	L	2		½	
m	4	6	M	7½	M	2¼			
n	4	4	N	7½	N	2½			
o	4	4	O	7½	O	2½			
p	1	6	P	6	P	1¾	4	0	
q	3	5	Q	2½	Q	¾			
r	3	5	R	8	R	2¼	1	8	
s	3	6	S	8	S	2¼			
t	3	12	T	9	T	2½			
u	2	2	U	5	U	1½			
v	14		V	3½	V	1		9	
w	1	10	W	7	W	2		4	
x	5		X	2	X	¾	1	2	
y	1	4	Y	4½	Y	1¾		2	
z	4		Z	2	Z	½		3	
æ	1	1	Æ	¾	Æ	¼		2	
œ	1	1	Œ	¾	Œ	¼		3	
fi	5		&	3	&	1		1	
ff	4								
ffi	4								
ffl	3								
TOTALS									
		58	12	10	0				
Lower Case								58¾	
Points								4¼	
Figures								4	
Caps								10	
Small Caps								3	
Spaces								10	
Quadrats								10	
								100	
								en set 2	
								3-em set 6	
								4-em set 1	
								5-em set 10	
								hair 2	
SPACES									
		en set		2	4				
		3-em set		6					
		4-em set		1				10	
		5-em set						2	
QUADRATS									
		en set		1	10				
		2-em set		4				2	
		3-em set		4				4	

SCHEME OF SUNDRIES FOR 100 LBS. ROMAN

FRACTIONS		DASHES AND BRACES		REFERENCES		COMMERCIAL MARKS		LEADERS	
LB	OZ	LB	OZ	LB	OZ	LB	OZ	LB	OZ
¼	6	—	½	*	2	@	6	en set	4
½	3	—	¼	†	1	#	3	em set	12
¾	2	—	⅛	‡	½	h	3	2-em set	2
⅞	1	—	1/16	§	¼	l	2	3-em set	2
1	1	—	1/32		1/8	o	1½		
1 ¼	1	—	1/64	¶	1/16	p			
1 ½	1	—	1/32		1/8	q			
1 ¾	1	—	1/16		1/4	r			
2	1	—	1/8		1/2	s	1	0	5
2 ¼	1	—	1/4		3/4	t			0
2 ½	1	—	3/8		5/8	u			
2 ¾	1	—	7/8		7/8	v			
3	1	—	1		1	w			
								Leaders	5 lb.
								References	8 oz.
								Braces and Dashes	1 lb.
								Fractions	1 lb.
								Commercial Marks	1 lb.

Table of Point Set Spaces Divided Showing Sorts Charged Under Various Price Tables:

BODY	SPACES HAIR AND THINNER THAN 5 EMS	FOR				QUADS		
		S	4	3	N-QD	M-QD	2-EM	3-EM
		EM	EM	EM				
5 Point	1	1¼	1½	2	2½	5	10	15
5½ Point	1	1¼	1½	2	2¾	5½	11	16½
6 Point	1	1¼	1½	2	3	6	12	18
7 Point		1¼	1½	2	3½	7	14	21
8 Point		1¼	1½	2	4	8	16	24
9 Point		1½	1¾	2¼	3	4½	9	18
10 Point		1¾	2	2½	3½	5	10	20
11 Point		1¾	2¼	2¾	3	5½	11	22
12 Point		1¾	2½	3	4	6	12	24
14 Point		2	3	4	5	7	14	28
16 Point		2	3	4	5	8	16	32
18 Point		2	3	4	6	9	18	36
20 Point	2	3	4	5	7	10	20	40
24 Point	2	3	4	6	8	12	24	48
30 Point	3	4	6	8	10	15	30	
36 Point	3	4	6	9	12	18	36	
42 Point	4	6	9	11	14	21	42	
48 Point	4	6	9	12	16	24	48	
54 Point	4	6	9	12	18	27	54	
60 Point	5	6	8	12	15	20	60	
72 Point	5	6	9	12	18	24	36	72
84 Point	6	9	12	16	21	28	42	84
96 Point	6	9	12	18	24	32	48	96
120 Point	6	9	12	18	24	30	40	60

HOW TO BUY TYPE ADVANTAGEOUSLY

By ordering in regular fonts (or regular parcels of weight fonts) buyers will get quick delivery and the lowest prices.

Orders for less than fonts (or regular parcels of fonts) and for type to be put up to irregular schemes or assortments are classified as Sort Orders, and are usually cast to order, involving delay and sometimes necessitating billing at higher prices.

The lowest prices for Job Type are obtained by buying in Weight Fonts in conformity with sizes of Minimum Weight Fonts at the top of page 40.

The lowest prices for additions to body type fonts are obtained by buying the regular sections of regular fonts in conformity with Table 6, page 40.

When prices are graded according to quantities ordered at one time, it is important to remember that the actual weight ordered is the factor determining the list price. If, for instance, a 500-pound font is ordered, and the weight is diminished by omitting from the order any section of the 500-pound font, the rate for 500 pounds does not apply, unless other sections of fonts of the same body, face and line are included as substitutes for the sections omitted.

In ordering additions to fonts to match type in use it is necessary to send a cap H and lower-case m (selecting letters that are least worn), in addition to stating (where possible) the correct

name and size of face and the name of the manufacturer of the type ordered. Omission to send samples may make it necessary to hold order while request to send samples is sent to customer.

It is important in ordering to use the exact name of type as printed in specimen books, giving name and date of specimen book and page on which the type is shown. So simple a change as ordering "Gothic Condensed" when the printed name is "Condensed Gothic," or the omission of the correct number may involve uncertainty and delay.

If any part of an order is required more urgently than the balance of the order, that fact should be stated, for sometimes an unimportant item, which may have to be made to order, may delay delivery of the items urgently needed.

Customers are usually in a better position to select the manner and route of shipping their orders, and can frequently effect economies of time and expense by adding shipping directions to their orders. Small quantities shipped by freight frequently cost as much or more than if shipped by express, are liable to delay and are frequently lost.

Estimates of cost of printing plants are furnished in detail upon request, but it is not possible to make an intelligent estimate unless an approximate idea of the amount the inquirer wishes to invest in his enterprise is stated, and also the nature of the work to be produced.

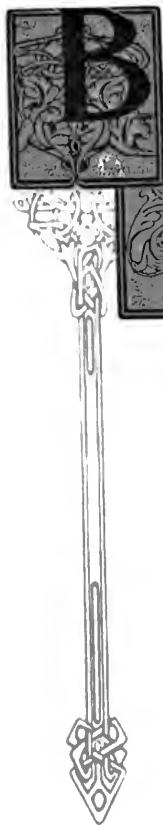

BODY TYPE

*Roman and
Oldstyle*

BEING
A COMPLETE SHOWING
OF
BEAUTIFUL
AND
USEFUL
TYPE FACES

AMERICAN TYPE FOUNDERS COMPANY

BODY TYPES

Announcement

Pages 44 to 144 show specimens of a selection of the best Modern and Oldstyle Body Types made by the American Type Founders Company and Inland Type Foundry. This selection covers every requirement of book, newspaper and general printing offices. The specimens are shown in various ways for the buyers' convenience.

First: Specimens by sizes in single lines of all series to permit ready comparisons of width, color and design.

Second: Specimens by sizes in paragraphs of series to permit of more critical comparison of mass or page effects.

Third: Specimens in large paragraphs arranged in series, to facilitate ordering a suitable gradation of sizes after the series has been selected.

INDEX

Synopsis of Lining Modern Roman Body Type Faces	44, 45
Synopsis of Lining Oldstyle Body Type Faces	96, 97
Lining Modern Roman Body Type Faces, showing sizes	46-59
Lining Oldstyle Body Type Faces, shown by sizes in series	98-109
Lining Modern Body Type Faces	60-95
Lining Oldstyle Body Type Faces, shown in series	110-143

Important Notice

To prevent confusion of identical numbers heretofore used by both this and other type foundries to identify body type faces, the numbers 570 have been added to the old numbers used by the Inland Type Foundry. Thus, former No. 10 of the Inland Type Foundry is now No. 580, and former No. 2 is No. 572. The following is a list of changes in numbering body type faces originated by the Inland Foundry.

Inland Oldstyle No. 9 now No. 579	Inland Roman No. 20 now No. 590
Inland Oldstyle No. 11 now No. 581	Inland Roman No. 26 now No. 596
Inland Oldstyle No. 13 now No. 583	Inland Roman No. 29 now No. 599
Inland Oldstyle No. 16 now No. 586	

American Type Founders Co.

SYNOPSIS OF LINING MODERN ROMAN BODY TYPE FACES

Series No.

4 POINT LINING MODERN ROMAN

A—When, in the course of human events, it becomes necessary for one people to dissolve the political bands which have coned

4¹/₂ POINT LINING MODERN ROMAN

A—When, in the course of human events, it becomes necessary for one people to dissolve the political bands which have conern

5 POINT LINING MODERN ROMAN

524—When, in the course of human events, it becomes necessary for one people to dissolve the political bands which hai

A—When, in the course of human events, it becomes necessary for one people to dissolve the political bands w

590—When, in the course of human events, it becomes necessary for one people to dissolve the political bandspt

527—When, in the course of human events, it becomes necessary for one people to dissolve the politicalt

5¹/₂ POINT LINING MODERN ROMAN

527—When, in the course of human events, it becomes necessary for one people to dissolve the politica

590—When, in the course of human events, it becomes necessary for one people to dissolve the politin

A—When, in the course of human events, it becomes necessary for one people to dissolve the polit

6 POINT LINING MODERN ROMAN

BB—When, in the course of human events, it becomes necessary for one people to dissolve the political bands whie

B—When, in the course of human events, it becomes necessary for one people to dissolve the political bands h

599—When, in the course of human events, it becomes necessary for one people to dissolve the political bandsso

590—When, in the course of human events, it becomes necessary for one people to dissolve the politie

D—When, in the course of human events, it becomes necessary for one people to dissolve the polid

A—When, in the course of human events, it becomes necessary for one people to dissolve the polit

E—When, in the course of human events, it becomes necessary for one people to dissolve the pol

C—When, in the course of human events, it becomes necessary for one people to dissolve the pil

510—When, in the course of human events, it becomes necessary for one people to dissolve the pit

596—When, in the course of human events, it becomes necessary for one people to dissolve the p

7 POINT LINING MODERN ROMAN

599—When, in the course of human events, it becomes necessary for one people to dissolve the po

A—When, in the course of human events, it becomes necessary for one people to dissolve

590—When, in the course of human events, it becomes necessary for one people to dissolv

596—When, in the course of human events, it becomes necessary for one people to disse

8 POINT LINING MODERN ROMAN

599—When, in the course of human events, it becomes necessary for one people to dissolv

BB—When, in the course of human events, it becomes necessary for one people to disso

D—When, in the course of human events, it becomes necessary for one people to ds

E—When, in the course of human events, it becomes necessary for one people to d

B—When, in the course of human events, it becomes necessary for one people tod

C—When, in the course of human events, it becomes necessary for one people ton

590—When, in the course of human events, it becomes necessary for one people to

510—When, in the course of human events, it becomes necessary for one people ts

596—When, in the course of human events, it becomes necessary for one people

A—When, in the course of human events, it becomes necessary for one peopl

9 POINT LINING MODERN ROMAN

599—When, in the course of human events, it becomes necessary for one people c

510—When, in the course of human events, it becomes necessary for one peop

590—When, in the course of human events, it becomes necessary for one peoe

596—When, in the course of human events, it becomes necessary for one pew

A—When, in the course of human events, it becomes necessary for onepe

10 POINT LINING MODERN ROMAN

599—When, in the course of human events, it becomes necessary for one peoi

E—When, in the course of human events, it becomes necessary for one pe

A—Century Expanded B—Bodoni BB—Bodoni Book C—Scotch Roman D—Norwood Roman E—Wayside

10 POINT LINING MODERN ROMAN

- BB- When, in the course of human events, it becomes necessary for one p
- C- When, in the course of human events, it becomes necessary for one it
- 510- When, in the course of human events, it becomes necessary for oni
- 596- When, in the course of human events, it becomes necessary for oni
- B- When, in the course of human events, it becomes necessary for in
- 590- When, in the course of human events, it becomes necessary for w
- D- When, in the course of human events, it becomes necessary fore
- A- When, in the course of human events, it becomes necessary is

11 POINT LINING MODERN ROMAN

- E- When, in the course of human events, it becomes necessary for one
- C- When, in the course of human events, it becomes necessary for ow
- 596- When, in the course of human events, it becomes necessary fort
- 510- When, in the course of human events, it becomes necessary fw
- A- When, in the course of human events, it becomes necessary
- 590- When, in the course of human events, it becomes necessarr

12 POINT LINING MODERN ROMAN

- 599- When, in the course of human events, it becomes necessary for w
- BB- When, in the course of human events, it becomes necessary for
- B- When, in the course of human events, it becomes necessay
- D- When, in the course of human events, it becomes necessai
- E- When, in the course of human events, it becomes necess
- C- When, in the course of human events, it becomes neeen
- 510- When, in the course of human events, it becomes nees
- 596- When, in the course of human events, it becomes need
- A- When, in the course of human events, it becomes neil
- 590- When, in the course of human events, it becomes nii

14 POINT LINING MODERN ROMAN

- BB- When, in the course of human events, it becomes neces
- B- When, in the course of human events, it becomes ni
- C- When, in the course of human events, it beco
- A- When, in the course of human events, it bec

18 POINT LINING MODERN ROMAN

- BB- When, in the course of human events, it bec
- B- When, in the course of human events, it
- A- When, in the course of human even
- C- When, in the course of human even

LINING MODERN ROMAN FACES SHOWN BY SIZES

4 Point Century Expanded

WHEN, in the course of human events, it becomes necessary for one people to dissolve the political bands which have connected them with another, and to assume, among the powers of the earth, the separate and equal station to which the laws of nature and of nature's God entitle them, a decent respect to the opinions of mankind requires that they should declare the causes which impel them to the separation. We hold these truths to be self-evident: That all men are created equal; that they are endowed by their Creator with certain inalienable rights; that among these are life, liberty, and the pursuit of happiness; that, to secure these rights, governments are instituted among men, deriving their just powers from the consent of the governed; that, whenever any form of government becomes destructive of these ends, it is the right of the people to alter or to abolish it, and to institute a new government, laying its foundation on such principles and organizing its powers in such form, as to them shall seem most likely to

Lower case a to z, 17 1-3 ems
ABCDEFGHIJKLMNPOQRSTUVWXYZ
1234567890

4½ Point Century Expanded

WHEN, in the course of human events, it becomes necessary for one people to dissolve the political bands which have connected them with another, and to assume, among the powers of the earth, the separate and equal station to which the laws of nature and of nature's God entitle them, a decent respect to the opinions of mankind requires that they should declare the causes which impel them to the separation. We hold these truths to be self-evident: That all men are created equal; that they are endowed with certain inalienable rights; that among these are life, liberty, and the pursuit of happiness; that, to secure these rights, governments are instituted among men, deriving their just powers from the consent of the governed; that, whenever any form of government becomes destructive of these ends, it is the right of the people to alter or to abolish it and to institute a new government, laying its foundations

Lower case a to z, 15 1-3 ems
ABCDEFGHIJKLMNPOQRSTUVWXYZ
1234567890

5 Point Century Expanded

WHEN, in the course of human events, it becomes necessary for one people to dissolve the political bands which have connected them with another, and to assume, among the powers of the earth, the separate and equal station to which the laws of nature and of nature's God entitle them, a decent respect to the opinions of mankind requires that they should declare the causes which impel them to the separation. We hold these truths to be self-evident: That all men are created equal; that they are endowed by their Creator with certain inalienable rights; that among these are life, liberty, and the pursuit of happiness; that, to secure these rights, governments are instituted among

Lower case a to z, 16 ems
ABCDEFGHIJKLMNPOQRSTUVWXYZ
1234567890

5 Point Roman No. 590

WHEN, in the course of human events, it becomes necessary for one people to dissolve the political bands which have connected them with another, and to assume, among the powers of the earth, the separate and equal station to which the laws of nature and of nature's God entitle them, a decent respect to the opinions of mankind requires that they should declare the causes which impel them to the separation. We hold these truths to be self-evident: That all men are created equal; that they are endowed by their Creator with certain inalienable rights; that among these are life, liberty, and the pursuit of happiness; that, to secure these rights, governments are instituted among

Lower case a to z, 15 3-4 ems
ABCDEFGHIJKLMNPOQRSTUVWXYZ
1234567890

5 Point Lining Roman No. 527

WHEN, in the course of human events, it becomes necessary for one people to dissolve the political bands which have connected them with another, and to assume, among the powers of the earth, the separate and equal station to which the laws of nature and of nature's God entitle them, a decent respect to the opinions of mankind requires that they should declare the causes which impel them to the separation. We hold these truths to be self-evident: That all men are created equal; that they are endowed by their Creator with certain inalienable rights; that among these are life, liberty, and the pursuit of happiness; that, to secure

Lower case a to z, 17 ems
ABCDEFGHIJKLMNPOQRSTUVWXYZ
1234567890

5 Point Lining Roman No. 524

WHEN, in the course of human events, it becomes necessary for one people to dissolve the political bands which have connected them with another, and to assume, among the powers of the earth, the separate and equal station to which the laws of nature and of nature's God entitle them, a decent respect to the opinions of mankind requires that they should declare the causes which impel them to the separation. We hold these truths to be self-evident: That all men are created equal; that they are endowed by their Creator with certain inalienable rights; that among these are life, liberty, and the pursuit of happiness; that, to secure these rights, governments are instituted among men, deriving their just powers from the consent of the gov-

Lower case a to z, 14 1-2 ems
ABCDEFGHIJKLMNPOQRSTUVWXYZ
1234567890

5½ Point Century Expanded

WHEN, in the course of human events, it becomes necessary for one people to dissolve the political bands which have connected them with another, and to assume, among the powers of the earth, the separate and equal station to which the laws of nature and of nature's God entitle them, a decent respect to the opinions of mankind requires that they declare the causes which impel them to the separation. We hold these truths to be self-evident: That all men are created equal; that they are endowed by their Creator with certain inalienable rights; that among these are life, liberty, and the pursuit of happiness; that, to secure

Lower case a to z, 17 ems
ABCDEFGHIJKLMNPOQRSTUVWXYZ
1234567890

5½ Point Lining Roman No. 527

WHEN, in the course of human events, it becomes necessary for one people to dissolve the political bands which have connected them with another, and to assume, among the powers of the earth, the separate and equal station to which the laws of nature and of nature's God entitle them, a decent respect to the opinions of mankind requires that they should declare the causes which impel them to the separation. We hold these truths to be self-evident: That all men are created equal; that they are endowed by their Creator with certain inalienable rights; that among these

Lower case a to z, 16 ems
ABCDEFGHIJKLMNPOQRSTUVWXYZ
1234567890

5½ Point Roman No. 590

WHEN, in the course of human events, it becomes necessary for one people to dissolve the political bands which have connected them with another, and to assume, among the powers of the earth, the separate and equal station to which the laws of nature and of nature's God entitle them, a decent respect to the opinions of mankind requires that they should declare the causes which impel them to the separation. We hold these truths to be self-evident: That all men are created equal; that they are endowed by their Creator with certain inalienable rights; that among these are life, liberty, and the pursuit of happiness; that, to secure these rights, governments are instituted among men, deriving their just powers from the consent of the governed; that, whenever any form of government becomes destructive of these ends, it is the right of the people to alter or to abolish it and to institute a new government, laying its foundation on such principles, and organizing its powers in such form, as to them shall seem most likely to effect their safety and happiness. Prudence, indeed, will dictate that governments long established should not be changed for light and transient causes; and, accordingly, all experience hath shown that man-

Lower case a to z, 16 1-4 ems
ABCDEFGHIJKLMNPOQRSTUVWXYZ
1234567890

LINING MODERN ROMAN FACES SHOWN BY SIZES

6 Point Roman No. 590

WHEN, in the course of human events, it becomes necessary for one people to dissolve the political bands which have connected them with another, and to assume, among the powers of the earth, the separate and equal station to which the laws of nature and of nature's God entitle them, a decent respect to the opinions of mankind requires that they should declare the causes which impel them to the separation. We hold these truths to be self-evident: That all men are created equal, that they are endowed by their Creator with certain inalienable rights, that among these are life, liberty, and the pursuit of happiness; that, to secure these rights, governments are instituted among men, deriving their just powers from the consent of the governed; that, whenever any form of government becomes destructive of these ends, it is the right of the people to alter or to abolish it, and to institute a new government, laying its foundation on such principles, and organizing its powers in such form, as to them shall seem most likely to effect their safety and happiness. Prudence, indeed, will dictate that governments long established should not be changed for light and transient causes; and, accordingly, all experience hath shown that mankind are more

Lower case a to z, 13 ems

ABCDEFGHIJKLMN O PQRSTU VWXYZ
1234567890

6 Point Roman No. 596

WHEN, in the course of human events, it becomes necessary for one people to dissolve the political bands which have connected them with another, and to assume, among the powers of the earth, the separate and equal station to which the laws of nature and of nature's God entitle them, a decent respect to the opinions of mankind requires that they should declare the causes which impel them to the separation. We hold these truths to be self-evident: That all men are created equal, that they are endowed by their Creator with certain inalienable rights, that among these are life, liberty, and the pursuit of happiness; that, to secure these rights, governments are instituted among men, deriving their just powers from the consent of the governed; that, whenever any form of government becomes destructive of these ends, it is the right of the people to alter or to abolish it, and to institute a new government, laying its foundation on such principles, and organizing its powers in such form, as to them shall seem most likely to effect their safety and happiness. Prudence, indeed, will dictate that governments long established should not be changed for light and transient causes; and, accordingly, all experience hath shown that mankind are more

Lower case a to z, 15.56 ems

ABCDEFGHIJKLMN O PQRSTU VWXYZ
1234567890

6 Point Roman No. 599

WHEN, in the course of human events, it becomes necessary for one people to dissolve the political bands which have connected them with another, and to assume, among the powers of the earth, the separate and equal station to which the laws of nature and of nature's God entitle them, a decent respect to the opinions of mankind requires that they should declare the causes which impel them to the separation. We hold these truths to be self-evident: That all men are created equal; that they are endowed by their Creator with certain inalienable rights; that among these are life, liberty, and the pursuit of happiness; that, to secure these rights, governments are instituted among men, deriving their just powers from the consent of the governed; that, whenever any form of government becomes destructive of these ends, it is the right of the people to alter or to abolish it, and to institute a new government, laying its foundation on such principles, and organizing its powers in such form, as to them shall seem most likely to effect their safety and happiness. Prudence, indeed, will dictate that governments long established should not be changed for light and transient causes; and, accordingly, all experience hath shown that mankind are more

Lower case a to z, 13.14 ems

ABCDEFGHIJKLMN O PQRSTU VWXYZ
1234567890

6 Point Bodoni Book

WHEN, in the course of human events, it becomes necessary for one people to dissolve the political bands which have connected them with another, and to assume, among the powers of the earth, the separate and equal station to which the laws of nature and of nature's God entitle them, a decent respect to the opinions of mankind requires that they should declare the causes which impel them to the separation. We hold these truths to be self-evident: That all men are created equal, that they are endowed by their Creator with certain inalienable rights, that among these are life, liberty, and the pursuit of happiness; that, to secure these rights, governments are instituted among men, deriving their just powers from the consent of the governed; that, whenever any form of government becomes destructive of these ends, it is the right of the people to alter or to abolish it, and to institute a new government, laying its foundation on such principles, and organizing its powers in such form, as to them shall seem most likely to effect their safety and happiness. Prudence, indeed, will dictate that governments long established should not be changed for light and transient causes; and, accordingly, all experience hath shown that mankind are more

Lower Case a to z, 12.12 ems

ABCDEFGHIJKLMN O PQRSTU VWXYZ
1234567890

6 Point Bodoni

WHEN, in the course of human events, it becomes necessary for one people to dissolve the political bands which have connected them with another, and to assume, among the powers of the earth, the separate and equal station to which the laws of nature and of nature's God entitle them, a decent respect to the opinions of mankind requires that they should declare the causes which impel them to the separation. We hold these truths to be self-evident: That all men are created equal; that they are endowed by their Creator with certain inalienable rights; that among these are life, liberty, and the pursuit of happiness; that, to secure these rights, governments are instituted among men, deriving their just powers from the consent of the governed; that, whenever any form of government becomes destructive of these ends, it is the right of the people to alter or to abolish it, and to institute a new government, laying its foundation on such principles, and organizing its powers in such form, as to them shall seem most likely to effect their safety and happiness. Prudence, indeed, will dictate that governments long established should not be changed for light and transient causes; and, accordingly, all experience hath shown that mankind are more

Lower case a to z, 13.16 ems

ABCDEFGHIJKLMN O PQRSTU VWXYZ
1234567890

LINING MODERN ROMAN FACES SHOWN BY SIZES

6 Point Lining Roman No. 510

WHEN, in the course of human events, it becomes necessary for one people to dissolve the political bands which have connected them with another, and to assume, among the powers of the earth, the separate and equal station to which the laws of nature and of nature's God entitle them, a decent respect to the opinions of mankind requires that they should declare the causes which impel them to the separation. We hold these truths to be self-evident: That all men are created equal; that they are endowed by their Creator with certain inalienable rights; that among these are life, liberty, and the pursuit of happiness; that, to secure these rights, governments are instituted among men, deriving their just powers from the consent of the governed; that, whenever any form of government becomes destructive of these ends, it is the right of the people to alter or to abolish it and to institute a new government, laying its foundation on such principles, and organizing its powers in such form, as to them shall seem most likely to effect their safety and happiness. Prudence, indeed, will dictate that govern-

Lower case a to z, 15 5-6 ems

ABCDEFGHIJKLMN OPQRSTUVWXYZ
1234567890

6 Point Norwood Roman

WHEN, in the course of human events, it becomes necessary for one people to dissolve the political bands which have connected them with another, and to assume, among the powers of the earth, the separate and equal station to which the laws of nature and of nature's God entitle them, a decent respect to the opinions of mankind requires that they should declare the causes which impel them to the separation. We hold these truths to be self-evident: That all men are created equal; that they are endowed by their Creator with certain inalienable rights; that among these are life, liberty, and the pursuit of happiness; that, to secure these rights, governments are instituted among men, deriving their just powers from the consent of the governed; that, whenever any form of government becomes destructive of these ends, it is the right of the people to alter or to abolish it and to institute a new government, laying its foundation on such principles, and organizing its powers in such form, as to them shall seem most likely to effect their safety and happiness. Prudence, indeed, will dictate that

Lower case a to z, 15 2-6 ems

ABCDEFGHIJKLMN OPQRSTUVWXYZ
1234567890

6 Point Scotch Roman

WHEN, in the course of human events, it becomes necessary for one people to dissolve the political bands which have connected them with another, and to assume, among the powers of the earth, the separate and equal station to which the laws of nature and of nature's God entitle them, a decent respect to the opinions of mankind requires that they should declare the causes which impel them to the separation. We hold these truths to be self-evident: That all men are created equal; that they are endowed by their Creator with certain inalienable rights; that among these are life, liberty, and the pursuit of happiness; that, to secure these rights, governments are instituted among men, deriving their just powers from the consent of the governed; that, whenever any form of government becomes destructive of these ends, it is the right of the people to alter or to abolish it and to institute a new government, laying its foundation on such principles, and organizing its powers in such form, as to them shall seem most likely to effect their safety and happiness. Prudence,

Lower case a to z, 15 2-3 ems

ABCDEFGHIJKLMN OPQRSTUVWXYZ
1234567890

6 Point Wayside

WHEN, in the course of human events, it becomes necessary for one people to dissolve the political bands which have connected them with another, and to assume, among the powers of the earth, the separate and equal station to which the laws of nature and of nature's God entitle them, a decent respect to the opinions of mankind requires that they should declare the causes which impel them to the separation. We hold these truths to be self-evident: That all men are created equal; that they are endowed by their Creator with certain inalienable rights; that among these are life, liberty, and the pursuit of happiness; that, to secure these rights, governments are instituted among men, deriving their just powers from the consent of the governed; that, whenever any form of government becomes destructive of these ends, it is the right of the people to alter or to abolish it and to institute a new government, laying its foundation on such principles, and organizing its powers in such form, as to them shall seem most likely to effect their safety and happiness. Prudence, indeed, will

Lower case a to z, 15 1-2 ems

ABCDEFGHIJKLMN OPQRSTUVWXYZ
1234567890

6 Point Century Expanded

WHEN, in the course of human events, it becomes necessary for one people to dissolve the political bands which have connected them with another, and to assume, among the powers of the earth, the separate and equal station to which the laws of nature and of nature's God entitle them, a decent respect to the opinions of mankind requires that they should declare the causes which impel them to the separation. We hold these truths to be self-evident: That all men are created equal; that they are endowed by their Creator with certain inalienable rights; that among these are life, liberty, and the pursuit of happiness; that, to secure these rights, governments are instituted among men, deriving their just powers from the consent of the governed; that, whenever any form of government becomes destructive of these ends, it is the right of the people to alter or to abolish it and to institute a new government, laying its foundation on such principles, and organizing its powers in such form, as to them shall seem most likely to effect their safety and happiness. Prudence, indeed, will dictate

Lower case a to z, 15 1-2 ems

ABCDEFGHIJKLMN OPQRSTUVWXYZ
1234567890

LINING MODERN ROMAN FACES SHOWN BY SIZES

7 Point Roman No. 588

WHEN, in the course of human events, it becomes necessary for one people to dissolve the political bands which have connected them with another, and to assume, among the powers of the earth, the separate and equal station to which the laws of nature and of nature's God entitle them, a decent respect to the opinions of mankind requires that they should declare the causes which impel them to the separation. We hold these truths to be self-evident: That all men are created equal; that they are endowed by their Creator with certain inalienable rights; that among these are life, liberty, and the pursuit of happiness; that, to secure these rights, governments are instituted among men, deriving their just powers from the consent of the governed; that, whenever any form of government becomes destructive of these ends, it is the right of the people to alter or to abolish it and to institute a new government, laying its foundation on such principles, and organizing its powers in such form, as to them shall seem most likely to effect their safety and happiness. Prudence,

Lower case a to z, 14.7 ems

ABCDEFGHIJKLMNOPQRSTUVWXYZ
1234567890

7 Point Roman No. 596

WHEN, in the course of human events, it becomes necessary for one people to dissolve the political bands which have connected them with another, and to assume, among the powers of the earth, the separate and equal station to which the laws of nature and of nature's God entitle them, a decent respect to the opinions of mankind requires that they should declare the causes which impel them to the separation. We hold these truths to be self-evident: That all men are created equal; that they are endowed by their Creator with certain inalienable rights; that among these are life, liberty, and the pursuit of happiness; that, to secure these rights, governments are instituted among men, deriving their just powers from the consent of the governed; that, whenever any form of government becomes destructive of these ends, it is the right of the people to alter or to abolish it and to institute a new government, laying its foundation on such principles, and organizing its powers in such form, as to them shall seem most likely to effect their safety and happiness. Prudence,

Lower case a to z, 15 ems

ABCDEFGHIJKLMNOPQRSTUVWXYZ
1234567890

7 Point Roman No. 599

WHEN, in the course of human events, it becomes necessary for one people to dissolve the political bands which have connected them with another, and to assume, among the powers of the earth, the separate and equal station to which the laws of nature and of nature's God entitle them, a decent respect to the opinions of mankind requires that they should declare the causes which impel them to the separation. We hold these truths to be self-evident: That all men are created equal; that they are endowed by their Creator with certain inalienable rights; that among these are life, liberty, and the pursuit of happiness; that, to secure these rights, governments are instituted among men, deriving their just powers from the consent of the governed; that, whenever any form of government becomes destructive of these ends, it is the right of the people to alter or to abolish it and to institute a new government, laying its foundation on such principles, and organizing its powers in such form, as to them shall seem most likely to effect their safety and happiness. Prudence, indeed, will dictate that governments long established should not be changed for light and transient causes; and, accordingly,

Lower case a to z, 12.9-11 ems

ABCDEFGHIJKLMNOPQRSTUVWXYZ
1234567890

7 Point Century Expanded

WHEN, in the course of human events, it becomes necessary for one people to dissolve the political bands which connect them with another, and to assume, among the powers of the earth, the separate and equal station to which the laws of nature and of nature's God entitle them, a decent respect to the opinions of mankind requires that they should declare the causes which impel them to the separation. We hold these truths to be self-evident: That all men are created equal; that they are endowed by their Creator with certain inalienable rights; that among these are life, liberty, and the pursuit of happiness; that, to secure these rights, governments are instituted among men, deriving their just powers from the consent of the governed; that, whenever any form of government becomes destructive of these ends, it is the right of the people to alter or to abolish it and to institute a new government, laying its foundation on such principles, and organizing its powers in such form, as to them shall seem most likely to effect their safety and happiness. Prudence, indeed, will

Lower case a to z, 14.27 ems

ABCDEFGHIJKLMNOPQRSTUVWXYZ
1234567890

LINING MODERN ROMAN FACES SHOWN BY SIZES

8 Point Roman No. 590

WHEN, in the course of human events, it becomes necessary for one people to dissolve the political bands which have connected them with another, and to assume, among the powers of the earth, the separate and equal station to which the laws of nature and of nature's God entitle them, a decent respect to the opinions of mankind requires that they should declare the causes which impel them to the separation. We hold these truths to be self-evident: *That all men are created equal; that they are endowed by their Creator with certain inalienable rights; that among these are life, liberty, and*

Lower case a to z, 13 1-2 ems

ABCDEFGHIJKLMNOPQRSTUVWXYZ

1234567890

8 Point Scotch Roman

WHEN, in the course of human events, it becomes necessary for one people to dissolve the political bands which have connected them with another, and to assume, among the powers of the earth, the separate and equal station to which the laws of nature and of nature's God entitle them, a decent respect to the opinions of mankind requires that they should declare the causes which impel them to the separation. We hold these truths to be self-evident: *That all men are created equal; that they are endowed by their Creator with certain inalienable rights; that among these are life, liberty, and the*

Lower case a to z, 13 1-2 ems

ABCDEFGHIJKLMNOPQRSTUVWXYZ

1234567890

8 Point Norwood Roman

WHEN, in the course of human events, it becomes necessary for one people to dissolve the political bands which have connected them with another, and to assume, among the powers of the earth, the separate and equal station to which the laws of nature and of nature's God entitle them, a decent respect to the opinions of mankind requires that they should declare the causes which impel them to the separation. We hold these truths to be self-evident: *That all men are created equal; that they are endowed by their Creator with certain inalienable rights; that among these are*

Lower case a to z, 13 1-8 ems

ABCDEFGHIJKLMNOPQRSTUVWXYZ

1234567890

8 Point Roman No. 596

WHEN, in the course of human events, it becomes necessary for one people to dissolve the political bands which have connected them with another, and to assume, among the powers of the earth, the separate and equal station to which the laws of nature and of nature's God entitle them, a decent respect to the opinions of mankind requires that they should declare the causes which impel them to the separation. We hold these truths to be self-evident: *That all men are created equal; that they are endowed by their Creator with certain inalienable rights; that among*

Lower case a to z, 14 1-4 ems

ABCDEFGHIJKLMNOPQRSTUVWXYZ

1234567890

8 Point Roman No. 599

WHEN, in the course of human events, it becomes necessary for one people to dissolve the political bands which have connected them with another, and to assume, among the powers of the earth, the separate and equal station to which the laws of nature and of nature's God entitle them, a decent respect to the opinions of mankind requires that they should declare the causes which impel them to the separation. We hold these truths to be self-evident: *That all men are created equal; that they are endowed by their Creator with certain inalienable rights; that among these are life, liberty, and the pursuit of happiness;*

Lower case a to z, 12 1-8 ems

ABCDEFGHIJKLMNOPQRSTUVWXYZ

1234567890

LINING MODERN ROMAN FACES SHOWN BY SIZES

8 Point Lining Roman No. 50

WHEN, in the course of human events, it becomes necessary for one people to dissolve the political bands which have connected them with another, and to assume, among the powers of the earth, the separate and equal station to which the laws of nature and of nature's God entitle them, a decent respect to the opinions of mankind requires that they should declare the causes which impel them to the separation. We hold these truths to be self-evident; That all men are created equal; that they are endowed by their Creator with certain inalienable rights; that among these are life, liberty,

Lower case a to z, 13.18 ems

ABCDEFGHIJKLMN OPQRSTU VWXYZ

1234567890

8 Point Wayside

WHEN, in the course of human events, it becomes necessary for one people to dissolve the political bands which have connected them with another, and to assume, among the powers of the earth, the separate and equal station to which the laws of nature and of nature's God entitle them, a decent respect to the opinions of mankind requires that they should declare the causes which impel them to the separation. We hold these truths to be self-evident; That all men are created equal; that they are endowed by their Creator with certain inalienable rights; that among these are life, liberty,

Lower case a to z, 13.18 ems

ABCDEFGHIJKLMN OPQRSTU VWXYZ

1234567890

8 Point Century Expanded

WHEN, in the course of human events, it becomes necessary for one people to dissolve the political bands which have connected them with another, and to assume, among the powers of the earth, the separate and equal station to which the laws of nature and of nature's God entitle them, a decent respect to the opinions of mankind requires that they should declare the causes which impel them to the separation. We hold these truths to be self-evident; That all men are created equal; that they are endowed by their Creator with certain inalienable

Lower case a to z, 12.14 ems

ABCDEFGHIJKLMN OPQRSTU VWXYZ

1234567890

8 Point Bodoni Book

WHEN, in the course of human events, it becomes necessary for one people to dissolve the political bands which have connected them with another, and to assume, among the powers of the earth, the separate and equal station to which the laws of nature and of nature's God entitle them, a decent respect to the opinions of mankind requires that they should declare the causes which impel them to the separation. We hold these truths to be self-evident; That all men are created equal; that they are endowed by their Creator with certain inalienable rights; that among these are life, liberty, and the pursuit of

Lower case a to z, 12.14 ems

ABCDEFGHIJKLMN OPQRSTU VWXYZ

1234567890

8 Point Bodoni

WHEN, in the course of human events, it becomes necessary for one people to dissolve the political bands which have connected them with another, and to assume, among the powers of the earth, the separate and equal station to which the laws of nature and of nature's God entitle them, a decent respect to the opinions of mankind requires that they should declare the causes which impel them to the separation. We hold these truths to be self-evident; That all men are created equal; that they are endowed by their Creator with certain inalienable rights; that among these are life,

Lower case a to z, 12.14 ems

ABCDEFGHIJKLMN OPQRSTU VWXYZ

1234567890

LINING MODERN ROMAN FACES SHOWN BY SIZES

9 Point Roman No. 510

WHEN, in the course of human events, it becomes necessary for one people to dissolve the political bands which have connected them with another, and to assume, among the powers of the earth, the separate and equal station to which the laws of nature and of nature's God entitle them, a decent respect to the opinions of mankind requires that they declare the causes which impel them to the separation. *We hold these truths to be self-evident: That all men are created equal; that they are endowed by their Creator with certain inalienable rights; that*

Lower case a to z, 12 8-9 ems

ABCDEFGHIJKLMN OPQRSTUVWXYZ
1234567890

9 Point Roman No. 590

WHEN, in the course of human events, it becomes necessary for one people to dissolve the political bands which have connected them with another, and to assume, among the powers of the earth, the separate and equal station to which the laws of nature and of nature's God entitle them, a decent respect to the opinions of mankind requires that they should declare the causes which impel them to the separation. *We hold these truths to be self-evident: That all men are created equal; that they are endowed by their Creator with certain inalienable*

Lower case a to z, 13 ems

ABCDEFGHIJKLMN OPQRSTUVWXYZ
1234567890

9 Point Roman No. 596

WHEN, in the course of human events, it becomes necessary for one people to dissolve the political bands which have connected them with another, and to assume, among the powers of the earth, the separate and equal station to which the laws of nature and of nature's God entitle them, a decent respect to the opinions of mankind requires that they should declare the causes which impel them to the separation. *We hold these truths to be self-evident: That all men are created equal; that they are endowed by their Creator with certain inalienable*

Lower case a to z, 13 2-9 ems

ABCDEFGHIJKLMN OPQRSTUVWXYZ
1234567890

9 Point Roman No. 599

WHEN, in the course of human events, it becomes necessary for one people to dissolve the political bands which have connected them with another, and to assume, among the powers of the earth, the separate and equal station to which the laws of nature and of nature's God entitle them, a decent respect to the opinions of mankind requires that they should declare the causes which impel them to the separation. *We hold these truths to be self-evident: That all men are created equal; that they are endowed by their Creator with certain inalienable rights; that among these are life,*

Lower case a to z, 12 1-9 ems

ABCDEFGHIJKLMN OPQRSTUVWXYZ
1234567890

9 Point Century Expanded

WHEN, in the course of human events, it becomes necessary for one people to dissolve the political bands which have connected them with another, and to assume, among the powers of the earth, the separate and equal station to which the laws of nature and of nature's God entitle them, a decent respect to the opinions of mankind requires that they should declare the causes which impel them to the separation. *We hold these truths to be self-evident: That all men are created equal; that they are endowed*

Lower case a to z, 14 ems

ABCDEFGHIJKLMN OPQRSTUVWXYZ
1234567890

LINING MODERN ROMAN FACES SHOWN BY SIZES

10 Point Lining Roman No. 40

WHEN, in the course of human events, it becomes necessary for one people to dissolve the political bands which have connected them with another, and to assume, among the powers of the earth, the separate and equal station to which the laws of nature and of nature's God entitle them, a decent respect to the opinions of mankind requires that they should declare the causes which impel them to the separation. We hold these truths to be self-evident; That all men are created equal; that they are endowed by their

Lower case a to z, 11.7-10 ems

ABCDEFGHIJKLMN OPQRSTUVWXYZ
1234567890

10 Point Scotch Roman

WHEN, in the course of human events, it becomes necessary for one people to dissolve the political bands which have connected them with another, and to assume, among the powers of the earth, the separate and equal station to which the laws of nature and of nature's God entitle them, a decent respect to the opinions of mankind requires that they should declare the causes which impel them to the separation. We hold these truths to be self-evident; That all men are created equal; that they are endowed by their Creator with certain

Lower case a to z, 12 ems

ABCDEFGHIJKLMN OPQRSTUVWXYZ
1234567890

10 Point Wayside

WHEN, in the course of human events, it becomes necessary for one people to dissolve the political bands which have connected them with another, and to assume, among the powers of the earth, the separate and equal station to which the laws of nature and of nature's God entitle them, a decent respect to the opinions of mankind requires that they should declare the causes which impel them to the separation. We hold these truths to be self-evident; That all men are created equal; that they are endowed by their Creator with certain inalienable

Lower case a to z, 11.7-10 ems

ABCDEFGHIJKLMN OPQRSTUVWXYZ
1234567890

10 Point Roman No. 506

WHEN, in the course of human events, it becomes necessary for one people to dissolve the political bands which have connected them with another, and to assume, among the powers of the earth, the separate and equal station to which the laws of nature and of nature's God entitle them, a decent respect to the opinions of mankind requires that they should declare the causes which impel them to the separation. We hold these truths to be self-evident; That all men are created equal; that they are endowed by their Creator with certain inalienable

Lower case a to z, 12.3-5 ems

ABCDEFGHIJKLMN OPQRSTUVWXYZ
1234567890

10 Point Roman No. 509

WHEN, in the course of human events, it becomes necessary for one people to dissolve the political bands which have connected them with another, and to assume, among the powers of the earth, the separate and equal station to which the laws of nature and of nature's God entitle them, a decent respect to the opinions of mankind requires that they should declare the causes which impel them to the separation. We hold these truths to be self-evident; That all men are created equal; that they are endowed by their Creator with certain inalienable

Lower case a to z, 11.7-10 ems

ABCDEFGHIJKLMN OPQRSTUVWXYZ
1234567890

LINING MODERN ROMAN FACES SHOWN BY SIZES

10 Point Roman No. 590

WHEN, in the course of human events, it becomes necessary for one people to dissolve the political bands which have connected them with another, and to assume, among the powers of the earth, the separate and equal station to which the laws of nature and of nature's God entitle them, a decent respect to the opinions of mankind requires that *they should declare the causes which impel them to the separation. We hold these truths to be self-evident: That all men are created equal; that*

Lower case a to z, 12.9-10 ems

ABCDEFGHIJKLMNOPQRSTUVWXYZ
1234567890

10 Point Bodoni Book

WHEN, in the course of human events, it becomes necessary for one people to dissolve the political bands which have connected them with another, and to assume, among the powers of the earth, the separate and equal station to which the laws of nature and of nature's God entitle them, a decent respect to the opinions of mankind requires that they should declare the *causes which impel them to the separation. We hold these truths to be self-evident: That all men are created equal; that they are endowed by their Creator*

Lower case a to z, 11.3-4 ems

ABCDEFGHIJKLMNOPQRSTUVWXYZ
1234567890

10 Point Bodoni

WHEN, in the course of human events, it becomes necessary for one people to dissolve the political bands which have connected them with another, and to assume, among the powers of the earth, the separate and equal station to which the laws of nature and of nature's God entitle them, a decent respect to the opinions of mankind requires that *they should declare the causes which impel them to the separation. We hold these truths to be self-evident: That all men are created equal; that*

Lower case a to z, 13 ems

ABCDEFGHIJKLMNOPQRSTUVWXYZ
1234567890

10 Point Norwood Roman

WHEN, in the course of human events, it becomes necessary for one people to dissolve the political bands which have connected them with another, and to assume, among the powers of the earth, the separate and equal station to which the laws of nature and of nature's God entitle them, a decent respect to the opinions of mankind requires that *they declare the causes which impel them to the separation. We hold these truths to be self-evident: That all men are created equal;*

Lower case a to z, 13.2-5 ems

ABCDEFGHIJKLMNOPQRSTUVWXYZ
1234567890

10 Point Century Expanded

WHEN, in the course of human events, it becomes necessary for one people to dissolve the political bands that have connected them with another, and to assume, among the powers of the earth, the separate and equal station to which the laws of nature and of nature's God entitle them, a decent respect to the opinions of mankind requires that *they should declare the causes which impel them to the separation. We hold these truths to be self-evident: That all*

Lower case a to z, 14 ems

ABCDEFGHIJKLMNOPQRSTUVWXYZ
1234567890

LINING MODERN ROMAN FACES SHOWN BY SIZES

11 Point Lining Roman No. 510

WHEN, in the course of human events, it becomes necessary for one people to dissolve the political bands which have connected them with another, and to assume, among the powers of the earth, the separate and equal station to which the laws of nature and of nature's God entitle them, a decent respect to the opinions of mankind requires that they should declare the causes which impel them to the separation.

Lower case a to z, 11.4-11 em.

ABCDEFGHIJKLMN OPQRSTUVWXYZ
1234567890

11 Point Scotch Roman

WHEN, in the course of human events, it becomes necessary for one people to dissolve the political bands which have connected them with another, and to assume, among the powers of the earth, the separate and equal station to which the laws of nature and of nature's God entitle them, a decent respect to the opinions of mankind requires that they should declare the causes which impel them to the separation. We hold these truths

Lower case a to z, 11.2-11 em.

ABCDEFGHIJKLMN OPQRSTUVWXYZ
1234567890

11 Point Roman No. 590

WHEN, in the course of human events, it becomes necessary for one people to dissolve the political bands which have connected them with another, and to assume, among the powers of the earth, the separate and equal station to which the laws of nature and of nature's God entitle them, a decent respect to the opinions of mankind requires that they should declare the causes

Lower case a to z, 11.2-11 em.

ABCDEFGHIJKLMN OPQRSTUVWXYZ
1234567890

11 Point Wayside

WHEN, in the course of human events, it becomes necessary for one people to dissolve the political bands which have connected them with another, and to assume, among the powers of the earth, the separate and equal station to which the laws of nature and of nature's God entitle them, a decent respect to the opinions of mankind requires that they should declare the causes which impel them to the separation. We hold these truths to be

Lower case a to z, 11.5-11 em.

ABCDEFGHIJKLMN OPQRSTUVWXYZ
1234567890

11 Point Century Expanded

WHEN, in the course of human events, it becomes necessary for one people to dissolve the political bands which have connected them with another, and to assume, among the powers of the earth, the separate and equal station to which the laws of nature and of nature's God entitle them, a decent respect to the opinions of mankind requires that they should declare the causes which

Lower case a to z, 11.5-11 em.

ABCDEFGHIJKLMN OPQRSTUVWXYZ
1234567890

LINING MODERN ROMAN FACES SHOWN BY SIZES

12 Point Norwood Roman

WHEN, in the course of human events, it becomes necessary for one people to dissolve the political bands which have connected them with another, and to assume, among the powers of the earth, the separate and equal station to which the laws of nature and of nature's God entitle them, a decent respect to the

Lower case a to z, 12 1-3 ems

ABCDEFGHIJKLMNOPQRSTUVWXYZ
1234567890

12 Point Wayside

WHEN, in the course of human events, it becomes necessary for one people to dissolve the political bands which have connected them with another, and also to assume, among the powers of the earth, the separate and equal station to which the laws of nature and of nature's God entitle them, a decent

Lower case a to z, 12 1-3 ems

ABCDEFGHIJKLMNOPQRSTUVWXYZ
1234567890

12 Point Roman No. 599

WHEN, in the course of human events, it becomes necessary for one people to dissolve the political bands which have connected them with another, and to assume, among the powers of the earth, the separate and equal station to which the laws of nature and of nature's God entitle them, a decent respect to the opinions of mankind requires

Lower case a to z, 12 1-2 ems

ABCDEFGHIJKLMNOPQRSTUVWXYZ
1234567890

12 Point Bodoni Book

WHEN, in the course of human events, it becomes necessary for one people to dissolve the political bands which have connected them with another, and to assume, among the powers of the earth, the separate and equal station to which the laws of nature and of nature's God entitle them, a decent respect to the opinions of mankind requires

Lower case a to z, 11 ems

ABCDEFGHIJKLMNOPQRSTUVWXYZ
1234567890

12 Point Bodoni

WHEN, in the course of human events, it becomes necessary for one people to dissolve the political bands which have connected them with another, and to assume, among the powers of the earth, the separate and equal station to which the laws of nature and of nature's God entitle them, a decent respect to the opinions

Lower case a to z, 12 ems

ABCDEFGHIJKLMNOPQRSTUVWXYZ
1234567890

LINING MODERN ROMAN FACES SHOWN BY SIZES

12 Point Lining Roman No. 519

WHEN, in the course of human events, it becomes necessary for one people to dissolve the political bands which have connected them with another, and also to assume, among the powers of the earth, the separate and equal station to which *the laws of nature and of nature's God entitle them, a decent re-*

ABCDEFGHIJKLMN Lower case a to z, 11-12 ems OPQRSTUVWXYZ
1234567890

12 Point Roman No. 516

WHEN, in the course of human events, it becomes necessary for one people to dissolve the political bands which have connected them with another, and to assume, among the powers of the earth, the separate and equal station to which *the laws of nature and of nature's God entitle them, a decent re-*

ABCDEFGHIJKLMN Lower case a to z, 11-12 ems OPQRSTUVWXYZ
1234567890

12 Point Roman No. 510

WHEN, in the course of human events, it becomes necessary for one people to dissolve the political bands which have connected them with another, and to assume, among the powers of the earth, the separate and equal station to which *the laws of nature and of nature's God entitle them, a*

ABCDEFGHIJKLMN Lower case a to z, 11-12 ems OPQRSTUVWXYZ
1234567890

12 Point Scotch Roman

WHEN, in the course of human events, it becomes necessary for one people to dissolve the political bands which have connected them with another, and also to assume, among the powers of the earth, the separate and equal station to which *the laws of nature and nature's God entitle them, a decent re-*

ABCDEFGHIJKLMN Lower case a to z, 12 7-12 ems OPQRSTUVWXYZ
1234567890

12 Point Century Expanded

WHEN, in the course of human events, it becomes necessary for one people to dissolve the political bands which have connected them with another, and to assume, among the powers of the earth, the separate and equal station to which *the laws of nature and of nature's God entitle them, a*

ABCDEFGHIJKLMN Lower case a to z, 13 1-12 ems OPQRSTUVWXYZ
1234567890

14 Point Bodoni Book

WHEN, in the course of human events, it becomes necessary for one people to dissolve the political bands which have connected them with another, and to assume, among the powers of the earth, the separate and equal station to which the laws of nature and of nature's God entitle them, a decent respect to the opinions of mankind requires that they should

Lower case a to z, 10 1-2 ems

ABCDEFGHIJKLMNOPQRSTUVWXYZ
1234567890

14 Point Bodoni

WHEN, in the course of human events, it becomes necessary for one people to dissolve the political bands which have connected them with another, and to assume, among the powers of the earth, the separate and equal station to which the laws of nature and of nature's God entitle them, *a decent respect to the opinions of mankind requires that*

Lower case a to z, 11 1-2 ems

ABCDEFGHIJKLMNOPQRSTUVWXYZ
1234567890

14 Point Scotch Roman

When, in the course of human events, it becomes necessary for one people to dissolve the political bands which have connected them with another, and to assume, among the powers of the earth, the *separate and equal station to which the laws of na-*

Lower case a to z, 13 ems

ABCDEFGHIJKLMNOPQRSTUVWXYZ
1234567890

14 Point Century Expanded

When, in the course of human events, it becomes necessary for one people to dissolve the political bands which have connected them with another, and to assume, among the powers of the earth, *the separate and equal station to which the laws*

Lower case a to z, 13 9-14 ems

ABCDEFGHIJKLMNOPQRSTUVWXYZ
1234567890

18 Point Bodoni Book

WHEN, in the course of human events, it becomes necessary for one people to dissolve the political bands which have connected them with another, *and to assume, among the powers of the earth, the*

Lower case a to z, 19 1/4 ems
 ABCDEFGHIJKLMNOPQRSTUVWXYZ
 1234567890

18 Point Bodoni

WHEN, in the course of human events, it becomes necessary for one people to dissolve the political bands which have connected them *with another, and to assume, among the powers*

Lower case a to z, 11 1/2 ems
 ABCDEFGHIJKLMNOPQRSTUVWXYZ
 1234567890

18 Point Scotch Roman

When, in the course of human events, it becomes necessary for one people to dissolve the political bands which have connected them *with another, and to as-*

Lower case a to z, 13 ems
 ABCDEFGHIJKLMNOPQRSTUVWXYZ
 1234567890

18 Point Century Expanded

When, in the course of human events, it becomes necessary for one people to dissolve the political bands which have connected them *with another, and to assume,*

Lower case a to z, 14 4/9 ems
 ABCDEFGHIJKLMNOPQRSTUVWXYZ
 1234567890

Century Expanded

4 POINT CENTURY EXPANDED

WHEN, in the course of human events, it becomes necessary for one people to dissolve the political bands which have connected them with another, and to assume, among the powers of the earth, the separate and equal station to which the laws of nature and of nature's God entitle them, a decent respect to the opinions of mankind requires that they should declare the causes which impel them to the separation. We hold these truths to be self-evident: That all men are created equal; that they are endowed by their Creator with certain inalienable rights; that among these are life, liberty, and the pursuit of happiness; that to secure these rights, governments are instituted among men, deriving their just powers from the consent of the governed; that, whenever any form of government becomes destructive of these ends, it is the right of the people to alter or to abolish it and to institute a new government, laying its foundation on such principles, and organizing its powers in such form, as to them shall seem most likely to effect their safety and happiness. Prudence, indeed, will dictate that governments long established should not be changed for light and transient causes; and, accordingly, all experience hath shown that mankind are more disposed to suffer, while evils are sufferable, than to right themselves by abolishing the forms to which they are accustomed. But, when a long train of abuses and usurpations, pursuing invariably the same object, evinces a design to reduce them under absolute despotism, it is their right, it is their duty, to throw off such government and to provide new guards for their future security. Such has been the patient sufferance of these colonies, and such is now the necessity which constrains them to alter their former systems of government. The history of the present King of Great Britain is a history of repeated injuries and usurpations, all having, in direct object, the establishment of an absolute tyranny over these States. To prove this, let facts be submitted to a candid world. He has refused his assent to laws the most wholesome and necessary for the public good; he has forbidden his governors to pass laws of immediate and pressing importance, unless suspended in their operation till his assent should be obtained; and, when so suspended, he has utterly neglected to attend to them; he has refused to assent to laws for the accommodation of large districts of people, unless those people would relinquish the right of representation in the legislature, a right inestimable to them, and formidable to tyrants only; he has called together legislative bodies at places unusual, uncomfortable, and distant from the depository of their public records, for the sole purpose of fatiguing them into compliance with his measures; he has

Lower case a to z, 17 1-3 ems

ABCDEFGHIJKLMNOQRSTUVWXYZ
 abcdefghijklmnopqrstuvwxyz
 ABCDEFGHIJKLMNOQRSTUVWXYZ
 1234567890 1234567890

4½ POINT CENTURY EXPANDED

WHEN, in the course of human events, it becomes necessary for one people to dissolve the political bands which have connected them with another, and to assume, among the powers of the earth, the separate and equal station to which the laws of nature and of nature's God entitle them, a decent respect to the opinions of mankind requires that they should declare the causes which impel them to the separation. We hold these truths to be self-evident: That all men are created equal; that they are endowed by their Creator with certain inalienable rights; that among these are life, liberty, and the pursuit of happiness; that to secure these rights, governments are instituted among men, deriving their just powers from the consent of the governed; that, whenever any form of government becomes destructive of these ends, it is the right of the people to alter or to abolish it and to institute a new government, laying its foundation on such principles, and organizing its powers in such form, as to them shall seem most likely to effect their safety and happiness. Prudence, indeed, will dictate that governments long established should not be changed for light and transient causes; and, accordingly, all experience hath shown that mankind are more disposed to suffer, while evils are sufferable, than to right themselves by abolishing the forms to which they are accustomed. But, when a long train of abuses and usurpations, pursuing invariably the same object, evinces a design to reduce them under absolute despotism, it is their right, it is their duty, to throw off such government and to provide new guards for their future security. Such has been the patient sufferance of these colonies, and such is now the necessity which constrains them to alter their former systems of government. The history of the present King of Great Britain is a history of repeated injuries and usurpations, all having, in direct object, the establishment of an absolute tyranny over these States. To prove this, let facts be submitted to a candid world; He has refused his assent to laws the most wholesome and necessary for the public good; he has forbidden his governors to pass laws of immediate and pressing importance, unless suspended in their operation till his assent should be obtained; and, when so suspended, he has utterly neglected to attend to them; he has refused to pass other laws for the accommodation of large districts of people, unless those people would

Lower case a to z, 15 1-3 ems

ABCDEFGHIJKLMNOQRSTUVWXYZ
 abcdefghijklmnopqrstuvwxyz
 ABCDEFGHIJKLMNOQRSTUVWXYZ
 1234567890 1234567890

5 POINT CENTURY EXPANDED

WHEN, in the course of human events, it becomes necessary for one people to dissolve the political bands which have connected them with another, and to assume, among the powers of the earth, the separate and equal station to which the laws of nature and of nature's God entitle them, a decent respect to the opinions of mankind requires that they should declare the causes which impel them to the separation. We hold these truths to be self-evident: That all men are created equal; that they are endowed by their Creator with certain inalienable rights; that among these are life, liberty, and the pursuit of happiness; that to secure these rights, governments are instituted among men, deriving their just powers from the consent of the governed; that, whenever any form of government becomes destructive of these ends, it is the right of the people to alter or to abolish it and to institute a new government, laying its foundation on such principles, and organizing its powers in such form, as to them shall seem most likely to effect their safety and happiness. Prudence, indeed, will dictate that governments long established should not be changed for light and transient causes; and, accordingly, all experience hath shown that mankind are more disposed to suffer, while evils are sufferable, than to right themselves by abolishing the forms to which they are accustomed. But, when a long train of abuses and usurpations, pursuing invariably the same object, evinces a design to reduce them under absolute despotism, it is their right, it is their duty, to throw off such government and to provide new guards for their future safety. Such has been the patient sufferance of these colonies, and such is now the necessity which constrains them to alter their former systems of government. The history of the present King of Great Britain is a history of repeated injuries and usurpations, all having, in direct object,

Lower case a to z, 16 ems

ABCDEFGHIJKLMNOQRSTUVWXYZ
 abcdefghijklmnopqrstuvwxyz
 ABCDEFGHIJKLMNOQRSTUVWXYZ
 1234567890 1234567890

5½ POINT CENTURY EXPANDED

WHEN, in the course of human events, it becomes necessary for one people to dissolve the political bands which have connected them with another, and to assume, among the powers of the earth, the separate and equal station to which the laws of nature and of nature's God entitle them, a decent respect to the opinions of mankind requires that they should declare the causes which impel them to the separation. We hold these truths to be self-evident: That all men are created equal; that they are endowed by their Creator with certain inalienable rights; that among these are life, liberty, and the pursuit of happiness; that to secure these rights, governments are instituted among men, deriving their just powers from the consent of the governed; that, whenever any form of government becomes destructive of these ends, it is the right of the people to alter or to abolish it, and to institute a new government, laying its foundation on such principles, and organizing its powers in such form, as to them shall seem most likely to effect their safety and happiness. Prudence, indeed, will dictate that governments long established should not be changed for light and transient causes; and, accordingly, all experience hath shown that mankind are more disposed to suffer, while evils are sufferable, than to right themselves by abolishing the forms to which they are accustomed. But, when a long train of abuses and usurpations, pursuing invariably the same object, evinces a design to reduce them under absolute despotism, it is their right, it is their

Lower case a to z, 17 ems

ABCDEFGHIJKLMNOQRSTUVWXYZ
 abcdefghijklmnopqrstuvwxyz
 ABCDEFGHIJKLMNOQRSTUVWXYZ
 1234567890 1234567890

Century Expanded

6 POINT CENTURY EXPANDED

WHEN, in the course of human events, it becomes necessary for one people to dissolve the political bands which have connected them with another, and to assume, among the powers of the earth, the separate and equal station to which the laws of nature and of nature's God entitle them, a decent respect to the opinions of mankind requires that they should declare the causes which impel them to the separation. We hold these truths to be self-evident: That all men are created equal; that they are endowed by their Creator with certain inalienable rights, that among these are life, liberty, and the pursuit of happiness; that, to secure these rights, governments are instituted among men, deriving their just powers from the consent of the governed; that, whenever any form of government becomes destructive of these ends, it is the right of the people to alter or to abolish it and to institute a new government, laying its foundation on such principles, and organizing its powers in such form, as to them shall seem most likely to effect their safety and happiness. Prudence, indeed, will dictate that governments long established should not be changed for light and transient causes; and, accordingly, all experience hath shown that mankind are more disposed to suffer, while evils are sufferable, than to right themselves by abolishing the forms to which they are accustomed. But, when a long train of abuses and usurpations, pursuing invariably the same object, evinces a design to reduce them under absolute despotism, it is their right, it is their duty, to throw off such government and to provide new guards for their future security. Such has been the patient sufferance of these colonies, and such is now the necessity which constrains them to alter their former systems of government. The history of the present King of Great Britain is a history of repeated injuries and usurpations, all having, in direct object, the establishment of an absolute tyranny over these States. To prove this, let facts be submitted to a candid world: He has refused his assent to laws the most wholesome and necessary for the public good; he has forbidden his governors to pass laws of immediate and pressing importance, unless suspended in their operation till his assent should be obtained; and, when so suspended, he has utterly neglected to attend to them; he has refused to pass other laws for the accommodation of large districts of people, unless those people would relinquish the right of representation in the legislature; a right inestimable to them, and formidable to tyrants only; he has called together legislative bodies at places unusual, uncomfortable, and distant from the depository of their public records, for the sole purpose of fatiguing them into compliance with his measures; he has dissolved representative houses repeatedly, for opposing, with manly firmness, his *invasions on the rights of the people; he has refused, for a long time after such dissolutions, to cause others to be elected; whereby the legislative powers, incapable of annihilation, have returned to the*

Lower case a to z, 15 1-2 ems
 ABCDEFGHIJKLMNOPQRSTUVWXYZ
 abcdefghijklmnopqrstuvwxyz
 ABCDEFGHIJKLMNOPQRSTUVWXYZ
 1234567890 1234567890

7 POINT CENTURY EXPANDED

WHEN, in the course of human events, it becomes necessary for one people to dissolve the political bands which have connected them with another, and to assume, among the powers of the earth, the separate and equal station to which the laws of nature and of nature's God entitle them, a decent respect to the opinions of mankind requires that they should declare the causes which impel them to the separation. We hold these truths to be self-evident: That all men are created equal; that they are endowed by their Creator with certain inalienable rights; that among these are life, liberty, and the pursuit of happiness; that to secure these rights, governments are instituted among men, deriving their just powers from the consent of the governed; that, whenever any form of government becomes destructive of these ends, it is the right of the people to alter or to abolish it and to institute a new government, laying its foundation on such principles, and organizing its powers in such form, as to them shall seem most likely to effect their safety and happiness. Prudence, indeed, will dictate that governments long established should not be changed for light and transient causes; and, accordingly, all experience hath shown that mankind are more disposed to suffer, while evils are sufferable, than to right themselves by abolishing the forms to which they have been accustomed. But, when a long train of abuses and usurpations, pursuing invariably the same object, evinces a design to reduce them under absolute despotism, it is their right, it is their duty, to throw off such government and to provide new guards for their future security. Such has been the patient sufferance of these colonies, and such is now the necessity which constrains them to alter their former systems of government. The history of the present King of Great Britain is a history of repeated injuries and usurpations, all having, in direct object, the establishment of an absolute tyranny over these States. To prove this, let facts be submitted to a candid world: He has refused his assent to laws the most wholesome and necessary for the public good; he has forbidden his governors to pass laws of immediate and pressing importance, unless suspended in their operation till his assent should be obtained; and, when so suspended, he has utterly neglected to attend to them; he has refused to pass other laws for the accommodation

Lower case a to z, 14 2-7 ems
 ABCDEFGHIJKLMNOPQRSTUVWXYZ
 abcdefghijklmnopqrstuvwxyz
 ABCDEFGHIJKLMNOPQRSTUVWXYZ
 1234567890 1234567890

Century Expanded

8 POINT CENTURY EXPANDED

WHEN, in the course of human events, it becomes necessary for one people to dissolve the political bands which have connected them with another, and to assume, among the powers of the earth, the separate and equal station to which the laws of nature and of nature's God entitle them, a decent respect to the opinions of mankind requires that they should declare the causes which impel them to the separation. We hold these truths to be self-evident: That all men are created equal; that they are endowed by their Creator with certain inalienable rights; that among these are life, liberty, and the pursuit of happiness; that to secure these rights, governments are instituted among men, deriving their just powers from the consent of the governed; that, whenever any form of government becomes destructive of these ends, it is the right of the people to alter or to abolish it and to institute a new government, laying its foundation on such principles, and organizing its powers in such form, as to them shall seem most likely to effect their safety and happiness. Prudence, indeed, will dictate that governments long established should not be changed for light and transient causes; and, accordingly, all experience hath shown that mankind are more disposed to suffer, while evils are sufferable, than to right themselves by abolishing the forms to which they are accustomed. But, when a long train of abuses and usurpations, pursuing invariably the same object, evinces a design to reduce them under absolute despotism, it is their right, it is their duty, to throw off such government and to provide new guards for their future security. Such has been the patient sufferance of these colonies, and such is now the necessity *which constrains them to alter their former systems of government. The history of the present King of Great Britain is a history of repeated injuries and usur-*

Lower case a to z, 14 3-8 ems

ABCDEFGHIJKLMN OPQRSTUVWXYZ
abcdefghijklmnopqrstu vwxyz
ABCDEFGHIJKLMN OPQRSTUVWXYZ
1234567890 1234567890

Partly opened with two point leads

For complete showing of this series see pages 254, 255 and 256

SECTION 2

The Tim

Vol. XXI.

Copyright, 1912, by
The Times-Herald Publishing Co.

INDIANAP

OPTIMISM KEYNOTE OF THE REALTY BOARD RICHMAN AND SO PREDICTIONS FOR A BRIGHT FUTURE FEATURE OF EAST GALESBURG ASSOCIATION'S FIRST BANQUET

ARRESTED TRYING K DOORS AT NIGHT IT AN OUTRAG

Bright predictions for a successful future featured the first dinner of the East Galesburg Board of Brokers, which includes the real estate operators of the city, at French's, East Galesburg, on Saturday night. Terence L. Upton, county tax commissioner, was toastmaster, and boxes with a "lots for sale" sign were souvenirs. Judge Edward E. Socem and several other prominent men joined the East Galesburg officials in felicitations to the real estate men. About 200 men and women enjoyed the function.

Mr. Upton announced that Assemblyman John B. Green, of East Galesburg, had introduced a bill that, if enacted into law, will provide legal authority for collecting real estate agents' commissions. The measure was drawn by Jeremiah I. Gaffney, attorney for the board, and its passage will be urged by the brokers. Mr. Upton also stated that the board will be incorporated at a meeting on Thursday night and an effort will be made to collect a fund for exploiting in systematic fashion the manifold advantages of

Rudolph Cognac, m
turer of store fixture
Delancey Street, who
bail for a hearing on
attempted burglary b
the Manhattan Avenu
terday. He and his fr
William, were arrest
the doorway of a clos
Shrunk, at No. 257 So
Policeman Goeasy of

Despite the protest
his boy were charged
burglary. The lad w
dren's Society; the fr

Panel Border Engravers Old English Bold Heading Condensed

9 POINT CENTURY EXPANDED

WHEN, in the course of human events, it becomes necessary for one people to dissolve the political bands which have connected them with another, and to assume, among the powers of the earth, the separate and equal station to which the laws of nature and of nature's God entitle them, a decent respect to the opinions of mankind requires that they should declare the causes which impel them to the separation. We hold these truths to be self-evident: That all men are created equal; that they are endowed by their Creator with certain inalienable rights; that among these are life, liberty, and the pursuit of happiness; that, to secure these rights, governments are instituted among men, deriving their just powers from the consent of the governed; that, whenever any form of government becomes destructive of these ends, it is the right of the people to alter or to abolish it and to institute a new government, laying its foundation on such principles, and organizing its powers in such form, as to them shall seem most likely to effect their safety and happiness. Prudence, indeed, will dictate that governments long established should not be changed for light and transient causes; and, accordingly, all experience hath shown that mankind are more disposed to suffer, while evils are sufferable, than to right themselves by abolishing the forms to which they are accustomed. But, when a long train of abuses and usurpations, pursuing invariably the same object, evinces a design to reduce them under absolute despotism,

Lower case a to z, 11 ems

ABCDEFGHIJKLMN OPQRSTUVWXYZ
 abcdefghijklmn opqrstuvwxyz
 ABCDEFGHIJKLMN OPQRSTUVWXYZ
 1234567890 1234567890

For complete showing of this series see pages 254, 255 and 256

Part I, specimen 11 (10 point)

SECTION 4

THE CHRON

Vol. XIX.

Copyright, 1912, by
The Chronicle Publishing Co.

AKRON

REBSAN CALLS PARTY TO AID THE INSURGENTS SOCIETY OFF TO G

GLINWOLD LOOMS AS DEMOCRATIC CHOICE—P. O. G. INSURGENT PLAN FAVORS GRIGSON

REPUBLICANS READY TO JOIN TO ELECT A CONSERVATIVE DEMOCRATIC MEMBER

ALBANY, March 31.—Although Murray legislative leaders stoutly maintain to-night that they will force the selection of a United States Senator to-morrow, political experts at a late hour say: "All combinations are shattered. There can be no election unless Murray accepts one of the men demanded by the insurgents. And he

Exasperated by George F. Hoppe's drubbing of Judge Thomas I. Cahill, whom Murray sought to put through the machine caucus to-day, Senators Norman and Stroub, and Democratic Floor Leader Schill of the Assembly, are awaiting telephone orders from their chief as to whom next to give a trial heat.

Glinwold looms up as the probable solution of the Senatorial tangle.

Samuel Smather's name was tried on the McMullen insurgents late to-night by the Murray directors. It was added to the list of ten being talked over by the Murray leaders and the McMullen insurgents.

The insurgents will have it in their power to-morrow to break the dead-

GREAT CROWD SAILS ON ST WASHINGTON HUNDR TO GET ABOARD GI

Society commence eastward rush yesteing every stateroom that could be conver use of passengers on steamer, George W

The exodus this ythan usual, due to a bookings on ocean s of Americans whom the Coronation. Thi list of the George W was printed on pink and the names it co registers of every k those to be found w

Century Expanded

10 POINT CENTURY EXPANDED No. 2

WHEN, in the course of human events, it becomes necessary for one people to dissolve the political bands which have connected them with another, and to assume, among the powers of the earth, the separate and equal station to which the laws of nature and of nature's God entitle them, a decent respect to the opinions of mankind requires that they should declare the causes which impel them to the separation. We hold these truths to be self-evident: That all men are created equal; that they are endowed by their Creator with certain inalienable rights; that among these are life, liberty, and the pursuit of happiness; that, to secure these rights, governments are instituted among men, deriving their just powers from the consent of the governed; that, whenever any form of government becomes destructive of these ends, it is the right of the people to alter or to abolish it and to institute a new government, laying its foundation on such principles, and organizing its powers in such form, as to them shall seem most likely to effect their safety and happiness. Prudence, indeed, will dictate that governments long established should not be changed for light and transient causes; and, accordingly, all experience hath shown that mankind *are more disposed to suffer, while evils are sufferable, than to right themselves by abolishing the forms to which they are accustomed. But, when*

Lower case a to z, 12 3-5 ems

ABCDEFGHIJKLMN OPQRSTUVWXYZ
abcdefghijklmnopqrstu vxyz
ABCDEFGHIJKLMN OPQRSTUVWXYZ
1234567890 1234567890

Partly opened with one point leads.

10 POINT CENTURY EXPANDED

WHEN, in the course of human events, it becomes necessary for one people to dissolve the political bands which have connected them with another, and to assume, among the powers of the earth, the separate and equal station to which the laws of nature and of nature's God entitle them, a decent respect to the opinions of mankind requires that they should declare the causes which impel them to the separation. We hold these truths to be self-evident: That all men are created equal; that they are endowed by their Creator with certain inalienable rights; that among these are life, liberty, and the pursuit of happiness; that, to secure these rights, governments are instituted among men, deriving their just powers from the consent of the governed; that, when any form of government becomes destructive of these ends, it is the right of the people to alter or to abolish it and to institute a new government, laying its foundation on such principles, and organizing its powers in such *form, as to them shall seem the most likely to effect their safety and happiness. Prudence, indeed, will dictate that governments long es-*

Lower case a to z, 14 ems

ABCDEFGHIJKLMN OPQRSTUVWXYZ
abcdefghijklmnopqrstu vxyz
ABCDEFGHIJKLMN OPQRSTUVWXYZ
1234567890 1234567890

Partly opened with two point leads

For complete showing of this series see pages 254, 255 and 256

Century Expanded

11 POINT CENTURY EXPANDED No. 1

WHEN, in the course of human events, it becomes necessary for one people to dissolve the political bands which have connected them with another, and to assume, among the powers of the earth, the separate and equal station to which the laws of nature and of nature's God entitle them, a decent respect to the opinions of mankind requires that they should declare the causes which impel them to the separation. We hold these truths to be self-evident: That all men are created equal; that they are endowed by their Creator with certain inalienable rights; that among these are life, liberty, and the pursuit of happiness; that, to secure these rights, governments are instituted among men, deriving their just powers from the consent of the governed; that, when any form of government becomes destructive of these ends, it is the right of the people to alter or to abolish it and to institute a new government, laying its foundation on such principles, and organizing its powers in *such form, as to them shall seem most likely to effect their safety and happiness. Prudence, indeed, will dictate that governments long*

Lower case a to z, 12 s, 11 ems

ABCDEFGHIJKLMN OPQRSTUVWXYZ
abcdefghijklm nopqrstuvwxyz
ABCDEFGHIJKLMN OPQRSTUVWXYZ
1234567890 1234567890

Partly opened with one-point leads

11 POINT CENTURY EXPANDED

WHEN, in the course of human events, it becomes necessary for one people to dissolve the political bands which have connected them with another, and to assume, among the powers of the earth, the separate and equal station to which the laws of nature and of nature's God entitle them, a decent respect to the opinions of mankind requires that they should declare the causes which impel them to the separation. We hold these truths to be self-evident: That all men are created equal; that they are endowed by their Creator with certain inalienable rights; that among these are life, liberty, and the pursuit of happiness; that, to secure these rights, governments are instituted among men, deriving their just powers from the consent of the governed; that, whenever any form of government becomes destructive of these ends, it is the right of the people to alter or to abolish it and to institute a new government, laying its foundation on such principles, and organizing its powers in such form, as to them shall seem

Lower case a to z, 13 2/3 11 ems

ABCDEFGHIJKLMN OPQRSTUVWXYZ
abcdefghijklm nopqrstuvwxyz
ABCDEFGHIJKLMN OPQRSTUVWXYZ
1234567890 1234567890

For complete showing of this series see pages 254, 255 and 256

Partly opened with two-point leads

Century Expanded

12 POINT CENTURY EXPANDED

WHEN, in the course of human events, it becomes necessary for one people to dissolve the political bands which have connected them with another, and to assume, among the powers of the earth, the separate and equal station to which the laws of nature and of nature's God entitle them, a decent respect to the opinions of mankind requires that they should declare the causes which impel them to the separation. We hold these truths to be self-evident: That all men are created equal; that they are endowed by their Creator with certain inalienable rights; that among these are life, liberty, and the pursuit of happiness; that, to secure these rights, governments are instituted among men, deriving their just powers from the consent of the governed; that whenever any form of govern

Lower case a to z, 13 1-3 ems

ABCDEFGHIJKLMNOPQRSTUVWXYZ

abcdefghijklmnopqrstuvwxyz

ABCDEFGHIJKLMNOPQRSTUVWXYZ

1234567890 1234567890

14 POINT CENTURY EXPANDED

When, in the course of human events, it becomes necessary for one people to dissolve the political bands which have connected them with another, and to assume, among the powers of the earth, the separate and equal station to which the laws of nature and of nature's God entitle them, a decent respect to the opinions of mankind requires that they should declare the causes which impel them to the separation. We hold these truths to be self-evident: That all men are created equal; that they are endowed by their Creator with certain inalienable rights; that among these are life, liberty, and the pursuit of

Lower case a to z, 13 9-14 ems

ABCDEFGHIJKLMNOPQRSTUVWXYZ

abcdefghijklmnopqrstuvwxyz

1234567890 1234567890

IS POINT CENTURY EXPANDED

When, in the course of human events, it becomes necessary for one people to dissolve the political bands which have connected them with another, and to assume, among the powers of the earth, the separate and equal station to which the laws of nature and of nature's God entitle them, a decent respect to the opinions of mankind requires that they should declare the causes which impel them to the separation. We hold these truths to be self-evident: That all men are created equal; that they are endowed by their Creator with certain inalienable rights; that among these are life, liberty, and the pursuit of happiness; that, to secure these rights, governments are instituted among men deriving their just powers from the consent of the governed; that, whenever any form of government becomes destructive of these ends, it is the right of the people to alter or to abolish it *and to institute a new government, laying its foundation on such principles*

Lower case a to z, 13 4-9 ems

ABCDEFGHIJKLMNOPQRSTUVWXYZ

abcdefghijklmnopqrstuvwxyz

1234567890

1234567890

Bodoni

6 POINT BODONI

WHEN, in the course of human events, it becomes necessary for one people to dissolve the political bands which have connected them with another, and to assume, among the powers of the earth, the separate and equal station to which the laws of nature and of nature's God entitle them, a decent respect to the opinions of mankind requires that they should declare the causes which impel them to the separation. We hold these truths to be self-evident: That all men are created equal; that they are endowed by their Creator with certain inalienable rights; that among these are life, liberty, and the pursuit of happiness; that, to secure these rights, governments are instituted among men, deriving their just powers from the consent of the governed; that, whenever any form of government becomes destructive of these ends, it is the right of the people to alter or to abolish it and to institute a new government, laying its foundations on such principles, and organizing its powers in such form, as to them shall seem most likely to effect their safety and happiness. Prudence, indeed, will dictate that governments long established should not be changed for light and transient causes; and, accordingly, all experience hath shown that mankind are more disposed to suffer, while evils are sufferable, than to right themselves by abolishing the forms to which they are accustomed. But, when a long train of abuses and usurpations, pursuing invariably the same object, evinces a design to reduce them under absolute despotism, it is their right, it is their duty, to throw off such government and to provide new guards for their future security. Such has been the patient sufferance of these colonies, and such is now the necessity which constrains them to alter their former systems of government. The history of the present King of Great Britain is a history of repeated injuries and usurpations, all having, in direct object, the establishment of an absolute tyranny over these States. To prove this, let facts be submitted to a candid world: He has refused his assent to laws the most wholesome and necessary for the public good; he has forbidden his governors to pass laws of immediate and pressing importance, unless suspended in their operation till his assent should be obtained; and, when so suspended, he has utterly neglected to attend to them; he has refused to pass other laws for the accommodation of large districts of people, unless those people would relinquish the right of representation, in the legislature; a right inestimable to them, and formidable to tyrants only; he has called together legislative bodies at places unusual, uncomfortable, and far distant from the depository of their public records, for the sole purpose of fatiguing them into compliance with his measures; he has dissolved representative houses repeatedly, for opposing, with manly firmness, his invasions on the rights of the people; he has refused, for a long time after such dissolutions, to cause others to be elected; whereby the legislative powers, incapable of annihilation, have returned to the people at large for their exercise; the state remaining, in the meantime, exposed to all the danger of invasion from without, and convulsions within; he has endeavored to prevent the population of these States; for that purpose, obstructing the laws for naturalization of foreigners, *refusing to pass others to encourage their migration hither, and raising the conditions of new appropriations of lands; he has obstructed the administration of justice, by refusing his assent to laws for establishing judiciary*

Lower case a to z, 13 1-6 ems

ABCDEFGHIJKLMNPOQRSTUVWXYZ

abcdefghijklmnopqrstuvwxyz

ABCDEFGHIJKLMNPOQRSTUVWXYZ

1234567890 1234567890 1234567890

8 POINT BODONI

WHEN, in the course of human events, it becomes necessary for one people to dissolve the political bands which have connected them with another, and to assume, among the powers of the earth, the separate and equal station to which the laws of nature and of nature's God entitle them, a decent respect to the opinions of mankind requires that they should declare the causes which impel them to the separation. We hold these truths to be self-evident: That all men are created equal; that they are endowed by their Creator with certain inalienable rights; that among these are life, liberty, and the pursuit of happiness; that, to secure these rights, governments are instituted among men, deriving their just powers from the consent of the governed; that, whenever any form of government becomes destructive of these ends, it is the right of the people to alter or to abolish it and to institute a new government, laying its foundations on such principles, and organizing its powers in such form, as to them shall seem most likely to effect their safety and happiness. Prudence, indeed, will dictate that governments long established should not be changed for light and transient causes; and, accordingly, all experience hath shown that mankind are more disposed to suffer, while evils are sufferable, than to right themselves by abolishing the forms to which they are accustomed. But, when a long train of abuses and usurpations, pursuing invariably the same object, evinces a design to reduce them under absolute despotism, it is their right, it is their duty, to throw off such government and to provide new guards for their future security. Such has been the patient *sufferance of these colonies, and such is now the necessity which constrains them to alter their former systems of government. The history of the present King of Great*

Lower case a to z, 13 3-8 ems

ABCDEFGHIJKLMNPOQRSTUVWXYZ

abcdefghijklmnopqrstuvwxyz

ABCDEFGHIJKLMNPOQRSTUVWXYZ

1234567890 1234567890 1234567890

Oldstyle Figures are fonted separately and sold at 50 cents per font

Bodoni

10 POINT BODONI

WHEN, in the course of human events, it becomes necessary for one people to dissolve the political bands which have connected them with another, and to assume, among the powers of the earth, the separate and equal station to which the laws of nature and of nature's God entitle them, a decent respect to the opinions of mankind requires that they should declare the causes which impel them to the separation. We hold these truths to be self-evident: That all men are created equal; that they are endowed by their Creator with certain inalienable rights; that among these are life, liberty, and the pursuit of happiness; that, to secure these rights, governments are instituted among men, deriving their just powers from the consent of the governed; that, whenever any form of government becomes destructive of these ends, it is the right of the people to alter or to abolish it and to institute a new government, laying its foundation on such principles, and organizing its powers in such form, as to them shall seem most likely to effect their safety and happiness. Prudence, indeed, will dictate that governments long established should not be changed for light and transient causes: and, accordingly, all experience hath shown that mankind are

Lower case a to z, 13 ems

ABCDEFGHIJKLMN^{OP}QRSTU^VWXYZ
abcdefghijklmnopqrstu^vwxyz
ABCDEFGHIJKLMN^{OP}QRSTU^VWXYZ
1234567890 1234567890 1234567890

12 POINT BODONI

WHEN, in the course of human events, it becomes necessary for one people to dissolve the political bands which have connected them with another, and to assume, among the powers of the earth, the separate and equal station to which the laws of nature and of nature's God entitle them, a decent respect to the opinions of mankind requires that they should declare the causes which impel them to the separation. We hold these truths to be self-evident: That all men are created equal; that they are endowed by their Creator with certain inalienable rights; that among these are life, liberty, and the pursuit of happiness; that to secure these rights, governments are instituted among men, deriving their just powers from the consent of the governed; that, whenever any form of government becomes destructive of these ends, it is the right of the people to alter or to abolish it and to institute a new government, laying its

Lower case a to z, 12 ems

ABCDEFGHIJKLMN^{OP}QRSTU^VWXYZ
abcdefghijklmnopqrstu^vwxyz
ABCDEFGHIJKLMN^{OP}QRSTU^VWXYZ
1234567890 1234567890 1234567890

Oldstyle Figures are fonted separately and sold at 50 cents per font

14 POINT BODONI

WHEN, in the course of human events, it becomes necessary for one people to dissolve the political bands which have connected them with another, and to assume, among the powers of the earth, the separate and equal station to which the laws of nature and of nature's God entitle them, a decent respect to the opinions of mankind requires that they should declare the causes which impel them to the separation. We hold these truths to be self-evident: That all men are created equal; that they are endowed by their Creator with certain inalienable rights; that among these are life, liberty, and the pursuit of happiness; that, to secure these rights, governments are instituted among men, deriving their just powers from the consent of the governed; that, whenever any form of government becomes destructive of these ends, it is the right of the people to alter or to abolish it and to institute a new government, laying its foundation on such principles, and organizing its powers in such form, as to them shall seem most likely to effect their safety and happiness. Prudence, indeed, will dictate that governments long established should not be changed for light and transient causes; and, accordingly, all experience hath shown that mankind are more disposed to suffer, while evils are sufferable, than to right themselves by abolishing the forms to which they are accustomed. But, when a long train of abuses and usurpations, pursuing invariably the same object, evinces a design to reduce them under absolute despotism, it is their right, it is their duty, to throw off such government and to provide new guards for their future security. Such has been the patient sufferance of these colonies, and such *is now the necessity which constrains them to alter their former systems of government. The history of the present*

Lower case a to z, 11 1-2 ems

ABCDEFGHIJKLMN OPQRSTUVWXYZ

abcdefghijklmnopqrstuvwxy z

ABCDEFGHIJKLMN OPQRSTUVWXYZ

1234567890 1234567890 1234567890

Oldstyle Figures are fonted separately and sold at 50 cents per font

18 POINT BODONI

WHEN, in the course of human events, it becomes necessary for one people to dissolve the political bands which have connected them with another, and to assume, among the powers of the earth, the separate and equal station to which the laws of nature and of nature's God entitle them, a decent respect to the opinions of mankind requires that they should declare the causes which impel them to the separation. We hold these truths to be self-evident: That all men are created equal; that they are endowed by their Creator with certain inalienable rights; that among these are life, liberty, and the pursuit of happiness; that, to secure these rights, governments are instituted among men, deriving their just powers from the consent of the governed; that, whenever any form of government becomes destructive of these ends, it is the right of the people to alter or to abolish it and to institute a new government, laying its foundation on such principles, and organizing its powers in such form, *as to them shall seem most likely to effect their safety and happiness. Prudence, indeed, will*

Lower case n to z, 11 1/2 ems

ABCDEFGHIJKLMNOPQRSTUVWXYZ

abcdefghijklmnopqrstuvwxyz

ABCDEFGHIJKLMNOPQRSTUVWXYZ

1234567890 1234567890 1234567890

Oldstyle Figures are fonted separately and sold at 50 cents per font

Bodoni Book

6 POINT BODONI BOOK

WHEN, in the course of human events, it becomes necessary for one people to dissolve the political bands which have connected them with another, and to assume, among the powers of the earth, the separate and equal station to which the laws of nature and of nature's God entitle them, a decent respect to the opinions of mankind requires that they should declare the causes which impel them to the separation. We hold these truths to be self-evident: That all men are created equal; that they are endowed by their Creator with certain inalienable rights; that among these are life, liberty, and the pursuit of happiness; that, to secure these rights, governments are instituted among men, deriving their just powers from the consent of the governed; that, whenever any form of government becomes destructive of these ends, it is the right of the people to alter or to abolish it and to institute a new government, laying its foundation on such principles, and organizing its powers in such form, as to them shall seem most likely to effect their safety and happiness. Prudence, indeed, will dictate that governments long established should not be changed for light and transient causes; and, accordingly, all experience hath shown that mankind are more disposed to suffer, while evils are sufferable, than to right themselves by abolishing the forms to which they are accustomed. But, when a long train of abuses and usurpations, pursuing invariably the same object, evinces a design to reduce them under absolute despotism, it is their right, it is their duty, to throw off such government and to provide new guards for their future security. Such has been the patient sufferance of these colonies, and such is now the necessity which constrains them to alter their former systems of government. The history of the present King of Great Britain is a history of repeated injuries and usurpations, all having, in direct object, the establishment of an absolute tyranny over these States. To prove this, let facts be submitted to a candid world: He has refused his assent to laws the most wholesome and necessary for the public good; he has forbidden his governors to pass laws of immediate and pressing importance, unless suspended in their operation till his assent should be obtained; and, when so suspended, he has utterly neglected to attend to them; he has refused to pass other laws for the accommodation of large districts of people, unless those people would relinquish the right of representation in the legislature; a right inestimable to them, and formidable to tyrants only; he has called together legislative bodies at places unusual, uncomfortable, and distant from the depository of their public records, for the sole purpose of fatiguing them into compliance with his measures; he has dissolved representative houses repeatedly, for opposing, with manly firmness, his invasions on the rights of the people; he has refused, for a long time after such dissolutions, to cause others to be elected, whereby the legislative powers, incapable of annihilation, have returned to the people at large for their exercise: the state remaining, in the meantime, exposed to all the danger of invasion from without, and convulsions within; he has endeavored to prevent the population of these States, for that purpose obstructing the laws for naturalization of foreigners, refusing to pass others to encourage their migration hither, and raising the conditions of new appropriations of lands. He has obstructed the administration of justice, by refusing his assent to laws for establishing judiciary powers. He has made judges dependent on his will alone, for the tenure of their offices, and the amount and payment of their salaries. He has erected a multitude of new

Lower case a to z, 13 1-6 ems

ABCDEFGHIJKLMNOPQRSTUVWXYZ

abcdefghijklmnopqrstuvwxyz

ABCDEFGHIJKLMNOPQRSTUVWXYZ

1234567890 1234567890

8 POINT BODONI BOOK

WHEN, in the course of human events, it becomes necessary for one people to dissolve the political bands which have connected them with another, and to assume, among the powers of the earth, the separate and equal station to which the laws of nature and of nature's God entitle them, a decent respect to the opinions of mankind requires that they should declare the causes which impel them to the separation. We hold these truths to be self-evident: That all men are created equal; that they are endowed by their Creator with certain inalienable rights; that among these are life, liberty, and the pursuit of happiness; that, to secure these rights, governments are instituted among men, deriving their just powers from the consent of the governed; that, whenever any form of government becomes destructive of these ends, it is the right of the people to alter or to abolish it and to institute a new government, laying its foundation on such principles, and organizing its powers in such form, as to them shall seem most likely to effect their safety and happiness. Prudence, indeed, will dictate that governments long established should not be changed for light and transient causes; and, accordingly, all experience hath shown that mankind are more disposed to suffer, while evils are sufferable, than to right themselves by abolishing the forms to which they are accustomed. But, when a long train of abuses and usurpations, pursuing invariably the same object, evinces a design to reduce them under absolute despotism, it is their right, it is their duty, to throw off such government and to provide new guards for their future security. Such has been the patient sufferance of these colonies, and such is now the necessity which constrains them to alter their former systems of government. The history of the present King of Great Britain is a history of repeated injuries and usurpations, all having, in direct object, the establishment of an absolute tyranny over these States. To prove this, let facts be submitted to a

Lower case a to z, 12 9-16 ems

ABCDEFGHIJKLMNOPQRSTUVWXYZ

abcdefghijklmnopqrstuvwxyz

ABCDEFGHIJKLMNOPQRSTUVWXYZ

1234567890 1234567890

10 POINT BODONI BOOK

WHEN, in the course of human events, it becomes necessary for one people to dissolve the political bands which have connected them with another, and to assume, among the powers of the earth, the separate and equal station to which the laws of nature and of nature's God entitle them, a decent respect to the opinions of mankind requires that they should declare the causes which impel them to the separation. We hold these truths to be self-evident: That all men are created equal; that they are endowed by their Creator with certain inalienable rights; that among these are life, liberty, and the pursuit of happiness; that, to secure these rights, governments are instituted among men, deriving their just powers from the consent of the governed; that, when any form of government becomes destructive of these ends, it is the right of the people to alter or to abolish it and to institute a new government, laying its foundation on such principles, and organizing its powers in such form, as to them shall seem most likely to effect their safety and happiness. Prudence, indeed, will dictate that governments long established should not be changed for light and transient causes; and, accordingly, all experience hath shown that mankind are more disposed to suffer, while evils are sufferable, than to right themselves by abolishing the forms to which *they are accustomed*. But, when a long train of abuses and usurpations, pursuing invariably the same object, evinces a design to reduce them under ab-

Lower case a to z, 11 17-20 ems

ABCDEFGHIJKLMN^{OP}QRSTU^VWXYZ
 abcdefghijklmnop^{qrstuv}wxyz
 ABCDEFGHIJKLMN^{OP}QRSTU^VWXYZ
 1234567890 1234567890

12 POINT BODONI BOOK

WHEN, in the course of human events, it becomes necessary for one people to dissolve the political bands which have connected them with another, and to assume, among the powers of the earth, the separate and equal station to which the laws of nature and of nature's God entitle them, a decent respect to the opinions of mankind requires that they should declare the causes which impel them to the separation. We hold these truths to be self-evident: That all men are created equal; that they are endowed by their Creator with certain inalienable rights; that among these are life, liberty, and the pursuit of happiness; that, to secure these rights, governments are instituted among men, deriving their just powers from the consent of the governed; that, whenever any form of government becomes *destructive of these ends, it is the right of the people to alter or to abolish it and to institute a new government, laying its foundation*

Lower case a to z, 11 ems

ABCDEFGHIJKLMN^{OP}QRSTU^VWXYZ
 abcdefghijklmnop^{qrstuv}wxyz
 ABCDEFGHIJKLMN^{OP}QRSTU^VWXYZ
 1234567890 1234567890

14 POINT BODONI BOOK

WHEN, in the course of human events, it becomes necessary for one people to dissolve the political bands which have connected them with another, and to assume, among the powers of the earth, the separate and equal station to which the laws of nature and of nature's God entitle them, a decent respect to the opinions of mankind requires that they should declare the causes which impel them to the separation. We hold these truths to be self-evident: That all men are created equal; that they are endowed by their Creator with certain inalienable rights: that among these are life, liberty, and the pursuit of happiness: that to secure these rights, governments are instituted among men, deriving their just powers from the consent of the governed; that, whenever any form of government becomes destructive of these ends, it is the right of the people to alter or to abolish it and to institute a new government, laying its foundation on such principles, and organizing its powers in such form, as to them shall seem most likely to effect their safety and happiness. Prudence, indeed, will dictate that governments long established should not be changed for light and transient causes: and, accordingly, all experience hath shown that mankind are more disposed to suffer, while evils are sufferable, than to right themselves by abolishing the forms to which they are accustomed. But, when a long train of abuses and usurpations, pursuing invariably the same object, evinces a design to reduce them under absolute despotism, it is their right, it is their duty, to throw off such government and to provide new guards for their future security. Such has been the patient sufferance of these colonies, and such is now the necessity which constrains them to alter their former systems of government. The history of the present King of Great Britain is a history of repeated injuries and usurpations, all having, in direct object, the establishment of an absolute tyranny over these

Lower case a to z, 10 1-2 ems

ABCDEFGHIJKLMN OPQRSTUVWXYZ

abcdefghijklmno pqrstuvwxyz

ABCDEFGHIJKLMN OPQRSTUVWXYZ

1234567890

14 Point Bodoni Book Italic in preparation

18 POINT BODONI BOOK

WHEN, in the course of human events, it becomes necessary for one people to dissolve the political bands which have connected them with another, and to assume, among the powers of the earth, the separate and equal station to which the laws of nature and of nature's God entitle them, a decent respect to the opinions of mankind requires that they should declare the causes which impel them to the separation. We hold these truths to be self-evident: That all men are created equal; that they are endowed by their Creator with certain inalienable rights; that among these are life, liberty, and the pursuit of happiness; that, to secure these rights, governments are instituted among men, deriving their just powers from the consent of the governed; that whenever any form of government becomes destructive of these ends, it is the right of the people to alter or to abolish it and to institute a new government, laying its foundation on such principles, and organizing its powers in such form, as to them shall seem most likely to effect their safety and happiness. Prudence, indeed, will *dictate that governments long established should not be changed for light and transient causes;*

Lower case a to z, 10 1-3 ems

ABCDEFGHIJKLMNOPQRSTUVWXYZ

abcdefghijklmnopqrstuvwxy

ABCDEFGHIJKLMNOPQRSTUVWXYZ

1234567890 1234567890

Scotch Roman

6 POINT SCOTCH ROMAN

WHEN, in the course of human events, it becomes necessary for one people to dissolve the political bands which have connected them with another, and to assume, among the powers of the earth, the separate and equal station to which the laws of nature and of nature's God entitle them, a decent respect to the opinions of mankind requires that they should declare the causes which impel them to the separation. We hold these truths to be self-evident: That all men are created equal; that they are endowed by their Creator with certain inalienable rights; that among these are life, liberty and the pursuit of happiness; that, to secure these rights, governments are instituted among men, deriving their just powers from the consent of the governed; that, whenever any form of government becomes destructive of these ends, it is the right of the people to alter or to abolish it and to institute a new government, laying its foundation on such principles, and organizing its powers in such form, as to them shall seem most likely to effect their safety and happiness. Prudence, indeed, will dictate that governments long established should not be changed for light and transient causes; and, accordingly, all experience hath shown that mankind are more disposed to suffer, while evils are sufferable, than to right themselves by abolishing the forms to which they are accustomed. But, when a long train of abuses and usurpations, pursuing invariably the same object, evinces a design to reduce them under absolute despotism, it is their right, it is their duty, to throw off such government and to provide new guards for their future security. Such has been the patient sufferance of these colonies, and such is now the necessity which constrains them to alter their former systems of government. The history of the present King of Great Britain is a history of repeated injuries and usurpations, all having, in direct object, the establishment of an absolute tyranny over these States. To prove this, let facts be submitted to a candid world: He has refused his assent to laws the most wholesome and necessary for the public good; he has forbidden his governors to pass laws of immediate and pressing importance, unless suspended in their operation till his assent should be obtained; and, when so suspended, he has utterly neglected to attend to them; he has refused to pass other laws for the accommodation of large districts of people, unless those people would relinquish the right of representation in the legislature; a right inestimable to them, and formidable to tyrants only; he has called together legislative bodies at places unusual, uncomfortable, and distant from the depository of their public records, for the sole purpose of fatiguing them into compliance with his measures; he has dissolved representative houses repeatedly, for opposing, with manly firmness, his invasions on

Lower case a to z, 15 2-3 ems

ABCDEFGHIJKLMN OPQRSTU VWXYZ
 abcdefghijklmno pqrstuvwxyz
 ABCDEFGHIJKLMN OPQRSTU VWXYZ
 1234567890 1234567890

8 POINT SCOTCH ROMAN

WHEN, in the course of human events, it becomes necessary for one people to dissolve the political bands which have connected them with another, and to assume, among the powers of the earth, the separate and equal station to which the laws of nature and of nature's God entitle them, a decent respect to the opinions of mankind requires that they should declare the causes which impel them to the separation. We hold these truths to be self-evident: That all men are created equal; that they are endowed by their Creator with certain inalienable rights; that among these are life, liberty, and the pursuit of happiness; that to secure these rights, governments are instituted among men, deriving their just powers from the consent of the governed; that, whenever any form of government becomes destructive of these ends, it is the right of the people to alter or abolish it and to institute a new government, laying its foundation on such principles, and organizing its powers in such form, as to them shall seem most likely to effect their safety and happiness. Prudence, indeed, will dictate that governments long established should not be changed for light and transient causes; and, accordingly, all experience hath shown that mankind are more disposed to suffer, while evils are sufferable, than to right themselves by abolishing the forms to which they are accustomed. But, when a long train of abuses and usurpations, pursuing invariably the same object, evinces a design to reduce them under absolute despotism, it is their right, it is their duty, to throw off such government and to provide new guards for their future security. Such has been the patient sufferance of these colonies, and such is now the necessity which constrains them to alter their former systems of government. To prove this, let facts be submitted to a candid world: He has refused his assent to laws the most wholesome and

Lower case a to z, 13 1-2 ems

ABCDEFGHIJKLMN OPQRSTU VWXYZ
 abcdefghijklmno pqrstuvwxyz
 ABCDEFGHIJKLMN OPQRSTU VWXYZ
 1234567890 1234567890

Scotch Roman

10 POINT SCOTCH ROMAN

WHEN, in the course of human events, it becomes necessary for one people to dissolve the political bands which have connected them with another, and to assume, among the powers of the earth, the separate and equal station to which the laws of nature and of nature's God entitle them, a decent respect to the opinions of mankind requires that they should declare the causes which impel them to the separation. We hold these truths to be self-evident: That all men are created equal; that they are endowed by their Creator with certain inalienable rights; that among these are life, liberty, and the pursuit of happiness; that, to secure these rights, governments are instituted among men, deriving their just powers from the consent of the governed; that, when any form of government becomes destructive of these ends, it is the right of the people to alter or to abolish it and to institute a new government, laying its foundation on such principles, and organizing its powers in such form, as to them shall seem the most likely to effect their safety and happiness. Prudence, indeed, will dictate that governments long established should not be changed for *light and transient causes; and, accordingly, all experience hath shown that mankind are more disposed to suffer, while evils are sufferable, than to right*

Lower case a to z, 12 ems

ABCDEFGHIJKLMN OPQRSTU VWXYZ
 abcdefghijklmnopqrstu vwxyz
 ABCDEFGHIJKLMN OPQRSTU VWXYZ
 1234567890 1234567890

11 POINT SCOTCH ROMAN

WHEN, in the course of human events, it becomes necessary for one people to dissolve the political bands which have connected them with another, and to assume, among the powers of the earth, the separate and equal station to which the laws of nature and of nature's God entitle them, a decent respect to the opinions of mankind requires that they should declare the causes which impel them to the separation. We hold these truths to be self-evident: That all men are created equal; that they are endowed by their Creator with certain inalienable rights; that among these are life, liberty, and the pursuit of happiness; that, to secure these rights, governments are instituted among men, deriving their just powers from the consent of the governed; that, whenever any form of government becomes destructive of these ends, it is the right of the people to alter or to abolish it and to institute a new government, laying its foundation on such principles, and *organizing its powers in such form, as to them shall seem most likely to effect their safety and happiness. Prudence, indeed, will dictate that govern-*

Lower case a to z, 11 1/2 ems

ABCDEFGHIJKLMN OPQRSTU VWXYZ
 abcdefghijklmnopqrstu vwxyz
 ABCDEFGHIJKLMN OPQRSTU VWXYZ
 1234567890 1234567890

Scotch Roman

12 POINT SCOTCH ROMAN

WHEN, in the course of human events, it becomes necessary for one people to dissolve the political bands which have connected them with another, and to assume, among the powers of the earth, the separate and equal station to which the laws of nature and of nature's God entitle them, a decent respect to the opinions of mankind requires that they should declare the causes which impel them to the separation. We hold these truths to be self-evident: That all men are created equal; that they are endowed by their Creator with certain inalienable rights; that among these are life, liberty, and the pursuit of happiness; that, to secure these rights, governments are instituted among men, deriving their just powers from the consent of the governed; that whenever any form of government becomes destructive of these ends, it is the right of the people to alter or to abolish it and to institute a new

Lower case a to z, 12 7-12 ems

ABCDEFGHIJKLMNOPQRSTUVWXYZ

abcdefghijklmnopqrstuvwxyz

ABCDEFGHIJKLMNOPQRSTUVWXYZ

1234567890 1234567890

14 POINT SCOTCH ROMAN

When, in the course of human events, it becomes necessary for one people to dissolve the political bands which have connected them with another, and to assume, among the powers of the earth, the separate and equal station to which the laws of nature and of nature's God entitle them, a decent respect to the opinions of mankind requires that they should declare the causes which impel them to the separation. We hold these truths to be self-evident: That all men are created equal; that they are endowed by their Creator with certain inalienable rights; that among these are

Lower case a to z, 13 ems

ABCDEFGHIJKLMNOPQRSTUVWXYZ

abcdefghijklmnopqrstuvwxyz

1234567890 1234567890

18 POINT SCOTCH ROMAN

When, in the course of human events, it becomes necessary for one people to dissolve the political bands which have connected them with another, and to assume, among the powers of the earth, the separate and equal station to which the laws of nature and of nature's God entitle them, a decent respect to the opinions of mankind requires that they should declare the causes which impel them to the separation. We hold these truths to be self-evident: That all men are created equal: that they are endowed by their Creator with certain inalienable rights: that among these are life, liberty and the pursuit of happiness: that, to secure these rights, governments are instituted among men, deriving their just powers from the consent of the governed; that, whenever any form of government becomes destructive of these ends, it is the right of the people to alter or to abolish it and to institute *a new government, laying its foundations on such principles, and organiz*

Lower case a to z, 13 ems

ABCDEFGHIJKLMNOPQRSTU

abcdefghijklmnopqrstuvwxy z

1234567890 1234567890

Wayside

6 POINT WAYSIDE

WHEN, in the course of human events, it becomes necessary for one people to dissolve the political bands which have connected them with another, and to assume, among the powers of the earth, the separate and equal station to which the laws of nature and of nature's God entitle them, a decent respect to the opinions of mankind requires that they should declare the causes which impel them to the separation. We hold these truths to be self-evident: That all men are created equal: that they are endowed by their Creator with certain inalienable rights; that among these are life, liberty, and the pursuit of happiness; that, to secure these rights, governments are instituted among men, deriving their just powers from the consent of the governed; that, whenever any form of government becomes destructive of these ends, it is the right of the people to alter or to abolish it and to institute a new government, laying its foundations on such principles, and organizing its powers in such form, as to them shall seem most likely to effect their safety and happiness. Prudence, indeed, will dictate that governments long established should not be changed for light and transient causes; and, accordingly, all experience hath shown that mankind are more disposed to suffer, while evils are sufferable, than to right themselves by abolishing the forms to which they are accustomed. But, when a long train of abuses and usurpations, pursuing invariably the same object, evinces a design to reduce them under absolute despotism, it is their right, it is their duty, to throw off such govern-

Lower case a to z, 15 1-2 ems

ABCDEFGHIJKLMNQRSTU VWXYZ
 abcdefghijklmnopqrstuvwxyz
 ABCDEFGHIJKLMNQRSTU VWXYZ
 1234567890 1234567890

8 POINT WAYSIDE

WHEN, in the course of human events, it becomes necessary for one people to dissolve the political bands which have connected them with another, and to assume, among the powers of the earth, the separate and equal station to which the laws of nature and of nature's God entitle them, a decent respect to the opinions of mankind requires that they should declare the causes which impel them to the separation. We hold these truths to be self-evident: That all men are created equal; that they are endowed by their Creator with certain inalienable rights; that among these are life, liberty, and the pursuit of happiness; that, to secure these rights, governments are instituted among men, deriving their just powers from the consent of the governed; that, whenever any form of government becomes destructive of these ends, it is the right of the people to alter or to abolish it and to institute a new government, laying its foundation on such principles, and organizing its powers in such form, as to them shall seem most likely to effect their safety and happiness. Prudence, indeed, will dic-

Lower case a to z, 13 3-8 ems

ABCDEFGHIJKLMNQRSTU VWXYZ
 abcdefghijklmnopqrstuvwxyz
 ABCDEFGHIJKLMNQRSTU VWXYZ
 1234567890 1234567890

10 POINT WAYSIDE

WHEN, in the course of human events, it becomes necessary for one people to dissolve the political bands which have connected them with another, and to assume, among the powers of the earth, the separate and equal station to which the laws of nature and of nature's God entitle them, a decent respect to the opinions of mankind requires that they should declare the causes which impel them to the separation. We hold these truths to be self-evident: That all men are created equal: that they are endowed by their Creator with certain inalienable rights; that among these are life, liberty, and the pursuit of happiness; that, to secure these rights, governments are instituted among

Lower case a to z, 11 7-10 ems

ABCDEFGHIJKLMNQRSTU VWXYZ
 abcdefghijklmnopqrstuvwxyz
 ABCDEFGHIJKLMNQRSTU VWXYZ
 1234567890 1234567890

Wayside

11 POINT WAYSIDE

WHEN, in the course of human events, it becomes necessary for one people to dissolve the political bands which have connected them with another, and to assume, among the powers of the earth, the separate and equal station to which the laws of nature and of nature's God entitle them, a decent respect to the opinions of mankind requires that they should declare the causes which impel them to the separation. We hold these truths to be self-evident: That all men are created equal; that they are endowed by their Creator with certain inalienable rights; that among these are life, liberty, and the pursuit of happiness; that, to secure these rights, governments are instituted among men, deriving their just powers from the consent of the governed; that, whenever any form of government becomes destructive of these ends, it is the right of the people to alter or to abolish it and to institute a new government, *laying its foundations on such principles, and organizing its powers in such form, as to them shall seem most likely to effect their safety and*

Lower case a to z, 11 5-11 ems

ABCDEFGHIJKLMNOPQRSTUVWXYZ

abcdefghijklmnopqrstuvwxyz

ABCDEFGHIJKLMNOPQRSTUVWXYZ

1234567890 1234567890

12 POINT WAYSIDE

WHEN, in the course of human events, it becomes necessary for one people to dissolve the political bands which have connected them with another, and to assume, among the powers of the earth, the separate and equal station to which the laws of nature and of nature's God entitle them, a decent respect to the opinions of mankind requires that they should declare the causes which impel them to the separation. We hold these truths to be self-evident: That all men are created equal; that they are endowed by their Creator with certain inalienable rights; that among these are life, liberty, and the pursuit of happiness; that, to secure these rights, governments are instituted among men, deriving their just powers *from the consent of the governed; that, whenever any form of government becomes destructive of these ends, it is the right of*

Lower case a to z, 12 2-3 ems

ABCDEFGHIJKLMNOPQRSTUVWXYZ

abcdefghijklmnopqrstuvwxyz

ABCDEFGHIJKLMNOPQRSTUVWXYZ

1234567890 1234567890

Partly owned with two point line

6 POINT LINING ROMAN No. 510

WHEN, in the course of human events, it becomes necessary for one people to dissolve the political bands which have connected them with another, and to assume, among the powers of the earth, the separate and equal station to which the laws of nature and of nature's God entitle them, a decent respect to the opinions of mankind requires that they should declare the causes which impel them to the separation. We hold these truths to be self-evident: That all men are created equal; that they are endowed by their Creator with certain inalienable rights; that among these are life, liberty, and the pursuit of happiness; that to secure these rights, governments are instituted among men, deriving their just powers from the consent of the governed; that, whenever any form of government becomes destructive of these ends, it is the right of the people to alter or to abolish it and to institute a new government, laying its foundation on such principles, and organizing its powers in such form, as to them shall seem most likely to effect their safety and happiness. Prudence, indeed, will dictate that governments long established should not be changed for light and transient causes; and, accordingly, all experience hath shown that mankind are more disposed to suffer, while evils are *sufferable*, than to right themselves by abolishing the forms to which they are accustomed. But, when a long train of abuses and usurpations, pursuing invariably the same object, evinces a design to reduce them under

Lower case a to z, 15 5-6 ems

ABCDEFGHIJKLMN O PQRSTU VWXYZ
 abcdefghijklmnopqrstu vwxyz
 ABCDEFGHIJKLMN O PQRSTU VWXYZ
 1234567890 1234567890

8 POINT LINING ROMAN No. 510

WHEN, in the course of human events, it becomes necessary for one people to dissolve the political bands which have connected them with another, and to assume, among the powers of the earth, the separate and equal station to which the laws of nature and of nature's God entitle them, a decent respect to the opinions of mankind requires that they should declare the causes which impel them to the separation. We hold these truths to be self-evident: That all men are created equal; that they are endowed by their Creator with certain inalienable rights; that among these are life, liberty, and the pursuit of happiness; that, to secure these rights, governments are instituted among men, deriving their just powers from the consent of the governed; that, whenever any form of government becomes destructive of these ends, it is *the right of the people to alter or to abolish it and to institute a new government, laying its foundation on such principles, and organizing its powers in such form, as to them shall*

Lower case a to z, 13 7-8 ems

ABCDEFGHIJKLMN O PQRSTU VWXYZ
 abcdefghijklmnopqrstu vwxyz
 ABCDEFGHIJKLMN O PQRSTU VWXYZ
 1234567890 1234567890

9 POINT LINING ROMAN No. 510

WHEN, in the course of human events, it becomes necessary for one people to dissolve the political bands which have connected them with another, and to assume, among the powers of the earth, the separate and equal station to which the laws of nature and of nature's God entitle them, a decent respect to the opinions of mankind requires that they should declare the causes which impel them to the separation. We hold these truths to be self-evident: That all men are created equal; that they are endowed by their Creator with certain inalienable rights; that among these are life, liberty, and the pursuit of happiness; *that, to secure these rights, governments are instituted among men, deriving their just powers from the consent of the governed; that, whenever any form of government be-*

Lower case a to z, 12 8-9 ems

ABCDEFGHIJKLMN O PQRSTU VWXYZ
 abcdefghijklmnopqrstu vwxyz
 ABCDEFGHIJKLMN O PQRSTU VWXYZ
 1234567890 1234567890

Partly opened with two point leads

10 POINT LINING ROMAN No. 510

WHEN, in the course of human events, it becomes necessary for one people to dissolve the political bands which have connected them with another, and to assume, among the powers of the earth, the separate and equal station to which the laws of nature and of nature's God entitle them, a decent respect to the opinions of mankind requires that they should declare the causes which impel them to the separation. We hold these truths to be self-evident: That all men are created equal; that they are endowed by their Creator with certain inalienable rights; that among these are life, liberty, and the pursuit of happiness; that, to secure these rights, governments

Lower case a to z, 12 3-5 ems

ABCDEFGHIJKLMN OPQRSTUVWXYZ

abcdefghijklmnopqrstuvwxyz

ABCDEFGHIJKLMN OPQRSTUVWXYZ

1234567890 1234567890

11 POINT LINING ROMAN No. 510

WHEN, in the course of human events, it becomes necessary for one people to dissolve the political bands which have connected them with another, and to assume, among the powers of the earth, the separate and equal station to which the laws of nature and of nature's God entitle them, a decent respect to the opinions of mankind requires that they should declare the causes which impel them to the separation. We hold these truths to be self-evident: That all men are created equal; that they are endowed by their Creator with certain inalienable rights; that among these are life, liberty, and the pursuit of

Lower case a to z, 12 3-11 ems

ABCDEFGHIJKLMN OPQRSTUVWXYZ

abcdefghijklmnopqrstuvwxyz

ABCDEFGHIJKLMN OPQRSTUVWXYZ

1234567890 1234567890

12 POINT LINING ROMAN No. 510

WHEN, in the course of human events, it becomes necessary for one people to dissolve the political bands which have connected them with another, and to assume, among the powers of the earth, the separate and equal station to which the laws of nature and of nature's God entitle them, a decent respect to the opinions of mankind requires that they should declare the causes which impel them to the separation. We hold these truths to be self-evident: That all men are created equal; that

Lower case a to z, 12 2-3 ems

ABCDEFGHIJKLMN OPQRSTUVWXYZ

abcdefghijklmnopqrstuvwxyz

ABCDEFGHIJKLMN OPQRSTUVWXYZ

1234567890 1234567890

Norwood Roman

6 POINT NORWOOD ROMAN

WHEN, in the course of human events, it becomes necessary for one people to dissolve the political bands which have connected them with another, and to assume, among the powers of the earth, the separate and equal station to which the laws of nature and of nature's God entitle them, a decent respect to the opinions of mankind requires that they should declare the causes which impel them to the separation. We hold these truths to be self-evident: That all men are created equal; that they are endowed by their Creator with certain inalienable rights; that among these are life, liberty, and the pursuit of happiness; that, to secure these rights, governments are instituted among men, deriving their just powers from the consent of the governed; that, whenever any form of government becomes destructive of these ends, it is the right of the people to alter or to abolish it and to institute a new government, laying its foundations on such principles, and organizing its powers in such form, as to them shall seem most likely to effect their safety and happiness. Prudence, indeed, will dictate that governments long established should not be changed for light and transient causes; and, accordingly, all experience hath shown that mankind are more disposed to suffer, while evils are sufferable, than to right themselves by abolishing the forms to which they are accustomed. But, when a long train of abuses and usurpations, pursuing invariably the same object, evinces a design to reduce them under absolute despotism, it is their right, it is their duty, to throw off such government and to provide new guards for their future security. Such has been the patient sufferance of these colonies, and such is now the necessity which constrains them to alter their former systems of government. The history of the present King of Great Britain is a history of repeated injuries and usurpations, all having, in direct object, the establishment of an absolute tyranny over these States. To prove this, let facts be submitted to a candid world: He has refused his assent to laws the most wholesome and necessary for the public good; he has forbidden his governors to pass laws of immediate and pressing importance, unless suspended in their operation till his assent should be obtained; and, when so suspended, he has utterly neglected to attend to them; he has refused to pass other laws for the accommodation of large districts of people, unless those people would relinquish the right of representation in the legislature, a right inestimable to them, and formidable to tyrants only; he has called together legislative bodies at places unusual, uncomfortable, and distant from the depository of their public records, for the sole purpose of fatiguing them into compliance with his measures; he has dissolved representative houses repeatedly, for opposing, with manly firmness, his *invasions on the rights of the people*; he has refused, for a long time after such dissolutions, to cause others to be elected; whereby the legislative powers, in-

Lower case a to z, 15 1-6 ems

ABCDEFGHIJKLMN OPQRSTUVWXYZ
 abcdefghijklmn opqrstuvwxyz
 ABCDEFGHIJKLMN OPQRSTUVWXYZ
 1234567890 1234567890

8 POINT NORWOOD ROMAN

WHEN, in the course of human events, it becomes necessary for one people to dissolve the political bands which have connected them with another, and to assume, among the powers of the earth, the separate and equal station to which the laws of nature and of nature's God entitle them, a decent respect to the opinions of mankind requires that they should declare the causes which impel them to the separation. We hold these truths to be self-evident: That all men are created equal; that they are endowed by their Creator with certain inalienable rights; that among these are life, liberty, and the pursuit of happiness; that, to secure these rights, governments are instituted among men, deriving their just powers from the consent of the governed; that, whenever any form of government becomes destructive of these ends, it is the right of the people to alter or to abolish it and to institute a new government, laying its foundations on such principles, and organizing its powers in such form, as to them shall seem most likely to effect their safety and happiness. Prudence, indeed, will dictate that governments long established should not be changed for light and transient causes; and, accordingly, all experience hath shown that mankind are more disposed to suffer, while evils are sufferable, than to right themselves by abolishing the forms to which they are accustomed. But, when a long train of abuses and usurpations, pursuing invariably the same object, evinces a design to reduce them under absolute despotism, it is their right, it is their duty, to throw off such government and to provide new guards for their future security. Such has been the patient sufferance of these colonies, and such is now the *necessity which constrains them to alter their former systems of government. The history of the present King of Great Britain is a history of repeated injuries*

Lower case a to z, 13 1-8 ems

ABCDEFGHIJKLMN OPQRSTUVWXYZ
 abcdefghijklmn opqrstuvwxyz
 ABCDEFGHIJKLMN OPQRSTUVWXYZ
 1234567890 1234567890

Norwood Roman

10 POINT NORWOOD ROMAN

WHEN, in the course of human events, it becomes necessary for one people to dissolve the political bands which have connected them with another, and to assume, among the powers of the earth, the separate and equal station to which the laws of nature and of nature's God entitle them, a decent respect to the opinions of mankind requires that they should declare the causes which impel them to the separation. We hold these truths to be self-evident: That all men are created equal; that they are endowed by their Creator with certain inalienable rights; that among these are life, liberty, and the pursuit of happiness; that, to secure these rights, governments are instituted among men, deriving their just powers from the consent of the governed; that, whenever any form of government becomes destructive of these ends, it is the right of the people to alter or to abolish it and to institute a new government, laying its foundations on such principles, and organizing its powers in such form, as to them shall seem most likely to effect their safety and happiness. Prudence, indeed, will dictate that governments *long established should not be changed for light and transient causes; and, accordingly, all experience hath shown that mankind are more*

Lower case a to z, 13 2-5 ems

ABCDEFGHIJKLMNOPQRSTUVWXYZ
abcdefghijklmnopqrstuvwxyz
ABCDEFGHIJKLMNOPQRSTUVWXYZ
1234567890 1234567890

12 POINT NORWOOD ROMAN

WHEN, in the course of human events, it becomes necessary for one people to dissolve the political bands which have connected them with another, and to assume, among the powers of the earth, the separate and equal station to which the laws of nature and of nature's God entitle them, a decent respect to the opinions of mankind requires that they should declare the causes which impel them to the separation. We hold these truths to be self-evident: That all men are created equal; that they are endowed by their Creator with certain inalienable rights; that among these are life, liberty, and the pursuit of happiness; that, to secure these rights, governments are instituted among men, deriving their just powers from the consent of the governed; that, whenever any form of government becomes destructive of these ends, it is the right of the people

Lower case a to z, 12 1-3 ems

ABCDEFGHIJKLMNOPQRSTUVWXYZ
abcdefghijklmnopqrstuvwxyz
ABCDEFGHIJKLMNOPQRSTUVWXYZ
1234567890 1234567890

Partly opened with two point leads

5 POINT ROMAN No. 590

WHEN in the course of human events, it becomes necessary for one people to dissolve the political bands which have connected them with another, and to assume, among the powers of the earth, the separate and equal station to which the laws of nature and of nature's God entitle them, a decent respect to the opinions of mankind requires that they should declare the causes which impel them to the separation. We hold these truths to be self-evident: That all men are created equal; that they are endowed by their Creator with certain inalienable rights; that among these are life, liberty, and the pursuit of happiness; that, to secure these rights, governments are instituted among men, deriving their just powers from the consent of the governed; that, whenever any form of government becomes destructive of these ends, it is the right of the people to alter or to abolish it, and to institute a new government, laying its foundation on such principles, and organizing its powers in such form, as to them shall seem most likely to effect their safety and happiness. Prudence, indeed, will dictate that governments long established should not be changed for light and transient causes; and, accordingly, all experience hath shown that mankind are more disposed to suffer, while evils are sufferable, than to right themselves by abolishing the forms to which they are accustomed. But, when a long train of abuses and usurpations, pursuing invariably the same object, evinces a design to reduce them under absolute despotism, it is their right, it is their duty, to throw off such government and to provide new guards for their future security. Such has been the patient sufferance of these colonies, and such is now the necessity which constrains them to alter their former systems of government. The history of the present King of Great Britain is a history of repeated injuries and usurpations, all having, in direct object,

Lower case a to z, 15 3-4 ems

ABCDEFGHIJKLMN O PQRSTU VWXYZ
 abcdefghijklmnopqrstuvwxyz
 ABCDEFGHIJKLMN O PQRSTU VWXYZ
 1234567890 1234567890

6 POINT ROMAN No. 590

WHEN, in the course of human events, it becomes necessary for one people to dissolve the political bands which have connected them with another, and to assume, among the powers of the earth, the separate and equal station to which the laws of nature and of nature's God entitle them, a decent respect to the opinions of mankind requires that they should declare the causes which impel them to the separation. We hold these truths to be self-evident: That all men are created equal; that they are endowed by their Creator with certain inalienable rights; that among these are life, liberty, and the pursuit of happiness; that, to secure these rights, governments are instituted among men, deriving their just powers from the consent of the governed; that whenever any form of government becomes destructive of these ends, it is the right of the people to alter or to abolish it, and to institute a new government, laying its foundation on such principles, and organizing its powers in such form, as to them shall seem most likely to effect their safety and happiness. Prudence, indeed, will dictate that governments long established should not be changed for light and transient causes; and, accordingly, all experience hath shown that mankind are more disposed to suffer, while evils are sufferable, than to right themselves by abolishing the forms to which they are accustomed. But, when a long train of abuses

Lower case a to z, 15 ems

ABCDEFGHIJKLMN O PQRSTU VWXYZ
 abcdefghijklmnopqrstuvwxyz
 ABCDEFGHIJKLMN O PQRSTU VWXYZ
 1234567890 1234567890

Partly opened with two point leads

5½ POINT ROMAN No. 590

WHEN, in the course of human events, it becomes necessary for one people to dissolve the political bands which have connected them with another, and to assume, among the powers of the earth, the separate and equal station to which the laws of nature and of nature's God entitle them, a decent respect to the opinions of mankind requires that they should declare the causes which impel them to the separation. We hold these truths to be self-evident: That all men are created equal; that they are endowed by their Creator with certain inalienable rights; that among these are life, liberty, and the pursuit of happiness; that, to secure these rights, governments are instituted among men, deriving their just powers from the consent of the governed; that whenever any form of government becomes destructive of these ends, it is the right of the people to alter or to abolish it, and to institute a new government, laying its foundation on such principles, and organizing its powers in such form, as to them shall seem most likely to effect their safety and happiness. Prudence, indeed, will dictate that governments long established should not be changed for light and transient causes; and, accordingly, all experience hath shown that mankind are more disposed to suffer, while evils are sufferable, than to right themselves by abolishing the forms to which they are accustomed. But, when a long train of abuses and usurpations, pursuing invariably the same object, evinces a design to reduce them under absolute despotism, it is their right, it

Lower case a to z, 16 1-4 ems

ABCDEFGHIJKLMN O PQRSTU VWXYZ
 abcdefghijklmnopqrstuvwxyz
 ABCDEFGHIJKLMN O PQRSTU VWXYZ
 1234567890 1234567890

7 POINT ROMAN No. 590

WHEN, in the course of human events, it becomes necessary for one people to dissolve the political bands which have connected them with another, and to assume, among the powers of the earth, the separate and equal station to which the laws of nature and of nature's God entitle them, a decent respect to the opinions of mankind requires that they should declare the causes which impel them to the separation. We hold these truths to be self-evident: That all men are created equal; that they are endowed by their Creator with certain inalienable rights; that among these are life, liberty, and the pursuit of happiness; that, to secure these rights, governments are instituted among men, deriving their just powers from the consent of the governed; that whenever any form of government becomes destructive of these ends, it is the right of the people to alter or to abolish it, and to institute a new government, laying its foundation on such principles, and organizing its powers in such form, as to them shall seem most likely to

Lower case a to z, 14 3-7 ems

ABCDEFGHIJKLMN O PQRSTU VWXYZ
 abcdefghijklmnopqrstuvwxyz
 ABCDEFGHIJKLMN O PQRSTU VWXYZ
 1234567890 1234567890

8 POINT ROMAN No. 590

WHEN, in the course of human events, it becomes necessary for one people to dissolve the political bands which have connected them with another, and to assume, among the powers of the earth, the separate and equal station to which the laws of nature and of nature's God entitle them, a decent respect to the opinions of mankind requires that they should declare the causes which impel them to the separation. We hold these truths to be self-evident; That all men are created equal; that they are endowed by their Creator with certain inalienable rights; that among these are life, liberty, and the pursuit of happiness; that, to secure these rights, governments are instituted among men, deriving their just powers from the consent of the governed; that, whenever any form of government becomes destructive of these ends, *it is the right of the people to alter or to abolish it, and to institute a new government, laying its foundations on such principles, and organizing its powers in such form, as to them*

Lower case a to z, 13 1-2 ems

ABCDEFGHIJKLMN^{OP}QRSTU^{VW}XYZ
 abcdefghijklm^{nop}qrstuv^{wxy}z
 ABCDEFGHIJKLMN^{OP}QRSTU^{VW}XYZ
 1234567890 1234567890

9 POINT ROMAN No. 590

WHEN, in the course of human events, it becomes necessary for one people to dissolve the political bands which have connected them with another, and to assume, among the powers of the earth, the separate and equal station to which the laws of nature and of nature's God entitle them, a decent respect to the opinions of mankind requires that they should declare the causes which impel them to the separation. We hold these truths to be self-evident; That all men are created equal; that they are endowed by their Creator with certain inalienable rights; that among these are life, liberty, and the pursuit of happiness; that, to secure these rights, governments are instituted among men, deriving their just powers from the consent of the governed; that, whenever any form of gov-

Lower case a to z, 13 ems

ABCDEFGHIJKLMN^{OP}QRSTU^{VW}XYZ
 abcdefghijklm^{nop}qrstuv^{wxy}z
 ABCDEFGHIJKLMN^{OP}QRSTU^{VW}XYZ
 1234567890 1234567890

10 POINT ROMAN No. 590

WHEN, in the course of human events, it becomes necessary for one people to dissolve the political bands which have connected them with another, and to assume, among the powers of the earth, the separate and equal station to which the laws of nature and of nature's God entitle them, a decent respect to the opinions of mankind requires that they should declare the causes which impel them to the separation. We hold these truths to be self-evident; That all men are created equal; that they are endowed by their Creator with certain inalienable rights; that among these are life, liberty, and the pursuit of happiness; that, to

Lower case a to z, 12 9 10 ems

ABCDEFGHIJKLMN^{OP}QRSTU^{VW}XYZ
 abcdefghijklm^{nop}qrstuv^{wxy}z
 ABCDEFGHIJKLMN^{OP}QRSTU^{VW}XYZ
 1234567890 1234567890

Partly opened with two point leads

11 POINT ROMAN No. 590

WHEN, in the course of human events, it becomes necessary for one people to dissolve the political bands which have connected them with another, and to assume, among the powers of the earth, the separate and equal station to which the laws of nature and of nature's God entitle them, a decent respect to the opinions of mankind requires that they should declare the causes which impel them to the separation. We hold these truths to be self-evident: That all men are created equal; that they are endowed by their Creator with certain inalienable rights; that among these are life, liberty, and the pursuit of happiness; that, to secure these rights, governments are instituted among men, deriving their just powers from the consent of the governed; that, whenever any form of government becomes destructive of these ends, it is the right of the people to alter or to abolish it *and to institute a new government, laying its foundations on such principles, and organizing its powers in such form, as to them*

Lower case a to z, 13 2-11 ems

ABCDEFGHIJKLMN OPQRSTUVWXYZ
 abcdefghijklm nopqrstuvwxyz
 ABCDEFGHIJKLMN OPQRSTUVWXYZ
 1234567890 1234567890

12 POINT ROMAN No. 590

WHEN, in the course of human events, it becomes necessary for one people to dissolve the political bands which have connected them with another, and to assume, among the powers of the earth, the separate and equal station to which the laws of nature and of nature's God entitle them, a decent respect to the opinions of mankind requires that they should declare the causes which impel them to the separation. We hold these truths to be self-evident: That all men are created equal; that they are endowed by their Creator with certain inalienable rights; that among these are life, liberty, and the pursuit of happiness; that, to secure these rights, governments are instituted among men, *deriving their just powers from the consent of the governed; that, whenever any form of government becomes de-*

Lower case a to z, 13 1-2 ems

ABCDEFGHIJKLMN OPQRSTUVWXYZ
 abcdefghijklm nopqrstuvwxyz
 ABCDEFGHIJKLMN OPQRSTUVWXYZ
 1234567890 1234567890

Partly opened with two point leads

Lining Roman Nos. 524 and 527

5 POINT LINING ROMAN No. 524

WHEN, in the course of human events, it becomes necessary for one people to dissolve the political bands which have connected them with another, and to assume, among the powers of the earth, the separate and equal station to which the laws of nature and of nature's God entitle them, a decent respect to the opinions of mankind requires that they should declare the causes which impel them to the separation. We hold these truths to be self-evident: That all men are created equal; that they are endowed by their Creator with certain inalienable rights; that among these are life, liberty, and the pursuit of happiness; that, to secure these rights, governments are instituted among men, deriving their just powers from the consent of the governed; that, whenever any form of government becomes destructive of these ends, it is the right of the people to alter or to abolish it and to institute a new government, laying its foundations on such principles, and organizing its powers in such form, as to them shall seem most likely to effect their safety and happiness. Prudence, indeed, will dictate that governments long established should not be changed for light and transient causes; and, accordingly, all experience hath shown that mankind are more disposed to suffer, while evils are sufferable, than to right themselves by abolishing the forms to which they are accustomed. But, when a long train of abuses and usurpations, pursuing invariably the same object, evinces a design to reduce them under absolute despotism, it is their right, it is their duty, to throw off such government and to provide new guards for their future security. Such has been the patient sufferance of these colonies, and such is now the necessity which constrains them to alter their former systems of government. The history of the present King of Great Britain is a history of repeated injuries and usurpations, all having, in direct object, the establishment of an absolute tyranny over these States. To prove this, let facts be submitted to a candid world. He has refused his assent to laws the most wholesome and necessary for the public good. He has refused his assent to laws the most wholesome and necessary for the public good. He has refused his assent to laws the most wholesome and necessary for the public good. He has refused his assent to laws the most wholesome and necessary for the public good.

Lower case a to z, 14 1/2 ems
 ABCDEFGHIJKLMNOPQRSTUVWXYZ
 abcdefghijklmnopqrstuvwxyz
 ABCDEFGHIJKLMNOPQRSTUVWXYZ
 1234567890

Lining Roman No. 527

5 POINT LINING ROMAN No. 527

WHEN, in the course of human events, it becomes necessary for one people to dissolve the political bands which have connected them with another, and to assume, among the powers of the earth, the separate and equal station to which the laws of nature and of nature's God entitle them, a decent respect to the opinions of mankind requires that they should declare the causes which impel them to the separation. We hold these truths to be self-evident: That all men are created equal; that they are endowed by their Creator with certain inalienable rights; that among these are life, liberty, and the pursuit of happiness; that, to secure these rights, governments are instituted among men, deriving their just powers from the consent of the governed; that, whenever any form of government becomes destructive of these ends, it is the right of the people to alter or to abolish it and to institute a new government, laying its foundations on such principles, and organizing its powers in such form, as to them shall seem most likely to effect their safety and happiness. Prudence, indeed, will dictate that governments long established should not be changed for light and transient causes; and, accordingly, all experience hath shown that mankind are more disposed to suffer, while evils are sufferable, than to right themselves by abolishing the forms to which they are accustomed. But, when a long train of abuses and usurpations, pursuing invariably the same object, evinces a design to reduce them under absolute despotism, it is their right, it is their duty, to throw off such government and to provide new guards for their future security. Such has been the patient sufferance of these colonies, and such is now the necessity which constrains them to alter their former systems of government. The history of the present King of Great Britain is a history of repeated injuries and usurpations, all having, in direct object, the establishment of an absolute tyranny over these States. To prove this, let facts be submitted to a candid world. He has refused his assent to laws the most wholesome and necessary for the public good. He has refused his assent to laws the most wholesome and necessary for the public good. He has refused his assent to laws the most wholesome and necessary for the public good. He has refused his assent to laws the most wholesome and necessary for the public good.

Lower case a to z, 17 ems
 ABCDEFGHIJKLMNOPQRSTUVWXYZ
 abcdefghijklmnopqrstuvwxyz
 ABCDEFGHIJKLMNOPQRSTUVWXYZ
 1234567890

5 1/2 POINT LINING ROMAN No. 527

WHEN, in the course of human events, it becomes necessary for one people to dissolve the political bands which have connected them with another, and to assume, among the powers of the earth, the separate and equal station to which the laws of nature and of nature's God entitle them, a decent respect to the opinions of mankind requires that they should declare the causes which impel them to the separation. We hold these truths to be self-evident: That all men are created equal; that they are endowed by their Creator with certain inalienable rights; that among these are life, liberty, and the pursuit of happiness; that, to secure these rights, governments are instituted among men, deriving their just powers from the consent of the governed; that, whenever any form of government becomes destructive of these ends, it is the right of the people to alter or to abolish it and to institute a new government, laying its foundations on such principles, and organizing its powers in such form, as to them shall seem most likely to effect their safety and happiness. Prudence, indeed, will dictate that governments long established should not be changed for light and transient causes; and, accordingly, all experience hath shown that mankind are more disposed to suffer, while evils are sufferable, than to right themselves by abolishing the forms to which they are accustomed. But, when a long train of abuses and usurpations, pursuing invariably the same object, evinces a design to reduce them under absolute despotism, it is their right, it is their duty, to throw off such government and to provide new guards for their future security. Such has been the patient sufferance of these colonies, and such is now the necessity which constrains them to alter their former systems of government. The history of the present King of Great Britain is a history of repeated injuries and usurpations, all having, in direct object, the establishment of an absolute tyranny over these States. To prove this, let facts be submitted to a candid world. He has refused his assent to laws the most wholesome and necessary for the public good. He has refused his assent to laws the most wholesome and necessary for the public good. He has refused his assent to laws the most wholesome and necessary for the public good. He has refused his assent to laws the most wholesome and necessary for the public good.

Lower case a to z, 16 ems
 ABCDEFGHIJKLMNOPQRSTUVWXYZ
 abcdefghijklmnopqrstuvwxyz
 ABCDEFGHIJKLMNOPQRSTUVWXYZ
 1234567890

Partly opened with two point leads

6 POINT ROMAN No. 596

WHEN, in the course of human events, it becomes necessary for one people to dissolve the political bands which have connected them with another, and to assume, among the powers of the earth, the separate and equal station to which the laws of nature and of nature's God entitle them, a decent respect to the opinions of mankind requires that they should declare the causes which impel them to the separation. We hold these truths to be self-evident: That all men are created equal; that they are endowed by their Creator with certain inalienable rights; that among these are life, liberty, and the pursuit of happiness; that, to secure these rights, governments are instituted among men, deriving their just powers from the consent of the governed; that, whenever any form of government becomes destructive of these ends, it is the right of the people to alter or to abolish it and to institute a new government, laying its foundations on such principles, and organizing its powers in such form, as to them shall seem most likely to effect their safety and happiness. Prudence, indeed, will dictate that governments long established should not be changed for light and transient causes; and, accordingly, all experience hath shown that mankind are more disposed to suffer, while evils are sufferable, than to right themselves by abolishing the forms to which they are accustomed. But, when a long train of abuses and usurpations, pursuing invariably the same object, evinces a design to reduce them under absolute despotism, it is their right, it is their duty, to throw off such government and to provide new guards for their future security. Such has been the patient sufferance of these colonies, and such is now the necessity which constrains them to alter their former systems of government. The history of the present King of Great Britain is a history of repeated injuries and usurpations, all having, in direct object, the establishment of an absolute tyranny over these States. To prove this, let facts be submitted to a candid world: He has refused his assent to laws the most wholesome and necessary for the public good; he has forbidden his governors to pass laws of immediate and pressing importance, unless suspended in their operation till his assent should be obtained; and, when so suspended, he has utterly neglected to attend to them; he has refused to pass other laws for the accommodation of large districts of people, unless those people would relinquish the right of representation in the legislature; a right inestimable to them, and formidable to tyrants only; he has called together legislative bodies at places unusual, uncomfortable, and distant from the depository of their public records, for the sole purpose of fatiguing them into compliance with his measures; he has dissolved representative houses repeatedly, for opposing, with manly firmness, his invasions on the rights of the people; he has refused, for a long time after such dis-

Lower case a to z, 15 5/6 ems

ABCDEFGHIJKLMN OPQRSTUVWXYZ
 abcdefghijklmnopqrstuvwxyz
 ABCDEFGHIJKLMN OPQRSTUVWXYZ
 1234567890 1234567890

7 POINT ROMAN No. 596

WHEN, in the course of human events, it becomes necessary for one people to dissolve the political bands which have connected them with another, and to assume, among the powers of the earth, the separate and equal station to which the laws of nature and of nature's God entitle them, a decent respect to the opinions of mankind requires that they should declare the causes which impel them to the separation. We hold these truths to be self-evident: That all men are created equal; that they are endowed by their Creator with certain inalienable rights; that among these are life, liberty, and the pursuit of happiness; that, to secure these rights, governments are instituted among men, deriving their just powers from the consent of the governed; that, whenever any form of government becomes destructive of these ends, it is the right of the people to alter or to abolish it and to institute a new government, laying its foundations on such principles, and organizing its powers in such form, as to them shall seem most likely to effect their safety and happiness. Prudence, indeed, will dictate that governments long established should not be changed for light and transient causes; and, accordingly, all experience hath shown that mankind are more disposed to suffer, while evils are sufferable, than to right themselves by abolishing the forms to which they are accustomed. But, when a long train of abuses and usurpations, pursuing invariably the same object, evinces a design to reduce them under absolute despotism, it is their right, it is their duty, to throw off such government and to provide new guards for their future security. Such has been the patient sufferance of these colonies, and such is now the necessity which constrains them to alter their former systems of government. The history of the present King of Great Britain is a history of repeated injuries and usurpations, all having, in direct object, the establishment of an absolute tyranny over these States. To prove this, let facts be submitted to a candid world: He has refused his assent to laws the most wholesome and necessary for the public good; he has forbidden his governors to pass laws of immediate and pressing importance, unless suspended in their operation till his assent should be obtained; and, when so suspended,

Lower case a to z, 15 ems

ABCDEFGHIJKLMN OPQRSTUVWXYZ
 abcdefghijklmnopqrstuvwxyz
 ABCDEFGHIJKLMN OPQRSTUVWXYZ
 1234567890 1234567890

Partly opened with two point leads

8 POINT ROMAN No. 596

WHEN, in the course of human events, it becomes necessary for one people to dissolve the political bands which have connected them with another, and to assume, among the powers of the earth, the separate and equal station to which the laws of nature and of nature's God entitle them, a decent respect to the opinions of mankind requires that they should declare the causes which impel them to the separation. We hold these truths to be self-evident: That all men are created equal; that they are endowed by their Creator with certain inalienable rights; that among these are life, liberty, and the pursuit of happiness; that, to secure these rights, governments are instituted among men, deriving their just powers from the consent of the governed; that, whenever any form of government becomes destructive of these ends, it is the right of the people to alter or to abolish it and to institute a new government, laying its foundations on such principles, and organizing its powers in such form, as to them shall seem most likely to effect their safety and happiness. Prudence, indeed, will dictate that governments long established should not be changed for light and transient causes; and, accordingly, all experience hath shown that mankind are more disposed to suffer, while evils are accustomed. But, when a long train of abuses and usurpations, pursuing invariably the same object, evinces a design to reduce them under absolute despotism, it is their right, it is their duty, to throw off such government and to provide new guards for their future security. *Such has been the patient sufferance of these colonies, and such is now the necessity which constrains them to alter their former systems of*

Lower case a to z, 11 1-4 ems

ABCDEFGHIJKLMN OPQRSTUVWXYZ
 abcdefghijklmnopqrstuvwxyz
 ABCDEFGHIJKLMN OPQRSTUVWXYZ
 1234567890 1234567890

9 POINT ROMAN No. 596

WHEN, in the course of human events, it becomes necessary for one people to dissolve the political bands which have connected them with another, and to assume, among the powers of the earth, the separate and equal station to which the laws of nature and of nature's God entitle them, a decent respect to the opinions of mankind requires that they should declare the causes which impel them to the separation. We hold these truths to be self-evident: That all men are created equal; that they are endowed by their Creator with certain inalienable rights; that among these are life, liberty, and the pursuit of happiness; that, to secure these rights, governments are instituted among men, deriving their just powers from the consent of the governed; that, whenever any form of government becomes destructive of these ends, it is the right of the people to alter or to abolish it and to institute a new government, laying its foundations on such principles, and organizing its powers in such form, as to them shall seem most likely to effect their safety and happiness. Prudence, indeed, will dictate that governments long established should not be changed for light and transient causes; and, accordingly, all experience hath shown that mankind are more disposed to suffer, while evils are sufferable, than to right themselves by abolishing the forms to which they are accustomed. But, when a long train of abuses and usurpations, pursuing invariably the same object, evinces a design to reduce them under absolute despotism, it is their right, it is

Lower case a to z, 13 2-9 ems

ABCDEFGHIJKLMN OPQRSTUVWXYZ
 abcdefghijklmnopqrstuvwxyz
 ABCDEFGHIJKLMN OPQRSTUVWXYZ
 1234567890 1234567890

Partly opened with two point lead

10 POINT ROMAN No. 596

WHEN, in the course of human events, it becomes necessary for one people to dissolve the political bands which have connected them with another, and to assume, among the powers of the earth, the separate and equal station to which the laws of nature and of nature's God entitle them, a decent respect to the opinions of mankind requires that they should declare the causes which impel them to the separation. We hold these truths to be self-evident: That all men are created equal; that they are endowed by their Creator with certain inalienable rights; that among these are life, liberty, and the pursuit of happiness; that, to secure these rights, governments are instituted among men, deriving their just powers from the consent of the governed; that, whenever any form of government becomes destructive of these ends, it is the right of the people to alter or to abolish it and to institute a new government, laying its foundation on such principles, and organizing its powers in such form, as to them shall seem most likely to effect their safety and happiness. Prudence, indeed, will dictate that governments long established should *not be changed for light and transient causes; and, accordingly, all experience hath shown that mankind are more disposed to suffer, while*

Lower case a to z, 12 3-5 ems

ABCDEFGHIJKLMN OPQRSTUVWXYZ
 abcdefghijklmnopqrstuvwxy z
 ABCDEFGHIJKLMN OPQRSTUVWXYZ
 1234567890 1234567890

11 POINT ROMAN No. 596

WHEN, in the course of human events, it becomes necessary for one people to dissolve the political bands which have connected them with another, and to assume, among the powers of the earth, the separate and equal station to which the laws of nature and of nature's God entitle them, a decent respect to the opinions of mankind requires that they should declare the causes which impel them to the separation. We hold these truths to be self-evident: That all men are created equal; that they are endowed by their Creator with certain inalienable rights; that among these are life, liberty, and the pursuit of happiness; that, to secure these rights, governments are instituted among men, deriving their just powers from the consent of the governed; that, whenever any form of government becomes destructive of these ends, it is the right of the people to alter or to abolish it and to institute a new government, laying its foundations on such principles, and *organizing its powers in such form, as to them shall seem most likely to effect their safety and happiness. Prudence, indeed, will dictate that*

Lower case a to z, 12 1-11 ems

ABCDEFGHIJKLMN OPQRSTUVWXYZ
 abcdefghijklmnopqrstuvwxy z
 ABCDEFGHIJKLMN OPQRSTUVWXYZ
 1234567890 1234567890

Partly opened with two point leads

12 POINT ROMAN NO. 596

WHEN, in the course of human events, it becomes necessary for one people to dissolve the political bands which have connected them with another, and to assume, among the powers of the earth, the separate and equal station to which the laws of nature and of nature's God entitle them, a decent respect to the opinions of mankind requires that they should declare the causes which impel them to the separation. We hold these truths to be self-evident: That all men are created equal; that they are endowed by their Creator with certain inalienable rights; that among these are life, liberty, and the pursuit of happiness; that to secure these rights, governments are instituted among men, deriving their just powers from the consent of the governed; that, whenever any form of government becomes destructive of these ends, it is the right of the people to alter or to abolish it and to institute a new government, laying its foundation on such principles, and organizing its powers in such form, as to them shall seem most likely to effect their safety and happiness. Prudence, indeed, will dictate that governments long established should not be changed for light and transient causes; and, accordingly, all experience hath shown that mankind are more disposed to suffer, while evils are sufferable, than to right themselves by abolishing the forms to which they are accustomed. But, when a long train of abuses and usurpations, pursuing invariably the same object, evinces a design to reduce them under absolute despotism, it is their right, it is their duty, to throw off such government and to provide new guards for their future security. Such has been the patient sufferance of these colonies, and such is now the necessity which constrains them to alter their former systems of government. The history of the present King of Great Britain is a history of repeated injuries and usurpations, all having, in direct object, the establishment of an absolute tyranny over these States. To prove this, let facts be submitted to a candid world: He has refused his assent to laws the most wholesome and necessary for the public good; he has forbidden his governors *to pass laws of immediate and pressing importance, unless suspended in their operation till his assent should be obtained; and,*

Lower case a to z, 12.5 6 ems

ABCDEFGHIJKLMNOPQRSTUVWXYZ

abcdefghijklmnopqrstuvwxyz

ABCDEFGHIJKLMNOPQRSTUVWXYZ

1234567890 1234567890

6 POINT ROMAN No. 599

WHEN, in the course of human events, it becomes necessary for one people to dissolve the political bands which have connected them with another, and to assume, among the powers of the earth, the separate and equal station to which the laws of nature and of nature's God entitle them, a decent respect to the opinions of mankind requires that they should declare the causes which impel them to the separation. We hold these truths to be self-evident: That all men are created equal; that they are endowed by their Creator with certain inalienable rights; that among these are life, liberty, and the pursuit of happiness; that to secure these rights, governments are instituted among men, deriving their just powers from the consent of the governed; that, whenever any form of government becomes destructive of these ends, it is the right of the people to alter or to abolish it and to institute a new government, laying its foundations on such principles, and organizing its powers in such form, as to them shall seem most likely to effect their safety and happiness. Prudence, indeed, will dictate that governments long established should not be changed for light and transient causes; and, accordingly, all experience hath shown that mankind are more disposed to suffer, while evils are sufferable, than to right themselves by abolishing the forms to which they are accustomed. But, when a long train of abuses and usurpations, pursuing invariably the same object, evinces a design to reduce them under

Lower case a to z, 13 1-4 ems
 ABCDEFGHIJKLMNOPQRSTUVWXYZ
 abcdefghijklmnopqrstuvwxyz
 ABCDEFGHIJKLMNOPQRSTUVWXYZ
 1234567890 1234567890

7 POINT ROMAN No. 599

WHEN, in the course of human events, it becomes necessary for one people to dissolve the political bands which have connected them with another, and to assume, among the powers of the earth, the separate and equal station to which the laws of nature and of nature's God entitle them, a decent respect to the opinions of mankind requires that they should declare the causes which impel them to the separation. We hold these truths to be self-evident: That all men are created equal; that they are endowed by their Creator with certain inalienable rights; that among these are life, liberty, and the pursuit of happiness; that to secure these rights, governments are instituted among men, deriving their just powers from the consent of the governed; that, whenever any form of government becomes destructive of these ends, it is the right of the people to alter or to abolish it and to institute a new government, laying its foundations on such principles, and organizing its powers in such form, as to them shall seem most likely to effect their safety and happiness. Prudence, indeed, will dictate to us that governments long established should not be

Lower case a to z, 12 9-14 ems
 ABCDEFGHIJKLMNOPQRSTUVWXYZ
 abcdefghijklmnopqrstuvwxyz
 ABCDEFGHIJKLMNOPQRSTUVWXYZ
 1234567890 1234567890

8 POINT ROMAN No. 599

WHEN, in the course of human events, it becomes necessary for one people to dissolve the political bands which have connected them with another, and to assume, among the powers of the earth, the separate and equal station to which the laws of nature and of nature's God entitle them, a decent respect to the opinions of mankind requires that they should declare the causes which impel them to the separation. We hold these truths to be self-evident: That all men are created equal; that they are endowed by their Creator with certain inalienable rights; that among these are life, liberty, and the pursuit of happiness; that to secure these rights, governments are instituted among men, deriving their just powers from the consent of the governed; that, whenever any form of government becomes destructive of these ends, it is the right of the people to alter or to abolish it and to institute a new government, laying its foundations on such principles, and organizing its powers in such form, as to them shall seem most likely to effect their safety and happiness. Prudence, indeed, will dictate that governments long established should not be changed for light and transient causes; and, accordingly, all experience hath shown that mankind are more disposed to suffer, while evils are sufferable, than to right themselves by abolishing the forms to which they are accustomed. But, when a long train of abuses and usurpations, pursuing invariably the same object, evinces a design to reduce them under absolute despotism, it is their right, it is their duty, to throw off such government and to provide new guards for their future security. Such has been the patient sufferance of these colonies, and such is now the necessity which constrains them to alter their former systems of government. The history of the present *King of Great Britain is a history of repeated injuries and usurpations, all having, in direct object, the establishment of an absolute tyranny over these States. To prove this,*

Lower case a to z, 12 1-8 ems
 ABCDEFGHIJKLMNOPQRSTUVWXYZ
 abcdefghijklmnopqrstuvwxyz
 ABCDEFGHIJKLMNOPQRSTUVWXYZ
 1234567890 1234567890

Partly opened with two point leads

9 POINT ROMAN No. 599

WHEN, in the course of human events, it becomes necessary for one people to dissolve the political bands which have connected them with another, and to assume, among the powers of the earth, the separate and equal station to which the laws of nature and of nature's God entitle them, a decent respect to the opinions of mankind requires that they should declare the causes which impel them to the separation. We hold these truths to be self-evident: That all men are created equal; that they are endowed by their Creator with certain inalienable rights; that among these are life, liberty, and the pursuit of happiness; that, to secure these rights, governments are instituted among men, deriving their just powers from the consent of the governed; that, whenever any form of government becomes destructive of these ends, it is the

Lower case a to z, 12 1/9 ems

ABCDEFGHIJKLMN OPQRSTUVWXYZ
 abcdefghijklmnopqrstuvwxyz
 ABCDEFGHIJKLMN OPQRSTUVWXYZ
 1234567890 1234567890

10 POINT ROMAN No. 599

WHEN, in the course of human events, it becomes necessary for one people to dissolve the political bands which have connected them with another, and to assume, among the powers of the earth, the separate and equal station to which the laws of nature and of nature's God entitle them, a decent respect to the opinions of mankind requires that they should declare the causes which impel them to the separation. We hold these truths to be self-evident: That all men are created equal; that they are endowed by their Creator with certain inalienable rights; that, to secure these rights, governments are instituted among men, deriving their just powers from the consent of the governed;

Lower case a to z, 11 7/10 ems

ABCDEFGHIJKLMN OPQRSTUVWXYZ
 abcdefghijklmnopqrstuvwxyz
 ABCDEFGHIJKLMN OPQRSTUVWXYZ
 1234567890 1234567890

12 POINT ROMAN No. 599

WHEN, in the course of human events, it becomes necessary for one people to dissolve the political bands which have connected them with another, and to assume, among the powers of the earth, the separate and equal station to which the laws of nature and of nature's God entitle them, a decent respect to the opinions of mankind requires that they should declare the causes which impel them to the separation. We hold these truths to be self-evident: That all men are created equal;

Lower case a to z, 10 1/2 ems

ABCDEFGHIJKLMN OPQRSTUVWXYZ
 abcdefghijklmnopqrstuvwxyz
 ABCDEFGHIJKLMN OPQRSTUVWXYZ
 1234567890 1234567890

Partly opened with two point leads

SYNOPSIS OF LINING OLDSTYLE BODY TYPE FACES

Series No.

5 POINT LINING OLDSTYLE

523—When, in the course of human events, it becomes necessary for one people to dissolve the political bands which have
581—When, in the course of human events, it becomes necessary for one people to dissolve the political bands

5½ POINT LINING OLDSTYLE

523—When, in the course of human events, it becomes necessary for one people to dissolve the political banil

6 POINT LINING OLDSTYLE

540—When, in the course of human events, it becomes necessary for one people to dissolve the political bands which ha
552—When, in the course of human events, it becomes necessary for one people to dissolve the political bh
586—When, in the course of human events, it becomes necessary for one people to dissolve the politil
523—When, in the course of human events, it becomes necessary for one people to dissolve the pon
A—When, in the course of human events, it becomes necessary for one people to dissolve the pm
551—When, in the course of human events, it becomes necessary for one people to dissolve the pia
583—When, in the course of human events, it becomes necessary for one people to dissolve the pls
579—When, in the course of human events, it becomes necessary for one people to dissolve theftf
581—When, in the course of human events, it becomes necessary for one people to dissolve thw
550—When, in the course of human events, it becomes necessary for one people to dissolve thes

7 POINT LINING OLDSTYLE

550—When, in the course of human events, it becomes necessary for one people to disso
579—When, in the course of human events, it becomes necessary for one people to dissil
551—When, in the course of human events, it becomes necessary for one people to disil
581—When, in the course of human events, it becomes necessary for one people to dis

8 POINT LINING OLDSTYLE

552—When, in the course of human events, it becomes necessary for one people to dissolv
540—When, in the course of human events, it becomes necessary for one people to dise
586—When, in the course of human events, it becomes necessary for one people tow
A—When, in the course of human events, it becomes necessary for one people to
523—When, in the course of human events, it becomes necessary for one people s
551—When, in the course of human events, it becomes necessary for one peoplen
583—When, in the course of human events, it becomes necessary for one peoplen
579—When, in the course of human events, it becomes necessary for one peoplet
581—When, in the course of human events, it becomes necessary for one peoplit
550—When, in the course of human events, it becomes necessary for one peopls

9 POINT LINING OLDSTYLE

552—When, in the course of human events, it becomes necessary for one people q
583—When, in the course of human events, it becomes necessary for one peop
551—When, in the course of human events, it becomes necessary for one pli
550—When, in the course of human events, it becomes necessary for one g
579—When, in the course of human events, it becomes necessary for one r
581—When, in the course of human events, it becomes necessary for one onq
A—When, in the course of human events, it becomes necessary for one

10 POINT LINING OLDSTYLE

540—When, in the course of human events, it becomes necessary for oneis
552—When, in the course of human events, it becomes necessary for ons
583—When, in the course of human events, it becomes necessary for tz
579—When, in the course of human events, it becomes necessary for it
551—When, in the course of human events, it becomes necessary for o
581—When, in the course of human events, it becomes necessary for s
550—When, in the course of human events, it becomes necessary forp

A—Century Oldstyle

10 POINT LINING OLDSTYLE—Continued

- 523—When, in the course of human events, it becomes necessary fort
 586—When, in the course of human events, it becomes necessary fow
 A—When, in the course of human events, it becomes necessary fr

11 POINT LINING OLDSTYLE

- 540—When, in the course of human events, it becomes necessary for
 551—When, in the course of human events, it becomes necessary ft
 583—When, in the course of human events, it becomes necessary z
 579—When, in the course of human events, it becomes necessartin
 550—When, in the course of human events, it becomes necessarts
 A—When, in the course of human events, it becomes necessart
 581—When, in the course of human events, it becomes necessatl

12 POINT LINING OLDSTYLE

- 551—When, in the course of human events, it becomes necese
 579—When, in the course of human events, it becomes neceii
 A—When, in the course of human events, it becomes necet
 552—When, in the course of human events, it becomes nece
 540—When, in the course of human events, it becomes nece
 586—When, in the course of human events, it becomes nec
 523—When, in the course of human events, it becomesn
 550—When, in the course of human events, it becomesn
 581—When, in the course of human events, it becomeso

14 POINT LINING OLDSTYLE

- 586—When, in the course of human events, it becoe
 A—When, in the course of human events, it becw
 540—When, in the course of human events, it beco
 551—When, in the course of human events, it bees

18 POINT LINING OLDSTYLE

- 523—When, in the course of human events, it b
 552—When, in the course of human events, itt
 579—When, in the course of human events, t
 551—When, in the course of human events, i
 586—When, in the course of human evenc
 A—When, in the course of human event
 540—When, in the course of human event

LINING OLDSTYLE ROMAN FACES SHOWN BY SIZES

5 Point Lining Oldstyle No. 523

WHEN, in the course of human events, it becomes necessary for one people to dissolve the political bands which have connected them with another, and to assume, among the powers of the earth, the separate and equal station to which the laws of nature and of nature's God entitle them, a decent respect to the opinions of mankind requires that they should declare the causes which impel them to the separation. We hold these truths to be self-evident, That all men are created equal; that they are endowed by their Creator with certain inalienable rights, that among these are life, liberty, and the pursuit of happiness; that, to secure these rights, governments are instituted among men, deriving their just powers from the consent of the governed.

Lower case a to z, 14 1-2 ems
 ABCDEFGHIJKLMNOPQRSTUVWXYZ
 1234567890

5½ Point Lining Oldstyle No. 523

WHEN, in the course of human events, it becomes necessary for one people to dissolve the political bands which have connected them with another, and to assume, among the powers of the earth, the separate and equal station to which the laws of nature and of nature's God entitle them, a decent respect to the opinions of mankind requires that they should declare the causes which impel them to the separation. We hold these truths to be self-evident: That all men are created equal; that they are endowed by their Creator with certain inalienable rights; that

Lower case a to z, 14 4-5 ems
 ABCDEFGHIJKLMNOPQRSTUVWXYZ
 1234567890

6 Point Lining Oldstyle No. 523

WHEN, in the course of human events, it becomes necessary for one people to dissolve the political bands which have connected them with another, and to assume, among the powers of the earth, the separate and equal station to which the laws of nature and of nature's God entitle them, a decent respect to the opinions of mankind requires they should declare the causes which impel them to the separation. We hold these truths to be self-evident: That all men are

Lower case a to z, 14 9-12 ems
 ABCDEFGHIJKLMNOPQRSTUVWXYZ
 1234567890

6 Point Oldstyle No. 581

WHEN, in the course of human events, it becomes necessary for one people to dissolve the political bands which have connected them with another, and to assume, among the powers of the earth, the separate and equal station to which the laws of nature and of nature's God entitle them, a decent respect to the opinions of mankind requires that they should declare the causes which impel them to the separation. We hold these truths to be self-evident:

Lower case a to z, 16 ems
 ABCDEFGHIJKLMNOPQRSTUVWXYZ
 1234567890

6 Point Lining Oldstyle No. 550

WHEN, in the course of human events, it becomes necessary for one people to dissolve the political bands which have connected them with another, and to assume, among the powers of the earth, the separate and equal station to which the laws of nature and of nature's God entitle them, a decent respect to the opinions of mankind requires that they should declare the causes which impel them to the separation. We hold these truths to be self-

Lower case a to z, 16 ems
 ABCDEFGHIJKLMNOPQRSTUVWXYZ
 1234567890

5 Point Lining Oldstyle No. 581

WHEN, in the course of human events, it becomes necessary for one people to dissolve the political bands which have connected them with another, and to assume, among the powers of the earth, the separate and equal station to which the laws of nature and of nature's God entitle them, a decent respect to the opinions of mankind requires that they should declare the causes which impel them to the separation. We hold these truths to be self-evident: That all men are created equal; that they are endowed by their Creator with certain inalienable rights; that among these are life, liberty, and the pursuit of happiness; that, to secure these rights, governments are instituted among

Lower case a to z, 15 9-10 ems
 ABCDEFGHIJKLMNOPQRSTUVWXYZ
 1234567890

6 Point Lining Caslon Oldstyle No. 540

WHEN, in the course of human events, it becomes necessary for one people to dissolve the political bands which have connected them with another, and to assume, among the powers of the earth, the separate and equal station to which the laws of nature and of nature's God entitle them, a decent respect to the opinions of mankind requires that they should declare the causes which impel them to the separation. We hold these truths to be self-evident: That all men are created equal; that they are endowed by their Creator with certain inalienable rights; that among these are

Lower case a to z, 12 1-3 ems
 ABCDEFGHIJKLMNOPQRSTUVWXYZ
 1234567890

6 Point Oldstyle No. 583

WHEN, in the course of human events, it becomes necessary for one people to dissolve the political bands which have connected them with another, and to assume, among the powers of the earth, the separate and equal station to which the laws of nature and of nature's God entitle them, a decent respect to the opinions of mankind requires they should declare the causes which impel them to the separation. We hold these truths to be self-evident: That all

Lower case a to z, 15 1-2 ems
 ABCDEFGHIJKLMNOPQRSTUVWXYZ
 1234567890

6 Point Lining Ronaldson Oldstyle No. 551

WHEN, in the course of human events, it becomes necessary for one people to dissolve the political bands which have connected them with another, and to assume, among the powers of the earth, the separate and equal station to which the laws of nature and of nature's God entitle them, a decent respect to the opinions of mankind requires that they should declare the causes which impel them to the separation. We hold these truths to be self-evident:

Lower case a to z, 15 5-6 ems
 ABCDEFGHIJKLMNOPQRSTUVWXYZ
 1234567890

6 Point Recut Caslon No. 586

When, in the course of human events, it becomes necessary for one people to dissolve the political bands which have connected them with another, and to assume, among the powers of the earth, the separate and equal station to which the laws of nature and of nature's God entitle them, a decent respect to the opinions of mankind requires that they should declare the causes which impel them to the separation. We hold these truths to be self-evident: That all men are created equal;

Lower case a to z, 14 13-24 ems
 ABCDEFGHIJKLMNOPQRSTUVWXYZ
 1234567890

LINING OLDSTYLE ROMAN FACES SHOWN BY SIZES

6 Point Oldstyle No. 579

WHEN, in the course of human events, it becomes necessary for one people to dissolve the political bands which have connected them with another, and to assume, among the powers of the earth, the separate and equal station to which the laws of nature and of nature's God entitle them, a decent respect to the opinions of mankind requires that they should declare the causes which impel them to the separation. We hold these truths to be self-evident:

Lower case a to z, 16 ems

ABCDEFGHIJKLMNOPQRSTUVWXYZ
1234567890

6 Point Century Oldstyle

WHEN, in the course of human events, it becomes necessary for one people to dissolve the political bands which have connected them with another, and to assume, among the powers of the earth, the separate and equal station to which the laws of nature and of nature's God entitle them, a decent respect to the opinions of mankind requires that they should declare the causes which impel them to the separation. We hold these truths to be self-evident. That all

Lower case a to z, 16 ems

ABCDEFGHIJKLMNOPQRSTUVWXYZ
1234567890

7 Point Lining Oldstyle No. 550

WHEN, in the course of human events, it becomes necessary for one people to dissolve the political bands which have connected them with another, and to assume, among the powers of the earth, the separate and equal station to which the laws of nature and of nature's God entitle them, a decent respect to the opinions of mankind requires that they should declare the causes which impel them to the separation. We hold these truths to be self-evident: That all men are created equal; that they are endowed by their Creator with certain inalienable rights; that among these are life, liberty, and the pursuit of happiness; that, to secure these rights, governments are instituted among men, deriving their just powers from the consent of the governed; that whenever any form of government becomes destructive of

Lower case a to z, 11 1/3-11 ems

ABCDEFGHIJKLMNOPQRSTUVWXYZ
1234567890

7 Point Lining Ronaldson Oldstyle No. 551

WHEN, in the course of human events, it becomes necessary for one people to dissolve the political bands which have connected them with another, and to assume, among the powers of the earth, the separate and equal station to which the laws of nature and of nature's God entitle them, a decent respect to the opinions of mankind requires that they should declare the causes which impel them to the separation. We hold these truths to be self-evident: That all men are created equal; that they are endowed by their Creator with certain inalienable rights; that among these are life, liberty, and the pursuit of happiness; that, to secure these rights, governments are instituted among men, deriving their just powers from the consent of the governed; that whenever any form of government becomes destructive of

Lower case a to z, 15 ems

ABCDEFGHIJKLMNOPQRSTUVWXYZ
1234567890

7 Point Oldstyle No. 579

WHEN, in the course of human events, it becomes necessary for one people to dissolve the political bands which have connected them with another, and to assume, among the powers of the earth, the separate and equal station to which the laws of nature and of nature's God entitle them, a decent respect to the opinions of mankind requires that they should declare the causes which impel them to the separation. We hold these truths to be self-evident: That all men are created equal; that they are endowed by their Creator with certain inalienable rights; that among these are life, liberty, and the pursuit of happiness; that, to secure these rights, governments are instituted among men, deriving their just powers from the consent of the governed; that whenever any form of government

Lower case a to z, 15 ems

ABCDEFGHIJKLMNOPQRSTUVWXYZ
1234567890

7 Point Oldstyle No. 581

WHEN, in the course of human events, it becomes necessary for one people to dissolve the political bands which have connected them with another, and to assume, among the powers of the earth, the separate and equal station to which the laws of nature and of nature's God entitle them, a decent respect to the opinions of mankind requires that they should declare the causes which impel them to the separation. We hold these truths to be self-evident: That all men are created equal; that they are endowed by their Creator with certain inalienable rights; that among these are life, liberty, and the pursuit of happiness; that, to secure these rights, governments are instituted among men, deriving their just powers from the consent of the governed; that whenever any form of

Lower case a to z, 15 1/2 ems

ABCDEFGHIJKLMNOPQRSTUVWXYZ
1234567890

LINING OLDSTYLE ROMAN FACES SHOWN BY SIZES

8 Point Lining Caslon Oldstyle No. 540

WHEN, in the course of human events, it becomes necessary for one people to dissolve the political bands which have connected them with another, and to assume, among the powers of the earth, the separate and equal station to which the laws of nature and of nature's God entitle them, a decent respect to the opinions of mankind requires that they should declare the causes which impel them to the separation. We hold these truths to be self-evident: That all men are created equal; that they are endowed by their Creator with certain *inalienable rights*; that among these are *life, liberty, and the pursuit of happiness*; that to secure these rights, *governments are instituted among men, deriving their just powers*

Lower case a to z, 12 9-16 ems

ABCDEFGHIJKLMNOPQRSTUVWXYZ
1234567890

8 Point Oldstyle No. 583

WHEN, in the course of human events, it becomes necessary for one people to dissolve the political bands which have connected them with another, and to assume, among the powers of the earth, the separate and equal station to which the laws of nature and of nature's God entitle them, a decent respect to the opinions of mankind requires that they should declare the causes which impel them to the separation. We hold these truths to be self-evident: That all men are created equal; that they are endowed by their Creator with certain inalienable rights; that among these are life, liberty, and the pursuit of happiness; that to secure these rights, governments are instituted

Lower case a to z, 13 7-8 ems

ABCDEFGHIJKLMNOPQRSTUVWXYZ
1234567890

8 Point Oldstyle No. 579

WHEN, in the course of human events, it becomes necessary for one people to dissolve the political bands which have connected them with another, and to assume, among the powers of the earth, the separate and equal station to which the laws of nature and of nature's God entitle them, a decent respect to the opinions of mankind requires that they should declare the causes which impel them to the separation. We hold these truths to be self-evident: That all men are created equal; that they are endowed by their Creator with certain inalienable rights; that among these are life, liberty, and the pursuit of happiness; that to secure these

Lower case a to z, 14 ems

ABCDEFGHIJKLMNOPQRSTUVWXYZ
1234567890

8 Point Oldstyle No. 581

WHEN, in the course of human events, it becomes necessary for one people to dissolve the political bands which have connected them with another, and to assume, among the powers of the earth, the separate and equal station to which the laws of nature and of nature's God entitle them, a decent respect to the opinions of mankind requires that they should declare the causes which impel them to the separation. We hold these truths to be self-evident: That all men are created equal; that they are endowed by their Creator with certain inalienable rights; that among these are life, liberty, and the pursuit of happiness; that to secure these rights

Lower case a to z, 14 1-4 ems

ABCDEFGHIJKLMNOPQRSTUVWXYZ
1234567890

8 Point Lining Oldstyle No. 550

WHEN, in the course of human events, it becomes necessary for one people to dissolve the political bands which have connected them with another, and to assume, among the powers of the earth, the separate and equal station to which the laws of nature and of nature's God entitle them, a decent respect to the opinions of mankind requires that they should declare the causes which impel them to the separation. We hold these truths to be self-evident: That all men are created equal; that they are endowed by their Creator with certain inalienable rights; that among these are life, liberty, and the pursuit of happiness; that to secure these rights,

Lower case a to z, 14 5-16 ems

ABCDEFGHIJKLMNOPQRSTUVWXYZ
1234567890

LINING OLDSTYLE ROMAN FACES SHOWN BY SIZES

8 Point Lining Oldstyle No. 523

WHEN, in the course of human events, it becomes necessary for one people to dissolve the political bands which have connected them with another, and to assume, among the powers of the earth, the separate and equal station to which the laws of nature and nature's God entitle them, a decent respect to the opinions of mankind requires that they should declare the causes which impel them to the separation. We hold these truths to be self-evident: That all men are created equal; that they are endowed by their Creator with certain inalienable rights; that among these are life, liberty, and the pursuit of happiness; that, to secure these rights, governments are

Lower case a to z, 13.3-14 ems

ABCDEFGHIJKLMNOPQRSTUVWXYZ
1234567890

8 Point Lining Ronaldson Oldstyle No. 551

WHEN, in the course of human events, it becomes necessary for one people to dissolve the political bands which have connected them with another, and to assume, among the powers of the earth, the separate and equal station to which the laws of nature and nature's God entitle them, a decent respect to the opinions of mankind requires that they should declare the causes which impel them to the separation. We hold these truths to be self-evident: That all men are created equal; that they are endowed by their Creator with certain inalienable rights; that among these are life, liberty, and the pursuit of happiness; that, to secure these rights, governments are

Lower case a to z, 13.3-16 ems

ABCDEFGHIJKLMNOPQRSTUVWXYZ
1234567890

8 Point Recut Caslon No. 586

When, in the course of human events, it becomes necessary for one people to dissolve the political bands which have connected them with another, and to assume, among the powers of the earth, the separate and equal station to which the laws of nature and of nature's God entitle them, a decent respect to the opinions of mankind requires that they should declare the causes which impel them to the separation. We hold these truths to be self-evident: That all men are created equal; that they are endowed by their Creator with certain inalienable rights; that among these are life, liberty, and the pursuit of happiness; that, to secure these rights, governments are instituted among men,

Lower case a to z, 13.3-16 ems

ABCDEFGHIJKLMNOPQRSTUVWXYZ
1234567890

8 Point Lining French Oldstyle No. 552

WHEN, in the course of human events, it becomes necessary for one people to dissolve the political bands which have connected them with another, and to assume, among the powers of the earth, the separate and equal station to which the laws of nature and of nature's God entitle them, a decent respect to the opinions of mankind requires that they should declare the causes which impel them to the separation. We hold these truths to be self-evident: That all men are created equal; that they are endowed by their Creator with certain inalienable rights; that among these are life, liberty, and the pursuit of happiness; that, to secure these rights, governments are instituted among men, deriving their just powers from the consent of the gov-

Lower case a to z, 12.1-4 ems

ABCDEFGHIJKLMNOPQRSTUVWXYZ
1234567890

8 Point Century Oldstyle

WHEN, in the course of human events, it becomes necessary for one people to dissolve the political bands which have connected them with another, and to assume, among the powers of the earth, the separate and equal station to which the laws of nature and of nature's God entitle them, a decent respect to the opinions of mankind requires that they should declare the causes which impel them to the separation. We hold these truths to be self-evident: That all men are created equal; that they are endowed by their Creator with certain inalienable rights; that among these are life, liberty, and the pursuit of happiness; that, to secure these rights, governments are insti-

Lower case a to z, 13.9-16 ems

ABCDEFGHIJKLMNOPQRSTUVWXYZ
1234567890

LINING OLDSTYLE ROMAN FACES SHOWN BY SIZES

9 Point Lining Oldstyle No. 550

WHEN, in the course of human events, it becomes necessary for one people to dissolve the political bands which have connected them with another, and to assume, among the powers of the earth, the separate and equal station to which the laws of nature and of nature's God entitle them, a decent respect to the opinions of mankind requires that they should declare the *causes which impel them to the separation. We hold these truths to be self-evident: That all men are created equal; that they are endowed by their Creator with cer-*

Lower case a to z, 13 13-18 ems

ABCDEFGHIJKLMNPOQRSTUVWXYZ
1234567890

9 Point Lining Oldstyle No. 579

WHEN, in the course of human events, it becomes necessary for one people to dissolve the political bands which have connected them with another, and to assume, among the powers of the earth, the separate and equal station to which the laws of nature and of nature's God entitle them, a decent respect to the opinions of mankind requires that they should declare the *causes which impel them to the separation. We hold these truths to be self-evident: That all men are created equal; that they are endowed by their Cre-*

Lower case a to z, 13 2-3 ems

ABCDEFGHIJKLMNPOQRSTUVWXYZ
1234567890

9 Point Oldstyle No. 581

WHEN, in the course of human events, it becomes necessary for one people to dissolve the political bands which have connected them with another, and to assume, among the powers of the earth, the separate and equal station to which the laws of nature and of nature's God entitle them, a decent respect to the opinions of mankind requires that they *should declare the causes which impel them to the separation. We hold these truths to be self-evident: That all men are created equal; that they are endowed*

Lower case a to z, 14 1-5 ems

ABCDEFGHIJKLMNPOQRSTUVWXYZ
1234567890

9 Point Lining Ronaldson Oldstyle No. 551

WHEN, in the course of human events, it becomes necessary for one people to dissolve the political bands which have connected them with another, and to assume, among the powers of the earth, the separate and equal station to which the laws of nature and of nature's God entitle them, a decent respect to the opinions of mankind requires that they should declare the *causes which impel them to the separation. We hold these truths to be self-evident: That all men are created equal; that they are endowed by their Creator with*

Lower case a to z, 14 5-9 ems

ABCDEFGHIJKLMNPOQRSTUVWXYZ
1234567890

9 Point Century Oldstyle

WHEN, in the course of human events, it becomes necessary for one people to dissolve the political bands which have connected them with another, and to assume, among the powers of the earth, the separate and equal station to which the laws of nature and of nature's God entitle them, a decent respect to the opinions of mankind requires that they *should declare the causes which impel them to the separation. We hold these truths to be self-evident: That all men are created equal; that they are endowed*

Lower case a to z, 14 1-10 ems

ABCDEFGHIJKLMNPOQRSTUVWXYZ
1234567890

LINING OLDSTYLE ROMAN FACES SHOWN BY SIZES

9 Point Oldstyle No. 583

WHEN, in the course of human events, it becomes necessary for one people to dissolve the political bands which have connected them with another, and to assume, among the powers of the earth, the separate and equal station to which the laws of nature and of nature's God entitle them, a decent respect to the opinions of mankind requires that they should declare the causes which impel them to the separation. We hold these truths to be self-evident: That all men are created equal; that they are endowed by their Creator with certain inalien-

Lower case a to z, 12.8-9 ems.

ABCDEFGHIJKLMN O PQRSTU VWXYZ
1234567890

10 Point Oldstyle No. 583

WHEN, in the course of human events, it becomes necessary for one people to dissolve the political bands which have connected them with another, and to assume, among the powers of the earth, the separate and equal station to which the laws of nature and of nature's God entitle them, a decent respect to the opinions of mankind requires that they should declare the causes which impel them to the separation. We hold these truths to be self-evident: That all men are created equal; that

Lower case a to z, 13 ems.

ABCDEFGHIJKLMN O PQRSTU VWXYZ
1234567890

10 Point Lining Caslon Oldstyle No. 540

WHEN, in the course of human events, it becomes necessary for one people to dissolve the political bands which have connected them with another, and to assume, among the powers of the earth, the separate and equal station to which the laws of nature and of nature's God entitle them, a decent respect to the opinions of mankind requires that they should declare the causes which impel them to the separation. We hold these truths to be self-evident: That all men are created equal; that they are endowed by their Creator with certain

Lower case a to z, 11.3-4 ems.

ABCDEFGHIJKLMN O PQRSTU VWXYZ
1234567890

10 Point Recut Caslon No. 586

When, in the course of human events, it becomes necessary for one people to dissolve the political bands which have connected them with another, and to assume, among the powers of the earth, the separate and equal station to which the laws of nature and of nature's God entitle them, a decent respect for the opinions of mankind requires that they should declare the causes which impel them to the separation. We hold these truths to be self-evident: That all men are

Lower case a to z, 13.3-20 ems.

ABCDEFGHIJKLMN O PQRSTU VWXYZ
1234567890

10 Point Century Oldstyle

WHEN, in the course of human events, it becomes necessary for one people to dissolve the political bands which have connected them with another, and to assume, among the powers of the earth, the separate and equal station to which the laws of nature and of nature's God entitle them, a decent respect to the opinions of mankind requires that they should declare the causes which impel them to the separation. We hold these truths to be self-evident: That all men are

Lower case a to z, 13.4-5 ems.

ABCDEFGHIJKLMN O PQRSTU VWXYZ
1234567890

LINING OLDSTYLE ROMAN FACES SHOWN BY SIZES

10 Point Lining Oldstyle No. 550

WHEN, in the course of human events, it becomes necessary for one people to dissolve the political bands which have connected them with another, and to assume, among the powers of the earth, the separate and equal station to which the laws of nature and of nature's God entitle them, a decent respect to the opinions of mankind requires that they should declare the causes which impel them to the separation. We hold these truths to be self-evident: That all men are created equal;

Lower case a to z, 13 1-5 ems

ABCDEFGHIJKLMNOPQRSTUVWXYZ
1234567890

10 Point Lining Oldstyle No. 523

WHEN, in the course of human events, it becomes necessary for one people to dissolve the political bands which have connected them with another, and to assume, among the powers of the earth, the separate and equal station to which the laws of nature and of nature's God entitle them, a decent respect to the opinions of mankind requires that they should declare the causes which impel them to the separation. We hold these truths to be self-evident: That all men are created

Lower case a to z, 13 1-5 ems

ABCDEFGHIJKLMNOPQRSTUVWXYZ
1234567890

10 Point Oldstyle No. 581

WHEN, in the course of human events, it becomes necessary for one people to dissolve the political bands which have connected them with another, and to assume, among the powers of the earth, the separate and equal station to which the laws of nature and of nature's God entitle them, a decent respect to the opinions of mankind requires that they should declare the causes which impel them to the separation. We hold these truths to be self-evident: That all men are created equal; that they

Lower case a to z, 13 3-20 ems

ABCDEFGHIJKLMNOPQRSTUVWXYZ
1234567890

10 Point Lining Ronaldson Oldstyle No. 551

WHEN, in the course of human events, it becomes necessary for one people to dissolve the political bands which have connected them with another, and to assume, among the powers of the earth, the separate and equal station to which the laws of nature and of nature's God entitle them, a decent respect to the opinions of mankind requires that they should declare the causes which impel them to the separation. We hold these truths to be self-evident: That all men are created equal; that they are

Lower case a to z, 13 ems

ABCDEFGHIJKLMNOPQRSTUVWXYZ
1234567890

10 Point Oldstyle No. 579

WHEN, in the course of human events, it becomes necessary for one people to dissolve the political bands which have connected them with another, and to assume, among the powers of the earth, the separate and equal station to which the laws of nature and of nature's God entitle them, a decent respect to the opinions of mankind requires that they should declare the causes which impel them to the separation. We hold these truths to be self-evident: That all men are created equal; that they

Lower case a to z, 12 9-10 ems

ABCDEFGHIJKLMNOPQRSTUVWXYZ
1234567890

LINING OLDSTYLE ROMAN FACES SHOWN BY SIZES

11 Point Lining Oldstyle No. 550

WHEN, in the course of human events, it becomes necessary for one people to dissolve the political bands which have connected them with another, and to assume, among the powers of the earth, the separate and equal station to which the laws of nature and of nature's God entitle them, a decent respect to the opinions of mankind requires that they should declare the causes which impel them to the

Lower case a to z, 12 s-11 ems

ABCDEFGHIJKLMN O PQRSTU VWXYZ
1234567890

11 Point Oldstyle No. 581

WHEN, in the course of human events, it becomes necessary for one people to dissolve the political bands which have connected them with another, and to assume, among the powers of the earth, the separate and equal station to which the laws of nature and of nature's God entitle them, a decent respect to the opinions of mankind requires that they should declare the causes which im-

Lower case a to z, 13 ems

ABCDEFGHIJKLMN O PQRSTU VWXYZ
1234567890

11 Point Oldstyle No. 579

WHEN, in the course of human events, it becomes necessary for one people to dissolve the political bands which have connected them with another, and to assume, among the powers of the earth, the separate and equal station to which the laws of nature and of nature's God entitle them, a decent respect to the opinions of mankind requires that they should declare the causes which impel them

Lower case a to z, 12 s-11 ems

ABCDEFGHIJKLMN O PQRSTU VWXYZ
1234567890

11 Point Oldstyle No. 583

WHEN, in the course of human events, it becomes necessary for one people to dissolve the political bands which have connected them with another, and to assume, among the powers of the earth, the separate and equal station to which the laws of nature and of nature's God entitle them, a decent respect to the opinions of mankind requires that they should declare the causes which impel

Lower case a to z, 12 s-3 ems

ABCDEFGHIJKLMN O PQRSTU VWXYZ
1234567890

11 Point Century Oldstyle

WHEN, in the course of human events, it becomes necessary for one people to dissolve the political bands which have connected them with another, and to assume, among the powers of the earth, the separate and equal station to which the laws of nature and of nature's God entitle them, a decent respect to the opinions of mankind requires that they should declare the causes which impel

Lower case a to z, 13 s-11 ems

ABCDEFGHIJKLMN O PQRSTU VWXYZ
1234567890

LINING OLDSTYLE ROMAN FACES SHOWN BY SIZES

11 Point Lining Caslon Oldstyle No. 540

WHEN, in the course of human events, it becomes necessary for one people to dissolve the political bands which have connected them with another, and to assume, among the powers of the earth, the separate and equal station to which the laws of nature and of nature's *God entitle them, a decent respect to the opinions of mankind requires that they should declare the causes which impel them to the separation. We hold*

Lower case a to z, 12 2-11 ems

ABCDEFGHIJKLMNOPQRSTUVWXYZ
1234567890

11 Point Lining Ronaldson Oldstyle No. 551

WHEN, in the course of human events, it becomes necessary for one people to dissolve the political bands which have connected them with another, and to assume, among the powers of the earth, the separate and equal station to which the laws of nature and of *nature's God entitle them, a decent respect to the opinions of mankind requires that they should declare the causes which impel them*

Lower case a to z, 12 6-11 ems

ABCDEFGHIJKLMNOPQRSTUVWXYZ
1234567890

12 Point Lining Ronaldson Oldstyle No. 551

WHEN, in the course of human events, it becomes necessary for one people to dissolve the political bands which have connected them with another, and to assume, among the powers of the earth, the separate and equal station to which the laws of *nature and of nature's God entitle them, a decent respect to*

Lower case a to z, 12 11-24 ems

ABCDEFGHIJKLMNOPQRSTUVWXYZ
1234567890

12 Point Lining Caslon Oldstyle No. 540

WHEN, in the course of human events, it becomes necessary for one people to dissolve the political bands which have connected them with another, and to assume, among the powers of the earth, the separate and equal station to which *the laws of nature and of nature's God entitle them, a decent re-*

Lower case a to z, 12 21-24 ems

ABCDEFGHIJKLMNOPQRSTUVWXYZ
1234567890

12 Point Oldstyle No. 579

WHEN, in the course of human events, it becomes necessary for one people to dissolve the political bands which have connected them with another, and to assume, among the powers of the earth, the separate and equal station to which the laws of *nature and of nature's God entitle them, a decent respect to*

Lower case a to z, 12 5-8 ems

ABCDEFGHIJKLMNOPQRSTUVWXYZ
1234567890

LINING OLDSTYLE ROMAN FACES SHOWN BY SIZES

12 Point Lining Oldstyle No. 550

WHEN, in the course of human events, it becomes necessary for one people to dissolve the political bands which have connected them with another, and to assume, among the powers of the earth, the separate and equal station to which the laws of nature and of nature's God entitle

Lower case a to z, 11.1-6 ems

ABCDEFGHIJKLMNOPQRSTUVWXYZ
1234567890

12 Point Lining Oldstyle No. 523

WHEN, in the course of human events, it becomes necessary for one people to dissolve the political bands which have connected them with another, and to assume, among the powers of the earth, the separate and equal station to which the laws of nature and of nature's God

Lower case a to z, 11 ems

ABCDEFGHIJKLMNOPQRSTUVWXYZ
1234567890

12 Point Oldstyle No. 581

WHEN, in the course of human events, it becomes necessary for one people to dissolve the political bands which have connected them with another, and to assume, among the powers of the earth, the separate and equal station to which the laws of nature and of nature's God

Lower case a to z, 11.5-12 ems

ABCDEFGHIJKLMNOPQRSTUVWXYZ
1234567890

12 Point Recut Caslon No. 586

When, in the course of human events, it becomes necessary for one people to dissolve the political bands which have connected them with another, and to assume, among the powers of the earth, the separate and equal station to which the laws of nature and of nature's God entitle them, a decent

Lower case a to z, 12.11-12 ems

ABCDEFGHIJKLMNOPQRSTUVWXYZ
1234567890

12 Point Century Oldstyle

WHEN, in the course of human events, it becomes necessary for one people to dissolve the political bands which have connected them with another, and to assume, among the powers of the earth, the separate and equal station to which the laws of nature and of nature's God entitle them, a decent

Lower case a to z, 12.3-4 ems

ABCDEFGHIJKLMNOPQRSTUVWXYZ
1234567890

LINING OLDSTYLE ROMAN FACES SHOWN BY SIZES

11 Point Lining Caslon Oldstyle No. 540

WHEN, in the course of human events, it becomes necessary for one people to dissolve the political bands which have connected them with another, *and to assume, among the powers of the earth, the sepa-*

Lower case a to z, 13 1-14 ems
ABCDEFGHIJKLMNOPQRSTUVWXYZ
1234567890

14 Point Recut Caslon No. 586

When, in the course of human events, it becomes necessary for one people to dissolve the political bands which have connected them with another, *and to assume, among the powers of the earth, the sepa-*

Lower case a to z, 12 9-14 ems
ABCDEFGHIJKLMNOPQRSTUVWXYZ
1234567890

14 Point Lining Ronaldson Oldstyle No. 551

WHEN, in the course of human events, it becomes necessary for one people to dissolve the political bands which have connected them with another, and to assume, among the powers of the earth, the

Lower case a to z, 13 5-14 ems
ABCDEFGHIJKLMNOPQRSTUVWXYZ
1234567890

14 Point Century Oldstyle

WHEN, in the course of human events, it becomes necessary for one people to dissolve the political bands which have connected them with another, *and to assume, among the powers of the earth, the*

Lower case a to z, 13 1-7 ems
ABCDEFGHIJKLMNOPQRSTUVWXYZ
1234567890

18 Point Lining Oldstyle No. 579

When, in the course of human events, it becomes necessary for one people to dissolve the political bands which have connected

Lower case a to z, 11 7-9 ems
ABCDEFGHIJKLMNOPQRSTUVWXYZ
1234567890

18 Point Lining Oldstyle No. 523

WHEN, in the course of human events, it becomes necessary for one people to dissolve the *political bands which have connected them*

Lower case a to z, 10 17-18 ems

ABCDEFGHIJKLMN OPQRSTUVWXYZ
1234567890

18 Point Lining Ronaldson Oldstyle No. 551

When, in the course of human events, it becomes necessary for one people to dissolve the political bands which have connected

Lower case a to z, 12 17-18 ems

ABCDEFGHIJKLMN OPQRSTUVWXYZ
1234567890

18 Point Lining Caslon Oldstyle No. 540

WHEN, in the course of human events, it becomes necessary for one people to *dissolve the political bands which have con-*

Lower case a to z, 12 13-18 ems

ABCDEFGHIJKLMN OPQRSTUVWXYZ
1234567890

18 Point Recut Caslon No. 586

When, in the course of human events, it becomes necessary for one people to *dissolve the political bands which have con-*

Lower case a to z, 12 25-36 ems

ABCDEFGHIJKLMN OPQRSTUVWXYZ
1234567890

18 Point Century Oldstyle

WHEN, in the course of human events, it becomes necessary for one people to *dissolve the political bands which have*

Lower case a to z, 12 8-9 ems

ABCDEFGHIJKLMN OPQRSTUVWXYZ
1234567890

Century Oldstyle

6 POINT CENTURY OLDSTYLE

WHEN, in the course of human events, it becomes necessary for one people to dissolve the political bands which have connected them with another, and to assume, among the powers of the earth, the separate and equal station to which the laws of nature and of nature's God entitle them, a decent respect to the opinions of mankind requires that they should declare the causes which impel them to the separation. We hold these truths to be self-evident: That all men are created equal; that they are endowed by their Creator with certain inalienable rights; that among these are life, liberty, and the pursuit of happiness; that to secure these rights, governments are instituted among men, deriving their just powers from the consent of the governed; that, whenever any form of government becomes destructive of these ends, it is the right of the people to alter or abolish it and to institute a new government, laying its foundations on such principles, and organizing its powers in such form, as to them shall seem most likely to effect their safety and happiness. Prudence, indeed, will dictate that governments long established should not be changed for light and transient causes; and, accordingly, all experience hath shown that mankind are more disposed to suffer, while evils are sufferable, than to right themselves by abolishing the forms to which they are accustomed. But, when a long train of abuses and usurpations, pursuing invariably the same object, evinces a design to reduce them under absolute despotism, it is their right, it is their duty, to throw off such government and to provide new guards for their future security. Such has been the patient sufferance of these colonies, and such is now the necessity which constrains them to alter their former systems of government. The history of the present King of Great Britain is a history of repeated injuries and usurpations, all having, in direct object, the establishment of an absolute tyranny over these States. To prove this, let facts be given to a candid world: He has refused his assent to laws the most wholesome and necessary for the public good; he has forbidden his governors to pass laws of immediate and pressing importance, unless suspended in their operation till his assent should be obtained; and, when so suspended, he has utterly neglected to attend to them; he has refused to pass other laws for the accommodation of large districts of people, unless these people would relinquish the right of representation in the legislature; a right inestimable to them, and formidable to tyrants only; he has called together legislative bodies at places unusual, uncomfortable, and distant from the depository of their public records, for the sole purpose of fatiguing them into compliance with his measures; he has dissolved representative houses repeatedly, for opposing, with manly firmness, his invasions on the rights of the people; he has refused, for a long time after

Lower case a to z, 15 2-5 ems

ABCDEFGHIJKLMNOPQRSTUVWXYZ

abcdefghijklmnopqrstuvwxyz

ABCDEFGHIJKLMNOPQRSTUVWXYZ

1234567890 1234567890

8 POINT CENTURY OLDSTYLE

WHEN, in the course of human events, it becomes necessary for one people to dissolve the political bands which have connected them with another, and to assume, among the powers of the earth, the separate and equal station to which the laws of nature and of nature's God entitle them, a decent respect to the opinions of mankind requires that they should declare the causes which impel them to the separation. We hold these truths to be self-evident: That all men are created equal; that they are endowed by their Creator with certain inalienable rights; that among these are life, liberty, and the pursuit of happiness; that to secure these rights, governments are instituted among men, deriving their just powers from the consent of the governed; that, whenever any form of government becomes destructive of these ends, it is the right of the people to alter or to abolish it and to institute a new government, laying its foundation on such principles, and organizing its powers in such form, as to them shall seem most likely to effect their safety and happiness. Prudence, indeed, will dictate that governments long established should not be changed for light and transient causes; and, accordingly, all experience hath shown that mankind are more disposed to suffer, while evils are sufferable, than to right themselves by abolishing the forms to which they are accustomed. But, when a long train of abuses and usurpations, pursuing invariably the same object, evinces a design to reduce them under absolute despotism, it is their right, it is their duty, to throw off such government and to provide new guards for their future security. Such has been the patient sufferance of these colonies, and such is now the necessity which constrains them to alter their former systems of government.

Lower case a to z, 13 9-16 ems

ABCDEFGHIJKLMNOPQRSTUVWXYZ

abcdefghijklmnopqrstuvwxyz

ABCDEFGHIJKLMNOPQRSTUVWXYZ

1234567890 1234567890

Century Oldstyle

9 POINT CENTURY OLDSTYLE

WHEN, in the course of human events, it becomes necessary for one people to dissolve the political bands which have connected them with another, and to assume, among the powers of the earth, the separate and equal station to which the laws of nature and of nature's God entitle them, a decent respect to the opinions of mankind requires that they should declare the causes which impel them to the separation. We hold these truths to be self-evident: That all men are created equal; that they are endowed by their Creator with certain inalienable rights; that among these are life, liberty, and the pursuit of happiness; that, to secure these rights, governments are instituted among men, deriving their just powers from the consent of the governed; that, whenever any form of government becomes destructive of these ends, it is the right of the people to alter or to abolish it and to institute a new government, laying its foundation on such principles, and organizing its powers in such form, as to them shall seem most likely to effect their safety and happiness. Prudence, indeed, will dictate that governments long established should not be changed for light and transient causes; and, accordingly, all experience hath shown that mankind are more disposed *to suffer, while evils are sufferable, than to right themselves by abolishing the forms to which they are accustomed. But, when a long train of abuses and*

Lower case a to z, 11.1 10 ems

ABCDEFGHIJKLMNOPQRSTUVWXYZ
abcdefghijklmnopqrstuvwxyz
ABCDEFGHIJKLMNOPQRSTUVWXYZ
1234567890 1234567890

10 POINT CENTURY OLDSTYLE No. 2

WHEN, in the course of human events, it becomes necessary for one people to dissolve the political bands which have connected them with another, and to assume, among the powers of the earth, the separate and equal station to which the laws of nature and of nature's God entitle them, a decent respect to the opinions of mankind requires that they should declare the causes which impel them to the separation. We hold these truths to be self-evident: That all men are created equal; that they are endowed by their Creator with certain inalienable rights; that among these are life, liberty, and the pursuit of happiness; that, to secure these rights, governments are instituted among men, deriving their just powers from the consent of the governed; that, whenever any form of government becomes destructive of these ends, it is the right of the people to alter or to abolish it and to institute a new government, laying its foundations on such principles, and organizing its powers in such form, as to them shall seem most likely to effect their safety and happiness. Prudence, indeed, will dictate that governments long established should not be changed for light and transient causes; and, *accordingly, all experience hath shown that mankind are more disposed to suffer, while evils are sufferable, than to right themselves by abolishing the*

Lower case a to z, 12.1 11 ems

ABCDEFGHIJKLMNOPQRSTUVWXYZ
abcdefghijklmnopqrstuvwxyz
ABCDEFGHIJKLMNOPQRSTUVWXYZ
1234567890 1234567890

Century Oldstyle

10 POINT CENTURY OLDSTYLE

WHEN, in the course of human events, it becomes necessary for one people to dissolve the political bands which have connected them with another, and to assume, among the powers of the earth, the separate and equal station to which the laws of nature and of nature's God entitle them, a decent respect to the opinions of mankind requires that they should declare the causes which impel them to the separation. We hold these truths to be self-evident: That all men are created equal; that they are endowed by their Creator with certain inalienable rights; that among these are life, liberty, and the pursuit of happiness; that to secure these rights, governments are instituted among men, deriving their just powers from the consent of the governed; that, whenever any form of government becomes destructive of these ends, it is the right of the people to alter or to abolish it and to institute a new government, laying its foundations on such principles, and organizing its powers in such form, as to them shall seem most likely to effect their safety and happiness. *Prudence, indeed, will dictate that governments*

Lower case a to z, 13 4-5 ems

ABCDEFGHIJKLMN OPQRSTUVWXYZ
abcdefghijklmno pqrstuvwxyz
ABCDEFGHIJKLMN OPQRSTUVWXYZ
1234567890 1234567890

11 POINT CENTURY OLDSTYLE

WHEN, in the course of human events, it becomes necessary for one people to dissolve the political bands which have connected them with another, and to assume, among the powers of the earth, the separate and equal station to which the laws of nature and of nature's God entitle them, a decent respect to the opinions of mankind requires that they should declare the causes which impel them to the separation. We hold these truths to be self-evident: That all men are created equal; that they are endowed by their Creator with certain inalienable rights; that among these are life, liberty, and the pursuit of happiness; that to secure these rights, governments are instituted among men, deriving their just powers from the consent of the governed; that, whenever any form of government becomes destructive of these ends, it is the right of the people to alter or to abolish it, and to institute a new government, laying its foundations on such principles, and organizing its powers in such

Lower case a to z, 13 2-11 ems

ABCDEFGHIJKLMN OPQRSTUVWXYZ
abcdefghijklmno pqrstuvwxyz
ABCDEFGHIJKLMN OPQRSTUVWXYZ
1234567890 1234567890

Century Oldstyle

12 POINT CENTURY OLDSTYLE

WHEN, in the course of human events, it becomes necessary for one people to dissolve the political bands which have connected them with another, and to assume, among the powers of the earth, the separate and equal station to which the laws of nature and of nature's God entitle them, a decent respect to the opinions of mankind requires that they should declare the causes which impel them to the separation. We hold these truths to be self-evident: That all men are created equal; that they are endowed by their Creator with certain inalienable rights; that among these are life, liberty, and the pursuit of happiness; that to secure these rights, governments are instituted among men, deriving their just powers from the consent of the governed; that whenever any form of government becomes destructive of these ends, it is the right of the people to alter or to abolish it and to institute a new government, laying its foundations on such principles and organizing its powers in such form as to them shall seem most likely to effect their safety and happiness. Prudence, indeed, will dictate that governments long established should not be changed for light and transient causes; and, accordingly, all experience hath shown that mankind are more disposed to suffer, while evils are sufferable, than to right themselves by abolishing the forms to which they are accustomed. But when a long train of abuses and usurpations, pursuing invariably the same object, evinces a design to reduce them under absolute despotism, it is their right, it is their duty, to throw off such government and to provide new guards for their future security. Such has been the patient sufferance of these colonies, and such is now the necessity which constrains them to alter their former systems of government. The history of the present King of Great Britain is a history of repeated injuries and usurpations, all having, in direct object, the establishment of an absolute tyranny over these States. To prove this, let facts be submitted to a candid world: He has refused his consent to laws the most wholesome and necessary for the public good; *he has forbidden his governors to pass laws of immediate and pressing importance, unless suspended in their operation till*

Lower case a to z, 12 19-24 ems

ABCDEFGHIJKLMNOPQRSTUVWXYZ

abcdefghijklmnopqrstuvwxyz

ABCDEFGHIJKLMNOPQRSTUVWXYZ

1234567890 1234567890

Century Oldstyle

14 POINT CENTURY OLDSTYLE

WHEN, in the course of human events, it becomes necessary for one people to dissolve the political bands which have connected them with another, and to assume, among the powers of the earth, the separate and equal station to which the laws of nature and of nature's God entitle them, a decent respect to the opinions of mankind requires that they should declare the causes which impel them to the separation. We hold these truths to be self-evident: That all men are created equal; that they are endowed by their Creator with certain inalienable rights; that among these are life, liberty, and the pursuit of happiness; that to secure these rights, governments are instituted among men, deriving their just powers from the consent of the governed; that, whenever any form of government becomes destructive of these ends, it is the right of the people to alter or to abolish it and to institute a new government, laying its foundations on such principles, and organizing its powers in such form, as to them shall seem most likely to effect their safety and happiness. Prudence, indeed, will dictate that governments long established should not be changed for light and transient causes; and, accordingly, all experience hath shown that mankind are more disposed to suffer, while evils are sufferable, than to right themselves by abolishing the forms to which they are accustomed. But, when a long train of abuses and usurpations, pursuing invariably the same object, evinces a design to reduce them under absolute despotism, it is their right, it is their duty, to throw off such govern-

Lower case a to z, 13 1-7 ems

ABCDEFGHIJKLMNOPQRSTUVWXYZ

abcdefghijklmnopqrstuvwxyz

ABCDEFGHIJKLMNOPQRSTUVWXYZ

1234567890 1234567890

18 POINT CENTURY OLDSTYLE

WHEN, in the course of human events, it becomes necessary for one people to dissolve the political bands which have connected them with another, and to assume, among the powers of the earth, the separate and equal station to which the laws of nature and of nature's God entitle them, a decent respect for the opinions of mankind requires that they should declare the causes which impel them to the separation. We hold these truths to be self-evident: That all men are created equal; that they are endowed by their Creator with certain inalienable rights; that among these are life, liberty, and the pursuit of happiness; that, to secure these rights, governments are instituted among men, deriving their just powers from the consent of the governed; that, whenever any form of government becomes destructive of these ends, it is the right of the people to alter or to abolish *it and to institute a new government, laying its foundations on such principles*

Lower case a to z, 12 5/9 ems

ABCDEFGHIJKLMN OPQRSTUVWXYZ

abcdefghijklmnopqrstuvwxy z

ABCDEFGHIJKLMN OPQRSTUVWXYZ

1234567890 1234567890

Lining Caslon Oldstyle No. 540

6 POINT LINING CASLON OLDSTYLE NO. 540

WHEN, in the course of human events, it becomes necessary for one people to dissolve the political bands which have connected them with another, and to assume, among the powers of the earth, the separate and equal station to which the laws of nature and of nature's God entitle them, a decent respect to the opinions of mankind requires that they should declare the causes which impel them to the separation. We hold these truths to be self-evident: That all men are created equal; that they are endowed by their Creator with certain inalienable rights; that among these are life, liberty, and the pursuit of happiness; that, to secure these rights, governments are instituted among men, deriving their just powers from the consent of the governed; that, whenever any form of government becomes destructive of these ends, it is the right of the people to alter or to abolish it and to institute a new government, laying its foundations on such principles, and organizing its powers in such form, as to them shall seem most likely to effect their safety and happiness. Prudence, indeed, will dictate that governments long established should not be changed for light and transient causes; and, accordingly, all experience hath shown that mankind are more disposed to suffer, while evils are sufferable, than to right themselves by abolishing the forms to which they are accustomed. But, when a long train of abuses and usurpations, pursuing invariably the same object, evinces a design to reduce them under absolute despotism, it is their right, it is their duty, to throw off such government and to provide new guards for their future security. Such has been the patient sufferance of these colonies, and such is now the necessity which constrains them to alter their former systems of government. The history of the present King of Great Britain is a history of repeated injuries and usurpations, all having, in direct object, the establishment of an absolute tyranny over these States. To prove this, let facts be submitted to a candid world: He has refused his assent to laws the most wholesome and necessary for the public good; he has forbidden his governors to pass laws of immediate and pressing importance, unless suspended in their operation till his assent should be obtained; and, when so suspended, he has utterly neglected to attend to them; he has refused to pass other laws for the accommodation of large districts of people, unless those people would relinquish the right of representation in the legislature; a right inestimable to them, and formidable to tyrants only; he has called together legislative bodies at places unusual, uncomfortable, and distant from the depository of their public records, for the sole purpose of fatiguing them into compliance with his measures; he has dissolved representative houses repeatedly, for opposing, with manly firmness, his invasions on the rights of the people; he has refused, for a long time after such dissolutions, to cause others to be elected; whereby the legislative powers, incapable of annihilation, have returned to the people at large for their exercise; the state remaining, in the meantime, exposed to all the danger of invasion from without, and convulsions within; he has endeavored to prevent the population of these States, for that purpose obstructing the laws for naturalization of foreigners, refusing to pass others to encourage their migration hither, and raising the conditions of new appropriations of lands; he has obstructed the administration of justice, by refusing his assent to laws for establishing judiciary powers; he has made judges dependent on his will alone for the tenure of their offices, and the amount and payment of their salaries; he has created a multitude of new offices, and sent hither swarms of officers to harass our

Lower case a to z, 12 1-3 ems

ABCDEFGHIJKLMN O PQRSTU VWXYZ

abcdefghijklmnopqrstuvwxyz

ABCDEFGHIJKLMN O PQRSTU VWXYZ

1234567890 1234567890

8 POINT LINING CASLON OLDSTYLE NO. 540

WHEN, in the course of human events, it becomes necessary for one people to dissolve the political bands which have connected them with another, and to assume, among the powers of the earth, the separate and equal station to which the laws of nature and of nature's God entitle them, a decent respect to the opinions of mankind requires that they should declare the causes which impel them to the separation. We hold these truths to be self-evident: That all men are created equal; that they are endowed by their Creator with certain inalienable rights; that among these are life, liberty, and the pursuit of happiness; that, to secure these rights, governments are instituted among men, deriving their just powers from the consent of the governed; that, whenever any form of government becomes destructive of these ends, it is the right of the people to alter or to abolish it and to institute a new government, laying its foundations on such principles, and organizing its powers in such form, as to them shall seem most likely to effect their safety and happiness. Prudence, indeed, will dictate that governments long established should not be changed for light and transient causes; and, accordingly, all experience hath shown that mankind are more disposed to suffer, while evils are sufferable, than to right themselves by abolishing the forms to which they are accustomed. But, when a long train of abuses and usurpations, pursuing invariably the same object, evinces a design to reduce them under absolute despotism, it is their right, it is their duty, to throw off such government and to provide new guards for their future security. Such has been the patient sufferance, of these colonies, and such is now the necessity which constrains them to alter their former systems of government. The history of the present King of Great Britain is a history of repeated injuries and usurpations, all having, in direct object, the establishment of an absolute tyranny

Lower case a to z, 12 9-16 ems

ABCDEFGHIJKLMN O PQRSTU VWXYZ

abcdefghijklmnopqrstuvwxyz

ABCDEFGHIJKLMN O PQRSTU VWXYZ

1234567890 1234567890

Lining Caslon Oldstyle No. 540

10 POINT LINING CASLON OLDSTYLE No. 540

WHEN, in the course of human events, it becomes necessary for one people to dissolve the political bands which have connected them with another, and to assume, among the powers of the earth, the separate and equal station to which the laws of nature and of nature's God entitle them, a decent respect to the opinions of mankind requires that they should declare the causes which impel them to the separation. We hold these truths to be self-evident: That all men are created equal; that they are endowed by their Creator with certain inalienable rights; that among these are life, liberty, and the pursuit of happiness; that, to secure these rights, governments are instituted among men, deriving their just powers from the consent of the governed; that whenever any form of government becomes destructive of these ends, it is the right of the people to alter or to abolish it and to institute a new government, laying its foundations on such principles, and organizing its powers in such form, as to them shall seem most likely to effect their safety and happiness. Prudence, indeed, will dictate that governments long established should not be changed for light and transient causes; and, accordingly, all experience *hath shown that mankind are more disposed to suffer, while evils are sufferable, than to right themselves by abolishing the forms to which they are accustomed. But, when*

Lower case a to z, 11 3/4 ems

ABCDEFGHIJKLMN OPQRSTUVWXYZ
 abcdefghijklmnopqrstuvwxyz
 ABCDEFGHIJKLMN OPQRSTUVWXYZ
 1234567890 1234567890

11 POINT LINING CASLON OLDSTYLE No. 540

WHEN, in the course of human events, it becomes necessary for one people to dissolve the political bands which have connected them with another, and to assume, among the powers of the earth, the separate and equal station to which the laws of nature and of nature's God entitle them, a decent respect to the opinions of mankind requires that they should declare the causes which impel them to the separation. We hold these truths to be self-evident: That all men are created equal; that they are endowed by their Creator with certain inalienable rights; that among these are life, liberty, and the pursuit of happiness; that, to secure these rights, governments are instituted among men, deriving their just powers from the consent of the governed; that, whenever any form of government becomes destructive of these ends, it is the right of the people to alter or to abolish it and to institute a new government, laying its foundations on such principles, and organizing its powers in such form, as to them shall seem most likely to effect their safety and happiness. Prudence, indeed, will

Lower case a to z, 12 2/11 ems

ABCDEFGHIJKLMN OPQRSTUVWXYZ
 abcdefghijklmnopqrstuvwxyz
 ABCDEFGHIJKLMN OPQRSTUVWXYZ
 1234567890 1234567890

Lining Caslon Oldstyle No. 540

12 POINT LINING CASLON OLDSTYLE No. 540

WHEN, in the course of human events, it becomes necessary for one people to dissolve the political bands which have connected them with another, and to assume, among the powers of the earth, the separate and equal station to which the laws of nature and of nature's God entitle them, a decent respect to the opinions of mankind requires that they should declare the causes which impel them to the separation. We hold these truths to be self-evident: That all men are created equal; that they are endowed by their Creator with certain inalienable rights; that among these are life, liberty, and the pursuit of happiness; that, to secure these rights, governments are instituted among men, deriving their just powers *from the consent of the governed; that, whenever any form of government becomes destructive of these ends, it is the right of the*

Lower case a to z, 12 11-12 ems

ABCDEFGHIJKLMNOPQRSTUVWXYZ

abcdefghijklmnopqrstuvwxyz

ABCDEFGHIJKLMNOPQRSTUVWXYZ

1234567890 1234567890

14 POINT LINING CASLON OLDSTYLE No. 540

WHEN, in the course of human events, it becomes necessary for one people to dissolve the political bands which have connected them with another, and to assume, among the powers of the earth, the separate and equal station to which the laws of nature and of nature's God entitle them, a decent respect to the opinions of mankind requires that they should declare the causes which impel them to the separation. We hold these truths to be self-evident: That all men are created equal; that they *are endowed by their Creator with certain inalienable rights; that among these are life, liberty, and the pur-*

Lower case a to z, 13 1-14 ems

ABCDEFGHIJKLMNOPQRSTUVWXYZ

abcdefghijklmnopqrstuvwxyz

ABCDEFGHIJKLMNOPQRSTUVWXYZ

1234567890 1234567890

18 POINT LINING CASLON OLDSTYLE NO. 540

WHEN, in the course of human events, it becomes necessary for one people to dissolve the political bands which have connected them with another, and to assume, among the powers of the earth, the separate and equal station to which the laws of nature and of nature's God entitle them, a decent respect to the opinions of mankind requires that they should declare the causes which impel them to the separation. We hold these truths to be self-evident: That all men are created equal; that they are endowed by their Creator with certain inalienable rights; that among these are life, liberty, and the pursuit of happiness; that, to secure these rights, governments are instituted among men, deriving their just powers from the consent of the governed; that, whenever any form of government becomes destructive of these ends, it is the right of the people to alter or to abolish it and to *institute a new government, laying its foundations on such principles, and organizing*

Lower case a to z, 12 13 18 ems

ABCDEFGHIJKLMN OPQRSTU V

abcdefghijklmnopqrstuvwxyz

ABCDEFGHIJKLMN OPQRSTU VWXYZ

1234567890 1234567890

Recut Caslon No. 586

6 POINT RECUT CASLON No. 586

When, in the course of human events, it becomes necessary for one people to dissolve the political bands which have connected them with another, and to assume, among the powers of the earth, the separate and equal station to which the laws of nature and of nature's God entitle them, a decent respect to the opinions of mankind requires that they should declare the causes which impel them to the separation. We hold these truths to be self-evident: That all men are created equal; that they are endowed by their Creator with certain inalienable rights; that among these are life, liberty, and the pursuit of happiness; that to secure these rights, governments are instituted among men, deriving their just powers from the consent of the governed; that, whenever any form of government becomes destructive of these ends, it is the right of the people to alter or to abolish it and to institute a new government, laying its foundation on such principles, and organizing its powers in such form, as to them shall seem most likely to effect their safety and happiness. Prudence, indeed, will dictate that governments long established should not be changed for light and transient causes; and, accordingly, all experience hath shown that mankind are more disposed to suffer, while evils are sufferable, than to right themselves by abolishing the forms to which they are accustomed. But, when a long train of abuses and usurpations, pursuing invariably the same object, evinces a design to reduce them under absolute despotism, it is their right, it is their duty, to throw off such government and to provide new guards for their future security. Such has been the patient sufferance of these colonies, and such is now the necessity which constrains them to alter their former systems of government. The history of the present King of Great Britain is a history of repeated injuries and usurpations, all having, in direct object, the establishment of an absolute tyranny over these States. To prove this, let facts be submitted to a candid world: He has refused his assent to laws the most wholesome and necessary for the public good; he has forbidden his governors to pass laws of immediate and pressing importance, unless suspended in their operation till his assent should be obtained; and, when so suspended, he has utterly neglected to attend to them; he has refused to pass other laws for the accommodation of large districts of people, unless those people would relinquish the right of representation in the legislature; a right inestimable to them, and formidable to tyrants only; he has called together legislative bodies at places unusual, uncomfortable, and distant from the depository of their public records, for the sole purpose of fatiguing them into compliance with his measures; he has dissolved representative houses repeatedly, *for opposing, with manly firmness, his incursions on the rights of the people; he has refused, for a long time after such dissolutions, to cause others to be elected; whereby the legislative powers, incapable of*

Lower case a to z, 14 13-24 ems

ABCDEF GHIJKL MNOPQRST UVWXYZ
 abcdefghijklmnopqrstuvwxy z
 ABCDEF GHIJKL MNOPQRST UVWXYZ
 1234567890 1234567890

8 POINT RECUT CASLON No. 586

When, in the course of human events, it becomes necessary for one people to dissolve the political bands which have connected them with another, and to assume, among the powers of the earth, the separate and equal station to which the laws of nature and of nature's God entitle them, a decent respect to the opinions of mankind requires that they should declare the causes which impel them to the separation. We hold these truths to be self-evident: That all men are created equal; that they are endowed by their Creator with certain inalienable rights; that among these are life, liberty, and the pursuit of happiness; that to secure these rights, governments are instituted among men, deriving their just powers from the consent of the governed; that, whenever any form of government becomes destructive of these ends, it is the right of the people to alter or to abolish it and to institute a new government, laying its foundation on such principles, and organizing its powers in such form, as to them shall seem most likely to effect their safety and happiness. Prudence, indeed, will dictate that governments long established should not be changed for light and transient causes; and, accordingly, all experience hath shown that mankind are more disposed to suffer, while evils are sufferable, than to right themselves by abolishing the forms to which they are accustomed. But, when a long train of abuses and usurpations, pursuing invariably the same object, evinces a design to reduce them under absolute despotism, it is their right, it is their duty, to throw off such government and to provide new guards for their future security. Such has been the patient sufferance of these colonies, and such is now the necessity which constrains them to alter their former systems of government. The history of the present King of Great Britain is a history of repeated injuries and usurpations, all having, in direct object, the establishment of an absolute tyranny over these States. To

Lower case a to z, 13 3-16 ems

ABCDEF GHIJKL MNOPQRST UVWXYZ
 abcdefghijklmnopqrstuvwxy z
 ABCDEF GHIJKL MNOPQRST UVWXYZ
 1234567890 1234567890

Recut Caslon No. 586

10 POINT RECUT CASLON NO. 586

When, in the course of human events, it becomes necessary for one people to dissolve the political bands which have connected them with another, and to assume, among the powers of the earth, the separate and equal station to which the laws of nature and of nature's God entitle them, a decent respect to the opinions of mankind requires that they should declare the causes which impel them to the separation. We hold these truths to be self-evident: That all men are created equal; that they are endowed by their Creator with certain inalienable rights; that among these are life, liberty, and the pursuit of happiness; that to secure these rights, governments are instituted among men, deriving their just powers from the consent of the governed; that, whenever any form of government becomes destructive of these ends, it is the right of the people to alter or to abolish it and to institute a new government, laying its foundation on such principles, and organizing its powers in such form, as to *them shall seem most likely to effect their safety and happiness. Prudence, indeed, will dictate that governments long established should not be*

Lower case a to z 13 3/4 ems

ABCDEFGHIJKLMN OPQRSTUVWXYZ
abcdefghijklmnopqrstu vwxyz
ABCDEFGHIJKLMN OPQRSTUVWXYZ
1234567890 1234567890

12 POINT RECUT CASLON NO. 586

When, in the course of human events, it becomes necessary for one people to dissolve the political bands which have connected them with another, and to assume, among the powers of the earth, the separate and equal station to which the laws of nature and of nature's God entitle them, a decent respect to the opinions of mankind requires that they should declare the causes which impel them to the separation. We hold these truths to be self-evident: That all men are created equal; that they are endowed by their Creator with certain inalienable rights; that among these are life, liberty, and the pursuit of happiness; that to secure these rights, governments are instituted among men, deriving their just powers from the consent of the governed; that, whenever any form of government becomes destructive of

Lower case a to z, 12 11/12 ems

ABCDEFGHIJKLMN OPQRSTUVWXYZ
abcdefghijklmnopqrstu vwxyz
ABCDEFGHIJKLMN OPQRSTUVWXYZ
1234567890 1234567890

14 POINT RECUT CASLON No. 586

WHEN, in the course of human events, it becomes necessary for one people to dissolve the political bands which have connected them with another, and to assume, among the powers of the earth, the separate and equal station to which the laws of nature and of nature's God entitle them, a decent respect to the opinions of mankind requires that they should declare the causes which impel them to the separation. We hold these truths to be self-evident: That all men are created equal; that they are endowed by their Creator with certain inalienable rights; that among these are life, liberty, and the pursuit of happiness; that, to secure these rights, governments are instituted among men, deriving their just powers from the consent of the governed; that, whenever any form of government becomes destructive of these ends, it is the right of the people to alter or to abolish it and to institute a new government, laying its foundation on such principles, and organizing its powers in such form, as to them shall seem most likely to effect their safety and happiness. Prudence, indeed, will dictate that governments long established should not be changed for light and transient causes; and, accordingly, all experience hath shown that mankind are more disposed to suffer, while evils are sufferable, than to right themselves by abolishing the forms to which they are accustomed. But, when a long train of abuses and usurpations, pursuing invariably the same object, evinces a design to reduce them under absolute despotism, it is their right, it is their duty, to throw off such government and to provide new guards

Lower case a to z, 12.9-14 ems

ABCDEFGHIJKLMN OPQRSTUVWXYZ

abcdefghijklmnopqrstuvwxy z

ABCDEFGHIJKLMN OPQRSTUVWXYZ

1234567890 1234567890

18 POINT RECUT CASLON No. 586

WHEN, in the course of human events, it becomes necessary for one people to dissolve the political bands which have connected them with another, and to assume, among the powers of the earth, the separate and equal station to which the laws of nature and of nature's God entitle them, a decent respect to the opinions of mankind requires that they should declare the causes which impel them to the separation. We hold these truths to be self-evident: That all men are created equal; that they are endowed by their Creator with certain inalienable rights; that among these are life, liberty, and the pursuit of happiness; that to secure these rights, governments are instituted among men, deriving their just powers from the consent of the governed; that whenever any form of government becomes destructive of these ends, it is the right, it is the duty of the people to alter or to abolish *it and to institute a new government, laying its foundations on such principles and*

Lower case a to z, 12 25 36 ems

ABCDEFGHIJKLMNOPQRSTUVWXYZ

abcdefghijklmnopqrstuvwxy^z

ABCDEFGHIJKLMNOPQRSTUVWXYZ

1234567890 1234567890

6 POINT OLDSTYLE No. 579

WHEN, in the course of human events, it becomes necessary for one people to dissolve the political bands which have connected them with another, and to assume, among the powers of the earth, the separate and equal station to which the laws of nature and of nature's God entitle them, a decent respect to the opinions of mankind requires that they should declare the causes which impel them to the separation. We hold these truths to be self-evident: That all men are created equal; that they are endowed by their Creator with certain inalienable rights; that among these are life, liberty, and the pursuit of happiness; that, to secure these rights, governments are instituted among men, deriving their just powers from the consent of the governed; that, whenever any form of government becomes destructive of these ends, it is the right of the people to alter or to abolish it, and to institute a new government, laying its foundations on such principles, and organizing its powers in such form, as to them shall seem most likely to effect their safety and happiness. Prudence, indeed, will dictate that governments long established should not be changed for light and transient causes; and, accordingly, all experience hath shown that mankind are more disposed to suffer, while evils are sufferable, than to right themselves by abolishing the forms to which they are accustomed. But, when a long train of abuses and usurpations, pursuing invariably the same object, evinces a design to reduce them under absolute despotism, it is their right, it is their duty, to throw off such government and to provide new guards for their future security. Such has been the patient sufferance of these colonies, and such is now the necessity which constrains them to alter their former systems of government. The history of the present King of Great Britain is a history of repeated injuries and usurpations, all having, in direct object, the establishment of an absolute tyranny over these States. To prove this, let facts be submitted to a candid world: He has refused his assent to laws the most wholesome and necessary for the public good; he has forbidden his governors to pass laws of immediate and pressing importance, unless suspended in their operation till his assent should be obtained, and, when so suspended, he has utterly neglected to attend to them; he has refused to pass other laws for the accommodation of large districts of people, unless those people would relinquish the right of representation in the legislature, a right inestimable to them, and formidable to tyrants only; he has called together legislative bodies at places unusual, uncomfortable, and distant from the depository of their public records, for the sole purpose of fatiguing them into compliance with his measures; he has dissolved representative houses repeatedly, for opposing, with manly firmness, his invasions on the rights of the people; he has refused, for a long time after such dissolutions, to cause others to be elected;

Lower case a to z, 16 ems

ABCDEFGHIJKLMN OPQRSTUVWXYZ

abcdefghijklmnopqrstuvwxyz

ABCDEFGHIJKLMN OPQRSTUVWXYZ

1234567890

1234567890

7 POINT OLDSTYLE No. 579

WHEN, in the course of human events, it becomes necessary for one people to dissolve the political bands which have connected them with another, and to assume, among the powers of the earth, the separate and equal station to which the laws of nature and of nature's God entitle them, a decent respect to the opinions of mankind requires that they should declare the causes which impel them to the separation. We hold these truths to be self-evident: That all men are created equal; that they are endowed by their Creator with certain inalienable rights; that among these are life, liberty, and the pursuit of happiness; that to secure these rights, governments are instituted among men, deriving their just powers from the consent of the governed; that, whenever any form of government becomes destructive of these ends, it is the right of the people to alter or to abolish it and to institute a new government, laying its foundations on such principles, and organizing its powers in such form, as to them shall seem most likely to effect their safety and happiness. Prudence, indeed, will dictate that governments long established should not be changed for light and transient causes; and, accordingly, all experience hath shown that mankind are more disposed to suffer, while evils are sufferable, than to right themselves by abolishing the forms to which they are accustomed. But, when a long train of abuses and usurpations, pursuing invariably the same object, evinces a design to reduce them under absolute despotism, it is their right, it is their duty, to throw off such government and to provide new guards for their future security. Such has been the patient sufferance of these colonies, and such is now the necessity which constrains them to alter their former systems of government. The history of the present King of Great Britain is a history of repeated injuries and usurpations, all having, in direct object, the establishment of an absolute tyranny over these States. To prove this, let facts be submitted to a candid world: He has refused his assent to laws the most wholesome and necessary for the public good; he has forbidden his governors to pass laws of immediate and

Lower case a to z, 15 ems

ABCDEFGHIJKLMN OPQRSTUVWXYZ

abcdefghijklmnopqrstuvwxyz

ABCDEFGHIJKLMN OPQRSTUVWXYZ

1234567890

1234567890

8 POINT OLDSTYLE No. 579

WHEN, in the course of human events, it becomes necessary for one people to dissolve the political bands which have connected them with another, and to assume, among the powers of the earth, the separate and equal station to which the laws of nature and of nature's God entitle them, a decent respect to the opinions of mankind requires that they should declare the causes which impel them to the separation. We hold these truths to be self-evident: That all men are created equal; that they are endowed by their Creator with certain inalienable rights; that among these are life, liberty, and the pursuit of happiness; that, to secure these rights, governments are instituted among men, deriving their just powers from the consent of the governed; that, whenever any form of government becomes destructive of these ends, it is the right of the people to alter or to abolish it and to institute a new government, laying its foundations on such principles, and organizing its powers in such form, as to them shall seem most likely to effect their safety and happiness. Prudence, indeed, will dictate that governments long established should not be changed for light or transient causes; and, accordingly, all experience hath shown that mankind are more disposed to suffer, while evils are sufferable, than to right themselves by abolishing the forms to which they are accustomed. But, when a long train of abuses and usurpations, pursuing invariably the same object, evinces a design to reduce them under absolute despotism, it is their right, it is their duty, to throw off such government and to provide new guards for their future security. *Such has been the patient sufferance of these colonies, and such is now the necessity which constrains them to alter their former*

Lower case a to z, 11 ems

ABCDEFGHIJKLMN O PQRSTU VWXYZ
 abcdefghijklmnopqrstu vwxyz
 ABCDEFGHIJKLMN O PQRSTU VWXYZ
 1234567890 1234567890

9 POINT OLDSTYLE No. 579

WHEN, in the course of human events, it becomes necessary for one people to dissolve the political bands which have connected them with another, and to assume, among the powers of the earth, the separate and equal station to which the laws of nature and of nature's God entitle them, a decent respect to the opinions of mankind requires that they should declare the causes which impel them to the separation. We hold these truths to be self-evident: That all men are created equal; that they are endowed by their Creator with certain inalienable rights; that among these are life, liberty, and the pursuit of happiness; that, to secure these rights, governments are instituted among men, deriving their just powers from the consent of the governed; that, whenever any form of government becomes destructive of these ends, it is the right of the people to alter or to abolish it and to institute a new government, laying its foundation on such principles, and organizing its powers in such form, as to them shall seem most likely to effect their safety and happiness. Prudence, indeed, will dictate that governments long established should not be changed for light and transient causes; and, accordingly, all experience hath shown that mankind are more disposed to suffer, while evils are sufferable, than to right themselves by abolishing the forms to which they are accustomed. *But, when a long train of abuses and usurpations, pursuing invariably the same object, evinces a design to reduce them*

Lower case a to z, 11.2 3 ems

ABCDEFGHIJKLMN O PQRSTU VWXYZ
 abcdefghijklmnopqrstu vwxyz
 ABCDEFGHIJKLMN O PQRSTU VWXYZ
 1234567890 1234567890

Partly opened with two-point lead

10 POINT OLDSTYLE No. 579

WHEN, in the course of human events, it becomes necessary for one people to dissolve the political bands which have connected them with another, and to assume, among the powers of the earth, the separate and equal station to which the laws of nature and of nature's God entitle them, a decent respect to the opinions of mankind requires that they should declare the causes which impel them to the separation. We hold these truths to be self-evident: That all men are created equal; that they are endowed by their Creator with certain inalienable rights; that among these are life, liberty, and the pursuit of happiness; that to secure these rights, governments are instituted among men, deriving their just powers from the consent of the governed; that, whenever any form of government becomes destructive of these ends, it is the right of the people to alter or to abolish it and to institute a new government, laying its foundations on such principles, and organizing its powers in such form, as to them shall seem most likely to effect their safety and happiness. *Prudence, indeed, will dictate that governments long established should not be changed for light and transient causes; and, accordingly, all experience*

Lower case a to z, 12.9-10 ems

ABCDEFGHIJKLMN OPQRSTUVWXYZ
 abcdefghijklmnopqrstuvwxyz
 ABCDEFGHIJKLMN OPQRSTUVWXYZ
 1234567890 1234567890

11 POINT OLDSTYLE No. 579

WHEN, in the course of human events, it becomes necessary for one people to dissolve the political bands which have connected them with another, and to assume, among the powers of the earth, the separate and equal station to which the laws of nature and of nature's God entitle them, a decent respect to the opinions of mankind requires that they should declare the causes which impel them to the separation. We hold these truths to be self-evident: That all men are created equal; that they are endowed by their Creator with certain inalienable rights; that among these are life, liberty, and the pursuit of happiness; that to secure these rights, governments are instituted among men, deriving their just powers from the consent of the governed; that, whenever any form of government becomes destructive of these ends, it is the right of the people to alter or to abolish it and to institute a new government, laying its foundations on such principles, and organizing

Lower case a to z, 12.8-11 ems

ABCDEFGHIJKLMN OPQRSTUVWXYZ
 abcdefghijklmnopqrstuvwxyz
 ABCDEFGHIJKLMN OPQRSTUVWXYZ
 1234567890 1234567890

12 POINT OLDSTYLE No. 579

WHEN, in the course of human events, it becomes necessary for one people to dissolve the political bands which have connected them with another, and to assume, among the powers of the earth, the separate and equal station to which the laws of nature and of nature's God entitle them, a decent respect to the opinions of mankind requires that they should declare the causes which impel them to the separation. We hold these truths to be self-evident: That all men are created equal; that they are endowed by their Creator with certain inalienable rights; that among these are life, liberty, and the pursuit of happiness; that, to secure these rights, governments are instituted among men, deriving their just powers from the consent of the governed; that, whenever any form of government becomes destructive of these ends, it is the right of

Lower case a to z, 12.5-ems.

ABCDEFGHIJKLMNOPQRSTUVWXYZ
 abcdefghijklmnopqrstuvwxyz
 ABCDEFGHIJKLMNOPQRSTUVWXYZ
 1234567890 1231567890

18 POINT OLDSTYLE No. 579

When, in the course of human events, it becomes necessary for one people to dissolve the political bands which have connected them with another, and to assume, among the powers of the earth, the separate and equal station to which the laws of nature and of nature's God entitle them, a decent respect to the opinions of mankind requires that they should declare the causes which

Lower case a to z, 11.7-ems.

ABCDEFGHIJKLMNOPQRSTUVWXYZ
 abcdefghijklmnopqrstuvwxyz
 1234567890

5 POINT OLDSTYLE NO. 581

WHEN, in the course of human events, it becomes necessary for one people to dissolve the political bands which have connected them with another, and to assume, among the powers of the earth, the separate and equal station to which the laws of nature and of nature's God entitle them, a decent respect to the opinions of mankind requires that they should declare the causes which impel them to the separation. We hold these truths to be self-evident; that all men are created equal; that they are endowed by their Creator with certain inalienable rights; that among these are life, liberty, and the pursuit of happiness; that, to secure these rights, governments are instituted among men, deriving their just powers from the consent of the governed; that, whenever any form of government becomes destructive of these ends, it is the right of the people to alter or to abolish it, and to institute a new government, laying its foundation on such principles, and organizing its powers in such form, as to them shall seem most likely to effect their safety and happiness. Prudence, indeed, will dictate that governments long established should not be changed for light and transient causes; and, accordingly, all experience hath shown that mankind are more disposed to suffer, while evils are sufferable, than to right themselves by abolishing the forms to which they are accustomed. But when a long train of abuses and usurpations, pursuing invariably the same object, evinces a design to reduce them under absolute despotism, it is their right, it is their duty, to throw off such government and to provide new guards for their future security. Such has been the patient sufferance of these colonies, and such is now the necessity which constrains them to alter their former system of government. The history of the present King of Great Britain is a history of repeated injuries and usurpations, all having, in direct object, the establishment of an absolute tyranny over these States. To prove this, let facts be submitted to a candid world: He has refused his assent to laws the most wholesome and necessary for the public good; he has forbidden his governors to pass laws of immediate and pressing importance, unless suspended in their operation till his assent should be obtained; and, when so suspended, he has utterly neglected to attend to them; he has refused to pass other laws for the accommodation of large districts of people, unless those people would relinquish the right of representation in the legislature; a right inestimable to them, and formidable to tyrants only; he has called together legislative bodies at places unusual, uncomfortable, and distant from the depository of their public records, for the sole purpose of fatiguing them into compliance with his measures; he has dissolved representative houses repeatedly, for opposing, with manly firmness, his invasions on the rights of the people; he has refused for a long time after such dissolutions, to cause others to be elected; whereby the legislative powers, incapable of annihilation, have returned to the people at large for their exercise, the state remaining, in the meantime, exposed to all the danger of invasion from without, and convulsions within; he has endeavored to prevent the population of these States, for that purpose obstructing the laws for naturalization of foreigners, refusing to pass others to encourage their migration hither, and raising the conditions of new appropriations of lands; he has obstructed the administration of justice, by refusing his assent to laws for establishing judiciary powers; he has made judges dependent on his will alone, for the tenure of their offices, and the amount and payment of their salaries; he has created a multitude of new offices, and sent hither swarms of officers to harass our people, and eat out their substance; he has kept among us, in time of peace, standing armies, without the consent of our legislatures; he has

Lower case a to z, 15.9-10 ems
 ABCDEFGHIJKLMNOPQRSTUVWXYZ
 abcdefghijklmnopqrstuvwxyz
 ABCDEFGHIJKLMNOPQRSTUVWXYZ
 1234567890 1234567890

6 POINT OLDSTYLE NO. 581

WHEN, in the course of human events, it becomes necessary for one people to dissolve the political bands which have connected them with another, and to assume, among the powers of the earth, the separate and equal station to which the laws of nature and of nature's God entitle them, a decent respect to the opinions of mankind requires that they should declare the causes which impel them to the separation. We hold these truths to be self-evident; that all men are created equal; that they are endowed by their Creator with certain inalienable rights; that among these are life, liberty, and the pursuit of happiness; that, to secure these rights, governments are instituted among men, deriving their just powers from the consent of the governed; that whenever any form of government becomes destructive of these ends, it is the right of the people to alter or to abolish it, and to institute a new government, laying its foundation on such principles, and organizing its powers in such form, as to them shall seem most likely to effect their safety and happiness. Prudence, indeed, will dictate that governments long established should not be changed for light and transient causes; and, accordingly, all experience hath shown that mankind are more disposed to suffer, while evils are sufferable, than to right themselves by abolishing the forms to which they are accustomed. But, when a long train of abuses and usurpations, pursuing invariably the same object, evinces a design to reduce them under absolute despotism, it is their right, it is their duty, to throw off such government and to provide new guards for their future security. Such has been the patient sufferance of these colonies, and such is now the necessity which constrains them to alter their former systems of government. The history of the present King of Great Britain is a history of repeated injuries and usurpations, all having, in direct object, the establishment of an absolute tyranny over these States. To prove this, let facts be submitted to a candid world: He has refused his assent to laws the most wholesome and necessary for the public good; he has forbidden his governors to pass laws of immediate and pressing importance, unless suspended in their operation till his assent should be obtained; and, when so suspended, he has utterly neglected to attend to them; he has refused to pass other laws for the accommodation of large districts of people, unless those people would relinquish the right of representation in the legislature; a right inestimable to them, and formidable to tyrants only; he has called together legislative bodies at places unusual, uncomfortable, and distant from the depository of their public records, for the sole purpose of fatiguing them into compliance with his measures; he has dissolved representative houses repeatedly, for opposing, with manly firmness, his invasions on the rights

Lower case a to z, 16 ems
 ABCDEFGHIJKLMNOPQRSTUVWXYZ
 abcdefghijklmnopqrstuvwxyz
 ABCDEFGHIJKLMNOPQRSTUVWXYZ
 1234567890 1234567890

Partly opened with two point leads

Oldstyle No. 581

7 POINT OLDSTYLE No. 581

WHEN, in the course of human events, it becomes necessary for one people to dissolve the political bands which have connected them with another, and to assume, among the powers of the earth, the separate and equal station to which the laws of nature and of nature's God entitle them, a decent respect to the opinions of mankind requires that they should declare the causes which impel them to the separation. We hold these truths to be self-evident: That all men are created equal; that they are endowed by their Creator with certain inalienable rights; that among these are life, liberty, and the pursuit of happiness; that, to secure these rights, governments are instituted among men, deriving their just powers from the consent of the governed; that, whenever any form of government becomes destructive of these ends, it is the right of the people to alter or to abolish it and to institute a new government, laying its foundation on such principles, and organizing its powers in such form, as to them shall seem most likely to effect their safety and happiness. Prudence, indeed, will dictate that governments long established should not be changed for light and transient causes; and, accordingly, all experience hath shown that mankind are more disposed to suffer, while evils are sufferable, than to right themselves by abolishing the forms to which they are accustomed. But when a long train of abuses and usurpations, pursuing invariably the same object, evinces a design to reduce them under absolute despotism, it is their right, it is their duty, to throw off such government and to provide new guards for their future security. Such has been the patient sufferance of these colonies, and such is now the necessity which constrains them to alter their former systems of government. The history of the present King of Great Britain is a history of repeated injuries and usurpations, all having, in direct object, the establishment of an absolute tyranny over these States. To prove this, let facts be submitted to a candid world: He has refused his assent to laws the most *wholesome and necessary for the public good; he has forbidden his governors to pass laws of immediate and pressing importance, unless suspended in their operation*

Lower case a to z, 15 2-7 ems

ABCDEFGHIJKLMN OPQRSTUVWXYZ
 abcdefghijklmnopqrstuvwxyz
 ABCDEFGHIJKLMN OPQRSTUVWXYZ
 1234567890 1234567890

8 POINT OLDSTYLE No. 581

WHEN, in the course of human events, it becomes necessary for one people to dissolve the political bands which have connected them with another, and to assume, among the powers of the earth, the separate and equal station to which the laws of nature and of nature's God entitle them, a decent respect to the opinions of mankind requires that they should declare the causes which impel them to the separation. We hold these truths to be self-evident: That all men are created equal; that they are endowed by their Creator with certain inalienable rights; that among these are life, liberty, and the pursuit of happiness; that, to secure these rights, governments are instituted among men, deriving their just powers from the consent of the governed; that, whenever any form of government becomes destructive of these ends, it is the right of the people to alter or to abolish it and to institute a new government, laying its foundation on such principles, and organizing its powers in such form, as to them shall seem most likely to effect their safety and happiness. Prudence, indeed, will dictate that governments long established should not be changed for light and transient causes; and, accordingly, all experience hath shown that mankind are more disposed to suffer, while evils are sufferable, than to right themselves by abolishing the forms to which they are accustomed. But when a long train of abuses and usurpations, pursuing invariably the same object, evinces a design to reduce them under absolute despotism, it is their right, it is their duty, to throw off such government and to provide *new guards for their future security. Such has been the patient sufferance of these colonies, and such is now the necessity which constrains them to alter their former*

Lower case a to z, 14 1-1 ems

ABCDEFGHIJKLMN OPQRSTUVWXYZ
 abcdefghijklmnopqrstuvwxyz
 ABCDEFGHIJKLMN OPQRSTUVWXYZ
 1234567890 1234567890

Partly opened with two point leads

9 POINT OLDSTYLE No. 581

WHEN, in the course of human events, it becomes necessary for one people to dissolve the political bands which have connected them with another, and also to assume, among the powers of the earth, the separate and equal station to which the laws of nature and of nature's God entitle them, a decent respect to the opinions of mankind requires that they should declare the causes which impel them to the separation. We hold these truths to be self-evident: That all men are created equal; that they are endowed by their Creator with certain inalienable rights; that among these are life, liberty, and the pursuit of happiness; that to secure these rights, governments are instituted among men, deriving their just powers from the consent of the governed; that, whenever any form of government becomes destructive of these ends, it is the right of the people to alter or to abolish it and to institute a new government, laying its foundations on such principles, and organizing its powers in such form, as to them shall seem most likely to effect their safety and happiness. Prudence, indeed, will dictate that governments long established should not be changed for light and transient causes; and, accordingly, all experience hath shown that mankind are more disposed to suffer, while evils are sufferable, than to right themselves by abolishing the forms to which they are accustomed. *But when abuses and usurpations, pursuing invariably the same*

Lower case a to z, 14 1-9 ems

ABCDEFGHIJKLMN^{OP}QRSTU^{VW}XYZ
 abcdefghijklm^{nop}qrstuv^{wxyz}
 ABCDEFGHIJKLMN^{OP}QRSTU^{VW}XYZ
 1234567890 1234567890

10 POINT OLDSTYLE No. 581

WHEN, in the course of human events, it becomes necessary for one people to dissolve the political bands which have connected them with another, and to assume, among the powers of the earth, the separate and equal station to which the laws of nature and of nature's God entitle them, a decent respect to the opinions of mankind requires that they should declare the causes which impel them to the separation. We hold these truths to be self-evident: That all men are created equal; that they are endowed by their Creator with certain inalienable rights; that among these are life, liberty, and the pursuit of happiness; that to secure these rights, governments are instituted among men, deriving their just powers from the consent of the governed; that, whenever any form of government becomes destructive of these ends, it is the right of the people to alter or to abolish it and to institute a new government, laying its foundation on such principles, and organizing its powers in such form, as to them shall seem most likely to effect their safety and happiness. *Prudence, indeed, will dictate that governments long established should not be changed for light and transient causes; and,*

Lower case a to z, 13 3-20 ems

ABCDEFGHIJKLMN^{OP}QRSTU^{VW}XYZ
 abcdefghijklm^{nop}qrstuv^{wxyz}
 ABCDEFGHIJKLMN^{OP}QRSTU^{VW}XYZ
 1234567890 1234567890

Partly opened with two point leads

11 POINT OLDSTYLE No. 581

WHEN, in the course of human events, it becomes necessary for one people to dissolve the political bands which have connected them with another, and to assume, among the powers of the earth, the separate and equal station to which the laws of nature and of nature's God entitle them, a respectful regard for the opinions of mankind requires that they should declare the causes which impel them to the separation. We hold these truths to be self-evident: That all men are created equal; that they are endowed by their Creator with certain inalienable rights; that among these are life, liberty, and the pursuit of happiness; that, to secure these rights, governments are instituted among men, deriving their just powers from the consent of the governed; that, whenever any form of government becomes destructive of these ends, it is the right of the people to alter or to abolish it and to institute a new government, laying its foundation on such principles, and organizing its powers in such form, as to them shall seem most

Lower case a to z, 13 ems
 ABCDEFGHIJKLMNOPQRSTUVWXYZ
 abcdefghijklmnopqrstuvwxyz
 ABCDEFGHIJKLMNOPQRSTUVWXYZ
 1234567890 1234567890

12 POINT OLDSTYLE No. 581

WHEN, in the course of human events, it becomes necessary for one people to dissolve the political bands which have connected them with another and to assume, among the powers of the earth, the separate and equal station to which the laws of nature and of nature's God entitle them, a decent respect to the opinions of mankind requires that they should declare the causes which impel them to the separation. We hold these truths to be self-evident: That all men are created equal; that they are endowed by their Creator with certain inalienable rights; that among these are life, liberty, and the pursuit of happiness; that, to secure these rights, governments are instituted among men, deriving their just powers from the consent of the governed; that, whenever any

Lower case a to z, 14.5-12 ems
 ABCDEFGHIJKLMNOPQRSTUVWXYZ
 abcdefghijklmnopqrstuvwxyz
 ABCDEFGHIJKLMNOPQRSTUVWXYZ
 1234567890 1234567890

Partly opened with two point leads

6 POINT OLDSTYLE No. 583

WHEN, in the course of human events, it becomes necessary for one people to dissolve the political bands which have connected them with another, and to assume, among the powers of the earth, the separate and equal station to which the laws of nature and of nature's God entitle them, a decent respect to the opinions of mankind requires that they should declare the causes which impel them to the separation. We hold these truths to be self-evident: That all men are created equal; that they are endowed by their Creator with certain inalienable rights; that among these are life, liberty, and the pursuit of happiness; that to secure these rights, governments are instituted among men, deriving their just powers from the consent of the governed; that, whenever any form of government becomes destructive of these ends, it is the right of the people to alter or to abolish it and to institute a new government, laying its foundations on such principles, and organizing its powers in such form, as to them shall seem most likely to effect their safety and happiness. Prudence, indeed, will say that governments long established should not be changed for light and transient causes; and, accordingly, all experience hath shown that mankind are more disposed to suffer, while evils are sufferable, than to right themselves by abolishing the forms to which they are accustomed. But,

Lower case a to z, 15 1-2 ems

ABCDEFGHIJKLMN^oQRSTU^vWXY
 abcdefghijklmⁿopq^rstuv^wxyz
 ABCDEFGHIJKLMN^oQRSTU^vWXYZ
 1234567890

8 POINT OLDSTYLE No. 583

WHEN, in the course of human events, it becomes necessary for one people to dissolve the political bands which have connected them with another, and to assume, among the powers of the earth, the separate and equal station to which the laws of nature and of nature's God entitle them, a decent respect to the opinions of mankind requires that they should declare the causes which impel them to the separation. We hold these truths to be self-evident: That all men are created equal; that they are endowed by their Creator with certain inalienable rights; that among these are life, liberty, and the pursuit of happiness; that to secure these rights, governments are instituted among men, deriving their just powers from the consent of the governed; that, whenever any form of government becomes destructive of these ends, it is the right

Lower case a to z, 13 7-8 ems

ABCDEFGHIJKLMN^oQRSTU^v
 abcdefghijklmⁿopq^rstuv^wxyz
 ABCDEFGHIJKLMN^oQRSTU^vWXYZ
 1234567890

9 POINT OLDSTYLE No. 583

WHEN, in the course of human events, it becomes necessary for one people to dissolve the political bands which have connected them with another, and to assume, among the powers of the earth, the separate and equal station to which the laws of nature and of nature's God entitle them, a decent respect to the opinions of mankind requires that they should declare the causes which impel them to the separation. We hold these truths to be self-evident: That all men are created equal; that they are endowed by their Creator with certain inalienable rights; that among these are life, liberty, and the pursuit of happiness; that to secure these rights, governments are instituted among men, deriving their just powers from the consent of the governed; that, whenever any form of government becomes destructive of these ends, it is the right of the people to alter or to abolish it and to institute a new government, laying its foundations on such principles, and organizing its powers in such form, as to them shall seem most likely to effect their safety and happiness. Prudence, indeed, will dictate that governments long established should not be changed for light and transient causes; and, accordingly, all experience hath shown that mankind are more disposed to suffer, while evils are sufferable, than to right themselves by abolishing the forms to which they are accustomed. But, when a long train of abuses and usurpations, pursuing invariably the same object, evinces a design to reduce them under absolute despotism, it is their right, it is their duty, to

Lower case a to z, 12 8-9 ems

ABCDEFGHIJKLMN^oQRSTU^vWXYZ
 abcdefghijklmⁿopq^rstuv^wxyz
 ABCDEFGHIJKLMN^oQRSTU^vWXYZ
 1234567890

Partly opened with two point leads

Series No. 583 is cast from strikes furnished by the Mergenthaler Linotype Co., and exactly matches its Oldstyle No. 1 Series No Italic made for Oldstyle No. 583

10 POINT OLDSTYLE No. 583

WHEN, in the course of human events, it becomes necessary for one people to dissolve the political bands which have connected them with another, and to assume, among the powers of the earth, the separate and equal station to which the laws of nature and of nature's God entitle them, a decent respect to the opinions of mankind requires that they should declare the causes which impel them to the separation. We hold these truths to be self-evident: That all men are created equal; that they are endowed by their Creator with certain inalienable rights; that among these are life, liberty, and the pursuit of happiness; that to secure these rights, governments are instituted among men, deriving their just powers from the consent of the governed; that, whenever any form of government becomes destructive of these ends, it is the right of the people to alter or to abolish it and to institute a new government, laying its foundations on such principles, and organizing its powers in such form, as to them shall seem most likely to effect their safety and happiness. Prudence, indeed, will dictate that governments long established should not be changed for light and transient causes; and,

Lower case a to z, 13 ems

ABCDEFGHIJKLMN^OQRSTU^VWXYZ
 abcdefghijklmⁿopqrstu^vwxyz
 ABCDEFGHIJKLMN^OQRSTU^VWXYZ
 1234567800

11 POINT OLDSTYLE No. 583

WHEN, in the course of human events, it becomes necessary for one people to dissolve the political bands which have connected them with another, and to assume, among the powers of the earth, the separate and equal station to which the laws of nature and of nature's God entitle them, a decent respect to the opinions of mankind requires that they should declare the causes which impel them to the separation. We hold these truths to be self-evident: That all men are created equal; that they are endowed by their Creator with certain inalienable rights; that among these are life, liberty, and the pursuit of happiness; that to secure these rights, governments are instituted among men, deriving their just powers from the consent of the governed; that, whenever any form of government becomes destructive of these ends, it is the right of the people to alter or to abolish it and to institute a new government, laying its foundations on such principles, and organizing its powers in such form, as to them shall seem most likely to effect their safety

Lower case a to z, 12 5/11 ems

ABCDEFGHIJKLMN^OQRSTU^VWXYZ
 abcdefghijklmⁿopqrstu^vwxyz
 ABCDEFGHIJKLMN^OQRSTU^VWXYZ
 1234567800

Series No. 583 is cast from strikes furnished by the Mergenthaler Linotype Co., and exactly matches its Oldstyle No. 1 Series. No Italic made for Oldstyle No. 583.

Partly opened with two point leads

Lining Oldstyle No. 523

5 POINT LINING OLDSTYLE No. 523

WHEN, in the course of human events, it becomes necessary for one people to dissolve the political bands which have connected them with another, and to assume, among the powers of the earth, the separate and equal station to which the laws of nature and of nature's God entitle them, a decent respect to the opinions of mankind requires that they should declare the causes which impel them to the separation. We hold these truths to be self-evident: That all men are created equal, that they are endowed by their Creator with certain inalienable rights, that among these are life, liberty, and the pursuit of happiness; that, to secure these rights, governments are instituted among men, deriving their just powers from the consent of the governed; that, whenever any form of government becomes destructive of these ends, it is the right of the people to alter or to abolish it, and to institute a new government, laying its foundation on such principles, and organizing its powers in such form, as to them shall seem most likely to effect their safety and happiness. Prudence, indeed, will dictate that governments long established should not be changed for light and transient causes; and accordingly, all experience hath shown that mankind are more disposed to suffer, while evils are sufferable, than to right themselves by abolishing the forms to which they are accustomed. But, when a long train of abuses and usurpations, pursuing invariably the same object, evinces a design to reduce them under absolute despotism, it is their right, it is their duty, to throw off such government and to provide new guards for their future safety. Such has been the patient sufferance of these colonies, and such is now the necessity which constrains them to alter their former systems of government. The history of the present King of Great Britain is a history of repeated injuries and usurpations, all having in direct object the establishment of an absolute tyranny over these States. *To prove this, let facts be submitted to a candid world: He has refused*

Lower case a to z, 14 1-2 ems

ABCDEFGHIJKLMN O PQRSTU VWXYZ
 abcdefghijklmnopqrstuvwxyz
 ABCDEFGHIJKLMNO PQRSTU VWXYZ
 1234567890 1234567890

6 POINT LINING OLDSTYLE No. 523

WHEN, in the course of human events, it becomes necessary for one people to dissolve the political bands which have connected them with another, and to assume, among the powers of the earth, the separate and equal station to which the laws of nature and of nature's God entitle them, a decent respect to the opinions of mankind requires that they should declare the causes which impel them to the separation. We hold these truths to be self-evident: That all men are created equal; that they are endowed by their Creator with certain inalienable rights; that among these are life, liberty, and the pursuit of happiness; that to secure these rights, governments are instituted among men, deriving their just powers from the consent of the governed; that, whenever any form of government becomes destructive of these ends, it is the right of the people to alter or to abolish it and to institute a new government, laying its foundation on such principles, and organizing its powers in such form, as to them shall seem most likely to effect their safety and happiness. Prudence, indeed, will dictate that governments long established should not be changed for light and transient causes; and, accordingly, all experience hath shown that mankind are more disposed to suffer, while evils are sufferable, than to right themselves by abolishing the forms to which they are accustomed. But, when a

Lower case a to z, 14 9-12 ems

ABCDEFGHIJKLMN O PQRSTU VWXYZ
 abcdefghijklmnopqrstuvwxyz
 ABCDEFGHIJKLMNO PQRSTU VWXYZ
 1234567890 1234567890

5½ POINT LINING OLDSTYLE No. 523

WHEN, in the course of human events, it becomes necessary for one people to dissolve the political bands which have connected them with another, and to assume, among the powers of the earth, the separate and equal station to which the laws of nature and of nature's God entitle them, a decent respect to the opinions of mankind requires that they should declare the causes which impel them to the separation. We hold these truths to be self-evident: That all men are created equal; that they are endowed by their Creator with certain inalienable rights; that among these are life, liberty, and the pursuit of happiness; that, to secure these rights, governments are instituted among men, deriving their just powers from the consent of the governed; that, whenever any form of government becomes destructive of these ends, it is the right of the people to alter or to abolish it and to institute a new government, laying its foundation on such principles, and organizing its powers in such form, as to them shall seem most likely to effect their safety and happiness. Prudence, indeed, will dictate that governments long established should not be changed for light and transient causes; and, accordingly, all experience hath shown that mankind are more disposed to suffer, while evils are sufferable, than to right themselves by abolishing the forms to which they are accustomed. But, when a long train of abuses and usurpations, pursuing invariably the same object, evinces a design to reduce them under absolute despotism, it is their right, it is their duty, to throw off such government and to provide new guards for their future security. Such has been the patient suffer-

Lower case a to z, 14 4-5 ems

ABCDEFGHIJKLMN O PQRSTU VWXYZ
 abcdefghijklmnopqrstuvwxyz
 ABCDEFGHIJKLMNO PQRSTU VWXYZ
 1234567890 1234567890

8 POINT LINING OLDSTYLE No. 523

WHEN, in the course of human events, it becomes necessary for one people to dissolve the political bands which have connected them with another, and to assume, among the powers of the earth, the separate and equal station to which the laws of nature and of nature's God entitle them, a decent respect to the opinions of mankind requires that they should declare the causes which impel them to the separation. We hold these truths to be self-evident: That all men are created equal; that they are endowed by their Creator with certain inalienable rights; that among these are life, liberty, and the pursuit of happiness; that, to secure these rights, governments are instituted among men, deriving their powers from the consent of the governed; that, whenever any form of government becomes destructive of these ends it is the right of the

Lower case a to z, 13 3-4 ems

ABCDEFGHIJKLMN O PQRSTU
 abcdefghijklmnopqrstuvwxyz
 ABCDEFGHIJKLMNO PQRSTU VWXYZ
 1234567890 1234567890

10 POINT LINING OLDSTYLE No. 523

WHEN, in the course of human events, it becomes necessary for one people to dissolve the political bands which have connected them with another, and to assume, among the powers of the earth, the separate and equal station to which the laws of nature and of nature's God entitle them, a decent respect to the opinions of mankind requires that they should declare the causes which impel them to the separation. We hold these truths to be self-evident: That all men are created equal; that they are endowed by their Creator with certain inalienable rights; that among these are life, liberty, and the pursuit of happiness;

Lower case a to z, 13 1/2 em

ABCDEFGHIJKLMN OPQRSTUVWXYZ
 abcdefghijklmno pqrstuvwxyz
 ABCDEFGHIJKL MNOPQRSTUVWXYZ
 1234567890 1234567890

12 POINT LINING OLDSTYLE No. 523

WHEN, in the course of human events, it becomes necessary for one people to dissolve the political bands which have connected them with another, and to assume, among the powers of the earth, the separate and equal station to which the laws of nature and of nature's God entitle them, a decent respect to the opinions of man-

Lower case a to z, 11 ems

ABCDEFGHIJKLMN OPQRSTUVWXYZ
 abcdefghijklmno pqrstuvwxyz
 ABCDEFGHIJKL MNOPQRSTUVWXYZ
 1234567890 1234567890

18 POINT LINING OLDSTYLE No. 523

WHEN, in the course of human events, it becomes necessary for one people to dissolve the political bands which have connected them with another, and to assume, among the powers of the earth, the separate and equal station to

Lower case a to z, 19 1/2 18 ems

ABCDEFGHIJKLMN OPQRSTUVWXYZ
 abcdefghijklmno pqrstuvwxyz
 ABCDEFGHIJKL MNOPQRSTUVWXYZ
 1234567890 1234567890

Lining Oldstyle No. 550

6 POINT LINING OLDSTYLE No. 550

WHEN, in the course of human events, it becomes necessary for one people to dissolve the political bands which have connected them with another, and to assume, among the powers of the earth, the separate and equal station to which the laws of nature and of nature's God entitle them, a decent respect to the opinions of mankind requires that they should declare the causes which impel them to the separation. We hold these truths to be self-evident: That all men are created equal; that they are endowed by their Creator with certain inalienable rights; that among these are life, liberty, and the pursuit of happiness; that, to secure these rights, governments are instituted among men, deriving their just powers from the consent of the governed; that whenever any form of government becomes destructive of these ends, it is the right of the people to alter or to abolish it, and to institute a new government, laying its foundation on such principles, and organizing its powers in such form, as to them shall seem most likely to effect their safety and happiness. Prudence, indeed, will dictate that governments long established should not be changed for light and transient causes; and, accordingly, all experience hath shown that *mankind are more disposed to suffer, while evils are sufferable, than to right themselves by abol-*

Lower case a to z, 16 ems

ABCDEFGHIJKLMN OPQRSTUVWXYZ
 abcdefghijklmnopqrstuvwxyz
 ABCDEFGHIJKLMN OPQRSTUVWXYZ
 1234567890 1234567890

7 POINT LINING OLDSTYLE No. 550

WHEN, in the course of human events, it becomes necessary for one people to dissolve the political bands which have connected them with another, and to assume, among the powers of the earth, the separate and equal station to which the laws of nature and of nature's God entitle them, a decent respect to the opinions of mankind requires that they should declare the causes which impel them to the separation. We hold these truths to be self-evident: That all men are created equal; that they are endowed by their Creator with certain inalienable rights; that among these are life, liberty, and the pursuit of happiness; that, to secure these rights, governments are instituted among men, deriving their just powers from the consent of the governed; that whenever any form of government becomes destructive of these ends, it is the right of the people to alter or to abolish it, and to institute a new government, laying its foundation on such principles, and organizing its powers in such form, as to them shall seem most likely to effect their safety and hap-

Lower case a to z, 14 13-14 ems

ABCDEFGHIJKLMN OPQRSTUVWXYZ
 abcdefghijklmnopqrstuvwxyz
 ABCDEFGHIJKLMN OPQRSTUVWXYZ
 1234567890 1234567890

8 POINT LINING OLDSTYLE No. 550

WHEN, in the course of human events, it becomes necessary for one people to dissolve the political bands which have connected them with another, and to assume, among the powers of the earth, the separate and equal station to which the laws of nature and of nature's God entitle them, a decent respect to the opinions of mankind requires that they should declare the causes which impel them to the separation. We hold these truths to be self-evident: That all men are created equal; that they are endowed by their Creator with certain inalienable rights; that among these are life, liberty, and the pursuit of happiness; that, to secure these rights, governments are instituted among men, deriving their just powers from the consent of the governed; that whenever *any form of government becomes destructive of these ends, it is the right*

Lower case a to z, 14 5-16 ems

ABCDEFGHIJKLMN OPQRSTU
 abcdefghijklmnopqrstuvwxyz
 ABCDEFGHIJKLMN OPQRSTU
 1234567890 1234567890

9 POINT LINING OLDSTYLE No. 550

WHEN, in the course of human events, it becomes necessary for one people to dissolve the political bands which have connected them with another, and to assume, among the powers of the earth, the separate and equal station to which the laws of nature and of nature's God entitle them, a decent respect to the opinions of mankind requires that they should declare the causes which impel them to the separation. We hold these truths to be self-evident: That all men are created equal; that they are endowed by their Creator with certain inalienable rights; that among these are life, liberty, and the pursuit of happiness; that, to secure these rights, governments are instituted among

Lower case a to z, 13 13-18 ems

ABCDEFGHIJKLMN OPQRSTU
 abcdefghijklmnopqrstuvwxyz
 ABCDEFGHIJKLMN OPQRSTU
 1234567890 1234567890

Partly opened with two point leads

10 POINT LINING OLDSTYLE No. 550

WHEN, in the course of human events, it becomes necessary for one people to dissolve the political bands which have connected them with another, and to assume, among the powers of the earth, the separate and equal station to which the laws of nature and of nature's God entitle them, a decent respect to the opinions of mankind requires that they should declare the causes which impel them to the separation. We hold these truths to be self-evident: That all men are created equal; that they are endowed by their Creator with certain inalienable rights; that among these are life, liberty, and the pursuit of happiness; that to

Lower case a to z, 13 1/2 ems

ABCDEFGHIJKLMN^{OP}QRSTU^{VW}XYZ

abcdefghijklmnopqrstu^{vwxyz}

ABCDEFGHIJKLMN^{OP}QRSTU^{VW}XYZ

1234567890 1234567890

11 POINT LINING OLDSTYLE No. 550

WHEN, in the course of human events, it becomes necessary for one people to dissolve the political bands which have connected them with another, and to assume, among the powers of the earth, the separate and equal station to which the laws of nature and of nature's God entitle them, a decent respect to the opinions of mankind requires that they should declare the causes which impel them to the separation. We hold these truths to be self-evident: That all men are created equal; that they are endowed by their Creator

Lower case a to z, 12 8/11 ems

ABCDEFGHIJKLMN^{OP}QRSTU^{VW}XYZ

abcdefghijklmnopqrstu^{vwxyz}

ABCDEFGHIJKLMN^{OP}QRSTU^{VW}XYZ

1234567890 1234567890

12 POINT LINING OLDSTYLE No. 550

WHEN, in the course of human events, it becomes necessary for one people to dissolve the political bands which have connected them with another, and to assume, among the powers of the earth, the separate and equal station to which the laws of nature and of nature's God entitle them, a decent respect to the opinions of mankind requires that they should declare the causes which impel them to the separation. We hold these truths to be self-evident:

Lower case a to z, 11 1/6 ems

ABCDEFGHIJKLMN^{OP}QRSTU^{VW}XYZ

abcdefghijklmnopqrstu^{vwxyz}

ABCDEFGHIJKLMN^{OP}QRSTU^{VW}XYZ

1234567890 1234567890

Lining Ronaldson Oldstyle No. 551

6 POINT LINING RONALDSON OLDSTYLE No. 551

WHEN, in the course of human events, it becomes necessary for one people to dissolve the political bands which have connected them with another, and to assume, among the powers of the earth, the separate and equal station to which the laws of nature and of nature's God entitle them, a decent respect to the opinions of mankind requires that they should declare the causes which impel them to the separation. We hold these truths to be self-evident: That all men are created equal; that they are endowed by their Creator with certain inalienable rights; that among these are life, liberty, and the pursuit of happiness; that, to secure these rights, governments are instituted among men, deriving their just powers from the consent of the governed; that whenever any form of government becomes destructive of these ends, it is the right of the people to alter or to abolish it, and to institute a new government, laying its foundation on such principles, and organizing its powers in such form, as to them shall seem most likely to effect their safety and happiness. Prudence, indeed, will dictate that governments long established should not be changed for light and transient causes; and, accordingly, all experience hath shown that mankind are more disposed to suffer, while evils are sufferable, than to right themselves by abolishing the forms to which they are accustomed. But when a long train of abuses and usurpations, pursuing invariably the same object, evinces a design to reduce them under absolute despotism, it is their right, it is their duty, to throw off such government

Lower case a to z, 15 5-6 ems

ABCDEFGHIJKLMN OPQRSTUVWXYZ
 abcdefghijklmnopqrstuvwxyz
 ABCDEFGHIJKLMN OPQRSTUVWXYZ
 1234567890 1234567890

7 POINT LINING RONALDSON OLDSTYLE No. 551

WHEN, in the course of human events, it becomes necessary for one people to dissolve the political bands which have connected them with another, and to assume, among the powers of the earth, the separate and equal station to which the laws of nature and of nature's God entitle them, a decent respect to the opinions of mankind requires that they should declare the causes which impel them to the separation. We hold these truths to be self-evident: That all men are created equal; that they are endowed by their Creator with certain inalienable rights; that among these are life, liberty, and the pursuit of happiness; that, to secure these rights, governments are instituted among men, deriving their just powers from the consent of the governed; that whenever any form of government becomes destructive of these ends, it is the right of the people to alter or to abolish it, and to institute a new government, laying its foundation on such principles, and organizing its powers in such form, as to them shall seem most likely to effect their safety and happiness. Prudence, indeed, will dictate that governments long established should not be changed for light and transient causes; and, accordingly, all experience hath shown

Lower case a to z, 15 ems

ABCDEFGHIJKLMN OPQRSTUVWXYZ
 abcdefghijklmnopqrstuvwxyz
 ABCDEFGHIJKLMN OPQRSTUVWXYZ
 1234567890 1234567890

8 POINT LINING RONALDSON OLDSTYLE No. 551

WHEN, in the course of human events, it becomes necessary for one people to dissolve the political bands which have connected them with another, and to assume, among the powers of the earth, the separate and equal station to which the laws of nature and of nature's God entitle them, a decent respect to the opinions of mankind requires that they should declare the causes which impel them to the separation. We hold these truths to be self-evident: That all men are created equal; that they are endowed by their Creator with certain inalienable rights; that among these are life, liberty, and the pursuit of happiness; that, to secure these rights, governments are instituted among men, deriving their just powers from the consent of the governed; that whenever any form of government becomes destructive of these ends, it is the right of the people to alter or to abolish it and to institute a new government, laying its foundation on such principles, and organizing its powers

Lower case a to z, 13 15-16 ems

ABCDEFGHIJKLMN OPQRSTUVWXYZ
 abcdefghijklmnopqrstuvwxyz
 ABCDEFGHIJKLMN OPQRSTUVWXYZ
 1234567890 1234567890

Lining Ronaldson Oldstyle No. 551

9 POINT LINING RONALDSON OLDSTYLE No. 551

WHEN, in the course of human events, it becomes necessary for one people to dissolve the political bands which have connected them with another, and to assume, among the powers of the earth, the separate and equal station to which the laws of nature and of nature's God entitle them, a decent respect to the opinions of mankind requires that they should declare the causes which impel them to the separation. We hold these truths to be self-evident: That all men are created equal; that they are endowed by their Creator with certain inalienable rights; that among these are life, liberty, and the pursuit of happiness; that, to secure these rights, governments are instituted among men, deriving their just powers from the consent of the governed; that when ever any form of government becomes destructive of these ends, it is the right of the people to alter or to abolish it, and to institute a new government, lay its foundation on such principles, and organizing its powers in such form, as to them shall seem most likely to effect their safety and happiness. Prudence, indeed, will dictate that governments long established should not be changed for light and transient causes; and, accordingly, all experience hath shown that mankind are more disposed to suffer, while evils are sufferable, than to right themselves by abolishing the forms to which they are accustomed. *But, when a long train of abuses and usurpations, pursuing invariably the same object, evinces a design to reduce them under absolute despotism, it is*

Lower case a to z, 13.5-9 ems

ABCDEFGHIJKLMN O PQRSTU VWXYZ
abcdefghijklmnopqrstu vwxyz
ABCDEFGHIJKLMN O PQRSTU VWXYZ
1234567890 1234567890

10 POINT LINING RONALDSON OLDSTYLE No. 551

WHEN, in the course of human events, it becomes necessary for one people to dissolve the political bands which have connected them with another, and to assume, among the powers of the earth, the separate and equal station to which the laws of nature and of nature's God entitle them, a decent respect to the opinions of mankind requires that they should declare the causes which impel them to the separation. We hold these truths to be self-evident: That all men are created equal; that they are endowed by their Creator with certain inalienable rights; that among these are life, liberty, and the pursuit of happiness; that, to secure these rights, governments are instituted among men, deriving their just powers from the consent of the governed; that whenever any form of government becomes destructive of these ends, it is the right of the people to alter or to abolish it, and to institute a new government, laying its foundation on such principles, and organizing its powers in such form, as to them shall seem most likely to effect their safety and happiness. Prudence, indeed, will dictate that governments long established should not be changed for light and transient causes; and, accordingly, all experience hath shown that mankind are more disposed to suffer,

Lower case a to z, 13 ems

ABCDEFGHIJKLMN O PQRSTU VWXYZ
abcdefghijklmnopqrstu vwxyz
ABCDEFGHIJKLMN O PQRSTU VWXYZ
1234567890 1234567890

Partly opened with two point leads.

Lining Ronaldson Oldstyle No. 551

11 POINT LINING RONALDSON OLDSTYLE No. 551

WHEN, in the course of human events, it becomes necessary for one people to dissolve the political bands which have connected them with another, and to assume, among the powers of the earth, the separate and equal station to which the laws of nature and of nature's God entitle them, a decent respect to the opinions of mankind requires that they should declare the causes which impel them to the separation. We hold these truths to be self-evident: That all men are created equal; that they are endowed by their Creator with certain inalienable rights; that among these are life, liberty, and the pursuit of happiness; that, to secure these rights, governments are instituted among men, deriving their just powers from the consent of the governed; that whenever any form of government becomes destructive of these ends, it is the right of the people to alter or to abolish it, and to institute a new government, laying *its foundation on such principles, organizing its powers in such form, as to them shall seem most likely to effect their safety and happiness.*

Lower case a to z, 12 6-11 ems

ABCDEFGHIJKLMN^oQRSTU^vWXYZ
 abcdefghijklmⁿopqrstu^vwxyz
 ABCDEFGHIJKLMN^oQRSTU^vWXYZ
 1234567890 1234567890

12 POINT LINING RONALDSON OLDSTYLE No. 551

WHEN, in the course of human events, it becomes necessary for one people to dissolve the political bands which have connected them with another, and to assume, among the powers of the earth, the separate and equal station to which the laws of nature and of nature's God entitle them, a decent respect to the opinions of mankind requires that they should declare the causes which impel them to the separation. We hold these truths to be self-evident: That all men are created equal; that they are endowed by their Creator with certain inalienable rights; that among these are life, liberty, and the pursuit of happiness; that, to secure these rights, governments are instituted among men, deriving their just powers from the consent *of the governed; that whenever any form of government becomes destructive of these ends, it is the right of the people to alter or*

Lower case a to z, 12 11-21 ems

ABCDEFGHIJKLMN^oQRSTU^vWXYZ
 abcdefghijklmⁿopqrstu^vwxyz
 ABCDEFGHIJKLMN^oQRSTU^vWXYZ
 1234567890 1234567890

Partly opened with two point leads

14 POINT LINING RONALDSON OLDSTYLE No. 551

WHEN, in the course of human events, it becomes necessary for one people to dissolve the political bands which have connected them with another, and to assume, among the powers of the earth, the separate and equal station to which the laws of nature and of nature's God entitle them, a decent respect to the opinions of mankind requires that they should declare the causes which impel them to the separation. We hold these truths to be self-evident: That all men are created equal; that they are endowed by their Creator with certain inalienable rights; that among these are life, liberty, and the pursuit of happiness; that, to

Lower case a to z, 13 5-11 ems

ABCDEFGHIJKLMN^QRSTUVWXYZ
 abcdefghijklmnopqrstu^vwxyz
 ABCDEFGHIJKLMN^QRSTUVWXYZ
 1234567890

18 POINT LINING RONALDSON OLDSTYLE No. 551

When, in the course of human events, it becomes necessary for one people to dissolve the political bands which have connected them with another, and to assume, among the powers of the earth, the separate and equal station to which the laws of nature and of nature's God entitle them, a decent respect to the opinions of mankind requires that they should declare the causes which

Lower case a to z, 12 1-18ems

ABCDEFGHIJKLMN^QRSTUVWX
 abcdefghijklmnopqrstu^vwxyz
 1234567890

6 POINT LINING FRENCH OLDSTYLE No. 552

WHEN, in the course of human events, it becomes necessary for one people to dissolve the political bands which have connected them with another, and to assume, among the powers of the earth, the separate and equal station to which the laws of nature and of nature's God entitle them, a decent respect to the opinions of mankind requires that they should declare the causes which impel them to the separation. We hold these truths to be self-evident: That all men are created equal; that they are endowed by their Creator with certain inalienable rights; that among these are life, liberty, and the pursuit of happiness; that to secure these rights governments are instituted among men, deriving their just powers from the consent of the governed; that, whenever any form of government becomes destructive of these ends, it is the right of the people to alter or to abolish it and to institute a new government, laying its foundations on such principles, and organizing its powers in such form, as to them shall seem most likely to effect their safety and happiness. Prudence, indeed, will dictate that governments long established should not be changed for light and transient causes; and, accordingly, all experience hath shown that mankind are more disposed to suffer, while evils are sufferable, than to right themselves by abolishing the forms to which they are accustomed. But, when a long train of abuses and usurpations, pursuing invariably the same object, evinces a design to reduce them under absolute despotism, it is their right, it is their duty, to throw off such government and to pro-

Lower case a to z, 14 ems

ABCDEFGHIJKLMN O PQRSTU VWXYZ
 abcdefghijklmnopqrstuvwxy
 ABCDEFGHIJKLMN O PQRSTU VWXYZ
 1234567890 1234567890

8 POINT LINING FRENCH OLDSTYLE No. 552

WHEN, in the course of human events, it becomes necessary for one people to dissolve the political bands which have connected them with another, and to assume, among the powers of the earth, the separate and equal station to which the laws of nature and of nature's God entitle them, a decent respect to the opinions of mankind requires that they should declare the causes which impel them to the separation. We hold these truths to be self-evident: That all men are created equal; that they are endowed by their Creator with certain inalienable rights; that among these are life, liberty, and the pursuit of happiness; that to secure these rights, governments are instituted among men, deriving their just powers from the consent of the governed; that, whenever any form of government becomes destructive of these ends, it is the right of the people to alter or to abolish it and to institute a new government, laying its foundations on such principles, and organizing its powers in such form, as to them shall seem

Lower case a to z, 12 1/4 ems

ABCDEFGHIJKLMN O PQRSTU VWXYZ
 abcdefghijklmnopqrstuvwxy
 ABCDEFGHIJKLMN O PQRSTU VWXYZ
 1234567890 1234567890

9 POINT LINING FRENCH OLDSTYLE No. 552

WHEN, in the course of human events, it becomes necessary for one people to dissolve the political bands which have connected them with another, and to assume, among the powers of the earth, the separate and equal station to which the laws of nature and of nature's God entitle them, a decent respect to the opinions of mankind requires that they should declare the causes which impel them to the separation. We hold these truths to be self-evident: That all men are created equal; that they are endowed by their Creator with certain inalienable rights; that among these are life, liberty, and the pursuit of happiness; that to secure these rights, governments are instituted among men, deriving their just powers from the consent of the governed; that, whenever any form of government becomes destructive of these ends, it is the right of the people to alter or to abolish it and to institute a new government, laying its foundations on such principles, and organizing its powers in such form, as to them shall seem most likely to effect their safety and happiness. Prudence, indeed, will dictate that governments long established should not be changed for light and transient causes; and, accordingly, all experience hath shown that mankind are more disposed to suffer, while evils are sufferable, than to right themselves by abolishing the forms to which they are accustomed. But, when a long train of abuses and usurpations, pursuing invariably the same object, evinces a design to reduce them under absolute despotism, it is their right, it is their duty, to throw off such government and to provide new guards for their future security. Such has been the

Lower case a to z, 12 1/9 ems

ABCDEFGHIJKLMN O PQRSTU VWXYZ
 abcdefghijklmnopqrstuvwxy
 ABCDEFGHIJKLMN O PQRSTU VWXYZ
 1234567890 1234567890

Lining French Oldstyle No. 552

10 POINT LINING FRENCH OLDSTYLE No. 552

WHEN, in the course of human events, it becomes necessary for one people to dissolve the political bands which have connected them with another, and to assume, among the powers of the earth, the separate and equal station to which the laws of nature and of nature's God entitle them, a decent respect to the opinions of mankind requires that they should declare the causes which impel them to the separation. We hold these truths to be self-evident: That all men are created equal; that they are endowed by *their Creator with certain inalienable rights; that among these are life, liberty, and the pursuit of happiness; that, to secure these rights, governments are*

Lower case a to z, 12 1/2 em

ABCDEFGHIJKLMN OPQRSTUVWXYZ

abcdefghijklmnopqrstu vwxyz

ABCDEFGHIJKLMN OPQRSTUVWXYZ

1234567890 1234567890

12 POINT LINING FRENCH OLDSTYLE No. 552

WHEN, in the course of human events, it becomes necessary for one people to dissolve the political bands which have connected them with another, and to assume, among the powers of the earth, the separate and equal station to which the laws of nature and of nature's God entitle them, a decent respect to the opinions of mankind requires that *they should declare the causes which impel them to the separation. We hold these truths to be self-evident: That all men*

Lower case a to z, 13 em

ABCDEFGHIJKLMN OPQRSTUVWXYZ

abcdefghijklmnopqrstu vwxyz

ABCDEFGHIJKLMN OPQRSTUVWXYZ

1234567890 1234567890

18 POINT LINING FRENCH OLDSTYLE No. 552

When, in the course of human events, it becomes necessary for one people to dissolve the political bands which have connected them with another, and to assume, among the powers of the earth, the separate and equal station

Lower case a to z, 11 1/9 em

ABCDEFGHIJKLMN OPQRSTUVWXYZ

abcdefghijklmnopqrstu vwxyz

1234567890



American Line Leaders

IN another section of this Catalogue (see index) will be found a showing of a complete assortment of American Line Leaders, made in five styles: one dot to the em, two dots to the em, three dots to the em, fine hyphen face and the regular hyphen face. The sizes range from five to eighteen points. These are the only correctly proportioned and accurately cut leaders on the market, this perfection being attained through the use of tools invented and used exclusively for the purpose by the American Type Founders Company. These leaders are cast from copper alloy type metal, excelling in lightness and durability. American Line Leaders are put up in job fonts of three and five pounds each and are sold at regular body type prices,—the same prices, in fact, as are charged when buying them in bulk. These small fonts have proved a great convenience to our customers



ATALOGUE BOOKLET & DISPLAY TYPE

For Commercial and Fine Art Printing and for Printed Salesmanship this section contains a collection (never before equalled in numbers) of the most Attractive, Popular and Successful Type Faces ever made—the types that have made Printing more PROFITABLE and widened the range of the Printing Business. To these assured money-makers are now added many NEW Faces equal if not superior in value to the printers in Business-Attracting Power

AMERICAN
TYPE FOUNDERS
COMPANY



Announcement



The following pages contain a complete and concise showing of a number of desirable type faces, among them being the great Cheltenham Family, the popular Century Family (a type without hair lines), the classic Clearface Family, the distinctive Litho Family, the Copperplate Family, the finest selection of useful Gothic Faces ever shown in one book, together with an excellent array of catalogue, newspaper, book and job faces

72 Point

3 A \$6 45 4 a \$3 75 \$10 20

NUMBERING
Strange Machine

60 Point

3 A \$5 40 4 a \$3 10 \$8 50

BRIGHT HOME
Compact Kingdoms

48 Point

4 A \$4 05 8 a \$3 45 \$7 50

DEMURE HUNTER
Extraordinary Adventure

42 Point

5 A \$3 65 8 a \$2 60 \$6 25

STRONG REMINDERS
Quaint Construction Noticed
Romantic Maiden Dreaming

36 Point

5 A \$2 85 8 a \$2 15 \$5 00

NEIGHBORS MENTIONED

Confiscating Historical Documents Sarcastic Remarks Create Disorder

30 Point

6 A \$2 40 10 a \$1 85 \$4 25

CUSTOMERS RECONSIDERING

Metropolitan Organizations Discontinued Delivering Numerous Campaign Orations

24 Point

6 A \$1 85 12 a \$1 65 \$3 50

BROKERS RETURN

Extemporaneous Speakers Consistently Remunerated

11 Point

20 A \$1 40 42 a \$1 35 \$2 75

INTRODUCTION OF PRINTING
Many Historians Contend That the Art of Printing Was Introduced and First Used in England by Caxton, Who, by His Great Intelligence, Quickly Mastered This Idea and Method of the Process While Abroad

18 Point

10 A \$1 65 21 a \$1 60 \$3 25

DETERMINED STUDENT

Gorgeous Receptions Introduced Handsome Compartment Sought

10 Point

21 A \$1 15 42 a \$1 35 \$2 50

WHITE SPACE IN ADVERTISING
A Judicious Use of White Space is Pleasing
Publisher Strives to Please Critical Advertiser
Answer Questions of Paramount Importance
Greater Historical Plays May Be Produced

14 Point

15 A \$1 50 30 a \$1 50 \$3 00

ENTERPRISING PRODUCTIONS

Remarkable Midnight Seance Discovered Some Meritorious Achievements Ignored Burdensome Schemes Considered Lightly

8 Point

24 A \$1 15 48 a \$1 10 \$2 25

EFFECTIVE AND PROFITABLE RESULTS
If the Advertisers Can Ever Come to Realize the Great Advantages of the Use of White Space, Both They and Publishers Will Reap Harvests; the Advertiser, Because His Ads Will Bring Results, and the Publisher, Because the Advertiser is Sure to Increase the Amount of Space

12 Point

18 A \$1 40 38 a \$1 35 \$2 75

PREDICTING ENORMOUS DEMANDS

Modernized Steamboats Displaying Great Speed Gigantic Liners Race Across the Turbulent Foam Comparable Creation \$1234567890 Advertising

6 Point

24 A \$1 00 48 a \$1 00 \$2 00

REMARKABLE CHARACTERISTICS EMPLOYED
Cheltenham Oldstyle is Pre-eminently Adapted for Newspaper and Magazine Advertisements. The Distinct and Characteristic Features Embodied in These Letters Make it One of the Most Popular Series Ever Offered the Craft. For General Commercial and High-Grade Job Printing no Better Type Face Could Be Suggested, as is Evidenced \$1234567890 by its Universal Use



Electrotype Half-tone No. 3 for two colors; complete \$3.00

MOST RELIABLE INFORMATION CONCERNING BEAUTIFUL SOUTH SHORE HEALTH RESORTS

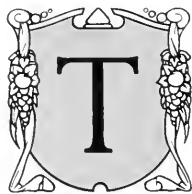

THE South Shore of Long Island, on the sea, will strongly appeal to anyone who enjoys the ocean with its fine surf bathing, sailing and deep-water fishing. The Great South Bay, the Mecca for lovers of aquatic sports, skirts the southern end of Long Island for a distance of nearly eighty miles and is an ideal and safe inland sea for sailing, fishing and still-water bathing. It is hardly necessary to point out the suitable places it contains—the Rockaways, Long Beach and Manhattan Beach—the latter place with its world-renowned Southern Beach and Continental Hotels. The recent improvements at Rockaway Beach make it very desirable for summer residence. The hotel and bathing houses there are attractive features. Belle Harbor, next to Rockaway Beach, is a lovely seaside residential district and many attractive homes are located there. The Belle Harbor Yacht Club is situated on Jamaica Bay, and is one of the features of that lovely place. Following the coast line to the east is Arverne, a modern summer city by the sea, Edgemere, Far Rockaway and other resorts, all delightful places at which to spend the summer or for all-year residence. In addition to the hotels, there are a number of attractive boarding cottages for the convenience of summer visitors who may arrive. These are favorite places with business men, who find their nearness to the city advantageous and their cool nights in the summer particularly inviting. These resorts can be reached in a very short time from New York by way of the Twentieth



GO TO THIS NEW HAMPSHIRE
LAKE RESORT FOR AN OUTING

THE largest and finest sheet of water in New Hampshire, and one of the country's most popular summer resorts, is Lake Winnepesaukee. It is easy to understand why it continues to hold such a high place in the affections of so many vacationists, for there are few lakes in all the world so superbly and splendidly endowed with the attractions of scenery, climate, and social life and enjoyment that go to make up the ideal resting place. One who would not be satisfied with Winnepesaukee would be indeed finical. Large in area, picturesque in conformation and with waters of crystalline purity, its serrated shores are indented the most romantic coves and harbors is partly inclosed by tiers of green hill

Panel Border Versatile Ornament Department-Store Initial

A FINE STOCK OF
**SUMMER
HATS**
ALL THE LATEST
STYLES IN HATS
FOR THE BOY OR
MAN DESIRING A
NEAT AND VERY
CHIC HEADPIECE
HIREMS
MOSTRAND STREET
ELIZABETHPORT

Unit Border

ONE way, the ancient and at one time the only way, of putting a piece of copy into type is as follows: The compositor glances over the manuscript with the wise eye of long practice, does a little rapid figuring with a stubby lead pencil to ascertain what type it will go in, gives his suspenders a hitch, then takes a fresh chew of tobacco and fires away. The result, when well printed, is legible, fairly neat in appearance, and difficult for a layman to criticise, even though he may have an uneasy feeling that it is not what it should be. That is typography, but it is by no means art. Artistic expression by the means of types is sometimes difficult, but always worth while. It means this: Every proposition, if it be manufacturing, mercantile, professional or what not, is surrounded by an individual atmosphere which possesses certain characteristics peculiar to itself. It presents points of individuality which are of importance, which are indeed essential to a complete and precise comprehension of its true character. These characteristics must be set forth by one skilled in the art of phraseology in order that the public may understand them. Then the mechanical details are left to

Times Border

**Quality
is Everything**

Naturally, after having spent nine years in buying advertising printing, I have pretty positive ideas on the subject of quality. The chief of these is that you cannot buy printing by the yardstick. I have found that there is only one way to get good printing, and that is to find a good printer and trust him. As soon as I found such a printer I never even thought of asking for an estimate. When I suggest such a process to a business man he goes up in the air, but that is owing to his own lack of experience and not to the fault of the theory. Of course it would be very easy for a printer to get the best of me once on this plan, but if he expected me to give him my work of quality he would not do it

Hughes Advertising Co.
Corner Quimby and Getty Streets, Newark

72 Point

3 A \$6 15 4 a \$3 30 \$9 45

*HUNDREDS
Greatest Designs*

60 Point

3 A \$5 45 5 a \$3 30 \$8 75

*MINER HIRED
Superior Investment*

48 Point

4 A \$3 75 9 a \$3 75 \$7 50

*DESIGN PRINTING
Secures Beautiful House*

42 Point

5 A \$3 55 8 a \$2 70 \$6 25

*HUNTS KINGFISHER
Pleasant Natural Resources
National Aeroplane Contest*

36 Point

5 A \$2 75 11 a \$2 25 \$5 00

*SPECIAL EXPERIMENTS
Magnificent Novelties Introduced*

30 Point

7 A \$2 35 11 a \$1 90 \$4 25

*DISTINGUISHED REGIMENTS
Encountered Condemned Manufacturer
Interspersed Anatomical Demonstrations*

24 Point

7 A \$1 90 12 a \$1 60 \$3 50

*RECOGNIZE MINOR UNIVERSITIES
Entertainments Advertised Remarkable Benefit
Largest Revolutionary Memorial Contributions*

18 Point

11 A \$1 70 21 a \$1 55 \$3 25

*RECEPTION GIVEN PROMINENT MEMBERS
Discouraged Shareholders Purchased Mechanical Invention
Modern Printers Using Beautiful Cheltenham Italic Often*

14 Point

15 A \$1 55 28 a \$1 45 \$3 00

*SECOND EMINENT MEMBER
Ministers Denied Untruthful Assertions
Engraving Business Conditions Normal*

10 Point

20 A \$1 30 46 a \$1 20 \$2 50

*RETURNING INDIAN HUNTERS
Enthusiastic Nimrods Journeying Eastward
Ladies Studied Interesting Historical Novel
Handsome Tragedian Permanently Secured*

12 Point

17 A \$1 45 36 a \$1 30 \$2 75

*FORMER SUBSCRIBER INDIGNANT
Newspaper Editor Indorsing Sanitary Dwellings
Subscribe Now \$1234567890 Amount Paid*

8 Point

23 A \$1 15 46 a \$1 10 \$2 25

*STAR RECEIVING SCIENTIFIC MENTION
Prominent Business Men Joined the Club Last Night
The Clearest Mountain Streams Rushing in Torrents
Opinions of the Administrators Remained Unchanged*

11 Point

21 A \$1 45 42 a \$1 30 \$2 75

*DISMOUNTING HORSEMEN PICTURED
Soldiers Entertained Distinguished French Merchant
Remarkable Feats Splendidly Performed Regularly*

6 Point

22 A \$1 00 46 a \$1 00 \$2 00

*CHICAGO EXPOSITION DELIGHTS MONARCHS
Exhibitors Strenuously Disapprove Methods Regarding Prizes
Many Northern Manufacturers Compete for Medal of Honor
Newspaper Delegates Received Marked Attention in Newport
Situation Aggravates \$1234567890 Prominent Compositors*



THERE was a time when flat stones with a good grit to them were the best thing we had for doing our grinding. By and by some genius cut the stone round, put a crank through the center of it, and it was then that science recorded the birth of the grindstone and people wondered why nobody had thought of it at some former date. Time passed, grindstones began to accumulate moss of antiquity, until emery and other substances began to take their place in the abrasive and grinding fields. Still science was not content. The diamond seemed to be the only thing that would fill the bill, and the use of diamonds would throw this world into a bankruptcy court within a month if we tried to make grindstones of them; and science mourned. In the meantime a very practical man began turning over in his brain the thought of making diamonds by applying intense electric heat to carbon and silicon. He did more than turn it over in his young mind, he accomplished it and gave the world a much-sought, hard, rough stone that is known everywhere as Carbonine

Bullfinch Border

NOTICE CHANGE OF ADVERTISING RATE

Just a year ago we announced an increase in our advertising rate. We then stated that if the magazine continued to grow in favor and in circulation we should raise the rate with such progress. The Rural Journal is bigger, better and greater than it was a year ago; it costs more to produce and it gives increased value to advertisers who use it. The new rate will be \$100 a page, beginning with the May issue. The average monthly circulation of 145,000 copies will be guaranteed for a magazine advertising year beginning on the first of May. Our advertisers will be privileged to reserve space at the present rate of \$98 a page until the April issue, provided that space so reserved will be continued at least another year. A discount will be allowed on all orders of three or more pages; this is the only discount. The fact that for ten issues of the Rural Journal each one had over one hundred pages of advertising is the best proof of its value as a medium of publicity among many careful advertisers who want the best. When you place your advertising in this paper it will repay you

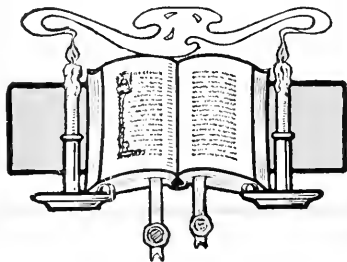

Versatile Ornament

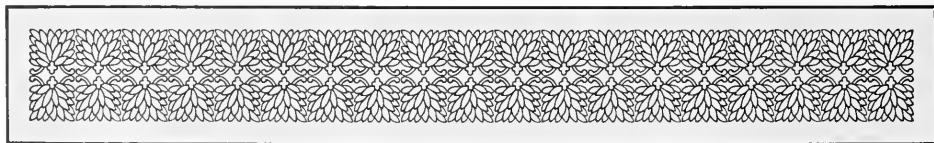

The Rosemont Real Estate and Investment Company

"Own a Home on the Highlands," where you can have Country Comforts with City Conveniences

HOME selecting is becoming more and more difficult. So many conflicting claims are being put forth on behalf of the various new residential sections in and near the city of Cleveland that it is quite a serious problem to choose a site that is satisfactory in every respect. All sorts of arguments are advanced, and all sorts of theories are increasing every day and are being propounded by those who have lots to sell. These are being used simply to assist sales. They do not help the man who wants to know beyond doubt that his home will be permanently satisfactory and increasingly valuable with every passing year. The safest course in such a dilemma is to locate in a section where all the advantages are guaranteed

SATISFACTION

IF YOU WILL take the trouble to inspect our showing of *Suits and Overcoats* for the fall and winter seasons, we are positive that you will be satisfied. The styles we will exhibit for the fall and winter demand will demonstrate beyond a doubt that this is an aggressive house, and sets the pace for this trade in general. There is a class and a standard of quality to these garments which characterize the store selling them as a *first-class house*. They win a prestige, the value of which cannot be at all overestimated. Our prices range lower than other dealers quote

*There
are none
so stylish
as ours*

MINERD HIRSH
THE MODISH CLOTHIER

Chap-Book Director French Cast Squares

G

His Evening Cigars

How about your father's, brother's or husband's cigars? To the most critical man no gift is more welcome than good tobacco, cigarettes, pipes and cigars. We have for sale just what the smoker wants—tobacco of established reputation. Any of these goods may be had all the year round from us. Our big stocks, to meet the holiday demand, include every brand that is familiar to the most discriminating smoker. The man you are going to buy for is sure to be pleased with a gift chosen in our store. Mention a price and we will give you the best for the money

Ghest Company
North End

Della Robbia Ornament

PRINTING PROBLEMS

THE FIRST problem of the composing room is the *arrangement*, and this involves a more detailed attention than it is usually given. The idea of the arrangement must be to bring the number of steps to be taken by the workmen down to a minimum. This arrangement should begin with the laying out of the type faces in the cases. Series frequently used in combination should be placed in proximity. Your text letters and the light-faced gothics used with them in the commercial work should be together. Members of the *Cheltenham Family* should be near one another, so that workmen setting a display announcement or a newspaper advertisement *may waste no steps*. Your composing room should be laid out with a definite idea as to the classes of work to be handled. Each man on blank or book-heading work should have a frame to himself, with his case of eight point for box-head work and display faces within easy reach. Certain alleys should be reserved for small commercial work and the stands should contain the faces regularly used on letterheads, programmes, and other work easily classified. Bold display work may be separate

AMERICAN MATERIAL

Always up to the Very Highest Standards of Accuracy and Finish in every way for best results in the modern printing offices American Type, lining system, is flawless

72 Point

3 A \$5 20 4 a \$3 85 \$9 05

INTERMINGLES
Cheltenham Dame

60 Point

3 A \$4 50 5 a \$3 35 \$7 85

HUNTED ERMINES
Chimes Entertainment

48 Point

4 A \$3 35 7 a \$3 10 \$6 45

FIRST PIGEON REPORT
Instinctive Maternal Lullaby

42 Point

4 A \$2 65 8 a \$2 60 \$5 25

DISTINGUISHED KINGDOM
Maiden Demanding Information
Handsome Christmas Reminder

36 Point

5 A \$2.30 8 a \$1.95 \$4.25

MENTIONING SUBLIME THINGS
International Question Recapitulated
Characteristic Esquimau Decorations

30 Point

6 A \$2.00 12 a \$2.05 \$4.05

EXPERIMENTING TINSMITH DESCRIED
Giving Monster Kindergarten Entertainments
Prominent Bostonian Manufacturer Selected

24 Point

8 A \$1.65 17 a \$1.85 \$3.50

IMPERTINENT REMARK ENJOINED WITH ZEST
Demonstrative Esperanto Linguist Acquires Proficiency
Beautiful Series for Booklet and General Job Printing

18 Point

13 A \$1.60 24 a \$1.65 \$3.25

DESIGNED MODERN SHOWING
Some Rather Select Border Designs
Originality Given Usual Prominence

10 Point

24 A \$1.20 48 a \$1.30 \$2.50

REPORT COLD WINTER ON LAKE HURON
Using Beautiful Cheltenham Oldstyle Condensed
Savage Races Grotesquely Decorate Their Bodies
Humanity Always Did Love Ornament and Color
Curious and Interesting Human Traits Displayed

14 Point

17 A \$1.50 34 a \$1.50 \$3.00

GREAT MERCHANT PRINCE EMBARKS
Important Turkish Mogul Drinks Perfumeries
Pretty Discarded Favorites Quietly Beheaded

8 Point

27 A \$1.05 56 a \$1.20 \$2.25

THE PART THE EYE PLAYS IN FAST TYPE SETTING
Speed of Arm is a Factor of Only Secondary Consideration
Alert Eye Should Continually Scout Ahead of the Fingers
Unerringly Noting the Exact Lay of the Letter in the Cases
Economically and Systematically Directing Each Movement

12 Point

22 A \$1.40 43 a \$1.35 \$2.75

EMOLUMENT AND MUCH RESPECT DESERVED
Printing is Seventh Giant Industry in the United States
Better Day Dawning \$1234567890 Printing Master

6 Point

30 A \$0.95 60 a \$1.05 \$2.00

PROSPEROUS MERCHANTS DISAPPROVED LONG TUNNEL
Magnificent Specimen of American Turkey Anticipated from Student
Extemporaneous Toasts Affording Entertainment with Amusements
August Personages Becoming Intoxicated During Informal Occasion
Indigestion Prevented Through Beneficial and Prolonged Exercising
Frolicing Youngsters and \$1234567890 Some Energetic Compositors

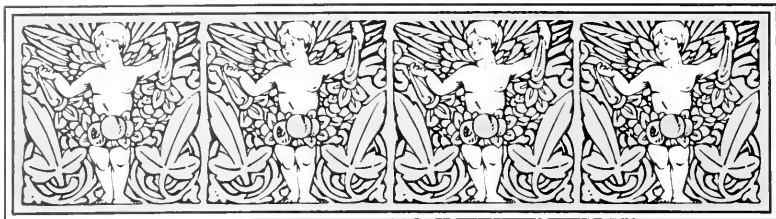

THE EXODUS OF PRINTING



WILLIAM BLADES, in his posthumous historical volume, *The Pentateuch of Printing*, discusses the origin of the art under the head of "Genesis," and its diffusion under that of "Exodus." As both these divisions of typographic history appertain to the fifteenth century, certain individuals being involved in both, they are not always clearly distinguishable even in the minds of the well-informed readers. As matter for history, the invention of printing always has received vastly more attention than the diffusion of the art. Yet the first subject is still involved in a cloud of controversy, its problems being, to a great extent, mechanical, and the very materials which the judgments are to be based upon are scanty or altogether wanting. The second subject is rich in popular as well as technical interest, having even a touch of romance, and its materials are abundant. Yet, so far as the general public is concerned, this



Electrotype Half-tone No. 1 for 2 colors, complete \$2.00

The Chandler & Price Lead and Rule Cutter

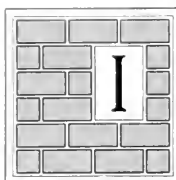

IN this cutter are many valuable features. It is a radical departure from every other style. The bed is nearly vertical, but inclines slightly from the operator. The lead or rule rests on a raised guide along the lower edge and automatically assumes a true position by gravity, assuring a square cut. The guide is accurately graduated to 12-point ems and numbered to 5-em lengths. The gauge is reversed for cutting leads required longer than the bed, and

is fitted with a latch to engage the slots of the guide. The position of the guide is such that the graduated scale is always in full view and is immediately seen without stooping over and without strain on the eyes. A thumb-screw holds the gauge for odd lengths. Gauges 14-inches—from zero to 85 ems.

In the Chandler & Price Lead and Rule Cutter the cutting mechanism is designed for accuracy and special rigidity. The two cutting blades are practically built to each other by being fastened at both ends, which keeps them working tightly together. Powerful leverage and the rigidity of adjustment are characteristic in this cutter.

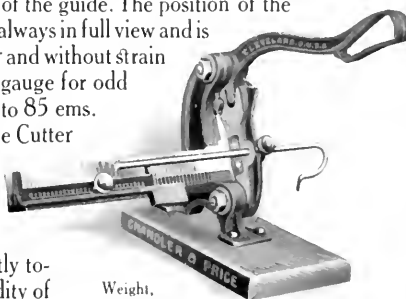

Weight, boxed, 15 pounds

The gauges on this cutter, when properly adjusted, cannot possibly slip; they are accurate and are sure to remain so. Short measures are quickly cut on the front gauge

The Chandler & Price Mitering Machine

This is a strong, well-built machine for mitering brass and metal rule to any desired angle. By adjusting the screw at the end of the hub the knife can be instantly set to cut any desired strength, making it convenient to start a miter with a strong shave, thus cutting more rapidly, and then toning the shave down to accuracy in the finishing. A good mitering machine

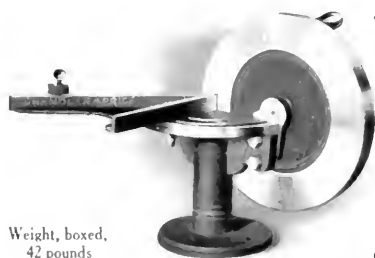

Weight, boxed, 42 pounds

is one of the handiest implements around a composing room—a tool that is useful in so many ways that it will pay for itself in economized time. The Chandler & Price Machine is different from all others in design. It combines strength with simplicity. The knife is made of the very best steel and is easily sharpened, thereby insuring a good miter

Half-tone Cuts used on this page are taken from Chandler & Price catalogue

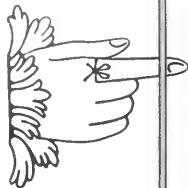

YOU SURELY CAN NOT AFFORD TO FORGET the **FARMING JOURNAL**

IT being the *best medium* for the advertiser in and about the farming region of Butler and surrounding counties, and is read by more families of the better class than any other paper in the State. Its columns contain a fund of information of especial importance to agriculturalists in particular, as well as the important local, national and foreign news. No questionable articles are printed in Farming Journal

ISSUED EVERY SATURDAY

Single Copies
Seven Cents
Three Dollars a
Year; One-Fifty
for Six Months

Panel Border Bullfinch Attractor

May Peace Abound



A
Christmas
Carol

Issued by
Hanover Publishing Company
Philadelphia, Pa.

Holiday Decorator



THIS STITCHER IS SO MUCH DIFFERENT AND BETTER THAN ANY OF ITS RIVALS THAT COMPARISON WOULD BE AN INJUSTICE TO IT

THE BOSTON WIRE STITCHER

The Single Adjustment Feature of the *Boston Wire Stitcher* is a valuable time and money saver. By turning the hand wheel at the back of the machine to gauge the thickness of the work, all the parts, including the feed, the cutter, clinchers and table, are automatically adjusted, and the first stitch driven is perfect. This one feature does away with the many expensive accidents typical of all competitive machines and places the *Boston Stitcher* at the top notch as a time and money saver. It should be remembered that from three to six different operations are necessary in other stitchers having any adjustment for length of stitch, and those without adjustment are capable of stitching but a few sheets at each operation. *The simplicity of adjustment is a desirable feature of this useful machine*

Rapid, Simple and Very
Best Stitching Machine

AMERICAN TYPE FOUNDERS COMPANY

Century Border Cast Squares



A Beautiful Residence

IN A MASTER DEVELOPMENT. All those up-to-date features that make for comfort and livableness, and which are usually associated only with high-cost houses, are to be found, at moderate prices, in the beautiful residences just completed, and welcoming your inspection at

Mount Elmwoods on Central Bayshore Electric Line

Built on plots 150 x 300, equal to 14 city lots and within easy walking distance of the station

Each residence has large living room, butler's kitchen finished in tile and white enamel with running water and range, laundry, library and from three to eight large light and airy sleeping rooms and roomy porch. Gas and electric fixtures, screens, shades and awnings are installed in every property. Decorations quaint, restful and harmonizing with the finish of all the wood work

Prices begin at \$3,500, then \$4,200, \$4,800 and up to \$12,000. Also a limited number ranging from \$15,000 to \$20,000. Any of these beautiful, modern residences may be purchased on terms to suit conservative buyers

One-Half Acre Cottage Plots, \$1,500. \$125 Down and \$10 Monthly. Write for Booklet

H. M. Hartman & Co.

Number 98 Brotherlove Avenue, Philadelphia

Panel Border Renaissance Ornament



EASTER

ONE WEEK FROM NEXT SUNDAY

Easter garb for clergy, clerical clothing, Latin and Anglican cassocks, albs and surplices, and pulpit gowns; in fact, everything that the clergy wears. Easter garb for choristers can be found here in a fine line of cassocks in black and colors, also cottas; in fact, we now have complete choir outfits in the very best of fabrics. Even the altar boys have not been forgotten as our excellent line of cassocks and surplices will show. Our new display of Easter neckwear merits your inspection—the season's best

HANCOCK & GORSDON
THE BROADWAY DEPARTMENT STORE

Panel Border Holiday Decorator

If your competitor talks about you
put him on the payroll. Never mind
what he says as long as he talks

72 Point

3 A \$6 50 4 a \$4 50 \$11 00

RED SHRINE
Brightest Morn

60 Point

3 A \$5 40 4 a \$3 60 \$9 00

PUNISHMENTS
Question Studied

48 Point

4 A \$4 05 8 a \$3 90 \$7 95

MODERN BAKERS
Increase Expenditures

42 Point

4 A \$3 15 8 a \$3 10 \$6 25

ENRICHES KINGDOM
Madros Printing Concern
Expenditures Decreasing

36 Point

5 A \$2.85 8 a \$2.30 \$5.15

DOMESTIC ORNAMENTS

Sanitary Regulation Enforced Manufacturing Improvements

30 Point

5 A \$2.05 10 a \$2.20 \$4.25

BEFRIENDS MUSIC PUBLISHER

Results Surprised Optimistic Dealers Harmonious Environs Indispensable

24 Point

6 A \$1.85 12 a \$1.75 \$3.60

KNIGHTS EMBARK

Bold Heroic Stratagem Disperse Cruel Enemy

11 Point

20 A \$1.40 42 a \$1.55 \$2.95

HANDSOME EDITION PRINTED
Light Blue and Gold Cover Ornament
Designed Neat Eleven Point for Body
Soft, Shade of Color Restful to the Eye
Constructing Bridges Along Railroad
Better Hardened Armor Plates Used

18 Point

10 A \$1.65 21 a \$1.70 \$3.35

HISTORICAL MANSIONS

Big Fonts of Our Cheltenham Intelligent Catalogue Layouts

10 Point

21 A \$1.15 42 a \$1.40 \$2.55

THE ADVERTISING LITERATURE
Famous Cheltenham Family Beautiful
Craft Realizing the Artistic Possibilities
Startling Beauty Ingeniously Exhibited
New American Typography Creations

14 Point

15 A \$1.50 30 a \$1.60 \$3.10

SOLID GRECIAN PRODUCTION

Organizer Endorses New Candidate International Corporation Established Delegates Nominate California Man

8 Point

24 A \$1.15 48 a \$1.30 \$2.45

BEST FACILITIES FOR MANUFACTURING
Superior Products Not an Accident but Usually
The Result of Continued and Painstaking Effort
Machinery and Workmen Also Important Factor
Labor-Saving Devices Help Increase the Output
Wheels of Progress Kept Turning Every Hour

12 Point

18 A \$1.40 38 a \$1.50 \$2.90

LATEST REVOLUTIONARY NOTICES

Beautiful Specimens Reward Neat Students Secret Conference Concerning the Exchequer Superintending \$1234567890 Constructions

6 Point

24 A \$1.00 48 a \$1.05 \$2.05

INTERESTING LECTURE REGARDING FINANCE
Surprisingly and Unusually Large Orders Just Received
Prosperous Proprietor Met Representative on the Square
Complete Series of Many New Faces in Very Large Fonts
Borders, Ornaments, Labor-Saving Brass Rules, Leaders
Large Sign Posted, No More Picking Sorts from Live Jobs
Bank Establishment \$1234567890 Using Much Currency

Berkshire Mountain Hotel



SITUATED IN THE BEAUTIFUL BERKSHIRE HILLS IN THE COUNTY OF CUMBERLAND AND SURROUNDED BY WONDERFUL BIRCH FORESTS

Sixty Miles North of Greenfield Manor

Old English Border Strathmore Mortised Initials

How Shall I Spend My Vacation?

is a question that looms large upon the horizon of the man or woman worn with the social or business activities of the past winter. The boon of the modern vacation is used by some and abused by others. What do you want to do with your vacation? It should be a period of rest and leisure. Its value lies in making it so. It has been given you for the purpose of revitalizing yourself. The place to do this is not upon board walks or amid the rabble sounds of strange cities. It is impossible in a hostelry where social ostentation tempers the air, however pure and sweet the air may be. The place to go for new life and new energy is where nature rules supreme, and that is to the Berkshire Mountains

Old English Border

This page of display is set in Cheltenham Wide, which is a member of the large and popular Cheltenham Family. For fine booklet work it would be difficult to secure a more excellent design. It is extremely legible, very attractive, and retains the many strong features which have created the great popularity of the family

TILES

And Their Uses



SEND FOR OUR BOOKLET

There are a number of places in that *new residence* you are planning to erect where tiles can be used to better advantage than any other material. There are at least four places where tiles are essential: the fireplace, the porch floor, the bathroom floor and walls; they may also be used to advantage in kitchen and laundry. In order that we may better explain to you our line of tiles for every purpose, we have prepared a booklet covering these points in a most interesting manner. It treats of the ornamental and decorative features of tiles, inlaid floors and mantels. *We will present this free* to any home builder. You will do well to read it before perfecting your building plans. The booklet itself is a work of art

WINCHESTER MANTEL COMPANY

Factory, Moxham, Indiana

Branch Office, 816 Lafayette Street, Uniontown

Cast Squares Art Tile Tint Formers Tricky Border

Inspect Our Gold Fish

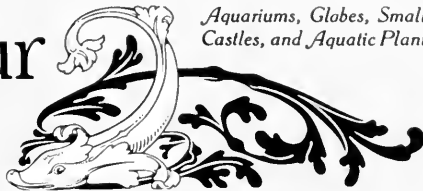

*Aquariums, Globes, Small
Castles, and Aquatic Plant*

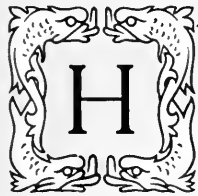

HAVE you ever watched a globe full of little gold fish disporting themselves in the welcome sunshine of a spring day? How their golden bodies glisten; how they dart here and there looking like a ray of the warm light of which they seem a part. These pretty little creatures are a species of *Carp* and are brought here from *China* where their color is produced by artificial selection, being in their natural state of a greenish tint. Are you interested in these little fish so much loved and admired for their beauty and grace, a means of decoration to any home or office, of no little instruction to the young? *Inspect our large supply* of the pretty little gold fish, also the artistic and attractive homes for them in the way of miniature aquariums, globes and castles. *Our store is open every evening*

KINGSLEY GOLD FISH STORE

NEAR THE PARK

72 Point

3 A \$6 70 4 a \$4 35 \$11 05

UNDERMINE
Honest Sailors

60 Point

3 A \$5 30 6 a \$4 80 \$10 10

MUSIC ENDING
Studious Mothers

48 Point

4 A \$4 05 7 a \$3 55 \$7 60

DESIGNS PLEASED
Silver Hunters Return

42 Point

5 A \$3 60 8 a \$3 00 \$6 60

HANDSOME GERMAN
Ninety Thousand Soldiers
Produced Beautiful Effect

36 Point

5 A \$2.55 9 a \$2.45 \$5.00

DELIGHTFUL EXCURSION
Promised Rewards Compared
Show Handsome Photographs

30 Point

6 A \$2.25 10 a \$2.00 \$4.25

SECURING AMERICAN DESIGNS
Great Masterpieces Originated Here
Cheltenham Medium Brings Returns

24 Point

7 A \$1.70 14 a \$1.80 \$3.50

COMPLETE PRINTING INSTRUCTIONS
Much Harmony Embodied Through Studies
American Encouraging Uniform Hospitality

18 Point

11 A \$1.60 21 a \$1.65 \$3.25

HUNDREDS PROSPERING
Cleverly Established Business
Styles Universally Maintained

10 Point

19 A \$1.20 38 a \$1.30 \$2.50

MAHOGANY FURNITURE SALES
New Theaters Have Grand Concerts
Invigorating Enjoyment Through Surf
Romantic Excursion During Autumn
Conservative Newspaper Publications

14 Point

15 A \$1.45 28 a \$1.55 \$3.00

PRINTERS RECEIVING PROFITS
Richly Bronzed Antique Ornaments
Mutual Admiration Society Formed

8 Point

22 A \$1.05 45 a \$1.20 \$2.25

FINE ORIGINAL PRODUCT DEMOLISHED
Traveling Salesmen Hold Convention in Ohio
Making Arrangements for Business Meetings
Better Transit Facilities Are Being Denounced
Natural Beauty of Colorado Mountain Scenery

12 Point

17 A \$1.35 34 a \$1.40 \$2.75

PUBLIC DEMANDING THIS PRODUCT
Harmony Between Printer and Customers
Our Materials Produced Great Satisfaction
Neat Designs \$1234567890 Big Earnings

6 Point

26 A \$0.95 50 a \$1.05 \$2.00

DEVELOPMENT OF STEEL AND IRON INDUSTRY
Purchasing Numerous Holiday Novelties for Merchants
Remarkable Gathering of Bright and Enterprising Men
Performance Every Wednesday Afternoon and Evening
Manufacturers Will Exhibit Marine Engines and Boilers
Injured in Automobile Accident on Railroad Crossing
Fine Entertainment \$1234567890 Excellent Collation

Business Methods

A MONTHLY REMINDER OF TOPICS IN OUR FACTORIES

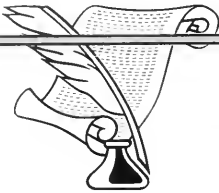

Special Talks on Advertising

Regarding Its Advantages and Power

Versatile Ornament

INFLUENCE OF THE TRADE JOURNAL ON OUR INDUSTRIAL DEVELOPMENT



NEVER has it been reported that Aesop published a technical journal, but it is widely known that he possessed a generous supply of the truly American advantage, practical common sense. Thus equipped, and with his ability to present his message in an attractive form, he might have justly aspired to the profession of journalism (even technical journalism) but for the fact that he was born some thousands of years too soon. One of the Aesop stories relates how a certain husbandman told his sons that he had left unto them gold buried under the ground in his vineyard, and they dugged all over the ground and of the gold they found none, but by reason of stirring and digging the mould about the roots of their vines, they had a very good vintage the next year. Lord Bacon, another philosopher who ought to have been an American, repeats this fable with the following comment: "So, assuredly the search and stir to make gold hath brought to light a great number of good and fruitful inventions and experiments, as well for the disclosing of nature as for the use of man's life." Now, it is just along these lines that the

Strathmore Mortised Initial

JUST ENOUGH DIVERSION

To secure proper attention and a large circulation many successful proprietors agree that in the judicious handling of copy for reading matter lies the way to progress. To our pages is credited many facts that divert and amuse



\$3.00
Per Annum

THE MODERN POST



\$1.50
Six Months

THE glory and power of Printing is not in the past. Its influence at the present time makes it a powerful conservator of all human acts and progress. It is the handmaiden of all the arts, industries and sciences, and the most energetic worker in the world's shop to polish and refine the civilization of this age and the future. When we consider its mission, and see in it all the great possibilities for perpetuating the inventions and knowledge of all eternity, we may well designate present printing as the Art Preservative of all Arts



THE
ORANGE GROVE

WHEN we speak of oranges, we at once bring before our minds a vision of the beautiful State of Florida, the flowery peninsula, where flows the fountain of youth perpetual. How would you like to own a few acres of the orange country? You will not find a more pleasant place for a home in all the world than among the orange trees with their fragrant blossoms and their golden fruit. The Key West Real Estate Company will mail you a portfolio containing actual photographs of the orange territory showing groves at all seasons of the year. In this portfolio are also views of the Everglades, Cypress Springs, and some interesting historical sites in quaint old St. Augustine. Fill out the enclosed blank and mail to us, and receive this collection of views from Florida. This land lies close to the great Indian River district and is known to be free from destructive early frosts. Jacksonville lies but a few miles away and is reached by one of the best roadways in the State. Florida has an annual production of many thousands of

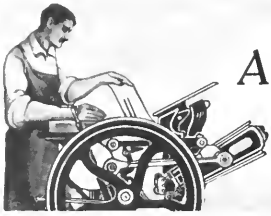

An Interesting Story

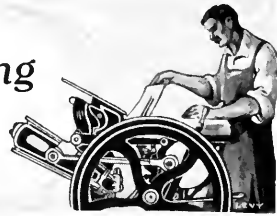

Electrotype Half-tone No. 2 for 2 colors complete \$2 00

ABOUT THE CHANDLER & PRICE GORDON PRESS

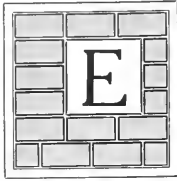

ENTERPRISING printers are appreciating the important points which make this press far superior to any other. In ninety out of one hundred printing offices in the country, the Chandler & Price Gordon Press is certainly the greatest money-maker in proportion to investment and cost of operation of any of the equipment. When other presses are idle in a shop, this press is usually busy and crowded with work. It is undoubtedly true that the foundations of a big majority of the successes made in the printing business during the past twenty years were laid with the profits made upon Chandler & Price Gordon Presses. Although the first of these machines was built in the year 1886, most of them are still in use. Printers will part with other presses for new ones, but they hold on to their Chandler & Price Gordons. This is proved by the fact that though thirty-four thousand of these machines are in use, it is an unusual thing to find a second-hand Chandler & Price Press that is offered for sale, they being so well constructed they outlast all other makes.

The Design or Mechanical Principles

A machine of few parts has a distinct advantage over a machine having many parts, provided it does its work equally well. That is one of the great advantages of the Chandler & Price Gordon Press, as it has fewer parts than any other type of job press, and its work is excelled by no other. The fact that there are over thirty-four thousand Chandler & Price Gordon Presses in every-day use should be sufficient evidence that they give first-class satisfaction. The design and mechanical principles involved make Chandler & Price Gordon Presses as nearly "fool proof" as a printing press can possibly be made. It has no complicated parts, and is simplicity itself in all its movements, thereby reducing most repair costs.

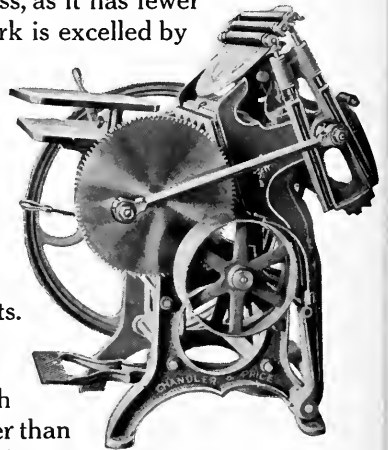

Weight Balanced Perfectly

The Chandler & Price Gordon Presses weigh from three hundred to five hundred pounds heavier than other presses of the same type, the extra material being largely in the frames, the platen and the bed, though it is distributed in proportion through the other parts of the machine on which strain of impression is thrown. Great care has been used to distribute the weight so that all parts

Half-tone Cuts used on this page taken from Chandler & Price Catalogue

Some Marine Expeditions Under Extraordinary Men

GIVING A COMPLETE AND DESCRIPTIVE ACCOUNT OF THE CRUISE
THROUGH THE PERILOUS CHANNELS TAKEN BY THE SEARCHERS

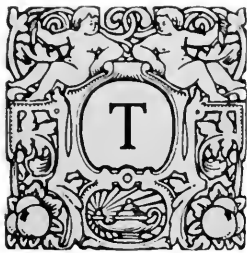

THESE marvellous and very exciting adventures of John Amond, his servant Conseil, and a Norwegian harpooner, Ned Jenson, had their origin in 1867. For many weeks ocean vessels had been met by an "enormous beast," a long object shaped like a spindle, occasionally phosphorescent, and infinitely larger and more rapid in its movements than a whale. Others observed what appeared to be a sand bank, or reef, in mid-ocean, which shifted from place to place. Ships were injured by collisions with the mysterious object, and others were beyond the shadow of any doubt destroyed by it, since there were numerous total disappearances of vessels. Finally the United States Government sent out a warship, the Abraham Lincoln, to search for and capture or destroy the creature, whatever it might be. On that vessel I, John Amond, with Conseil and Jenson, secured passage. Hundreds of miles were sailed without any result. Then, November 28, not far from the coast of Japan, the object of our quest was sighted. A prolonged chase began, the unknown object easily keeping ahead of the ship. But one night it lay still upon the water, apparently an enormous whale with a luminous eye. Our vessel stole up to it. Ned hurled the harpoon. I heard the sonorous tone

72 Point

3 A \$6 85 4 a \$4 55 \$11 40

SINGE BIRD
Deduct Riches

60 Point

3 A \$5 55 5 a \$4 10 \$9 65

BUSHINGTON
Kerns Abolished

48 Point

4 A \$4 25 6 a \$3 50 \$7 75

TRUST BANKERS
Monstrous Theatrical

42 Point

5 A \$3 65 7 a \$2 90 \$6 55

ARTISTIC PRINTING
Runaway Maims Eleven
Mechanical Introduction

36 Point

5 A \$2 80 8 a \$2 30 \$5 10

CLEAR PRINTING DONE
Enormous Railroad Dividend Shows Building Construction

30 Point

6 A \$2 35 9 a \$1 90 \$4 25

SOUGHT MODERN DESIGNER
Cheltenham Harmony Association Handsome Lithographic Inventions

24 Point

7 A \$1 85 12 a \$1 70 \$3 55

WONDERFUL PRODUCTION GIVEN
Encouraging Department Superintendents Concedes Unimportant Historical Precedent

18 Point

10 A \$1 60 20 a \$1 65 \$3 25

INCREASING INTEREST
Crowded Department Stores Gives Handsomeſt Souvenir

10 Point

19 A \$1 25 38 a \$1 25 \$2 50

ADMIRED HANDSOME ITALICS
Recognized Leader in Type Fashions The Result of Scientific Study Noted Adequate Conception of Real Beauty Wisely Avoids Persistent Elaboration

14 Point

15 A \$1 50 28 a \$1 50 \$3 00

ENRICHES ENGLISH MAIDENS
Obtain Correĉt Physical Conſtitution Superfluous Avoirdupois Unhealthy

8 Point

22 A \$1 10 43 a \$1 15 \$2 25

SECURING NUMEROUS TYPE ORDERS
Italic is Suitable for Greatest Range of Display Twelve Extremely Graceful Maidens Presented Cherished Inmates of Old Home Remembered Sought Deft Hands Guided by Studious Heads

12 Point

18 A \$1 40 35 a \$1 40 \$2 80

PRODUCES BEAUTIFUL SPECIMENS
Horrible Plague Deſtroyed Cruel Kingdoms Americans Entertain German Yachtsmen Rush Orders \$1234567890 Very Eſthetic

6 Point

24 A \$0 95 48 a \$1 05 \$2 00

DISCRIMINATING PRINTER MERITED HONORS
Appreciative Craftsmen Will Admire This Beautiful Face Most Readable and Impressive Italic Series Ever Shown See Splendid Gradation of Sizes and General Excellence Renowned Achievements Reflecting Progressive Workers Its Decided Superiority a Direct Result of Scientific Study Type of Great Merit \$1234567890 Noteworthy Feature

Barton Dime Savings Institution

Four Per Cent
Interest Paid on
Deposits

Capital and Surplus
\$48,500

Safe Deposit
Boxes Rented by the
Month or Year

Art-Tile Tint Formers

HERMIT INLET

Out in the Pure, Pine
Laden Air the Day Long

An out-of-door resort that is a most attractive rendezvous for fall or winter; here is continual sunshine, an invigorating, dry climate, pure water and every convenience for visitors. The weather is always of the finest

Holiday Decorators

Mendson Club

NOTICE

This advance notice is sent to remind you of the date set for our Twelfth Annual Excursion to Boundingville Beach. The regular games are under direction of our organizer, Mr. Knowles, to whom all communications pertaining to tickets, games and the dining service may be addressed. According to resolution passed at our last meeting, the member who sells the greatest number of tickets will be honored by the club in the presentation of a twenty-dollar gold piece. Don't forget the date

Rain or Shine

August Twenty-Ninth

Samples on Request



HAVING established a very modern and up-to-date printing office in your neighborhood which we have thoroughly equipped with desirable new American Type Faces, also new Colt's Armory and Chandler & Price presses and all known improvements for the most economical handling of high-class printing, and as we are practical printers of long experience, we feel that in soliciting your work we are fully prepared and capable of handling it in a thorough manner. We assure you that any order placed with us, be it large or small, will receive our most careful and immediate attention

Hemingstone Print Shop

Highest Quality Catalogues and Fine Job Work
Doan Street, Kensington, Maine

Panel Border Renaissance Initial



The
Pierce-Arrow
Car

The *success* of the
PIERCE-ARROW Car
is undoubtedly due
to the fact that it was
never built to meet
a price. A *successful*
car came first; *price*
second.

Reprinted by permission



*Variety Means Profit and
New Faces Cost No More
Than The Older Designs*

Variety is a strongly-marked factor in the commercial activity of this age. Modern merchants and manufacturers in all lines have found it profitable to cater to the public demand for frequent innovations. Many years ago the styles in feminine garments did not change once a year. A dress was in style until it was worn out. Now such styles change at least once in every three months. Even the apparently conventional clothing of men varies constantly. This Fall the coat lapels are cut short; last Spring they were cut very long. Naturally there is an added profit for the tailors and the dressmakers under these modern conditions. *They* will assert that variety pays. Every progressive printer will take advantage of this modern taste for variety, for more variety is possible in printing today than ever before. *The American Type Founders Company* is constantly designing and producing new and attractive type faces. These newer faces cost no more than the old designs and they will infuse into the work of the printer who buys them the variety that attracts the purchaser of printed matter

SEARCHING THE TITLES

Closing the titles to real estate is often a very tedious matter and, unless it is conducted by experts, complications are apt to follow, and it is possible for you to incur a great financial loss thereby. Let us show you our methods and facilities for closing real estate titles, etc.

TRUST COMPANY

Offices, Second Floor Trust Building

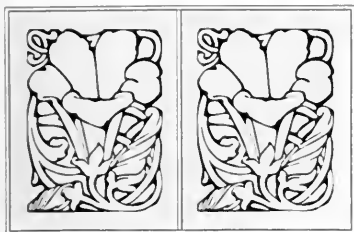

Linear Border Strathmore Ornaments

Bridal Gifts

THE DISTINCTIVE GRADE THAT PLEASES THE DISCRIMINATING

THE name *The Hurden Company* is so inseparably connected with silverware that it may not be usually appreciated that the company also produces an extensive line of 14 and 18 carat goldware which is truly renowned for its exquisite taste, for its great beauty and refinement and real artistic value. Any article that is made in silver is usually duplicated in gold. The splendid assortment of fine tableware designed and made for our own exclusive trade is indeed a very choice gathering. A quick and pleasing selection is assured particular buyers who visit our showrooms. Our present stock includes the new *Rheim* design which is made especially for wedding presentations. Booklet sent on request

The Hurden Company

CHICAGO SAN FRANCISCO BOSTON

Evening Dress Garments for Men



WITH your working and everyday clothes you may possibly be just a trifle careless, but the proprieties demand of you to adhere to established forms regarding evening garments, even to the smallest detail. Such details are complied with in evening dress garments made by us. They are as perfect as tradesmen can make them

HARLEM GARMENT WORKS

1847 Montgomery Avenue, Borough of Manhattan, New York

120 Point

3 A \$11 25 4 a \$7 00 \$18 25

BIG Hat

96 Point

3 A \$8 45 4 a \$5 20 \$13 65

**NUMBER
Birds Shot**

84 Point

3 A \$7 15 4 a \$4 80 \$11 45

**FINE JOBS
Get Behind
Near Home**

72 Point

3 A \$6 55 4 a \$4 05 \$10 60

**EXTENSION
New Railroad**

60 Point

3 A \$5 55 5 a \$4 10 \$9 65

**INTERMINGLE
Desired Method**

48 Point

4 A \$4 15 6 a \$3 35 \$7 50

**SINGLE NUMBERS
Numbering Machine**

42 Point

4 A \$3 15 8 a \$3 10 \$6 25

**GENUINE TRIUMPHS
Envied Thrifty German
Sing Cheltenham Praise**

36 Point

5 A \$2 70 8 a \$2 30 \$5 00

**REVIEWS MYSTIC RITES
Displayed Handsome Shirts
Daring Explorer Astonished**

30 Point

6 A \$1 95 10 a \$2 30 \$4 25

**FURNISHED SUPERB ACTORS
Heartily Endorse Banking Method
Determined Members Considering**

24 Point

6 A \$1 70 13 a \$1 80 \$3 50

**PRINTER BUYS WITH CONFIDENCE
Design Improved Machinery Throughout
Handsome Souvenir Recently Presented**

18 Point

10 A \$1 60 20 a \$1 65 \$3 25

**INTERESTING SUBJECT
Cause and Effect Relations
Debated by Omega Society**

10 Point

18 A \$1 20 37 a \$1 30 \$2 50

**EDITOR STARTS ON JOURNEY
Mysterious Machines Being Rebuilt
Public Mints Are Continuing to Run
They Experienced Severe Reverses
Prolong Financial Embarrassments**

14 Point

14 A \$1 50 26 a \$1 50 \$3 00

**MONSTER SHIPS OPERATED
Floating Palace Developed Speed
Makes Glad Orient and Occident**

8 Point

22 A \$1 10 45 a \$1 15 \$2 25

**SCIENCE CANDLE BRIGHTLY BURNING
Emanating Rays Light Pathway of Progress
Humanity Recipient of Noted Improvement
Sanguine Expectations Crown Experimenter
Obscure Indefatigable Individuals Contribute**

12 Point

17 A \$1 30 33 a \$1 45 \$2 75

**NOTED GRANGER EXHIBIT CLOSES
Mammoth Farm Production This Season
Best Cash Prize for Enterprising Farmer
Awards \$1234567890 Handsome Medal**

6 Point

24 A \$0 90 48 a \$1 10 \$2 00

**THE ORIGINAL UNIVERSITY OF TYPE DESIGN
Strong Type Families: the American Type Foundry
Company Issues Have Given the Printing Industry a
Greater Business-Compelling Value for its Product
Than Any Other Known Ally or Industry Catering to
Successful Typographers. Recognized Appreciation
Evidenced Through \$1234567890 the Rapid Increase**

KING OF ALL TYPE



The
Cheltenham
Family



Q The sovereignty of the Cheltenhams in the big world of advertising has been thoroughly established. The growing popularity of the new members which have recently been added is an indication that this most pleasing type family will remain in favor for many years to come. When we consider the versatility and dignity of this monarch of display, we readily appreciate the reason for its phenomenal success. The progressive printers and publishers buying liberal weight fonts are certain to give the Cheltenhams first place in their composing rooms. Never in the history of type casting has the printing trade been presented with such variety and harmony in a single series of type faces. Its intrinsic worth and great adaptability is acknowledged by all. Sold in weight fonts at our regular body type prices

Cheltenham Bold in Practical Display

THE AEROPLANE IN FLIGHT

WHEN Morianson's craft left the ground he did not waste any time in making preliminary circles about the field. Steadily he forced his monoplane skyward, and in regularly widening circles he soared. The machine seemed to become smaller and it was more difficult to observe, and the crowd took its attention from the desultory flying of the champions. At times the aeroplane, outlined against a hazy sky, would vanish as it made its wide circles; but in a short time would reappear to the northeast, like a faint speck, swimming at a height which it seemed impossible



Aerial Cuts Margin Ornament

THE PRIDE OF CHELTENHAM

This useful and handsome series is distinctively an American Product and is in keeping with the American reputation for giving the printer a plain, stylish and serviceable type face. Its field of usefulness in all branches of the trade is unlimited. The Cheltenham Family, renowned for its legibility, is always popular. The American Type Founders Company is the leader in type fashions, having a large department devoted to the designing and cutting of distinctive and original faces in type, and to the manufacture of artistic decorative material and brass rule

AMERICAN TYPE FOUNDERS COMPANY

**Strong "Pull"
and Drawing
Power in All
Our Printing**



NOT ALL catalogues are consigned to the waste basket. A good many find a place in the files of the recipient or on his desk or his table. The catalogue upon which one can depend to win this distinction is of the out-of-the-ordinary class, the well-designed and well-executed example of the printing art. Every business man desires that his catalogue should have what is known as "pulling" power; that is, it should accomplish its intended mission, namely, to set forth the value of goods and secure orders for those goods. The catalogues we print are those that win the coveted place at the elbow of the prospective customer. They do it by their attractiveness. We employ the highest class of workmen, who are specialists on catalogue work

Menshon & Hartimore
Highest Grade of Catalogue Printing

Indian Weave

The Rug from the Golden West

HERE is a message from the land of the golden west—Red Horse, the famous warrior chief, makes the white man a peace offering in the form of beautiful rugs, blankets and carriage robes, woven by his stoic tribe on *their own reservation*. We can supply you with them in exactly the colors and sizes you want, and in quality and weight best adapted to your particular needs. If you have a room or a den to which you desire to impart an air of distinctive individuality, the Indian Weave Kiana Rug will best accomplish the purpose. There is not a room in the house where you could not advantageously use *Kiana Rugs*

The Indian Rug Company

HEADQUARTERS ON KIANA RESERVATION

*The Kiana Rug is a thing
of beauty and a joy forever*

Cast Squares Indian Border

BOOK MARK

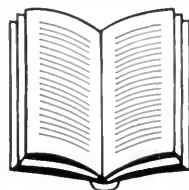

OPENING A NEW BOOK

Hold the closed book with its back resting on a flat surface; drop the front cover down flat and then the back cover. Still holding the book with the left hand, open a few leaves at the back and then a few in the front with the right hand, *gently* pressing open sections till you reach the center of the volume. Do this two or three times and you will obtain the best results. If you open the book violently or carelessly in any one place you will very likely break the back, causing a start in the leaves. *Never force the back*. If it does not yield to gentle opening, the back is too tightly or strongly lined. Protect your volumes and they will last you longer and give you better service

HORAN
BOOK PRINTING

Versatile Ornament

PRUNING TREES CORRECTLY

With your orchard, correct pruning is one of the most vital things—upon which much of its success depends—and emphasizes the benefits of the elimination of the unfit for the stimulation of the fit. None but skilled men should be allowed to tamper with your trees, and this is the time of the year in which to give your orchard every possible care and attention. Have your pruning, filling of cavities and spraying for scale done now. Let me inspect your orchard and I will tell you just what treatment is required to put it in the best producing condition. I have made this business my life study and offer you a half-century of experience



MARTIN JOHNSON, THE TREE DOCTOR, HEMTON, MAINE

72 Point

3 A \$7 25 5 a \$5 25 \$12 50

REMINDER
Snake Fights

60 Point

4 A \$6 50 6 a \$5 00 \$11 50

NIGHT BIRDS
Bohemian Girls

48 Point

4 A \$4 20 6 a \$3 30 \$7 50

HORSE EXHIBIT
Club House Stables

42 Point

5 A \$3 75 7 a \$2 75 \$6 50

PECULIAR DRIVER
Careful Saving Repaid
Handsome Conception

36 Point

5 A \$2 85 8 a \$2 40 \$5 25

***DETERMINED CITIZEN
Reach Judgments Quickly
Desired Honest Statement***

30 Point

6 A \$2 45 9 a \$1 95 \$4 40

***HARMONIOUS ORCHESTRA
Numerous Comedians Required
Rushed Advertising Department***

24 Point

7 A \$1 90 11 a \$1 60 \$3 50

***METHODICAL PRINTERS EXHIBIT
Unexceptionable Mechanical Principle
Involving Obstacles Alter Calculations***

18 Point

9 A \$1 50 20 a \$1 75 \$3 25

***DEMAND NUMBERING
Men Improving Standards
Requires Quaint Wording***

10 Point

16 A \$1 20 34 a \$1 30 \$2 50

***NEW MACHINES ON MARKET
Instantly Revealing Imperfections
Have Reached Government Office
Deliver Handsome Sample Picture
Secretary Now Declines Invitation***

14 Point

14 A \$1 50 28 a \$1 50 \$3 00

***DISTINGUISHED MECHANICS
Shocked Metamorphic Promoters
Recognize Exceptional Qualities***

8 Point

20 A \$1 05 42 a \$1 20 \$2 25

***PRINTER DEMANDING NEW MATERIAL
American Typography Reaching Supremacy
Progress Necessarily Forces New Inventions
Shows Creditable Type Families Artistically
American Type Founders Company Reliable***

12 Point

15 A \$1 30 32 a \$1 45 \$2 75

***REMARKABLE PRINTING DEVICE
Strongest Characters Displayed Neatly
Experienced Collective Art Knowledge
Report Gain \$1234567890 First Month***

6 Point

20 A \$0 95 42 a \$1 05 \$2 00

***PRINTERS MAKING ADVERTISING POPULAR
These Great Type Designs Captured First Honors
Wandering Musicians Becoming Geniuses by Study
Discovering Related Families After Seventy Years
Many Advertising Solicitors Favoring Cheltenham
She Cultivated Profitable Business Acquaintances
Largest Demand \$1234567890 Excellent Printing***

Cheltenham Bold Italic in Practical Display

**Think
Over
This**



THERE is none so good as the best, and the best type is always American. Don't think for a single moment that high-class work is just beyond your scope. Proper outfits of material are the secret of profit in production. Up-to-date ads are "planned" along lines similar to the construction of a modern home; all parts are carefully designed, and can readily be put together to form modern structures, as best suits the whim of the most artistic typotect

**AMERICAN TYPE
FOUNDERS COMPANY**

Bulfinch Attractor Chap-Book Director

**EXHIBIT
OF FINE PAPERS**

**Plain Stationery
For Live Business Men**



Compliments of
**De Luxe Paper Store
Cupid Street**

Panel Borders Della Robbia Ornament

Cheltenham Bold Italic



Striking designs are possible only when type has a decided character. In all of the types cast by this Company much character and dignity may be found. They represent the very highest grade of workmanship and are cast with an idea to save labor and to be practical. The printer who is successful is the one who is ever on the lookout for new methods for attracting the attention of the prospective customer

For a bold display in either job printing or advertising, this fine Cheltenham Bold Italic has all the real requisites for legibility and distinct color. It is easy to read, with no hair lines to break down, just one straightforward dividend-earning type face. It can be used today and for an unending succession of days to come, ever producing you profit

AMERICAN TYPE FOUNDERS COMPANY

BOSTON

STAPLE BINDER

The Boston Staple Binder is the handiest binder and best paying investment which has ever been offered to the up-to-date printer

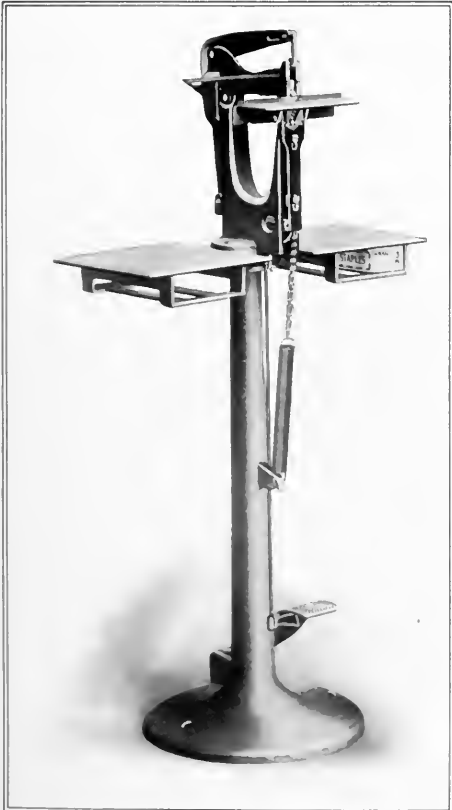

Realizing the great necessity of an efficient, well-built stapling machine, the manufacturers of the Boston Wire Stitcher have invented and brought out the Boston Staple Binder, the only perfected and up-to-date stapler that practically duplicates the work of the best stitcher. The Boston Staple Binder is built on distinctly new lines, with many valuable features never before used in a stapling machine. It is the nearest approach to a regular stitcher yet devised, and its work is neater and better than that of any stitcher other than the Boston. It is difficult to distinguish its stapling from that of the best wire stitching. Staples are furnished on tin cores (no shrinking or swelling of wood) with paper covers, and placed in the machine at the right-hand side. The cores may be lifted out of the stapler and replaced as often as necessary without loss of staples, saving from twenty-five to fifty per cent in staples over all other machines. Write to nearest House for full details

American Type Founders Co.

GENERAL SELLING AGENT

72 Point

3 A \$4 90 4 a \$3 25 \$8 15

EXTINGUISHER
Home Protection

60 Point

3 A \$4 15 4 a \$2 60 \$6 75

MODERN DESIGNS
Practical Equipment

48 Point

4 A \$3 05 8 a \$3 20 \$6 25

INTERESTING METHOD
Guests Manifest Pleasure

42 Point

5 A \$2 80 8 a \$2 45 \$5 25

PURSUING NOBLE COURSE
Historic Specimens Preserved
Fine Magazine Advertisement

36 Point

5 A \$2.31 8 a \$2.00 \$4.30

DISTINGUISHED BURLESQUERS
Miser Uncovers Richest Hoardings
Beautiful Autumn Sunrise Pictured

30 Point

7 A \$1.95 13 a \$2.05 \$4.00

HANDSOME INSTRUMENT EXHIBITED
Discloses Reason for Exceptional Quality
Gratifying Educational Chance Presented

24 Point

8 A \$1.60 16 a \$1.90 \$3.50

FOREST STRETCHING BEYOND THE HORIZON
Anglers Haunt Quiet Streams and Leaping Brooks
Distinguished Citizens Help Great Free Excursions

18 Point

12 A \$1.45 26 a \$1.80 \$3.25

DESIRABLE CONDENSED TYPE
Very Useful Face for Advertisers
Compact and Eminently Readable

10 Point

22 A \$1.15 46 a \$1.35 \$2.50

SERVICE IS COMPLETE AND PERFECT
Mechanical Ability Prominently Shown Here
Great Number of People Gathering in Parks
Charming Conversation Recently Disturbed
American Line Type Faces Lead the World

14 Point

17 A \$1.35 36 a \$1.65 \$3.00

STRAINS OF PLEASING MUSIC HEARD
Dim Moonlit Lanes and Inviting Meadows
Wild Flowers and Fragrant Honeysuckles
Strollers Hesitatingly Return Homeward

8 Point

27 A \$1.05 54 a \$1.20 \$2.25

ASSEMBLED THRONGS HONORING NOBLE HERO
Unveiling of Monument Bearing Suitable Inscriptions
Former Mighty Deeds of Valor Fittingly Remembered
Noted Journalist Comrade Delivers Interesting Address
Forceful Presentation of the Exciting Battles Fought
Bold Enemies Chagrined and Lasting Victories Gained

12 Point

21 A \$1.25 44 a \$1.50 \$2.75

CHEERFUL EDITOR SMILING WITH CONTENT
Unexpectedly and Very Substantially Remembered
Many Large Contributions Quietly Acknowledged
Entrancing Moments \$1234567890 Nicely Depicted

6 Point

30 A \$0.90 60 a \$1.10 \$2.00

WONDERFUL AND MAGNIFICENT SPECTACULAR DISPLAY
Leaping Lurid Flames Belching from the Lofty Burning Mountains
Prominent Tourists Behold Remarkable Pyrotechnic Performance
Startling Volcanic Outbursts Accompanied by Deafening Sounds
Bright Streams of Devastating Lava Rushing to the Waters Edge
Sudden Loud Detonations and Hissing Noises of Escaping Steam
Areas for Miles Surrounding \$1234567890 Completely Laid Waste

American Type Fashions

Users of printing realize the intrinsic value of new type ideas. Let the printer consider this fact well and equip his plant with type of twentieth century style



Type Faces of Bright Design

**AMERICAN
TYPE
FOUNDERS
COMPANY**

Originator of
The Cheltenham Family

HANDSOME type designs are certain to bring the printer more business. It is one of the leading objects of printing to invite favorable attention. How to accomplish this, thereby greatly increasing its advertising value, is the constant study of those earnest printers who are striving to meet the demands for the very best in modern typography. The designs produced by this Company excel in variety, utility and originality the combined products of all other type foundries. Offices equipped with American material are worth more for use or sale than offices equipped from other sources. The question now arises: "Why buy old faces when the newest and best designs cost no more?" Why use the old-fashioned type faces when new faces make your work more attractive; when the new faces are invariably carried in stock, while the old faces, being cast to order, cause delay and increased cost? Stylish Type means more profits

HUNTLERS

Travel Center of Bragford

Today's Events at the Huntlers' Store, of which yesterday's Star and Evening Spectator told fully

An 88-Note Piano Player, purchased on easy terms, a gift that will surely afford pleasure for a lifetime, at **\$317**

500 Oriental Rugs, the result of one of the greatest rug deals made in this city, prices range from \$10 to **\$570**

Tailor-made Suits. Nearly three hundred Tailor-made Suits in such numerous styles and varieties that your individual taste can undoubtedly find its complete satisfaction. And your purse, if small, can be suited also, as the prices range exceedingly low for such high-grade materials. In our dresses and costumes, the variety is even much larger than might be expected; but variety is not all, and, large as the choice is, each garment has an air of distinction. We pick carefully and even our plainest tailor-made suit has an "air" about it. \$22 to **\$35**

Every woman knows the distinguishing marks of the custom suit. They are found right here

A Fur Event matching in interest the great sale of eight months ago, which you can readily recall. Coats, at **\$258**

Huntler Brothers

The Largest Department Store in all Raperdown County
Bramsand and Grove Streets, Bragford

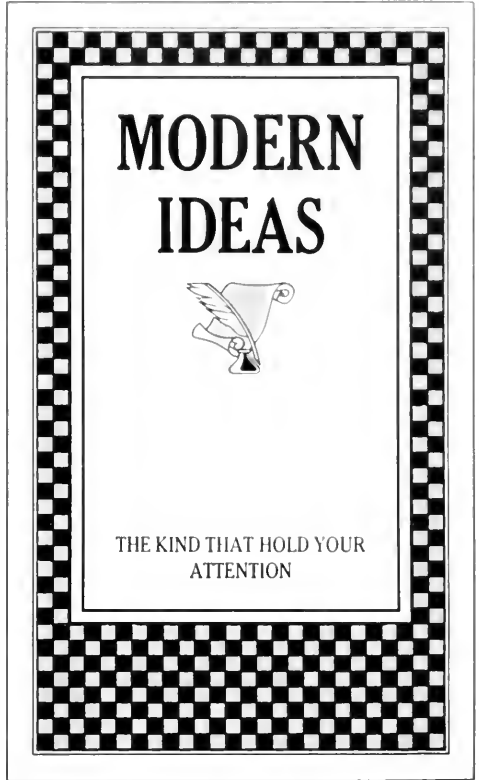

MODERN IDEAS



THE KIND THAT HOLD YOUR ATTENTION

Tricky Border Versatile Ornament

SUPERIOR SAFETY



AMONG the features which make for the safety of a bank, the maintenance of an ample surplus is of the greatest moment. Together with the bank's capital, it stands between the depositors and possible loss. The Superior now has a capital and surplus of One Million, Two Hundred and Twenty-five Thousand Dollars, and this fund shows a great increment by the addition of the undivided profits. The confidence of the people in the Superior's safety was well shown on the opening day, when deposits amounted to more than Six Million Dollars. Since that time, seven years ago, the phenomenal growth of this bank has greatly increased its resources until they now exceed Twenty Million Dollars. This is the most remarkable record of growth ever enjoyed by any banking concern in Vermont. The safety of a bank depends greatly upon another point, perhaps as much as upon capital and surplus, that is the character and general personality of its Board of Directors and Managing Officers

72 Point

3 A \$5 60 4 a \$3 70 \$9 30

SENT PICTURE
Northern Homes

60 Point

3 A \$4 80 4 a \$3 20 \$8 00

MIGHTY HUNTER
Important Question

48 Point

5 A \$3 80 8 a \$3 70 \$7 50

UNTRIED MINER SENT
Reserve Stock Enormous

42 Point

5 A \$2 95 10 a \$3 35 \$6 30

SEND RIGHT EQUIPMENT
National Convention Reports
Habits Become International

36 Point

5 A \$2.30 10 a \$2.70 \$5.00

MODERN PRINTER DESIGNING
Cheltenham Bold Condensed Italic
Building Mechanical Contrivances

30 Point

7 A \$2.20 12 a \$2.15 \$4.35

COMBINE THOUGHTS WITH DREAMS
Banker Expects Financial Achievements
Stylish Councilman Displaying Diamond

24 Point

9 A \$1.75 16 a \$1.85 \$3.60

PUBLISHER IMPROVING SOCIETY COLUMNS
Clothing Manufacturers Holding Long Convention
Richest American Railroad Contractors Honored

18 Point

12 A \$1.50 24 a \$1.75 \$3.25

SECURE CONVENIENT FOREST
Newspaper Writers Dined Today
Honest Builder Refused Contract

10 Point

20 A \$1.10 42 a \$1.40 \$2.50

MODERN REQUIREMENTS IN BUILDING
Warships Reigned Supreme Over Kingdom
Three American Wild Turkeys Slaughtered
Fishing Boats Sighted Off the Grand Banks
Remarkable Changes Noticed in Paintings

14 Point

16 A \$1.40 32 a \$1.60 \$3.00

PROMOTING STRINGENT MEASURES
Renders Beautiful Musical Number Daily
Disastrous Rainstorm Destroyed Houses
Prominent Member Rejects Cheap Prints

8 Point

25 A \$1.05 50 a \$1.20 \$2.25

MONSTER WESTERN GOLD MINES DISCOVERED
Desirable Mountain Homes Rented on Atlantic Coast
Best Workmanship Observed Among the Careful Men
Natural Ability Coupled with Energy Means Success
Study Conditions and Surroundings Thoroughly Today
The Prince Sailed About Twelve Miles Up the Stream

12 Point

20 A \$1.30 40 a \$1.45 \$2.75

MAKING MARVELOUS PRINTING INVENTION
Profitable Workmen Require the Modern Facilities
Modern Specimens Enlightened Uneducated Buyers
Numerous Designs \$1234567890 Receive Mention

6 Point

28 A \$0.95 58 a \$1.05 \$2.00

PRODUCTIVE IDAHO ORCHARDS BLIGHTED BY PESTS
Iron Smelters Labored Under Trying Conditions Until Recently
Searching for Sorts Always an Unpleasant and Unprofitable Job
Discard Your Old Type and Procure Reliable New Faces Now
The Investments in American Type Faces Repay the Purchaser
Grand Canyon Was Discovered Many Years Ago by the Indians
Many Banks Hold \$1234567890 Large Amounts of Securities

THE MOST PROFITABLE AND MOST POPULAR PRESS

The Brower

Drum Cylinder

A Very
Effective
Press

Publishers and printers who possess one are really proud of it. Of all the standard drum cylinders, the Brower is the lowest in price because of the labor-saving jigs and templets used in the manufacture of every part. In a Brower Drum Cylinder Press one secures the most press for the smallest amount of money

*Made in One
Size Only
Seven-Column
Folio*

American Type Founders Co. SELLING AGENT
Houses Everywhere

Hagood Florets



Why do some printers sort up old-fashioned and half-worn type faces when the popular new style job and display faces cost no more than the old, non-dividend-paying variety?





PROPER EQUIPMENT FOR THE GREAT

HORSE FAIR

We have all the clothing that you will need, ready to wear. And you will see nothing new in garments for men at the horse fair that cannot be found here

HERDMIND & DIRKENSIN

DEALERS IN HIGHEST GRADE OF READY-TO-WEAR CLOTHES

BOSTON CHICAGO DETROIT SEATTLE

Panel Borders Rigs and Trap

THE KIRMSBIE SHIRT *FOR NATTY MEN*

Our shirts are perfection in themselves and are correct in form and finish; they are made up in the quarter sizes that are essential to perfect fit; in fact the very acme in shirt-making was attained in our model factory, and with pride we point to our success as leaders in patterns which are neat and novel—shown in madras, percale, pongee and silk. Also a few seasonable styles in latest effects of fashionable neck-wear, in which a very great variety of shades and colors is presented. An invitation is extended to men who are accustomed to finest grades of men's furnishings to visit us and inspect the choicest display of gloves, hats and underwear, together with all other needful haberdashery

MUSCHDERN

*The
Haberdasher*

 *N Oswego Cutters* nothing was spared to produce the most efficient cutting machine possible to build. Uniform reliability and greatest accuracy are attractive features embodied in these cutting machines. They give the greatest cutting output at lowest cost. Here is a machine which we unreservedly endorse

AMERICAN TYPE
FOUNDERS CO. GENERAL SELLING AGENT

ECONOMY AND ACCURACY IN OPERATING
Oswego
Power Paper
Cutters

The Machine of Quality

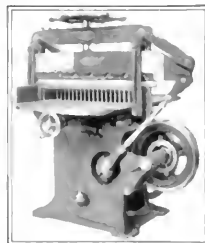

WRITE TO OUR NEAREST HOUSE FOR ILLUSTRATED CATALOGUE CONTAINING LIST OF NET PRICES AND FULL DESCRIPTIVE MATTER

120 Point

3 A \$7 10 4 a \$4 90 \$12 00

BEST HOME

Straight Line

96 Point

3 A \$6 40 4 a \$4 30 \$10 70

RICHER MINES

Bonds Exported

84 Point

3 A \$5 40 4 a \$3 90 \$9 30

NUMBERS GIVEN

Chimes Regulated

72 Point

3 A \$4 15 5 a \$3 50 \$7 95

HANDSOME DESIGN
Superb Material Used

30 Point

3 A \$3 60 5 a \$2 80 \$6 40

DISTINCTIVE HEADINGS
Legible Condensed Series

18 Point

6 A \$3 60 9 a \$3 15 \$6 75

CHARMING REMARKS HEARD
Selected Bright University Pupils
Enthusiastic Orators Decamping

12 Point

6 A \$2 75 10 a \$2 75 \$5 50

MODERN ADVERTISER PROCURED
Enterprising Scheme Quietly Revised
Some Remarkably Clever Pamphlets

36 Point

6 A \$2 10 10 a \$2 20 \$4 30

DESIRABLE WEIGHT FONTS FURNISHED
Popular American Faces Increase Business
Experienced Printers Like the Family Idea

30 Point

8 A \$1 95 14 a \$2 05 \$4 00

MODERN PRINTING OFFICE FURNITURE BOUGHT
Beholding Exquisite Conceptions of Pleasing Quality
Showing a Sublime Beauty Throughout Entire Series

24 Point

10 A \$1 75 19 a \$1 75 \$3 50

HARMONIOUS TYPOGRAPHICAL CONCEPTIONS PROCURED
Stylish Original Features in Cheltenham Bold Extra Condensed
Favorable Chances Being Grasped by the Enterprising Advertiser

18 Point

15 A \$1 45 31 a \$1 80 \$3 25

POPULAR STYLES OF AMERICAN TYPE
Distinctive Features Are Plainly Noticeable
Pleased Customers Mean Increased Sales

10 Point

27 A \$1 15 54 a \$1 35 \$2 50

SPACES AND QUADS MUCH CHEAPER THAN TIME
The Cheapest Commodity Used in Any Printing Office
Lack of Spaces and Quads Consumes Greatest Time
Sufficient Material Enables Compositors to Make Good
Cases Receive Regular Attention from Property Man

14 Point

20 A \$1 40 40 a \$1 60 \$3 00

DISCERNING PRINTERS BUY MODERN MATERIAL
Successful Advertisers Demand Up-to-date Publicity
Antiquated Type Faces Hamper Profit and Progress

8 Point

33 A \$1 05 68 a \$1 20 \$2 25

SPLENDID RESULTS OBTAINED WITH AMERICAN TYPE FACES
Without Good Material in Printing Offices Fine Work is Impossible
Give Your Customer What He Anticipated When Leaving the Order
Specimens Show Much Improvement from the Practical Standpoint
Look for a Printer Who Can Guarantee His Work as Being Perfect

12 Point

24 A \$1 25 48 a \$1 50 \$2 75

THE ADVANTAGE OF HAVING FULL CASES OF JOB TYPE
Picking for Sorts is an Expensive and Annoying Proposition
Plenty of Material \$1234567890 Saves Time and Energy

6 Point

36 A \$0 90 73 a \$1 10 \$2 00

CHELtenham BOLD EXTRA CONDENSED ALWAYS STANDING OUT CLEAR
Every Printing Office Should Be Equipped with the Entire Cheltenham Collection
Beautiful Workmanship Pleased Critic Who Required Original Copy and Design
Executes an Order That Will Reflect Credit to His Establishment and to Himself
Modern Banking Institution \$1234567890 Handling Much Money of Printers

BOOKLETS

Written, Designed and
Printed by Men Who
Understand the Work



Our facilities for turning out high-grade booklets of every description are unequalled. A large staff of skilled photographers and artists are here to anticipate your every want, while our adwriters are all men of exceptional ability in their chosen field. A business man, to be successful to-day, must advertise—that is, keep his goods before the public in a bright and pleasing way. Our artistic booklets will accomplish this

Telephone
2379
Publicity

Estimates
Cheerfully
Given

The H. J. MYER PRINTING CO.
No. 24-30 State Street EL PASO, TEXAS

Wayside Ornament

American Type Founders Company

ORIGINATOR AND MAKER
OF POPULAR TYPE FACES



**Cheltenham Bold
Extra Condensed**
Looks Good Wherever Used

Panel Border Wayside Ornament

Our Annual Furniture Sale

AFFORDS MANY EXCELLENT OPPORTUNITIES TO FURNISH YOUR HOME AT A LOW COST

CHINA CLOSETS. Solid oak, colored or finished to suit the purchaser; leaded glass doors. Decided bargain. Price **\$32**

SIDEBOARDS. Eighty inches long; Mahogany finish; hand carvings; velvet lined drawers for silverware. Price **\$23**

DINING TABLES. Solid oak, quarter-sawed, extension tables; beautifully finished top and pedestal base. Price **\$16**

BUREAUS. Finished in golden oak; large French plate glass mirror; four roomy drawers; a very useful article. Price **\$19**

REFRIGERATORS. Sturdily built so as to withstand rough usage; adjustable shelves; black walnut finish. Price **\$12**

MORRIS CHAIRS. Oak finish; selected plush cushions in many colors; this is the best value ever offered. Price **\$24**

The Columbia Furniture Company Hamlin's Leading Furniture Store **27** BOSWICK AVENUE HAMLIN, MD.



A SMOOTH, QUIET RUNNING ENGINE

Is much less expensive to maintain than a noisy vibrating car that bumps and jolts along the road, causing unnecessary wear from vibration. Did it ever occur to you that vibration is the most dangerous defect known to automobiles? If you would have a car so flexible in construction that it will crawl through the crowded traffic, mount the most difficult hills, or fly along the country roads with velvet-like smoothness and never a shift of gears, look at the "BUMPER" with its offset crank shaft, straight line drive, and large, comfortably riding wheels. At last, in a moderate priced car, you are offered all the superior features and high qualities which have hitherto been obtainable only in machines costing \$900 and upward. All models exhibited at the "Big Show" in Madison Gardens

The Bumper Automobile Co.

62 and 64 Manhattan Boulevard, Holyoke, Michigan

GEORGE PETERSON, Branch Manager

TELEPHONE 695 FLUSHING

AMERICAN TYPE FASHIONS LEAD



**Originator of Stylish
Type Designs for all
Progressive Printers
and Their Customers**

New Styles in type are created in order that attractive variety may be added to commercial and advertising typography generally. To be progressive, the printer must always use new faces before they become ancient history. It is the novelty that makes new faces valuable. They catch the eye of the reader by a change in form and tone of printed matter. The type face that has become the property of all in general loses somewhat its original attraction. It is this Company's one aim to create new styles in type which may be used by printers who want the pulling power that goes with novelty—a power to utilize new designs while they are new and stylish. Style in type is as valuable as style in literature. Printers having the ability to compose their copy in a pleasing manner are worth as much to the advertisers as are the copy writers who bend their efforts toward originality

AMERICAN TYPE FOUNDERS COMPANY

96 Point

3 A \$6 60

SKIRMISHER

84 Point

3 A \$5 15

**MUST RETURN
PRINTS CLEAR**

72 Point

3 A \$5 05

**RICH LEAD MINE
FINDING MONEY**

60 Point

4 A \$4 75

**SUPERB STRENGTH
MEN HUNTING BIRD**

CHELTENHAM BOLD EXTRA CONDENSED TITLE

48 Point

5 A \$3 75

HANDSOMEST PICTURES
LEADING MERCHANDISE

42 Point

6 A \$3 25

BUILD FIRMEST STRUCTURE
FURNISHED LUMBER CAMPS

36 Point

7 A \$2 80

REFRESHING ZEPHYRS BLOWING
SONGSTER DELIGHTING ORPHAN

30 Point

10 A \$2 60

FOUND STRONG LINE
CUSTOMERS TICKLED

12 Point

27 A \$1 50

CLEVER PRINTER FOREMAN FEARING
THE PROVERBIAL SLIP OF THE TYPES
PREVENTS UNPLEASANT HAPPENING
AMERICAN \$1234567890 ORIGINAL

24 Point

14 A \$2 55

MOB QUIETLY DISPERSED
HIDING EDITOR RETURNS

10 Point

36 A \$1 40

CONCERN OF FUTURE DILIGENTLY STUDIED
WITHOUT SOLEMN IMPRESSIVE CEREMONIES
RETARDMENTS OF PROGRESS FOREVER GONE
GENTLY BUT UNRESERVEDLY LAID TO REST

18 Point

20 A \$2 00

FINDING MYSTICAL ENCAMPMENT
BENEVOLENT SILENT INFLUENCES

8 Point

40 A \$1 25

REMINDING THE PRINTING WORLD OF EXTREME WORTH
USEFUL CHELTENHAM EXTRA BOLD CONDENSED TITLE
MAKERS OF HEAD LINES NOTICE ITS GREAT ADVANTAGE
PROMINENT DISPLAY OF LONG WORDS AND SENTENCES

14 Point

25 A \$1 75

GRAND FREE SPECIAL TYPE EXHIBITION
SOUTHERN BOTANIST CALMLY RETIRING

6 Point

42 A \$1 00

HURIEDLY SPOKEN WORDS GONE FOREVER AS FATHER TIMES MOVE
SWIFTLY SCAMPING OVER FIELDS, MEADOWS AND BROAD VALLEYS
BEAUTIFUL SPRINGTIME MELODIES AND PLEASURES IN ABUNDANCE
WAVES CEASELESSLY BEAT \$1234567890 UPON THE WHITISH SANDS

y-Bulletin



ARY 18, 1912

New Series Number Twelve

ES ORATORY

NISHED FIVE-MINUTE GLASS ATE DEBATE

an. 17.—A very queer
aker's desk attracted
House during debate
he Army bill. Asher
eatest Parliamentary
urned it upside down
the Speaker himself
s hands folded on the
ould gaze at it atten-
ared that the machine
m a five-minute glass
e purpose of dealing
tie to members who
ve-minute rule of the
tions.

P REAPPORTIONMENT

ill select a committee
investigate the entire
onal reapportionment
rating the committee
vernment a good deal
l the adoption of this
inly bound to act as
sturbance came when
ey could get through

ERECTING HIGH BUILDING

MOST LOFTY STRUCTURE IN THE STATE EXPECTED

PLANS FOR 55-STORY BUILDING FILED—TWENTY-FIVE STORIES IN THE TOWER; THREE STORIES TO BE UNDER GROUND

This mammoth skyscraper is to be the tallest office building in the world, and will be erected on the westerly side of Broadway, occupying the block between Jay Street and Parks Place. It will be 750 feet high, or about 50 feet higher than any other building. Mr. Brady recently secured the Jay Street corner, he intends to change his plans so that he can utilize the entire block for his new building.

"My building ideas have enlarged," he said, "in harmony with the acquisition of additional property. The plans originally prepared for the building on the Parks Place corner will be entirely altered. My present idea is to have the main building of from twenty-seven to

exceeded in height in the world by the Eiffel Tower, 985 feet, will cost about \$12,000,000. The land, which has been acquired in the past year, has cost nearly \$5,000,000. The building, to cover a total of 39,500 square feet, will afford almost 13,000,000 cubic feet of available space in the completed structure. It will be of the best fireproof construction, and in the revised plans the original general ideas adopted for the smaller enterprise will be incorporated. The tower, Mr. Brady says, will be an architectural ornament.

Mr. Brady will have possession of the Jay Street corner about May 1, at which time the leases of the tenants expire. By that time the excavating work of the

FLIES TO WARSHIP THEN BACK AGAIN

SUCCESSFUL AVIATOR ALIGHTS ON THE PENNSYLVANIA WHILE TRAVELING FIFTY-FIVE MILES AN HOUR

CARRIED OFF IN SIGNAL TRIUMPH

SOLDIERS BEAR HIM ON THEIR WILLING SHOULDERS UPON HIS RETURN TO LAND—EASIER IF SHIP WERE MOVING, HE SAYS

The crowds of expectant spectators which faithfully assembled day by day to witness the proposed flight to a ship at sea by the daring aviator were repaid for their persistence by seeing the successful accomplishment of this feat.

It was decided that weather conditions were favorable. The sky was hazy. At 10:45 o'clock he left the aviation field. His motor worked perfectly, and after

HEARD CALL OF THE CITY

MADISON, N. J., GIRL STARTING OUT TO SEEK HER FORTUNE IS CAUGHT AT GENERAL STATION

Feeling the call of the big city, Agnes Cavanaugh, now sixteen, packed her valise and with two small bundles of extra clothing and a hat box set out solemnly from Madison, N. J., to cast her fortune in this city. She did not expect anyone to meet her and was much surprised when Lieut. McIntosh accosted her by name, as she alighted from a train at 11 o'clock at night in General Station.

On the way to the Fifty-sixth street police station she explained that she had grown homesick up in the country, and had come away full of confidence in her ability to take care of herself here. She emphasized these intentions to Lieut. Ranier at the station house, and became highly indignant when he said he would have to send her to the Children's Home.

Lieut. Ranier got the news of her coming in a queer way. A call came to him about a half an hour before the train was due telling him the girl's name, saying she was pretty and describing her dress. Then suddenly the telephone connection was cut off. Lieut. Ranier soon decided that a girl from Madison must

BILL TO PUNISH GOES BEFORE

MILITARY CHIEFS WA BECAUSE ESPIONAGE DEFENSES IS FLY

CORREGIDOR SECRETS

ONE ATTEMPT MADE TO GET BRIBE FOILED, BUT A CEDED—NO SPY

WASHINGTON, Jan. an end to the activities United States and its taken by the House C Through representati sylvania, it reported navy and military au have been greatly tro ties of foreign spies i When they have caught

MINNEAPOLIS

A GRAND NIGHT'S REST

IS ASSURED THE TRAVELER WHO CHOOSES THE EAST SHORE RAILROAD, BECAUSE THE ROUTE IS "WATER LEVEL," PRACTICALLY NO GRADE—YOU CAN SLEEP

THE MINNEAPOLIS EXPRESS

LEAVES WARISON STREET, 8:46 P. M.
ARRIVES MINNEAPOLIS, 10:53 A. M.

THIS IS THE WESTERN TRAIN THAT AFFORDS SOLIDLY VESTIBULED SLEEPERS, WITH BUFFET, SMOKING CAR AND OBSERVATION COACHES, TOGETHER WITH ALL LATEST IMPROVEMENTS THAT GIVE REAL COMFORT

THE EAST SHORE LIMITED

LEAVES WARISON STREET, 6:23 A. M.
ARRIVES MINNEAPOLIS, 8:29 P. M.

THIS IS THE DAYLIGHT TRAIN—HAS PARLOR CARS AND COACHES, ALSO DINING CAR SERVICE DE LUXE BAGGAGE CARRIED ON SAME TRAIN WITH PASSENGER

EAST SHORE RAILROAD

RAILROAD AND SLEEPER TICKETS CAN BE SECURED AT ANY OF OUR OFFICES, OR WILL BE DELIVERED UPON REQUEST BY SPECIAL MESSENGER. FOR INFORMATION OR ILLUSTRATED LITERATURE COMMUNICATE WITH W. LORR, TRAFFIC MANAGER

Cheltenham Bold Extended

72 Point

3 A \$9 35 4 a \$5 85 \$15 20

**HINDERS
Born Rich**

60 Point

3 A \$6 15 4 a \$4 60 \$10 75

**PIEDMONT
Stone Hand**

48 Point

3 A \$4 65 4 a \$2 85 \$7 50

**MEANDERING
Cane Returned**

42 Point

3 A \$3 70 5 a \$2 75 \$6 45

**RESPECT HOME
Building Material
Hunt Lost Miners**

Cheltenham Bold Extended

36 Point

3 A \$2.90 5 a \$2.15 \$5.05

**MARKETING PRICE
Broken Hearthstone
Remarkable Guards**

30 Point

1 A \$2.20 7 a \$2.05 \$4.25

**NUMBERING MACHINE
Continue Earnest Search
Heroic Knights Returned**

24 Point

5 A \$1.75 9 a \$1.75 \$3.50

**MORNING BRINGS DELIGHT
Determined Neighbors Confer
Entering Handsome Mansions**

18 Point

7 A \$1.65 13 a \$1.60 \$3.25

**SYSTEMS DESIRED
Exceptional Method
Strength and Beauty**

10 Point

13 A \$1.15 28 a \$1.35 \$2.50

**INCREASE KNOWLEDGE
Development of Industries
Grand Educational Course
Intricate Machines Bought
Hard Problems Elucidated**

14 Point

10 A \$1.40 21 a \$1.60 \$3.00

**PHENOMENAL EXHIBIT
Modernized Construction
Charming Reports Noted**

8 Point

15 A \$1.00 30 a \$1.25 \$2.25

**MANY PLEASING REFLECTIONS
Cultivate Orchards and Meadows
Springtime Memories Encouraged
Fragrant Perfumes Gently Inhaled
Chases Butterflies Through Fields**

12 Point

12 A \$1.30 25 a \$1.45 \$2.75

**DISTINGUISHED PRESIDENT
American Type Characteristic
Beautiful Cheltenham Designs
Legible \$1234567890 Figure**

6 Point

17 A \$0.95 35 a \$1.05 \$2.00

**ENCHANTING TROPICAL COUNTRIES
Ruins and Strange Tales of the Ancients
Visit Dense Almost Impenetrable Forest
Beside Picturesque Meandering Stream
Imposing Scenery Fascinates the Tourist
Wild Animals Haunt Mountain Fastness
Entangling \$1234567890 Luxuriance**

Great Autumn Clearance Sale

Modern Suits and Overcoats

Here is an opportunity greater than this city has seen in a good many years and the greatest that we have known in our long experience. This is a chance to buy some broken sizes in our Men's Suits and Overcoats which you may not see again. Value \$30 to \$35, at **\$27**

Seventy-eight \$20 to \$25 Suits of unfinished worsted, in new browns and grays; wale weaves; also silk and neat stripe effects on black and blue grounds. Bargain at **\$17**

Fifty-seven \$25 to \$30 Suits of velours and cheviots; all new shades of gray and brown; exclusive designs in glen checks, stripes, pin checks and many fine weaves, at **\$18**

Sixty \$22.50 to \$32.50 Convertible Collar Overcoats, of worsteds, velours and tweed cheviots, to be had in all the newest gray and brown shades, in plain stripe and fancy weave and all new designs. All are 52 inches long and well made, at **\$26**

Twenty-seven \$24 to \$33 Overcoats in black, Oxford and Cambridge grays, in meltons and velours. Stripes and plain weaves; fitted with plain and velvet collars, at **\$23**

Sixty-eight \$20 to \$25 Overcoats, for business and dress wear; new shades of gray and brown; in worsteds and velours; many new zig-zag weaves; latest models, at **\$18**

Included are the most popular models and fabrics produced this season. A large majority of these garments have only been received from our exclusive custom shops within the past few weeks. The prices quoted are attributable solely to our policy of giving to our customers the lowest prices

MEYER, DENT & COMPANY

Ninety-eight North Lexington Street, Los Angeles

BRANCH STORES IN PHILADELPHIA, PITTSBURG, CHICAGO, ST. PAUL

Cheltenham Bold Extended

A USEFUL MEMBER OF THE FAMOUS CHELTENHAM FAMILY

A bold and extended letter has many uses in display advertising when shown alone or in combination with the more condensed faces. For the purpose of display is to bring out with greater force an idea or ideas contained in the text. The bolder the display, within the limits imposed by taste, refinement and rules of harmony, the more thoroughly the desired effect will be produced. The Cheltenham Bold Extended is the most forcible and vigorous member of the Cheltenham Family. It harmonizes perfectly with all the other members and it retains its boldness without sacrificing any of the refinement inherent in all the Cheltenham. It is an ideal display letter of sufficient strength and distinction to demand attention, regardless of position or tone of surrounding matter

AMERICAN TYPE FOUNDERS COMPANY

Cheltenham Bold Outline

72 Point

3 A \$6 55 4 a \$4 05 \$10 60

BEND RODS
Highest Rank

60 Point

3 A \$5 55 5 a \$4 10 \$9 65

MINE SUNKEN
Returned Bright

48 Point

4 A \$4 15 6 a \$3 35 \$7 50

EARNED PENSION
Grand Home Burned

42 Point

4 A \$3 15 8 a \$3 10 \$6 25

DEMANDS HEARING
Signs Important Record
Inspects Many Sections

36 Point

1 A \$2.70 5 a \$3.00 \$3.00

RECORD MAKER FINED
Honest Mechanic Employed

30 Point

6 A \$1.95 10 a \$2.50 \$3.25

HANDSOME KNIGHT SCARED
Grand Merchandise Departments

24 Point

6 A \$1.70 13 a \$1.80 \$3.50

FIVE REFINED BOHEMIAN SINGERS
Rehearse Theatrical Stage Performance
Conspicuous Philanthropist Enthusiastic

18 Point

10 A \$1.60 20 a \$1.65 \$3.25

ENORMOUS PRODUCTS RECEIVED MENTION
Beautiful Country Maiden Admired Foreign Counts
Kind Gentleman Entertained Many Prominent Men

14 Point

14 A \$1.50 26 a \$1.50 \$3.00

DEMANDS PLAUSIBLE IDEAS
Pupil Displayed Numerous Medals
Rich Sister Located in New Jersey
Leading Citizens Demand Concert

10 Point

18 A \$1.20 37 a \$1.30 \$2.50

SATISFACTORY TYPOGRAPHY
Memorized Nonsensical Discussions
Lone Maiden Finds Congenial Mate
Windstorm Destroys Parachutist
Mid Weather Reported for Sunday

12 Point

17 A \$1.30 33 a \$1.45 \$2.75

OBSERVED BEAUTIFUL SPECIMENS
Eastern Speculators Select Fruit Country
Magnanimous Proclamation Emblazoned
Depositing \$1234567890 Money Friday

8 Point

22 A \$1.10 45 a \$1.15 \$2.25

SEARCHING FOR STOLEN TREASURES
Country-born Stenographers and Typewriters
Fishing Crews Likely to Cause Long Delay
Making Arrangements for Grand Convention
Compiling Comprehensive Business Forecasts
Grand Instructions Emitted by Generous Men

HESTER & SON

Established
Mar. 1, 1875

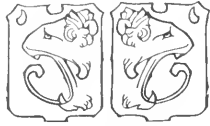

DEALERS IN HIGH-GRADE NOVELTIES IN

JEWELRY

Telephone 146 Emerald

Precious Stones
OF MATCHLESS BRILLIANCY

We desire to inform our many friends and the public in general that our new line of high-grade novelties in jewelry is now here awaiting their approval, and we have no hesitancy in saying that the splendid values here shown are far the best ever offered in the city. A visit to our store, and a casual glance over this stock, will be greatly appreciated by us

27 North Frankford Avenue
NEW LONDON, TEXAS

Strathmore Border Strathmore Ornaments

For All Occasions

Flowers

Twenty years of continued success in catering to the wants of the flower and plant-loving people of this city is a record of which I am justly proud, and I take this means of expressing my thanks to my friends and patrons for their kind patronage in the past and hope for a continuance of same

Arnold the Florist
28 Plant Street, HURON, LA.

Strathmore Ornaments 12 Point Linear Border

Our Selection of Classical

MUSIC

For the Piano and Organ
Contains Many Features
that Please the Public

J. KING & CO.

39 Hanford Street

Versatile Ornament

Cheltenham Bold Outline

ONE OF THE POPULAR MEMBERS OF
THE USEFUL CHELTENHAM FAMILY

□  □

This characteristic and striking type design commends itself to discriminating printers, it being useful as a distinct series for fine commercial printing and as an advertising letter. It is effective in combination with all the other members of this widely known Cheltenham Family. The use of this type means something more than merely to give us a page of printed matter, it brings desired results to the printers who use it

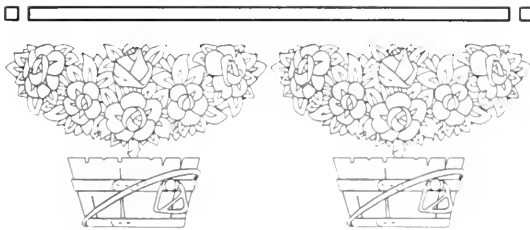

Original Design

American Type Founders Co.

LEADER IN TYPE DESIGN

72 Point

3 A \$7 20 4 a \$4 35 \$11 55

FISHERMEN

Strange Birds

Great Empire

60 Point

3 A \$5 55 5 a \$3 95 \$9 50

FINDS MONEY

Inspired Student

Solving Mystery

48 Point

4 A \$4 25 6 a \$3 40 \$7 65

MINERS TURNING

Best Music Selection

Historical Document

42 Point

4 A \$1 10 8 a \$3 15 \$6 25

QUESTION KNIGHTS
Decorated Handsomely
Build Substantial House

36 Point

5 A \$2 80 8 a \$2 35 \$5 15

ENTERPRISING FRIENDS
Reinstated Member Named
Demands Honest Statement

30 Point

5 A \$2 05 10 a \$2 20 \$4 25

BURNISHED HEARTHSTONES
Stupendous Contract Undertaken
Beautiful Fireplace Reconstructed
Determined Producers Conversing

24 Point

6 A \$1 70 13 a \$1 80 \$3 50

HANDSOME PREMIUM EXHIBITION
Extraordinary Horticultural Competitions
Remarkable Floral Creations Distributed
Bright Geraniums and Magnificent Roses

ROMANCES

   By Popular Fiction Writers

NOWHERE in the city can a more complete list of popular novels be secured than in our enlarged book department. As the holiday season approaches, the question again arises: "What can I buy him or her for a present?" Now what could be more useful or appropriate than some interesting book to while away these long dreary winter evenings

TOM BURK By HAROLD J. MERIDET

A stirring tale of Ireland during the latter part of the sixteenth century, when beautiful scenes are depicted with a strong sense of humor will

ROSMORE By MRS. MARTIN SOUTHWICK

One of the prettiest love stories ever written, and with

AN IDLE

This romantic narrative of strange and inspiring beauty the bewitching Nile and its leaves one lost in meditati

THE MIN

A stirring novel of California the great gold craze which love and adventures during hold the reader's attention i

MYSTER

A detective story of life in crowded metropolis. Hidden vice and crime among the strange deductions that th

A CHILD

The amount of tenderness whose hero is a baby will strangely original little drama a fresh revelation of what

Hent
49 Birkes

Baxter Mobile Company

Each year adds something new to the automobile business, and we can truthfully say that we have always kept abreast of the times in catering to the whims and fancies of the automobile public. Our latest effort in this line has been to produce the

Model Six

which we believe to be the most accurately built and the fastest machine for \$2500 ever placed on the market. We would be delighted to have you call and take a 50 or 100-mile spin through the country in order to prove the truth of our assertion

TELEPHONE 1945 METROPOLE

Second and Pine Streets



TOYS

Automatic and
Electric



REIMEN & BANKS

Chicago, Illinois



120 Point

3 A \$7 40 4 a \$5 10 \$12 50

EXTENSION

Bright Metal

96 Point

3 A \$6 60 4 a \$4 40 \$11 00

RENUMBERED

Special Harbors

84 Point

3 A \$5 50 4 a \$3 70 \$9 20

MODEST DESIGN

Curious Labyrinth

72 Point

3 A \$4 70 5 a \$3 60 \$- 35

DELIGHTFUL CHILD
Beautyland Reported

60 Point

3 A \$3 55 5 a \$2 90 \$6 45

HUNTERS CONSIDERED
Manufacturing Chemicals

48 Point

5 A \$3 20 9 a \$3 30 \$6 50

MERITORIOUS PERFORMERS
Showing Remarkable Souvenirs

42 Point

6 A \$2 75 10 a \$2 65 \$5 40

HANDSOME STUDENT CENSURED
Misrepresented Historical Condition

36 Point

6 A \$2 20 10 a \$2 10 \$4 30

HONORING DISTINGUISHED FOREIGNER
Modern and \$1234567890 Useful Figures

JONES & SONS Clothiers

We are the sole agents in every large city of the east for the well known patterns of the superior

Maple Brand

men's and boys' Clothing; these goods are to be obtained at our salesrooms also



BRANCH STORES

Philadelphia
Boston
Indianapolis
Cleveland
Washington

THERE is no test of worthiness so true as the growth of popular demand and this season the demand for MAPLE BRAND CLOTHES is greater than ever before. This is your clearest proof of their superiority of quality and value. To truly enjoy life, wear clothes that are snappy, full of vigor and vim—MAPLE BRAND CLOTHES. We are showing a complete assortment of them, the season's newest and best creations. They include a variety of styles and patterns that will appeal to every man of taste and judgment. They're away from the commonplace, most of them found nowhere else. One-price goods only

Bargains at our salesrooms mean so much more than the ordinary Bargain Sale that you cannot afford to miss this extraordinary offering

NEW YORK OFFICE AND SALESROOMS

286 Fourth Street

PHONE HARRISON 82 LONG DISTANCE BELL 309

HUNIGEM

THIS SEASON'S MODELS NOW
EXHIBITED AT OUR GARAGES



Model "D"

NINETY HORSEPOWER

Has the newest type motor and a 5x6 cylinder; 42-inch wheels and 136-inch wheel-base. An easy-running, strongly built car in closed and torpedo bodies

\$3200

Model "E"

FORTY HORSEPOWER

Has the newest type motor and a 5x8 cylinder; 38-inch wheels and 124-inch wheel-base. A stylish machine. It can be equipped with touring body model

\$2450



Gasolene Touring

CARS

This make of car has always particularly stood for comfort. This season's models represent the perfection of comfort in the automobile line. The detachable doors in front assure an added luxury for the forward passengers, and by the moving of a pin you remove any part of the door. They are the ideal cars for pleasure and business. The price includes a complete equipment with the Dutch doors, folding windshield, best grade silk Mohair tops and a dust-hood. Large wheels and long wheel-bases also contribute to the end of more pleasant motoring over rough roads

The Car of Quality

HANDSOMELY ILLUSTRATED BOOKLETS MAILED UPON REQUEST

MERDUN & DIBSEN

SOLE DISTRIBUTING AGENTS FOR THE EASTERN STATES :: GARAGES IN ALL PRINCIPAL CITIES

72 Point

3 A \$9 35 4 a \$5 85 \$15 20

BURNISH
Kind Girls
Exchange

60 Point

3 A \$7 50 4 a \$4 40 \$11 90

NICE BIRDS
Return Coin
Great Music

48 Point

3 A \$4 75 4 a \$2 95 \$7 70

PRIZED HORN
Gentle Remark
Mineral Search

42 Point

3 A \$3.05 5 a \$2.70 \$6.25

BRIGHT CHIMES
Reminder Sought
Charm Hundreds

36 Point

3 A \$2.85 5 a \$2.15 \$5.00

DETERMINE MINDS
Greatest Excitement
Handsome Manager

30 Point

4 A \$2.20 7 a \$2.05 \$4.25

MIDNIGHT ENTERPRISE
Extraordinary Document
Remarkable Manuscripts

24 Point

5 A \$1.75 9 a \$1.75 \$3.50

MUSEUM EXHIBITS RETURN
Enthusiastic Members Confide
Numerous Souvenirs Obtained

18 Point

7 A \$1.55 13 a \$1.70 \$3.25

INSURGENTS DESIRE RECOGNITION
Diplomatic Leaders Secure Candidates
Reorganized \$1234567890 Railroads

Furniture

HAVING THE VERY HIGHEST
QUALITY

The intrinsic value possessed by every piece of furniture we handle, in space-saving and in labor saving qualities, has been most fully demonstrated in some of the best and largest printing offices in this country, where our modern printing office furniture and other materials have been installed. The very finest products of the forest are used in building our furniture. This imparts elegance, strength and durability, a trio of essential qualities. The great economic features embodied in our wood goods are unsurpassed. Wood Type and Borders of modern design and all guaranteed uniform in height

American Type
Founders Company

Homeland Residences

On the Aero Planeway

IF you are one of those city dwellers whose early life was passed in the country you are the person we have a message for; you are the person we can interest because you know from experience of the enjoyment and health there are in plenty of fresh air, light, sunshine and roominess of country life, and that is the subject of our message to you. Business may make it necessary that you should be in the crowded, busy city every day but the time has come when you need not spend the twenty-four hours of the day there. Homeland is only fifteen minutes from the city. Homeland is located among the most peaceful natural surroundings of woodland, fields, streams and lakes. It has all the advantages of the city, including gas, electric light, sewers and purest spring water plentifully supplied for every purpose. It has asphalt streets and the finest crushed stone roads into the country, giving the most delightful opportunity for motoring. Any man can own a home here to suit his taste and salary. Give us an opportunity to prove this

Holmes Real Estate Co.

Lafayette Avenue and Grove Street

Holmes, Michigan

THE GREATNESS OF THE CHELTENHAM FAMILY



NO TYPES have equaled the Cheltenham in usefulness to the commercial printers, or brought more profits to the printers. ¶ No types have equaled the Cheltenham in creating and increasing an appreciation of the value of good printing among the printers' customers. ¶ No types have equaled the Cheltenham in producing harmonious and striking effects with less expenditure of time and thought and experiment on the part of the compositor

ORIGINATOR OF
THE CELEBRATED CHELTENHAM FAMILY
THE LARGEST TYPE FAMILY EVER
BROUGHT OUT

American Type Founders Company

Strathmore Ornament Gray Border No. 2
Cheltenham Inline, Cheltenham Inline Extra
Condensed and Cheltenham Wide

The Cheltenham Family

IS BEYOND ALL DOUBT THE MOST POPULAR AND THE MOST DISTINCTIVE GATHERING OF RELATIVE TYPE FACES THAT THE WORLD HAS EVER SEEN

The completeness of this great family makes it adaptable for all forms of work

Most Profitable Designs

Proven by the most successful printers and advertisers in the world

**American
Type Founders
Company**

Originator of Type Fashions

Cheltenham Oldstyle

Cheltenham Wide

Cheltenham Medium

Cheltenham Bold

Cheltenham Bold Condensed

Cheltenham Bold Extra Condensed

Cheltenham Bold Outline

Cheltenham Oldstyle Condensed

Cheltenham Italic

Cheltenham Medium Italic

Cheltenham Bold Italic

Cheltenham Bold Condensed Italic

CHELTENHAM BOLD EXTRA CONDENSED TITLE

Cheltenham Bold Extended

Cheltenham Extrabold

Cheltenham Inline

Cheltenham Inline Extended

Cheltenham Inline Extra Condensed

72 Point

3 A \$7 75 4 a \$5 40 \$13 15

**MENTIONS
Ring Chime**

60 Point

3 A \$6 25 4 a \$4 40 \$10 65

**RENUMBERS
Enters Design**

48 Point

3 A \$4 15 5 a \$3 35 \$7 50

**FINISH ENGINES
Crockery Broken**

42 Point

3 A \$3 15 6 a \$3 25 \$6 40

**DISTURBS ERMINE
Captures Steamship
Indian Fisher Moves**

36 Point

4 A \$2.70 6 a \$2.45 \$5.15

EXPOSED HUNTSMEN Fires Destroy Evidence Government Inspection

30 Point

5 A \$2.20 8 a \$2.05 \$4.25

CONDEMNS LIGHTHOUSES Unusual Gathering Expected Beautiful Ornaments Chosen

24 Point

6 A \$1.75 10 a \$1.75 \$3.50

PRODUCED DISTINCT PRINTING Handsome Carnation Given Sailor Extraordinary Gentleman Returns

18 Point

9 A \$1.55 16 a \$1.70 \$3.25

ADMIRING CHILDREN Steamer Rounds Capes Secure Heroic Fireman

10 Point

15 A \$1.15 30 a \$1.35 \$2.50

ENTHUSIASTIC HISTORIANS Described Printing Machinery Showed Marvelous Inventions Many Borders Sold in Georgia Desires Cheltenham Extrabold

14 Point

11 A \$1.35 23 a \$1.65 \$3.00

PRODUCED INFORMATION Captain Withdrew Regiment Important Documents Found

8 Point

18 A \$1.05 35 a \$1.20 \$2.25

SOUTHERN PLANTERS CELEBRATED Largest Cotton and Watermelon Crops Celebrated Mule Driver Buys Harness Warm Weather Causes Much Suffering Immense Plantations Sold by Butchers

12 Point

14 A \$1.25 26 a \$1.50 \$2.75

ANCIENT HISTORY MENTIONED Handsome Designs Mailed Today Girls Educating Young Composer Detective \$1234567890 Uses Gold

6 Point

21 A \$0.95 40 a \$1.05 \$2.00

ENTHUSIASTIC MOUNTAINEER REMAINED Young Pressman Wanted Several Cold Bottles Brilliant Composers Delivered Fine Lectures Strong Mechanics Removing Famous Painting Husky Sailors Visited Italy and South America Delightful Excursion Party Returned Tuesday Most Printers \$1234567890 Remain Wealthy

Cheltenham Extrabold

WITHOUT the latest and most artistic type faces fine printing is almost an impossibility. Novelty in type faces is always an incentive to the production of beautiful and attractive printing. The new Cheltenham Extrabold is a very striking and attractive member of the great Cheltenham Family and one which will readily lend itself to the many requirements of all advertising and other display composition. The addition of Cheltenham Extrabold to the plant of any printer will surely bring its own reward by renewed orders and an enviable reputation for excellent work. American Type Designs have a decided character and dignity. They represent the very best workmanship and skill in their manufacture. A glance at these original American Type Designs will cause many to buy

**AMERICAN
TYPE
FOUNDERS
COMPANY**

Facts

FOR ALL PRINTERS

THE BEST proof of the value of new type faces to the printer is shown in the tremendous growth of the American Type Founders Company, which puts out more new faces than all other type foundries combined. The printer finds that the customer's eye is caught by the new faces, and that his printing orders increase. The most practical way to obtain difference and distinction is with the newer type faces which give the effect of pleasing novelty, without eccentricity. Business men of today are demanding plain and easily-read composition, well printed. Since this kind of printing is standardized, the only way in which distinction can be obtained is in the use of original display type faces. Many new and attractive faces are shown in this book

**AMERICAN
TYPE FOUNDERS
COMPANY**

COMMERCIAL PRINTING

From the HAYDEN PRESS

THE Hayden Press is glad to announce that recent important improvements and added facilities make it practicable to continue to turn out the highest grade commercial printing at what in many cases will represent a material saving in costs as compared with the best figures formerly made. Quality of course will remain the same, our motto being, "Reliability Plus Progress." Agreeable to this idea, we shall take pleasure in receiving your printing orders

THE HAYDEN PRESS, CHICAGO

Century Border

Story of a Cuban

A New Novel
By General Matoz



TALE of Cuba and the famous war with Spain in which many brave men laid aside all home ties to fight for humanity and liberty. The book presents a picture of the West Indian life which is unsurpassed in modern writing for its splendid realism. General Matoz can write intelligently of this island. He knows Cuba and its people, its wonder and charm, and in a story centering around a great war of rebellion he has taken up the fortunes of Alfa Tero, a son of Captain Manuel Tero of the Cuban army. The book is illustrated in color. The other book written by this great author as a companion story, "The Island's Queen," has proved an unusual seller. Price either book, \$1.50

Illustrated by
Edward Wilders

THE FAIR
LIBRARY DEPARTMENT

Strathmore Mortised Initial

Look for this Trade Mark



A Lucky Strike for You

You will find that a pair of our Swastika Shoes will prove the lucky strike of your shoe-buying tours. In every way they make good all our claims to fit, style and material

Swastika Shoes

End nerve-worry and save foot-fatigue. The wearer is enabled to do things on his feet. Write for style books and name of nearest Swastika Shoe Store

HARRIS CO.
CLEVELAND

Swastika Outline Ornament

MUSIC

PIANO AND STRINGED INSTRUMENT
POPULAR BAND MUSIC

NEARLY three thousand selections were sold by me during October and November. All the old favorites and many of my own copyrights were represented. Many of the season's successes can be found here. Best Orchestra and Band Music always on hand. Music lovers in Rock City are invited to come and hear the latest music played. A good musician always in charge. Read the page advertisement in another section of this program concerning the many Pianos and other Musical Instruments for sale and kept in stock by this store at all times. Ten new Pianos on display

TALKING MACHINES, RECORDS
AND DISCS

R. K. HINES

ROCK CITY, NEW YORK

THE STERLING VALUE OF THE CENTURY TYPE FAMILY

As mahogany is among woods, or wheat among the grains, or the diamond among precious stones, so is the Century Family among types. No work set in it can look other than superior. It is impossible to make any work which is set in the Century Family look commonplace. There is no work (whether the finest or for the most ordinary of every day uses) which cannot appropriately be set in the Century Family. There is no safer purchase, and none more useful. The Century Family will never go out of fashion as long as good typography is in demand. It is a classic family and will therefore outlast many other type styles

American Type Founders Co.

ORIGINATOR OF THE CENTURY FAMILY

The Century Family

AN EXCEEDINGLY DIGNIFIED TYPE FAMILY

Century Expanded
Century Expanded Italic
Century Bold
Century Bold Italic
Century Bold Condensed
Century Bold Extended
Century Oldstyle
Century Oldstyle Italic
Century Oldstyle Bold
Century Oldstyle Bold Italic

American Type Founders Co.

ORIGINATOR OF THE FAMILY IDEA IN TYPES

72 Point

3 A \$6 25 4 a \$4 55 \$10 80

RICH KINGS
Strange Mind

60 Point

3 A \$5 35 5 a \$4 35 \$9 70

BRIDES HOME
Royal Grenadier

48 Point

4 A \$3 95 7 a \$3 90 \$7 85

HONEST BINDERS
Design Knife Handle

42 Point

4 A \$3 00 8 a \$3 25 \$6 25

GRAND COMEDIANS
Stage Manager Excited
Delighted Social Parties

36 Point

5 A \$2 65 8 a \$2 15 \$5 10

REMARKABLE METHOD

Serious Conditions Detected

30 Point

5 A \$2 00 10 a \$2 25 \$1 25

ENTERPRISING COUNCILMEN

Graduating Exercise Unexplained

24 Point

6 A \$1 65 13 a \$1 85 \$3 50

MODERNIZED RAILROAD SCHEMES

Distinguished Scholar Receiving Mention

Banking Question Becoming Complicated

18 Point

10 A \$1 50 20 a \$1 75 \$3 25

BEAUTIFUL RESIDENCE

Charming Landscape Scene

Fragrant Rosebush Garden

10 Point

17 A \$1 15 32 a \$1 35 \$2 50

PROMPT RETURN MENTIONED

Greater Energy Recently Displayed

Real Estate and Government Bonds

Tremendous Deal Lately Negotiated

14 Point

14 A \$1 40 26 a \$1 60 \$3 00

STRENUOUS PERFORMANCES

Audience Extends Congratulations

Enthusiastic Manager Applauding

9 Point

20 A \$1 15 38 a \$1 35 \$2 50

EUROPEAN PRINTERS WELCOMED

Artistic Designer Promoting Harmony

Wonderful Combination Demonstrated

Magnificently Colored Pictures Bought

12 Point

17 A \$1 30 32 a \$1 45 \$2 75

SCIENTIFIC DOCUMENT REQUIRED

Original Mechanical Contrivance Sought

Reconsidering \$1234567890 Propositions

8 Point

21 A \$1 05 42 a \$1 20 \$2 25

EXTRAORDINARY REPORT SUBMITTED

Interesting Resolution Immediately Endorsed

Some Propositions Receive Unanimous Vote

Prospective Members Becoming Very Active

11 Point

17 A \$1 25 35 a \$1 50 \$2 75

EXCITED COMPETITORS RECOGNIZED

Chromatic Selections Rendered Every Night

Many Celebrated Philanthropists Organizing

Resorts Unusually Crowded During August

6 Point

23 A \$0 90 46 a \$1 10 \$2 00

BEAUTIFUL HOMESTEAD FINELY DECORATED

Colonial Architecture Greatly Admired by Contractor

Grand Paintings Procured From European Countries

Charming Lawns and Picturesque Sloping Meadows

Hunting Party Lost in the Wilds of Southern Montana

Splendid Receptions \$1234567890 Lavish Entertainment

HAMTON BANK

Suppose you give just a little serious consideration to the question of savings. One of the fundamental laws of life is the law of cycles. It can be seen all about you. Observe the seasons as they revolve from seed time unto harvest and from harvest to the cold winter. These actions occur in the history of the people; in the lives of nations. You have seen this great country go through very many alternating periods of prosperity and hard times. History tells us of the rise and fall of p
Nowhere is there an unin

REMEMBER IT IS NOT THE MONEY WE EARN
COUNTS IT IS ONLY THE MONEY THAT WE S

Old English Border Linear Border No. 2 Versatile Border

ORDER OF DANCE

Starlight Club

REGULAR MONTHLY

Entertainment and
Dance

MUSIC BY CLUB BAND

The receipts of this event
have been ordered set aside for
the benefit of charity

Cob nial

The Handeson Store

IMPORTERS OF THE
FINEST

Chinaware and
Pictures



AGENTS FOR
RELO STATUARY

Kate Greenaway Mignonette

Modern Cities

MANY THOUSANDS OF PERFECTLY SATISFIED
USERS OF OUR PRODUCTS THROUGHOUT THE
COUNTRY ATTEST THE SUCCESS ATTAINED

NESTON, the inventor, was the first man to develop a line of reinforced concrete lamp standards, and is today the recognized authority on the application of concrete to ornamental lighting. The principle, first employed in manufacturing ornamental standards for the great Neston Lighting Company, was applied later to the construction of Jardus Luxolabra as described in Section 24 of this catalogue. Concrete columns are all made in cast iron moulds and the capital and arms are moulded in gelatine. The material used depends upon the colors and finish desired. For instance, lake sand and cement properly mixed gives a natural sandstone finish; fine white sand and white cement produces a very beautiful white marble finish, whereas, white sand and white cement mixed with crushed marble presents still another appearance. This company is in a position to furnish standards in thirty-two concrete finishes. Ten designs are always kept in stock, believing that the others are merely slight modifications and will not be in great demand. A frame containing samples of ten

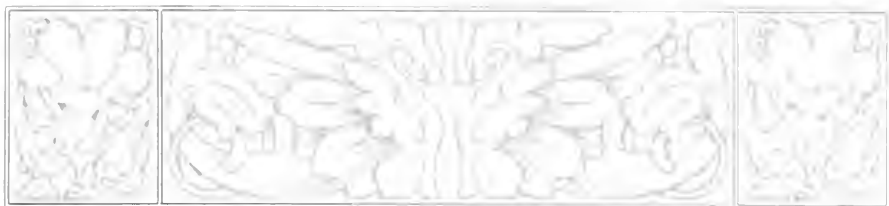

A GENERAL DISCOURSE UPON THE VICISSITUDES WHICH ARE ENCOUNTERED BY AUTHORS AND PUBLISHERS

IT HAS been said by some bright person, probably an ad-writer, that this is the age of the fountain pen, and the amount of manuscripts which are offered to the publishers would certainly lead one to that conclusion. A very interesting and characteristic collection they are, too, ranging from the delicate, sandalwood scented and beautifully wrought pages of a foreign essayist and the pathetically hopeless attempt of the neophyte to the bulky reams of the philosopher or scientist. The surprising thing is not that so many are found to be unacceptable as that so many are found to be passably good. The reader for a prominent publishing house has estimated that of the great mass of manuscripts which are submitted during a year only about one and one-half per cent are published. This does not mean that the others were worthless, but simply that they lacked the qualities which were necessary to make them available. In the case of fiction, either the plot or the treatment would be hackneyed, or lack human appeal, while other manuscripts dealt with subjects that had already been better handled, or subjects that are not worth handling at all. Many manuscripts miss acceptance because, while they are passably good and would probably sell five hundred or even a thousand copies, this sale would not be great enough to pay the cost of manufacture. Roughly, it takes a sale of about five thousand copies to pay expenses, and unless such a sale is practically certain, publication is not worth while. The author who really has an interesting narrative to tell, or an important message to convey, can usually succeed in finding a publisher to undertake the manufacture and sale of the book upon some sort of terms. Naturally the publisher makes as good a bargain with the author as possible; that is only ordinary business prudence. In fact, the author who has written one or more successful books is usually in a position to dictate almost any sort of terms. Some of the well-known writers are the object of keen rivalry on the part of publishers, and are paid large sums in advance royalties. This practice is exciting, but not always satisfactory to either party to the contract, especially when the

72 Point

3 A \$7 15 4 a \$4 60 \$11 75

HERMETIC
Design Neatly

60 Point

3 A \$6 15 4 a \$4 00 \$10 15

RICHER MINE
Modern Denizen

48 Point

4 A \$3 75 8 a \$3 85 \$7 60

ROUND NUMBER
Bureau of Industries

42 Point

5 A \$2 90 8 a \$3 35 \$6 25

AMERICAN MINERS
Brother Declared Insane
Housewives Complained

36 Point

5 A \$2 70 8 a \$2 30 \$5 00

RESOLUTE COMRADES
Leading Concern Supervised

30 Point

6 A \$2 40 10 a \$2 15 \$4 55

COMBINES STRONG MERITS
*Return of the Scientific Expedition
Considering Separate Negotiations*

24 Point

6 A \$1 70 12 a \$1 80 \$3 50

UNDERGROUND TRANSFERS SOLD
*Modern Ventilating Appliance Employed
Displays Handsome American Characters*

18 Point

9 A \$1 60 20 a \$1 70 \$3 30

UNITED RICHES GIVEN
*Cause Many Aching Hearts
Reveals Unpleasant Tidings*

10 Point

18 A \$1 25 35 a \$1 25 \$2 50

MITIGATING CIRCUMSTANCE
*Chiromantic Development Explained
Nominal Damages Awarded Clients
Heirs Claimed Estates in Fee Simple*

14 Point

14 A \$1 40 29 a \$1 60 \$3 00

HOARDED NUMEROUS COINS
*Praises Ludicrous Burlesque Fiasco
Grotesque Characters Manipulated*

9 Point

20 A \$1 25 41 a \$1 25 \$2 50

NUMEROUS SCHEMES OUTLINED
*Sensational Reports Concerning Explorer
The Government Issues Emphatic Orders
Ingenuous Navigators Experience Trouble*

12 Point

17 A \$1 40 32 a \$1 35 \$2 75

FIVE ROUND MILLIONS INVESTED
*Land of Golden Sunset Gives Opportunity
Metropolitan \$1234567890 Expenditures*

8 Point

20 A \$1 10 42 a \$1 15 \$2 25

DISCONTINUED EVIL PERFORMANCES
*Biennial Celebrations are Financially Successful
Contemporaneous Technologists Thunderstruck
Several Printers Lucidly Explain Disappearance*

11 Point

17 A \$1 25 35 a \$1 50 \$2 75

STRINGENT MEASURE CONSIDERED
*Congested District Impedes Railroad Progress
Bright Individuals Demand New Legislation*

6 Point

23 A \$0 95 45 a \$1 05 \$2 00

RECOMMENDED MAGNIFICENT INDUCEMENT
*Honorable Gentlemen Promulgate Professional Doctrine
Numismatical Collectors Confiscate Lincoln Penny-piece
Spasmodic Indigestion Causes Resolutions and Kicking
Medical Attendance \$1234567890 Given Several Girls*

THOUGHTS ON PRINTING

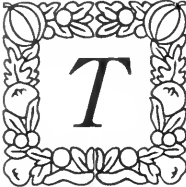
 *HE success or failure of all printing is steadily becoming more dependent upon design as used in a broad sense. Design includes the preliminary outline or main purpose and all of the elements by which printing is made efficient. It therefore contains the insight into general business conditions and specifically into the business which is to be directly served. Design is arrangement. It is the reasonable and practical adjustment of all the mechanical and esthetic qualities to produce the very best results in competition with all of the rest of the world's products. It is one man or one establishment against all of the rest. Design in printing is the element which combines imagination, taste and skill to produce a desired and definite result. The printing industry may be termed the barometer of commercial prosperity. It differs from all other industries in that it deals with every calling and is closely identified with the prosperity of each. A manufacturer of shoes has but an academic interest in the piano industry, but both the shoemaker and the piano man are vitally interested in the printing art*

Let Us Make You a Dummy for the Job

MAIL TO US THE FOLLOWING INFORMATION FOR A DUMMY

Approximate Size of Catalogue

Quantity Wanted

Paper Stock (inside)

Cover Stock

Kind of Cuts you will use

Printed in what Colors

Any Type preference



It is important in issuing your advertisements that you know how they are going to appear when finished. The cost can be lowered to a minimum since you have an idea of the work before it is done. If you will give us the information asked for on attached postal card, we will make you up several dummies, *without any cost to you*, from different grades of our papers, and afford to the printer the advantage of the color combinations that we have found can be used in different shades with best results. We have gone to considerable expense experimenting on these color combinations, with the view of being an assistance to you in your work of advertising and *will appreciate an early reply* with the accompanying blank sheet filled out. We believe we can be of great help to the advertiser, and that he will be sure to find these samples very valuable

KENDSORM PAPER HOUSE
CORNER UNION STREET AND WASHINGTON AVENUE

Blossoms

■ ————— ■
The plants that give us the most blossoms are those kept young and healthy by people who own them. A printing plant is no exception to this bit of wisdom. The blossoms of dividends are reaped only by the printer who is careful to keep his composing room supplied with plenty of type of modern design and style

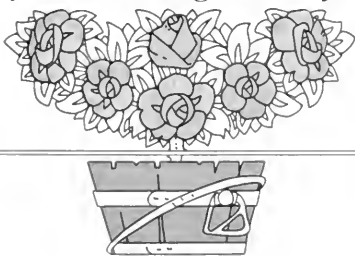

Strathmore Ornament

Sectional Initial Former Della Robbia Border

THE GREAT HARPIST

THE DISCUSSION
OF NOTED MUSIC



THE JOYCRAFTERS BOOK
VOLUME FOUR HUNDRED

Versatile Ornament

Century Oldstyle Bold

120 Point

3 A \$12 60 4 a \$8 05 \$20 65

HE Did

96 Point

3 A \$9 65 4 a \$6 20 \$15 85

HINTED

Big Shop

84 Point

3 A \$7 60 4 a \$4 85 \$12 45

MONGER

Sold Crisp

Century Oldstyle Bold

72 Point

3 A \$7.95 4 a \$5.00 \$12.95

KIND MEN

High Banks

60 Point

3 A \$6.20 4 a \$3.95 \$10.15

SEIZE KNIFE

Reports Given

Useful Camels

54 Point

3 A \$4.95 4 a \$3.80 \$8.75

BOYS CHASED

Company Stops

Before Exercise

Century Oldstyle Bold

48 Point

4 A \$4 25 6 a \$3 60 \$7 85

**RIGHT NUMBER
Stronger Material
Prince and Dukes**

42 Point

4 A \$3 45 7 a \$3 20 \$6 65

**HONOR MEMBERS
Catalogue Designers
Buildings Important**

36 Point

4 A \$2 70 7 a \$2 50 \$5 20

**HUNTS KINGFISHERS
Determined Composer
Curious Detective Story**

30 Point

5 A \$2 25 9 a \$2 15 \$4 40

**REMARKABLE MANSIONS
Asked Matrimonial Question
Enterprising Students Retire**

Century Oldstyle Bold

24 Point

6 A \$1 75 12 a \$1 85 \$3 60

DISFRANCHISING COUNCILMEN
Educational Departments Suffering
Strong Administrations Established

18 Point

9 A \$1 55 18 a \$1 70 \$3 25

HISTORICAL SPEAKER BECAME KNOWN
Century Oldstyle Bold Prints Very Distinctly
Marvelous Building Erected Near Broadway
Many Handsome Features Contained Within

14 Point

12 A \$1 40 24 a \$1 60 \$3 00

FOREIGN WRESTLER DEVELOPING MUCH MUSCLE
Heavyweight Brewery Worker Easily Downed Tuesday
Giant Covered Five Miles Before Breakfast During Rain
Sporty Newspaper Reporters Crowd Training Quarters
Photographs Rapidly Purchased by Admirers Every Day

12 Point

14 A \$1 25 29 a \$1 50 \$2 75

CAREFUL COMPOSITORS HIRED
Disastrous Railroad Wreck Averted
Fireman Stops Engine on Sidetrack
Open Switch Nearly Caused Trouble
Companies \$1234567890 Jubilant

8 Point

19 A \$1 05 38 a \$1 20 \$2 25

COMPOSITORS RECEIVE CHARTERS
Grand Picnics Attract Several Athletes
Exquisite Medals Presented Contestant
Starting Point Crowded with Spectators
Beautiful Women Adore Hero Lifesaver
Excursionists Traveled Over Mountain
Stylish Young Conductor Takes Tickets

10 Point

16 A \$1 20 32 a \$1 30 \$2 50

PROSPEROUS MERCHANT RETIRED
Spends Leisure Hours Reading Hamlet
Money Became Useful in Declining Days
Was Ribbon Counter Expert Early in Life
Contemplating Enormous Improvement
Retains Bachelor Quarters in Patterson

6 Point

21 A \$0 95 42 a \$1 05 \$2 00

DEMONSTRATION INTERESTED FARMERS
General Advertising Display Series Delighting
Brave Detective Foiled Highwayman in Street
Desperate Safecrackers Fought Against Police
These American Type Faces Please Customers
Remarkable Trip Taken to London and Venice
Wonderful Battleships Enter Harbor During War Game
Choice Fruits and Vegetables Procured Today
Some Bankers \$1234567890 Make Expenses

9 Point

18 A \$1 20 37 a \$1 30 \$2 50

MANY HUMOROUS STORIES PUBLISHED
Made by American Type Founders Company
Contain Modern Wit Throughout Entire Book
Awkward German Sayings Amused Children
Graceful and Dignified Characters Produced
Originated Beautiful Ornaments and Borders

5 Point

20 A \$0 95 40 a \$1 05 \$2 00

HANDSOME ADVERTISEMENTS BECAME POPULAR
Compositors Observed Beautiful Century Oldstyle Bold
Great Steamers Cleared Port Safely Loaded with Horses
Handsome Building Destroyed by Tornado Last Month
Contains Dignified Character Throughout Entire Series
Wonderful Battleships Enter Harbor During War Game
Government Employees Escaping From Federal Prisons
Largest Island Inhabited by Peculiar Looking Creatures
Bronze Statue Becomes Tarnished From Being Exposed

Century Oldstyle Bold in Practical Display

The New Wing Horton Mailer



The Most Accurate Machine of its kind on the Market

For many years the Horton Mailer has been characterized as the best. The many testimonials applauding its merit are evidence, together with continued and repeated orders, that unquestionably proves it has maintained its reputation. All developments of weakness in the Horton have been carefully noted and remedied and several new and valuable features have been added

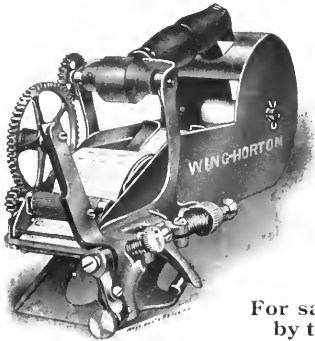

MADE IN SIX SIZES

- | | |
|--------------------------|--------------------------|
| No. 1 Mailer, 1 7-8 inch | No. 4 Mailer, 3 inch |
| No. 2 Mailer, 2 1-4 inch | No. 5 Mailer, 3 1-2 inch |
| No. 3 Mailer, 2 5-8 inch | No. 6 Mailer, 3 7-8 inch |

In ordering be particular to give width of list to be used so that machine may be properly fitted for your work

For sale by the **American Type Founders Co.**

Cast Squares Twentieth Century Ornament

THE HEMPEL MONARCH

Quoin

Has all the best features of the Improved Hempel Quoin with the extra advantage of a self-locking device. It is simple in formation and at the same time easy to operate, requiring little or no attention after the form is on the press. A neat circular, containing extra details, prices, etc. will be furnished to any one who feels interested

AMERICAN
TYPE FOUNDERS CO.

Wayside Ornament

ART IN PRINTING



The Kind Your Patrons
Are Looking For

Secured With
American Line
Type Faces

Versatile Ornament

Perfumes

IMPART A DELICATE AND PLEASING FRAGRANCE THAT REMINDS ONE OF SUNSHINE AND ROSES. THE FASHION LEADERS OF PARIS PREFER IT

THIS choice selection of perfumes is the product of Ferries & Larue one of the oldest and most celebrated firms of chemists and makers of toilet articles in Paris. The signatures of the firm on its packages of perfumes stand for perfection in all the word implies

EACH package of these powdered perfumes is put up in dainty air-tight boxes and guaranteed to hold their fragrance until used. These extracts are made from a formula that is only understood by the makers, and consequently can't be duplicated. Have been used for years by the most exclusive families of Europe and stand today the most popular articles of their kind in the world

SOME people prefer the liquid perfume, and to satisfy the demand of this class of patrons a special line of delightful extracts has been prepared and put up in handsome cut-glass bottles, making a splendid ornament for the boudoir or a delightful present for any occasion
Our special price list is now ready for mailing



HARRIS & MORSE

IMPORTERS AND MANUFACTURERS OF SELECT TOILET ARTICLES
Bond and Oakford Streets CHICAGO, ILL.

Foreign Offices: 768 Rue Lafayette, Paris, and 195 Middlesex Street, London

72 Point

3 A \$7 80 4 a \$5 00 \$12 80

HUNTERS
Shops Built

60 Point

3 A \$6 80 4 a \$4 60 \$11 40

REPRINTED
After Burglar
House Rented

54 Point

3 A \$5 05 5 a \$3 95 \$9 00

QUIET NIGHT
Grand Banquet
Required News

48 Point

3 A \$1 05 6 a \$1 05 \$8 10

NOTED SINGER
Entertain Society
Husky Merchants

42 Point

3 A \$3 15 6 a \$3 15 \$6 30

LENDING MONEY
Oketown Physicians
Surprising Gymnast

36 Point

4 A \$2 65 7 a \$2 65 \$5 30

PRINTER EXAMINES
Jerseyite Injured Hyena
Compositors Improving

30 Point

5 A \$2 25 8 a \$2 00 \$4 25

PROSPERITY CONTINUES
Confirmed Bachelor Repents
Truthful Lawyers Discovered
Blacksmith Giving Reception

Century Oldstyle Bold Italic

24 Point

6 A \$1 85 10 a \$1 75 \$3 60

BURNED MANSION DESERTED
*Printing Specimens Receive Praise
Honorably Discharge Irish General
Incapacitated Lieutenant Removed*

18 Point

9 A \$1 55 16 a \$1 70 \$3 25

PERFORMANCE CONTINUED TUESDAY
*Congressman From Missouri Congratulated
Foreigners Escaping Quarantine Inspectors
Honest Conductor Receives Handsome Gifts*

14 Point

12 A \$1 40 23 a \$1 60 \$3 00

RETURNED NINETEEN THOUSAND WEDNESDAY
*Detective Discovering Counterfeiters Notifies Inspector
Infuriated College Professor Denounces Clever Student
Twelve Distinguished Compositors Recently Competed
National League Baseball Commission Entertainment*

12 Point

15 A \$1 30 28 a \$1 45 \$2 75

EXHIBITS HANDSOME DESIGN
*Noname Pleasure Club Organized
Child Graduate Surprises Teacher
Printers \$1234567890 Manicured*

8 Point

19 A \$1 10 38 a \$1 15 \$2 25

SOUTHERN BOULEVARD ELEGANT
*Great Mechanic Invents Useful Knives
Professional Ballplayer Congratulated
Entertainment Commencing Saturday
Heroic Firemen Miraculously Escaped
Mechanics Recognized Superintendent*

10 Point

16 A \$1 20 30 a \$1 30 \$2 50

CONFIRMING REPORTS RECENTLY
*Lieutenant Recovers Important Papers
Gigantic Steamer Returning Thursday
Housesmiths Building Elegant Bridges
Titled Foreigner Marries Stenographer*

6 Point

21 A \$0 95 42 a \$1 05 \$2 00

MOTHER PRAISED TRUTHFUL CHILDREN
*Congressional Documents Recovered Monday
Handsome Inventor Mysteriously Disappears
Public School Graduate Wins Diamond Medal
Champion International Swimmer Competed
Clever Football Instructors Seriously Injured
Inspector Changes \$1234567890 Complaints*

9 Point

18 A \$1 20 35 a \$1 30 \$2 50

MECHANICS ENCOURAGE APPRENTICE
*Printer Discovered Pressman on Broadway
Enthusiastically Received Handsome Singer
Champion Billiard Players Gave Exhibition
International Bowling Tournament Closing
Farmer Talking Scientifically Missed Watch*

5 Point

19 A \$0 95 38 a \$1 05 \$2 00

CLEVER CHICAGO HEIRESS REFUSED NOBLEMAN
*Compositors Showing Handsome Specimens of Printing
Century Oldstyle Bold Italic Useful in Job Composition
Distinguished Irish Gentleman Distributing Sovereigns
Honest Independent Youth Returning Enormously Rich
Fourteenth Consecutive Brooklyn Handicap Completed
Former Collegians Recognized Oldtime Acquaintances
Meditated Seriously on Entering Regents Examination
Handsome Young Woman Discovers Missing Diamonds*

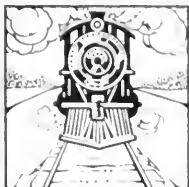
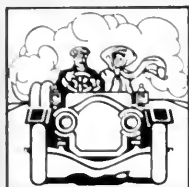

Travel Outfits

PATENT GRIP

Something new and original. Every traveling man should have one. The most compact grip ever sold. Contains all you need and insures the comforts of home. Send for catalogue "Travel Outfits"

C. R. THOMIER CO., CUBA, N. Y.

Versatile Ornaments Boston Breton Cast Squares

Finest Paper

SECTION SIX

The papers shown in this section of Pike's Sample Book are all the very best. A fifty per cent. discount is allowed on all orders for box stationery or invitation stock that are shown in section six. All Pike's Finest Paper bears the Two Cannon water-mark

S. I. Pike Co.
SOUTH BUFFALO, N. Y.



Celebration Border

ZOMA COLD CREAM



TESTIMONIALS FROM
SOME FAMOUS STAGE
PEOPLE OF THE LAND

*"Beauty is only skin deep and
Zoma Cream makes the skin"*

The tint shown on this page was routed on a Miller Saw Trimmer

Versatile Border

Come Next Friday and Help Us

Celebrate

Our Furniture Sale

WE HAVE just completed the new addition to our furniture store in time to accommodate a very large shipment of new stock. We intend celebrating the event on Friday, September first, and will offer some rare bargains in furniture and carpets. Many pieces have been marked down below cost. We must make room for the new. From the many bargains we display below three samples:

Morris Chairs
sold for \$8.50
on this
Friday **\$5**

Parlor Suites in
various designs
to go
for .. **\$16**

Brass Beds in
Mission styles
on this
Friday **\$8**

M. S. JONES & CO.

294 OSBORNE STREET

Celebration Border

*Twentieth Century Type Designs for
Twentieth Century Printers*

Century Oldstyle Bold Italic in Display



Hays & Co.

Mothers

Our twenty-eighth season as leaders in winter wear for children will be fittingly celebrated with a great New Year Display of exclusive and fashionable clothing.

You are urged to visit our store during the special display days, January second and third. Bring the little tots along.

Holiday Decorator Art-tile Tint Formers

For Baby

Always Pure

For sale at all leading drug stores in the land

Rose Soap is the ideal bath soap for a baby because it soothes the skin and cleanses in the most gentle manner. It will keep the skin sweet, wholesome and healthy. Big bar 25c

ROSE SOAP

72 Point

3 A \$6 70 4 a \$4 20 \$10 90

MERINGUE
Kings Incline
Such Domain

60 Point

3 A \$5 20 4 a \$3 65 \$8 85

ROME BURNS
Quiet Dungeons
Lemon Crushed

48 Point

4 A \$3 95 6 a \$3 55 \$7 50

MEMBERS UNITE
Speculator Retreats
Harmony Enhanced

42 Point

4 A \$3 15 7 a \$3 10 \$6 25

RENTED BUNTINGS
Secured Remuneration
Graceful Dance Sketch

36 Point

4 A \$2 50 7 a \$2 50 \$5 00

GENEROUS BRITISHER
Rutland Mentions Dickens
Limousine Manufacturing

30 Point

5 A \$2 00 10 a \$2 25 \$4 25

HENRICKSON REIMBURSED
Expeditions Involved Great Peril
Maneuvering Seaman Triumphs
Discern Enemy's Base Intriguery

24 Point

6 A \$1 70 11 a \$1 80 \$3 50

NINETEEN FARMERS IN TROUBLE
Century Expanded Important Creation
Unusual Beauty Ingeniously Developed
Judicious Users Receive Nice Contracts

18 Point

9 A \$1 45 20 a \$1 80 \$3 25

RENDERING DENIZENS CERTAIN BENEFITS
Delivered Strong Forceful Argument Convincingly
Legislature Enacts Subject of Extended Discussion
Oratorical Efforts Reconcile Seeming Inconsistency

14 Point

12 A \$1 30 26 a \$1 70 \$3 00

FUNGUS GROWTH ENDANGERS CONIFEROUS FORESTS
Many Insectivorous Birds Furnish Probable Solution of Problem
Enthusiastic Botanists and Nature Experts Show Exasperation
Interesting Research Concerning Protracted Incubating Season

12 Point

15 A \$1 25 32 a \$1 50 \$2 75 10 A \$0 50

REPRESENTATIVE BUTCHERS INTERRUPTED THE PROCEEDINGS
Returning Saunterer Discovers Remarkable Songbird on Hyperborean Coast
Seaside Mallow Beautifies Northern Marshes During August and September
Numerous Doubting Scientists Plan Investigation Before Accepting Records

11 Point

18 A \$1 30 37 a \$1 45 \$2 75 11 A \$0 50

HISTORICAL LIBRARIES RANSACKED
Archives Searched for Ancient Folklore Tale
Investigators Continue Labors Till Daybreak
Explanation of Quaint Dutch Custom Sought

6 Point

24 A \$0 90 48 a \$1 10 \$2 00 20 A \$0 50

MOUNTAIN CLIMBERS ORGANIZED SOCIETIES
Dangerous Chasms Crossed by Means of Rope Bridges
Delightful Excursion Party Being Entertained Today
Rehearse Day's Exciting Experiences and Adventures
Women Wading Cool Swift Mountain Streams Shriek
Stories of Narrow \$1234567890 Escapes from Precipices

10 Point

18 A \$1 15 36 a \$1 35 \$2 50 13 A \$0 50

BENEFACTORS EMPLOYED KIDNAPPER
Magnificent Productions Tempt Curio Hunters
Collusion of Interests Ratifies Queer Procedure
Modest Blacksmith Surprises Dignified Editors

5½ Point

22 A \$0 95 44 a \$1 05 \$2 00 20 A \$0 50

DIGESTIBLE APPETIZER TANTALIZING FISHES
Further Investigation Reveals String Attached to Bait
Important Document Unearthed Near Great Warship
Procures Exquisite American Borders and Ornaments
Astounding Financial Gains From Meagre Beginning
Most Determined Effort Likely to Win Lasting Laurels

9 Point

21 A \$1 15 42 a \$1 35 \$2 50 15 A \$0 50

MOUNTAIN GEOLOGICAL EXCURSION ENDS
Interesting and Extensive Paleontological Research
Enthusiastic Money Lenders Contribute Sovereigns
Mythological Creatures Enthuse Serious Professors

5 Point

23 A \$0 95 45 a \$1 05 \$2 00

HANDSOMEST DESIGNS RECEIVED HIGHEST HONORS
Years of Experience Enable the Production of Better Products
Originality Next to Accuracy and Detail is a Big Asset in the
Printing Business. Here is Where American Faces Excel All
Others, Commanding that Distinctiveness Peculiar to the Best
Preserving That Artistic Touch Coupled With Clear Legibility

8 Point

20 A \$1 05 40 a \$1 20 \$2 25 15 A \$0 50

STARTLING AMERICAN INVENTION OPERATED
Sententious Observations Entertain Danish Philosopher
Numerous Vanishing Products Renewed Simultaneously
Curious Bystanders Desiring Information Crowd Streets

4½ Point

19 A \$0 95 38 a \$1 05 \$2 00

IMPEDIMENTS OF GREAT MARCH OF PROGRESS OBLITERATED
Whole Block of Dilapidated Structures Removed to Make Room for Tall
Buildings of Massive Proportions and Embodying in Their Construction
Grand Conceptions of Architectural Design, Beauty and Convenience of
Interior Arrangement, Improved Ventilating System, Brilliantly Lighted
Corridors Connecting Fast and Unsurpassed Electric Elevator Facilities

7 Point

23 A \$1 05 46 a \$1 20 \$2 25 18 A \$0 50

PURCHASERS CONSIDERING THE PROBABLE INCOMES
Investing Moneys Only in Substantially Manufactured Products
Reputations Founded Upon Quality Receive First Consideration
Large Orders Given Houses Featuring Tried and Proven Goods

4 Point

21 A \$0 85 42 a \$1 15 \$2 00

EDITOR GREATLY ENTHUSED ON HEARING OF APPOINTMENT
Official Notice From Washington to Fill an Important Diplomatic Station
Authorities Had Long Sought After Man of Unusual Tact and Sagacity
Complicated Intricate and Delicate Problems to be Studied and Adjusted
Face to Face With Questions Concerning the International Peace or War
Grand Celebration and Banquet Tendered Editor by Home Constituents

Century Expanded in Practical Display



OUR NEW TYPE FACES

MODERN printing seems to be getting away from eccentricity. Designs in type should not be crowded or over-ornamented. There is such a mass of printing being put out from all sides, both in literature and advertising, that in order to get a difference the printer must use new faces. They must be easily read. The easiest way to get a difference is with new faces, and the printer with the greatest number of new faces can create the most work; the reason is that he can offer his customers a maximum amount of difference. The best proof of the value of new faces for the printer is shown in the growth of the American Type Foundry

Strathmore Ornaments

A STORY OF THE SUCCESS OF A WELL KNOWN FIRM LOCATED IN EAST BERLIN

This is a small booklet, but its contents disclose a great deal about a certain large print shop in this city. If you can use any printed matter it will prove to be an interesting booklet. And not only that, it will also be a profitable outlaying of time to look through its contents. This print shop is located at Eighth street and Hamilton avenue; it is, as you well know, practically in the very heart of the business district. Incidentally, the shop is composed of a large, roomy and well-lighted floor, with all the modern advantages that are to be acquired from the architect's brain. This plant is equipped with newest printing material which was chosen with a view of being serviceable and distinctive, thus it enables us to print

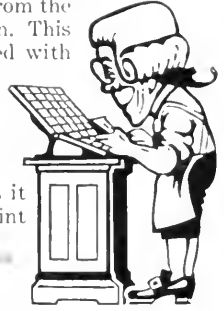

Art Ornament I-129002 Mercantile Border No. 49

Fine New Islandwood Pleasure Resort

BEAUTIFUL scenery abounds about Islandwood and makes it one of the most picturesque places in this part of the country. This is a conveniently situated resort, possessing many varied attractions, and is sure to become the most popular summer resort, as evidenced by the fact that many of America's wealthier people are now making their summer home at Islandwood. Boating and fishing are also drawing features for this lake in summer

SHOES

*The Boot Shops
of Quality*

THE EXCLUSIVE CENTURY MODELS

We offer you in ready-to-wear shoes all the comfort and ease of custom service—the result of our life-long experience in custom boot making—yet you pay only for the material and built-in value of the shoes. Century

shoe-service-by-post affords to patrons at a distance an opportunity to secure literal correctness and the acme of comfort in footwear, quite as satisfactory by the mails as if purchased in person. Upon request we will furnish large photographic reproduction of current shoe styles for street dress or sporting wear. Our ready-to-wear shoes, the only shoes of similar character and quality ever offered to buyers public ready-to-wear, are sold from seven dollars upward

Individual Reco

Perfect records are kept of all our fittings, and all you will need to do after your first order is to write or wire your requirements as to kinds of shoes or occasion of wearing and the right shoes will go forward within the hour, all at our risk and with our guarantee of satisfaction

FRED SMITH

Ye Bootmaker for Men and Women



Select Xmas Furnishings



EVERY year we take particular notice of the numerous gifts selected from our stocks and we have arranged to display the largest and most attractive line of furnishing goods ever offered Xmas shoppers in this city. For those who cannot come to the store, we have compiled a catalogue with prices

Hermis & Sons
Minneapolis, Minnesota

*New York City
Philadelphia
Saint Louis
Cleveland
Chicago
Boston*

THE SUNSETS OF AMERICA

By A. TRAVELLER

TOURISTS and travelers have written much concerning the many beauties of the sunsets of *Norway* and of *Sweden* and of other foreign countries. But *America* is not far behind in this respect. In times to come parts of this country will become noted for their beautiful sunset effects, as they should be now. Without leaving his own country an American may see a greater variety of mountain, plain and glacier sunset scenery than can be found in all *Europe*. In addition he has the opportunity of witnessing tonal effects such as may be observed in no other part of the world.

There is probably no more beautiful spectacle than a sunset in the *Bad Lands*, which lie between *North Dakota* and *Montana*. Even at high noon the tones in these dead, barren hills are wonderful; the colors run through the entire gamut of the color scale. The most gorgeous reds, the palest and most delicate blues, the softest pinks and the most blatant yellows are jumbled together and softened by the atmosphere.

As the sun sets the natural colors change. The hills seem to be bathed in transparent films of ever-changing color. The reds are changed into deep and translucent purples as the sun gets lower, and the delicate pinks are strengthened until they become livid, flaring vermilions. As the sun nears the horizon these changes are effected with almost startling rapidity. One can scarcely wink without opening his eyes on an entirely new scene. The results are almost kaleidoscopic.

The autumn sunsets in some parts of the *New England States* are also glorious. Such beautiful sunset scenes as one witnesses in this part of the country have proved an inspiration for many of the highest examples of our American art. The country about *Franconia*, in *New Hampshire*, is the seat of a colony of artists, drawn to this section by the beauties of the local sunsets. *Franconia* is situated in the heart of the *White Mountains*, in themselves one of the beauty-spots of the continent. On all sides rise the rugged, stolid hills. Down through *Franconia* there flows the *Pemigewasset River*, shimmering in silvery and golden beauty. The sunset paintings produced by the artistic colony who have captured this section have attracted wide attention throughout the world of art. Even in the more thickly settled and conventional sections of our

country the beauty of the sunsets is rarely ever surpassed. Seldom can an artist's brush truthfully portray the beauties of an *Ohio River* sunset. Through a rift a ball of burnished gold illuminates the ragged edges of the cloud tops and casts over the almost rippleless stream a sheen of molten gold. The sun-tipped clouds reflect their splendor in the glassy mirror of the river and cast upon the foliage and the meadows of the banks a tinge of opalescent yellow.

One American artist of great prominence has devoted himself almost entirely to sunsets. The paintings of Gilbert Futrelle have won a reputation throughout the world. The first examples of his work to attract attention were done in the far west, most of them in the *Grand Canyon of the Colorado*. An exhibition of these paintings hung at the St. Stephen's Club in Chicago made a distinct sensation and were highly praised by the critics.

Thereafter Mr. Futrelle made a two-years' trip to the Arctic region lying about *Baffin's Bay*. He painted fifty canvases or more, suffering terrible hardships and facing difficulties which have been experienced by no other enthusiast in the pursuit of art. After he



A SUNSET IN THE UPPER YELLOWSTONE VALLEY

returned to the States some of his Arctic sunset pictures were reproduced in colors in an issue of a New York magazine. They caused a great deal of comment and were declared the most unique paintings ever executed by an artist of any repute. Before the interest in his works had subsided, Mr. Futrelle was off for new fields; this time he camped in the *Bad Lands*, just to the east of *Glendive*. The atmosphere of the country lent to his work here a larger element of impressionism than had before been noticeable. As usual, sunsets composed a large part of his work in this country.

At the end of six months he returned to New York City. For something more than two years he was comparatively idle. During this time, however, he painted many sunset scenes, both in winter and summer, taking usually as his subjects the *Palisades*. He also worked along the New Jersey coast, and some of the paintings executed about this time are numbered among the best of his life's work. Two of them are now hung in the Museum of Chromatic Art in New Zealand. For the past two years he has been located in San Francisco.

72 Point

3 A \$6 75 4 a \$4 40 \$11 15

HERDINGS
Zone Exempt
Bridge Metal

60 Point

3 A \$5 60 4 a \$3 80 \$9 40

MEND STOCK
Builder Dorian
Easter Beauties

48 Point

3 A \$3 65 7 a \$3 85 \$7 50

RIGHT MINDERS
Arousing Kingdom
Exacted Conception

42 Point

4 A \$3 35 6 a \$3 00 \$6 35

*MODERN FIGHTER
Selects Genial Designs
Handsome Characters*

36 Point

4 A \$2 35 8 a \$2 70 \$5 05

*PRODUCT EXPORTED
Lodged Zealous Confidence
Important Market Opened*

30 Point

5 A \$1 95 10 a \$2 30 \$4 25

*DISCONTINUES COMBINES
Substantial Country Bungalows
Remarkable Beauties Examined
Method for Thinking Advertisers*

24 Point

6 A \$1 70 12 a \$1 90 \$3 60

*BENIGNITY CONFIRMS VICTORY
Notable Conscientious Founders Work
Extraordinary Achievement Published
Noteworthy Features Enhanced Beauty*

Century Expanded Italic

18 Point

9 A \$1 50 21 a \$1 80 \$3 30

EXAMINE ADVERTISEMENT STRUCTURE
Psychological Experiments with Various Industrial Literature Disclose Profitably Adapted Advantages Typographical Investment is Beyond Expectations

14 Point

13 A \$1 35 28 a \$1 65 \$3 00

DETERMINED ADVERTISERS EXHIBIT EXPERIENCE
Significant Tendency Toward Exclusively Ornamental Design Reporting Extraordinary Fantastic Evolution of Embellishers Many Educated Users of American Type Founders Company

12 Point

16 A \$1 30 30 a \$1 45 \$2 75

PRINTERS REVIEWING ULTIMATE HISTORICAL COMBINATION
Deadly Monotony in Printing is Prevented by Installing the Newest Designs Permanently Recognized Business-Compelling Typographic Laws Necessary Comely Women Demonstrating \$1234567890 Remarkable Electric Sprinkler

11 Point

18 A \$1 35 35 a \$1 40 \$2 75

ENGINES ENDANGER HUMAN LIVES
Crowded Throughfares Cause Disturbance Strap-Hanging Habit Revolutionizes Travel Twelve Reputable Boston Residents Involved

6 Point

23 A \$1 00 45 a \$1 00 \$2 00

INVESTORS REALIZE GREATER DIVIDENDS
Weary Stockholders Receiving Documentary Evidence Municipal Building Completed on Twentieth of April Dreaming of Several Mansions and Beautiful Garden Propositions For Faithful Unquestioning Acceptance British Soldiers Reviewed \$1234567890 by Compositors

10 Point

18 A \$1 20 36 a \$1 30 \$2 50

MANAGERS MAKE STRONG PROTESTS
Hotel Guests Mutual Benefit Society Framing Demands Incorporating Arbitrary Resolutions Great Celebrations Remained Unexceptionable

5½ Point

20 A \$1 00 40 a \$1 00 \$2 00

PROLIFIC ORIGINALITY LOSES COMPETITION
The American Type Founders Company Entered the Industry of Type Making With a Policy Which Would Not Allow Even the Appearance of Imitation and Still Demands Originality in All its Newest Type Creations Wise Printers Will Make Their Selections of Type and Brass Rule from Among Our Many Beautiful Designs

9 Point

20 A \$1 15 41 a \$1 35 \$2 50

REGISTERED PHARMACISTS STUDY DRUG
Secret Fountain Containing the Youth Perpetual Modern Ponce de Leon Highly Rewarded Publicly Distinguished Scientists Claim Noted Discoveries

5 Point

22 A \$0 95 44 a \$1 05 \$2 00

PRESENTS UNPRECEDENTED FORCEFUL APPEALS
You Remember the Story of a Drummer Who Remized the Cost of His Winter Overcoat in His Expense Account. That Item Was Stricken Off Next Season His Expense Account Went Through Flying. "I see," said His Manager, "That You Haven't Another Overcoat in Your Account This Trip." "Oh, It's There All Right," Replied the Honest Drummer Printers Could Profitably Treat Type as the Drummer did the Overcoat

8 Point

20 A \$1 05 42 a \$1 20 \$2 25

INTERNATIONAL CONVENTION COMPLAINING
General Manifestations Revealed International Interest Prospective Investor Desired Certain New Information Rapidly Spreading Broadcast Throughout the Universe

4½ Point

19 A \$0 95 38 a \$1 05 \$2 00

PURCHASED INDIVIDUAL TYPE DESIGNS FOR CLIENTAL
You Remember the Story of a Drummer Who Remized the Cost of His Winter Overcoat in His Expense Account. That Item Was Stricken Off Next Season His Expense Account Went Through Flying. "I see," said His Manager, "That You Haven't Another Overcoat in Your Account This Trip." "Oh, It's There All Right," Replied the Honest Drummer Printers Could Profitably Treat Type as the Drummer did the Overcoat

7 Point

25 A \$1 10 50 a \$1 15 \$2 25

QUESTIONS ELIMINATING PRICE-CUTTING PRINTER
Hopeful Outlook Largely Represents Conditional Improvement Dependent Primarily Upon Advantages Maintained Mutually Two Bankers Determine Price by Means of Tiresome Figuring

4 Point

22 A \$0 85 44 a \$1 15 \$2 00

AMBITIOUS PRINTERS SECURING NUMEROUS CUSTOMERS
When a Printer Installs a New Type Design Ambitious Aspirations to Bring His Customers With the Opportunity of Sharing his Enjoyment Accelerate His Own Thoughts and Movements Consequently He Gets a Move On Him and Business Comes Easier and More Profitably. Type is Certainly the Life-Blood of the Print Shop. Successful Printers Using

Century Expanded Italic in Practical Display



Century Hotel

The Health Nook

Situated in the finest and the most elevated section of Mountclair County, Unsurpassed cuisine, together with the luxurious library and smoking parlors, makes the reputation of this institution one of very high standing

Winter Service

Versatile Ornament

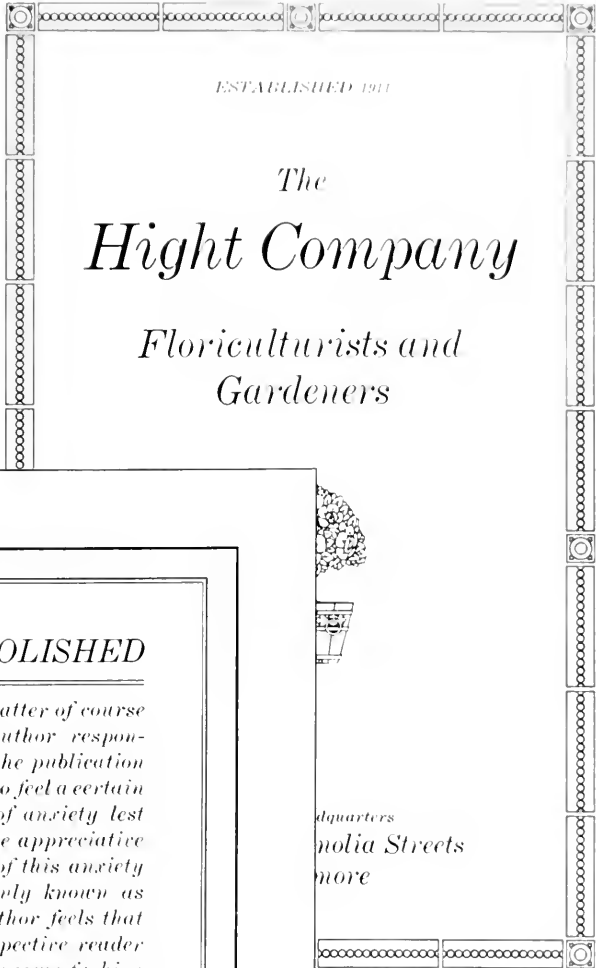

ESTABLISHED 1911

*The
Hight Company*

*Floriculturists and
Gardeners*

*quarters
nolia Streets
more*

Century Border Strathmore Ornament

PREFACE ABOLISHED



As it is a matter of course for the author responsible for the publication of a book to feel a certain amount of anxiety lest the reader should not be appreciative of its merits, and out of this anxiety comes what is commonly known as a "preface." The author feels that he must meet the prospective reader at the threshold, and in some fashion prepare him for the disappointment that is to follow. I omit from the present volume any form of preface, for two reasons—neither of which I feel called upon to give. To each reader I would say: "In thanking you for your flattering request I must here express my regret that I am unable to avail myself of your offer, as I shall be occupied for several months preparing manuscripts." H. J. Anonymous



Renaissance-Initial Versatile Ornament

*Century Expanded
Italic*

This is an American Line Type adaptable for printing booklets, announcements, cut-alongs, folders and other subject matter. Century. This face is even as readable and attractive to the eye, and possessing individuality which gives it distinction. It is set in really cut and accurately cast, and the broad letters are clean cut to an unusual extent for this

*A Type
Without Hairlines*

Century Bold

120 Point

3 A \$10 80 4 a \$7 70 \$18 50

BIG Hit

96 Point

3 A \$8 80 4 a \$6 20 \$15 00

EDITION

Gold Dust

84 Point

3 A \$7 00 4 a \$5 00 \$12 00

RECITING

Made King

72 Point

3 A \$6 65 4 a \$1 40 \$11 05

MINISTERS
Cleans Brush

60 Point

3 A \$5 00 4 a \$3 70 \$8 70

IRON GIRDER
Electric Launch

48 Point

4 A \$3 85 6 a \$3 65 \$7 50

DESIGNS RUINED
Executed Muscovite

42 Point

4 A \$3 15 7 a \$3 20 \$6 35

CITIZENS REFUSED
Projected Exploration
Englishmen Interested

36 Point

4 A \$2 55 7a \$2 50 \$5 05

NUMBER GOLD BONDS Forceful Method Admired

30 Point

5 A \$1 95 10a \$2 30 \$4 25

TREMENDOUS ENTERPRISE Discarding Religious Movement Histrionic Encyclopedia Printed

24 Point

6 A \$1 65 12a \$1 85 \$3 50

HUNTERS ENCOURAGED RETURN English Mariners Described Expedition Numerous Eastern Graduates Honored

18 Point

10 A \$1 65 18a \$1 65 \$3 30

PRISONERS RELIEVED Improves Turbine Engines Bridge Entirely Destroyed

10 Point

18 A \$1 15 36a \$1 35 \$2 50

COLOR PRINTER AND BINDER Progressive Students in Solar Prints Complete Harmonious Combination Arranging Remarkable Exhibitions

14 Point

13 A \$1 40 26a \$1 60 \$3 00

INGENIOUS MERCHANTMEN Criticise Elegant Social Function Interesting Experience Described

9 Point

20 A \$1 10 40a \$1 40 \$2 50

ANNUAL HORTICULTURAL SHOW Rare Plants and Bulbs Are Displayed Unlimited Varieties of Japanese Lilies Floral Exhibit Attracts Country Folks

12 Point

15 A \$1 20 32a \$1 60 \$2 80

STUDENTS DENOUNCE KINGDOM Executive Revives Seashore Festivities Foreign Honorary Members Introduced

8 Point

20 A \$1 00 40a \$1 25 \$2 25

NOTICE RECEIVED IN TYPE CONTEST Ambitious Technical Students Recognized Cash Bonus Given Meritorious Graduates Tuition Payable in Quarterly Installments

11 Point

18 A \$1 30 36a \$1 45 \$2 75

PROMOTED INSURANCE ENTERPRISE Diamond Miners Unearth Richest Treasure Hungarian Steamer Pleases English Tourist

6 Point

24 A \$0 95 48a \$1 05 \$2 00

EXAMPLES OF MODERN BRANDS INTERESTING Final Meeting of Commercial Travelers Secures Result Approved Manual of Process Engraving and Fine Arts Scientific Experiments by Learned College Professors Astronomical Calculations Based on Observations Made

CENTURY BOLD

The type for today and an
endless line of tomorrows

This type face possesses the prime requisites of fine color, legibility and distinctiveness. Easy to read, with no hair lines to break; just an honest bread-and-butter type face. Century Bold will look well wherever used



Preserve This Booklet

IT will be of service until a year from the present date, and will assist you in the buying and selling of the goods listed therein. We particularly call attention to section two, pages four, eight and nine, containing specific and important information in connection with samples. This new catalogue and price list replaces all issues previous to the date of receipt of this last volume, and you will find it of great convenience as a book of ready reference, and we are confident you will appreciate its advantages in your office

The United
Electric Supply Company

Grandville

THE BEAUTIES OF THE MOUNTAINS
AND THE DELIGHTS OF THE OCEAN

This splendid property is located near the heart of Grandville, the fastest growing and most popular suburb on the South Shore, with a large frontage on both sides of the famous New Land Speedway within close proximity to railroad and trolley and a short distance from Ralston ferry. This property is justly popular because of its very pleasant surroundings and great atmospheric advantages; flies and mosquitoes or the microbes they convey being entirely unknown in these exceptionally fine real estate holdings. All desirably restricted

LOTS
\$89
25 x 100

RICHARDS & HAMUN
Homestead and Grove Streets, Grand Shore

OUR NEW FLORAL BASKET



We have a Surprise Special for this week that will make happy flower-lovers everywhere. The Cedar Florist aims to create what Nature suggests. This week we are going to offer you a most original *Floral Basket*, a generous and gladsome breath of spring. The freshest and choicest flowers obtainable will be used. It costs just Five Dollars

THE CEDAR STREET FLORIST

CLEVELAND, OHIO

Floral Basket Piece

EVERY DAY IS SUNSHINE

*in Every Printing Office
Equipped with the
Century Bold
Series*

AMERICAN LINE TYPE
PLEASES THE PRINTER

Wayside Ornament



Book Repair

How about your Books? Have you examined your beloved volumes to see if any are losing their covers or falling apart from the sheer misuse and neglect they often suffer? We know you must have many books you prize highly. These cherished inmates of your library should be preserved as carefully as any old heirlooms. Let us mend your books

*Maten Bindery
Roxbury Hill*

Trade Cut

The Ships That Pass in the Night



Attract little attention. This cannot be said of the many stylish American Type Faces launched on the great sea of advertising. They at once become popular and indispensable



THE CAR THAT HAS MADE ITS NAME
STRICTLY UPON ITS PROVEN MERITS

Harim Car

THERE IS BUT ONE DECISIVE TEST OF MOTOR
CARS, THAT BEING THE RIGID TEST OF SERVICE

The Finest Car for Service



YOU are hereby invited to view this year's models of the new Harim Car and the several designs of coach, touring and roadster bodies now shown at our exhibition in the Arcade Garages, corner of Stevenson and Thielman streets. Those who are satisfied only with the highest type of automobile use the Harim exclusively. The newest model Harim Car is especially complete in its equipment and is as satisfactory a car as the market affords the automobile enthusiast. The body is made entirely of aluminum, thereby reducing its weight and making it lighter than all other cars of this size and horsepower. The great advantage of this feature in power, speed, hill-climbing and in economical handling is evident. The car has been especially noted for its very smart appearance. It originally commended itself to a great number of our clients through this beauty of design and its refinement of detail. The equipment includes such appurtenances as silk curtains, electric dome lights, speaking tubes, cigar and ash tray, vanity case. The car for every occasion

SHIPMENTS OF THIS CAR CAN BE MADE WITHIN ELEVEN
DAYS FROM DATE OF RECEIPT OF ORDER AT OUR OFFICE



KENDER CAR COMPANY
Madison Street, Detroit

72 Point

3 A \$7 00 4 a \$4 15 \$11 15

ENTERING
Royal Kings

60 Point

3 A \$5 65 4 a \$3 65 \$9 30

BURNISHING
Neater Garden

48 Point

4 A \$3 90 6 a \$3 75 \$7 65

BRIGHT MINERS
Handsome Scholar

42 Point

4 A \$3 35 6 a \$3 05 \$6 40

DESIGNS REFUSED
Magnificent Numbers
European Conception

36 Point

1 A \$2 45 7 a \$2 55 \$5 00

BROKERS RETURNED
*Many Dishonest Schemes
Largest Investors Decline*

30 Point

5 A \$2 10 9 a \$2 15 \$4 25

ENTERPRISING STUDENTS
*Magnificent Oration Delivered
Congratulating Smart Maiden*

24 Point

6 A \$1 75 10 a \$1 75 \$3 50

STRENUOUS HUNTERS DESIRED
*Charming Mountain Scenes Revealed
Enthusiastic Sportsmen Ramble East*

18 Point

9 A \$1 50 17 a \$1 75 \$3 25

CHOICEST ROSEBUSH
*Splendid Flower Gardens
Beautiful Ever Blooming*

10 Point

17 A \$1 20 32 a \$1 30 \$2 50

QUAINT FOREIGN KINGDOMS
*Meritorious Governments Honored
Excited Population Gesticulating
Remarkable Measures Announced*

14 Point

14 A \$1 40 27 a \$1 65 \$3 05

SUSPENDED MEMBERSHIP
*Involved Considerable Expense
Dangerous Forebodings Ahead*

9 Point

18 A \$1 15 36 a \$1 35 \$2 50

GYMNASIUM AND FIELD SPORTS
*Physical Culture Exercise Demanded
Extraordinary Muscular Development
Acrobatic Feature Becoming Popular*

12 Point

14 A \$1 20 30 a \$1 60 \$2 80

BURLESQUE DANCERS REMAIN
*Industrious Performer Remunerated
Bold and Clear \$1234567890 Figures*

8 Point

18 A \$1 05 36 a \$1 20 \$2 25

FINANCIAL RESOURCES PROCURED
*Brighter Industrial Conditions Reported
Ingenuous Managers Collecting Securities
Resourceful Diplomats Rewarding Agent*

11 Point

17 A \$1 30 32 a \$1 45 \$2 75

HISTORIC MANSIONS DEMOLISHED
*Ancient Building Permanently Removed
Influential Contractors Receiving Notice*

6 Point

22 A \$0 90 44 a \$1 10 \$2 00

THE CLIFTONVILLE PLEASURE ORGANIZATION
*Mutual Admiration Seances Proving Very Successful
Professional Flatterers Secured at Tremendous Cost
Viracious Dames \$1234567890 and Beardless Youths*

Fireproof Deposit Vaults

***Second
National
Bank***

Of North Brockton, Missouri
FRANK JONES, President

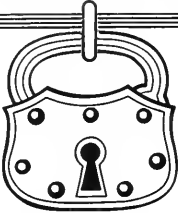

*Some Interesting Hints for Those Who
Are Desirous of Protecting
Their Valuables*

Versatile Ornament Cast Squares



*The Eureka
Cafe*

Menu

SOUPS

Consomme Mock Turtle
Tomato with Rice

FISH

Broiled Halibut Steak
Sea Bass Blue Fish

ROASTS

Spring Duckling Spring Lamb
Young Turkey

SALADS

Watercress Romaine
Chicken Lobster

VEGETABLES

Mashed Potatoes Stuffed Onions
Green Corn Lettuce

DESSERT

Fancy Cakes Ice Cream
Wine Jelly Eclairs

Versatile Ornaments

?

KINDLY look over the enclosed account and if found to be correct oblige us with a prompt remittance. We are closing our books for the year, and require money to meet our own bills, which are very large and pressing. This account may seem small to you, but we have several hundred of them out and the total is a large sum to us. Hoping that this communication will receive your immediate consideration, we beg to remain

THE MODEL PRINTING COMPANY

?

Publicity

BRINGS THE BUYER IN TOUCH WITH THE MAKER

*We Can Assist You to
Introduce Your Goods*



VERY year you send out a dark blue catalogue which reposes on the shelf or in the book-case of your prospective customer along with four dark blue catalogues, six light brown ones three bright red ones and many others of various hues. What chance has your catalogue to sell goods? And now and then you get out a piece of advertising matter with nothing particularly distinctive or forcible about it. Advertising of that character is simply a waste of money. What you need is a series of bright, strong, snappy matter to go through the mails at regular intervals, thus keeping the merit of your goods up in front of the buyer's eye, and absolutely forcing him to order from your catalogue instead of the other one. We can do this in a manner that will produce results

BRIGHT & DEMURE

Publicity Makers

*197 Pine Street
CAMDEN, MO.*

72 Point

3 A \$1 80 4 a \$3 45 \$8 25

BURNISHED IRON
Surprised Animals

60 Point

3 A \$3 80 5 a \$3 25 \$7 05

MODERN DESIGNERS
Entertained President

48 Point

5 A \$3 30 8 a \$3 20 \$6 50

PERFORMERS RETURNING
Modest Reporter Promoted

42 Point

5 A \$2 65 8 a \$2 60 \$5 25

BEAUTIFUL SOUVENIRS GIVEN
Curious Scenes Nicely Described
Enthusiastic Pedestrian Chosen

Century Bold Condensed

36 Point

5 A \$1 95 10 a \$2 30 \$4 25

HISTORICAL LECTURES RENDERED
Inspiring Orations Delight Thousands
Magnificently Gowned Females Speak

30 Point

7 A \$1 80 14 a \$2 20 \$4 00

HUMOROUS COMEDIANS PLEASE CHILDREN
European Acrobats Displaying Great Energy
Unprejudiced Managers Securing Experience

24 Point

9 A \$1 60 18 a \$1 95 \$3 55

ENTERPRISING ADVERTISEMENT WRITERS CONFER
Numerous Schemes Outlined and Seriously Considered
Discriminating Members Attending Elaborate Seances

18 Point

14 A \$1 45 28 a \$1 80 \$3 25

BEAUTIFUL ADVERTISING LETTER
Exquisite Designs Forwarded Today
Type Artists Praise this Useful Face

10 Point

25 A \$1 15 50 a \$1 35 \$2 50

MANY STARTLING DISCLOSURES EXPECTED
Swiftest Compositor Bought New Roller Skates
Noticed Liberal Graduation of Sizes Contained
Appreciative Craftsmen Purchased this Series
Renowned Achievements Gained from Working

14 Point

19 A \$1 35 39 a \$1 65 \$3 00

BUYS CENTURY BOLD CONDENSED SERIES
Presenting One Dozen Marvelous Specimens
Made by American Type Founders Company

8 Point

31 A \$1 00 63 a \$1 25 \$2 25

STRONG TYPOGRAPHICAL DESIGNS INTRODUCED HERE
Reports Large Yield of Grape Fruit from North of Ireland
German Singing Society Entertains Large Audience Today
Money Spent on Century Bold Condensed Brought Returns
American Manufacturers Claiming Heavy Increases Lately

12 Point

23 A \$1 20 47 a \$1 55 \$2 75

MILLIONAIRE INSURES HIS FINEST HOME HEAVILY
Strong Display Always Obtained Without any Crudity
This Large Company Leads the World in Production
Modern Serviceable \$1234567890 Figures Furnished

6 Point

30 A \$0 90 60 a \$1 10 \$2 00

DETECTIVES PROMPTLY RETURNED DIAMOND WATCH CHARMS
American Type Leads the World in Distinctiveness and Originality
Curious Audience Failed to Recognize the Famous Political Speaker
Thirty Thousand People Enjoying Themselves at Rockaway Beach
Delightful Series of Musical Concerts Given by Famous Italian Band
Thirsty Sailors Drank Salt Water After Enduring Many Hardships
Showing Ten Distinct \$1234567890 Figures in One Very Short Line

FINAL WEEK OF THE MARCH

Furniture Sales

The reductions we have named for this series, which begins on

Monday at ten o'clock and will be continued every other day during the week, are the greatest we have offered during these popular sales

SOME HANDSOMELY UPHOLSTERED

Parlor Chairs, \$2

THESE FORMERLY SOLD AT \$4.50

PARLOR SUITS. Five pieces; each suit consists of sofa, two large armchairs and two small armchairs; mahogany finished frames; tufted backs and plain seats, covered with green silk crushed plush; regular price \$56; sale price, **\$45.50**

A SPECIAL LINE OF HIGH-GRADE

Carpets and Rugs

AT PRICES THAT DEFY COMPETITION

DAVENPORT SOFA BEDS. Frames made of solid, plain oak, golden color and gloss finish; splendidly upholstered and covered with a fine quality of green velour; regular price \$25; sale price, **\$13.95**

BRANK & HARLEN FURNITURE CO.

TELEPHONE NUMBER 907 FURNITURE

4 Rosen Street, CHICAGO



ESTABLISHED 1892

PHONE 216 BELL

HARTMAN'S LIVERY STABLE

Vehicles of all kinds here at your disposal. Open day and night. Telephone calls given immediate attention

29 East Market Street

OPPOSITE GRAND OPERA HOUSE

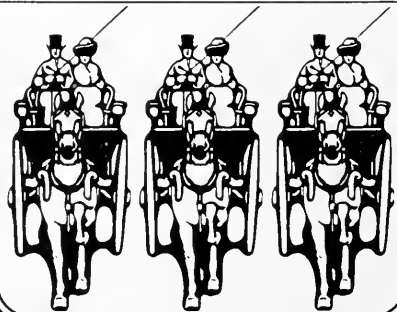

Versatile Ornaments

Weight Fonts

This striking series, like all other popular American faces, is sold in weight fonts at Body Type prices and regular discounts. As an advertising letter and for general display it will immediately commend itself to the particular trade

Century Bold Condensed in Practical Display

The Prize Model

A NEW STYLE AUTOMOBILE ESPECIALLY CONSTRUCTED FOR SPEED AND COMFORT

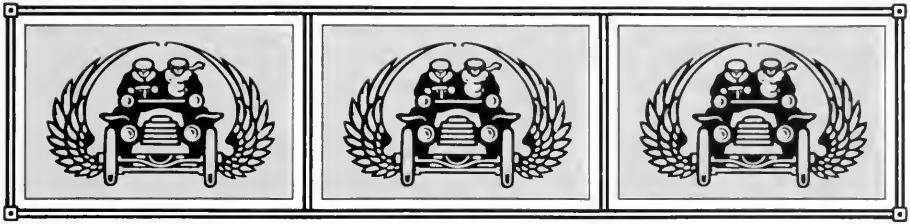

OVER THREE HUNDRED CARS
SOLD DURING THE
MONTH OF FEBRUARY

PRICE COMPLETE
\$2400

EQUIPPED WITH OUR
POPULAR PUNCTURE PROOF
STEEL-RIBBED TIRES

IN presenting the Prize Model machine for the approval of the public we feel confident that our efforts to produce a high-grade car at a small cost have been extremely successful, and to the man who is looking for something real classy in the automobile line we unhesitatingly recommend the Prize Model. This machine is equipped with all the latest and best improvements, and for real solid comfort cannot be excelled. That a machine of this character could be built and placed on the market at such a low price seemed very doubtful, but after experimenting for some time along new lines we finally succeeded in accomplishing our purpose. A visit to our showrooms is very earnestly solicited

Mirst Automobile Company

MANUFACTURERS OF STRICTLY HIGH-GRADE MOTOR CARS. AMERICAN AGENT FOR THE BEAUMONT MACHINES

Numbers 162-168 North Morningside Street KANSAS CITY, MISSOURI

Century Bold Extended

72 Point

3 A \$8 85 4 a \$5 90 \$14 75

REMARK
Fine Light

60 Point

3 A \$7 25 4 a \$4 30 \$11 55

ENDURING
Large Fields

48 Point

3 A \$4 70 4 a \$2 90 \$7 60

BANDS UNITE
Senators Gifted

42 Point

4 A \$3 75 5 a \$2 60 \$6 35

HEROES FOUND
Municipal Guards
Ladies Prominent

Century Bold Extended

36 Point

1A \$2.85 6a \$2.10 \$5.25

**MOTHER EXCUSED
Restores Old Plunder
Stupid Teacher Fined**

30 Point

4A \$2.10 8a \$2.15 \$4.25

**LUMBER KING ELOPES
Printers Lecturing Tinker
Daring Jumpers Consoled**

24 Point

5A \$1.65 10a \$1.85 \$3.50

**ENJOYED READING NOVELS
Hotel Guests Scared Proprietor
Beautiful Actress Bought Show**

18 Point

8A \$1.65 14a \$1.65 \$3.30

**FIND QUIET HOME
Obliging Clairvoyant
Thousands Rejoicing**

10 Point

14A \$1.15 29a \$1.35 \$2.50

**GAYEST RIALTO NIGHTS
Actor Folks Throng Streets
Broadway Hotels Profiting
Many Amusing Stories Told
Delights Theatre Managers**

14 Point

11A \$1.45 21a \$1.55 \$3.00

**JUDGMENT RENDERED
Confront Latest Problems
Exonerated Shrewd Jailer**

8 Point

17A \$1.05 31a \$1.20 \$2.25

**CONTAINING MODERN DESIGNS
Handsome Specimens Reproduced
Makes Original American Creation
Desperate Burglar Captured Today
Series Suited Greatest Advertisers**

12 Point

13A \$1.30 25a \$1.45 \$2.75

**USEFUL EXTENDED DESIGN
Handy Character Where Finest
Grade of Printing is Demanded
Inspects \$1234567890 Closely**

6 Point

20A \$0.95 38a \$1.05 \$2.00

**EXTRACTS FROM SHERLOCK HOLMES
Bold German Soldiers Tracked Porcupine
Society Couples Entertain Cannibal King
Wonderful Exhibition of Latest Paintings
Musical Duets Rehearsing Laughable Act
Temperance Advocate Warns Youngsters
Hero Welcomed \$1234567890 in Vermont**



Tours

TO EUROPE

These tours have been planned with the idea of giving the summer tourist a chance to visit almost every city of note in Europe, while, in addition, the itinerary also comprises a cruise on the Mediterranean, stopping at such places as Gibraltar, Malta and many prominent watering resorts along the coast. The commodious liners of the

Clark Steamship Company

are equipped with all the latest requisites for safety and comfort known to modern marine enterprise. Nothing is left undone to make these tours both enjoyable and instructive. Unusually low rates are in effect for these tours during the Summer. Arrangements for passage should be made at once to insure the most desirable quarters

FULL INFORMATION REGARDING RATES,
SCHEDULES AND MAPS, CAN BE HAD
BY WRITING OR APPLYING TO

H. L. SMITH, General Agent

STEAMSHIP BUILDING, NEW YORK



SHERM & BURKE

INTERIOR WORK

EXTERIOR WORK

Decorators

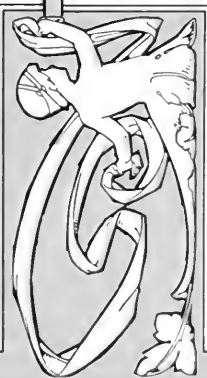

STYLE BOOK

CONTAINING DESCRIPTIVE INFORMATION
AND COMPLETE LIST OF PRICES

Ornamentation of Plaster, Cement and Metal
Modeling and Wood Carving



MAIN OFFICE CORNER SYDNEY AND NORTH EIGHTH STREETS, CHICAGO
GALVESTON RICHMOND PORTLAND NEW YORK DETROIT SPOKANE SAN FRANCISCO

72 Point

3 A \$7 00 4 a \$4 15 \$11 15

NICE HERD
Mocking Bird
Royal Singers

60 Point

3 A \$5 45 5 a \$3 80 \$9 25

MINERS RING
Sublime Episode
Chairs Damaged

48 Point

4 A \$4 15 7 a \$3 55 \$7 70

GRAND KNIGHTS
Enchanting Mansion
Literary Department

42 Point

5 A \$3.60 8 B \$2.95 \$6.55

BRIGHT REMINDER
Enterprising Merchants
Statesmen Contributing

36 Point

5 A \$2.85 8 A \$2.40 \$5.25

CHARMING DREAMERS
Exquisite Souvenirs Bought
Remarkable Ornamentation

30 Point

6 A \$2.25 10 A \$2.05 \$4.30

PRINTING CLEVER DESIGNS
Have Interested Customer Remain
Distinctive Arrangement Obtained
Secures Numerous Useful Benefits

24 Point

7 A \$1.85 12 A \$1.65 \$3.50

MERITORIOUS REPORT GRANTED
Extraordinary Measures Receive Censure
Delighted Senators Securing Recognition
Harmonious Organizations Congratulated

18 Point

10 A \$1 60 20 a \$1 65 \$3 25

BRIGHT TYPE DESIGNS FOR THE PRINTER PRODUCED ARTISTIC ADVERTISING PAGES

American line type is noted for original and effective characteristics by the leading printers and advertisers of this country and abroad. Every printer who knows the value of artistic advertising typography will surely appreciate the splendid type faces recently brought out

14 Point

14 A \$1 45 28 a \$1 55 \$3 00

SOME PLEASING DESIGNS IN BORDERS AND ORNAMENTS

In addition to the large and varied assortment of type designs made by this Company the printer can also be supplied with the most artistic line of modern decorative material

12 Point

17 A \$1 35 35 a \$1 40 \$2 75

POPULAR AMERICAN LINE TYPES ARE PROFITABLE AND PLEASING

The most important factor in building up a successful printing business is the type. It is the lever which stimulates or retards the growth of an establishment. In many plants the types are put on the same par as the collective art knowledge, experience and brains of the \$1234567890 organization

10 Point

19 A \$1 20 38 a \$1 30 \$2 50

OBSERVING PRINTERS CONTINUE THE DEMAND FOR DISTINCTIVE FASHIONS

The type founder who produces a distinct and pleasing type face not only stimulates the type business but vastly stimulates the demand for printing. Such an addition to a printing plant is equal, at least, to the accession to the staff of a successful designer, and each new type face gives impetus to the printing business just as each brainy addition to the printer's staff does

8 Point

24 A \$1 10 47 a \$1 15 \$2 25

VITALIZE YOUR BUSINESS BY KEEPING YOUR TYPE STYLES ALIVE AND ACTIVE

New and original type faces stimulate orders for the printer. When the printer puts in a new face he knows he has something good to offer his customers, and this thought puts snap and ginger into his own thoughts and actions. In short, he gets a hustle on him, and business comes easier and more profitable. Type is the life-blood of the printing office, and the wise printer of today does not allow his type styles

6 Point

25 A \$0 95 50 a \$1 05 \$2 00

STRIKING EFFECTS SECURED WITH MODERN TYPE DESIGNS AND DECORATIVE MATERIAL

In most cases type should be purchased in families, in complete series and in large fonts. A great variety of unrelated types in small fonts is expensive to buy and expensive to use. Printers will get better and quicker results with large fonts of a few well-selected series of related styles than with a miscellaneous assortment of faces never intended to be used together, and with which good results are obtainable only by exercising a great amount of time-absorbing care. Simplify your type selection. Fewer faces and bigger fonts is the economic policy. Old material should be discarded without qualms whether it be cases, racks, type or what not, since it costs more to keep such material \$1234567890 than to discard it

5 Point

24 A \$0 95 48 a \$1 05 \$2 00

THE TYPES THAT MAKE PRINTING POPULAR, BEING A SIMPLE STATEMENT OF FACTS KNOWN TO PRINTERS

The great type designs originated by this Company have captured the advertising genius of the country. The many new type faces recently brought out in related families have an immense potency in advertising. It has become worth while, necessary, in fact, for the advertisers to study type-design, and that study has cultivated a demand for printing millions of dollars' worth more than could have been the case if the American Type Founders Company had not reformed typographic design. Its influence has been apparent abroad as well as in our own country, and now America, through its greatest type foundry, is acknowledged leader of type-fashions. The typefounder who perfects a successful type-face not only aids his own business, but helps the business of printers who use that face. If we examine the pages of our great magazines or the fine catalogues of the present period, we will observe them all using the type families mentioned above. The printer is wise that uses them

The Swift



The velocity of this machine surpasses that of all other cars

THE SPEED CONTEST AT ROCHE
HOW THE SWIFT EASILY WON TH

Versatile Ornament

THE purchase of appropriate ornaments is another great factor in the best printing offices. To have an assortment constantly on hand and plenty for every emergency is really an economic proposition. It goes without saying that a graceful and properly selected ornament applied to a job of printing will

HART SHINE IS THE BEST SILVER CLEANER

Royal Silver of Louis XIV



JAMES B. HART COMPANY
SILVERSMITHS

Louis Fourteenth surrounded himself with masters of every art and craft. He stimulated them to do their best by very lavish payments of money. Under such a royal master these men made his reign famous for its splendor. It was an age of magnificence. Today we show that seventeenth century magnificence interpreted in sterling silverware in the style of Louis XIV. The effect is exceedingly impressive with a massiveness and grandeur seldom seen. In an examination of our silverware there will be found designs adapted to different periods

Department Store Initial Versatile Ornament Cast Squares

THANK YOU

We appreciate this order, which it is hoped has been filled to your liking and will lead to future business relationship between us

HIGH-GRADE
ADVERTISING
TYPOGRAPHY

MINORT PRESS
Caxton Building, Boston

GLEN OUTING CLUB



The original conception of the Glen Outing Club was nature's own. Its organization was due to the happy combination of natural advantages grouped about this region, where mountainous heights and pleasant valleys, rocky crags and rippling water-courses, and the peace and ozone invite lovers of nature

COLONEL MARTIN LAMBERQUINS, KEEPER

Versatile Ornament

INTERESTING HINTS IN REGARD TO THE ROLL-FRONT

Case Rack

MANY printers have often desired to abandon the regular case racks and substitute a cabinet, thus increasing the life of the type by having it free from dust

The new Roll-Front Case Racks solve the problem, as they are equal to cabinets in every way. They are made of ash, finished in bright antique oak

The Roll-Front Case Racks are fitted with steel runs and are thoroughly manufactured in every way. Have a fine brass desk lock in center and a single key secures the entire tier of cases. For further information write to nearest House of the American Type Founders Co., Selling Agent

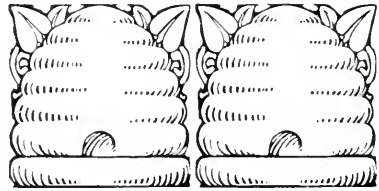

Century Border Strathmore Ornament

Time wasted in hunting sorts constitutes one of the greatest losses encountered in a composing room. The way to obviate such a condition is to buy Job Type in Weight Fonts at Body Type prices and fair discounts.



American
Type Founders Co.

Clearface

A new and very beautiful book and job letter with distinctive characteristics, making it very desirable where a stylish and easily read type is required. Unsurpassed for all-round work.

FOURTEEN EVENLY GRADUATED SIZES, RANGING FROM FIVE POINT TO SEVENTY-TWO POINT, FORMING A USEFUL SERIES

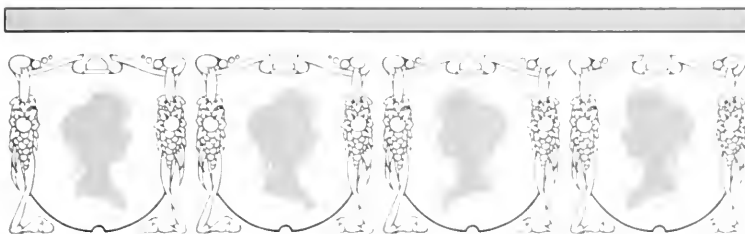

THE COLONIZING OF PLYMOUTH ROCK

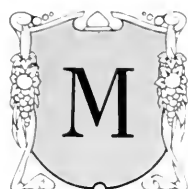

OST noteworthy of all was the colony planted at Plymouth, Massachusetts, on December 20. This was established by Englishmen belonging to the Congregational Church. They had been persecuted in England because of their dissent from the established church, and first sought a place of refuge in Holland. Shortly after they came to America to organize a colony where they might have freedom to worship God according to the dictates of their own consciences. They sailed from Plymouth, in England, on September 16, 1620, in the ship *Mayflower*, and reached the American coast on December 20; for several months they had great hardships to endure, and many of them died. The survivors persevered and made a permanent settlement which finally became the most important of all the English colonies in America. At first they got along in friendly fashion with the Indians, especially with the great *Samoset* and *Massasoit*. But the son of the latter, *King Philip*, was their deadly foe. A bitter war was waged with him which ended with his death and the dispersion of his tribe. Colonies were planted by the Swedes in Delaware, but these, together with the Dutch colonies, presently went into the hands of the English as spoils of war, and all the North Atlantic Coast as far south as Florida, which Spain held, became English territory. As already stated, Virginia was settled at *Jamestown* in 1607, and it may be added that negro slavery was introduced into the North American colonies there in 1620. New York was settled by the Dutch at New York—then called *New Amsterdam*—and *Albany*, in 1614. It was taken by the English who changed its name to the present form in 1664. Massachusetts was settled at Plymouth in 1620 by English Puritans. New Hampshire was settled by the English in 1628. New Jersey was settled by the

72 Point

3 A \$6 60 4 a \$4 25 \$10 85

TRENCHES
Clearest Italic

60 Point

3 A \$5 90 4 a \$3 75 \$9 65

FINE DRINKS
Requires Printer

48 Point

4 A \$3 90 7 a \$3 65 \$7 55

SENDING MINER
Drawing Handsome

42 Point

4 A \$3 15 7 a \$3 10 \$6 25

MODEST NUMBERS
Copied Novel Designer
Note Renowned Series

Clearface Italic

36 Point

5 A \$2 80 8 n \$2 40 \$5 20

*KINGS HUNTED BIRDS
Introduce Graceful Dancing*

30 Point

6 A \$2 15 10 a \$2 10 \$4 25

*HINDER ARTISTIC PRINTER
Ignorance of Newest Type Design*

24 Point

7 A \$1 75 12 a \$1 75 \$3 50

*EXPRESS DELIGHTFUL THOUGHT
Thinking Printers Everywhere Interested*

18 Point

10 A \$1 60 19 a \$1 65 \$3 25

*STRANGEST EVENTS PROMISED TONIGHT
Secure Reliable Type Faces and Observe the Result
Beautiful Clearface Italic for the Modern Print Shop*

14 Point

15 A \$1 45 29 a \$1 55 \$3 00

*USED PROFITABLE SCIENCE
Publish Interesting Stories Today
Artistic Specimens Repay Printers*

8 Point

22 A \$1 10 43 a \$1 15 \$2 25

*USING STYLISH PRINTING MATERIAL
Best Specimens Produced with Utmost Care
Printers Conditions Improved Beyond Doubt
Founded Up-to-Date Printing Establishments
Our Instinct Points Toward Clearface Italic*

12 Point

17 A \$1 35 34 a \$1 40 \$2 75

*SHOWING COMPLETED RETURNS
Many Studious Printers Qualify Rapidly
Clearface Italic Will Satisfy the Customer
Produce Brilliant \$1234567890 Feature*

6 Point

24 A \$0 95 48 a \$1 05 \$2 00

*WONDERFUL DEMONSTRATIONS EFFECTED
America's Great Manufacturers Advertise Heavy Gain
Largest Corn Crop Ever Produced in Western Kansas
Sunburned Compositors Delighted Large Audiences
Money Used Purchasing Clearface Italic is Well Spent
A Rolling Stone Gathers No Moss. Do You Want Any
Best Results in \$1234567890 Printing Business Made*

10 Point

19 A \$1 25 36 a \$1 25 \$2 50

*EARTHQUAKE SHAKES LIGHTHOUSE
Note Remarkable Escape in Daily Newspaper
Ambulances Dashing Around Corner Rapidly
Thousands Scared When Aeroplane Dropped
Wonderful Demand for American Ornaments*

5 Point

22 A \$1 00 41 a \$1 00 \$2 00

*CONSIDERS CAREFUL TYPE SELECTION BENEFICIAL
Enormous Change Observed Throughout Entire Civilized World
Italian Sculptor Carved Beautiful Granite Statues in Germany
Harefooted Boy Trudged Along with Long Fishing Pole Today
Sunburned Compositors Refused to Indulge in Baseball Games
Exercises of Strenuous Nature Partaken in by Hardened Visitor
Watermelon Vines Climbed Over Garden Wall During Summer
Lady Purchased Handsome Parasols While Staying in Harlem*

Bander Print Shop

CORNER HENDERSON
AND NINTH STREETS
MADISONIAN

Designing :: Etching :: Embossing :: Printing

Hern & Rand

GREATEST FICTION DEALERS IN THE SOUTHERN STATES

The Heritage of the Wilderness

By William Taylor Bly "An appealing love story, chaste as *Author of Mountaineer* the far water brooks," says a critic of this new novel, "in which the curtain is raised on a scene hitherto unexplored by American writers." The *Tribune* adds this comment: "It is a strong story, rich with life and mixed with color. You will like it much"

Pearl *By the Renowned Hattie Courtwright* *Mark* *By Heusinger Doer A Popular Author*

A love story of real life, true and sympathetic as *Miss Courtwright's* early stories of New England life always were. A picture of every day human nature without gleam of pretense, varied by the complex incidents and suspended interest of diversified romance, and full of humor. It is the kind of story to bring laughter and tears aplenty

The hero is also the villain in this wonderful romance. The startling novelty of the plot and the charm of the love story have called forth a chorus of praise, swelling across the country and echoing beyond the ocean into the English press. Quite without exception they say this story is better than "Amber Grove," and still more interesting

The Court of His Royal Majesty

By Nathan Bauman This brilliant historical novel, woven *The Great Historian* about the infamous yet interesting Borge family, which completes Mr. Bauman's Italian trilogy, in which "Casdel de Nuvio" and "The Rascal of Rome" have already been published, is unequalled by modern writers of fiction. Illustrations by Norman

HENDER AND KEMINTON STREETS, MOBILE

WINTER NEWSPAPER SYNDICATE



*Remarks made
By a General
Advertising
Solicitor*

*This Syndicate
Bought The
Ottumwa
Review*

*Buys Another
Newspaper to
Keep things
Humming*

WHY it happened I cannot explain, but wherever I found a daily newspaper published by the well-known Winter Syndicate there was something that made me recognize it as being a newspaper of higher grade than any other that was published in the same town. This was an off-hand remark made by an experienced advertising man who had been making a visit to the cities in Iowa, and it suggested the popular interest which might be felt in this story of the Winter Syndicate and the quality which entitles it to claim "If it is a Winter Syndicate paper it is the best paper." The beginning of this powerful Winter Syndicate took place some time ago when Mr. W. Winter purchased *The Review* at Ottumwa, Iowa. *The Review* at that time was a daily and had a circulation of five hundred copies. By strenuous work and in the face of capable and active competition, Mr. Winter brought it up to a bona fide circulation of twelve thousand daily and weekly. Mr. A. Winter then went to Lafayette, Iowa, and purchased *The Sun*, of that town, and *The Observer*, of Mineola, Iowa, a few years later, a newspaper owned and edited by his brother-in-law, and on which Mr. A. Winter received his training. Early in the present year two other properties were added to

72 Point

3 A \$6 80 4 a \$4 45 \$11 25

FRIGHTENS
Staunch Limb
Display Finest

60 Point

3 A \$5 25 5 a \$4 05 \$9 30

KIND BROKER
Returned Names
Distrusts Burglar

48 Point

4 A \$3 85 7 a \$3 70 \$7 55

NOBLE DESIGNER
Marvelous Historians
Romans Entertaining

42 Point

5 A \$3 45 8 a \$3 10 \$6 55

BEING DETERMINED
Remarkable Elimination
Hebrew National Society

36 Point

6 A \$2 70 8 a \$2 35 \$5 05

INTERESTING PRINTERS
Handsome Mansions Rebuilt
Construct Greatest Buildings

30 Point

6 A \$2 20 10 a \$2 05 \$4 25

SECURED HONEST MEMBERS
Unprecedented Multitudes Remain
Metropolitan Avenues Being Clean
Government Employing Detectives

24 Point

7 A \$1 80 12 a \$1 70 \$3 50

EXERTS THEIR OBSCURED MUSCLE
Gymnastic Event Unexpectedly Continued
Secure Inspired Exhilarating Performance
Big Contractor Erected Beautiful Libraries

Clearface Bold

18 Point

10 A \$1 60 20 a \$1 65 \$3 25

CLEARFACE BOLD BECOMES MORE POPULAR EACH DAY TO USERS OF DISTINCT PRINTING
This beautiful type design commands the attention of the reader's eye wherever displayed. As is signified by the name it possesses the exquisite feature of clearness together with the desirable character of boldness. The combination makes it a series which advertisers desire

14 Point

14 A \$1 40 29 a \$1 60 \$3 00

HANDSOME AMERICAN FACES PURCHASED BY BEST PLANT
Harmony and symmetry are the two principles that govern a standard of typography. The blending of types, borders and ornaments in one group always produces an agreeable effect

12 Point

16 A \$1 30 35 a \$1 45 \$2 75

MODERN SPECIMENS PLEASE MANY OLDER TYPOGRAPHICAL STUDENTS
Strange to say there are no rules by which good taste in typography may be governed even today. Every printer has his own style and exercises his own sweet will. Often he adopts the suggestion of a customer which may be entirely out of harmony. A printer should study \$1234567890 the specimens

10 Point

19 A \$1 20 38 a \$1 30 \$2 50

ATTRACTIVE STYLE DELIGHTED EVERY PURCHASER DESIRING THE BEST WORK
Look over your stock of type, and whenever you find any with the undisturbed dust of weeks on it you may as well throw it out since it does not pay dividends. Attractive type styles that please your patrons and increase your trade are goods that pay the dividend on the investment. When in the market for material remember American Type Founders Company quality is the very best

8 Point

22 A \$1 05 46 a \$1 20 \$2 25

PRACTICAL SELECTIONS BECOME EASY BEAUTIFUL DESIGNS CAREFULLY MADE
Clearface Bold has been in conspicuous service in nearly every modern printing office; today it is one of the most popular faces on the market. Its great legibility together with its refined and graceful shape makes it preferable to faces less easily read. Clearface Bold is a standard for a fashion in type, and all printers who use it will unhesitatingly testify to its serviceableness as a display letter for any general printing purpose

6 Point

25 A \$0 95 50 a \$1 05 \$2 00

PRINTING MATERIAL PROCURED FOR WORKERS IN LARGEST FONTS AT OUR BODY TYPE PRICES
During the past year many changes have been observed in the advertising field. There is a tendency toward more conservative tones in the advertising literature of largest commercial institutions. The changes have been brought around largely by a fuller appreciation of the importance of the advertising department. Managers of great houses where business on a large scale is conducted are realizing that the printed column, or page, or booklet has a large influence in determining the future of the establishment using it. And as a natural outgrowth, greatest care must be taken in the selection of men entrusted with preparing the literature intended to bring to the house it represents not only profit, but a \$1234567890 good name that will

5 Point

23 A \$0 95 47 a \$1 05 \$2 00

FREQUENT CHANGES NOTED IN ADVERTISING METHODS WHICH BENEFITED BOTH ADVERTISER AND PUBLISHER
The success or failure of printing is steadily becoming more and more dependent upon the design as used in a broad sense. Design includes the primary outline or main purpose and all elements by which printing is made efficient. It therefore contains the insight into general business conditions and specifically into the business which is to be directly served. Design is the arrangement. It is the reasonable and practical adjustment of all the mechanical and the esthetic qualities that produce the greatest results in competition with all of the rest of the world's products. It is one man or one establishment against all the rest. Design in printing is the element which combines imagination, taste and skill to produce a desired as well as definite result. The printing industry may be termed the barometer of most commercial prosperity. It differs from all other industries in that it deals in every calling and is closely identified with the prosperity of each. One must advertise to become known

Clearface Bold in Practical Display

Meint & Son

SIXTH AVENUE AND EIGHTH STREET

ENTERING upon our thirty-sixth year of continuous business in the Carriage and Harness trade, we seize this opportunity to thank our great army of customers for their patronage in the past and hope for a continuance of it in the future. As we look back through the vista of former years and note the many obstacles which have been so successfully encountered, it is with a feeling of supreme contentment that we look forward to the shadowy future waiting to grasp the triumphs which are yet to come. Realizing that Character, combined with Honesty, is the only foundation on which to build a business edifice, we have always in the past, and will in the future, endeavor to keep that ideal ever in view. Having been continually surrounded by the most original designers and also the most skillful workmen that this country could produce, our efforts to meet the ever changing demand for vehicles of every description have invariably been successful. Our facilities for handling work of this nature are second to none, and it is with a feeling of pride that we invite our patrons and the general public to pay us a visit and satisfy themselves that our assertions are well founded. When we saw it was impossible to turn out work quickly enough in our old quarters we immediately located in the modern and up-to-date

ON TUESDAY, NOVEMBER SEVEN, WE INTEND TO PLACE ON EXHIBITION A COMPLETE LINE OF NEWLY MODELED CARRIAGES, BAROUCHES, PHAETONS AND OTHER VEHICLES WHICH HAVE BEEN ACKNOWLEDGED BY EXPERTS AS THE BEST OF THEIR KIND EVER OFFERED TO THE BUYING PUBLIC

new building at the above address. Occupying fully four blocks of floor space we are now in a position to cater to the demands of the public in a business-like manner. For the benefit of our numerous customers who reside out of town and find it

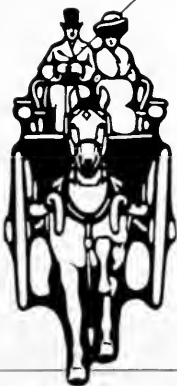

Versatile Ornament

HENRY MERIDETH MANUFACTURING CO.

WHOLESALE **SHOES** AND RETAIL

FOR MEN, WOMEN AND
CHILDREN

728 MONTROSE STREET, ARLINGTON

Clearface Bold in Practical Display

SOME GOOD HINTS ABOUT

Glendalen On-the-Chesterville THE HEALTH RESORT

Some people have ofttimes wondered at the custom of their friends in going, year after year, to the same old resort. But where this fine resort happens to be in the highlands of Glendalen, the wonder promptly begins to cease, and these very same people, after they have had a trial trip, become just as devoted to the charm of the region. Glendalen is by far the most popular resort in this section of the country because of its high altitude and its surrounding groves of pine trees and the great ocean bordering directly on the south. Health and rest are positively assured here

For all special information apply to

BIRTH & HOLMES
Managing Agents for Glendalen
AT THE GLENDALEN RAILROAD

Cast Squares Holiday Decorators

The Harry Gurdein Company

Designers and
Makers of

Mausoleums and Monuments

General Office and Yard
Kensington Road and South Street
Huntsville, Ohio

Century Border Metal Ornament

Printing Craft Monthly



\$3.00
Per Year

The magazine bearing the above title has a common appeal of interest to printers and engravers as well as to publishers or booklovers, indeed all those concerned in the allied arts, and a majority of the public



\$1.50
Six Months

THE HARINGTON PRINTING AND PUBLISHING COMPANY :: WILMINGTON

Typographical Designing

By HENRY WARD BRIGHTON

HOW many printers have been ruined by hap-hazard and loose business methods. Lack of proper methods in the composing room are likely to lead to serious losses. All jobs given to a compositor without definite instructions as to style, opens up an element of doubt as to the result. This uncertainty continues until the proof is taken, and if this happens to be unsatisfactory then the employer loses job. Ten years ago when the pioneer in the field of typographical design suggested to several compositors the idea was ridiculed, and the idea was represented had more than depended on to consist of. Today few plants of any size leave any designing to the compositor because the compositors mechanical possibilities in these ideas are to be carried out. This specialist sketches a layout sheet cut to the size and specifies the size and style of type and rules, and lets just how the finished job or less detail and lettering ink or crayon may be used according to impressions is highly pleasing to the eye that it was produced in the department in many work of the best class. It but on proved results of has been demonstrated in better results, both as to style and time than other few printers with modern consider seriously the method being new in all brings about the change little advice to many bet



The CLEARFACE FAMILY

Pre-eminently adapted for all classes of high-grade job work

BY SIDNEY FRANKALL

THE ROAD TO WEALTH

Story of an Advertising Campaign



ADVERTISERS PRESS
PHILADELPHIA, PA.

L. DESIGNING 4

planned and executed by one of the greatest designers of the age, the result is a great economy thereby secured. The increased efficiency in every detail of the design saves many dollars saved to the advertiser. The artistic and dignified design of the layout and the proper margins also gave the design a high quality. The layout is the logical result of the design applied to printing. This is a peculiar business. The same attention to every detail entering its condition to this fact, very close as a finished product will be given to anyone but the customer. The design is unsatisfactory, then every detail of the design is more or less of an art. The designer is more or less of an artist as to just what features are to be included in this way greatly adds to the value of the printing produced. To the advertiser it seldom find their way into the hands of the first class typographical designer with weakness of such heads. The design is advised by the layout man on the design. The design thus place the finished advertisement is highly satisfactory to every advertiser. The design create prospects for new business by a man capable of making results and pleased patrons if they are. Have you recognized the one of the most artistic typographies full of the rules and ornaments, is over-looked for more artistic pages, you as something worth some. One that generally costs four times as much as the other. The design generally sufficient for design of the modern style and also a distinct demand for more real and intricate design, taking hours

to compose, additional hours to justify on the stone, and more hours to make ready properly, all at a great expense, is giving way to the simple and dignified type-design with which the color of stock and ink all harmonize into making a beautiful and attractive piece of printing and advertising. The designer realizes that often a single embellished line of type, properly atmospherized with the stock and color, is far stronger than the most labored efforts requiring hours of time in the composing room. It costs much less to produce and creates greater profit for the printer. Another great weakness of the plan of leaving the copy to the compositor's ideas is his lack of familiarity with the innumerable subjects he is compelled to handle in a day's work. He is but human, and it is very unreasonable to expect him to be familiar with all the various themes he puts into type. Not being very conversant with the subjects, how can he be expected to bring out the strong selling points and thus create real strong advertising? The natural result is inane and poor advertising, about which the customer storms and for which the compositor is unjustly blamed. The question immediately arises: Is the typographical designer any more conversant with all these varied subjects than the compositor? He is not. But he has one great advantage over



AMERICAN LINE TYPE FACES

Lead the world for excellence in design and wearing qualities

72 Point

3 A \$6 90 4 a \$4 35 \$11 25

INSERTING
Loans Charm

60 Point

3 A \$5 60 4 a \$3 60 \$9 20

MONUMENTS
Beautiful Hymn

48 Point

4 A \$3 95 7 a \$3 65 \$7 60

QUICKEST JUDGE
Explanations Sought

42 Point

4 A \$3 10 8 a \$3 25 \$6 35

MERITED TRIUMPH
Herculanean Structures
Geological Examination

Clearface Bold Italic

36 Point

5 A \$2 75 8 a \$2 40 \$5 15

CONTINUED READINGS
Superb Clearface Bold Italic

30 Point

6 A \$2 30 10 a \$2 05 \$4 35

DEFEND FRENCH EMPEROR
Best Compositors Admire Printing

24 Point

7 A \$1 75 13 a \$1 80 \$3 55

SILENT HONEST MINERS RETURN
*Unearthed Important Document Recently
Beholds Marvelous Changes Everywhere*

18 Point

10 A \$1 60 20 a \$1 70 \$3 30

DESTROY FINEST SHIP
*Handsome Chrysanthemum
Oregon Roses Delight Hosts*

10 Point

18 A \$1 20 38 a \$1 30 \$2 50

STRENUOUS EXERTION TIRES
*Introducing Muscular Development
Splendid Gymnastic Entertainment
Graceful Acrobat Nonsense Pursued*

8 Point

21 A \$1 05 44 a \$1 20 \$2 25

DISTINGUISHED FOREIGNER RETURNS
*Greatest Financial Achievements Enumerated
Investigated Gigantic Mining Swindle Quietly
Largest Enthusiastic Stockholders Bewildered
Reprinted Handsomest Specimens Wednesday*

14 Point

14 A \$1 40 29 a \$1 60 \$3 00

LISTING BROKER GENEROUS
*Magnificent Buildings Demolished
Improved Contracts Reward Buyer
Demonstration Silently Performed*

6 Point

24 A \$0 90 50 a \$1 10 \$2 00

PRODUCE MAGNIFICENT BURLESQUE SHOWS
*Stunning Damsels Delight Unsophisticated Audiences
Continuous Performance Every Monday and Saturday
Abbreviated Costumes Cause Great Excitement Among
Exclusive Society Circles, Introducing Weird Dancers
Which Brings \$1234567890 Manager Sufficient Credit*

12 Point

16 A \$1 30 35 a \$1 45 \$2 75

SOUTHERN GIRLS COMING NORTH
*Honorable Gentleman Worked Every Day
Handsome Designs Wrought Exclusively
Since Clearface \$1234567890 Bold Italic*

5 Point

23 A \$0 95 46 a \$1 05 \$2 00

MONSTER WARSHIPS ENTERING NEW YORK HARBOR
*Giant Rifles Belching Naisy Salutes to American Commanders
Bluejackets Received Pay and Granted Shore Liberty Tuesday
Many Curious Visitors Being Entertained by Admiral and Crew
Mascot Monkey Becomes Attached to Youngest Quartermasters
Several Oldtime Sailors Went to Coney Island and Rockaway*

Diamonds

*BRILLIANT STONES DIRECT FROM
THE FAMOUS SOUTH AFRICAN
MINING DISTRICT*

*HAVING lately secured
a third interest in one
of the most productive
diamond mines in the South
African district we are now
prepared to furnish our cus-
tomers and their friends with
the most magnificent stones
on the market. Employing
none but the most expert in
the art of diamond cutting
and being in the position to
cater direct to the public, we
have built up a reputation for
reliability and quality that is
second to none in the world
An enlarged show room will
be opened early next month*

*Meirsont
Company*

RICHMOND, MAINE

Trade Cut Panel Border

Fashionable Clothing

*Delightful Winter creations from London
and Paris. Tailor-made garments in all
the latest styles at moderate prices. Our
new designs in Spring cloaks and skirts
will please the most fastidious customers*

*TELEPHONE
2846
NUMERAL*

Markson & Braindom

SECOND AND MARKET STREETS, PHILADELPHIA

*STYLISH MODES
FOR THE
WOMEN WHO
DRESS SMARTLY*

CRUISES

THROUGH THE MEDITERRANEAN SEA

No other tour could be planned at the same expense of time and money which will give you as much enjoyment as a visit

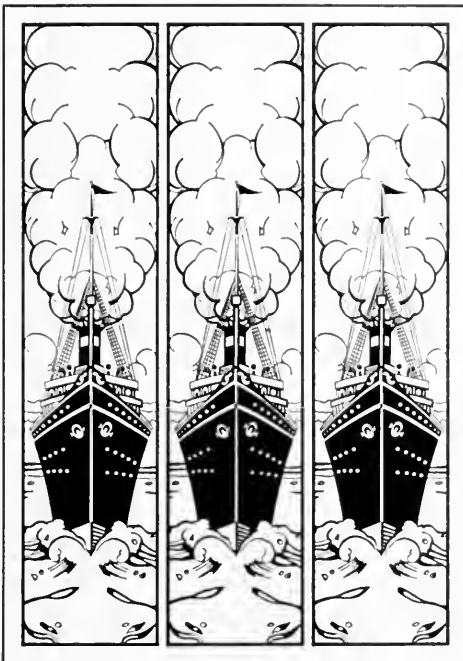

to the romantic resorts situated along the coast of the beautiful Mediterranean. A number of stops will be made during the trip to give the passengers a chance to view the strange scenes and quaint customs of the natives. No expense has been spared by the Metropolitan Steamship Company to make these tours the best that have been offered at such a low rate. The boats are equipped with all modern appliances both for comfort and safety. To insure getting a good berth your order for tick-

Write for Further Particulars

ets should be sent in at once as the company anticipates a large demand for accommodations on these tours. No better way to spend your vacation could be devised than one of these trips

HERBERT R. MEIRDON

Passenger Agent

1288-1290 North Bainbridge Street
Telephone 186-Bell NEW YORK CITY

72 Point

3 A \$7 75 4 a \$5 35 \$13 10

PRINTERS
Fine Design

60 Point

3 A \$6 35 4 a \$4 50 \$10 85

MENTIONED
Bought Sticks

48 Point

3 A \$4 15 5 a \$3 35 \$7 50

RICHEST MISER
Pleasant Morning

42 Point

3 A \$3 25 6 a \$3 20 \$6 45

MODERN STORIES
Use Clearface Heavy
Receives Instruction

36 Point

1 A \$2 65 7 a \$2 55 \$5 20

PREMIUM RETURNED Strong Athletes Coming Copy Original Specimen

30 Point

5 A \$2 20 8 a \$2 05 \$4 25

COMPOSITORS REJOICING Shows Bolder Advertisement Exposing Honorable Methods

24 Point

6 A \$1 70 11 a \$1 80 \$3 50

SEVENTH DESTRUCTIVE FROST Healthy Soldiers Marched Saturday Young Ladies Entertain Gentlemen

18 Point

8 A \$1 50 16 a \$1 75 \$3 25

BRINGS DOCUMENTS Great Earthquake Here Excursionists Delighted

10 Point

16 A \$1 15 32 a \$1 35 \$2 50

SECURED MONSTER ORDER Eminent Orators Disappearing Educated Monkey Died Friday Beautiful November Afternoon Detectives Surprised Old Chief

14 Point

12 A \$1 35 24 a \$1 65 \$3 00

PROSPEROUS GOLDSMITH Mailing Descriptive Pamphlet Convention Reports Progress Foreign Delegations Entering

8 Point

19 A \$1 05 38 a \$1 20 \$2 25

EXPERT HUNTER BECOMING BLIND Lonesome Spinster Helps Poor Student Largest Fleet Left North River on Time Much Powder Used in Saluting Officials President Visited Large Ship Thursday Buy Boston Wire Stitchers Every Time

12 Point

16 A \$1 35 29 a \$1 40 \$2 75

HANDSOME WOMEN OBSERVED Large Theatre Completely Wrecked Distinguished Government Officers New Figures \$1234567890 Shown

6 Point

24 A \$0 95 47 a \$1 05 \$2 00

HANDSOME BLONDE RETURNED TUESDAY Wealthy Compositors Spurned by Fair Maiden Expert Border Designer Becoming Melancholy Important Evidence Received from Ice Dealers American Type Founders Company Originator Several Printers \$1234567890 Saving Money

Braddock Park Opening

NATIONAL pride and American patriotism prompted the Harn Railway Company to lay out a beautiful park near the place where General Braddock was overcome and defeated by the Indians. All places of any historical interest should be properly marked and the large monument previously erected will have an appropriate and beautiful setting. See daily papers for programme and special rates to Braddock Park on the great opening day, July 9. This being also the date of the place July 9, 1755. The H put on cars to accomod

Celebration Border Versatile Initial Tint, Inland Border No. 1241

THIS TICKET

and twenty-five cents
is full payment
for twelve
views

LAMB POSTCARD CO.

MONEY IN OUR BANK

Safe as modern
locks can make it

Oleas Trust
Company

Inland Tree Ornaments Versatile Ornament

Clearface Heavy in Practical Display

Our Banner Days

Ladies' Coats in the latest modes will be found on the second floor. You will observe many other little bargains waiting for you here on the Banner Days of this great sale



We are going to make Thursday, Friday and Saturday, January 6, 7 and 8, of the coming week three big Banner Days in our Annual White Goods Sale. Read the big page advertisements in the morning newspapers about this week end display of special values. Every article marked to one-third original price on Banner Days

WELKENSON DRY GOODS COMPANY

NO. 183 KENDALL AVENUE, TARPOT, PA.

Cast Squares Patriotic Border

MODEL SUITS

FOR SWELL DRESSERS

Men's Clothes are so cleverly constructed nowadays and are offered so temptingly, that it is indeed quite difficult to determine one's choice. Don't waste your time in looking around, just come in and buy one of our new Model Suits. Model spring suits and overcoats sell at \$19.50 and upwards. Our written guarantee goes with every garment that leaves our store. We like lookers; come in any time

THE MODEL CLOTHIERS

SENECA, PENNSYLVANIA

Clearface Heavy Italic (Non-Kerning)

72 Point

3 A \$8 10 4 a \$5 35 7 \$13 45

INFRINGE
Hunt Kings

60 Point

3 A \$6 70 4 a \$4 50 \$11 20

EXPENDING
Knight Comes

48 Point

3 A \$4 50 4 a \$3 00 \$7 50

CURED PRINCE
Mentions History

42 Point

3 A \$3 30 6 a \$3 30 \$6 60

MODERN HOUSES
Describe Great Shop
Protected Merchant

Clearface Heavy Italic (Non-Kerning)

36 Point

4 A \$2 75 6 a \$2 50 \$5 25

PRINTERS REMODEL
Originated Fine Border
Finish Elegant Machine

30 Point

5 A \$2 30 8 a \$2 05 \$4 35

EXPORTING MACHINERY
Delighted Children Returned
Showing Handsomest Design

24 Point

6 A \$1 75 10 a \$1 75 \$3 50

DETERMINED CONFECTIONER
Threatening Rainstorms Vanishing
Awaked Honest Pressman Monday

18 Point

8 A \$1 50 16 a \$1 75 \$3 25

HUNTING DESERTER
Pirate Steamer Returns
Trusting Maiden Found

10 Point

16 A \$1 20 31 a \$1 30 \$2 50

CITIZEN REJECTED CLAIMS
Intelligent Students Exercising
Unfortunate Railroader Found
Supreme Council Invites Belles
Broadway Production Pleased
Destructive Storm Announced

14 Point

11 A \$1 40 22 a \$1 60 \$3 00

HIRES HONEST PRINTERS
Determined Baseball Umpire
Handsome Burlesque Maiden

8 Point

19 A \$1 10 36 a \$1 15 \$2 25

MAGNIFYING GLASSES DESCRIBED
Great Historians Write Unusual Stories
Sympathetic Crowd Donated Five Cents
Pressman Thanked Curious Composer
Boarding House Keeper Demands Coin
Handsome Children Entertaining Guest

12 Point

15 A \$1 30 25 a \$1 45 \$2 75

STRIKING DESIGNS PRODUCED
Modern Creation Displayed Friday
Remarkable Burlesque Performers
Sailor Spent \$1234567890 Money

6 Point

21 A \$0 95 40 a \$1 05 \$2 00

EXCITED BUTCHERS BOUGHT ORCHARDS
Marvelous Performances Rendered by Actress
Great Mechanical Device Originated by Printer
Experienced Statesmen Planned New Measure
Tremendous Crowd of Beautiful Women Came
American Type Founders Company Creations
Instructs Prosperous \$1234567890 Children



Easter Hats at Reglan's

QUANTITY and style are the big features of Reglan's Sale of Men's Hats for the attire of swell dressers on next Easter day. We have them in the very latest styles and in some nobby shapes. Spring derbies in gray, black and brown. Soft hats of selected stock that certainly speak for themselves

THE MANSEL HAT

Designed especially for His Majesty after his own original ideas. Now King Mansel has the reputation of being the best dressed man in all Europe. The Mansel Hat is the rage now in all metropolitan centers

This hat is the best really worth-while novelty in the hat line that we have seen for some time. All famous makes are represented here, The Wright, Acorn, Gold Crown, Willowton, Bosto & Gukor, The Lion and Big Prize hats

Reglan's

Largest Hatters in Uniontown



At the Sign of the Lion

You will find the best printing office in the city of East Cormly, let us show you some of our work. When you want the best in quality and workmanship, see us

Arnold's Print Shop

Strathmore Ornament

Real Advertising

A Matter of Dollars

Advertising is the royal highway to opulence and wealth. It is the vital principle that makes for success in any business institution. Selling is a most important science and deserves every consideration by discerning business men. The *Publicity Magazine* is a mine of information to men who have to do with modern advertising

For Sale by Newsdealers Everywhere

PUBLICITY MAGAZINE

A Monthly Periodical for Live Business Men

Clearface Gothic

72 Point

3 A \$6 30 4 a \$4 05 \$10 35

MINER HUNTS
Distinct Gothic

60 Point

4 A \$5 40 6 a \$4 75 \$10 15

WITH PRECISION
Careful Managing

48 Point

5 A \$3 95 8 a \$3 70 \$7 65

PRESIDENT RETIRED
Newspaper Publishing

42 Point

5 A \$3 15 9 a \$3 25 \$6 40

MAGAZINE INFLUENCES
Understands Remarkably
Clearface Gothics Shown

36 Point

6 A \$2 45 10 a \$2 80 \$5 25

HIGHEST GRADE MECHANIC Somewhat Exceptional Artists

30 Point

6 A \$2 10 12 a \$2 25 \$4 35

DEVELOPS USEFUL INFORMATION Newsdealers Establish Departments

24 Point

8 A \$1 70 15 a \$1 85 \$3 55

BEAUTIFUL PRINTING PLEASED FOREMEN Charming Manicure Received Many Visitors Exquisite Letter for Magazine or Newspaper

18 Point

12 A \$1 55 22 a \$1 75 \$3 30

BOUGHT USEFUL MATERIAL Lovely Spring Weather Today Helping Youthful Composer Grand Opera Singers Pleased

10 Point

22 A \$1 15 43 a \$1 35 \$2 50

PROVIDING STRONGER CHARACTER Noble Features Embodied Throughout Shows Exquisite Modern Type Design Containing Beautiful Clearface Effect American Type Excels all Competitors Noticing the Very Striking Originality

14 Point

15 A \$1 35 32 a \$1 65 \$3 00

PRINTER FOUND WHITE DIAMOND Compositors Improving Consistently Rockaway Beach Bathing Refreshing Bachelor Found Young Widow Crying

8 Point

25 A \$1 05 48 a \$1 20 \$2 25

SYSTEMATIC GOVERNMENT SHOWS CHANGES Bluebirds Flying Northward Meet Cold Weather Disastrous Railroad Wreck Caused Much Delay Oldest Inhabitant Pursued by Boisterous Crowds Present Artistic Design of Original Copy to Judge Modern Printers Used Only Materials of Quality

12 Point

19 A \$1 30 37 a \$1 45 \$2 75

HONORED GUESTS CAME FROM BOSTON Greatest Marathon Race Proved Interesting Promoter of Giant Wrestler Receives Medal Amateur Boxers Caused Much Amusement Useful and \$1234567890 Distinct Figures

6 Point

26 A \$0 95 52 a \$1 05 \$2 00

REFINED GENTLEMAN RETURNS AFTER CORONATION Stylish Women Went to the Aviation Field on Large Stage Gigantic Steamer Floated Majestically on Atlantic Ocean Order Sorts Frequently and Save Time Used for Picking Nearly all Grades of Printing Improved with Our Borders Prominent Visitors Attend the Opening of Coney Island American Type Founders Company Produces Best Faces Much Money Expended \$1234567890 Seeking Pleasure

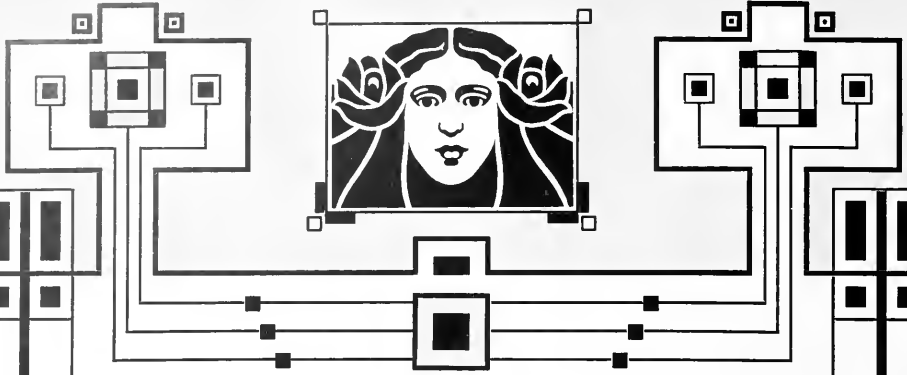

Hotel Elizabeth

BROADWAY AND HURON STREET
CHICAGO

This is the newest and one of the greatest hotels in America. Hotel Elizabeth is a two million dollar structure, at the apex of the busiest section of Broadway, embodying in every feature the important idea of doing everything perfectly. It is the only hotel in this great city that caters exclusively to the women folks, thus enabling them to secure accommodations which are pleasant and entirely free from the annoying and very objectionable scrutiny of a curious throng in the lobbies and corridors. There is the rare quality of perfect taste, as well as of richness, permeating the whole house. The restaurant is the finest in this city, or in all America. The dignified, quiet comfort, the restful repose, the tasteful furnishings of the sleeping rooms, the reception and the reading rooms are similarly characteristic

EUROPEAN AND AMERICAN PLAN

Exclusive Hotel for Lady Patrons

MISS MARION BUDDINGTON
Manager



SOMETHING ABOUT

HAMILTON

Printing-Office Furniture



WHAT we have done for others we can accomplish in any printing office where the furniture equipment has not been modernized. It is a fact that printers are most conservative in changing their equipment. At the present time there are hundreds of composing-rooms where, with a small investment in new furniture requiring less outlay than the purchase of a new cylinder press, a saving could be made amounting to from 10 to 20 per cent in labor, and from 20 to 30 per cent in floor space.

AMERICAN TYPE FOUNDERS COMPANY

CONVENIENTLY LOCATED SELLING HOUSES

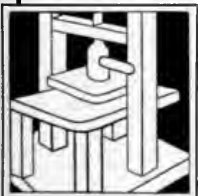

All of the Hamilton Manufacturing Company products can be purchased at any of the American Type Founders Company Selling Houses at the lowest prices and best terms. Modernize your plant with Hamilton Materials

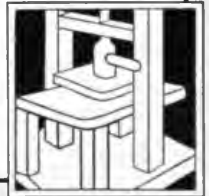

120 Point

3 A \$11 25 4 a \$7 30 \$18 55

HIS Kid

96 Point

3 A \$8 70 4 a \$5 70 \$14 40

RETIRE

Style Jobs

84 Point

3 A \$7 55 4 a \$4 95 \$12 50

EMPIRES

Hunts Sign

72 Point

3 A \$7 60 4 a \$4 60 \$12 20

MENDERS
Home Study

60 Point

3 A \$6 05 4 a \$3 80 \$9 85

REBINDING
Splendid Prints

48 Point

3 A \$3 85 6 a \$3 65 \$7 50

FINE IMPRINT
Guitars and Pianola

42 Point

3 A \$3 20 7 a \$3 20 \$6 40

MINDS FIRMEST
Send Federal Reports
Practical Ends Noted

36 Point

3 A \$2 45 7 a \$2 55 \$5 00

HANDSOME PRINCE
Sought Historic Ground

30 Point

4 A \$1 85 10 a \$2 50 \$4 35

PRINT FINE SPECIMENS
Noted Geographers Advance

24 Point

5 A \$1 60 12 a \$2 00 \$3 60

DETERMINED CITIZEN TOLD
Remarkable Horticultural Exhibition

20 Point

7 A \$1 55 14 a \$1 70 \$3 25

DEFEND SOLDIER
Government Recovered
Seven Hundred Dollars

11 Point

16 A \$1 30 38 a \$1 45 \$2 75
12 A \$0 50

A HISTORY OF AD-WRITING
Some twelve years ago an advertising
writer advised his employers that, in
public addresses, pictorial illustrating
would be found important attractors

18 Point

9 A \$1 60 19 a \$1 65 \$3 25
5 A \$0 50

MODERN BUILDINGS
Elegant Structure Complete
Increased Store Department

10 Point

16 A \$1 10 44 a \$1 40 \$2 50
15 A \$0 50

ADVERTISERS WANT RETURNS
The mistake in selecting publications with
the largest circulations, without regard to
class, often results in great loss to the firm
thus advertising, and also to the publishers

14 Point

12 A \$1 40 27 a \$1 60 \$3 00
9 A \$0 50

CAPTURED BOLD BRIGAND
Manipulate Unsuspecting Citizens
Police Enthusiasm Disrupted Band

8 Point

18 A \$1 00 45 a \$1 25 \$2 25
17 A \$0 50

THE DECORATION OF CATALOGUES
Nearly everyone knows the real purpose of the
catalogue; it surely is not sent out to exploit the
personal work of the artist who designed it or
the typographical mannerisms of the compositor

12 Point

13 A \$1 25 32 a \$1 50 \$2 75
11 A \$0 50

REMARKABLE SEA EXPEDITION
Twelve American Yachtsmen Entertained
Guests Recognized Exceptional Qualities
Horticultural \$1234567890 Growers Met

6 Point

22 A \$0 80 63 a \$1 20 \$2 00
21 A \$0 50

NUMEROUS OUTLINES OF HISTORY ILLUSTRATED BY
PROMINENT PROFESSORS OF SEVERAL UNIVERSITIES
Since all immemorial, historic places have had their round of sight
seers from every nation, so Pottstown with all its points of interest
excites the traveler to press onward with tireless energy to reach
the goal of his ambition, that is, to see everything. In the space
eastward of the celebrated Casino stands the Coliseum Theatre,
which became the boast of Pottstown and the world. \$1234567890



Investments

A GOOD INVESTMENT IS EQUIVALENT
TO A WHOLE LIFE OF ARDUOUS LABOR



YOU are the very man with whom we wish to talk; you have something you wish to invest, you want to invest it where it will bring you the largest profits. You know, however, that \$100 or even \$500 is not sufficient capital to make you a fortune, if you depend on interest rates. People don't get wealth by hard work. Pinching and saving is not the profitable way. Yet if \$100 or \$1,000 is placed in the safest of all investments—Lewiston Park Real Estate—where values have a habit of doubling over night, there is a positive assurance of its reaping for you an immense percentage of profit in return. We have managed and placed small investments for a great number of men and women, having made from 100 to 1,000 per cent profit in the past three months, which has placed them upon a solid basis of practical affluence. To secure an interest in this quick money maker, very prompt action is necessary.

HENRY MADESON COMPANY
MANCHESTER AND BROADWAY, KANSAS CITY

THE
SHERIN MANUAL OF
PRINTING

A TREATISE ON THE
TECHNICAL POINTS IN THE
PRINTING TRADE

• • •

CONTAINING RULES FOR
PUNCTUATION AND CAPITALIZATION • STYLE
MARKING PROOF • MAKE UP OF BOOK
SIZES OF BOOKS • DIAGRAMS OF IMPOSITION
SIZES OF THE UNTRIMMED LEAF
AND OTHER USEFUL
INFORMATION



PUBLISHED BY THE
HERRINTON & DEANBURG CO.
CHICAGO AND BOSTON

The First Ancient Patriotic and Folk
SONGS
of Great Britain and Ireland as sung by
Bards and Minstrels in Saxon, Gaelic
and Cymric tongues, now Translated

Under *the* Patronage of H. M. GEORGE III

FAVOURED by the *patronage* of His Gracious Majesty and the Ancient Nobility and Clerical Highnesses of these Realms, some *Scholars* of great wisdom relating to **Minstrel Lore** in this volume have revived for the use of all Right True and Loyal Subjects of our Sovereign Master many of the *Sacerdotal, Chivalric and Mystic Songs and Poetical Recitals* which in the olden times cheered and inspired alike the Warlike Camps and Peaceful Gatherings in Castle, Abbey, Palace and Manor Hall. These **Minstrelsies**, the Inspirations of our ancient National Prowess, are now printed for the first time and made available as household treasures in patriotic homes.

SOLD ONLY TO SUBSCRIBERS IN ADVANCE

Founded in the Year of Our Lord, MDCCCLXVI
The Ancient Patriotic Literature Society
Carter Lane and Ludgate Hill, London, E. C.

42 Point

4 A \$3 50 7 a \$2 75 \$6 25

*SENDING PHONE
Discontinued Investments
Uses Lining Caslon Italic*

36 Point

4 A \$2 70 8 a \$2 50 \$5 20

*HUNTING KINGDOM
Trustworthy Manufacturers
Rebuilding Greatest Factory*

30 Point

4 A \$2 15 9 a \$2 10 \$4 25

*BROTHERS ENJOINED
Burlesque Maidens Ruminating
Produce Many Lovely Designs*

24 Point

5 A \$1 75 12 a \$1 85 \$3 60

*BINDERY GIRLS TURBULENT
Conversations Interested Superintendents
Handsome Specimens Received Saturday*

20 Point

7 A \$1 65 14 a \$1 60 \$3 25

*RECEIVES DANGEROUS CROCODILE
Many Printers Fishing Along Muskingum River
Tourist Returned from Long Sojourn in Bermuda*

18 Point

8 A \$1.60 19a \$1.50 24 \$1.00

*PHILOSOPHERS QUESTION HISTORIAN
Beautiful Caslon Characteristics Please Careful Buyers
Handsome Specimens Reward Users of American Faces
Striking Designs of Exquisite Taste Produced with Italic
Remarkable Performance Delighted Immense Audience*

14 Point

12 A \$1.40 28a \$1.30 38 \$1.00

*DELIGHTS HOME COMERS WITH BIG RECEPTIONS
Elderly Gentlemen Became Excited at Automobile Races Last March
Harmless Lemonade Causes Remorse Whenever Drunk by the Printers
Midsummer Romances Become Popular on Lovely Moonlight Evenings
Heavy Steamships Remodeled and Sent Toward Northern Greenland
Grand Scenery Was Admired by American Tourists Visiting Europe*

12 Point

11 A \$1.35 33a \$1.40 32 \$1.75

*PROMISE FARMERS IMPROVED TRANSPORTING FACILITIES
Stylish Workmanship of Practical Usefulness Suits the Superintendents and Customers
Making Radical Changes Owing to Demoralized Conditions of Banking Department
The Abundance of Material Helps to Regulate Production in Modern Printing Plant
Useful American Type Leads the World for General Originality and Distinctiveness
Damaging Windstorms Destroy \$1234567890 Many Large and Prosperous Hamlets*

11 Point

16 A \$1.30 40a \$1.45 32 \$1.75

*EXPERIENCED CUSTOMERS PLEASED
This Popular Face Increases Sales of Your Printing
Ability is Required in Purchasing Correct Material
Enterprising Measures Drawn by Better Statesmen
Tremendous Crowd of Fashionable Women Parade
Charming Entertainers Score Great Success in 1676a*

8 Point

19 A \$1.00 46a \$1.25 32 \$2.25

*UNIVERSAL CHARIOT RACES WITNESSED
Nine Thousand Turn to Review the Great Spectacle
Far North People Elect King to Rule in Polar Region
Faithful Pegasus Wondering at Modern Aeroplanes
Enterprising Advertisement Writers Secure a Result
Discriminating Members Attend Elaborate Science
Extraordinary Excursionist Spent Money Lavishly*

10 Point

18 A \$1.25 43a \$1.25 32 \$2.50

*HUMOROUS ANSWER CAUSES COMMENT
Found Artificial Lakes Surrounded by Fragrant Roselushes
Handsome Designs Composed by Foremost Country Printer
Staunch and Hearty Sailors Cruised Over Foreign Waters
Curious Audience Fails to Discern the Prominent Orator
Many Characteristic and Striking Type Designs Presented
Bright and Original Effects Produced with this Lovely Face*

6 Point

21 A \$0.80 68a \$1.20 32 \$2.00

*THEATRICAL PERFORMANCE CREATING ENTHUSIASM
Enormous Crowd Turned Away from His Entertainment, D. J. Walker
Acted as a Great Pleasure to the Remembrance of the Great Drama
Unusual Character of the Performance Caused the Dramatic Critic
Dominic's Character from the Play to be the Cause of the
Ingenious Nature of the Play, the Play, the Play, the Play
The Character of the Play, the Play, the Play, the Play
Detailed Treatment of the Play, the Play, the Play, the Play
Goes to Singing School, Dances, Large Amount of Other, H. H.
Goes to Report from Mexico, \$1234567890, \$1234567890*

Northland Technical School for Designers

New Course in the Graphic Arts

The new course of instruction in the Graphic Arts will include Composition, Proofreading, Lettering, Writing of Copy and Practical Engraving. Instruction is given by correspondence, every lesson of the course receiving individual attention from the instructors. Through it the new and most approved educational methods are now applied to the Graphic Arts. Students are taught the reason why of good composition. All the principles of design and color harmony are applied to typography in a scientific manner. The twelve lessons in Lettering will meet the ever increasing demand for this work and it is a special feature

Lessons in Lettering

present the subject in a new manner and give the information desired in the most useful way. They deal with methods of reproduction and give ideas that facilitate work. Send for full information and sample lessons

Read this letter from one man who graduated after taking a course of study in Decorative Design. "The course is of the highest class and has proved to be of inestimable value to me in my work. Every lesson is so instructive that the study hour is a pleasure. It gave me much that could not be secured from any other source. As an investment it certainly wins. I now make double my previous pay"

Representative in this city for Northland Technical School

*Brocton G. Masterlend
Offices on Second Floor of Sturman Building*

Silver of Quality

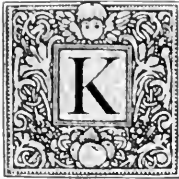

ING Louis XIV of France attached to his royal court the masters of every art and craft. He stimulated them to do their best by liberal rewards of money and extension of royal favors and the wisdom of this liberal policy was immediately seen in their work

*Vauban was his engineer, Mansart built his palaces,
LeBrun adorned them, LeNotre laid out his gardens,
Gobelins wove his tapestry, Boulé was his cabinet-maker,
Watteau painted his pictures, Ballin was his metal worker.*

Under such a master these men made his reign famous for its splendor. It was an age of Magnificence. Today we interpret that seventeenth century magnificence in Kormens Solid Silverware in the Louis XIV style and the effect is exceedingly grand, with an impressive massiveness and richness seldom seen in modern times

*In an examination of Kormens Silverware there will
be found designs adapted to the different historical
periods of the seventeenth and eighteenth centuries.
Kormens Silverware is recognized by its superiority
and may be obtained of leading jewelers everywhere*

KORMENS COMPANY
Manufacturers of Quality Silverware

STERLINGTOWN, MASSACHUSETTS

84 Point

3 A \$8 45 4 a \$4 80 \$13 25

HERDING
North River

72 Point

3 A \$6 90 4 a \$3 90 \$10 80

STRANGLE
Hardest Metal

60 Point

3 A \$6 00 4 a \$3 40 \$9 40

MECHANICS
Knocked Down

48 Point

4 A \$4 25 6 a \$3 25 \$7 50

STYLE BINDING
Decorator Holidays

42 Point

1A \$1 7a \$2 90 \$6 25

PRINTER FRIENDS Sociable Manufacturers

36 Point

1A \$2 60 8a \$2 10 \$5 00

ORIGINAL DESIGNER American Type Invigorates

30 Point

5 A \$2 15 10 a \$2 10 \$1 25

NEW HISTORICAL SCENES House Containing Entertainment

21 Point

6 A \$1 75 13 a \$1 75 \$3 50

MICHIGAN ORPHEUM FINISHED Conversation Interested Superintendents

18 Point

10 A \$1 65 18 a \$1 60 \$3 25

ELEGANT RENDITION North Boston Lemon Clubs Comets Arrive on Schedule

10 Point

18 A \$1 25 36 a \$1 25 \$2 50

EXPECT EARLY INDICTMENT Condemned Prisoners Are Sentenced Kind Magistrate Industrious Studies Contents of Ponderous Bound Books Millionaire Manufacturer the Victim

14 Point

13 A \$1 45 27 a \$1 55 \$3 00

GRECIAN MYTHS INTEREST Many an Interesting Conversation Enjoyable Afternoons Maintained

8 Point

21 A \$1 40 42 a \$1 15 \$2 25

ENTERPRISING SOCIETY NEWSBOYS Sales Consequently Vastly Increased Thereby Profits Make Lighter the Heart of Little Mike Most Thunderous Tone Ever Audible in City Deafening Roars Make People Think of Babel

12 Point

15 A \$1 25 32 a \$1 50 \$2 75

REVIEWING NATIONAL GUARDS Duplicate Declaration of Independence Investors Realizing Unusual Dividends Foreign Places \$1234567890 Amusement

6 Point

23 A \$0 95 47 a \$1 05 \$2 00

GENEROUS MARGINS DELIGHT THE READER Modern Printers Always Give Proper Consideration An Artistic Touch Requires Conception of the Beautiful Typographers Study Art of Other Periods and Peoples Colorado Reports Largest Rainfall for Nineteen-three Weather Bureaus in Western States Giving Statements Great Agricultural Display \$1234567890 Anticipated Next

Elements of Design in Decoration of Covers

THERE IS ONE VERY NOTED CHARACTERISTIC OF COVER DECORATION THAT SETS IT APART FROM MOST OTHER DEPARTMENTS IN DESIGN

IT is not unnatural when we consider what the principal function of the cover of a book has grown to be in its evolution from just a simple protective case; and surely, apart from extremely plain-lettered covers, there is more to be said in favor of a cover that serves in some way to suggest the character of the contents of a book than of one that only embodies a scheme of a purely formal line of decoration without any reference to what is contained within. The usual difficulty with many symbolic covers (a difficulty which has led us occasionally to emphasize, at their expense, covers of a more formal type) is that they, and the artists that design them, very often try to symbolize too much. It is a fundamental rule that no element of reality may enter into a scheme of decorative composition without undergoing such modification of its parts as may be necessary to bring it into relation to other elements in design

THE WESTERNER

7

CHAPTER VI

IN October of that year, Fred Furlman was at a post of the Harlem Bay Company when the news came that a large body of English settlers was at hand. He saw at once what this meant. With only a few hours' preparation he set off on horseback, determined to go to Washington. He meant to see Mr. Webber to tell him how possible it was for the United States to occupy Oregon, and so to prevent him from making a treaty which should surrender that country.

With a companion and a guide he left the neighborhood of what is now Walla-Walla. It was a terrible ride. Exactly three months afterwards he was at Santa Fe, having braved the ice

A TRIP THROUGH
THE WEST

A NATURE STUDY

WRITTEN BY

FRANCIS W. HILLS



BOSTON NEW YORK

SMITH, WHITE & CO.

Publishers

Collins Florct

COVER PAPER

for

From BARSTOW & HAWKINS
320 South Montana Street, Philadelphia

48 Point

4 A \$4 40 6 a \$3 10 \$7 50

*HUNTS POLICE
Neat Design Selected
Question Eleven Boys
Stevedore Triumphed*

36 Point

4 A \$2 55 9 a \$2 45 \$5 00

*RECUT CASLON TYPE
Fine Display of Modern Style
Instruct Nine Clever Binders
Parks and Beaches Thronged*

30 Point

4 A \$2 00 12 a \$2 25 \$4 25

*DESIRES KNOWN METHOD
Twelve Constables Overtake Burglar
Coney Island Bathers Rescued Lady
Amateur Detective Startles England
Jumps From Automobile Into Ocean*

24 Point

1 A \$1.40 1.1a \$2.00 \$3.70

GUARDING ANCIENT BUILDING
*American Soldiers Return Quite Indignant
Banker Insured Foreign Depositor Recently
Kinetoscope Entertainment for Young Girls*

18 Point

1 A \$1.15 2.1a \$1.80 \$3.25

DEPORTED SEVERAL AGED FOREIGNERS
*Beautiful Imported Chinaware Bought by Frenchman
Public Exhibition of Antique Furniture and Novelties
Melodrama Pleased Renowned European Playwright
Training School Pupils Enjoyed Sail on Broad Pacific*

14 Point

1.1 A \$1.30 3.0a \$1.70 \$3.00

LEGIBLE CHARACTERS PRODUCED BY AMERICANS
*Statesman Denounces Tricky Methods Employed by Crafty Detective
Famous Author Reviews Works of Prominent English Fiction Writer
Legislators Declare Laws Invalid After Many Unnecessary Remarks
Natural History Being Studied by Freshman Class at Old University*

12 Point

1.3 A \$1.20 3.6a \$1.55 \$2.75

GIANT STEAMER RUNS AGROUND
*Large Gathering of Lithographers Delighted
Dynamiting Beautiful Eastern Art Museum
Japanese Curio Treasured Highly by Prince
Bring Along \$1234567890 That Office Devil*

8 Point

1.6 A \$0.90 5.0a \$1.35 \$2.25

CUB REPORTER SUES STOCK BROKER
*Beautiful Recut Caslon Italic Series Suited Craft
Lumber Industry Revolutionized Since Civil War
Great Opportunities for Young and Strong Mince
Adventurers Tried in Vain to Resist Call of Wild
Rapid Growth of Southwest Surprised Foreigner
Manhattan Island Still Holds Its Many Charms*

10 Point

1.5 A \$1.05 4.3a \$1.45 \$2.50

DISCOVER RUINS OF ANCIENT ROME
*Experts Cheat Themselves Auditing the Accounts
Strangest Kind of Quadrupeds Seen Near Chicago
Marathon Contestants Finished Tedious Training
New England Merchant Retires After Two Years*

6 Point

1.8 A \$0.85 5.3a \$1.15 \$2.00

MUSICIANS ENTERTAIN YOUNG ORPHANS
*New Haberdashery Advertises Nine Bargains for Men
Jurist Speaks Before Large and Intelligent Gatherings
Organizing Armed Troops to Invade Jungles of Borneo
Trained Ponies Delighted Young Children From Texas
King of Tropical Island Enjoys Long Stay in Germany
Amusement Resorts \$1234567890 Near Rockaway Beach*

Recut Caslon Italic in Practical Display

COLOR IN ADVERTISING

THE attractive power of many good advertisements is oftentimes greatly increased by the use of proper color. From the standpoint of the reader, the right use of that color is of primary importance. As it will probably command his attention, it is important that color should attract, not repel. Strong color used without discretion calls attention to itself, not to the advertisement. Color that is carefully harmonized and used very discriminatingly with regard to the amount and its distribution will help to retain attention and concentrate it upon the important matter in the advertisement. One is an index finger pointing out and making clearer the way to the pith of the advertisement and the other an obstruction beyond which numerous readers never pass

Empire Border

THE FISHING SONG

*Down in the wide, gray river
The current is sweeping strong;
Over the wide, gray river
Floats the fisherman's song.*

*The oar-stroke times the singing,
The song falls with the oar;
And an echo in both is ringing,
I thought to hear no more.*

*Out of a deeper current
The song brings back to me
A cry from mortal silence
Of mortal agony.*

*Life that was spent and vanished,
Love that had died of wrong,
Hearts that are dead in living,
Come back in the fisherman's song.*

*With the rude strain swelling, sinking,
In the cadence of days gone by,
As the oar, from the water drinking,
Ripples the mirrored sky.*

*Yet the soul hath life diviner;
Its past returns no more,
But in echoes, that answer the minor
Of the boat-song, from the shore.*

*And the ways of God are darkness;
His judgment waiteth long;
He breaks the heart of a woman
With a fisherman's careless song.*

Madison Avenue and Bard Street

WE wish to call your attention to the special display which we are now making of new fall and winter fancy dress materials. This display comprises the choicest patterns of the leading European manufacturers and was personally selected by our own expert representative. An early inspection will assure you of the opportunities to be derived from this display

Franklyn Edwardson & Company

Henry Mandeville, *President*

Andrew Kane, *Secretary*

Patrick Munro, *Treasurer*

Radmon Printing Company

Fine Catalogue Builders

Designers : Engravers : Illustrators : Electrotypers

PUBLISHERS OF THE IDEAL MONTHLY JOURNAL

*Madison and Kreedon Streets
New York City*

Bairtonia Chemical Syndicate

Drugs WHOLESALER OF THE HIGHEST STANDARD CHEMICALS
GENERAL REQUISITES FOR HOSPITALS AND SURGEONS

Maker of Balgro Hair Tonic

Hawthorne Avenue, Chicago, Illinois

Statement {

}

Metropolitan Studios

Magazine and Newspaper Advertising
Clinton Street, New York City

Etching Department

GRAND ENTERTAINMENT
GIVEN FOR THE BENEFIT OF MEMORIAL HOSPITALS

Under Auspices of the



JEDIMENS
MUSICAL SOCIETY

To be held in
ACADEMY OF MUSIC

MONDAY EVENING, SEPTEMBER SIXTEENTH

Strathmore Ornament

84 Point

3 A \$9 30 4 a \$5 20 \$14 50

BINDERS
Stone Bank

72 Point

3 A \$7 50 4 a \$4 25 \$11 75

RINGMIEN
Broad Marks

60 Point

3 A \$6 35 4 a \$3 65 \$10 00

MORPHEUS
Quaint Animal
Made Demand

48 Point

4 A \$4.00 6a \$3.50 \$7.50

LIGHT MONTH
Champion Student
Records Explained

42 Point

4 A \$3.50 6a \$2.75 \$6.25

TENOR SINGERS
Procure Caslon Type
Right Ideas Sustained

36 Point

4 A \$2.65 7a \$2.35 \$5.00

HONESTY REMAINS
Lumber Industry Thrifty
Money Quietly Produced

30 Point

5 A \$2.25 9a \$2.00 \$4.25

TIRED PIGEONS TUMBLE
Logical Players Served Knights
Competent Scholars Advanced

24 Point

5 A \$1 65 12 a \$1 85 \$3 50

IMPROVED TYPES CONTINUE
Typographical Novelty Everywhere
New Caslon Series Extensively Used
Unusual Results Obtained by Student

18 Point

8 A \$1 55 17 a \$1 70 \$3 25

HONEST POLICEMAN FOUND MONEY
Rich Gentleman Spurns Extraordinary Reward
Captains Investigate Strange Automobile Flight
Several Dignified Ladies Entertained Reporters
Expensively Gowned Maiden Becomes Excited

14 Point

12 A \$1 45 24 a \$1 55 \$3 00

IMPROVED BEAUTIFUL SOUTHERN RESIDENCE
Prominent Country Family Proposed Sensational Elopement
Unsophisticated Couple Shadowed Through Northern States
Detective Notified Headquarters After Several Days Elapsed
Quiet Homes Greatly Agitated Over Recent Bold Procedure

12 Point

15 A \$1 30 30 a \$1 45 \$2 75

DESIRE WONDERFUL STORIES
The Publisher Requires Modern Type
Diogenes Looked For An Honest Man
Simplicity Combined With Adaptability
Claims Beautiful Specimens of Printing
Always Entertain \$1234567890 Notions

8 Point

21 A \$1 10 42 a \$1 15 \$2 25

MANY UNWISE EARLDOMS REMAIN
Beautiful Reliable Printing Becomes National
Successful Under Average Model Conditions
Many Sections Where Ideal Service Abounds
Caslon Series of Type are Always Serviceable

6 Point

23 A \$0 95 47 a \$1 05 \$2 00

NEW CASLON MEANS REAL STANDARD TYPE
Practical Knowledge of the Printing Art Comes Readily
The Reliable Type Faces Are Produced by this Foundry
Handsome Cover Pages Presented to Careful Solicitors
Beautiful Natural Scenery \$1234567890 Abounds in Italy

10 Point

17 A \$1 25 34 a \$1 25 \$2 50

TRUE FRIENDSHIP NEVER BROKEN
American Company Exports to Every Nation
Material and Workmanship the Highest Grade
Designing Attractive Typographical Novelties
Business Drawing Requirement of Catalogues
Benefit for Children's Summer Vacation Fund
Heavy Rainstorm Delayed Baseball Opening

5 Point

21 A \$0 95 42 a \$1 05 \$2 00

LOGICAL ADVICE TAKEN RIGHT AIDS WONDERFULLY
The Government Inspectors Remaining Silent Prepare Sensations
Treasury Departments Which Control Large Amounts Introduced
International Questions Require Powerful Thinkers Every Time
Disabled Passenger Train Whistled for Help near Franklin Station

New Caslon in Practical Display

MEN NOTABLE FOR ORATIONS

F. DOUGLASS

MEMORIAL ASSOCIATION
NEW JERSEY

Versatile Ornament Panel Border

LONG ISLAND RESORTS

Where is the best place to go this summer? Is there a well-conducted city home in America where this welcome yet puzzling question has not awakened interest and brightened the eyes of all within range?

Now if the fourth and fifth words are accented there is only one answer — LONG ISLAND. There is no place where you can have so much comfort or such good sport as on Long Island. "Everyone knows Long Island," you say? Yes. You know there is a Long Island. You know of thousands living there. Hundreds of thousands there. But you don't realize its varied charms have brought to its hospitality many more pleasure-seekers than go to any of the other sections or resorts. Isn't it worth your while to investigate and prove the worth of such evidence yourself — by personal experience? Think and read on.

This is for those who do not know exactly what Long Island is today. Long Island is the largest island on the eastern coast of the United States — 123 miles long and from 15 to 25 miles wide, with a coast line of over 400 miles. Long Island's physical contour and geographical location are such that it receives the maximum of the ocean's cooling breezes. These remarkably steady winds in the summer come from the south, direct from the ocean — pure, life-giving and rich in ozone



FREDERICK DOUGLASS AT BUREN DECORATION DAY

FRIENDS and Fellow Citizens. Tarry here for a moment. My words shall be few and simple. The solemn rites of this hour and place call for no lengthened speech. There is, in the air of this resting-ground of the unknown dead, a silent, subtle and all-pervading influence, more touching, impressive, and thrilling than living lips do ever utter. Into the measureless depths of every loyal soul it is now whispering lessons of all that is precious, priceless, holiest, and most enduring in human existence.

Dark and sad would be the hour to this nation when it failed to pay grateful homage to its greatest benefactors. The offering we bring today is due alike to the patriot soldier dead and their noble comrades who still live; for, whether living or dead, whether in time or eternity, the loyal soldiers who imperiled all for country and freedom become one and inseparable. Those unknown heroes whose

Strathmore Ornament

RESIDENCE RESORT PLEASURE-SEEKERS TOOK LONG ISLAND

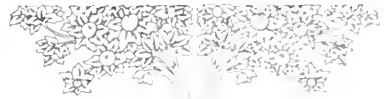

WILL BE GOOD
BREEZES
BELOW

Long Island Residence Hotels
HOUSES EVERYWHERE

Strathmore Ornament

Bramford Carving Syndicate

GERMAN : GRECIAN : ITALIAN
RUSSIAN : FRENCH : VIENNESE

Statuary

Best reproductions of all the finest creations by the hands of the best sculptors of modern times. A very extensive and a very tastefully selected array of exquisite statuary is continually kept on exhibition in our Parlors of Exhibit. This will enable the most critical and most discriminating customer to make a prompt and satisfactory selection

GOLD MEDALS SECURED FROM TWENTY-FOUR
CONSECUTIVE STATE AND OTHER EXHIBITIONS

Hushor Engines

HUSHOR MACHINES SUCCEED WHERE ALL OTHERS HAVE FAILED
THE HIGHEST POSSIBLE EFFICIENCY IN ENGINE MANUFACTURING

Hushor Automatic Friction Clutches

HUSHOR ENGINES AND AUTOMATIC SAFETY CLUTCHES HAVE SECURED THEIR
REPUTATION FROM THEIR MANY YEARS OF PERFECT AND EFFECTIVE SERVICE

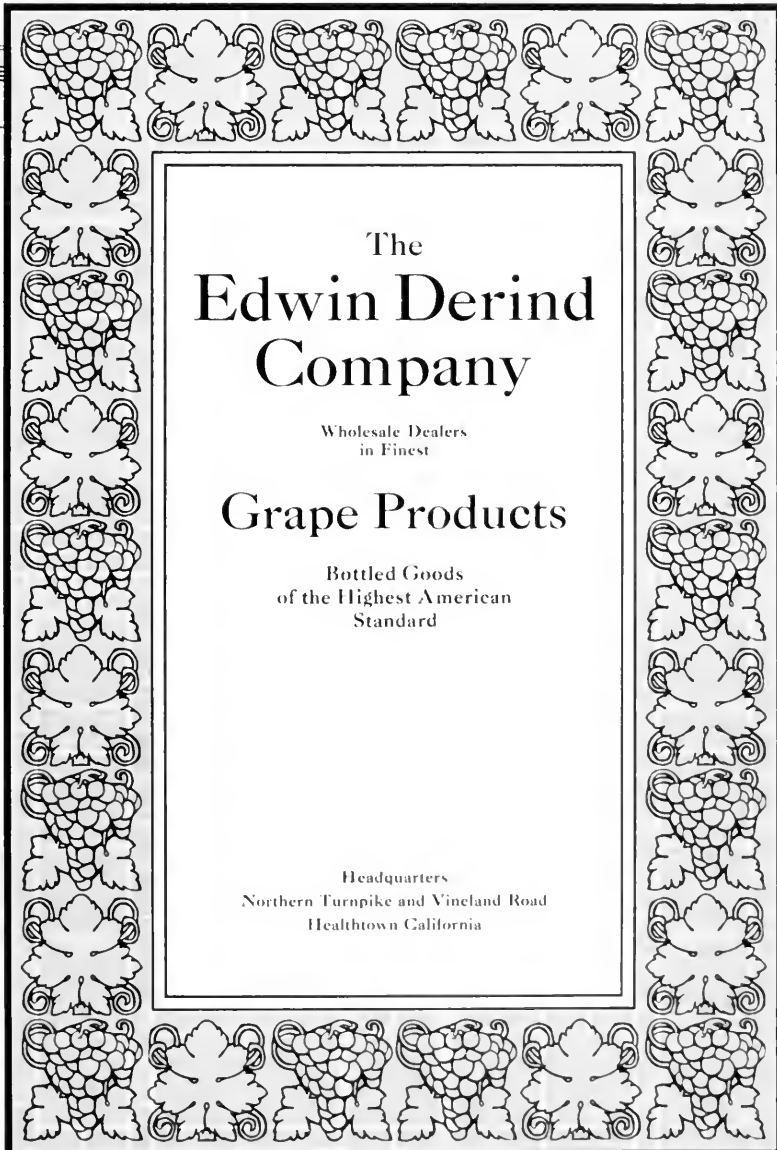

The
**Edwin Derind
Company**

Wholesale Dealers
in Finest

Grape Products

Bottled Goods
of the Highest American
Standard

Headquarters
Northern Turnpike and Vineland Road
Healthtown California

48 Point

3 A \$3 90 6 a \$3 60 \$7 50

MINERS NOTES
Students Instruction
Build Quaint House

42 Point

4 A \$3 30 7 a \$2 95 \$6 25

NEW BENCH REST
Caslon Italic New Faces
Thousands Overthrown

36 Point

4 A \$2 40 9 a \$2 60 \$5 00

EIGHT MUSKETS FIRE
Decreased Hunters Rewards
Honored Famous Statesman

30 Point

4 A \$1 80 11 a \$2 45 \$4 25

PRINTERS DESIRE ORDERS
Underworld Inhabitants Reformed
Gambler Swindles Popular Banker

21 Point

1A \$1.60 21a \$1.90 \$3.25

GRACEFUL AMERICAN DANCERS
*Broadway Musical Comedy Stars Retiring
Compositors Studying Principles of Design
Thirsty Printers Refuse to Inspect Brewery*

18 Point

11A \$1.25 22a \$1.75 \$3.25

INVENTOR LECTURED YOUNG MECHANIC
*Beautiful Characters Delighting Particular Customer
Discriminating Jerseyites Censured Aged Magistrates
Promising University Graduate Condemned Academy*

14 Point

11A \$1.25 30a \$1.75 \$3.00

SUPERIOR AMERICAN TYPE RELIEVED COMPOSITOR
*Acrobat Performed Daring Feats on Flagpole of Chicago Skyscraper
Horse Show Attracts Thousands of Most Fashionable Society Ladies
Railroad Magnates Respond Quickly to Appeal for Eighty Thousand
Job Printers Reminding Many Customers of Our New Caslon Italic*

12 Point

13A \$1.15 33a \$1.60 \$2.75

BUSY WORKERS REPORT RUMORS
*Newspaper Editors Ignored Certain Threat
Old Scientist Invited Opinions of Historian
Pythons and Lion Engage in Fierce Struggle
Tried Numerous Remedies for Tired Brain
Discovers New \$1234567890 Speed Marvel*

8 Point

17A \$0.90 51a \$1.35 \$2.25

HANDSOME DESIGNS PLEASE BOTANIST
*Granite Structure Withstanding Terrific Explosion
Able Lawyer Retained by Eccentric Young Burglar
Publishing House Ordered Complete Series of Type
Boston Inventor Perfects Wonderful New Airships*

10 Point

15A \$1.05 41a \$1.45 \$2.50

AIRSHIP LIGHTS ON AKRON BUILDING
*Lonesome Jungles Attracting Wild Game Hunters
Eastern Sculptor Received Medal From University
Systematic Investigations Revealed Startling Facts
Greatest Profits Realized From Small Investment
Famous Comedian Making Annual Farewell Tour
Gold Diggers Return Without Causing Excitement*

6 Point

20A \$0.80 60a \$1.20 \$2.00

COLORADO MOUNTAINS REACHED BY TOURISTS
*Greatest Discoveries Known to American Medical Fraternity
Eighty Copies of Heretofore Unknown Monthly Publications
Domestic Animals Stolen From Mansion of Rich Bank Clerk
Hunters Returned From Trip to Civilized Districts of Africa
Questioned Regarding \$1234567890 Stolen From Chiropractors*

5 Point

17A \$0.80 52a \$1.20 \$2.00

OCEAN LINERS WRECKED NEAR EASTERN COAST OF CHINA
*Linemen Blackmailed by Foreign Representative of Notorious Pickpocket
Stupid Blacksmith Condemns Most Beautiful Structure in Northern Jersey
Mountainous Regions Thronged With Travelers From Southern California
Generous Printer Requested Handsome Sum to Buy Charitable Institution
New Caslon Italic Bought in Large Quantities From American Type Foundry*

Modern Art Furnishings

Catalogue No. 1

*Showing for the First Time
a Complete Line of Home
Furnishings and Decorative
Materials Simply Designed
in the Modern Art Style
Among Which are Included
Furniture, Rugs, Window
and Door Hangings, Wall
Paper, Clocks, Lamps, Gas
and Electric Fixtures, Etc.*

Harper Brothers
2345 East Broad Street
Highburg

THE OFFICE BOY

O, joy supreme! Say, talk about your happy kids, well, maybe I ain't the real little cherub of sunshine. Le' me tell you the cause of all this happiness. You know how nice the weather has been lately, well, it does make a fellow feel pretty peevish when he has to stick in an office while all the other kids are out playin' ball or swimmin'. Well, day before yesterday I sure did have 'em. I felt just about as gloomy as Dr. Koch when he got that Kopenhagen report. Well, just as I was ready to do something rash, I hear three buzzes. Now, of course, three buzzes that's my signal to hot foot it into the boss' office, so I bolts in expectin' to find the next atmosphere rather chilly and I also had a hunch that I was due for a very good bawling out. But instead of t stare, there sat his nibs waitin with a big broad smile. Now the boss isn't a chronic grouch

28

The Works of
**FREDERIC
WILLIAMS**

Volume II

**Beatrice
Fowlers**

PART I

SPECIAL HAND
MADE EDITION

The Complete Works of
**James Henry
Humperdinck**

Second Edition



VOLUME XXVIII

EARLY COMPOSERS
AND THEIR WORKS

JAPANESE IMPERIAL
VELLUM EDITION

THE KIND OF MEN TO HIRE

RECIPE for picking out the best business executives furnished by a writer for a large phrenological journal, whose definition about an executive is "an indoor business man." In the hope that his rules may prove valuable to the business world generally, a few extracts are quoted: "An employer who wishes to select an indoor business man needs a person who has the vital temperament, one who also has the following faculties always present: Casualty, comparison, order, human nature, calculation, secretiveness, conscientiousness and veneration.

"The head of an indoor business man will consequently be broad in the upper part of the forehead, and

13

96 Point

3 A \$8 40 4 a \$5 10 \$13 50

RICE KING
Marked Soil

84 Point

3 A \$7 20 4 a \$4 40 \$11 60

HIRED MEN
Roast Chicken

72 Point

3 A \$5 75 4 a \$3 50 \$9 25

SPRING POEM
Unmasted Ships

60 Point

3 A \$5.00 1 a \$3.10 \$8.10

HUNTS MINERS
Secret Names Lost

48 Point

3 A \$3.20 6 a \$3.05 \$6.25

PRINTERS REFUSED
Display Caslon Quality

42 Point

4 A \$2.60 8 a \$2.65 \$5.25

TRUSTED MEN SIGNED
Demand Condensed Caslon
Nearly Perfect Expositions

36 Point

4 A \$2.10 8 a \$2.15 \$4.25

MODERN TERMS GRANTED
New School Geography Printed
Utilitarian Artistic Caslon Face

30 Point

6 A \$2 00 11 a \$2 00 \$4 00

SECURED AMBITIOUS WORKERS
Effective Advertising Material Shown
Mechanical Perfection Here Attained

24 Point

7 A \$1 65 15 a \$1 85 \$3 50

UNIFORMED ENSIGN ORDERS RETURN
Harmonious Proportions Universally Praised
Musicians Discourage Beautiful Cornet Player

18 Point

12 A \$1 60 22 a \$1 65 \$3 25

SPECIAL NOVEMBER SALE
Most Popular Condensed Face
Nicely Displays Good Features
Printers Prefer American Type
Useful Member Caslon Family

10 Point

21 A \$1 20 42 a \$1 30 \$2 50

PROSPEROUS KINGDOMS EXISTED
Newspapers Demand Caslon Condensed
Modern Compositors Fervently Praised
Fine Productions with Modern Material
High Grade Printing by First-Class Men
Pleasure and Profit in Modern Printing
New Type Made Composition Enjoyable
Printers and Customers Highly Pleased

14 Point

15 A \$1 40 30 a \$1 60 \$3 00

PRINTS MODERN ADVERTISING
Fine Engraving House Complimented
Old American Letter Press Specimens
Publishers Revise Subscription Rates
Journeyman Print Masters Obstacles
The Most Fastidious Dresser Satisfied.

8 Point

24 A \$1 10 46 a \$1 15 \$2 25

ENTERTAINED THOUGHTFUL GENTLEMEN
Second Monthly Reunion of the Oldest Inhabitants
Contributing Member Received Many Inducements
Honorable Lawyers Encouraged by Recent Lecture
Beautiful Edition Completed and Delivered Sunday
Conservative Diplomat Makes Ridiculous Remarks
Secretary Declined Renomination After Discussion
German Band Playing Popular Music Near Factory
Descriptive Circulars Mailed to Prospective Buyers

12 Point

19 A \$1 35 38 a \$1 40 \$2 75

REAL DELIGHTFUL MYSTERY SOLVED
Require Absolutely Honest and Careful Printer
General Praise Secured From City Publishers
National Advertisers Endorse American Type
Also Other Prominent Expert Advertising Men
American Type \$1234567890 Founders Face

6 Point

26 A \$0 95 52 a \$1 05 \$2 00

SIMULTANEOUS AND POSITIVELY UNAVOIDABLE
Printers Required New Materials to Replace the Old Worn
Out Supplies on Hand, and, as the Aim Ever Had Been to
Produce Distinctive Printing, Naturally, When Ordering
New Material, New and Modern Designs Were Selected to
Displace the Old-Fashioned, Out of Date Goods on Hand
The Demand for Originality and Distinctiveness of Design
In Printing was Originally Made and Naturally Insisted on
By Manufacturers and Advertisers of National Reputation
Whose Experience Has \$1234567890 Its Advertising Value

The Portland

Multiple Punching Machine

HOLES punched any distance apart from $1\frac{1}{8}$ to 24 inches. Any number of holes punched at once, to full capacity of machine. An endless variety of punching, and absolutely accurate. Very rapid. Best system of gauges yet devised; two micrometric back gauges which can be set in any desired position and adjusted to the hundredth part of an inch. Specially constructed side gauge allows use of full length 30-inch table. Graduated rule, 30 inches long, is inlaid in table. Drawer under punches, into which paper punchings drop, preventing litter around the machine. Fourteen sizes of round punches furnished from three thirty-seconds of an inch up, graduated by thirty-seconds

Foot-power with side gauge and micrometric back gauges. Is also supplied with steam fixtures and noiseless power clutch, another of the new and original features of this remarkably efficient machine

For full particulars and prices inquire of any branch of the

Not only is the first cost of these machines very much less than other multiple punching machines, but the price of punch heads is also a great deal lower. Any size and style of punch head made to order on short notice. When you purchase a "Portland" you make a large saving and continue to save every time you add a punch head. You could not purchase a better punching machine than the "Portland" if you paid twice as much for it. This is a generally recognized fact

American Type Founders Co.

FIFTIETH ANNUAL SALE OF

"Bubrand" Scarfs

CONSISTING OF MANY NEAT AND NOBBY
DESIGNS FOR THE CRITICAL CUSTOMER

Fifteen hundred fine scarfs, variety of which is great, embracing eight plain colors, an almost endless combination in stripe and neat effects on dark and medium grounds. This stock is made of best domestic and imported silks in reps, satins, amures and surahs. An ideal assortment affording a very wide range of selection. When you examine these scarfs, take particular notice that they have the wide, open ends. They are a manufacturer's stock, and made to sell at prices from 50 cents to \$1.00

Economy in price has not been offset by economy in material. These scarfs are in every respect all that we aver. They are the best value in this city today at

25c

MONK & SIREN

CORNER SEVENTEENTH AND HENRY STREETS

Ned Hartmain Printery

ENGRAVER
PRINTER
BINDER

The few circulars sent forth from this modern printing office merely made known its aim and purpose. It was too early then to speak with authority of its accomplishments and cite reasons why you should grant it favor or patronage. The sturdy ideal for which it stands has met success from the very outset and we have had three years as one busy season. In this time we have executed our work in such a manner that we feel proud, and contained in our books of samples are many interesting specimens of good printing. The object of this effort is to establish closer relationship with all our friends and patrons here

Telephone
Number
124-M



The Model Shop

LOCATED AT HELM STREET
AND BELMONTER AVENUE

Art Ornament 120001

Printing

UNRIVALED FACILITIES ENABLE
US TO GUARANTEE OUR QUALITY
AND IT ACCOUNTS TO NO SMALL
DEGREE FOR THIS REMARKABLE
SUCCESS IN PLEASING EVERYONE

MENHER
PRINT SHOP

The kind you ought to use and when you ought to have it, that is when you really need it. We have contracted the habit of satisfying all our customers. Our work as a business getter is of the highest quality

The ECHO



Volume IX

Number 14



SPECIAL FEAT

ARTICLES BY HENRY J. NORTH



THE publishers of Echo desire to announce to their readers that they have secured the services of Henry J. North, one of the most noted writers of the present-day conditions in the industrial world. Mr. Northampton will run a series of articles dealing with his own personal experiences in some of the large mills throughout the country. This gifted writer has a style that is interesting, and holds the reader throughout. His wide-range of experience enables him to deal with this subject in an intelligent and entertaining manner, and at the same time prove very i



THE ECHO PUBLISHED
No. 279 Market Street, CHICAGO

Versatile Mortised Initial Panel Border

An Ideal Vacation

Beach House

LOCKPORT, MAINE



HARKINS & BURTON

PROPRIETORS

Heavy Caslon

84 Point

3 A \$9 45 4 a \$5 30 \$14 75

FINDERS
Hold Firm

72 Point

3 A \$7 70 4 a \$4 40 \$12 10

KITCHENS
Decide Race

60 Point

3 A \$6 70 4 a \$3 50 \$10 50

SMOULDER
Honors Given
Sending Dime

Heavy Caslon

48 Point

3 A \$1.45 5 a \$3.05 \$7.50

REIMBURSING
Entertain Binders
Securing Material

42 Point

3 A \$3.30 6 a \$2.95 \$6.25

MODERN CITIES
Remains Handsome
Claims Best Quality

36 Point

4 A \$2.80 6 a \$2.20 \$5.00

PRESIDING KNIGHT
Harmonious Decoration
Distinctly Characteristic

30 Point

5 A \$2.20 9 a \$2.05 \$4.25

MENTIONED CHILDREN
Produced Handsome Printing
Remunerative Considerations

Heavy Caslon

24 Point

6 A \$1 85 10 a \$1 65 \$3 50

DETERMINING INSTRUCTION
Conventional Shouters Disembarked
Including Delightful Entertainments
Manufacturer Solves Great Problem

18 Point

8 A \$1 55 16 a \$1 70 \$3 25

HONORED PROMISES RECEIVE NOTICE
Balmy Spring Weather Delighted Our Printers
Neater Display Rewards User of Heavy Caslon
Gives Sensational Musical Performances Again
Several Boisterous Cowboys Returned Monday

14 Point

12 A \$1 45 23 a \$1 55 \$3 00

REIMBURSED PRESIDENT SAILING FOR EUROPE
Beautiful Specimens Reward Users of this Practical Series
Heavy Railroad Engine Climbed Mount Royal Every Hour
Fashionable Society Entertains Visiting Dukes From India
Great National Sport Opens on Westminster Cricket Field

12 Point

14 A \$1 30 29 a \$1 45 \$2 75

MAINTAIN SUPREME QUALITY
Requirement Sometimes Nonsensical
Observe Dignity in this Lovely Series
Received Large Orders Every Month
Demands \$1234567890 Satisfaction

8 Point

19 A \$1 10 38 a \$1 15 \$2 25

DETAILS DISTINGUISHED NUMBER
Scientist Claims Most Original Discoveries
A Type Combining Usefulness With Beauty
These Liberal Font Schemes Help Printers
Interesting Historians Granting Interviews
Little Cubes of Metal, Little Tubes of Ink
Brains and Printing Make Hundreds Think

10 Point

16 A \$1 20 32 a \$1 30 \$2 50

RICHEST MERCHANDISE SECURED
Very Delightful Excursion Made by Tourist
Recreation Made Healthy and Athletic Men
Exact Measurements Required by Owners
Hunting District Reserved for Many Years

6 Point

20 A \$0 95 40 a \$1 05 \$2 00

THE WORD UNIQUE MORE DESCRIPTIVE
This Modern Series of Caslon Faces is Superior
Pleasing Advertisers by Strength and Legibility
Stupendous Profit Sharing Concerns Organized
Best Technical Education Absolutely Required
The Rehearsals of Many Dramatic Speculations
Indestructible \$1234567890 Dignified Materials

THE
**HARMONIC
PIANO**



Catalogue Number One

**AN INSTRUMENT BUILT
ON HONEST PRINCIPLES**



Harmon Company

52 Oak Street, Dells, Ohio

BRANCH SALESROOMS

New York	Chicago	Boston	Cincinnati
Portland	Tacoma	Seattle	Spokane
Philadelphia	Los Angeles	San Francisco	

Overcoats \$25 up
Suits \$19 to \$40



Behmard Store

48 East Broadway

Thoroughmade Clothes are like a Thoroughbred Horse

Back of each there must be a strictly unblemished pedigree without which there is neither the thorough breeding of a horse nor the thorough making of clothes. Strip check-rein and trappings off an ill-bred horse and straightway he droops into dispirited cobship. Put an ill-made suit on a live man and send it through a rainstorm, and it wilts into forlorn swathing. When a man makes a purchase of clothing he should be sure that the garments are backed by a real pedigree—blue-blooded clothes

Versatile Ornament



American Type
Foundry Company

LEADER OF FASHIONABLE TYPE STYLES

The type, borders, ornaments and other printing materials made by this Company excel in design, and their durability is assured by practical use of the best ingredients for their respective requirements. The printing office equipped with its productions is worth more for either use or sale than one made up from the materials of incomplete type foundries

Twentieth Century Ornament

A Virile Story of Wild Life



By H. B. GREN

IN the Alaskan goldfields Gren has shared the wilderness life of hunters, ranchmen, hostile Indians and Mormons. His hero is saved from a lone death in the desert, rides, fights and loves with the people who have so gallantly taken him in. Their leader, the giant patriarch of the vast Purple Desert, is more typical of his time and place than any character in fiction. The earnest taming of the wild horse Silvermane, the quest for Mescal, the young girl of the sunset, through mirage and sand storm, are but two of the many thrilling events in its very finely written and illustrated chapters

Copyrighted and Published solely by
MARSDEN PRINTING COMPANY

Versatile Ornament

THE CORN NATIONAL

HABIT is the strongest link in the chain of life. To the twentieth century philosophers life is not so much a matter of destiny or environment as it is a matter of sequence. Man is a creature governed by habit. What you do to-day determines what you will be to-morrow. Form the Saving Habit now. The Corn National conducts a special department for the

smaller depositor cent interest if th
A savings accoun
mean no more th
guaranteed to giv
home protections
youth when your
children are then
in business or in
banking in this w
Corn National wi
directors are will
most extensive n
saving habit then
appropriate and t
so you can plainl
up to you to com
small amounts to
and beyond ques
men of repute an

CORN
PAYS TWO PER CEN
NORTHERN

OUR SUMMER LIFE Our Bird Friends out in the Garden

HOW we all love the first breath of spring. Then we are reminded of the many bright days that are coming. When spring has actually taken form and separated herself from the mists of melting snow, bringing Pandora's own box of mysteries for luggage, even the garden owner who has ceased to expect the miraculous to happen suddenly becomes alert, and is continually in the attitude known as nose to the wind in the lore of the wild. Which of the earth tribe that live by root, bulb and seed has survived the long winter? Who of the winged company have safely passed the perils of flight through storms and unfriendly lands? We walk along the paths and into the garden of our summer home and find answers on every side. Nesting places there are galore in tree, bush, briar-patch, and well-contrived houses that are gladly welcomed by our bird friends. Shed-beams are here for the Phoebes and snuggeries for House Wrens, a heap of cedar brush in farm land if the Carolina Wren is home-hunting; the Robins will find many home sites among the trees and roof nooks. A fine group of spruces on a knoll above the pool where in early spring the first peep of the Hyla is heard



72 Point

3 A \$8 80 4 a \$5 10 \$13 90

TINKERS
Bonds Sold

60 Point

3 A \$7 70 4 a \$4 45 \$12 15

SOLDIERS
Hand Caster

48 Point

3 A \$5 00 4 a \$2 90 \$7 90

HOT SPRING
Delights Crowd

36 Point

3 A \$2 65 6 a \$2 35 \$5 00

SOUGHT PRINTER
Lithographic Printers
Sleighs Manufactured

Litho Roman

30 Point

4 A \$2 15 8 a \$2 10 \$1 25

NOTHING IS PERFECT
The Famous Litho Family
Most Useful for the Printer

24 Point

5 A \$1 85 9 a \$1 65 \$3 50

DEMOTHUS IS DELIGHTED
Annual Exhibition of Machinery
Economic Convention Adjourns
Decorous Sobriety and Restraint

18 Point

8 A \$1 70 14 a \$1 55 \$3 25

DEMURE MAIDEN
The Mischievous Boy
Grenadiers Advancing
Five Hundred Dollars

10 Point

15 A \$1 25 28 a \$1 25 \$2 50

EXHIBITION OF FRUITS
Choice Opportunity in Cities
Many Interesting Anecdotes
Unsophisticated Campaigner
Thrilling Adventures of Jack
The Hero of the Sunken Ship

14 Point

11 A \$1 50 21 a \$1 50 \$3 00

MOUNTAIN SCENERIES
Plumbers Investing Money
Received Golden Souvenir
Subscribers Want Premium

8 Point

18 A \$1 15 34 a \$1 10 \$2 25

THAT LOWER CASE FEATURE IN
Litho Roman Makes it Doubly Useful
Often a Line and Sometimes the Entire
Job Can be Made More Pleasing by the
Use of Lower Case. Then, too, Lower
Case and Capital Letters Together are
More Legible Than Upper Case Alone

12 Point

13 A \$1 35 26 a \$1 40 \$2 75

THE CRITICAL STUDENT OF
Letter Design is Assured Sincere
Showing in American Specimens
Even Casual Letter Spacing May
Certified \$1234567890 Shares

6 Point

20 A \$1 00 38 a \$1 00 \$2 00

BANKER ERECTS MODERN BUILDINGS
Pleasing Effects Derived from American Type
Neat Work Always Assured With New Faces
Many Studious Mechanics Received Mention
Specimens of Desirable Standard Line Types
Good Results Obtained With Proper Material
Original Features Highly Endorsed by Critics
One Hundred Passengers Lost in Shipwreck
Figures Custom \$1234567890 Uniform Body

DIPLOMA

Bonto School of Typographic Design

FOUNDED BY PAUL RENAN
ART EDITOR OF THE BASKERVILLE ART MAGAZINE

This is to Certify that Mr. _____
has completed the Correspondence Course in Art Printing with such
excellence as to merit the endorsement of this institution as a fully
qualified and entirely competent

TYPOTECT

In Witness Whereof, we hereby subscribe our names and affix the Official Seal of the
Bonto School of Typographic Design, this _____ day
of _____ 19____ in the State of Massachusetts

SEAL

President

Secretary

Special Show Days for Fall

HAVING received large shipments of new goods purchased in New York last month, we desire to announce Wednesday, Thursday and Friday, October sixth, seventh and eighth, as formal Display Days in our Ready-to-Wear Department. On these three days it will be our pleasure to present for your consideration the most comprehensive exhibit of this season's modes in Best Fur Lined Empire and Paddock Coats, Fur and Feather Neck Pieces, Wash Silk and Cotton Tailored and Lingerie Waists, Street and Dress Skirts, Fine Tailored Street Suits, Negligee house Garments, Misses' and Children's Coats. The Kistler Store has long been recognized as the fashion center of South Olean, and in this special showing we are not going to display anything but the very latest in

thus retaining all styles ladies will appreciate a attention has been given were it not for this one hion of New York City

WE RESPECTFULLY REQUEST YOU AND YOUR FRIENDS TO VISIT THIS STORE ON DAYS DEVOTED ENTIRELY TO THIS SPECIAL SHOWING. LIGHT LUNCH WILL BE SERVED IN THE WAITING ROOM ON THE THIRD FLOOR



WILL OPEN STORE ON ALL EVENINGS

er Department Store
on Street, South Olean, New York



SPRING PARK CLUB

The New Tennis Courts and Bowling Alleys at the Club are now completed and open to all members of the Spring Park Club and their families or friends. Every effort has been put forth to assure the success of this new feature, and everything has been so provided that the Club will prove a great attraction this coming season. This feature, combined with all the house privileges, makes a membership in this Club desirable, and it is hoped that all the members and friends will take such advantage of this out-door feature as will justify the addition of other and more extensive attractions

FRIDAY
JUNE SECOND

Versatile Ornament Uniform-Rule Cast Corners

RIO HIGH SCHOOL

RIO, TEXAS

TO STRENGTHEN MUTUAL CONFIDENCE BETWEEN TEACHERS AND PARENTS, TO STIMULATE GREATER SYMPATHY AND HARMONY BETWEEN THEM, THE NEW FACULTY OF RIO HIGH SCHOOL CORDIALLY REQUEST YOUR PRESENCE AT A RECEPTION TO BE HELD IN THE WEST WING, FRIDAY AFTERNOON, FROM ONE UNTIL FOUR O'CLOCK. SPECIAL MUSIC

MISS ROBIN WILLIAMS

TITLE LITHO ROMAN

60 Point

3 A \$8 50

PRINTED

54 Point

3 A \$7 20

MENDERS

48 Point

3 A \$5 50

PROMOTER
RAMBLERS

42 Point

3 A \$4 50

COMPOUNDS
GRUMBLING

36 Point

4 A \$3 75

RODS BROKEN
SMOKE HOUSE

TITLE LITHO ROMAN

30 Point

5 A \$3 00

**BRIGHT STUDENT
EASTERN FRIEND**

24 Point No. 2

6 A \$2 50

**INHERITED MANSION
SOUND UNIVERSITIES**

24 Point No. 1

7 A \$2 50

**MEGAPHONE CONDEMNED
SHOWING NOBLE ROMANS**

18 Point No. 2

8 A \$2 00

**DISREGARDING
RACKS BOUGHT**

8 Point No. 2

16 A \$1 25

**MANY BOYS LEAVE FARM
DISTINCT LITHO QUALITY
ENTHUSIASTIC AUDIENCE
DETERMINED STATESMEN**

18 Point No. 1

10 A \$2 00

**NOTES EMPHASIS
GOLDEN QUALITY**

8 Point No. 1

20 A \$1 25

**RECORD BREAKING ATHLETES
HUNTING LIONS IS DANGEROUS
DURING THE SEVENTH SEASON
SATISFIED THE ART PRINTERS**

14 Point

11 A \$1 75

**NATURAL HISTORY
CHECK NUMBERED**

6 Point No. 4

20 A \$1 00

**THE EFFECTIVE AND PROGRESSIVE
MANY ENERGETIC PRINTERS WISELY
EDUCATING THE PUBLIC TO A BETTER
APPRECIATION OF QUALITY IN FACES**

12 Point

12 A \$1 50

**AMERICAN LINE TYPE
ORNAMENTS ARTISTIC**

6 Point No. 3

23 A \$1 00

**PUBLISHERS WHO NEGLECT THE STUDY
OF GOOD TYPOGRAPHIC STYLE ARE NOT
ON TO THEIR JOB. THOSE WHO PLACE THE
GREAT ADVERTISING CONTRACTS, ALSO**

10 Point

15 A \$1 40

**COMPETENT ADVERTISERS
BURGLAR BADLY INJURED**

6 Point No. 2

26 A \$1 00

**WHEN ANYTHING IN STYLE GETS ESTABLISHED
IN PRINTING SHOPS THERE IS SURE TO BE SOME
REACTION. PRINTING BUYERS OF TODAY WANT
VARIETY IN THEIR WORK AND THE UP-TO-DATE**

9 Point

15 A \$1 25

**SEVENTH ANNUAL RECEPTION
USEFUL \$1234567890 FIGURES**

6 Point No. 1

30 A \$1 00

**THE HOPE OF THE PRINTER FOR BETTER PRICES WILL
BE REALIZED GRADUALLY BUT VERY POSITIVE BY THE
PUBLIC BECOMING MORE FAMILIAR WITH TYPE FACER
ORIGINAL DESIGNER BISSIER7890 AND ILLUSTRATIONS**

72 Point

3 A \$6 75 4 a \$3 95 \$10 70

SUPERFINE
Great Demand
Making Plates

60 Point

3 A \$5 95 4 a \$3 45 \$9 40

PRODUCTION
French Brokers
Northern Home

48 Point

4 A \$4 15 6 a \$3 35 \$7 50

KNIGHT ELOPED
Humble Actor Tried
European Physician

36 Point

4 A \$2 40 9 a \$2 00 \$5 00

HONORABLE MENTION
Modern Engravers Beguiled
Tasty Printer Desired Litho

30 Point

5 A \$2 00 11 a \$2 25 \$4 25

CRITICS INFLUENCE YOUTH
Oldest Detective Given Preference
Recognize Superior Cover Designs

24 Point

6 A \$1 75 13 a \$1 75 \$3 50

STRIKING MODELS MERIT HONOR
Faces Having Many Points of Superiority
Particular Printer with Elated Customers

18 Point

10 A \$1 60 20 a \$1 65 \$3 25

WONDERFUL SCHOLAR
Advertising Seven Bargains
Enjoys Ride to Coney Island

10 Point

18 A \$1 20 36 a \$1 30 \$2 50

SIMPLE MAIDENS REHEARSE
Quiet Place Near Beautiful Mansion
Refreshing Breezes of North Shores
Children Amused Pioneer Merchant
Honest Dealer Contradicting Banker

14 Point

14 A \$1 45 28 a \$1 55 \$3 00

JUSTIFY EACH LINE IN YOUR
Stick and Thereby Become Popular
With Our Big Enemy, the Stoneman

8 Point

22 A \$1 10 44 a \$1 15 \$2 25

ORNAMENTATION PRIMARY INSTINCT
Harmonious Color Schemes Decorating Papers
Productions That Mark an Epoch in the Trade
History of Printing Points Out Some Abilities
Work of Deft Hands Guided by Studious Heads

12 Point

17 A \$1 35 34 a \$1 40 \$2 75

PLEASING DESIGN READILY SOLD
Advertisers Demand Original Composers
The Accurate \$1234567890 Anvil Finished

6 Point

24 A \$0 95 48 a \$1 05 \$2 00

FUNDAMENTAL PRINCIPLE OF TYPOGRAPHY
Workman Intuitively Composed Artistic Combination
Zehras and Elephants Amused Children at the Circus
Some Entirely Suitable Designs Thoroughly Satisfying
Great Scientific \$1234567890 Preparations Discovered



BRONZE MASTERPIECES

SOME years ago we started an effort to popularize in this city the best bronze work of America and Europe, and we now offer for your critical inspection the results of a carefully selected collection of masterpieces in sculpture of bronze of both American and foreign artists. These works are entirely original and have been highly commended by connoisseurs and art collectors both in this country and abroad. This exhibition is now in progress on the seventh floor and is the most notable one of its kind that has ever been held in America. The real significance of the present revival in bronze statuary will be at once apparent to the observant visitor at this exhibition. A visit from you will afford us much pleasure

To those of our patrons who are interested in this exhibition and find it inconvenient to attend in person, we have prepared a finely illustrated booklet which will be mailed on receipt of their address

Wayside Ornament



THE LINCOLN AERO CLUB KANSAS CITY, MISSOURI

Desires to announce to its friends and the public in general that many of the most prominent aviators of the country have been secured to compete in the semi-annual tournament of the club on

Governor's Day

at the Missouri State Fair Grounds at Austin. This event promises to outdo anything of its kind ever attempted in this part of the United States. Special arrangements for facilitating travel is in the hands of a competent committee

RUTHERFORD J. MASON
Recording Secretary

Aerial Cut

ABSOLUTELY BURGLAR PROOF

Safety Lock Boxes

A GOOD PLACE TO LEAVE YOUR JEWELRY WHILE ON YOUR VACATION TRIP



Local and Long Distance
Telephones

The Boston Safety Co.
NEW LONDON, CONN.

Versatile Border

J. HENRY BROWN
PRESIDENT



JAMES M. SMITH
MANAGER

BRUSHTON PAINT COMPANY

EXCLUSIVE MANUFACTURERS OF

CROWN BRAND WHITE LEAD

PAINTS, OILS AND VARNISHES

Charlestown, Maine

ANNUAL STATEMENT
JUNE FIRST

Hudmor Banking Company

DEPOSITORY
FOR THE COUNTY
OF HUDSON

Capital and Surplus
\$580,000

INTEREST PAID ON DEPOSITS
SAFE DEPOSIT BOXES

Exhibition of Silverware and Cut Glass

The Burdock Company would respectfully call the attention of its patrons to a collection of silverware and cut glass, designed by and made under the direct supervision of Jean Renau, member of the Standard Academy of Design. This fine collection will be on exhibition, for a limited time only, at our Exhibit Hall on Second Avenue. The array will consist of spoons, forks and serving pieces, tea services and dinner ware, trays and bowls, etc. Cut glass decanters, whiskey jugs, and silver mounted vases, etc. Card cases, cigarette and cigar cases, pocket knives, match boxes and desk fittings.

The Burdock Co.
San Francisco

ORCLIN

DANIEL BEARING

DRAND JEWELRY SHOP
EAST MAIN STREET
PORTLAND

Hedan Investment Company

DEVELOPING AND OPERATING

Mining Properties, Timber Tracts
and Coal Lands

MAIN OFFICES
CANTON BUILDING

WASHINGTON, D. C.

60 Point

3 A \$6 75

RENUMBER

54 Point

4 A \$6 50

SEIZE BRIDE

48 Point

4 A \$5 00

HUNT MINERS

42 Point

5 A \$4 50

SECURE KNIGHT

36 Point

5 A \$3 75

**STRONGER DESIGN
VERY FINE SERIES**

30 Point

6 A \$3 00

**REQUIRED PRINTINGS
SELECT MODERN TYPE**

CONDENSED TITLE LITHO

24 Point No. 2

8 A \$2.50

UNINTERESTING SPECIMEN
PLEASING BEAUTY DOCTOR

24 Point No. 1

9 A \$2.50

ERECTING HANDSOME BUILDINGS
PRINTS CHARMING AND DISTINCT

18 Point No. 3

11 A \$2.50

BANQUET SEVERAL HONEST TINKERS
GRAND REUNIONS HELD FREQUENTLY

18 Point No. 2

13 A \$2.00

THE AMERICAN TYPE FOUNDERS COMPANY
MODERN DESIGNERS RECEIVED STUDENTS

18 Point No. 1

15 A \$2.00

GRANT FIRE FIGHTING HERO DIAMOND MEDAL
DISCARD YOUR BROKEN AND WORN OUT SERIES

12 Point No. 5

16 A \$1.50

VERY FINE SPRING MORNING
SUN CAUSES MUCH ANXIETY
COLDEST \$1234567890 WINTER

12 Point No. 1

29 A \$1.50

SIGHTING TORPEDO BOAT DESTROYER
CRUISER BROKE THE SPEED RECORDS
DEMOLISHED HANDSOME STEAMSHIP

12 Point No. 4

20 A \$1.50

MADE WORLD-WIDE REPUTATIONS
CHANGE VOTING DISTRICT OFTEN
STYLISH NOVELTIES ORIGINATED

6 Point No. 4

25 A \$1.00

MERCHANT HAS OCCASIONAL COMPETITION
PURCHASE WONDERFUL AUTOMOBILE COVER
RICH MERCHANT RETURNED WITH PICTURES
NEGOTIATES \$1234567890 INSURANCE POLICIES

12 Point No. 3

22 A \$1.50

STRONGLY BUILT MAN COMING HOME
DISTRIBUTING DEAD TYPE PROMPTLY
BOLD SAILOR GRANTED SHORE LEAVE

6 Point No. 3

28 A \$1.00

ABSOLUTELY VALUABLE PREMIUMS PRESENTED
SPECIAL ATTENTION REGARDING INSTRUMENTS
STRONG LETTER FOR THE GENERAL JOB PRINTER
IT BRINGS RESULTS IMMEDIATELY WHEN SHOWN

12 Point No. 2

24 A \$1.50

EXPOSITION STARTED WITH GREAT HOPE
TOURIST ENTERTAINED VAST AUDIENCES
CAREFUL COMPOSITOR OBTAINED NOTICE

6 Point No. 2

32 A \$1.00

EVERY CONTRACT RELATING TO SUBWAY WAS BLOCKED
INNOCENT BACHELOR DEPLEDRES BIGAMY ACCUSATIONS
GOVERNMENT INSPECTORS ACQUIRE GREAT KNOWLEDGE
INTERNATIONAL QUESTIONS ARDUSED MANY DIPLOMATS

6 Point No. 1

38 A \$1.00

PAUSE HERE AND GIVE YOUR OFFICE TOWEL A JERK AND BUY LITHO
REMEMBER THIS TYPE ALWAYS PLEASURES THE CRITICAL CUSTOMER
MACHINERY OF ALL KINDS BOTH NEW AND REBUILT AT BRANCHES
WEIGHT FONTS AT BOLD TYPE PRICES SAVING TO LARGER BUYERS

Bold Litho

48 Point

3 A \$6 10 4 a \$3 70 \$9 80

HIER SONG
Big Returns
Distributing

36 Point

3 A \$3 40 4 a \$2 00 \$5 40

BUST MODERN
Expensive Habits
Great Importance

30 Point

3 A \$2 45 5 a \$1 80 \$4 25

DESIGNS MODERN
Beautiful Homestead
Remarkable Printers

24 Point

4 A \$1 75 8 a \$1 75 \$3 50

REPEATED QUESTION
Certain Political Situation
Large Theatre Demolished
Appoints Special Delegate

Bold Litho

18 Point

6 A \$1.90 12 a \$1.65 \$3.25

**HIRES STRONGER MUSICIAN
Showing Greater Remunerations
Review Fashionable Department
Fourteenth Individual Questions**

14 Point

9 A \$1.50 16 a \$1.50 \$3.00

**CONSTRUCTED SPLENDID BUILDING
Handsome Metropolis Discovered Monday
Enterprising Printers Form Organizations
Speakers Defending Greatest Fortification**

Rates, \$2 Per Day

Best Table in Reno

Jackson Hotel

Established 1881

Charles Roscoe,
Proprietor

RENO CITY, PA.

**Bold Litho is the
Best Face for any
plate work that is
more or less of a
display nature. It
will please many**

12 Point

11 A \$1.30 22 a \$1.45 \$2.75

**TYPE SPECIMEN BOOKS
Unsurpassed Performances
Many Advertising Problems
Pleasing Designs in Borders
Rules \$1234567890 Figure**

8 Point

14 A \$1.10 28 a \$1.15 \$2.25

**FORM GORGEOUS PARADE
Holiday Tours to Old Cape Cod
Secretary Holly Opposed Talk
Bargains in Summer Clothing
Florida is the Land of Flowers
Detective Methods are Modern**

10 Point

12 A \$1.20 23 a \$1.30 \$2.50

**DISCERNING COMPOSERS
Owner Selecting Combination
Realistic and Delightful Story
Special November Convention
Display Many Litho Qualities
Girl Withdrew Every Promise**

6 Point

15 A \$0.95 30 a \$1.05 \$2.00

**SPLENDID FORM RECOGNIZED
Mendicant Janitors Denounce Organ
Continental Explorations Rewarded
Return from Battlefield of Santingo
Discovered Roadbeds for Carriages
Examinations by the General Public
Strived Earnestly for Improvements
His Kingly \$1234567890 Splendors**

Litho Bold and Light Copperplate Gothic

WILLIAM M. BOSKIN

PHILIP H. SHERMAN

BOSKIN & SHERMAN

WHOLESALE AND RETAIL DEALERS IN

GRAIN AND PROVISIONS

FARM PRODUCE

CENTER AND MORAN STREETS

NEAR THE OLD BURDEN MILL

HOME TELEPHONE 27
LONG DISTANCE 2738

JOHNSTOWN, GA.

WILSON P. HARRIS, PRESIDENT
GEORGE C. JIMSON, SECRETARY

WM. BROMLEY, VICE-PRESIDENT
CLAUDE WILLARD, TREASURER

HARRIS & JIMSON

Printers and Binders

Designing, Writing and Printing of Fine
Advertising Literature

PETER S. KILBOURNE
REPRESENTATIVE

23-24 BUXTON BUILDING
DALLAS, TEXAS

STATEMENT

Morningland State Bank

For the Year Ending
June Eighteenth



OFFICERS

THOS. B. WINCHELL, PRESIDENT
ROY H. WILLIS, VICE-PRESIDENT
LAWRENCE W. MCKIM, CASHIER

Capital Stock \$500,000.00
Surplus 56,275.00

Versatile Ornament

The Annual

Anchor Club Boat Race

HELD IN CONNECTION
WITH THE

Independence Day
Celebration



Beardstown, Illinois
July Fourth

Versatile Ornament

GEORGE BRADSON, President

MAURICE ROBERTSON, Secretary

EDWARD CHESTER, Treasurer

George Bradson & Company

WHOLESALE DEALERS AND BROKERS IN

Lumber, Grain, Hay and Coal

Directors

CORNELIUS READE - New York
ROBERT REDDIN - San Francisco
FREDERICK SMITH - Milwaukee
JOHN KNOWLES - Providence

HAROLD GRAHAM - Spokane
THOMAS KETTEL - San Francisco
ARTHUR BARNES - Detroit
STEPHEN THURSTON - New York

OFFICES LOCATED AT

Spokane and New York

No.

National Bank

OF THE CITY OF CHAMBERSBURG

Chambersburg, N.J.

General Office Supplies

Rubber Stamps and Seals

Branburg & Drumond

Commercial and Society

Printing - Engraving

Embossing - Designing

Pay to the Order of

\$

871 EAST MAIN STREET

DEANSBURG, COLORADO

Busha Ornament

48 Point

3 A \$4 75 4 a \$2 75 \$7 50

SEND BRICK
Retired Soldier

42 Point

3 A \$3 65 5 a \$2 60 \$6 25

SINGED RIDER
Kitchen Musician

36 Point

3 A \$2 65 6 a \$2 35 \$5 00

MERINOS
Great Band

10 Point

15 A \$1 20 30 a \$1 30 \$2 50

ELECTRIC MACHINERY
Grecian Philosopher Expires

8 Point

18 A \$1 10 35 a \$1 15 \$2 25

FAMOUS HISTORICAL PRINTER
Proposing Typographical Researches
Annually Instructing College Toilers

30 Point

4 A \$2 15 8 a \$2 10 \$4 25

MEN BRING
Roman Herds

6 Point

20 A \$1 00 39 a \$1 00 \$2 00

PURCHASE AMERICAN EXCELLENCE
This Type Enables Many Printers to Keep in
the Lead and \$1234567890 Pleases Customers

6 Point No. 2*

23 A \$1 00 45 a \$1 00 \$2 00

PRINTERS KNOW THY TYPES AND INVEST
Judiciously. Remember Old Faces Are Not Always
Old Friends. A Type That Will Also Be Selected

24 Point

5 A \$1 70 10 a \$1 80 \$3 50

SEND PRINCE
Gardener Soulful

5 Point*

17 A \$1 00 34 a \$1 00 \$2 00

EXCESSIVE RACKET PREVENTS MUSICIAN
Mendacious Tourist Fiddler Resumes Long Journey
Members of this League are Promoters of Fine Arts

18 Point

8 A \$1 55 16 a \$1 70 \$3 25

FRENCH CHEMIST
Modernized Condition

6 Point Title No. 4

21 A \$1 00

FACE AND SIZE FOR EVERY DEMAND
ENGRAVING EFFECTS SHOWN HERE

14 Point

11 A \$1 45 22 a \$1 55 \$3 00

MUSICIAN DELIGHTED
Presents Finest Exhibitions

6 Point Title No. 3

24 A \$1 00

PARTICULAR CUSTOMERS ARE SATISFIED
IMITATION ENGRAVING DONE WITH LITHO

12 Point

13 A \$1 30 27 a \$1 45 \$2 75

INTERESTED COMPOSITOR
Splendid \$1234567890 Featuring

6 Point Title No. 2

28 A \$1 00

DEMONSTRATIONS IN LATE STYLES AND FACES
SHOWING ELEGANT SIMPLICITY OF TYPOGRAPHY

6 Point Title No. 1

30 A \$1 00

PRACTICAL DESIGNS BY EMINENT FELLOW-WORKERS
CONTINUOUS CELEBRATION IN TWENTIETH CENTURY

* The same face

Christmas Exercises

GIVEN UNDER THE AUSPICES OF
ST. ANDREW'S CHURCH
OF PITTSBURGH, PENNSYLVANIA

Wednesday Evening
December 25th

Holiday Border Holiday Decorator

QUALITY

ON THIS WE HAVE BUILT OUR
PRESENT BUSINESS

SEVEN years ago last February we started our business taking as our motto the one word Quality and we believe that our patrons will all agree with us when we say it has truly been our slogan all this time with every piece of work turned out. Our reputation for high-grade work is well known. We are fully equipped to do all your printing

FRANKLIN
PRINTERY
92 MARLOW STREET

MILLINERY EXHIBIT

IN ORDER TO SHOW THE SEASON'S STYLES IN FALL AND WINTER HATS, WE WILL EXHIBIT A NUMBER OF DISTINCTIVE IMPORTED PRODUCTIONS AS WELL AS SOME OF OUR OWN EXCLUSIVE MODELS. COME TO OUR GRAND OPENING. SPECIAL INVITATION IS EXTENDED TO YOU TO INSPECT THE VERY LATEST CREATIONS IN MILLINERY. BEAUTIFUL SOUVENIRS PRESENTED

THURSDAY, SEPTEMBER TWENTIETH

FROM TEN UNTIL FOUR O'CLOCK

THE MISSES FLESHMER
CORNER OF FIFTH AVENUE AND BROADWAY

Century Border

60 Point

3 A \$4 60 4 a \$3 15 \$7 75

EDITORS Disputed

48 Point

4 A \$3 25 6 a \$3 00 \$6 25

Northern HISTORIANS

36 Point

5 A \$2 10 8 a \$2 15 \$4 25

HOLDING RARE Demonstration

30 Point

6 A \$1 85 11 a \$2 15 \$4 00

Misappropriated INCREASED STOCKS

24 Point

8 A \$1 60 15 a \$1 90 \$3 50

RELIABLE MERCHANTS Indorsed Application

18 Point

11 A \$1 45 22 a \$1 80 \$3 25

PEDESTRIANS GATHERING FRAGRANT HONEYSUCKLES Gentle Summer Breezes Refreshing Their Fevered Brows

14 Point

15 A \$1 30 30 a \$1 70 \$3 00

BOLD INTRUDER FOUGHT POLICEMAN Found Lurking Around Corner Stores

6 Point No. 1

26 A \$0 90 52 a \$1 10 \$2 00

EIGHTEEN FOREIGNERS ENLISTED IN SALVATION ARMY
Dentists Recommended Artichokes For Preserving Teeth
Fishermen Extremely Busy Catching Mossbunkers in China
Important Government Position Given Remarkable Maids

12 Point

19 A \$1 25 38 a \$1 50 \$2 75

EMINENT DOCTORS HOLDING CONSULTATION Peters Invested \$1234567890 Irrigating Land

6 Point No. 2 †

32 A \$0 90 63 a \$1 10 \$2 00

EXTRAORDINARY IMPROVEMENT NOTED IN SOUTHERN INDUSTRIES
Advertising For a Situation Often Helps One Into a Good Position
Inspector Who Investigated Skyscrapers Found Law Being Observed
Important Questions Wisely Answered by Young University Women

10 Point

21 A \$1 10 41 a \$1 40 \$2 50

EXAMINATION DISCLOSING DELINQUENT PUPILS Many Fair Ladies Protest Against Unfair Methods

5 Point †

24 A \$0 90 47 a \$1 10 \$2 00

ELEVEN HONEST COUNTRYMEN RECEIVED GOVERNMENT POSITIONS
Remarkable Interest Manifested in Recent Foreign Automobile Races
Determined Young Lawyer Succeeds in Winning Most Celebrated Case
Constantly and Energetically Paving Rough Roads to Ultimate Success

8 Point

24 A \$1 00 48 a \$1 25 \$2 25

HILARIOUS STUDENTS RETURNING AFTER FOOT BALL GAMES Serious Accidents Reported Daily During Eastern Tournament

6 Point Title No. 1

44 A \$1 00

EXTREMELY UNCOMFORTABLE ENDURING PROLONGED PERIOD OF INTENSE HEAT
SEVERAL FORTUNATE YOUNG PHYSICIANS RECEIVED SPECIAL MENTION ABOARD
PROMINENT NEWSPAPER PUBLISHED ARRANGING REGULAR ANNUAL CONVENTION

† The same face

Compressed Litho in Practical Display

TEXAS LAND IMPROVEMENT COMPANY
SAN HIDALGO, TEXAS

PAUL F. WERNER, President
ROBERT BOYD, Secretary-Treasurer

SPECIAL ANNOUNCEMENT

I desire to announce to the land investors throughout the East that the Land Investors' Tour through central and southern Texas will start from Grand Central Station by special schedule at ten o'clock Wednesday morning, April fourteenth, and will arrive at San Hidalgo on the morning of the seventeenth. Reservations applied for require three special trains, that consist of sleepers, dining and observation cars, thus making the service most commodious and complete, and those who wish to participate in this business and pleasure trip are reminded that all applications must reach me not later than the twelfth

SAMUEL R. THOMPSON, Agent

New York
March fourteenth

TELEPHONE MEMORANDUM



Mr. _____

Called you up on very
urgent business and
will call you up again

at _____

CLERK

JOHN H. SMITH

JAMES H. BROWN

JOHN H. SMITH & COMPANY

DECORATORS

INTERIOR FURNISHERS, PAPER HANGERS
FRESCOERS AND PAINTERS

Represented by
MARTIN B. JOHNSON
501 Cherry Street

21 COLUMB'S AVENUE
TOLEDO, OHIO

MONTHLY STATEMENT

Jersey City, N. J., _____ 191__

M _____

TO **FREDERICK MONTROSE** DR.
PRINTING MACHINERY

TERMS: STRICTLY CASH

119 MONTGOMERY AVENUE

60 Point

3 A \$7 60 4 a \$4 40 \$12 00

FINE Styles

48 Point

3 A \$1 70 4 a \$2 80 \$7 50

Printing RIGHT

42 Point

3 A \$3 65 5 a \$2 60 \$6 25

COMES Regularly

36 Point

3 A \$2 50 7 a \$2 50 \$5 00

Language QUESTION

30 Point

4 A \$2 00 9 a \$2 25 \$4 25

HUNTERS Destroy Animal

24 Point

5 A \$1 60 11 a \$1 90 \$3 50

**RELIABLE ANTIQUE SHOWED
Evident Adaptability and Elegance**

18 Point

9 A \$1 60 16 a \$1 65 \$3 25

**SEARCH STEAMERS
Relieves Thirsty Sailor
Patient Crowd Waiting**

10 Point

16 A \$1 25 30 a \$1 25 \$2 50

**CLEAN CENTRAL STATION
Employed Hustling Foreigners
Matrons Relieving Sickly Guest
Colored Porters Find Chickens
One Conductor Receives Order**

14 Point

12 A \$1 50 22 a \$1 50 \$3 00

**ADMIRING ROSEBUSHES
Butcher Became Unfortunate
Lighthouse Appeared Dismal**

8 Point

19 A \$1 10 37 a \$1 15 \$2 25

**IMMORTAL WILLIAM RUMINATING
Stratford Philosopher Poet Reflects Life
Ardent Romeo and Merciless Shylock
Cleopatra Alluring the Noble Anthony
King Lear Charms, Richard III Thrills**

12 Point

15 A \$1 35 28 a \$1 40 \$2 75

**YOUTHFUL LOVERS ESCAPING
Wrathful Parent Engaged Taxicabs
Leaping Unavoidable Embankment
Valuable \$1234567890 Property**

6 Point

21 A \$1 00 40 a \$1 00 \$2 00

**COMPOSITORS' GREAT OPPORTUNITIES
Proper Attention Brings Increased Efficiency
American Faces Makes Pleasing Arrangement
Changing Environment is Moulding Character
Great Monsters Inhabiting Primeval Forests
Desperate Burglars Pursued Through Country
Egyptian Hero \$1234567890 Relates History**

H. C. Martin, President

N. H. Anthony, Secretary

Domestic Trust Company

Commercial Banking

Safe Deposit Boxes

Four Per Cent Interest

Capital \$2,455,000

ANNUAL FLOWER SHOW

Grouping of the Best
Specimens from
Many Climes

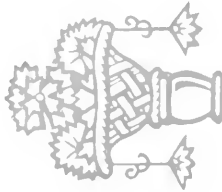

DECEMBER
EIGHTEENTH, NINETEENTH
AND TWENTIETH

Exhibition Auditorium
East Sixteenth Street
Manhattan

Telephone 1268 Rector

The Advertising Press

Designers and Producers of

Profitable Advertising

Illustrating

Presented by
John E. Dodson

405 Commercial Plaza
CHICAGO

Emmet Hester

Floral Basket Press

11 Point

5 A \$1 65 11 a \$1 85 \$3 50

RECEIVES PRINTED DESIGN
Famous Monarch Returns Today

18 Point

9 A \$1 65 16 a \$1 60 \$3 25

DRAMATIC EDITORS FOILED POLICE
Western Bandits Ransack Fast Mail Trains

14 Point

11 A \$1 50 22 a \$1 50 \$3 00

GOTHAMITES CAMPED NEAR SOUTH BEACH
Surf Bathing Attracted Many Beautiful Young Ladies

12 Point

15 A \$1 35 30 a \$1 40 \$2 75

AGED MOUNTAIN CLIMBER RESCUES FOREIGN TOURIST
Farmer Lost Huge Roll of \$1234567890 Cigarette Papers in Reno

DR. FRANCIS ROGAN

M. COME AND WORTHINGTON

262 EUNDIAM A

10 Point

16 A \$1 25 31 a \$1 25 \$2 50

PROSPECTOR MAKES RICH STRIKE IN NORTHERN COLORADO
Young Composer Spends Forty Dollars While Rusticating at New Haven

8 Point

18 A \$1 15 35 a \$1 10 \$2 25

AMERICAN LINE FACES USED THROUGHOUT THE WORLD BY JOB PRINTERS
Inspector Condemns Compartment New Building at Request of Influential Citizen of Iowa

6 Point No. 1

19 A \$1 00 38 a \$1 00 \$2 00

FINISH DOCTOR... METAL...
...with...
...methods for...

6 Point Title No. 3

25 A \$1 00

...FLEA...
...THUL FORGER...
...STUDENTS

6 Point No. 2

25 A \$1 00 48 a \$1 00 \$2 00

...DAILY...
...HOURS...
...MEXITAN YOUTH IN ARIZONA

6 Point Title No. 2

29 A \$1 00

...THROUGH...
...HOURS...
...MEXITAN YOUTH IN ARIZONA

6 Point Title No. 4

20 A \$1 00

...STORIES...
...NOVELIST...
...SHAKE

6 Point Title No. 1

34 A \$1 00

...SHARK WHILE SAILING NORTH...
...SAILORS MUCH TRIBLE...
...THUNDER STORM...
...NEW STEEL TACKLE

Litho Gothic

36 Point

3 A \$2.90 5 a \$2.10 \$5.00

GOTHIC PRINTING
Destroyed Structure

30 Point

4 A \$2.35 7 a \$1.90 \$1.25

MODERN SPECIMEN
Containing Characteristic

24 Point

5 A \$1.95 8 a \$1.55 \$3.50

COMPRISING
Design Charms

8 Point

15 A \$1.10 30 a \$1.15 \$2.25

DESCRIBED NEWSPAPERS
Feature Commercial Typography
Displays Exquisite Workmanship

18 Point

7 A \$1.65 13 a \$1.60 \$3.25

DEFINE HISTORY
Startle Goldworker
Returning Bracelet

6 Point No. 1

16 A \$1.00 32 a \$1.00 \$2.00

SUPERINTENDENT RETURNED
Contemplated Extensive Improvement
Charming \$1234567890 Featurings

14 Point

9 A \$1.50 19 a \$1.50 \$3.00

ENDURING DESIGNS
Buy American Ornament
Showed Distinct Borders

6 Point No. 2*

18 A \$1.00 35 a \$1.00 \$2.00

HONEST METHODS EXPOSED HERE
Ambitious Lightweight Wrestler Procured
Great Cricket Game Played During Storm

12 Point

12 A \$1.40 23 a \$1.35 \$2.75

COMPLIMENT FOREMEN
Detained Emigrants Saturday
Count \$1234567890 These

5 Point*

13 A \$1.00 26 a \$1.00 \$2.00

ANCIENT FACES BEING REPLACED
Ocean Going Steamer Rounds Cape Horn
Large Tugs Rushed Down Bay Full Speed
Enormous Cargoes Taken Aboard Vessels

10 Point

13 A \$1.25 26 a \$1.25 \$2.50

RECEIVES HONOR FIGHTING
Oregon Cowpuncher Fired Salute
Village Cornet Bands Play Slowly
Youthful Soldier Unfurled Ensigns

6 Point No. 12

23 A \$1.00

STRONG FOREIGNER SECURED CLOTHING
ATTENDED EXTRAORDINARY CONVENTION
MODEL AMERICAN PRINTING MACHINERY
HANDSOMEST BORDERS AND ORNAMENTS

6 Point No. 11

29 A \$1.00

BOSTON WIRE STITCHERS PROVE GOOD INVESTMENT
IMPORTANT HISTORICAL EVENTS RECEIVING NOTICE
DEFECTIVE BOLTS CAUSED GREAT RAILROAD WRECK
DESPERATE CRIMINAL CAPTURED BY BRAVE WOMAN

6 Point No. 10

46 A \$1.00

BY THE WAY ADDRESS HERE FOR WHENCE FORTUNE FROM HEALTH UNDER
THESE DELIGHTFUL SEPTEMBER MORNINGS PLEASE EVERY LOVER OF NATURE
BY THE WAY COMMERCIAL ADVERTISINGMENTS PROBABLY UNPLAID BY PARTIES
LARGE BU LONES SOLD AT PUBLIC AUCTION AT VERY LOW PRICES VARIOUS
WONDERFUL DESCRIPTION ON ASTRONOMIC GIVEN BY EDUCATED BUT PRESERVE

* The name face

72 Point

3 A \$5 55 4 a \$3 90 \$9 45

HIRED CLERK
Brighter Staples

60 Point

3 A \$4 75 5 a \$3 80 \$8 55

HEROIC KNIGHT
Champions Argued

48 Point

5 A \$3 90 8 a \$3 70 \$7 60

HUMBLE INSPECTOR
Some Magnificent Styles

42 Point

5 A \$3 30 8 a \$3 00 \$6 30

EXPORT FINE CLOTHES
Hungry Gentleman Reports
Fashionable Couples Dance

Bodoni

36 Point

5 A \$2 30 10 a \$2 70 \$5 00

UNIQUE BODONI SPECIMEN
Exquisite Series Nicely Designed
Display Remarkably Handsome

30 Point

6 A \$2 05 11 a \$2 20 \$4 25

SECURING AMERICAN BEAUTIES
Imparting Considerable Individuality
Bright Compositors Recognize Results

24 Point

7 A \$1 60 14 a \$1 90 \$3 50

ENTERPRISING PRINTERS REFLECTING
Nothing Accomplished With Ancient Material
Many Charming Designs Recently Introduced

18 Point

11 A \$1 50 22 a \$1 60 \$3 30

ADMIRABLE EXHIBITIONS
Sumptuous Apartment Ruined
Inspiring Entertainment Given

10 Point

21 A \$1 20 40 a \$1 30 \$2 50

EDUCATION SADLY NEGLECTED
Studious Young Scholars Going Ahead
Grasp Golden Opportunities, Brothers
Discouraged Boy Becomes Melancholy
Strict Attention Should Always Prevail

14 Point

16 A \$1 45 31 a \$1 55 \$3 00

GREATEST AMERICAN PRODUCER
Receiving Congratulations From Critics
Printers Anticipated a Prosperous Year

8 Point

23 A \$1 10 46 a \$1 15 \$2 25

MECHANIC MADE GRAND SUGGESTION
Proposed Reconstruction of Complicated Parts
Demonstrates Practical Points for Stockholder
Highly Complimented by Department Official
Beautiful Dreams Distract the Handsome Hero

12 Point

18 A \$1 30 35 a \$1 45 \$2 75

NUMEROUS ENTERPRISES REPORTED
Schemes Outlined and Seriously Considered
Extraordinary \$1234567890 Demands Made

6 Point

28 A \$0 95 52 a \$1 05 \$2 00

DEPARTMENTS REORGANIZED DURING SEPTEMBER
Extensive Preparations Being Made for Increasing Fall Trade
Learned Professor Discovered Numerous Ancient Manuscripts
Considerable Notoriety Obtained When Corporations United
Mystery Surrounds Great \$1234567890 Bank Robbery in Spain

Fine English Suitings

AT GREATLY REDUCED PRICES

MADE by our own experienced and skillful workmen into stylish and modish suits for careful dressers. The materials are imported direct from the best English Mills, in patterns exclusively controlled by us. During the ensuing eight weeks we shall offer these at a very great reduction to Angelica citizens. Perfect fit guaranteed in every case

One Price \$22.50

RUFUS FABIAN TAILORING COMPANY

ANGELICA, NEW YORK

The Constitution of the United States of America

Done in a Convention of the
Thirteen States

PHILADELPHIA:
IN THE TWELFTH YEAR OF THE UNITED STATES

MDCCCLXXXVII

WE, the People of the United States, in order to form a more perfect Union, establish justice, insure domestic tranquillity, provide for the common defence, promote the general welfare, and secure the blessings of liberty to ourselves and our posterity, do ordain and establish this CONSTITUTION for the United States of America.

ARTICLE I.

SECTION 1. All legislative powers herein granted shall be vested in a Congress of the United States, which shall consist of a Senate and House of Representatives.

SECTION 2. The House of Representatives shall be composed of members chosen every second year by the people of the several States, and the electors in each State shall have the qualifications requisite for the electors of the most numerous branch of the State legislature.

THEN OPENED HE THEIR UNDERSTANDING,
THAT THEY MIGHT UNDERSTAND THE SCRIPTURES
SAINT LUKE 24:45

HISTORIC BIBLE PRINTERS

AN ACCOUNT OF
THEIR PART IN THE SPREAD
OF SACRED SCRIPT

BY
RAMOND VINCENT LOVES

PRESIDENT OF GROVE SEMINARY

NEW EDITION DE LUXE
ILLUSTRATED

FROM THE PRESS OF
EARLY PUBLISHING COMPANY
PHILADELPHIA

PRINTERS HONOR BODONI
*Italian Designers Study History
Uninvited Neapolitans Perform
Husky Opera Leaders Criticized
Californian Taught Champions*

BODONI DELIGHTS MERCHANTS
*Beautiful Creation Purchased Lately
Display Modern American Ornament
Inspiring Natural Harmonies Charm
Rusticating Musician Studies Melody
Strongest Butcher Subdued Landlord*

BANKER INVITED BOHEMIAN AUTHOR
*Inspector Examines Five Gigantic Skyscrapers
Northwestern Bandits Caught Nearing Helena
Southern Representative Introduced Georgian
Important Documents Unearthed Near Colma
Prosperous Merchants Return From England
Newspaper Editors Received Congratulations*

Bodoni Italic

18 Point

11 A \$1 50 22 a \$1 75 \$3 25

AMERICAN PERFORMER DELIGHTING AUDIENCES
*Shrewd Farmers Capture Twelve Grizzly Bears Near Denver
Bostonians Entertain Delegates From Ecuador and England
Notorious Bank Robber Escaped from Dangerous Detectives
Hungry Gorillas Display Wonderful Agility Climbing Trees
Bodoni Italic Proved a Reliable Purchase for Fine Printers*

14 Point

16 A \$1 45 31 a \$1 55 \$3 00

THOUGHTFUL DESIGNERS PRAISING MODERN BODONI ITALICS
*This Reliable Italic Face Produced by American Type Founders Company
Cast on Script Line Thereby Preserving the Long Descenders on Solid Body
Wonderful Story Circulated by Tourist About Fountain of Perpetual Youth
Grand Vaudeville Performer Returned from Successful Foreign Invasions
Unfortunate Emperors Remaining Silent During Entire Search by Soldiers
Great Marathon Racer Received Trophy After Finishing with His Exercises
Delighted Children Appreciated Long Trolley Ride Down Lower Parkway*

12 Point

18 A \$1 35 33 a \$1 40 \$2 75

SPENDTHRIFT EXPOSES HISTORIANS
*Foremost Establishment Celebrated Tuesday
Natural History Students Questioned Expert
Oklahoman Befriends California Proprietor
Kind Foreman Forgives Famous Composer
Demonstrated Usefulness of Modern Design
Egyptian Dungeon Contains Many Antiques
London Haberdasher Condemns Old Tavern
Carpenter Submits \$1234567890 New Plans*

8 Point

22 A \$1 05 45 a \$1 20 \$2 25

EARTHQUAKE SHOCKS FELT MONDAY
*Indiana Detective Informed Chicago Notable
Six Beautiful Models Exhibit Graceful Forms
Japanese Tonsorialist Discovers New Remedy
Ohio Composer Receives Money From Logan
Eastern Athlete Tours Australia With Doctors
Cattle Rustlers Banished From Northern Iowa
Mexican Hercules Surprised Chinese Acrobats
Rescue Thousands From Burning Laboratory
New England Heavyweight Wrestler Returns
Industrious Apprentice Finished Long Course
United States Marines Reviewed by Dignitary
Admiral Praises Brave Lieutenant at Banquet*

10 Point

21 A \$1 20 41 a \$1 30 \$2 50

GOLDENROD BRIGHTENS REMOTE FIELDS
*Mountain Flowers Possess Marked Characteristics
November Delights Many Enthusiastic Pedestrians
Merganser Ducks Eagerly Pursue Hungry Pickerel
Children Botanize and Study Migrating Songsters
Pensive Dreamer Neglects Radiant Summer Hours
Dark Spruce Forests Shelter Numerous Partridges
Heavy Underbrush Delayed Excited Ornithologist
Progressive Farmers Observe Natural Phenomena
Grayheaded Composer Describes the Mountains
Delegation Attends Convention at San Francisco*

6 Point

28 A \$0 90 55 a \$1 10 \$2 00

MARI ELOUS CREATIONS PLEASED GREAT PRINTER
*Destructive Cyclone Swept Lower New England Coast Today
Greatest Theatres Opened Earlier Since Cold Weather Came
Most Wonderful Display Originated with American Material
Striking Designs Presented Royal Congress During February
Several Baseball Players Demanded Large Increase in Salary
Charming Rosebushes Obscured Throughout Pacific Coast Tour
Beautiful White Mountain Scenery Attracts Vacation Parties
Vermont Unitype Operator Becomes Engaged to Composer
Tramp Steamer Anchored Near Statue of Liberty Last Night
Sunburned Bathers Endured Terrible Tortures While Dressed
Youthful Stowaways Found Among Coal Bunkers in Chicago
Great Western Corn Crop Being Mocked by Largest Railroad
Burlesque Shows Entertained Vast Audiences During Evening
Husky Bartenders Returning from an Extended Steamer Trip
Gigantic Warship Enters Harbor After Long Perilous Journey
Vast Figures Supplied \$1234567890 in Every Complete Font*

*International School of Printing
Fortieth Lesson*

IDEAS OF BODONI ON PRINTING

Foreword

HIS NOTIONS about Typography are to the point: "The beauty of letters consists in their regularity, in their clearness, and in their conformity to the taste of the race, nation and age in which the work was first written, and finally in the grace of the characters, independent of time or place. Types should be suitably arranged on the pages in straight regular lines, not crowded, nor, in proportion to their height, too far apart, and with equal spaces between words and lines. The more classic the book, the more appropriate it is that the text should appear alone, in order that the beauty of the letters may be apparent. This is real art." Notwithstanding the many advances in printing and type making that have been made in modern times, these ideas of this old master printer still hold good. The School has taken great pains in the following pages to show a few Bodoni reproductions. The typographer of the twentieth century will find much in the simple styles of Giambattista Bodoni that is worthy of close study and emulation. This lesson will also prove of practical value on account of the increasing popularity of Bodoni types

*This Instruction Paper is Strictly
Confidential*

Mankind and Education

A Book of Essays by JOHN FRANCIS CHESTERFIELD

WE are pleased to announce that this book is now ready; and we wish to say that it is the best we have yet offered, in fact it is one of the finest examples of bookmaking which has recently been produced. Even if this book had been in a language unknown to the reader it would be a delight to take it in hand and linger upon its typographical charms. It will satisfy the booklover who can appreciate the art of the craftsman, who was inspired by a high ideal, and worked in an atmosphere of harmony and good fellowship. Little need be said of the text of this book, for Chesterfield was one of America's foremost essayists, and *MANKIND AND EDUCATION* is one of his best books. These essays contain some of the most beautiful thoughts ever penned, and they are held as almost sacred by many readers. This book is printed on rich white, pure rag paper, from clear cut new type, with nature design in delicate tint on each page, title page and frontispiece carefully hand colored. There are about four hundred copies in substantial brown board binding, at one dollar each, and one hundred copies in full leather, at two dollars each.

INTERNATIONAL PUBLISHING COMPANY

New York Baltimore Philadelphia Boston New Orleans Chicago San Francisco

PRINTING EQUIPMENTS

IN THE TWENTIETH CENTURY

HITHERTO the expenditures for the composing room have been insignificant as compared with those in other departments. Under the method here outlined, composing room equipments, excluding types and linotypes, have ranged in cost from five thousand to eighteen thousand dollars. There has been a superstition among printers that the composing rooms did not pay. Facts show that the composing room with a cost system is the most profitable department. It has developed in the sale of specialized composing room outfits and the resulting increase in efficiency has almost always been a real source of agreeable surprise to every purchaser.

**American
Type Founders Company**

**COMPLETE
PRINTING OFFICE
OUTFITTER**

Our Specially-designed Iron Composing Room Equipments are practically indestructible and economical in floor space.

36 Point

5 A \$2 35 10 a \$2 70 \$5 05

DISTINGUISHED FOREIGNER

Printers Secured Handsome Series Acknowledge Prominent Designer

30 Point

6 A \$2 15 12 a \$2 25 \$4 40

RECOVERING ANCIENT HISTORIES

Italian Merchants Erect Beautiful Statues American Type Founders Company Face

24 Point

8 A \$1 65 16 a \$1 90 \$3 55

BLACKSMITHS PURCHASED HORSESHOES

Handsome Borders Improve Better Type Designs Notice Striking American Originality Throughout

18 Point

12 A \$1 50 24 a \$1 80 \$3 30

IGNORES TRUSTING MAIDEN

Disinherit Prominent Composer Honest Judge Granting Interviews

10 Point

22 A \$1 20 42 a \$1 30 \$2 50

OBSERVING STRANGEST CREATURE

Making Christmas Gifts of Jeweled Purses Seventy Turkeys Used Thanksgiving Day Steamers Arrived from Bermuda on Time Wonderful Demonstration Pleased Ladies

14 Point

17 A \$1 45 33 a \$1 55 \$3 00

EXQUISITE TYPOGRAPHIC FEATURE

Explains Remarkable Coincidence Monday Deserted Lighthouses Rapidly Demolished Shows Handsome and Dignified Characters

8 Point

24 A \$1 05 47 a \$1 20 \$2 25

PRAISING MODERN DESIGNS FERVENTLY

Hoboken Heavyweight Wrestler Was Challenged Hunters Pursued Mountain Lions Around Forest Astounding Report from Greatest Mining Center Japanese Admiral Found Large Phonograph Disc Heavy Rainstorm Stopped Football Games Today

12 Point

19 A \$1 30 38 a \$1 45 \$2 75

SECURE MODERN PRINTING EQUIPMENT

Foreign Mechanic Demanded American Quality Boston Wire Stitchers Repay Careful Purchaser Prosperous Farmer Leaves Vermont Mountains Employ Husky \$1234567890 Unitype Operator

6 Point

24 A \$0 95 52 a \$1 05 \$2 00

MARVELOUS STRUCTURES COMPLETED AFTER DELAYS

Steamboat Captain Pilots Large Excursion Party Safely Tuesday Noted Harvard Astronomer Discovers New Comet in Eastern Sky Charming Burlesque Show Amused Many Ladies and Gentlemen Printing Office Superintendents Praising Bodoni Book Fervently Wealthy Merchants Purchased Valuable Buildings for Daughters Expert Bookkeeper Held Important Government Position Lately Handsome Stenographer Returned from Prolonged Vacation Trip Beautiful Figures Quickly \$1234567890 Observed by Composer

COMFORTABLE HOMES



Hundreds of families now find under the roof of one massive structure practically the privacy of a secluded home, and have many more privileges and conveniences, such as elevators, gardens, billiard rooms, courts, etc., than a single home can afford

THE PERSON WHO HAS NOT KEPT APACE WITH THE TIMES IN THE DEVELOPMENT OF APARTMENT HOUSE CONSTRUCTION WOULD TRULY MARVEL AT THE NUMEROUS HOME CONVENIENCES AT THEIR COMMAND

THE JAMES HENDERSON RENTING AGENCY

MANHATTAN BOULEVARD AND RIVERSIDE DRIVE, NEW YORK CITY : TELEPHONE 81

Strathmore Ornament Three Point Border Linear Border No. 2

ESTABLISHED 1883

Hudson & Nairn Company

MAKERS OF

Lithographic Inks and
Fine Dry Colors

MAIN OFFICE AND FACTORIES
PHILLIPSBURG, PENNSYLVANIA
BRANCHES EVERYWHERE

INCREASING TRADE

A SERIES OF EXAMPLES TAKEN FROM
THE PRACTICAL TYPOGRAPHIC GUIDE

IN the last article, the ingredients of inks were discussed and now we come to the distributing end of the business. If the printer could so standardize all his work as to be able to buy regular inks in large lots from the manufacturer's stock, he would considerably reduce the cost of getting the ink to the user. This is probably impossible in a number of cases. Paper, presses, cuts, time requirements, and numerous other

CITY TELEPHONE 1234

BELL TELEPHONE 5678

MONSEN & BURNS

DESIGNERS, MANUFACTURERS AND WHOLESALE DEALERS
ARTISTIC GOLD JEWELRY

MONSEN AND BLAKE STREETS
NEW HAVEN

prices on inks that are supposed to be the same, stop and think what each can may contain in the way of true value, and of how much real

PAGE NINE

36 Point

6 A \$2 70 9 a \$2 30 \$5 00

*CONDEMNING LIGHTHOUSES
Gunboats Returning From Sweden
Honorable Gentlemen Disinherited*

30 Point

6 A \$2 05 12 a \$2 35 \$4 45

*REQUIRING STRONG AUTOMOBILE
Large Steamer Nearing Southern Harbor
Delightful Excursion Parties Disbanding*

24 Point

8 A \$1 70 15 a \$1 80 \$3 50

*MYSTERIOUS KNIGHT DESIRED FORTUNE
Disheartened Ranchman Journeys Through Utah
Extraordinary Confectioners Holding Conventions*

18 Point

12 A \$1 55 24 a \$1 75 \$3 30

*SHOWED EXQUISITE DESIGN
Pleasing Bodoni Book Italic Face
Handsome American Ornaments*

10 Point

22 A \$1 25 43 a \$1 25 \$2 50

*DESTRUCTIVE RAINS HAVE PASSED
We are a Complete Printing Office Outfitter
Young Frenchman Saved Native Spaniard
Large Pressman Dances Like Grizzly Bear
Badly Punish Western Fighting Sensation*

14 Point

16 A \$1 40 33 a \$1 60 \$3 00

*ENGLISH DUKE INTERVIEWS KINGS
Strong Butcher Carried Heavy Load Friday
Five Large Hornets Chased Husky Soldiers
Bewildered Geographical Students Helped*

8 Point

24 A \$1 05 46 a \$1 20 \$2 25

*DISTINGUISHED FOREIGNERS ENTERING
Several Governors Elected During Last Elections
United States Senator Received Fountains Friday
Young Councilman from Oregon Presented Claim
Interesting Lectures Enthusing Former Policeman
Retired Banker Spent Money With Great Masters
Mexican General Submits Plans for Fortifications*

12 Point

19 A \$1 30 39 a \$1 45 \$2 75

*GIRLS MENTION INTERESTING HISTORY
Naming Twentieth Century Economies Correctly
Radiant Sunshine Delights Seaside Promenader
Splendid Japanese Performer Touring Continent
Beautiful Figures \$1234567890 Shown Printer*

6 Point

30 A \$0 95 56 a \$1 05 \$2 00

*GOVERNMENT INSPECTOR PURSUED FOREIGN COUNTS
Clim Agents Being Entertained in Brooklyn by German Soldiers
Unusual Strength and Endurance Observed at Professional Game
American Type Founders Company Sets the Pace in Making Type
Strong Bodoni Features Preserved Throughout this Entire Series
Serviceable Borders and Ornaments Enrich Finer Printed Designs
Enormous Profits Rewarded Users of Original Bodoni Book Italic
This Company Sells Cylinder and Job Presses, Paper Cutters, Etc.
American Line Type Styles \$1234567890 Mean Increased Profits*

The Growing Demand for Good Printing

GOOD work pays. The finest quality of printing, that which is used for advertising purposes, as well as the commercial forms, is the kind in which there is the most money for the advertiser and also for the firm producing such work. This growing demand for a better grade of printing is due to the fact that the public has at last awakened to the educational value of good printing. Now to do good work one must have good material, and the many beautiful

American Line Type Faces

which are shown in this catalogue will help wonderfully in producing this class of work. That the demand for high-grade work will continue to increase is a recognized fact, for the constant development of the esthetic sense in our educational institutions is bound to produce notable and lasting results. While we may not have passed through the era of cheapness, there is less desire for the cheap article than there was a few years ago, that is, if the low price is at the sacrifice of elegance, worth and good taste

Originator and Maker of Artistic Type Faces

American Type Founders Company

BOYD'S HISTORY OF THE CIVIL WAR

This book has been pronounced by experts as the most exact record of the war between the North and South which has ever been placed on sale. Full details of the facts leading up to the great conflict are given, while the actual fighting is portrayed in a very interesting way

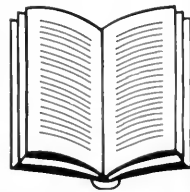

NATIONAL PUBLISHING CO., Chicago

72 Point

3 A \$6 20 4 a \$4 40 \$10 60

FINER PRINT
Brighter Color

60 Point

3 A \$4 55 5 a \$3 95 \$8 50

NOTICE FISHER
Strongest Display

48 Point

4 A \$3 65 8 a \$4 15 \$7 80

HISTORIC DOCTOR
Secured Many Houses

42 Point

4 A \$3 00 8 a \$3 25 \$6 25

DISTURBS MUSICIANS
Making Handsome Coins
Placed Great Confidence

Bodoni Bold

36 Point

5 A \$2 60 8 a \$2 15 \$5 05

IMPROVING STRUCTURES
Submits Bodoni Bold Design
Handsome Ladies Returning

30 Point

6 A \$2 10 10 a \$2 15 \$4 25

INDIAN INTERESTS CHILDREN
Large Insurance Building Ruined
Detectives Reject Destitute Misers

24 Point

6 A \$1 65 12 a \$1 95 \$3 60

AUSTRALIA IMPORTING MACHINERY
Several Marvelous Improvements Noticed
Makes Charming Ornaments and Borders

18 Point

10 A \$1 50 20 a \$1 75 \$3 25

SECURING BODONI BOLD
Delight Enterprising Printer
Thanksgiving Proclamations

10 Point

19 A \$1 20 36 a \$1 30 \$2 50

HONEST COMPOSITORS COMING
Strong Display Letter Shown Buyers
The World's Printing Shop Outfitter
American Type Founders Company
Brave Pressman Drills German Boy

14 Point

15 A \$1 35 30 a \$1 65 \$3 00

HELPS PROMINENT UNIVERSITY
Eighty Reliable Merchants Enthused
Purchased Distinct Printing Quickly

8 Point

21 A \$1 05 41 a \$1 20 \$2 25

BRIGHTER HISTORY STUDENT FOUND
Pass Important Examinations Successfully
Strength and Adaptability Easily Observed
Advertisers Rejoicing Over Bodoni Designs
Largest Quantities of Imported Hair Stolen

12 Point

17 A \$1 30 32 a \$1 45 \$2 75

PROMINENT DESIGNERS RETURNED
Enthusiastic Lighthouse Keeper Drowns
Clever Artists Held Audience Spellbound
Nimble Men \$1234567890 Counted Sum

6 Point

25 A \$0 90 49 a \$1 10 \$2 00

CHARACTERISTIC AND STRIKING TYPE CREATION
Avoid the Expensive Habit of Picking Live Jobs Through
Lack of Having an Abundance of Material. This Costly and
Unnecessary Habit Not Only Causes Great Inconvenience
but Causes Lack of Harmony Among Ambitious Printers
These Figures Printed \$1234567890 Distinct and Clear

Elegance of the Bodoni Family

THE NEW TYPE FASHION

ANOTHER new and great type family is shown in this Specimen Book of Type Styles. The new Bodoni Type Family is going to be a long-lived fashion because the design is of classic simplicity, elegant, yet strong, and like all real works of art its beauty will be appreciated the more it is studied. Every printer will find it profitable to show Bodoni styles to the buyers of printing. The enterprising printers will be certain to reap a splendid crop of orders. It has been positively demonstrated that with the introduction of each successful Type Family the demand for printing has been both stimulated and increased. Those who pay for catalogues, booklets, circulars, and advertisements of every kind, are looking for new business attractors in types. When a great type design appears their interest in printed salesmanship is freshened and orders to the printers follow

AMERICAN TYPE FOUNDERS COMPANY

Maker and Originator of the Classical Bodoni Type Family, the New and Beautiful Type Family which will attract the many Buyers of Printing

THE LISTO PIANO

An Instrument of the Highest Grade

The familiar lines from Shakespeare's *Merchant of Venice* can be paraphrased thus, and still be fraught with equal truth: "The home that has no piano in its midst, nor is not moved with aspiration to possess one, is lacking in the fundamental instincts of culture and refinement." Because, to-day, the possession of a *fine* piano is not so much a question of money as it is of desire. For a LISTO PIANO is the *equal of any piano manufactured* and yet it can be purchased by payments as small as Five Dollars a month

Write for Illustrated Catalogue

THE BENSHOFF PIANO COMPANY

1256 FREDONIA STREET, BOSTON

FOUR CAMERA BOOKS

Retouching for Amateurs

Elementary instructions on removing defects in negatives, and improving all of your home portraits

How to Take Portraits

Describes the making of backgrounds and apparatus, lighting, posing, exposure and development of portraits, for outdoors

How to Make Enlargements

Simple directions for making enlargements without special apparatus, and instructions for making an enlarging lantern

A Manual of Printing

A great book for the beginners, but valuable for everybody, because written out of long experience

AMATEUR PHOTOGRAPHERS' SUPPLY COMPANY

2151 HANCOCK STREET, ROXBURY, MASS.

72 Point

3 A \$6 95 4 a \$4 35 \$11 30

REMORSE
Biographical

60 Point

3 A \$6 00 4 a \$3 70 \$9 70

GRANDEUR
Bathing Decks

48 Point

4 A \$4 20 6 a \$3 30 \$7 50

FORMER PRICE
Cleanest Mechanics
Monument Spoiled

36 Point

4 A \$2 70 7 a \$2 30 \$5 00

PRINTER DRINKING
Designs Bronzing Machine
Entertain Congenial Guest

30 Point

5 A \$2 10 10 a \$2 15 \$1 25

HANDSOMER COSTUMES

Compositor Refuses Nomination Delights Enthusiastic Audiences

24 Point

6 A \$1 80 11 a \$1 70 \$3 50

DISPUTES CLEVER MECHANIC

Released Noted Professional Ballplayer Embezzler Secretly Returned Monday

18 Point

9 A \$1 55 18 a \$1 70 \$3 25

DISCOVERED PHENOMENAL PRINTERS

Extensive Advertising Profitably Increases Business Congressmen Entertaining Senators in Washington

14 Point

13 A \$1 45 26 a \$1 55 \$3 00

DISTRIBUTING SOUVENIRS

Child Graduate Receives Diploma Hoboken Printing Concern Burns Respecting Insignificant Members Printers Retiring Immensely Rich

10 Point

19 A \$1 20 38 a \$1 30 \$2 50

NEW DORP THRONGED MONDAY

Champion Invited West Hoboken Friend Husky Ethiopian Exhibits Great Science Oklahoma Giant Demands Record Prices Boston Youth Developing Quite Rapidly Westchester Athlete Taking Long Sleep Gothamite Interviews Chicago Architect

12 Point

15 A \$1 30 30 a \$1 45 \$2 75

EXHIBITED ARTISTIC PICTURE

Annual Convention of Steamfitters Held Compositor Displays Practical Judgment United Brewers Giving Elegant Dinners Pedestrian Arriving Within Ninety Days Tonsorial \$1234567890 Artists Explained

8 Point

21 A \$1 05 41 a \$1 20 \$2 25

KENTUCKY ORATOR SAVED BANKER

Auditors Revising Large Record of Mortgages Famous Conductor Reorganized Leading Band Manhattan Physician Solved Twelve Problems Capable Manager Condemns New Automobile Newark Employers Raised Wages Voluntarily Broadway Merchants Demanding Recognition Young Adventurers Returned From California Constable Suspected Southern Representative

11 Point

18 A \$1 35 36 a \$1 40 \$2 75

HANDSOMELY ENGRAVED MONOGRAM

Excursions Wednesday Afternoons and Evenings Printers Receiving Handsome Competition Prizes Dependent Foreigner Suddenly Became Alarmed Enthusiastically Welcomed English Ambassador Renowned Musicians Arriving Thursday Evening

6 Point

22 A \$0 90 45 a \$1 10 \$2 00

DIPLOMATIC AGENTS ARRIVING IN SCOTLAND

Spend Fourteen Weeks Touring Beautiful Highlands Points of Interest Reached by American Automobile Aviator Starting on Perilous Flight Across Continent Expensive Aeroplanes Built by New Orleans Citizens Noted Comedians Accompanied Daring Young Pilots Foreign Contestant Praised Managers of Great Show Country Boy Wins Fame in Great English University German Scientist Lectured Senior Class Last Friday Japanese Inventor Startles Foremost Philanthropists Young Ballet Dancer \$1234567890 Deceives Treasurers



AMERICAN

TYPE, BORDERS AND ORNAMENTS ARE
IDEAL PRINTERDOM FASHION PLATES



EW Type, Borders and Ornaments of the American Type Founders Company excel in design and their durability is assured by use of the best material procurable. The selection of designs and styles as brought out by this company surpasses in both variety and utility the combined product of all other type foundries. A printing office completely equipped with its productions is worth far more for either use or sale than one made up from the productions of other type foundries. It is conceded that American Type is the standard for excellence throughout the world. The up-to-date printer will secure a distinct advantage over his competitor by purchasing job type in weight fonts from this company. Buying in weight fonts means full cases, and full cases obviate the necessity of hunting for sorts, which is a very serious handicap in a composing room. It stands to reason that the printer who has full cases will derive a much larger profit from his work than his competitor who is continually picking sorts from the live jobs.

SCOTCH ROMAN

A beautiful book and job type with some characteristic features which make it a letter adaptable for all kinds of work. There are not many faces more available for all around use, and it will give an air of distinction to even the best of work.



Drawing and Designing

By HAROLD IRWIN BECHMAN, Art Instructor



PRACTICAL treatise on the art of designing, drawing and illustrating in connection with typography. Contains concise and complete instructions, very lavishly illustrated, concerning the development of art as allied to printing and the typographical industry. The utility of this treatise to the student is manifest and the information which it imparts is bound to be of great benefit to the beginner as well as to the student who is well advanced in art

Our service to the community is threefold; we train the eyes and the hands of the children, and give them another means of expressing and recording what they see; we develop artistic quality in our national industries, and so promote the intellectual interests of the men and women employed in them; and we cultivate in the population at large the precious sense of beauty. Are not these worthy objects for the work of our lives?

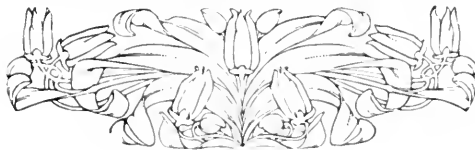

PUBLISHED BY THE

Ohio Institute of Drawing and Design

Cromwell Avenue and King Street

East Hamel, Ohio

72 Point

3 A \$6 40 4 a \$3 80 \$10 20

INVENTIONS
Byron Springs

60 Point

3 A \$5 50 5 a \$3 75 \$9 25

FIVE HUNDRED
Summer Garden

48 Point

4 A \$3 75 8 a \$3 80 \$7 55

EIGHT MONSTERS
Undesirable Bachelor

42 Point

5 A \$3 30 9 a \$3 15 \$6 45

YOSEMITE SCENERY
Acrobatic Performances
Numbering Equipments

36 Point

5 A \$2.65 9a \$2.45 \$5.10

LUMBERING STEAMSHIP
Announcing Demonstration
Midnight Serenades Ceased

30 Point

6 A \$2.25 10a \$2.05 \$4.30

POPULAR CONVENTIONALIST
Demonstration of Art Preservative
Mechanical Ability Became Scarce

24 Point

7 A \$1.65 14a \$1.95 \$3.60

NUMEROUS PEDESTRIANS TRAINING
Plainly Revolutionizing Printing Methods
Unconquerable Blizzards and Snowstorms

18 Point

10 A \$1.60 21a \$1.65 \$3.25

VENTURESOME BANKER
Monitor and Merrimac Fight
Beautiful Nightingale Sings

10 Point

18 A \$1.15 40a \$1.40 \$2.55

HANDSOME PRINTS EXHIBITED
Poster Workers Use Type Creations
Now Playing Championship Games
Excessive Study Becomes Arduous
Relative or Appertaining to Printing

14 Point

14 A \$1.50 26a \$1.50 \$3.00

INSURANCE DIRECTORS DINE
Circumstantial Evidence Produced
Harmony Showing in Supplement

8 Point

20 A \$1.00 48a \$1.25 \$2.25

SAN FRANCISCO EXPOSITION DECIDED
Eccentric Printing Relegated to the Scrap Heap
Peculiarities of Mankind Shown on Broadway
Artistic Borders and Ornaments for Color Work
Monumental Indifference Positively Exhibited

12 Point

16 A \$1.25 37a \$1.50 \$2.75

TYPOGRAPHICAL BEAUTY ABOUND
Systematic Production Increases Finances
Modern Printers Know Prevailing Models
Neatness and \$1234567890 Speed Lead

6 Point

24 A \$1.00 48a \$1.00 \$2.00

ADMIRING THRONGS REJOICE OVER VICTORY
The Art Preservative of All Arts Thanks the American
Printing Executed Neatly and Quickly Retains Business
Newest Features Are Injected Into Type Manufacturing
European Advertisements a Big Feature for Magazines
Motor Boats and Launches Will Race on the Schuylkill
Several Thousand \$1234567890 People in Crowds

Display

IN MODERN JOB COMPOSITION
AND ADVERTISING LITERATURE

SOME years ago the prevailing methods among compositors to obtain desired emphasis in type display were eccentricity and harsh contrasts. Printers who study the needs of the advertiser realize that other methods must be used if real distinction is to be secured. There is such a volume of printing coming from many sources, both in literature and advertising, that the printer in order to make his work different and distinctive must use stylish and original type faces. The best proof of the intrinsic value of new faces to the printer is shown in the tremendous growth of the American Type Founders Company

If you would forge to the front, and advance in the world of printing you will add to your type equipment often

FARMS

AND SEASHORE PROPERTY

SITUATED IN SECTIONS THAT ARE
MOST HANDY TO COMMUTERS

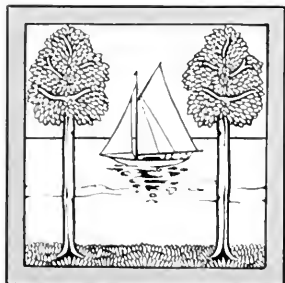

Our property is in the heart of the most popular coast section of Hanover County and is the coming suburb of Portland. It has many railroad facilities and good roads. The farming lands are fertile and promise returns to the investor. Many sections of the water-front form choice locations for summer cottages, in fact there are several now in course of construction. Act at once while the choice is good

DUIRKEN & SON

SOLE AGENTS

Marden Street, Detroit

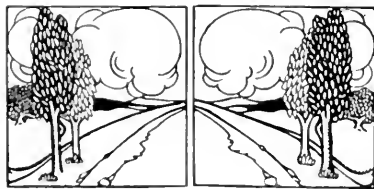

THE CELEBRATED HIMAN PIPE ORGAN

An instrument built for
Home and Church use

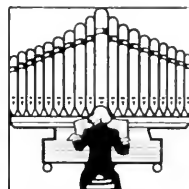

Awarded First Prizes
and Gold Medals
France
Germany, Brussels
United States



MADE BY THE MOST SKILLED
LABOR AND FROM THE BEST
MATERIALS TO BE OBTAINED

J. HIMAN & CO.

No. 37 MADISON AVENUE
BRAMTOWN, WISCONSIN

Mason & Hemdan

MANUFACTURERS OF AND WHOLESALE DEALERS
IN THE BEST OF EUROPEAN AND AMERICAN MADE

Automobiles

PRACTICAL REPAIRING AND GENERAL SUPPLIES
RIDGE AND HUNTING STREETS, COLUMBIA

Meriontype Series

72 Point

3 A \$6 80 4 a \$4 50 \$11 30

KIND NURSE
Easter Styles

60 Point

3 A \$5 50 4 a \$3 55 \$9 05

FINE BUTCHER
Modern Border

48 Point

4 A \$3 80 7 a \$3 80 \$7 60

MORNING ARGUS
Greatest Mountain

42 Point

4 A \$3 00 8 a \$3 35 \$6 35

HOUSES FURNISHED
Enthusiastic Speakers

36 Point

5 A \$2 75 7 a \$2 30 \$5 05

INTERESTING ROMANCE
Beautiful Seashore Resort
New Attractions Saturday

30 Point

6 A \$2 25 9 a \$2 00 \$4 25

SOUTHERN EXCURSION TRIPS
Liberal and Judicious Selection
Returning From the Battlefields

24 Point

7 A \$1 75 12 a \$1 80 \$3 55

DEVICE FOR COMFORT AND SAFETY
Patrons Desiring to Rent Opera Chairs
Need Only Hand in Their Application

18 Point

10 A \$1 60 18 a \$1 70 \$3 30

RESOURCES OF RUSSIA
Select Printing Machines
American Type Foundry

10 Point

16 A \$1 10 35 a \$1 40 \$2 50

KLONDIKE EXPLORER FROZEN
Postponed Furniture Exhibition
Hudson Bridge Delights Tourist
Beautiful Lakeview Residences
Superintendent Received Order

14 Point

12 A \$1 30 28 a \$1 70 \$3 00

BEAUTIFUL CONCERT ORGAN
Largest Collection Ever Shown
Benevolent Bulgarian Societies

8 Point

20 A \$1 00 40 a \$1 25 \$2 25

DEVELOPMENT OF CERTAIN INDUSTRY
Doubtful Improvement Being Investigated
Thoroughly Conversant With All Details
Cannot Afford to Waste Much Time Here
Two Hundred Thousand Dollars Invested

12 Point

15 A \$1 15 34 a \$1 60 \$2 75

HARMONIOUS CONVENTION HELD
Antique Ornaments Richly Bronzed
Development \$1234567890 Industry

6 Point

22 A \$0 90 44 a \$1 10 \$2 00

THERE IS NO BETTER EVIDENCE OF THE HIGH
Average Good Taste of American Printers Than
The Phenomenal Popularity of The Meriontype
Series. It Has Dignity, Beautiful Contour, Elegant
Proportions, Perfect \$1234567890 In Every Way

60 Point

3 A \$5 20 5 a \$3 65 \$8 85

CHIME Designed

48 Point

4 A \$3 50 6 a \$2 75 \$6 25

Strengthened ANCHOR

36 Point

5 A \$2 25 9 a \$2 00 \$4 25

DUPLICATE HAND PEN PRINT Showing Exquisite American Hotels

30 Point

6 A \$2 05 12 a \$1 95 \$4 00

PRODUCING THIS DISTINCT SERIES Have Original Quality and Charming Beauty

24 Point

7 A \$1 60 16 a \$1 90 \$3 50

IMITATING FANCY LETTERING DESIGNS Copyrights Odd and Very Useful Printing Material

18 Point

11 A \$1 55 23 a \$1 70 \$3 25

SHOWED MODERN SERIES Mailing Remarkable Publication Purchase Handsomer Dictionary

10 Point

21 A \$1 20 44 a \$1 30 \$2 50

MARVELOUS ADVERTISING PAGES Brilliant Orators Entertained Secretaries Enthusiastic Audiences Attending Theatre Handsome Blonde Entered Hotel Bilmont Startling Disclosures Expected from Bank

14 Point

17 A \$1 50 34 a \$1 50 \$3 00

PRODUCE EXTRAORDINARY SERIES Honest Gentleman Delivered Famous Book Reproduce Several Magnificent Specimens Educated Compositors Demanded Pen Print

8 Point

24 A \$1 05 49 a \$1 20 \$2 25

CARVE STATUE DURING SPARE MOMENTS Honest Quality and Quantity are Always Universal Enthusiastic Demonstrator Proved Very Interesting Spinster Removes Harsh Lines Through Massage Juvenile Students Demand Promotion Immediately Shorthand Expert Finds More Charming Diversion

12 Point

19 A \$1 35 38 a \$1 40 \$2 75

SEVERE SCORING GIVEN BOLD CONVICT Monster Gathering Has Every Available Space Pleasant Surprise Awaits Users of Our Product Golden Harvest \$1234567890 Brings the Coin

6 Point

28 A \$0 95 58 a \$1 05 \$2 00

BIOGRAPH PICTURES DISPLAYING CHARMING SCENES Curious Girl Detective Becomes Interested in Stronger Criminal Mechanical Department Becoming Highly Profitable Nowadays Photography for Many Centuries Remained an Unsolved Mystery The Declaration of Independence was Composed in Philadelphia Enterprising Newsbays Promulgate Plans for Enterprising Clubs Great Agricultural Display \$1234567890 Anticipated Next Spring

Established 1876

Telephone 189 Bell

Columbia Watch Company

Corner Broadway and Forty-seventh Street

Kansas City, Missouri

WISHES to announce to the general public that the new Columbia-Nash Watch is now completed and ready for sale. This masterpiece of the watchmaker's art has been pronounced by experts to be the acme of perfection. All that skill and money can do to make a perfect timepiece has been done. There is no other watch at the price of the Columbia-Nash—\$5.00 to \$19.00—which will keep as good time, and there is no watch at any price that will keep more than a very small fraction better time. To get that infinitely small fraction of accuracy makes your watch cost about ten times as much as the Columbia-Nash, and that small fraction is not really of value in the day's work. In other words, a Columbia-Nash at, say \$9.00, is a good enough watch for anybody. Why not pay us a visit and look them over

Dated, September 19th

Harold M. Northrup

Number 396 North Hudson Street

Representing
Columbia Watch Company

Kansas City, Mo.

Order of Dances

Part One

- 1 Waltz
- 2 Two-Step
- 3 Schottische
- 4 Gallop
- 5 Waltz-Quadrille
- 6 Mazurka
- 7 Waltz
- 8 Two-Step

Intermission

72 Point

3 A \$5 65 4 a \$4 25 \$9 90

BURNISHED
Highest Reign

60 Point

3 A \$6 10 4 a \$3 45 \$9 55

HOLD FRIEND
Greatest Scholar

54 Point

3 A \$5 00 5 a \$3 75 \$8 75

BURMESE KING
System Unequaled

48 Point

4 A \$3 75 8 a \$3 85 \$7 60

DESCRIBE HOMES
Explorers Mentioned

42 Point

5 A \$3 25 9 a \$3 05 \$5 20

HAULING ENGINES
Describe Either Method

36 Point

5 A \$2 40 9 a \$2 70 \$5 10

FRAME HOUSE BURNED
Experiment Bringing Motive

30 Point

5 A \$2 05 11 a \$2 20 \$4 25

SECURE NOVEL MAGAZINE
Greatest Medical Board Instructor

24 Point

7 A \$1 85 12 a \$1 65 \$3 50

HOME KNIGHTS REVISE DECISION
Undisturbed Historical Emblems Retained

18 Point

9 A \$1 60 18 a \$1 65 \$3 25

EXECUTIVE HONORED
BERMINGHAM HEROES
Historical Medals Discovered

10 Point

18 A \$1 25 36 a \$1 25 \$2 50

PUBLISHES HANDSOME DESIGNS
FURNISHED PRINTED PROGRAM
By Committee for the Great Celebration
Mayor and Other Prominent Men There
Oration by State Senator John Monroe

14 Point

13 A \$1 45 26 a \$1 55 \$3 00

GENUINE DEMANDS SIGNED
FIGURES DISGUISE MEANING
Remarkable History of Government

8 Point

23 A \$1 15 46 a \$1 10 \$2 25

PROGRESSIVE PRINTERS USING AMERICAN
LINE TYPE PRODUCE HANDSOME DESIGNS
Della Robbia will Aid in Every Way to Give Your
Printing that Dignified and Fashionable Style Which
Meets the Approval of the Most Fastidious Customer

12 Point

16 A \$1 35 33 a \$1 40 \$2 75

FINANCIAL STRINGENCY RELIEVED
MERCHANTS PREDICT PROSPERITY
Crisis of the Financial World Safely Passed
Secured Amount \$1234567890 Philanthropist

6 Point

26 A \$1 00 52 a \$1 00 \$2 00

BECAUSE OF ITS ATTRACTIVE VARIETY OF SIZES
LEADING EXPONENTS OF TYPOGRAPHY ADMIRE
THE FASHIONABLE DESIGNS SET IN DELLA ROBBIA
It Possesses an Individuality of its own that Produces the Artistic
Effects so Much Desired by Up-to-date Houses Throughout the
Country and Which has Led Master Printers to Adopt this Face
For Use on All Work that \$1234567890 is of an Artistic Nature

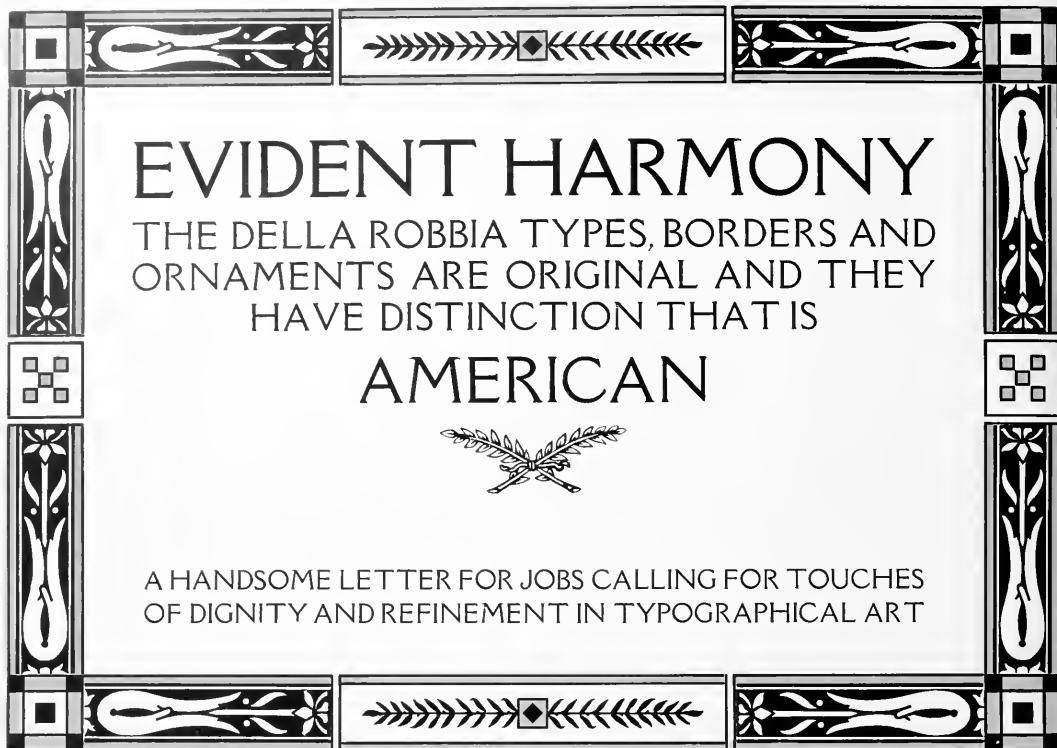

EVIDENT HARMONY

THE DELLA ROBBIAS TYPES, BORDERS AND ORNAMENTS ARE ORIGINAL AND THEY HAVE DISTINCTION THAT IS

AMERICAN



A HANDSOME LETTER FOR JOBS CALLING FOR TOUCHES OF DIGNITY AND REFINEMENT IN TYPOGRAPHICAL ART

Della Robbia Borders Della Robbia Ornament Monotone Border Cast Squares French Cast Squares



NEW TYPE DESIGNS

THEIR BUSINESS VALUE TO THE PROGRESSIVE PRINTERS

MEN realize that a successful business is the outcome of foresight, ingenuity and scientific business methods. Wherever you find a great business leading in its field, its success has been achieved by splendid business methods. Ask any printer what is the basic reason for the great success of this company and his answer will be "new and original type faces"

THE PRINTER FOUND THAT THE CUSTOMER'S EYE WAS CAUGHT BY THE NEW FACE; AND THAT THE PLEASING NOVELTY BROUGHT HIM MORE BUSINESS

AMERICAN TYPE FOUNDERS CO.

Della Robbia Border Della Robbia Initial



Qualities

THAT ARE OF INTRINSIC VALUE IN
TYPE DISPLAY AND MODERN TYPE
COMPOSITION FOR ADVERTISERS

NEW TYPE FACES

HE many new type faces that have recently been brought out by this Company are certain to put gold in the coffers of all the printers and advertising men. Their many good qualities are quickly appreciated by the discerning printer. They all have that distinction and pleasing novelty that are so characteristic of American type faces. A more truly artistic and classical showing of type designs has never appeared before in the entire history of movable types

□ American Styles Lead



AMERICAN TYPE FOUNDERS
COMPANY

ORIGINATOR AND MAKER OF
FASHIONABLE TYPE DESIGNS

72 Point

3 A \$7 90 4 a \$4 35 \$12 25

REMINDS
Bright Novel

60 Point

3 A \$5 70 4 a \$3 50 \$9 20

NICE BIRDS
Oriental Despot

48 Point

3 A \$4 15 6 a \$3 50 \$7 65

CHOICE MINES
Grand Easter Hymn

42 Point

4 A \$3 50 6 a \$2 75 \$6 25

STRONG RIDERS
Orchestral Entertainers
Curfew Rings Monthly

36 Point

1A \$2.80 8a \$2.20 \$5.00

DECEMBER QUERIES
Organization Depletes Bank
Inhaled Dangerous Perfumes

30 Point

6A \$2.50 11a \$2.10 \$4.60

INSURED OCEAN LINER
Members of Parliament Entertain
Established New Liability Branch

24 Point

6A \$1.80 13a \$1.80 \$3.60

BINDING MACHINE CONCERN
Modern Specification and Drafting Outfit
Sentimental Contractor Relieved Boynton

18 Point

9A \$1.70 20a \$1.55 \$3.25

NUMEROUS EVENTS
Sarcastic Oration Delivered
Diplomatic Maidens Rejoice

10 Point

19A \$1.25 40a \$1.25 \$2.50

HANDSOME PRIZE RECEIVED
Beautiful Souvenir Presented to Lucky
Competitor Amid Deafening Cheers and
General Rejoicing at the Second Annual
Flower Exposition Held in Podunk Hall

14 Point

13A \$1.50 28a \$1.50 \$3.00

CONSIDERED PUBLIC MEN
Lithography and Engraving Influence
Inspector Dictated Stenograph Notes

8 Point

23A \$1.05 47a \$1.20 \$2.25

EXPERIENCED SALESGIRL PROMOTED
Bright and Ornamental Array of Jewelry and
Precious Stones on Exhibition at Our Recently
Enlarged Show Rooms. Charmed Amulets and
Oriental Trinkets to Delight Sentimental Dames

12 Point

16A \$1.45 36a \$1.30 \$2.75

ENTERPRISING FIRM HONORED
Remarkable Newspaper Editorials Criticised
Brilliant Authors Receive Scathing Rebukes
Magnificent and \$1234567890 Characteristic

6 Point

24A \$1.00 54a \$1.00 \$2.00

MARKET SCENES IN MOUNTAINS OF EUROPE
Scattered at Short Intervals Along the Skirts of the Valleys
In Spring the Melting Snow Has Replenished Every Corner
Great Nations of Earth and Recognized Commercial Marts
Decorative Material in Individual Border Units Are Handy
Many Satisfied Customers Appreciate Our Prompt Service
Now Selling Useful Series \$1234567890 At Body Type Prices

The and tt of

These Special Characters accompany each font

RICH LOCKS



The Rich Locks are manufactured for every purpose in the home, office or public building. Our line includes also Builders' Hardware of many styles and prices. The Rich trade mark is a positive voucher, assuring perfect mechanism, workmanlike finish and good design. For nearly a half-century our locks have given real service and security as well as beauty to some of the finest mansions. When you contemplate building, you can do no better than specify Rich Locks and hardware to your architect. You can go even further than we by asking us for our Book of Design. This will bring to you suggestions on hardware in harmony with every style of architecture and interior design. We want you to see it—a sample is waiting your approval

MADIN-EMERSON
CHICAGO NEW YORK

Pabst Border Versatile Ornaments

The HURD BOOK

tells all about *Jewelry*, Diamonds, Precious Stones, Silverware, Cutlery and other articles for gifts on any occasion. It contains sixty pages of reading matter as interesting as any novel of the day. Free for the asking.

Our system of selling by mail appeals to people of refinement who prefer the quiet and comfort of their own library to the confusion and business atmosphere of the average shop.

We send *The Hurd Book* free to those who ask for it, and after several articles have been selected by their description, we will send on the goods for personal inspection.

HURD MAIL ORDER COMPANY

EXCHANGE AND BROAD STS., CHICAGO

NORTH AND TREMONT STS., DENVER

The Pabst Oldstyle and Pabst Italic

are especially adapted for that class of printing which attracts the eye of the man who knows. A fine book and job letter with characteristic features which make it adaptable for all kinds of work. There are not many letters more available for all around use, and it will give an air of distinction to the best of work. Made in 13 useful sizes, 6 to 72 point

American Type Founders Company

Pabst Border Busha Ornaments

Marlin and Marlin wish to announce
the Opening on

December Twentieth

of the entire First Floor of their present premises at

15 East Grand Street

to be used exclusively for their

Ladies' Shoe Service

Elevator in Connection

As Thomas Durkinson sole representatives in New York, we are showing exclusively the complete 1913 line of fashionable Hand-sewed Footwear by the Thomas Durkinson Custom Shoe Shops, the world's greatest shoemakers

Priced at \$7 upwards

Your interest is cordially invited

**MARLIN
&
MARLIN**

Bootmakers for Men, Women and Children

15 East Grand St., New York

Custom Department Entrance on Eighth Street



Busha Ornaments

Pabst Italic

72 Point

Special Characters \$2 45 per font

3 A \$8 05 4 a \$4 20 \$12 25

THICKER
Same Experts

60 Point

Special Characters \$2 25 per font

3 A \$7 20 4 a \$3 60 \$10 80

DEMOLISH
Plumber Injured

48 Point

Special Characters \$1 50 per font

3 A \$4 25 6 a \$3 25 \$7 50

REPLENISHED
Beautiful Manicurist

42 Point

Special Characters \$1 25 per font

4 A \$3 70 6 a \$2 55 \$6 25

FRENCH COURT
Greater Profits Reported
Insurgent Hunted Native

Pabst Italic

36 Point

Special Characters \$1.40 per font

5 A \$3.45 7 a \$2.05 \$5.50

EXCITED RUSTLER
Question Romantic Burglars

30 Point

Special Characters \$1.00 per font

5 A \$2.35 7 a \$2.05 \$4.40

PERFECTED MOULDERS
Amateur Performer Signs Contract
Capable Mechanics Examined Boiler

21 Point

Special Characters \$0.75 per font

6 A \$2.00 10 a \$1.50 \$3.50

DELIVER GOLDEN TRUMPET
Bohemian Silversmith Instructing Pensioner
Noteworthy Playwrights Organized Society

18 Point Special Characters \$0.50 per font 9 A \$1.80 16 a \$1.45 \$3.25

GOTHAM STUDENT
Ferocious Elephants Captured
Ireland and the Blarney Stone

10 Point

16 A \$1.35 38 a \$1.15 \$2.50

REMARKABLE GRADUATE
Youthful Prodigy Surprised Physicians
English Athlete Defeated in Great Race
Neat Letters for Book and Job Printers
Brigands Demand Two Hundred Cents

14 Point

12 A \$1.70 26 a \$1.35 \$3.05

JERSEY POLICE RETURN
Lumber King Speculating His Money
Rustic Homesteads Nearly Destroyed

8 Point

21 A \$1.25 42 a \$1.00 \$2.25

CONDEMNNS DANGEROUS STAGING
Unusual Ceremony Preceding Annual Convention
Balmy Summer Evening in Eastern Pennsylvania
Fisherman Returns From Voyage Around World
Oarsmen Collapse After Most Gruelling Contests

12 Point

16 A \$1.50 35 a \$1.25 \$2.75

FOUND UNDESIRABLE PONIES
North River Sailors Rescued Plucky Captain
European Scientist Delighted Austrian Prince
Clever Dancers \$1234567890 Refuse Money

6 Point

22 A \$1.05 49 a \$0.95 \$2.00

ARMY GENERALS EXPECTING PENSIONS
Unsophisticated Californians Enlisted for Twelve Months
Record Crowds Attending Seventh Annual Entertainment
Flourishing Oklahoma Towns Become Thronged With Men
Missouri Banking House Advertising Golden Opportunity
Judge Scored Famous Attorney at Trial of Young Aviator
Beautiful Pabst Figures \$1234567890 Delighting Customers

A B D G M N P R T

These Special Characters are put up with all fonts from 6 to 14 Point inclusive. They are sold in separate fonts from 18 to 72 Point inclusive

72 Point

3 A \$6 45 4 a \$3 80 \$10 25

PRINCETON
Direct Thought

60 Point

3 A \$5 90 4 a \$3 35 \$9 25

INSTRUCTED
Explorers Refuse

48 Point

4 A \$4 25 6 a \$3 25 \$7 50

SOME NEW TYPE
Gives Pleasing Result

36 Point

5 A \$2 65 9 a \$2 35 \$5 00

PROFIT AND PLEASURE
Undesirable Material Removed
Installing Seven Useful Designs

30 Point

5 A \$2 00 12 a \$2 25 \$4 25

INTEREST MODERN PRINTERS
Required Only Finest Printing Material
Foremost Composition Improvements

24 Point

6 A \$1 70 14 a \$1 80 \$3 50

DEMAND SCHEDULED REDUCTIONS
Movable Signs Resemble Engravers Products
Combinations Easily Recognized From Chart

18 Point

10 A \$1 55 22 a \$1 70 \$3 25

EXQUISITE ADVERTISING SERIES PRODUCED
Mature Satisfaction Recognized Judgment of Customers
When Maintaining Best Printing Construction Material

14 Point

16 A \$1 50 30 a \$1 50 \$3 00

MODERN TYPE FACES INTEREST DISCERNING PURCHASERS
Ingenuous Semblance of Engraving Process Accomplished Without Trouble
Artist Featuring Many Desirable Characteristics Throughout Entire Series
Show Splendid Typography with American Type Founders Company Type

12 Point

18 A \$1 35 38 a \$1 40 \$2 75

ADVERTISERS STUDY TYPE DESIGNS
This Education Cultivates Demand for Printing
Worth More Than Could Have Been Without
The American \$1234567890 Type Founders

8 Point

26 A \$1 15 50 a \$1 10 \$2 25

SPECIAL POLICEMAN RETURNS LOST RING
Large Excursion Parties Left Iron City Memorial Day
Striking Handsome Cover Design Received First Prize
Original Conception Made Typographical Critic Ponder
Modern Establishments Used Avil Series Extensively
Finest Magazine Advertisements Reproduced in Paper

10 Point

20 A \$1 20 42 a \$1 30 \$2 50

REFORMED TYPOGRAPHICAL MATERIALS
These Great Type Designs Captured the Advertising
Genius Everywhere. Materials Consistently Formed
Discovered Having Immense Potency in Advertising

6 Point

28 A \$1 00 52 a \$1 00 \$2 00

TYPES ON PAR WITH COLLECTIVE ART KNOWLEDGE
Startling Report Concerning Icebound Explorers Received Monday
Furnished Auditorium Sheltered Bankrupt Composers Out West
Great Delegation Headed Movement Regarding Suburban Service
Foreigner Made Ludicrous Mistake While Attempting to Converse
Many Notable Personages \$1234567890 Give Much Valuable Time

THE
TWENTIETH CENTURY
DECORATION

Derbrand

Wall Papers



AWARDED SPECIAL
GOLD MEDALS FROM
FAIRS, EXHIBITIONS
AND CONTESTS FOR
BEST HARMONY AND
THE FINEST DESIGNS

Send for Catalogue of Latest Price List and Patterns

Herthinson & Mulguerth

DESIGNERS AND IMPORTERS

Broadway and Sixth Avenue, Boston

Buyers of Printing

JUST A FEW WORDS TO THE BUSINESS MAN WHO DESIRES TO HAVE HIS PRINTING PRODUCED ACCURATELY AND PROMPTLY

Wouldn't it be a great relief if you could say to your printer, "I need a catalogue, a circular, some letterheads and envelopes," and then be able to entirely dismiss the matter from your mind in the confidence that he will do the work to your entire satisfaction. The printer comes to you with a proposition that pleases; that has a strong advertising value in the suggested copy, in the proposed typography, in the color arrangement, and in the general layout. What a satisfaction to have an assured confidence that the finished product will meet with your approval

The printer who can do that for you must offer efficient service. That is what we are giving to our numerous customers, and we are ready to do the same for you

Manders & Bredton Printing House
CORNER FREMONT AND EUCLID AVENUES, SINCLAIR, WISCONSIN

Wayside Ornaments Cast Squares

ANNOUNCEMENT

Our beautiful stock of stylish Spring Millinery, including many exclusive Paris Models, is now on display for the examination of our friends and patrons. This display is without doubt the finest ever exhibited in this city and affords the customer an excellent opportunity to make a satisfactory selection in both price and quality

MENDERING & REIDBERNS

Importing Milliners
BROAD AND NEW STREETS

Grill Border

72 Point

3 A \$7 25 4 a \$4 55 \$11 80

REMINDER
Hauling Car

60 Point

3 A \$6 55 4 a \$4 20 \$10 75

MARINERS
Flying Slowly

48 Point

4 A \$4 25 6 a \$3 25 \$7 50

NAMED JUDGES
Reward Endeavors

36 Point

4 A \$2 75 6 a \$2 25 \$5 00

AMERICAN HOUSE
Beautifying Expensively
Mighty Forces Growing

30 Point

5 A \$2 25 9a \$2 00 \$1 25

HUMOROUS DEPOSITOR
The University of Rushmorely
 Southern Merchants Complain

24 Point

5 A \$1 70 10a \$1 80 \$3 50

ADVISE HONEST SOLDIER
 Interesting Indictments Expected
 Home Discipline Gained Strength

20 Point

6 A \$1 55 14a \$1 70 \$3 25

DINERS REJOICED
 Enjoy March Banquet
 Ninety Invited Guests

10 Point

18 A \$1 25 36a \$1 25 \$2 50

ELEVEN HOUSES RANSACKED
 Daring Burglar Entered Fine Homes
 Along the North Shore Drive During
 Month of March and Secured a Large
 Amount of Clothing and Rare Jewels

18 Point

9 A \$1 60 18a \$1 65 \$3 25

DRIVERS HIT HORSES
 Insulting Rich Bystanders
 Discourage Mean Actions

9 Point

19 A \$1 25 38a \$1 25 \$2 50

STRONG MANSION CONSTRUCTED
 Artistic Decorations Recently Completed
 Delightful Garden and Beautiful Lawns
 Remarkable Exterior Commented Upon
 Magnificent Summer Resorts Described

14 Point

13 A \$1 45 26a \$1 55 \$3 00

FIREMAN RISKED FORTUNE
 Sharpers Captured Near Cleveland
 Remember Seven Eventful Nights

8 Point

20 A \$1 10 40a \$1 15 \$2 25

NUMEROUS ENTERPRISING FRIENDS
 Generous Support Secured The Nominations
 Bright Orations and Wonderful Pyrotechnics
 Dignified Candidates Rejected and Dismissed
 Lavish Display of Silk Hats and Frock Coats

12 Point

15 A \$1 35 32a \$1 40 \$2 75

HEMPBURG COUNCIL RESIGNED
 Resignations Handed Mayor Separately
 Taxpayers Making Mysterious Inquiries
 Report Short \$1234567890 Makes Denial

6 Point

23 A \$0 95 47a \$1 05 \$2 00

BOSTON STAPLE BINDERS AND POPULARITY
 The Machine Has Been a Boon to Printers in General
 Handsome Type Faces Are Cast on American Line
 New History of Printing and Its Great Development
 Celebrated Resorts in Germany and Other Countries
 Government Exercises Influence in New Possession
 Beautiful Sentiment \$1234567890 Celebrate Prosperity

A M R r y of *The* 

These Special Characters are furnished with each font, except the Ornament,
 that being furnished with sizes from 6 to 12 Point inclusive

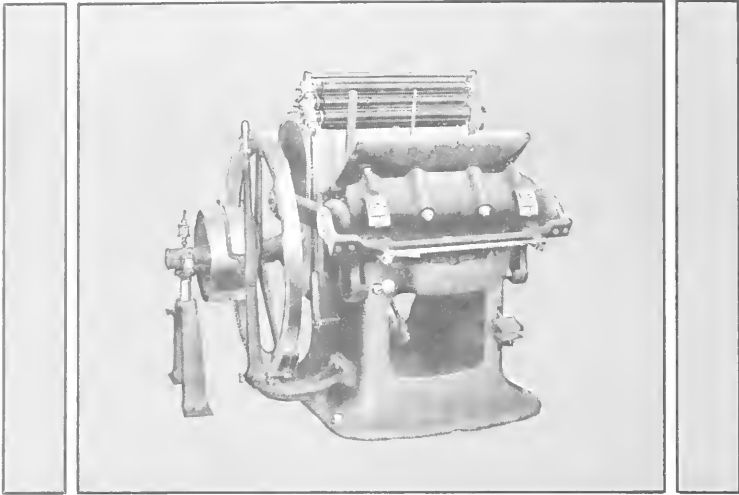

THE SYNTHESIS OF QUALITY



CONSTRUCTION of the best grade, comprising material and workmanship; general fitness, with a complete knowledge of the art; the builder's integrity and ability of first order, and a design embodying an idea of the laws of motion, will, according to the immutable law of cause and effect make up a first-class piece of work of quality—in this case, a printing press, known to the trade the world over as a "Colt's Armory" Platen Printing, Scoring and Embossing Press.

Ⓒ Judgment is a factor. A watch having an uncompensated balance wheel can readily be so finished that its cost would equal that of a Dent chronometer; yet as relates to its prime function, "it wad na be worth a tinker's dom!" It simply would be lacking quality.

Ⓒ Then, if a platen is so controlled that, when impinging upon the form, to prevent it from transversing the arc of a curve it must be compelled by opposing means to move in a straight line, it is a hundred to one shot that the misalliance will not endure. That is, in its dominant principle it is deficient in quality. That's simple.

Ⓒ Quality is relative. A mechanic might, with a hand tool, form a microscopic screw and the thread thus fashioned may compare favorably with that produced by precise mechanism; but, if time is considered, the manual method merely exhibits dexterity—like a Master Printer who successfully operates a Silurian machine.

Secure Quality if You Would Produce Quality

The CAROLINA
SCHOOL *of* ART

FOR YOUNG MEN *and* WOMEN

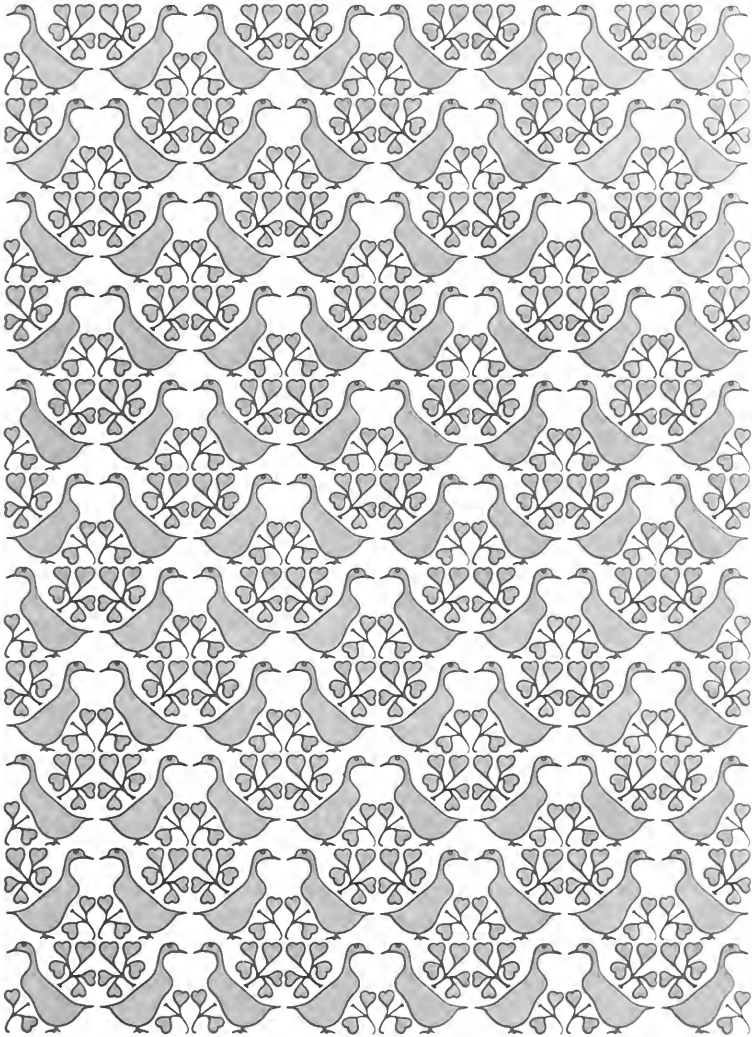

at HAGENSVILLE

72 Point

Special Characters \$1 30 per font

3 A \$7 05 4 a \$4 45 \$11 50

MENDERS
Holds Guest

60 Point

Special Characters \$1 00 per font

3 A \$6 15 4 a \$4 15 \$10 30

SOMETHING
Bridge Special

48 Point

Special Characters \$0 75 per font

3 A \$3 75 7 a \$3 85 \$7 60

INDORSEMENT
Hunting Elephants

36 Point

Special Characters \$0 50 per font

4 A \$2 65 7 a \$2 50 \$5 15

FINE SHOEMAKERS
Composed Catchy Songs
Entertained Blacksmith

Bookman Italic

30 Point

Special Characters \$0.30 per font

5 A \$2.10 9 a \$2.15 \$1.25

*ENLIGHTEN INK MIXER
Special Ingredients Required
Customer Hints Repeat Order*

24 Point

Special Characters \$0.25 per font

5 A \$1.70 11 a \$1.80 \$1.50

*DISGUISED JOKES EXPOSED
Editors Smiling Acknowledgment
Tremendous Outburst of Laughter*

18 Point

Special Characters \$0.25 per font

9 A \$1.55 18 a \$1.70 \$3.25

*HAND SHAKERS GIVE BIG EXCURSION
Outing of Yesterday Conceded Record Breaking
Evidences Phenomenal Increase of Organization*

14 Point

11 A \$1.50 23 a \$1.50 \$3.00

*UNEARTH CURIOUS RELIC
Ancient Quaint Stone Instrument
Monster Crowd From Country
Miners Excavating Paying Ores*

9 Point

18 A \$1.20 37 a \$1.30 \$2.50

*CAPTURING STUPID BURGLAR
Books, Title Pages, Catalogs, Stationery
Bookman Italic Very Useful Production
Enhanced Unusual Ornamental Effects
Elite Touches Imparted to Composition
Desirable Individuality Given to Printing*

12 Point

13 A \$1.30 27 a \$1.45 \$2.75

*WELCOME SPRING SUNSHINE
Actors Spend Vacation Near Paris
Wild Flower Growing Near Roadside
Frightened \$1234567890 Speculator*

8 Point

19 A \$1.10 38 a \$1.15 \$2.25

*DISCOVERS ANOTHER LARGE TREE
Hardwood Lumbering World Again Startled
Alleged Dimension Eclipse Former Records
Fancied Authentic Account to be Confirmed
Party Having Good Reputation for Veracity
Selected to Make Necessary Measurements*

10 Point

16 A \$1.20 34 a \$1.30 \$2.50

*HORSE RACING EXHIBITION CLOSES
Last Day Brings Out Unusually Large Crowd
Handsome Specimens Native Thoroughbreds
Remarkably Clever Equestrian Performances
Smart Youngsters Learned Trade Very Fast*

6 Point

22 A \$1.00 44 a \$1.00 \$2.00

*EARLY MORNING FIRE DESTROYS HOTEL
Fire Fighting Heroes Awaken the Slumbering Guest
Exciting Stampede - Pandemonium Reigns Supreme
Half Dazed Men, Women and Children Scantly Clad
Rush Down the Frosty Iron Fire Escapes Recklessly
Stories of Wonderful Escape from Crashing Timbers
Timely Rescue; Wealthy Hermit Nearly Asphyxiated
Handsome Building \$1234567890 Total Wreck, Cost*

A M R S s y

These Special Characters are put up with all fonts from 6 to 14 Point inclusive.
They are sold in separate fonts from 18 to 72 Point inclusive.

NOTICE

The past 6 numbers of *The Prospect*, September to February inclusive, will be delivered free if this rare offer is accepted before Monday the 21st day of April

Twenty Impressions of Kreand's Engravings. Over one hundred Short Stories and Verse and Illustrations of the *Prospect* sort

The Mandur Co.
Mirandy Avenue
Savannah, Georgia



Contentment

Let us learn to be contented with what we have. Let us get rid of prejudices and false estimates, set up the higher ideals—a quiet home; vines of our own planting; a few books full of the inspiration of a genius; a few friends worthy of being loved and able to love us in turn; a hundred innocent pleasures that bring no pain or sorrow; devotion to the right that will never swerve; a simple religion empty of all bigotry, full of trust and hope and love—and to such a philosophy this world will give up all empty joy it has.



Compliments of

Moreland & Klingsman

Abbottsville, Vermont

72 Point

3 A \$7 25 4 a \$4 55 \$11 80

RESPONSE
Ladies Dined

60 Point

3 A \$6 55 4 a \$4 20 \$10 75

BUCK FENCE
More Delightful

48 Point

4 A \$4 25 6 a \$3 25 \$7 50

INCOME RAISED
Northern Producers

36 Point

4 A \$2 75 6 a \$2 25 \$5 00

REDUCTION ASKED
Unusual Animals Found

30 Point

5 A \$2 25 9 a \$2 00 \$4 25

DESIRE ELEGANT STYLE
Entertaining Country Relatives

24 Point

5 A \$1 70 10 a \$1 80 \$3 50

EMINENT BOYS ORGANIZE
Social Parties Held During Month
Handsome Ladies Are Interested
Many Members Becoming Active

20 Point

6 A \$1 55 14 a \$1 70 \$3 25

IMPROVED CONDITIONS EXISTING
Printers Evidently Prosperous in Country
Recent Indications Denoted Advancement
Numerous Mechanics Rarely Unemployed

18 Point

9 A \$1 60 18 a \$1 65 \$3 25

SPEAKING ABOUT DURABLE TYPE FACES
Lining Oldstyle Antique Long Noted for Durability
Generally Found in All Up-to-Date Printing Offices
Much Better Results Obtained With New Material

14 Point

13 A \$1 45 26 a \$1 55 \$3 00

FINE AMERICAN PRODUCTS
Misconstrued Information Received
False Documents Presented Pupils
Principal Asked Rigid Investigation

9 Point

19 A \$1 25 38 a \$1 25 \$2 50

POLITICIAN ANSWERED REBUKE
Reports Submitted Are Considered False
Organizations Demanded Public Apology
Newspapers State System is Demoralized
Prominent Merchants Vigorously Protest
Harmony Prevails Along Political Circles

12 Point

15 A \$1 35 32 a \$1 40 \$2 75

FIERCE FIRE DESTROYS EASTON
Several Made Homeless by Conflagration
Big Department Store Completely Ruined
Damage Great \$1234567890 No Insurance

8 Point

20 A \$1 10 40 a \$1 15 \$2 25

RURAL GENTLEMAN VISITED CIRCUS
Greatly Amazed During Evening Performance
Comical Trained Animals Caused Amusement
Elephants Created Wild Panic During Parade
Marvellous Feats Performed by Young Indian
Red Lemonade and Peanuts Received Notice

10 Point

18 A \$1 25 36 a \$1 25 \$2 50

BURGLARS RANSACK COUNTRY HOMES
Residents Becoming Alarmed Throughout Town
Lone Highwayman Kidnaps Whole Police Force
Entire Population Now in State of Consternation

6 Point

23 A \$0 95 47 a \$1 05 \$2 00

BRIGHT PUPILS ARGUING CELEBRATED CASE
Noted Professors Preparing Strenuous Examinations
University Graduates Receiving Honorable Mention
State Normal Schools Participated in Recent Contest
Northern Educators Denounced Private Institutions
Religious Societies \$1234567890 Securing Considerable

60 Point

3 A \$6 15 4 a \$3 75 \$9 90

INHERITING
Robust Charm
Stronger Lines

48 Point

3 A \$3 70 7 a \$3 80 \$7 50

EXPERT DESIGN
Quality Considered
Selecting Buildings

36 Point

4 A \$2 35 9 a \$2 65 \$5 00

BRIGHT JOURNEYMEN
Studiously Improve Minds
Recognize Trade Literature
Unique Enthusiasm Found

30 Point

5 A \$1 95 11 a \$2 20 \$4 25

MODERN TYPE EQUIPMENT
Orders Receive Prompt Attention
Deferment is Manifestly Unwise

24 Point

6 A \$1 75 12 a \$1 75 \$3 50

EXPERIENCED SUPERINTENDENT
Realizes Enormous Cost of Time Bought
Improve American Material Extensively

18 Point

10 A \$1 60 20 a \$1 65 \$3 25

SPLENDID TYPE FOR GENERAL PURPOSES
Light Dorsey is a Peculiarly Adaptable Type Face
It May be Profitably Used on Many Kinds of Work
Besides it Has a Strong Companion Face in Dorsey

14 Point

14 A \$1 45 27 a \$1 55 \$3 00

LIGHT DORSEY FOR DISPLAY
Proper Types for Modern Printers
Creating Strong and Neat Display
Stylish Design Properly Executed

8 Point

22 A \$1 10 44 a \$1 15 \$2 25

THE MAIN ITEM OF EXPENSE IS TIME
Adequate Facilities Increase Products of Time
Every Time-Saving Facility Should be Utilized
An Ample Supply of Material Pays for Itself
Have You Enough Type, Leads, Slugs and Rule
Your Lost Time May Cost Enough to Buy This

12 Point

17 A \$1 35 33 a \$1 40 \$2 75

MANY HOURS LOST ON THE PRESS
Wonderful Electric Display Last Evening
Lost Time of a Compositor and Pressman
Guarantee \$1234567890 Chattel Mortgage

6 Point

25 A \$0 95 50 a \$1 05 \$2 00

COMPLETE COURSE OF PRINTING INSTRUCTION
Printers Study the Display Pages in Our Type Showings
And it is Our Aim to Make Them Instructive as Possible
These Pages Offer Suggestions for a Great Variety of Jobs
Which are Often Found Acceptable on Customers' Work
American Type Set in The American Way is Distinctive
Printers Should Order \$1234567890 American Type Faces

10 Point

18 A \$1 20 37 a \$1 30 \$2 50

THE PRINTER IS WORTHY OF HIS HIRE
Men Will Demand Just Reward for Themselves
Yet Browbeat the Printer Into Cutting His Price
Sauce for the Goose is Also Sauce for the Printer

5 Point

22 A \$0 95 44 a \$1 05 \$2 00

NOTICED CAREFUL GRADUATION OF SIZES CONTAINED
By Purchasing the Complete Series of the Beautiful Light Dorsey
One Can Print Nearly Any Kind of Job with Neatness and Speed
It Contains all the Qualities for First-Class Composition on Finer
Advertisements for Catalogues, Pamphlets, Booklets, Folders and
in Fact Everything that requires a Neat, Serviceable Type Face
Be Sure and Order an Abundance to be Prepared for Emergency

18 Point

9 A \$1 25 24 a \$2 00 \$3 25

*EIGHTY ENTHUSIASTIC ADVERTISERS REJOICED
PURCHASING BEAUTIFUL LIGHT DORSEY ITALIC
Kind Magistrate Sentenced Rough Prisoner to Lockup
Millionaire Manufacturer Bought the Fake Gold Brick
Weather Bureau Reports Heavy Rainfall in Michigan
Contain Delightful Typographical Usefulness Within*

14 Point

12 A \$1 25 32 a \$1 75 \$3 00

*ENTERPRISING COMPOSITOR SAVES MUCH VALUABLE TIME
HUNTING SORTS ABOLISHED IN ALL PROFIT MAKING SHOPS
Particularly Adapted for Magazine Advertisements and Fine Work
Royal Horseman Holds the Prominent Place in Coronation Parade
Printing Condition Much Improved by Scientific Type Manufacture
Craftsmen Demand Useful Borders and Ornaments for Best Work
Torpedo Boat Destroyers Sailed Northward via Boston Light Today*

12 Point

15 A \$1 10 43 a \$1 65 \$2 75

*HUSKY SERGEANT GAVE LOUD ORDERS
BOUGHT MODERN PRINTING MATERIAL
Best typography is getting away from all the
eccentricity that was formerly being used, it
being nearly eliminated; the circular should
be easy to read and not be overcrowded with
unnecessary ancient \$1234567890 type faces*

8 Point

18 A \$0 85 54 a \$1 40 \$2 25

*MONSTER GATHERING WELCOME HEROINE
DASHING BEAUTIES CAUSING ADMIRATION
One would think that this great Company, with
its infinite variety of faces, would rest content
on its laurels and forego the trouble and expense
of constantly issuing new faces. But this it must
not and will not do. This Company knows that
the printer is calling for new faces, because they
bring him new customers and also hold his old
ones. As long as this Company leads this branch
of the printing industry, it will maintain custom*

10 Point

16 A \$0 95 47 a \$1 55 \$2 50

*HANDSOME DESIGNS RETURNED YESTERDAY
MANY NOTABLE GENTLEMEN RECEIVED PIES
The American Type Founders Company produced
and sold many new faces, the total volume of its
business increased; from this policy of increasing
volume by giving the printer what he wanted, and
decreasing cost of manufacture and an increasing
excellence of the product was born the leadership*

6 Point

21 A \$0 75 63 a \$1 25 \$2 00

*SCORCHING AUTOMOBILE STRIKES TELEGRAPH POLE
SUPERB TYPE QUALITIES INTRODUCED EXTENSIVELY
The business men of the United States are better educated
on type than are those of any other country in the world.
The printing press of this country is educating everyone to
demand better printing. Eccentricity of composition has
been used so much, and so thoroughly tried out, that it has
practically been relegated to the past as useless. Today and
tomorrow call for plain, sane, easily-read composition, well
printed. Since this kind of printing is almost standardized,
the only way in which novelty and difference can be obtained
is in the use of the newer display faces in their various sizes.
Buying faces is a great \$1234567890 help to the compositor*

The Dorseys in Combination

MUNCY ORIGINAL TYPOGRAPHY OUR HOBBY Telephone 248 Main **Art Print**

*Letterheads, Billheads
Cards, Circulars, Folders
Fine Booklets, etc.*

WE NEVER DISAPPOINT A CUSTOMER ON A PROMISE. YOU GET THE JOB WHEN IT'S DUE

251 HERIM AVENUE



Cast Squares Art Ornaments Hapgood Floret Hello Cut

Printing for Profit



MUNCY quality and style are by far the best obtainable for many miles around. Fitted up with the best of equipment and new and up-to-date material. Our men are artists in every sense of the word. Located in the business center of the city, within easy reach of supply houses, prompt shipment of our supply orders is thus insured, which, in return, warrants a quick and convenient execution and delivery of the finished product promptly at the time promised

AS DONE
BY THE
BUSY PRESS

THE MUNCY ART PRINT

641-643 Henry Street

BOWLING, TEXAS



72 Point

3 A \$8 60 4 a \$5 30 \$13 90

HENRIKS
Gold Metal

60 Point

3 A \$7 45 4 a \$4 65 \$12 10

ESTHETIC
Great Stand

48 Point

3 A \$4 60 4 a \$2 90 \$7 50

NORTH FORK
Rare Specimen

36 Point

3 A \$2 55 6 a \$2 45 \$5 00

BRIGHT COMPOSER
Dismounted Rounders
Mechanics Exposition

30 Point

4 A \$1 95 9 a \$2 30 \$4 25

FINE DORSEY SHOWING
Increase Distinct Harmony
Modern Type Faces Shown

24 Point

5 A \$1 65 10 a \$1 85 \$3 50

EXCURSION BEARING WEST
Mutineers Proclaim Sentiments
Every Question Being Arbitrated

18 Point

8 A \$1 55 15 a \$1 70 \$3 25

WONDERFUL SPECIMEN EXECUTED
American Line Type Faces Please Printer
Refined Theatrical Performance Coming

14 Point

10 A \$1 35 22 a \$1 65 \$3 00

THE ORIGIN AND FOUNDATION OF PRINTING
Binding Books Carries Us Back Perhaps More Than
Thousand Years, When Very Heavy Lead Tablets
With Inscribed Hieroglyphics Were Put Together

12 Point

14 A \$1 35 26 a \$1 40 \$2 75

STANDARD LINING MATERIAL
Gives Success to Every Up-to-date
Printer and the Use of Distinctive
Type Faces for a Booklet or Other
Attractive Printing \$1234567890

8 Point

18 A \$1 10 35 a \$1 15 \$2 25

EXPERIENCED CATALOG PRINTER
Remarkable Designs Perfectly Drawn
Conservative Newspaper Publications
International Exposition in Petersburg
All Striking Characteristics Illustrated
Interviewed Progressive Typographers
Wonderful Tales of Strange Countries

10 Point

15 A \$1 20 30 a \$1 30 \$2 50

BARGAIN IN REBUILT MACHINERY
We Have Always Taken Great Interest
in Working and Doing Everything for
the Prosperity and Welfare of Printing

6 Point

20 A \$0 95 35 a \$1 05 \$2 00

ENTERPRISING PRINTERS SUGGESTIONS
The Other Day One of Our Customers Wanted
A Post Card Announcing His Taxicabs for the
Auto Races. He Did Not Know What He Was
Going to Get Until He Saw the First Proof; Then
He Was Tickled. We Secured \$1234567890

TYPE

BORDERS, ORNAMENTS
BRASS RULE, WOOD GOODS
AND OTHER SUPPLIES



IT is fast coming to the point where the office with antiquated equipment will be so much handicapped that soon it will be impossible to show a profit on work produced under those conditions. Savings are being made in labor and floor space which must eventually influence and finally control prices of printing. One of the principal factors in the saving of labor as well as floor space is our line of Modernized Printing Office Furniture. Do you want to make a saving of 33 per cent. in labor and 50 per cent. in floor space? If so, immediately ask for more detailed information and booklet

American
Type Founders
Company



Are You
Playing
Santa
Claus

to a
MAN
or
BOY
this
year?

**MISTER
& SON**

HABERDASHERS
21 South Meekin Street
KIRTSHAM, IND.

It will be very gratifying to holiday shoppers when they visit our large store and find the great variety of beautiful showings, such as young and old appreciate at this time of year. Useful presents in our various departments cannot be equalled by other firms. An invitation is cheerfully extended all to inspect this wonderful showing of goods appropriate for the season's business. Tea served ladies



PROMPT DELIVERY

We wish to call your special attention to our Gents' Furnishing Department, which cannot be praised too highly; with such a varied line to select from, one will have comparatively little trouble in selecting a handsome holiday present for a gentleman

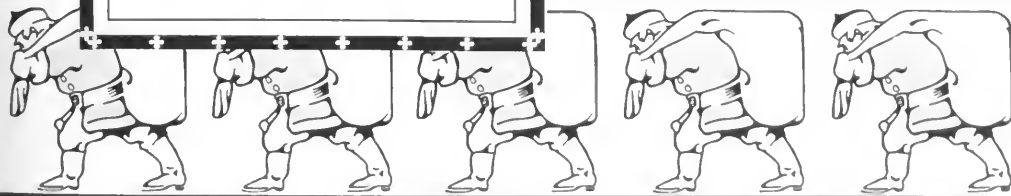

72 Point

3 A \$7 20 4 a \$4 35 \$11 55

PRODUCED
Make Engine

60 Point

3 A \$6 15 4 a \$3 75 \$9 90

HURTS KING
Shows Quality

48 Point

3 A \$3 70 7 a \$3 80 \$7 50

MONEY CHOSEN
Production Greater

36 Point

4 A \$2 35 9 a \$2 65 \$5 00

DELIGHTFUL HISTORY
Modern Printing Materials
Handsommer Display Letter

30 Point

5 A \$1 95 11 a \$2 39 \$4 25

CONDENSED SERIES CHARM
Buys Modern Dorsey Installment
Desired Sensational Performance

24 Point

6 A \$1 75 12 a \$1 75 \$3 50

SECURING CURIOUS ENTERPRISES
Considered Determined Bankers Lightly
Instantly Answered Strenuous Remarks

18 Point

10 A \$1 60 20 a \$1 65 \$3 25

BUILDING LONGEST NORTHERN RAILROAD
Our Superior Material Brought General Satisfaction
Distinct and Original American Type Faces Pleased
Recognizing Foreign Mechanics Through Invention

14 Point

14 A \$1 45 27 a \$1 55 \$3 00

PUBLISHERS DESIRE SERIES
Our Gifted Senator Shows Ability
Inspiring Orations Delight Crowd
The Extraordinary Characteristic

8 Point

22 A \$1 10 44 a \$1 15 \$2 25

RUSH HINDERING ARTISTIC PRINTERS
Abolished Tyrant Rulers Who Enjoyed Cruelty
Husky Infants Cried Lustily During Luncheon
Strongest Banks Easily Wrecked by Dynamite
Extensive Mountain Range Climbed by Expert
Great Aviation Feats Performed by Foreigners

12 Point

17 A \$1 35 33 a \$1 40 \$2 75

PRINTS MODERN ADVERTISEMENT
Newspapers Demanded Condensed Dorsey
Requiring Honest Typographical Standard
American Type Founders Company Faces
Finest Stories \$1234567890 Ever Written

6 Point

25 A \$0 95 50 a \$1 05 \$2 00

ENTERPRISING HOUSES ADVERTISED HEAVILY
Insurance Collectors Entertain Many Prominent Guests
Entire Series Show Qualities that Aid General Printing
Distinct Results Obtained Easily with American Border
Exquisite Style Shown Throughout Our Specimen Pages
European Acrobats Displayed Great Energy While Here
This Legible and Readable Type is of Unusual Durability
Popular American Line Type Styles Strongly Advocated
Modern Plants Kept \$1234567890 Busy Throughout Season

10 Point

18 A \$1 20 37 a \$1 30 \$2 50

MANY RESOLUTE COMRADES AROUND
Housewife Complains About Nearly Everything
Chiromantic Developments Explained Publicly
Makes Beautiful Ornaments and Borders Today
Lightning Strikes Old Church Tower Near Top

5 Point

22 A \$0 95 44 a \$1 05 \$2 00

CONDENSED DORSEY PLEASING CRITICAL CUSTOMERS
Curbstone Orator Secured the Reforms by Threatening Exposure
Thoroughbred Cattle Noticed Browsing Upon the Mountain Slope
Daring Acrobatic Feats Performed by Famous Athletes of Europe
Continuous Performance Every Night and Special Friday Matinee
Last Appearance in this County of the Celebrated Animal Trainer
Boston Wire Stitcheer Proved a Wonderful Labor Saving Machine
Buying Plenty of Finest Disolay Type and Handsome Ornaments

PRINTING

EMBOSSING and DESIGNING



HERE is no other investment that brings such sure and constant profits as printed salesmanship as we do it. There is no other method of getting business so inexpensive. While you are thinking of our booklet you may be in need

of billheads, letterheads, labels or receipt books.

Now is the time to follow in the footsteps of that army of successful merchants who are, in making fortunes for themselves, building up the great printing industry so rapidly. Let us do your printing.



The
BRICE & JOHNS
PRINTING HOUSE

CHICAGO

NEW YORK

BOSTON

Della Robbia Border Knickerbocker Ornate Department Store Initial

You Should Keep Your Policy In Force



"I thank you for the prompt payment of claim on my brother for \$435," writes a Millertown beneficiary. "I was much surprised when the agent gave me a check for \$20 more than the policy called for, because of a concession made to policyholders by The Hamberg. My brother was insured just a little over one year. I was going to let this policy lapse just two or three weeks ago, but your Assistant Superintendent spoke to me and showed me where it would help me out, in case my brother should die. I highly recommend The Hamberg Insurance Company to all those who are not insured."

The Hamberg

The time you think of letting a policy lapse is probably the time you are in need of it most



FASHIONABLE

KINGSBURG

BOOTS & SHOES

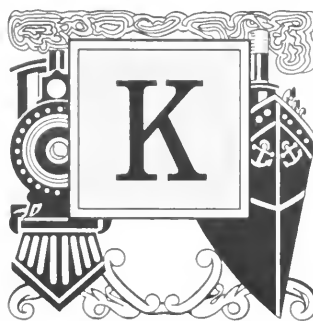

KINGSBURG SPRING
STYLE SHOE TALK

From the regular Kingsburg stock of Men's splendid shoes for spring wear we selected certain styles to sell at lowered prices because the sizes are broken and will not be replenished. Kingsburg quality is favorably known; even the most discriminating sportsmen appreciate it. Calfskin, button or lace, with the fashionable Parisian style toe-shape; stoutly built shoes with oak soles for hard usage. Latest styles in tan or black, calfskin and patent leather, the best hand-sewed shoes made for spring

Prices, ranging from \$3.50 to \$7.00, plainly woven in strips

S. J. KINGSBURG MAKER OF STYLISH FOOTWEAR HABITS PRINCEY, ME.

"Not the largest in size, but the biggest in quality"



72 Point

3 A \$6 85 4 a \$4 15 \$11 00

HUCKSTER
Dude Sought

60 Point

3 A \$5 85 4 a \$3 80 \$9 65

STERN JUDGE
Honor Burglars

48 Point

4 A \$3 95 7 a \$3 70 \$7 65

INSPECT BROILER
Meanest Cracksman

42 Point

4 A \$3 00 9 a \$3 70 \$6 70

GOTHAMITE SPENDS
Return Precious Charm
Prominent Californians

36 Point

5 A \$2 75 7a \$2 25 \$5 00

TOURED IRISH MARKET Spanish Prosecutor Argues

30 Point

6 A \$2 10 10a \$2 20 \$4 30

MARINERS FOILED TEXANS Justice Reprimands Lady Sleuth

24 Point

7 A \$1 80 11a \$1 75 \$3 55

HISTORIAN EULOGIZES MARTYRS Dreadful Explosion Wrecked Building Englishmen Remodel Oldest Mansions

18 Point

10 A \$1 55 20a \$1 70 \$3 25

NUBIAN HORSES DELIGHTED DUTCH JOCKEY Farmer Spends Independence Day Repairing House Lieutenant Explained Weather Signals to Recruits

14 Point

14 A \$1 45 28a \$1 65 \$3 10

YOUNG PRINTER INSTRUCTS Philosopher Chastised Promoters Hunters Injure Huge Grizzly Bear Bank Wrecker Given Long Term

10 Point

20 A \$1 15 40a \$1 35 \$2 50

WISE COMPOSITORS STUDY TYPES Appreciate Value of Old Familiar Face Used to Advantage on Many Occasions

9 Point

22 A \$1 15 44a \$1 35 \$2 50

MOST SENSIBLE AND STRONG FACES Advancing Interests of Many Advertisers Business Forms Supplied with Real Style

12 Point

16 A \$1 30 32a \$1 45 \$2 75

PROSPECTORS RETURNED FRIDAY American Marksman Captured Emblem Noted Speaker Addressed Large Throng Invested About \$1234567890 in Clothing

8 Point

22 A \$1 05 44a \$1 20 \$2 25

CONSTANT AND HEAVY DEMANDS MET Modern Printing Industry Rapidly Increasing Wonderful Strides Made in the Craft Progress

7 Point

24 A \$1 00 48a \$1 25 \$2 25

DESIGNERS PLEASING WITH LATEST IDEAS Peruvian Sailors Return After Long Ocean Voyage Useful Material Satisfying Foremost Young Artist

11 Point

20 A \$1 25 40a \$1 50 \$2 75

ATHLETIC YOUNGSTERS REVIEW RACES Surgeon Performed Startling Feat in Hospital Nurses and Inmates Gathering Close to Table Hospital Attendants Amazed at the Operation

6 Point

24 A \$0 90 48a \$1 10 \$2 00

CONSERVATIVE TYPE FACES ON AMERICAN LINE Leader in Type Fashion and Originator of Distinct Faces Discerning Printers Say American Line is the Best Line Fishermen Encounter \$1234567890 Terrible Ocean Current



SQUABS



How to Raise Them

The demand for squabs by high class hotels
 and restaurants has been so insistent in late
 years that prices for this toothsome dainty
 have steadily advanced. Here is an unusual
 opportunity for anyone with a little time
 and patience to make money. The author of
 this book is a pioneer breeder and authority
 on this subject and he has explained all the
 essential details so clearly that anyone can
Make Money From the Start

Panel Border Knickerbocker Ornaments Boston Breton Cast Squares

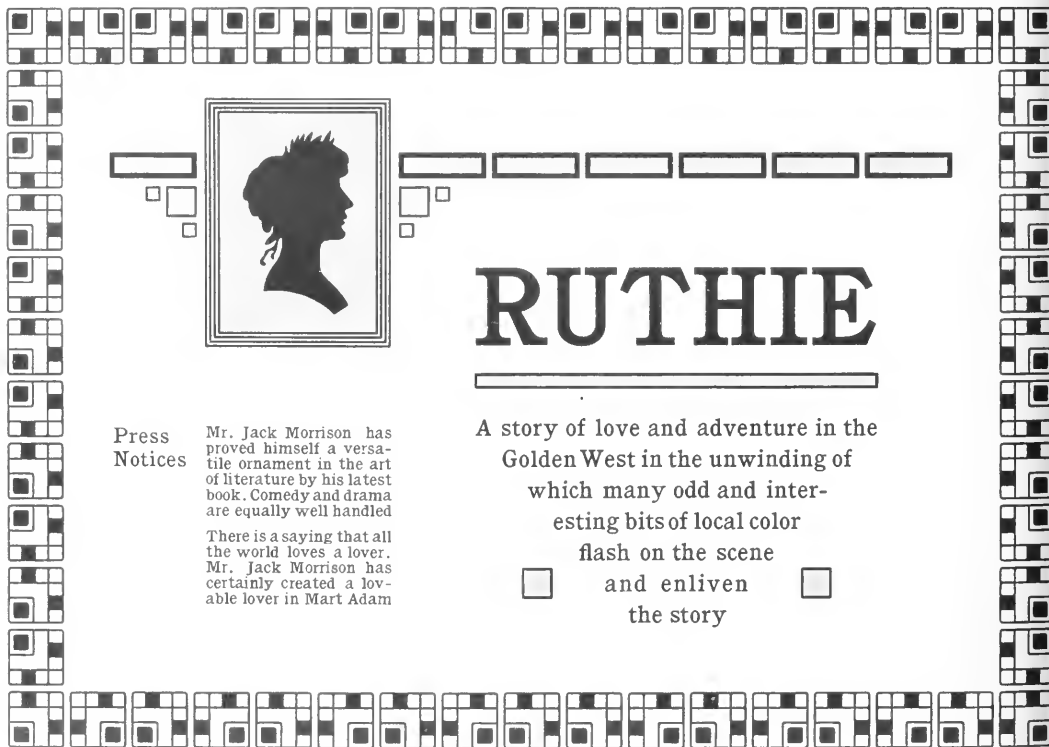

RUTHIE

Press Notices

Mr. Jack Morrison has proved himself a versatile ornament in the art of literature by his latest book. Comedy and drama are equally well handled

There is a saying that all the world loves a lover. Mr. Jack Morrison has certainly created a lovable lover in Mart Adam

A story of love and adventure in the Golden West in the unwinding of which many odd and interesting bits of local color flash on the scene and enliven the story

Vesatile Ornament Inland Border No. 2346

Inland Border No. 120621

DOUGH *in* BAGS



Proprietors of printing establishments upon realizing the efficiency of the American Type Founders Company's service will not hesitate in employing it, thereby outwitting the other fellow in proficiency of workmanship as well as in superior quality of the finished product. These are the two most vital points of the business; they count from the very beginning. Upon them you must depend for success and filling of your doughbag, unless you are in business for pleasure. American line material always proves a good investment because of its customer-pleasing features. Besides, the prices are within reach of even the smallest purse. We help you to business success



American Type Founders Company

Originator and Maker of Fashionable Designs in Type, Borders and Ornaments

Selling Houses Located Throughout the United States

72 Point

3 A \$6 50 4 a \$4 15 \$10 65

DIRECTORS
Printer Bright

60 Point

3 A \$5 25 4 a \$3 30 \$8 55

BARN RAISED
Steamer Delayed

48 Point

4 A \$3 90 7 a \$3 60 \$7 50

REDUCING PRICES
Important Publication

42 Point

4 A \$2 90 9 a \$3 35 \$6 25

HONEST YOUNG MEN
Always Find Employment
Neat Boys Generally Liked

36 Point

4 A \$2 10 9a \$2 60 \$5 60

NUMEROUS EXCURSIONS
Returning Rather Discouraged
Answered Interesting Question

30 Point

5 A \$2 05 10a \$2 20 \$4 25

ENJOYING PLEASANT DRIVE
Discussing Matrimonial Proposition
Minister Satisfied Love-Sick Couple

24 Point

6 A \$1 75 12a \$1 75 \$3 50

BROKEN ENGAGEMENT REPLACED
Homes Entered by Numerous Bold Burglars
Detective Unearths Notorious Outlaw Band

18 Point

10 A \$1 65 19a \$1 60 \$3 25

LINING CUSHING ITALIC
Handsome and Durable Series
Printers Recognize This Fact

10 Point

21 A \$1 15 46a \$1 35 \$2 50

PROVED STRONG DISPLAY SERIES
Lovely Lining Cushing Oldstyle Italic Type
Containing Numerous Exquisite Features
Printing Greatly Benefited by Ornaments
American Type Founders Company Maker

14 Point

14 A \$1 45 29a \$1 55 \$3 00

EMINENT SPEAKER RETURNS
Large Audience Greets Noted Editor
Former Politician Expected to Speak

8 Point

25 A \$1 05 54a \$1 20 \$2 25

REVIEWING GREAT MEMORIAL PARADES
Madison Avenue Crowded with Patriotic Strangers
Proud Old Veterans March Ahead of Long Column
Beautiful Music Rendered by Large German Bands
Great Speakers Paid Honor to Gray Haired Heroes

12 Point

17 A \$1 30 37a \$1 45 \$2 75

MEETINGS CREATING EXCITEMENT
Hundreds Interested in Wonderful Movement
Newspapers Claim Scheme is a Capital Idea
Receive Cash \$1234567890 Some Changes

6 Point

28 A \$0 95 60a \$1 05 \$2 00

GENERAL PUBLIC DEMANDING INVESTIGATIONS
Harmonious Results Obtained Using Lining Cushing Italics
Prosperous Merchants Securing Much Advertising Publicity
Sincere Compliments Extended Philanthropic Benefit Society
Thoroughly Demonstrating Manufactured Printing Material
Recommending Superlative Typographic Art Ornamentation
Ten Practical Figures \$1234567890 Distinctly Shown Here

FRAMES

THE LATEST AND MOST DELIGHTFUL CREATIONS



Spring Catalogue

Showing an extensive line of hand-tooled wooden art picture frames. This assortment includes the latest and best patterns, and will go a long way in aiding the housewife to make the home attractive

HARTMAIN & SINCLAIR

Number 749 North Market Street, MONROE, ILL.

Palset Border Graphic Border



Our new high-grade wardrobe trunk is a bureau and wardrobe manufactured to swing on one set of hinges, and designed to accommodate the sartorial equipment of both men and women. These trunks are the quintessence of convenience for the traveler, and their durability is a thing to marvel at. Made in thirty-one models, and sold at prices to suit the necessities of all

**Masterson's
Trunk Store**

CHOICE TRAVELING REQUISITES

19 Mapleton Street

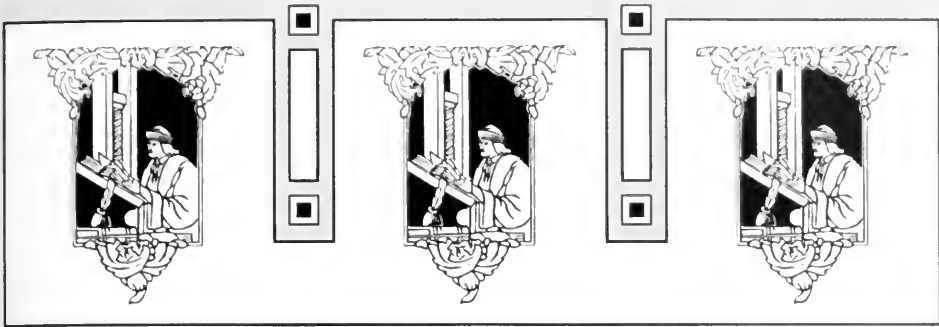

The *Colt's Armory* *Job Presses*

INDISPENSABLE WHEN
GOOD HALFTONE AND
ABSOLUTE REGISTER
WORK ARE NECESSARY

Among the heavy platen presses which are offered the printing trade for the best grade of printing the Colt's Armory Presses stand supreme. The printer who uses them thereby proclaims his superior status in the art. He has no annoying and expensive handicaps and can thus produce the very best of quality in the most economical manner. The demand for a press that will do heavy halftone printing, hot and cold embossing, paper-box cutting, and also high-grade job printing, is satisfactorily met by the Colt's Armory. Being well-known for their perfect construction and accurate results in color work, these presses are often supplanting less expensive and more lightly constructed presses in all offices where evenness of impression and absolute register are of paramount importance. No better impression or register can be obtained on any job press. As the largest buyers of Colt's Armory Presses the American Type Founders Company sells all sizes and styles to the best advantage of its customers. For terms and full details write our nearest Selling House

**AMERICAN TYPE
FOUNDERS COMPANY**

SELLING AGENT FOR COLT'S ARMORY PRESSES

Lining Cushing No. 2

24 Point

7 A \$1 90 11 a \$1 60 \$3 50

PRODUCED EXQUISITE DESIGNS
Several Important Cases Unexplained

18 Point

10 A \$1 70 18 a \$1 60 \$3 30

REFUSING MEMBERS
Hemrican Lodge Bankrupt
Fine Entertainment Given

10 Point

*15 A \$0 50

22 A \$1 25 45 a \$1 25 \$2 50

EXTENSIVE BUSINESS IMPROVED
Mining Interests Located Nearer Railroad
Thousands Invading Country District Daily
Large Products Delivered Various Dealers
Graceful Dancers Entertaining Publishers

14 Point

13 A \$1 45 28 a \$1 55 \$3 00

MINING ENGINEER SINKING
Extend Railroad Farther South
High Lands Remain Concealed

8 Point

*17 A \$0 50

22 A \$1 05 44 a \$1 20 \$2 25

MUCH MONEY JUDICIOUSLY EXPENDED
Retiring Bankers Build Magnificent City Homes
Large Sums Negotiated During Financial Strain
Fashions Admired by Fastidious Foreign Counts
Departing Noblemen Enthusiastically Cheered

12 Point

*12 A \$0 50

16 A \$1 30 36 a \$1 45 \$2 75

ENORMOUS STOCKS SOLD MONDAY
Numerous Familiar Faces Arrived Quickly
Big Dividends \$1234567890 Promptly Paid

6 Point

*20 A \$0 50

24 A \$0 95 48 a \$1 05 \$2 00

PRIVATE BUSINESS TRANSACTION REPORTED
Humorous Young Man Played Practical Jokes on Professor
Latest Reports From Headquarters Seem Very Favorable
Profitably Invested \$1234567890 Money Shows Results
Real Estate Business Showing Profitable Returns Daily

*Small Caps for sizes from 6 to 12 Point inclusive are fonted and priced by themselves and only sent when ordered

Lining Cushing Italic No. 2

24 Point

5 A \$1 30 18 a \$2 20 \$3 50

REPRODUCED AMERICAN INVENTION
Prosperous Merchant Received Nomination

18 Point

6 A \$1 25 25 a \$2 00 \$3 25

EXCITED MEN RETURN
Brokers Examined Realties
Many Ruins Reported Later

10 Point

14 A \$0 90 60 a \$1 60 \$2 50

EXTENSIVELY IMPROVED METHODS
Maintaining Greater Current with Electricity
Hundreds Remain Behind Looking for Success
Merchants Throughout the Country Advertise
Large Fortunes Frequently Procured Quickly

14 Point

10 A \$1 10 37 a \$1 90 \$3 00

HANDSOME CARDS ORDERED
Beautiful Enlarged Portrait Arrives
Roman Empires Recently Destroyed

8 Point

16 A \$0 85 63 a \$1 40 \$2 25

A BRILLIANT MANIPULATION INTRODUCED
Honorable Mention Given During Recent Examination
Profits Divided Monthly Among Several Stockholders
Nomination Sought During Early Summer Excursion
Banquet Given Students Before Leaving the Seminary

12 Point

12 A \$1 00 45 a \$1 75 \$2 75

UNIVERSITY STUDENT MAKES RECORD
Substantial Homes Devastated by Earthquakes
Money Saved \$1234567890 Money Earned

6 Point

16 A \$0 70 65 a \$1 30 \$2 00

DISPENSATION OF QUICK JERSEY STATE JUSTICE
Clever Lawyer Discovers Technicality While Arguing Cases
Powerful Influence Brought to Bear During the Investigation
Many Protest Against Methods Used by Country Proprietors
General Test Proves \$1234567890 Merchant to be Correct

36 Point

1A \$2 60 7a \$2 10 \$5 00

BRIGHT PUBLISHERS
Eight Soldiers Conquered
Dangerous Zebras Escape

30 Point

5A \$2 15 9a \$2 10 \$1 25

HUMOROUS PHYSICIANS
French Authority Heard Music
Remarkable Designer Explains

24 Point

6A \$1 80 11a \$1 70 \$3 50

STUDIOUS YOUTH ENTHUSES
American Fashions Please Craftsmen
Comic Opera Managers Joined Army
Imitating Graceful Portland Acrobats

18 Point

11A \$1 70 21a \$1 55 \$3 25

WESTERN MEN RETIRE
Lumber District Grows Rapidly
Tragedians Stranded Near Asia
Quaint Mansion Charms Tourist

10 Point

22A \$1 30 41a \$1 20 \$2 50

ADMIRER MOST CAREFUL ARTISAN
Clearest Faces Designed for Beautiful Book
New York Publishers Invited Old Resident
Jockeys Injured in Most Exciting Contests

8 Point

22A \$1 10 45a \$1 15 \$2 25

UNIVERSITY PROFESSORS QUALIFIED
Hunters Captured Strange Tropical Quadrupeds
Much Discussion Over Latest Infraction of Rule
Pressmen and Compositors Seeking Employment

12 Point

17A \$1 35 35a \$1 40 \$2 75

MEXICAN HUNTERS CHASE TIGER
Nation Honors Young Australian Discoverer
Unusual Excitement at Meeting of Bachelors
Durable Materials for Catalogue Composer
Jovial Crowds \$1234567890 Received Praise

6 Point

28A \$0 90 55a \$1 10 \$2 00

FARMERS TRAVEL FOUR HUNDRED MILES BY STAGE
Nine Beautiful Summer Evenings Spent at Rockaway Beach
Burglars Ransack Boudoir of Popular Young French Dancer
Thirsty Tourist Went \$1234567890 Two Days Without Drink

72 Point

3 A \$6 55 4 a \$4 25 \$10 80

MINE Shafts

60 Point

3 A \$5 60 4 a \$3 55 \$9 15

Dines PRINCE

48 Point

4 A \$4 05 7 a \$3 65 \$7 70

MONKEY Climbed

36 Point

4 A \$2 50 8 a \$2 50 \$5 00

Character MODERNIZED

30 Point

5 A \$2 05 10 a \$2 25 \$4 30

PROSPEROUS Hotel Owners

21 Point

7 A \$1 85 12 a \$1 75 \$3 60

DESCRIBE HORSE
Honest Investments

10 Point

22 A \$1 15 43 a \$1 35 \$2 50
12 A \$0 50

SHOWING EXQUISITE FEATURES
MORE Holiday Presents Being Received
Fires Destroyed Beautiful State Houses
Remove Columbian Machinery Exhibit

20 Point

8 A \$1 65 15 a \$1 60 \$3 25

FISHERMEN DROWN
Departed Easter Sunday

9 Point

23 A \$1 20 46 a \$1 30 \$2 50
14 A \$0 50

EXCURSION STEAMERS REMARKABLE
ALARMED Over Many Threatening Notices
Children Rendered Delightful Entertainment
New Counties Demand Equalization Boards

18 Point

11 A \$1 60 22 a \$1 65 \$3 25

SENTRY FIRED SIXTY SHOTS
Heavy Order of French Oldstyle

8 Point

24 A \$1 05 48 a \$1 20 \$2 25
15 A \$0 50

INVENT PRACTICAL COLOR PHOTOGRAPHY
EXPERT Mechanics Require Substantial Materials
Magnificent Returns Gained Through Investment
Require Natural Talent Throughout Entire Season

12 Point

16 A \$1 30 32 a \$1 45 \$2 75
10 A \$0 50

DESIGNS MODERN PRINTING PLANT
MANY Banks \$1234567890 Receive Coins

6 Point

25 A \$0 90 51 a \$1 10 \$2 00
22 A \$0 50

MYSTERIOUS IMPORTANT DOCUMENT VANISHES
BEAUTIFUL Editions Contained Halftones and Engravings
Gigantic Scheme Uncovered by Wonderful Girl Detective
Rainy Weather Costs \$1234567890 Factories Much Money

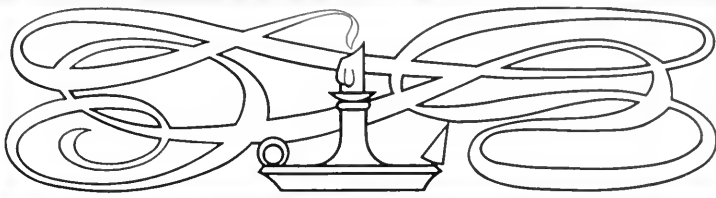

TYPOGRAPHY

AND THE ADVERTISING INSTINCT

HAVE you ever considered the relation of typesetting to advertising? One of the very best known advertising experts in the United States has paid as high as fifty dollars for setting up a single advertisement, the standard magazine page size. This man knows the value of correct typography. Years of analytical experience and careful tabulation of results has taught him that the pulling power of an advertisement can be doubled or trebled by correct typography. Shrewd advertising managers no longer hesitate to pay ten, fifteen, or twenty-five dollars for setting a single advertisement. They find it money well invested.

Correct typography involves first of all what might be called the advertising instinct. Just the ordinary "typesetting" is not typography in the sense here intended. A knowledge of advertising requirements is essential. A staff of high-priced competent compositors is also essential. For years we have made a leading specialty of graphic typography for advertisers. We put into our work the advertising instinct plus experience and knowledge of what is required.

HARNOR-ROSKAN PRESS

148 BOHEMIA STREET

LEWISTOWN, MAINE

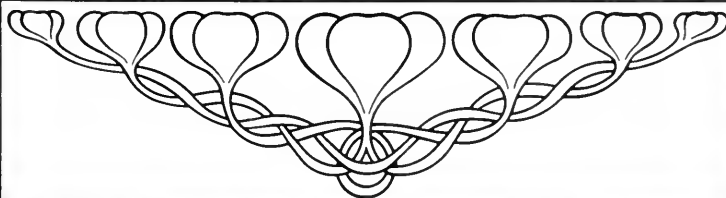

Lining French Oldstyle Italic No. 552

12 Point

16 A \$1 35 32 a \$1 50 \$2 85

*EXQUISITE MODERN SELECTIONS
Beautiful Types Always Remaining Popular
General Printing Establishments Used Italics
Graceful Letter for Neater Practical Display
Sold by American Type Founders Company
Original Features Charm Timid Customers
Reorders at Frequent Intervals Show Result
Striking Style and Dignity Observed Herein
Supreme Qualities of Ingenuity and Strength
Useful Figures \$12 34567890 Included Also*

10 Point

19 A \$1 25 38 a \$1 30 \$2 55

*MARVELOUS BUILDING TOWERING ABOVE
Contracts Given for Breaking Public Highway Stones
Government Dredge Working Near Statue of Liberty
Placing Awnings on Front Veranda a Sign of Spring
Tired Excursionists Rest Under Spreading Elm Trees
Visited Popular Maine Hunting Grounds Frequently
Youthful Golf Player Showing a Fancy Stroke to Men
Disgraceful Rioting Followed an Unpopular Decision
Beautifully Formed Diver Gets Wonderful Notoriety
Famous Historians Receiving Much Unearned Praise
Sailor Received Great Welcome at New York Harbor*

9 Point

25 A \$1 20 50 a \$1 30 \$2 50

*SHOWING PRONOUNCED IMPERFECTION
Tender Hearted Women Became Hysterical Today
Blind Man Walks Beside Charming Servant Girl
Apprentices Receiving Much Needed Encouragement
Large Steamer Pitched Dangerously During Storm
Giant Westerner Found Valuable Diamond Rings
Clever Bicycle Racer Wins National Championship*

8 Point

23 A \$1 05 46 a \$1 20 \$2 25

*STRICTER CIVIL SERVICE EXAMINATION
Old Revenue Cutter Sunk in Collision with Barges
Fireman Scalded with Escaping Steam in Fireroom
Engines Stop at Critical Moment and Never Moved
New Wireless Telegrapher Flashed Distress Signal
Captain Found Nearly Starved by Searching Party
Reporter Sent to Scene of Horrible Accident in Bay
Pictures and Description Printed in Largest Papers*

6 Point

26 A \$0 95 52 a \$1 05 \$2 00

*MODERN SPECIMENS DESIGNED IN LIGHT COLORS
Mechanics from Boston Showed Good Judgment While Working
Railroad Fireman Held Position During Slack Business Season
Mexican Frontier Swarmed with Hungry Seventeen Year Locusts
Beautiful Niagara Visited by Curious Nature Loving Residents
Competing Printer Submitted Various Estimates to Government
Presenting Wealthy Bride of Foreign Count in Court at England
International Association of Ambitious Mechanics is Organizing
Enthusiastic Conventions Presenting Grand Reports to Secretary
Remarkable Historic \$1234567890 Kingdom Unearthed in India*



*YOU ARE INVITED TO BE PRESENT
with ladies at a feast given by the members
of the Nonpareil Club in celebration of the
most prosperous year the Club has enjoyed
since its organization. Kensington House,
Friday Evening, December ninth, Nineteen hundred and
twelve, at eight-thirty o'clock. Music will be furnished by
the Kensington Glee Club and addresses will be delivered
by President Johnston, Secretary Richardsmith and others*

*SAMUEL I. JOHNSTON
President
JAMES RICHARDSMITH
Secretary*

*RICHARD H. YOUNG
FRANK E. HARDING
JOHN F. EARLY
CLAUDE MERCER
Directors*

36 Point

6 A \$2 75 9a \$2 55 \$5 10

HARMONICA INSTRUCTION
Unmerited Rewards Distributed
Merchandise Quotations Lower

30 Point

6 A \$2 00 13a \$2 10 \$4 40

CUSTOMERS DEMANDING PURITY
Notification Granting Exclusive Rights
Demands Superior Advertising Method

24 Point

8 A \$1 60 15a \$1 90 \$3 50

LARGE NEW TURBINE STEAMSHIP ARRIVES
Unusually Intelligent People Sometimes Leave
Enormously Overpopulated Districts Imperilled

18 Point

12 A \$1 50 23a \$1 75 \$3 25

PRODUCED SOME MYTHICAL STORIES OF THE PRAIRIES
For the Edification of Diminutive People Hunting Wild Animals
Appliances and Processes for the Manufacture of Underwear

12 Point

16 A \$1 15 40a \$1 60 \$2 75

MADE IN EIGHT SIZES AND VERY USEFUL
Our Civilization and Modern Advancement
Difficulty With Forms Not Properly Locked Up
Experimenting \$ 1 234567890 Considerations

8 Point

20 A \$0 85 52a \$1 40 \$2 25

FRIENDSHIP CEASES WHEN YOU NEED MONEY
Consequential Individual Promoted to Authority
Understand How to Print and Suit the Customer
Mention That Most Famous of Salmon Waters
Knowledge is Necessary in Highest Mechanics
Responsible Positions Always Open to Graduates

10 Point

18 A \$1 15 40a \$1 35 \$2 50

SPRINGTIME WILL MAKE THE OLD FEEL YOUNG
Inventing the Fine Art Which Perpetuates History
Credit of Achievements Has Been Long Contested
Method of Reducing the Weight of Pocketbooks

6 Point

25 A \$0 90 50a \$1 10 \$2 00

FINE CHANCE FOR LOVERS OF EXCELLENT LITERATURE
No Writings But Those of the Best Authors in Collection
Bargain Sale in Latest Books Written by Popular Writers
Commencing Thursday Morning at the Publishing House
Valuable Instructive Literature is a Necessity to Printers
Further Information by \$ 1234567890 Addressing Direct

72 Point

3 A \$5 45 4 a \$3 65 \$9 10

NUMBERING
Royal Kingdom

60 Point

3 A \$5 65 4 a \$2 95 \$8 60

FRENCH COINS
Markets Destroyed

54 Point

4 A \$4 70 8 a \$4 05 \$8 75

GRAND SMOKER
Remarkable Number

48 Point

4 A \$3 95 9 a \$3 70 \$7 65

FOREIGN EMPIRES
Explored Strange Island

42 Point

1 A \$3 25 9 a \$3 00 \$6 25

SURPRISE NEIGHBOR
Modern American Designs

36 Point

5 A \$2 85 9 a \$2 20 \$5 05

SECURE HIGHER PRICES
Expend Manufacturing Capital

30 Point

6 A \$2 40 10 a \$1 90 \$1 30

HISTORIC MANSION BURNED
Several Beautiful Emblems Destroyed

24 Point

7 A \$2 00 13 a \$1 50 \$3 50

BANKER HONORS ENGLISH CHECK
International Business Confidence Established

18 Point

10 A \$1 85 20 a \$1 40 \$3 25

EXPLODING MAGAZINE
Authorities Deny Responsibility
Officers Demanding Admission

10 Point

18 A \$1 30 38 a \$1 20 \$2 50

SOUVENIRS ARE DISTRIBUTED
Meritorious Work Heartily Rewarded
Charming Graduates Attend Summer
Exercises and Receive Their Diplomas
Happy Recipients Heartily Applauded

14 Point

13 A \$1 60 26 a \$1 40 \$3 00

ARTISTIC BORDER DESIGNS
Ordinary Jobs of Printing Enhanced
American Designs Always Original

8 Point

22 A \$1 25 42 a \$1 00 \$2 25

MAGNIFICENT HOME IS DESTROYED
Excited Neighbors Volunteer Their Assistance
During a Midnight Conflagration which Ruined
Binghamton's Most Palatial Residence, Captain
Bowe, Trying to Get Policy, was Slightly Injured

12 Point

16 A \$1 45 32 a \$1 30 \$2 75

STRIKING ADVERTISING LETTER
Undoubtedly Realize Handsome Dividends
Producing Attractive Commercial Printing
Brings Golden \$1234567890 American Coin

6 Point

25 A \$1 00 50 a \$1 00 \$2 00

DELIGHTFUL CONCERT GIVEN BY MAROSCH
Magnificent Bermuda Symphony Orchestra of Twenty-six
Pieces Under the Direction of the Famous Parisian Leader
Four Evenings Will Be Devoted to the Rendition of Classic
Masterpieces: the Two Remaining Evenings and Matinee
Popular Medley Will be Rendered. Mme. Brimel, Soprano
Has Been Engaged for \$1234567890 Nightly Performance

KNIGHT

THE LAST WORD IN QUALITY

THE KNIGHT BROTHERS WERE PIONEERS IN SPECIAL PAPERS
AND HAVE ALWAYS KEPT WELL IN THE LEAD IN NEW IDEAS



REPUTATION for good paper must rise or fall with the quality of the product. It is most important that we keep the quality of our paper above the average. This has been our object ever since we embarked in the paper business. The Knight Paper Company, with their well-known reputation for quality of product and business honesty, stands behind every sheet of KNIGHT PARCHMENT. It is the business paper for those who desire to give expression to all the highest commercial ideals. This paper combines the reliability of the ages with modern day progress. It is always the first choice of the printer's careful customer, and also the first choice of the discriminating buyers who appreciate quality. The printer will do well to show his customers this paper; it will mean a satisfied clientele and more profit. Send for our new and original sample book

DUKE BOND

We still carry a large stock of the famous Duke Bonds, all colors and weights. It is a very desirable paper stock for ordinary business forms



THE KNIGHT PAPER CO.

OFFICES AND MILLS, NORTH OLEANA, OHIO

BRANCH OFFICES: NEW YORK, CHICAGO, CLEVELAND, BUFFALO, SEATTLE

THE RELATION OF APPLIED DESIGN
TO OUR MODERN INDUSTRIES. ❖❖❖



ELIGHT in the graceful line and well-balanced form are universally inborn. Regard for this has always been shown in utensils and in construction. To nearly every form of product, design of some kind expresses the degree of the designer's or workman's interest in his work and his conception of appropriateness. Doorways, windows, and the whole facade are appreciations of the purposes of the building and the abilities of the architect. Of the things that go into the house, furniture and utensils, there are the same elements of regard for beauty of form and appropriate decoration. In all industrial products, applied design has an especially prominent part in forming a practical product.

Forms of knives, forks, spoons and pitchers follow the general model, but the degree of interest and merit of the pattern depend on the decorative design that is used as well as on form. The different periods of ornament are used especially in this class of products, German, French and English models being most conspicuous, so that we have tableware, wallpaper, and furniture in which the design is held as closely as possible to the periods represented. ❖❖❖❖❖❖❖❖❖

Versatile Border Jenson Initial

THE NEW IDEA OF THE MOIRBURGH BANKING CORPORATION



DO do the right thing, at the right time, in the right way; to do some things better than they were ever done before; to eliminate errors; to know both sides of the question; to be courteous; to be an example; to work for love of the work; to anticipate requirements; to develop resources; to recognize no impediments; to master circumstances; to act from reason rather than rule; to be satisfied with nothing short of perfection. ❖❖❖❖❖❖❖❖❖

72 Point

3 A \$6 80 4 a \$3 50 \$10 30

HINDER Fights

60 Point

3 A \$5 50 4 a \$2 80 \$8 30

*CONTRIBUTION
Rosebush Kingdom*

54 Point

4 A \$4 70 7 a \$4 15 \$8 85

*BIG REDUCTIONS
Escapade Denounced*

48 Point

3 A \$4 60 6 a \$3 15 \$7 75

*MODEST NUMBERS
Harmonious Serenades*

42 Point

4 A \$3 55 7 a \$2 70 \$6 25

*MAZIPOMA SPRINGS
Renegade Detains Butcher*

36 Point

1 A \$2.70 9a \$2.30 \$5.00

SURGEONS RECOGNIZED
Elementary Publication Revised

30 Point

6 A \$2.30 10a \$1.95 \$4.25

REFORM DISHONEST MAIDEN
Desperate Men Destroyed Battlement

24 Point

7 A \$1.95 12a \$1.55 \$3.50

CONSTRUCTED MODERN MANSION
Numerous Incriminating Documents Purloined
Revolutionists Destroy Beautiful Monasteries

18 Point

11 A \$1.70 20a \$1.55 \$3.25

DELIGHTFUL WEATHER CONDITIONS PREVAIL
Many Enterprising Schemers Receive Scathing Reprimand
Interior Decorators Submit Magnificent Designs for Museum

12 Point

16 A \$1.30 34a \$1.45 \$2.75

GRAND EUROPEAN MUSEUM OPEN
Remarkable Trained Monkey Entertainment
Physical Marvel Displayed Great Endurance
Showing Fine \$1234567890 Type Designs

8 Point

22 A \$1.10 44a \$1.15 \$2.25

ELABORATE HORTICULTURAL DISPLAY
Magnificent Decorative Bargains are Shipped
American Designed Artistic Historical Pictures
Expected Great Results From Baseball Player
Unprejudiced Citizens Favored Novel Schemes
Inquisitive Child Gathers Useful Information

10 Point

20 A \$1.25 40a \$1.25 \$2.50

ARRANGED EXPENSIVE EUROPEAN TOUR
Superior Elbow Lotion Relieves Springtime Maladies
Distinguished Foreigner Entertains American Senator
American Discovered Rare Specimens of Wild Birds

6 Point

26 A \$1.00 52a \$1.00 \$2.00

MARATHON RUNNER RECEIVES HANDSOME PRIZE
Future Events Accurately Foretold Prevented Catastrophes
Theatre Manager Engaged Charming Singer for Next Season
Midnight Seances Greatly Enjoyed by Enthusiastic Members
Remarkable Showing of Foreign Automobiles on Exhibition
Strenuous Boller-maker \$1234567890 Commands Police Force

144 Point

3 A \$11 30 4 a \$6 70 \$18 00

END Sale

120 Point

3 A \$8 65 4 a \$5 35 \$14 00

DISTRICTS
Shops Great

96 Point

3 A \$6 40 4 a \$3 85 \$10 25

REMINDERS
Cheaper Horse

72 Point

3 A \$5 00 4 a \$3 15 \$8 15

SERIES BOUGHT
Quality Considered

60 Point

3 A \$4 00 4 a \$2 50 \$6 50

HONEST CHILDREN
Visits Beautiful River

48 Point

5 A \$3 30 7 a \$2 95 \$6 25

MERCHANDISE SPOILED
Exports American Products

42 Point

5 A \$2 70 9 a \$2 60 \$5 30

SHOWS HANDSOME ROSES
Pleasant Summer Amusement
Containing Striking Originality

36 Point

5 A \$2 20 10 a \$2 30 \$4 50

GRAND MECHANICAL EXHIBITS International Bowling Championship

30 Point

7 A \$2 05 12 a \$1 95 \$4 00

EXHIBITING TYPOGRAPHICAL DESIGNS Aeroplanes Hovering Threateningly Beyond Brokers Report Delinquent Members of Curb

24 Point

8 A \$1 65 17 a \$1 90 \$3 55

GIVING ARITHMETICIAN TEDIOUS EXAMPLES Incorporated Manufacturers Conducting Exposition Six Remarkable Buildings Destroyed by Earthquake

18 Point

12 A \$1 50 26 a \$1 75 \$3 25

MUSICAL ARTISTS HUMOROUS Savory Beverage Causes Headache Foreman and Composer Satisfied Greatest Circus on Earth Delighted

10 Point

22 A \$1 15 46 a \$1 35 \$2 50

MERCANTILE CONDITIONS PROSPEROUS Numbering Machines in Greatest Demand Showing Artistic Typographical Designing Traveling Salesmen Reaping New Benefits Magazines Denounce Eccentric Millionaires Indian Farmer Reaps Large Wheat Harvest

14 Point

16 A \$1 25 39 a \$1 75 \$3 00

PLAINEST DESIGNS SECURING PRIZES Unlimited Conversational Powers Necessary Musical Entertainers Generously Applauded American Type Founders Company Product

8 Point

26 A \$1 05 55 a \$1 20 \$2 25

ANCIENT TYPES SELDOM BRING DESIRED RESULT Meandering Through Dusky Woodlands in Springtime Showing Handsome Ornaments and Borders Profusely Most Pathetic Exhibition of Ancient Printers Compared Beautiful Designing Submitted for General Inspection Hudson River Pirates Easily Captured by Dreadnaughts

12 Point

20 A \$1 25 43 a \$1 50 \$2 75

AUTOMOBILE MANUFACTURERS FORTUNATE Finding Nefarious Schemes to Accumulate Money Financial Conditions Becoming Generally Normal Foreign Languages Easily Learned From Teachers Handsome Sharp Cut \$1234567890 Useful Figures

6 Point

28 A \$0 90 60 a \$1 10 \$2 00

REMARKABLE SHOWING OF DETERMINATION BY PRINTERS Awful Catastrophe Happens to the Peculiar Men of Modern Ideas Millionaires Eventually Recognize the Possibilities of Intelligence Brains Are Mightier Than Dollars When Men Refuse to be Slaves Order Jenson Condensed at Frequent Intervals Through Our Houses Monster Gathering Crowd Thoroughfares During a Marathon Race Warmer Weather Prevailed Over Eastern Portion of United States Contented People Stupidly \$1234567890 Injure Their Neighbors

Oriental Carpets

NO WESTERNER NEED FARE TO NEW YORK TO SEE A
FIRST-CLASS ASSORTMENT OF ORIENTAL WEAVES.

THEY ARE EXHIBITED HERE AT TEMPTING PRICES
SUCH AS HAVE VERY RARELY BEEN APPROACHED
BY OTHER DEALERS ANYWHERE IN THE COUNTRY

For Your Homes

It would startle the crafty dealers of the East to see a big stock of Oriental Carpets and the price of every piece marked in plain figures. And you needn't cross the ocean to find other dealers who would be astonished to see such a thing. That isn't the way Oriental Weave is usually handled. But it's just the way that has lifted our Oriental Carpet business from the most modest to one of the greatest in the West. We handle Orientals as we handle any other merchandise, because we know how to buy.

WE HAVE A VARIETY OF DESIGNS AND SIZES GREATER PERHAPS THAN EASTERN HOUSES. IF YOU ARE ANXIOUS TO SECURE ORIENTALS WHICH ARE MADE TO BEAR THE CLOSEST SCRUTINY, THIS IS A GOOD PLACE TO COME. GLAD TO ACCOMMODATE YOU AT ANY TIME

Wyoming Oriental Importing Company

Corner West Jackson Street and Schermerhorn Avenue, Cheyenne, Wyoming

144 Point

3 A \$9 80 4 a \$6 85 \$16 65

MEN Form

120 Point

3 A \$8 70 4 a \$5 80 \$14 50

UNDERBIDS
Large Plank

96 Point

3 A \$5 40 4 a \$3 65 \$9 05

HOMES FOUND
Beautiful Light

72 Point

3 A \$1 30 4 a \$3 00 \$7 30

MODERN TEACHER
Discouraged Hunter

60 Point

4 A \$3 65 5 a \$2 65 \$6 30

DELIGHTFUL ROWING
Secured Precious Jewel

48 Point

5 A \$3 15 8 a \$3 10 \$6 25

EXPOSED BANK GRAFTERS
Honest Manufacturer Sailed

2 Point

5 A \$2 35 10 a \$2 95 \$5 30

REIMBURSED KINDEST WOMAN
Unfortunate Foreigner Detained
Produced Numerous Candidates

36 Point

6 A \$2 05 12 a \$2 35 \$4 25

**PROMINENT CHIROPODIST BANKRUPT
Advocating Reciprocity Internationally
Disinterested Manufacturers Perplexed**

30 Point

8 A \$1 95 14 a \$2 10 \$4 05

**SCIENTIFIC MEDICAL EXAMINER REPORTED
Eminent Physicians Questioned Young Students
Graduation Ceremonies Proclaimed Magnificent**

24 Point

10 A \$1 70 17 a \$1 80 \$3 50

**RECEIVED EUROPEAN THEATRICAL INSTRUCTIONS
Foremost Printer Relates Most Wonderful Experience
Jenson Bold Condensed Type Produces Effective Results**

18 Point

13 A \$1 50 26 a \$1 75 \$3 25

**TWENTIETH CENTURY INVENTION
Barkentine Wrecked in Arctic Ocean
Designer Strives to Please Journalist**

10 Point

20 A \$1 05 46 a \$1 45 \$2 50

**PRECIOUS GEMS STOLEN FROM PRINCE
Lady Rewards Young Duke Who Left City
Doctors and Nurses Fail to Restore Health
Vagabond Spends Weary Night in Ireland
Historic Building Destroyed by Brush Fire**

14 Point

18 A \$1 40 36 a \$1 60 \$3 00

**CONCERNS MAGAZINES AND NEWSPAPERS
Studious Pupils Graduate With High Honors
Record Crowd Witnessed Exciting Ball Game**

8 Point

28 A \$1 00 58 a \$1 25 \$2 25

**GRAND OPERA SINGER RETURNS AFTER LONG TOUR
Amusing Performers Banqueted After Successful Events
Desperate Prisoner Remained Silent After Eloquent Plea
Kind Californian Befriends Former Banker and Attorney
Northwestern Plainsmen Noted for Many Bravest Deeds**

12 Point

20 A \$1 10 46 a \$1 65 \$2 75

**MINSTREL COMEDIAN DELIGHTS LARGE AUDIENCE
American Merchant Favors Proposed Railway Lines
Many Ferocious Creatures Inhabit Southern Forest
Innocent Farmers \$1234567890 Display Big Sums**

6 Point

30 A \$0 90 60 a \$1 10 \$2 00

**FAMOUS CIRCUS MANAGER RECEIVED HUMOROUS COMEDIANS
Inspectors Determined to Condemn Modern Structures of America
Contains Many Attractive and Interesting Features Never Shown
Many Young Amateurs Producing the Highest Grade of Printing
Aeronaut Makes Successful Flight Near Hudson County Boulevard
Ten Thousand People Witness Daring Feats Performed by Monkey
Seventy Million Dollars \$1234567890 Spent for Pleasure Parties**

Hamilton

MILITARY SCHOOL

A Boarding and Day School for Boys. Preparation for College Manual and Military Training

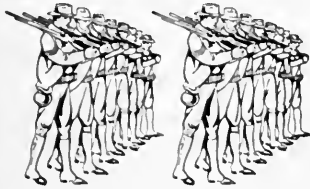

MONROE, EAST OREGON
DWIGHT CHARLES HAMILTON, Head Director

Patriotic Border Army and Navy Series No. 3

MEKIN & CO

Manufacturers of

Silks

TREE BRAND THE SILK OF
HONEST QUALITY



Trade-Mark

4 East Marion Avenue
Newkirk, Ohio

Tree Ornament Combination Ornaments

CRIXDON CAMERA

THE MOST SATISFACTORY AND CONVENIENT CAMERA FOR YOUR VACATION



Just the sort of camera for the beginner, because it is the easiest of all cameras to load and operate. And it is also an excellent camera for the most experienced because it will make pictures of as good quality as the larger cameras. Has automatic shutter and universal lens. It is the most compact camera in existence today



THE METROPOLITAN OPTICAL AND CAMERA COMPANY, Brooklyn

Minion Toys Cluster Border

84 Point

3 A \$8 70 4 a \$5 15 \$18 85

HIRE Boy

72 Point

3 A \$6 95 4 a \$4 05 \$11 00

Signal USED

60 Point

3 A \$6 10 4 a \$3 60 \$9 70

BIRDS Flying

54 Point

3 A \$5 05 5 a \$3 70 \$8 75

Always RIGHT

48 Point

3 A \$3 90 6 a \$3 60 \$7 50

DESIGN SHOPS
Stadium Repaired

42 Point

4 A \$3 50 6 a \$2 75 \$6 25

PRINTED FIGURE
Creation Handsomer

36 Point

3 A \$2.50 8 a \$2.50 \$5.00

PICTURE RETURNED

Entertaining Boatbuilders

30 Point

5 A \$2.05 10 a \$2.20 \$4.25

CONSTRUCT BUILDINGS

Monitor Destroying Lighthouse

24 Point

6 A \$1.90 11 a \$1.60 \$3.50

PURCHASE STRIPED REPTILE

Foremost Superintendent Remembered

20 Point

8 A \$1.65 16 a \$1.60 \$3.25

DISTRICT RECORDS

Delegates Return Monday

10 Point†

18 A \$1.20 37 a \$1.30 \$2.50

MODERN SERIES CHARMING

Searched Ancient Fighting Grounds Historians Contemplated Removing

18 Point*

11 A \$1.60 23 a \$1.65 \$3.25

MOUNT BUCKING MULE

Automobile Runs Over Children

9 Point

21 A \$1.25 40 a \$1.25 \$2.50

DESIRE TRUSTWORTHY BROKER

Handsome Newspaper Advertisements Reconstructs Progressive Department

16 Point*

11 A \$1.50 22 a \$1.50 \$3.00

PRODUCTION SECURED

Experienced Hardship in Storm

8 Point

22 A \$1.10 44 a \$1.15 \$2.25

SEAGOING STEAMER PASSED BOSTON

Approach Stormy Weather Near Greenland One Huge Iceberg Sighted by Quartermaster

14 Point

14 A \$1.50 28 a \$1.50 \$3.00

KNOW SPLENDID METHODS

Largest Steamship Entered Monday

6 Point†

24 A \$0.95 50 a \$1.05 \$2.00

DESPERATE BURGLAR CAPTURED YESTERDAY

Fight Policemen Until Ammunition Becomes Exhausted Attempt Jailbreaking During Absence of Husky Turnkey Magistrate Fines Culprit \$12,345,678.90 During Hearing

12 Point

16 A \$1.35 33 a \$1.40 \$2.75

EUROPEAN PRINCES RESIGNED

Greatest Coronation Attracted Hundreds Duke Was \$1234567890 Given Souvenir

5 Point

20 A \$1.00 38 a \$1.00 \$2.00

TWELVE SOLDIERS PURSUE FEMALE SHOPLIFTER

Accused Woman Enters High Building While Evading Arrest Newspaper Reporters Taking Flashlight Photograph Tuesday Expert Criminal Attorney Summoned by Professional Jockey Easily Proving Innocence When Tried by Intelligent Captain Congratulations Received Through Mail From Many Friends

*Same face †6 Point cast on 7 Point body and 10 Point cast on 11 Point body, sold in weight fonts only

TILES IN THE BATH ROOM

FOR the floor and walls of a bath room the use of tiles should be considered by everyone who is building a home or who is planning to make alterations in his present home. The same set of conditions that demand exposed plumbing demand tile. Boxed-up plumbing was abandoned because it was a damp, dark breeding place for germs. The white surface of porcelain tubs and lavatories affords no place for germs to breed. The same is true of tile. The whiteness reveals dirt. If you could see the wooden floors of a bath room under a microscope you would be shocked. Wooden floors cannot be kept sanitary. The only impervious material that will really meet all conditions is tile. All substitutes are subject more or less to the conditions of wood. But the really important thing to know is that all of these substitutes cost more in the end than tile. Tile is the cheapest treatment for the floor and walls of the bathroom because once properly laid it lasts forever. It needs no replacing

We solicit correspondence with home owners, architects and contractors on the subject of using tile in building the home

KERAMIC & COMPANY
Manufacturers of Classic Tiles and Potteries
MACFARLAND, WISCONSIN, U. S. A.

PART NUMBER TWO

Programme

Musical selections will be preceded by an address by Superintendent Morris

- Traumerei Schumann
Song of The Weirs Coogan
Fifth Nocturne Leybach
Oft In the Stilly Night . . . Moore
Minuet Paderewski
Heart Bowed Down Balfe
Toreador's Song Bizet
Bonnie Doon Burns
Charming Evelyn Coogan
You'll Remember Me Balfe
The Days That Are No More . Dale

INTERMISSION

Solos will be rendered during intermission by members of the band

- The Resignation Chatterton
The Rose and the Gauntlet . Sterling
Ballad of the Tempest Fields
The Shepherd Boy Landon
Dream of the Mermaid Lancaster
The Vision of Hope Meade
The Traveling Boy Minstrel . Ross
Countess of Cumberland . . . Daniel
Defiance of the Soul Stoddard
The Pleasant Days of Old . . . Smythe
Star Spangled Banner Key



Benefit Night

PROCEEDS TO BE GIVEN FOR THE
BENEFIT OF CRAN ORPHAN HOME

The Merham Band

PRESENTING ITS
GREAT EUROPEAN SUCCESS
ENTITLED

The Dream of Music



MR. HERMAN STEINART
LEADER

The Hamidon Auditorium
READON AND MITCHEL STREETS, DETROIT

Thursday Evening, May 22
Eight-Thirty o'Clock



48 Point

3 A \$4 00 6 a \$3 50 \$7 50

HIRED Carpenters

36 Point

4 A \$2 55 8 a \$2 45 \$5 00

PICTURES REGILDED
Unexpected Joyous Return

30 Point

5 A \$2 20 9 a \$2 05 \$4 25

GOING HOME DISGUISED
Soldier Contemplates Leaving

24 Point

6 A \$1 85 10 a \$1 65 \$3 50

BROOKLYN CITIZENS FOUGHT
Poster Compositor Pleases Everyone

20 Point

7 A \$1 50 16 a \$1 75 \$3 25

FOUND BOY CRYING
Convict Shot Eight Men

12 Point

16 A \$1 35 31 a \$1 40 \$2 75

NINETEEN STRONG BOYS
Loses \$1234567890 Gambling

10 Point

18 A \$1 20 36 a \$1 30 \$2 50

WORLD RENOWNED PRINTERS
Father Congratulates Oldest Child
Everybody Grieves Over a Failure

18 Point*

10 A \$1 55 21 a \$1 70 \$3 25

BURNING THE MONITOR
Charge Secretary with Theft

9 Point

20 A \$1 20 40 a \$1 30 \$2 50

FIREMEN SURVEY BURNING DOCK
Captain Surprised with Diamond Ring
Desperate Burglars Escaped Detectives

16 Point*

10 A \$1 40 21 a \$1 60 \$3 00

YOUNG STUDENT GOING
From Hoboken to California

8 Point

20 A \$1 05 41 a \$1 20 \$2 25

AMERICAN TYPE FACES ATTRACTIVE
Postponed Cricket Until Following Month
Small Children Give Clever Entertainment

14 Point

13 A \$1 45 27 a \$1 55 \$3 00

CLERK RETURNS PRESENTS
United States Discharging Station
Give Two Children Entertainment

6 Point

25 A \$1 00 48 a \$1 00 \$2 00

YOUNG PEOPLE ENJOYING THEMSELVES WELL
Confirming the Reports of the Late English Ambassadors
Demands of Customers Satisfied With MacFarland Italic
Pocketbook Containing \$1234567890 Lost Eleven Days

*Same face

NEW ERAS

Mean Improved Methods

Type
Talks



Every New Era in the world's history has been marked by a complete change in both the theories and methods of industry. This patent fact is well worth the consideration of all progressive printers. The ambition to advance, the desire to investigate, has made the world what it is today. Get on the wire

THE MESSAGE

At present we are in the midst of a new Business Era in which we have not, as yet, comprehended the important scope of our business literature. Printing is really a silent salesman and the use of the mails for business and advertising is as far removed from the old methods as the modern telephone is from the couriers of the ancients. Advertising to be attractive must have style and newness. These features are obtained through the use of an attractive type face and original elements of decoration. As a leader in stylish type faces the American Type Founders Company is classed alone

84 Point

3 A \$6 40 4 a \$4 10 \$10 50

MISER DINES
Stands Burned

72 Point

3 A \$5 35 4 a \$3 40 \$8 75

REDUCE TRAIN
Engines Clashed

60 Point

3 A \$4 85 5 a \$3 65 \$8 50

FRIENDS JOINED
Prominent Barber

48 Point

4 A \$3 35 6 a \$2 90 \$6 25

HONEST DETECTIVES
Deserving Prominence

36 Point

5 A \$2 10 9 a \$2 15 \$4 25

EXPECTED CHILD RETURNING
Advances Disreputable Character
Composer Teaching Apprentice

30 Point

6 A \$2 00 12 a \$2 00 \$4 00

ARTISTIC PRINTER RECOVERS STICK
Banking Concerns Interested Foreigners
Gymnastic Professor Causes Excitement

24 Point

9 A \$1 75 15 a \$1 75 \$3 50

TWENTY INSPECTORS CONTRIBUTED MONEY
Escaped From Infuriated Students Miraculously
Received Presents Graciously Without Thinking

18 Point

14 A \$1 65 22 a \$1 60 \$3 25

PRISONERS RETURNING HOME
Mechanics Holding Conventions
People Watching Clever Acrobat

10 Point

25 A \$1 25 44 a \$1 25 \$2 50

SOUTHERN STUDENT RETURNING HOME
Popular Young Physicians Received Fortune
Rich Relative Located After Seventeen Years
Explosions Caused Considerable Excitement
Famous Doctors Meet in Western Convention

14 Point

18 A \$1 45 32 a \$1 55 \$3 00

PROMINENT PHILOSOPHERS CONVENE
Performing Monkeys Created Excitement
Overwhelming Crowd Gathered Recently

8 Point

32 A \$1 15 52 a \$1 10 \$2 25

PRINCESS REQUIRES NINETEEN HUNDRED DOLLARS
Several Magnificent Springtime Costumes Recently Ordered
Eminent Instructors Recommend Strenuous Daily Exercises
Ten Romantic Young Ladies Visited Famous Country Hotel
Harmonious Strains of Music Enrapture the Star Boarders

12 Point

22 A \$1 35 40 a \$1 40 \$2 75

COLLEGE STUDENT RETURNS LOST DIAMOND
Advertisement Writer Disappears Rather Quickly
Mysterious Adventurer Faces Ninety Indictments
Stranger Returns \$1234567890 Given Abruptly

6 Point

34 A \$1 00 58 a \$1 00 \$2 00

MARVELOUS EXHIBIT OF IMPORTED AND DOMESTIC CLOTHING
Many New and Original Designs Secured From Every Part of Europe
Learned Professors Lectured Class In Natural History and Geography
Country School Teacher Captures First Prize at Recent Beauty Show
Village Blacksmith Chops Down Famous Old Spreading Chestnut Tree
Noted Oarsmen Prepare for Great Annual Professional College Races
Prominent Business-Man \$1234567890 Erects Magnificent Dwelling

Condensed MacFarland in Practical Display

ILLUSTRATED CATALOGUE

THIRD EDITION

Harbin & Son

DESIGNERS AND MAKERS OF

Monuments and Statuary

IN VERMONT AND ITALIAN MARBLE
BROWN STONE AND GRANITE, FOR INTERIOR
AND EXTERIOR PURPOSES



Richardson Street, Madison

DISTRICT TELEPHONE 8542 MARKET

SPECIMENS

AS GOOD AS THESE ANY PRINTER CAN DO



THE trade magazines pertaining to the printing business, together with the fine specimen sheets that are issued so frequently by the American Type Founders Company, have become the principal mediums for demonstrating the possibilities of type, ink and paper from an artistic standpoint. These three forces depend each upon the other, but the effectiveness of this great combination rests mainly on the manufacture of the type; the quality of its metal and the beauty of its face being absolutely necessary to the completion of good work. The finest collection of type faces ever designed and cast are those originated and produced by artists and mechanics of the highest class in our employ. The successful printer of today is the one who is ever on the lookout for new methods for attracting the attention of the prospective customer, and once having him, by prompt and efficient service holding him. Discard the old types and methods and substitute our modern type faces and ornaments

WE MAKE AN EXTENSIVE LINE OF DECORATIVE MATERIAL AND CARRY A COMPLETE LINE OF

Brass Rule and Brass Galleys



AMERICAN TYPE FOUNDERS CO.

The World's Leading Originator and Designer of Type Fashions

BRANCHES IN ALL THE PRINCIPAL CITIES

60 Point

3 A \$5 60 4 a \$3 60 \$9 20

HIRE Students

48 Point

4 A \$4 00 6 a \$3 50 \$7 50

Specimen DESIGN

36 Point

5 A \$2 65 8 a \$2 35 \$5 00

LIGHT HORSE BRIGADES Inhabitants Uncomfortable

30 Point

6 A \$2 20 10 a \$2 05 \$4 25

PURSUED BOLDEST HUNTER Distinguishes Gentleman Printer

24 Point

7 A \$1 80 11 a \$1 70 \$3 50

PLEASING AMERICAN TYPE SERIES Fireman Congratulated on Promotion

18 Point

10 A \$1 60 18 a \$1 65 \$3 25

BANK CLERK INDICTED Twentieth Marathon Race

10 Point

18 A \$1 20 35 a \$1 30 \$2 50

SOUTHERN GENERAL RETIRED Financier Entertains Aged Guests Wine Dealers Heard Conversation

14 Point

15 A \$1 45 26 a \$1 55 \$3 00

SEVEN HUNDRED AERONAUTS Handcuffing Desperate Burglars Job Printer Teaches Composer

8 Point

22 A \$1 10 40 a \$1 15 \$2 25

CHICAGO WATCHMAN FOUND DIAMOND Remarkable Kleptomaniacs Captured Here New York Manufacturer Dines at Brooklyn Mischievous Boy Destroys Many Cottages Congressman Holding Elegant Receptions

12 Point

18 A \$1 40 30 a \$1 35 \$2 75

BEAUTIFUL HOMESTEADS BURNING Congratulated Printer After Marriage Bachelors \$1234567890 Saved Money

6 Point

22 A \$0 95 44 a \$1 05 \$2 00

NORTHERN FARMERS COMING WEDNESDAY Piano Instructor Causes Merriment at Wedding Most Startling Discovery Reported this Evening Sensational Report Coming from Massachusetts Embezzler Given \$1234567890 from Confederate

Gifts for the Bride



FURNITURE FOR YOUR HOME
ALL OUR GOODS ARE PRICED



Craftsman Furniture is the leader now. It is made in such variety of pieces that a home can be furnished complete if desired. Single pieces may be bought, if preferred, with the assurance that other pieces to match can always be had. Craftsman furniture is built on simple, natural lines and will not change. Lasting as it does a lifetime, it comes to have sentimental value that can't be measured in terms of any one counting house

Rugs of Value

We wish to especially invite all prospective and all newly married people to see what an immense stock in fine rugs we carry. These rugs were purchased by our buyer, who just arrived from the east, and are special picks

DURING THE TWO WEEKS BEFORE CHRISTMAS
STORE WILL BE OPEN EVENINGS UNTIL ELEVEN

Studley Furniture Store

Henderson Street, on Garfield Square, Mobile, Ala.

72 Point

3 A \$4 35 4 a \$3 15 \$7 50

MODERN Features

60 Point

3 A \$8 85 4 a \$2 75 \$6 60

Condensed DESIGNS

48 Point

5 A \$3 15 8 a \$3 10 \$6 25

STRONGER Kings Crowned

36 Point

6 A \$2 05 10 a \$2 20 \$4 25

Displaying Beautiful CHARACTERISTIC

30 Point

9 A \$2 10 12 a \$1 90 \$4 00

DISTINGUISHED AMERICAN Quality Preserved

24 Point

12 A \$1 90 16 a \$1 60 \$3 50

**RECEIVING MAGNIFICENT JEWELLED BIRTHDAY PRESENT
Contains Many Original Ideas Regarding General Printing**

18 Point

15 A \$1 40 30 a \$1 85 \$3 25

**QUESTION RECEIVED BRIGHT ANSWER
Exquisite Advertising Face Purchased**

10 Point

28 A \$1 05 58 a \$1 45 \$2 50

**MECHANICAL DEPARTMENT BECOMING PROFITABLE
Country Gentlemen Go Back to the Days of Chivalry
Advertisers Demanding Condensed Studley Always**

14 Point

20 A \$1 30 42 a \$1 70 \$3 00

**BEAUTIFUL CONEY ISLAND PLEASURE RESORTS
Baseball Player Made Sensational Onehand Stop**

8 Point

32 A \$0 95 68 a \$1 30 \$2 25

**STRAW HAT SEASON OPENING EARLIER THAN USUAL IN DENISON
Job Type Sold at Body Type Prices Saves Money for Big Concern
Encouragement Galore Tendered Brave Heroes Returning to War**

12 Point

28 A \$1 25 52 a \$1 50 \$2 75

**GREAT HISTORICAL EDIFICE DESTROYED DURING TORNADO
Commercial Value Easily \$1234567890 Detected by Printers**

6 Point

40 A \$0 90 80 a \$1 10 \$2 00

**BUSINESS MEN FROM THIS HEMISPHERE BECOMING TYPOGRAPHICALLY STUDIOUS
Modern Workmen are Avoiding Eccentricity in Designs Unless Personally Demanded
Every Feature is Clear and Sharp \$1234567890 Noticed in the Beauty of the Figures**

Samples

A Great Source of New Ideas in
Type Display for the Ambitious
Job Compositors of the Country

A NEW SPECIMEN EXCHANGE
FOUNDED BY PAULAH INGAM

HERE are some ideas in sample study from an artist printer in touch for some time with many of the foremost compositors of the country. His sample books are bulging with specimens from every State of the Union. The number of interested compositors has gradually increased until the present membership now fully warrants the exchange of new ideas and stimulation of craft interest on a more extensive scale. Write today for full information and cost of membership in this exclusive typographical venture and most novel method of craft education

PLEASE ADDRESS ALL COMMUNICATIONS DIRECTLY TO
THE PAULAH INGAM EXCHANGE
NUMBER 4258 SUMMERS STREET, PORT CLINTON, OHIO

72 Point

4 A \$4 00 6 a \$3 80 \$7 80

REPRINTED Sixty Posters

60 Point

4 A \$3 80 6 a \$3 50 \$7 30

Manufacturing NICE BORDER

48 Point

5 A \$2 75 10 a \$3 50 \$6 25

EXTRA CONDENSED Modern Castings

36 Point

6 A \$1 95 11 a \$2 30 \$4 25

EXQUISITE SERIES PLEASING CRITICAL CUSTOMERS Beautiful Prima Donna Entertains Largest Audience

30 Point

9 A \$1 85 16 a \$2 15 \$4 00

REIMBURSED TROPICAL CITIES DESTROYED EASTER SUNDAY Binders Plan Great Social Function During the Annual Picnic

24 Point

10 A \$1 55 21 a \$1 95 \$3 50

SOUTHERN ESTABLISHMENTS REMOVED New Inventory Proved Highly Interesting

14 Point

24 A \$1 35 46 a \$1 65 \$3 00

MIDNIGHT SERENADERS RECEIVED GOOD BEATING Rendering Patriotic Hymns on Squeaking Violins Police Reserves Aroused Without Much Ceremony

18 Point

17 A \$1 50 32 a \$1 75 \$3 25

OWNERS HUNTING SUITABLE PRINTING MATERIAL The Largest Schooner Anchored Near Snug Harbor Footsore and Tired Orderly Quits Fighting Generals

12 Point

26 A \$1 25 52 a \$1 50 \$2 75

STORMY WEATHER HALTED CHAMPIONSHIP GAME TUESDAY Rubestown Sprinters Starting Rapidly at Crack of Shotgun American Faces Always Lead Competitors Without Trouble Cash Prizes and Medals \$1234567890 Were Rewards Paid

WINE LIST

FOR THE WHOLESALE TRADE



Liebfrauenmilch
Deidesheimer
Niernsteiner
Voelslauer
Markobrunner
St. Julien
Ruedesheimer
Burgundy
Johannesberger
Champagne

Burd & Son

Wine Merchants
Rex Block CAMDEN, MO.

Solution of the Short-Day Problem in the Press Room

THE AMERICAN Roller Spray

Eliminates Noon and Night Press and Roller Wash-ups
Presses Run to Full Limit of Working Time

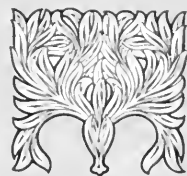
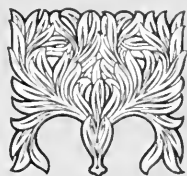

CAN BE APPLIED TO ANY JOB
OR CYLINDER PRESS
IN LESS THAN ONE MINUTE

This is a liquid preparation for retaining ink on the press and rollers without its drying, and also for reducing ink to a usable condition, while preserving the color and working consistency. Write for full details

American Type Founders Co.

BEST OF EVERYTHING FOR THE PRINTER

60 Point

3 A \$9 15 4 a \$5 85 \$15 00

KID Shot

48 Point

3 A \$5 80 4 a \$3 70 \$9 50

Fine HOME

36 Point

3 A \$3 05 4 a \$1 95 \$5 00

NICEST Country

30 Point

3 A \$2 15 6 a \$2 10 \$4 25

Hustling PRINTERS

24 Point

4 A \$1 70 8 a \$1 80 \$3 50

SPECIMENS REJECTED Higher American Quality

18 Point

7 A \$1 65 12 a \$1 60 \$3 25

GAMES ENDING Handsome Stars

10 Point

12 A \$1 15 24 a \$1 35 \$2 50

STUDENT ENTERING Lecture Delights Critic Marvelous Description

14 Point

10 A \$1 50 16 a \$1 50 \$3 00

HUNTING FLOWERS Boston Wire Stitcher Useful Display Faces

8 Point

15 A \$1 05 28 a \$1 20 \$2 25

DISCOVERING ORNAMENTS Uses Exclusive Point System Preserving Original Features Spring Poet Sending Rhyme

12 Point

12 A \$1 40 20 a \$1 35 \$2 75

HISTORICAL RESIDENCE Plowed Beautiful Meadow Uses \$1234567890 Types

6 Point

16 A \$0 95 31 a \$1 05 \$2 00

BERLIN PENSIONED POLICEMEN Mayor Reviewed Monster Parades Crowded Madison Square Monday German Band Heads First Division Lost Much \$1234567890 Real Gold

RIO LINE

THE POPULAR DIRECT ROUTE TO

London - Antwerp - Holland

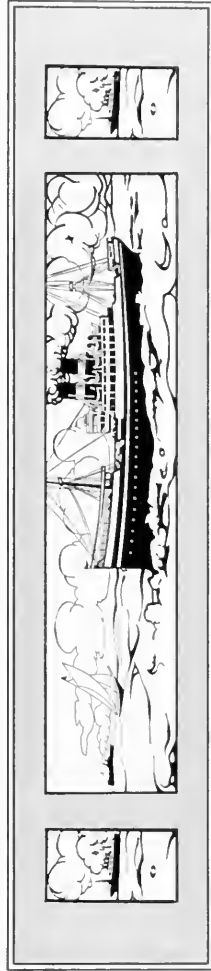

Sailing Mondays, Wednesdays and
Saturdays

FOR FURTHER PARTICULARS APPLY TO

THE RIO STEAMSHIP COMPANY
2830 BROAD STREET, NEW YORK CITY

72 Point

3 A \$7 80 4 a \$4 70 \$12 50

BOND Sold

60 Point

3 A \$6 95 4 a \$4 20 \$11 15

Heavy RAIN

48 Point

3 A \$1 35 5 a \$3 15 \$7 50

GRAND Material

36 Point

4 A \$2 60 7 a \$2 40 \$5 00

Modest Display FOUND

30 Point

5 A \$2 20 9 a 2 05 \$4 25

NEAT DESIGN Method Wanted

12 Point

15 A \$1 30 30 a \$1 45 \$2 75

EIGHT CHILDREN RETURN Leave Country Homes Alone Secure Employment Quickly Bank \$1234567890 Saved

24 Point

6 A \$1 75 11 a \$1 75 \$3 50

SPRING OPENING Prominent Contrast

10 Point

16 A \$1 20 35 a \$1 30 \$2 50

RESPITE GRANTED FORGERS Defense Produced New Evidence Police Make Sensational Charges Jury Instructed by Learned Judge

18 Point

9 A \$1 60 18 a \$1 65 \$3 25

EUROPEAN MEMBERS Returning Home Shortly

8 Point

20 A \$1 05 43 a \$1 20 \$2 25

MUSICAL ENTERTAINMENT PLANNED Artistic Invitations Issued to Exclusive Sets Professor Stringham Engaged for Occasion Newport Society Largely Represented Here

14 Point

12 A \$1 45 25 a \$1 55 \$3 00

IMPORTANT NEWS PRINTED Unpleasant Family Affair Public

6 Point

22 A \$0 95 46 a \$1 05 \$2 00

INDEPENDENT DEMOCRAT REFUSED POSITION County Physician Examined the Aloresaid Individual Found Gentleman Suffering from Temporary Insanity Large Dividends \$1234567890 Annually Divided



AMERICAN TYPE EXCELS all others in durability and originality of design, also in readability, so essential to all advertisements. In some magazines occasionally we find engraved lettering. The general effect might perhaps be pleasing, but when you commence to read you find it difficult. The artist seems intent on making his letters ornate or queer. If he made them plain and readable his customers would see that he was giving them something they could get set in type at much cheaper prices

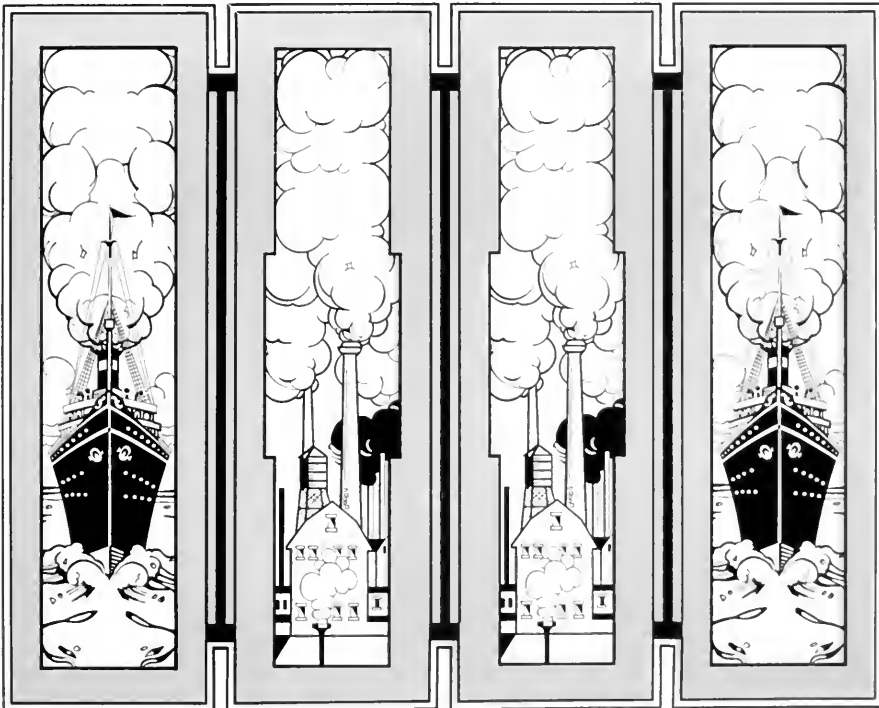

American Type Founders Company

72 Point

Special Characters \$0.35 per font

3 A \$4.85 4 a \$3.30 \$8.15

IMPROVEMENT
Greatest Admiral
Sailors Explained

60 Point

Special Characters \$0.30 per font

3 A \$4.00 4 a \$2.60 \$6.60

NUMBERS FOUND
Remarkable Animals
Private Department

48 Point

Special Characters \$0.20 per font

4 A \$3.25 7 a \$3.10 \$6.35

HISTORICAL SCHOLAR
Bright Matron Rewarded
Frequent Visitors Depart

Lining Schœffer Oldstyle No. 2

36 Point

Special Characters \$0.20 per font

5 A \$2.35 7 a \$1.90 \$4.25

**FORMED MANY EXPEDITIONS
Thousands Welcomed Statesman**

30 Point

Special Characters \$0.15 per font

6 A \$2.05 11 a \$2.00 \$4.05

**SOUTHERN EXCURSION WRECKED
Ninety Miraculous Escapes From Death
Careful Investigation Promptly Ordered**

24 Point

Special Characters \$0.15 per font

8 A \$1.75 14 a \$1.75 \$3.50

**MECHANICAL INSTRUCTIONS NECESSARY
Particular and Ambitious People Deserve Notice
Superior Mechanics Sometimes Receive Rebukes**

18 Point

Special Characters \$0.15 per font

13 A \$1.60 25 a \$1.65 \$3.25

**LIEUTENANT QUESTIONED INCOMPETENT GUARDSMEN
Indicted Soldiers Created Sensation During Army Investigation
Administration Severely Criticized Unusual Stringent Methods**

14 Point

15 A \$1.40 33 a \$1.60 \$3.00

**SEARCHED NOTORIOUS CRIMINALS
Foreigner Returned Mysterious Diamond
Undoubtedly Answered Serious Question
Strenuous Young Athlete Entered Contest**

10 Point

23 A \$1.20 49 a \$1.30 \$2.50

**FEROCIOUS DOG ATTACKED ELEPHANT
Reservation Indians Rescue Several Ranchmen
Chief Dragemout Discovers Ancient Relations
Big Eatemup Became Infatuated With Paleface
Soldiers Encountered Desperate Outlaw Bands
Interesting Ceremonies Witnessed by Stranger**

12 Point

18 A \$1.25 40 a \$1.50 \$2.75

**EXTEMPORANEOUS PREACHERS SECURED
Responsible Instructors Resume Their Positions
Numerous Reports Received Indicate Prosperity
Proper Figures \$1234567890 Judiciously Used**

8 Point

23 A \$1.05 49 a \$1.20 \$2.25

**CALIFORNIA RAILROAD ENTERPRISE STARTED
Western Stockholders Addressed Enthusiastic Meeting
Property Owners Continually Becoming Dissatisfied
Distance Covered Between Chicago and San Francisco
Enormous Capital \$1234567890 Invested Judiciously**

G M R S

These Special Characters are put up with all fonts from 8 to 14 Point inclusive. They are sold in separate fonts from 18 to 72 Point inclusive.

72 Point

3 A \$3 85 5 a \$3 20 \$7 05

MODERN KINGDOMS
Resourceful Prisoner
Impartial Judgments

60 Point

4 A \$4 15 6 a \$3 85 \$8 00

RETURNING PHYSICIAN
Destroys Consignments
Parliamentary Etiquette

48 Point

5 A \$3 15 8 a \$3 10 \$6 25

WONDERFUL ACHIEVEMENTS
Handsome Stationery Printing
Railroad Increasing Dividends

36 Point

6 A \$2.30 9 a \$1.95 \$4.25

CONTENTED MILLIONAIRE DECAMPED
Automobile Exhibition Crowded Nightly
Singing Comedians Entertain Managers

30 Point

8 A \$2.00 13 a \$2.00 \$4.00

ENTHUSIASTIC PROSPECTORS COMMUNICATE
Charitable Manufacturer Announced Intentions
Four Unprejudiced Philanthropists Exonerated

24 Point

9 A \$1.60 17 a \$1.90 \$3.50

MAGNIFICENT SKYSCRAPERS OBSTRUCT THE RANGE
Discriminating Superintendents Rearranged Factories
Twentieth Century Structure Withstood Bombardment

18 Point

13 A \$1.45 26 a \$1.80 \$3.25

PROGRESSIVE NORWEGIAN MECHANICS UNANIMOUSLY SELECTED
Decreasing Temperature Necessitates Comfortable Winter Quarters
Extraordinarily Conservative Financiers Considering Postponement

14 Point

17 A \$1.35 36 a \$1.65 \$3.00

ELOQUENT SPEAKER CHARMS LISTENERS
Skilled Designer Enthuses Attentive Pupil
Reconstructed Amphitheatre Surrounded
Vacationists Enjoying Popular Excursions

10 Point

23 A \$1.10 48 a \$1.40 \$2.50

FORTY MORE DISGRUNTLED SUBURBANITES
Distinguishable Features Considered Perfect
Thrilling Adventures Interesting Booklovers
Arctic Explorers Return Absolutely Destitute
Renowned Scientist Invents Wonderful Cures

12 Point

21 A \$1.25 42 a \$1.55 \$2.80

INEXPENSIVE THRESHING MACHINERY INSTALLED
Bright Designs for Snappy Typographical Display
Distinctive Creations Excelling Previous Endeavor
Visiting Uninterrupted \$1234567890 Proceedings

8 Point

26 A \$1.00 52 a \$1.25 \$2.25

HUMOROUS AUTHOR DEMANDING GREATER INCREASE
Incompetent Directors Undergo Gruelling Examination
Circus Performer Risking Life With Utmost Confidence
Peculiar Rhinoceros Delights Curious Seminary Pupils
Emergency Ambulances \$1234567890 Wanted Instantly

72 Point

3 A \$5 85 4 a \$3 80 \$9 65

GOLDEN ROD Exchange Cattle Broadway Firms

60 Point

3 A \$4 90 4 a \$3 00 \$7 90

MAKING BRICKS Established Method Important Question

48 Point

3 A \$3 10 7 a \$3 15 \$6 25

INSPIRE SOME HOMES Gymnastic Benefit Clubs Better Reports Promised

36 Point

1 A \$2 00 9 a \$2 25 \$1 25

MODERN RECORDS UNIQUE Students Describe Home Courses

30 Point

7 A \$2 15 10 a \$1 85 \$1 00

THE RIDGEMOUNT PLEASURE CLUB Broker Required Genuine Endorsement Graduating Biographical History Clubs

24 Point

8 A \$1 75 14 a \$1 75 \$3 50

RIDICULE BONDING DELINQUENT MEMBER Demands Ninth Section Erased From Constitution Increased Attendance Inspires Great Deliberations

18 Point

12 A \$1 50 24 a \$1 75 \$3 25

INCREASE GENERAL OUTPUT Recent Demands Insure Certain Improvements Before November

10 Point

23 A \$1 20 45 a \$1 30 \$2 50

BOSTON WIRE STITCHERS SUPERIOR Hundreds Used Daily by Leading Printers and Publishers Throughout This Country Acknowledged Best From all Standpoints Observatory Destroyed by Terrible Storm

14 Point

16 A \$1 35 34 a \$1 65 \$3 00

REINSURES HOUSEHOLD FURNITURE County Agents Demanded High Premium Satisfactory Propositions for Settlements

8 Point

26 A \$1 10 50 a \$1 15 \$2 25

SPECIMEN SHEETS AND PRICES REMARKABLE The General Advertiser Appreciates Popular Designs Suited to the Requirements of Commercial Printers An Ideal Display Letter That Commands Attention Cast on American Point Line in Twelve Regular Sizes

12 Point

19 A \$1 30 39 a \$1 45 \$2 75

CHILD SINGER RECEIVES INTRODUCTION Monarch Confers With Instructor at Academy Legal Guardian Makes the Final Arrangement Selecting Twelve \$1234567890 Quaint Designs

6 Point

28 A \$0 95 54 a \$1 05 \$2 00

LARGE COMMERCIAL HOUSE INTERESTS EMPLOYERS New Method Pursued Shows the Value of Practical Suggestion Bright and Attractive Styles in Typography Produce Business Our Bewick Roman Wins Favor Among the Elite of Printerdom Branch Houses Everywhere Can Furnish Complete Equipment We Strive to Make Prompt Shipments of Every Order Received Unexcelled Facilities in \$1234567890 Producing Paying Type

ſ ① ¶ ¶ A C G O O ſ ſ ct ff qu

These Special Characters included in fonts 18 Point and larger. The three Florets are omitted from fonts of 6 to 12 Point



The Folks Who Lunch

Everyone who loves the big out-of-doors and enjoys a lunch in the open will want one of our new Patented Refrigerator Lunch Baskets. They are built in styles and sizes to meet the requirements of everyone, the touring motorist, the family that picnics in the park or woods, the folks who go fishing and boating, and all who enjoy life in the open. Booklet giving a detailed description of these baskets will be sent on request



THE BESTIAS COMPANY
48 GRANT STREET, MOXHAM, IND.

Versatile Ornaments Typotect Border

Exact Printing

LITTLE TOUCHES OF CORRECTNESS



HAVE you ever considered the quality of your work from the standpoint of careful type composition and efficient proofreading? The reputation of this house for good printing has been established through accuracy and attention to the little details. Send your printing here and we will do it right

The Justso Company
Franklin, Pennsylvania

Quadruple Cast Squares Bullfinch Attractor

ANNUAL MEETING OF THE OHIO
STATE TEACHERS AND
INSTRUCTORS



REPORT



ONE OF THE SERIES OF
REPORTS BY THIS
COMMITTEE

**SPECIAL TEXTBOOK
COMMITTEE**



WEST SPRINGS, OHIO
JULY SEVENTH

Quadruple Cast Squares Busha Ornament

HOTEL SHERMIND

THE MOST CONVENIENTLY LOCATED HOTEL AND RESTAURANT FOR BOSTON'S BUSINESS MEN
CORNER OF EAST HENDERSON STREET AND MEDINGTON AVENUE, BOSTON, MASSACHUSETTS

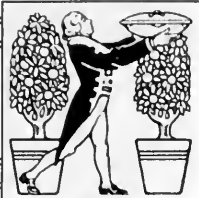

FIRST CLASS RESTAURANT
AND GRILL ROOM



The Finest Hotel in Boston

Hotel Shermind is a million dollar structure at the very apex of Boston's busiest life, embodying in every feature the Shermind idea of always doing the thing perfectly. In architecture it is remarkable, even when considered as a hotel only. It is, first of all, a home hotel, where any gentleman of moderate means may bring his family at reasonable cost, and where there is all the privacy of the home. Its fame is perennial. But the dignified, quiet comfort, the air of repose, the tasteful furnishing of the sleeping rooms and even the halls are just as characteristic. Write for new Booklet

BUREM G. SHERMIND
PROPRIETOR

LARGE FIRE PROOF GARAGE FOR THE USE OF TOURISTS

Versatile Ornaments Art Ornament Mercantile Border

JOHN M. ROBERTSON

Table d'Hote Dinner 50c



TWELVE GRAND BOULEVARD
HENDERSON CITY, MAINE

Telephone
2536
Chelsea

TAXICAB
SERVICE

Mission Toy Hello Cut



HAT CHECK
SMURKINSON HOTEL

Panel Border Trade Cut

72 Point

3 A \$8 55 4 a \$5 25 \$13 80

RED Braid

60 Point

3 A \$7 60 4 a \$4 75 \$12 35

High TIDES

48 Point

3 A \$4 70 4 a \$3 00 \$7 70

DESIGN Ships

36 Point

3 A \$2 60 6 a \$2 40 \$5 00

Monument ERECTED

30 Point

4 A \$2 10 8 a \$2 15 \$4 25

RIGHT ROAD Great Mistake

12 Point

15 A \$1 35 26 a \$1 40 \$2 75

AMERICANS PROMOTED Highest Position Accepted Numerous Parties Joining State \$1234567890 Loan

24 Point

5 A \$1 65 10 a \$1 85 \$3 50

BARNS RUINED Grand Excursion

10 Point

16 A \$1 20 30 a \$1 30 \$2 50

MYSTERIOUS PRODUCTION Stolen Document Reproduced Arguing Extraordinary Cases Prominent Lawyers Advising

18 Point

9 A \$1 60 15 a \$1 65 \$3 25

SEVERAL MASTERS Lost During February

8 Point

20 A \$1 10 36 a \$1 15 \$2 25

REMARKABLE PLANTS DISCOVERED Ancient Professor Astonishes Audience Delivered Anniversary Oration Fluently Men Becoming Unusually Obstreperous

14 Point

11 A \$1 40 22 a \$1 60 \$3 00

DEMANDING REDUCTION Private Individuals Rebuild

6 Point

22 A \$1 00 39 a \$1 00 \$2 00

EMINENT POLITICAL SPEAKERS REJOICING Regular Nightly Meetings Creating Enthusiasm Promising Young College Graduates Nominated Elected Several \$1234567890 Wonderful Men

Corbitt in Practical Display



**THE
FIRST
DAILY IN
SPORTAGE
COUNTY**



SPORT

THE HERALD'S NEW BASEBALL SERVICE

 **THE Sportage Daily Herald** will, commencing with the opening day of the Baseball season, inaugurate a Baseball News Bureau. This special department will collate the first records of the games as they are received from different centers and present them in a novel and complete form. The actual results of the day by this method will be seen at a glance. Our experienced writers will furnish in detail the fine points of each game and interesting comments on the great national sport will be printed daily

We show herewith a specimen of the score we will run at the top of our sporting page

Ponce 615340219-31

Roscoe 91285373x-38

We have installed a special wire direct from the baseball grounds to provide our patrons with the entire score by innings which we will post on our bulletin board

THE HERALD SPORTAGE, NEW YORK



**BEST
SPORTING
PAPER
IN THE
WORLD**



Department Store Initial Baseball Figures Baseball Series No. 3 French Cast Squares



The Twentieth Century is a century of progress. The old world is throwing aside many of its foolish and absurd notions. This new industrial era means much to the printer. The liberal use of the mails for advertising; the increasing tendency of the higher professions to advertise; the literature necessary to promote and sell our many new inventions; the new demands being made for printing; all are grist for the printer's mill and he should be prepared to handle them

KEEP STEP WITH MODERN PROGRESS

72 Point

3 A \$6 35 4 a \$4 05 \$10 40

SAME Design

60 Point

3 A \$5 60 4 a \$3 60 \$9 20

Grateful **KINGS**

48 Point

3 A \$3 50 5 a \$2 75 \$6 25

HANDSOME Printer

36 Point

4 A \$2 15 7 a \$2 10 \$4 25

Publication **PROBED CRIME**

30 Point

5 A \$1 75 11 a \$2 25 \$4 00

TRAIN WRECKED Passengers Growl

12 Point

18 A \$1 30 35 a \$1 45 \$2 75

EXCURSIONISTS COMING HOME New and Stylish Fashions in Type Angry Parents Seek Lost Children Returns \$1234567890 Expected

24 Point

8 A \$1 85 12 a \$1 65 \$3 50

FARM PRODUCTIONS Experienced Employer

10 Point

20 A \$1 15 40 a \$1 35 \$2 50

RECOVERED MANY LOST ARTICLES Handsome Young Couples Joy-Riding Millionaire Compositor's Long Voyage Some Choice Oriental Designs in Rugs

18 Point

12 A \$1 65 19 a \$1 60 \$3 25

HANDSOME YOUTH DROVE Horses Admired by Members

8 Point

26 A \$1 10 46 a \$1 15 \$2 25

SUPERIOR MATERIAL ALWAYS SATISFACTORY Continually Picking Live Jobs Causes Many Errors Prosperous Tourists Traveling in Foreign Countries Engaged Couple Elope and Make Numerous Friends

14 Point

16 A \$1 50 26 a \$1 50 \$3 00

DETECTIVE CAPTURES BURGLAR Angry Women Put Rascals to Flight

6 Point

26 A \$0 95 52 a \$1 05 \$2 00

PRINTING MACHINES OF EVERY DESCRIPTION FOR SALE Handsome Young Cornet Player Discouraging Many Suitors Important Transportation Facilities Are Promised Shippers Beautiful Homes \$1234567890 Surrounded by Mountains

OCEAN TRIPS

TO MAINE, IN 22 HOURS FROM NEW YORK CITY

The glorious air, the magnificent views and the comfortable accommodations are some of the luxuries one can enjoy while spending a vacation on the coast of Maine. Before going on your vacation this Summer it will be to your best advantage to write us for detailed information regarding complete cost of a trip to Bar Harbor, together with new illustrated booklet

A BEAUTIFUL HAND-COLORED PICTURE, ENTITLED "THE BATHING GIRL," WILL BE SENT ON RECEIPT OF TEN CENTS IN STAMPS, TO COVER THE COST OF MAILING

THE MURDEN STEAMSHIP CO.

MAIN OFFICE, 453 NEW AMSTERDAM STREET, NEW YORK CITY



Commercial Ornament

FISHING TACKLE

THE KIND YOU SHOULD BUY AND A FEW GOOD REASONS

There is an old saying which tells us that there are plenty of fish in the sea that have never been caught. The fish worth while are not so easily coaxed. Our many new trout flies will surely interest you. We have them in many sizes and prices



By HANS FISHER

HERMAN WALL PAPER

Interior Decorator and Furnisher



LOCATED AT
269 WASHINGTON AVENUE
NEW BRUSHTOWN
INDIANA

120 Point

3 A \$14 15 3 a \$8 45 \$22 60

END Bin

96 Point

3 A \$9 90 3 a \$6 10 \$16 00

Digs MINE

72 Point

3 A \$7 35 4 a \$4 90 \$12 25

**BRINGS MEN
Chase Hounds**

60 Point

3 A \$6 15 4 a \$4 25 \$10 40

**FIGHT JUDGES
Conflict History**

48 Point

3 A \$3 80 6 a \$3 70 \$7 50

HIRING BOHEMIAN Destroyed Kingdom

42 Point

4 A \$3 30 7 a \$3 05 \$6 35

BIG SHARK CAUGHT Amazon River Mansion

36 Point

4 A \$2 55 7 a \$2 45 \$5 00

DESIGNS FINEST HOMES Stout Printers Scared Chief

30 Point

5 A \$2 25 8 a \$2 00 \$4 25

HUNTING BUCK Guides Explaining

12 Point

15 A \$1 30 28 a \$1 45 \$2 75

SOCIETY FOLKS RETURN Acrobat Invites Young Kings Doctor Inspects Brick Building Great \$1234567890 Actors

24 Point

6 A \$1 80 10 a \$1 75 \$3 55

KNIGHTS REFUSE Train Jumped Track

10 Point

16 A \$1 25 30 a \$1 25 \$2 50

TYPE CASTERS PERFORMED Suspects Northeastern Detectives Local Golfer Defeats Clever Boy Desperate Ribbon Salesman Hired

18 Point

9 A \$1 55 16 a \$1 70 \$3 25

NEW MUSIC TEACHER Conductor Arouses Clerk Young Bankers Confused

8 Point

18 A \$1 00 40 a \$1 25 \$2 25

PRINTER SPENDS MONDAY ON LAKE Great Waves Sweep Over Huge Bulkhead Old Express Train Derailed at Bridgeport Soldiers of Fortune Lost Near Palm Beach Fabricator Arraigned Before Stout Justice College Professors Instructed Tall Students

f th si fl st M R h m n t u ct The

These Special Characters are put up in all fonts

OLEAN

BASE BALL SCORE CARD



TUESDAY'S GAME

Inter-State League

CUSTER CITY vs. OLEAN TANKERS

PUBLISHED BY
THE MORNING HERALD

JUNE



What is so Rare as a Day
in June but a Package
of Printing with
the Joycraft
Quality

The Joycrafters

Rose Border Panel Border



A Sailor Boy

TWO ACT FARCE



The Dramatic Club Rooms

Holiday Printing

CHRISTMAS ORDERS FILLED ON VERY SHORT NOTICE

It is unnecessary for us to talk at length about our modern printing plant and the satisfactory manner in which we execute our work; as a matter of fact for eighteen years we have been termed "the home of everything that's good in printing"

The Newfont's Printing Company

MECHANICSVILLE, CALIFORNIA

Holiday Border Holiday Decorators

CHRISTMAS

Wreaths

MISTLETOE AND HOLLY



We desire to inform our customers that we are making a specialty of unique floral designs for weddings, funerals and all social functions

Telephone orders will receive prompt and personal attention

BENSLER & MUNSON

FLORISTS

325 MAIN STREET, EASTON

Brockton Border Holiday Decorators

BOOKS

Art : Fiction : Poetry

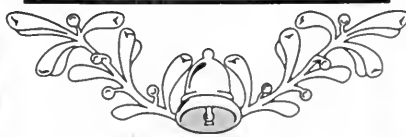

In our unusual collection of holiday books you will find many interesting Christmas tales written especially for young boy and girl readers

HANSEN & COMPANY

RADE BUILDING

BRIGHTOWN, MARLAND

Holiday Decorators

Roycroft Open

72 Point

3 A \$7 35 4 a \$4 90 \$12 25

RESPONDED
Eighty Blanks

60 Point

3 A \$6 15 4 a \$4 25 \$10 40

DISCERNMENT
Machine Bought

48 Point

3 A \$3 80 6 a \$3 70 \$7 50

BRIGHTER HOMES
Pleasingly Improved

36 Point

4 A \$2 55 7 a \$2 45 \$5 00

REINFORCED
Heavy Frames

18 Point

9 A \$1 55 16 a \$1 70 \$3 25

MODEST JAILERS
Designed Specimens
Climbing Mountains

24 Point

6 A \$1 80 10 a \$1 75 \$3 55

MUSICAL LADIES
Fighter Discouraged

12 Point

15 A \$1 30 23 a \$1 45 \$2 75

STRANGE LANDS VISITED
Exquisite Drawing Discovered
Afternoon Exercises Beneficial
Large \$1234567890 Portion

Kent Printing Company

We are prepared to execute orders for artistic printing which will command attention by its striking and original advertising features. Our greatest efforts are always made to maintain the printer's highest and best standards of excellence. Our type equipment is being constantly augmented by the new and latest faces. If you desire color combinations and arrangements of the most attractive character, our services are always at your instant disposal

13 Stephen Street, East Roxbury

BOTH 'PHONES

Versatile Ornaments

To be right up to the minute you will need
some of our pleasing and original borders

72 Point

3 A \$8 50 4 a \$5 30 \$13 80

RESUMED
High Stand
Many Dark

60 Point

3 A \$7 30 4 a \$4 50 \$11 80

BLINDSIDE
Girls Expert
Naked Truth

48 Point

3 A \$4 65 4 a \$2 85 \$7 50

ENCAMPMENT
Songs Required
Divulged Secret

36 Point

3A \$2.55 6a \$2.45 \$5.00

MEMORIAL SERVICE Criminal Extinguished Blithesome Publishers

30 Point

1A \$1.95 9a \$2.30 \$4.25

HISTORIANS CONVENING Elegant Prospects Restored Reprimand Caused Trouble

24 Point

6A \$1.90 9a \$1.60 \$3.50

AMERICAN MACHINES PLEASE Neglected Animal Becomes Unruly Delinquent Cashier Paid Managers

18 Point

9A \$1.60 16a \$1.65 \$3.25

SUPERIOR PRINTERS Reproducing Drawings Interesting Photograph

10 Point

16A \$1.25 30a \$1.25 \$2.50

ECONOMICAL HOUSEWIVES Received Pleasant Stepmother Obtaining Satisfactory Results Making Important Discoveries Numerous Politicians Exposed

14 Point

12A \$1.45 22a \$1.55 \$3.00

MERCANTILE INDUSTRIES Unusual Excitement Planned Dignified Author Sojourning

8 Point

20A \$1.10 36a \$1.15 \$2.25

BEAUTIFUL ILLUSTRATED MAGAZINE American Productions Greatly Admired Composer Displays Clever Originality Principal Rewarded Ambitious Students Serious Trouble Anticipated Eventually

12 Point

14A \$1.35 28a \$1.40 \$2.75

HANDSOME SOCIETY LEADERS Pleasing Entertainments Arranged Extravagant Daughter Inconsistent Bankrupt \$1234567890 Receiver

6 Point

20A \$0.90 42a \$1.10 \$2.00

MARVELLOUS GYMNASIIC PERFORMANCES Ladies Performed Several Unusual Daring Feats Chinese Magicians Delighted the Vast Audience Elephants Played Hoboken Musical Instruments Prominent Citizens Witnessed Spectacular Sight Sensational Long Distance Races Pleased Sports Management is \$1234567890 Greatly Pleased

VOLUME II

JANUARY

NUMBER ONE

THE SOUTHERN RED CROSS BULLETIN

ISSUED FROM HEADQUARTERS OF THE SOUTHERN RED CROSS
ASSOCIATION, REINLANDER BUILDING, MACOME, MD.

AND OF WAR + FOUNDED TO

FERING IN TIMES OF PEACE

AID IN THE PREVENTION AND

CONTENTS



FIRST AID TO THE INJURED	.	John Smith	.	1
THE YOUNG DOCTOR. Verse	.	Elsie Conroy	.	4
MY FIRST CASE	.	Dr. George Cooper	.	5
STUDYING THE TYPHOID GERM	.	Prof. F. L. Winter	.	17
THE TRUTH ABOUT DRUGS	.	James Lyons	.	31
THE AMBULANCE DRIVER. Verse	.	Mary Harvey	.	48
X-RAY IN PRACTICAL USE	.	Dr. W. E. Ayres	.	49
CHOLERA GERM DISCOVERED	.	Prof. Eugene Hall	.	85
THE MEDICAL STUDENT	.	Roy Sawyer	.	103
ALCOHOLISM A DISEASE	.	Samuel Miller	.	125
THE NURSE. Verse	.	May Rogers	.	132
COMBATING THE RABIES	.	Dr. Otto Bries	.	133
CHINA AWAKENING	.	Carl Morris	.	157
THE BABY'S BATH. Verse	.	Margaret Cheney	.	178
LEPROSY CASE CURED	.	Prof. M. McClain	.	179



Red Cross Publishing Co.

MACOME, MD.

ALLEVATION OF HUMAN SUFF

M-H LINENS

We Operate the Largest Factory in the East Devoted to the Manufacture of Linen Goods Exclusively, Consequently We Can Give You the Best Values

Sheetings · Embroideries
Fine Table Cloths
Napkins



THE MUIR-HENK MANUFACTURING CO.
THREE HUNDRED AND EIGHTY HUNTER STREET, WEAVERVILLE, MASS.

Foreign Factories in London, Hamburg, Paris

WHY YOU SHOULD HAVE A

Phone

INSTALLED IN YOUR OFFICE

	<p>How a Phone saved the day and averted a big financial disaster</p>		
	<p>HAMPTON Telephone Co. HAMPTON, MAINE</p>		

KIM

Jeweler and
Clock Fixer



I Pay Best Prices for Old Gold, Silver, Platinum and Rare Antiques Watches, etc.

18 PUTNEY STREET
HOPEFIELD, OHIO

In Business Twenty-Nine Years

Bewick Border Chap-Book Cut

Versatile Ornaments Inland Border No. 683

Versatile Ornaments Linear Border No. 2 Hello Cuts

84 Point

3 A \$8 15 4 a \$5 00 \$13 15

STUMBLED Near Ireland

72 Point

3 A \$6 40 4 a \$3 95 \$10 35

BLIND TIGER Major Hunting

60 Point

3 A \$5 55 4 a \$3 45 \$9 00

PRINTS CHECK Friend Explains

48 Point

3 A \$3 55 5 a \$2 70 \$6 25

GUEST HIDES COIN Returned Five Quads

36 Point

4 A \$2 05 8a \$2 20 \$4 25

JOCKEY CAUTIONS FRIEND Boys Explained Secret Orders Postpone Suburban Handicap

30 Point

5 A \$1 75 11a \$2 25 \$4 00

ENGLISHMAN JOINS HUNGARIAN Foreigners United Tuesday Morning Gigantic Ocean Liners Nearing India

24 Point

7 A \$1 60 15a \$1 90 \$3 50

TAXIDERMIST PURCHASED YOUNG LION Washington Ranchman Furnished Specimen Quadruped Escaped Without Injuring Guard

18 Point

11 A \$1 50 23a \$1 75 \$3 25

IMPROVES YOUR PRINTING Legible Faces Holding the Eye Twentieth Century Type Styles

10 Point

22 A \$1 20 43a \$1 30 \$2 50

AMERICAN NEWSPAPER PUBLISHERS Related Incidents of Journalistic Careers Queer Facts Concerning Foremost Editor Was Practical Printer Before Going West Humorist Explains Art of Pleasing Public

14 Point

16 A \$1 40 32a \$1 60 \$3 00

COMBINE CHARACTER AND STYLE Picks From Standing Advertisements Conditions Bewildering the Foreman

8 Point

27 A \$1 05 55a \$1 20 \$2 25

SALESMAN VISITED PROPRIETOR LAST THURSDAY Merchant Promoting Several Young Philadelphia Boys Large Department Store Manager Rewarding Employee Window Decorators Pleased Many Particular Shoppers Rapid Growth of Store Surprised Youngest Stockholder

12 Point

20 A \$1 35 38a \$1 40 \$2 75

HUNTER TRAILED HUGE MOUNTAIN GOATS Mules Becoming Hostile Near End of Journey Kind Animals Demonstrated Great Endurance Captured Twelve \$1234567890 Grizzly Bears

6 Point

30 A \$0 90 63a \$1 10 \$2 00

RHINOCEROS CAPTURED AFTER INJURING EIGHTEEN HUNTERS Natives Joined Chase Through Thick Forests for Monstrous Beast Guide Became Frightened at Strange Party Firing From Ambush Two Elephants Charge Defenseless Africans Before Help Arrives Eight Excited Tourists Made Hasty Retreat and Thereby Escaped American Cowboy Lassoed Huge Quadruped After Nine Attempts Ivory Tusks Valued at About \$1234567890 Stolen From Steamers

Condensed Winchell in Practical Display

Announcement

OF THE OPENING OF THE

Nashville Bank

OF THE STATE OF CALIFORNIA

Capital and Surplus \$25,840,000



South Madison and Randall Streets
Reading, California

Happy Thoughts Cast Panel Pieces Versatile Ornaments

HOTEL BIRMINGTON

"ONE MINUTE FROM EVERYWHERE"

A three million dollar structure located at the very apex of Broadway's busiest life, embodying in every feature the one Birmingham idea of doing everything in a perfect manner. It is, first of all, a home hotel, where gentlemen of moderate means may bring their families, and where the women folk are not subjected to the curious scrutiny of lobby-loungers

EUROPEAN AND AMERICAN PLAN

BROADWAY AND FORTIETH STREET, PORTSMOUTH

FINE RESTAURANT AND GRILL ROOM

THE CUISINE OF THIS HOTEL IS BEYOND ALL DOUBT THE BEST THAT CAN BE OBTAINED IN THIS GREAT CITY OF PORTSMOUTH

TOURING

A MAGAZINE FOR THE AUTOIST



NUMEROUS articles and illustrations of special interest to lovers of outdoor life as well as the enthusiastic automobilist will be found in the pages of this issue. Many valuable hints on cross-country touring in the different parts of America are offered by the country's best known writers on this subject. Under the title "Speed" is grouped practical information for the driver of a touring machine, giving a little advice on many subjects of great importance, based on comfort, safety, power, economy, buoyancy, speed and other matter of similar character. An interesting section on outdoor life has also been inserted, having come from the pen of our friend, Harry Georgeous

THIRTY CENTS PER COPY

Post Oldstyle Roman No. 1

72 Point

Special Characters \$1 40 per font

3 A \$8 10 4 a \$6 15 \$14 25

HIDE Sold

60 Point

Special Characters \$1 40 per font

3 A \$6 10 4 a \$4 00 \$10 10

Bright MIND

54 Point

Special Characters \$1 20 per font

3 A \$5 80 4 a \$3 70 \$9 50

DIVE Straight

48 Point

Special Characters \$1 25 per font

3 A \$1 85 4 a \$3 15 \$8 00

**INDIAN HIRED
Highest Building**

42 Point

Special Characters \$0 95 per font

3 A \$3 70 5 a \$2 80 \$6 50

**CHINESE MOURN
Exterior Decorated**

36 Point

Special Characters \$0 75 per font

3 A \$2 80 6 a \$2 55 \$5 35

**FORMER PREAMBLE
Explorations Continue**

Post Oldstyle Roman No. 1

30 Point

Special Characters \$0.65 per font

1 A \$2.15 8 a \$2.10 \$1.25

MODERNIZED PRINTING
Dignified Character Bought
Shows Original Conception

24 Point

Special Characters \$0.50 per font

5 A \$1.70 10 a \$1.80 \$3.50

PERFORMANCE INTERESTED
Handsome Decorations Presented
Makes Beautiful Easter Creations

18 Point

Special Characters \$0.50 per font

8 A \$1.65 14 a \$1.60 \$3.25

PHYSICIANS HONORING PROFESSOR
Fraudulent Insurance Presidents Indicted
Greatest Crowds Aboard Sinking Steamer

14 Point

10 A \$1.45 17 a \$1.55 \$3.00

HONEST DISBURSEMENTS BY LEGISLATURE
Interesting Agricultural Semi-Monthly Publication
Finest Advertising Methods Required Everywhere

12 Point

14 A \$1.40 20 a \$1.35 \$2.75

8 Point

16 A \$1.15 24 a \$1.10 \$2.25

REQUIRE SINCERE MEMBERS
American Types and Ornaments
More Startling Exposure Coming
Spending \$1234567890 Salary

PURCHASE WHITE ELEPHANT
Find African Jungle Beaters Here
Cannibals Chase Pious Missionary
Make Finest Irish Stew Imaginable
Savages Holding Delightful Feasts
Hurricane Deck Swept by Captain

10 Point

14 A \$1.25 21 a \$1.25 \$2.50

6 Point

16 A \$1.05 25 a \$0.95 \$2.00

IRISH PRINTERS DISAPPEARED
Hoboken Scenery Charmed Visitor
Fisherman Landed Smallest Turtle
Black Clouds Rolling Slowly Away

MAINE RESORTS OPENED EARLIER
Overgrown Lumberman Bruised Hand
Describes Beautiful Mountain Scenery
Encountering Treacherous Quicksand
Burning Hickory Forest Causes Alarm
Estimates on \$1234567890 New Type

The of o f fi ll E R L O (&) leaf

These Special Characters are put up with all fonts from 6 to 14 Point inclusive They are sold in separate fonts from 18 to 72 Point inclusive

Post Oldstyle Roman No. 2

72 Point

Special Characters \$1 70 per font

3 A \$8 80 4 a \$6 20 \$15 00

NICE Kid

60 Point

Special Characters \$1 20 per font

3 A \$6 65 4 a \$4 85 \$11 50

May BRIDE

54 Point

Special Characters \$1 20 per font

3 A \$6 15 4 a \$4 30 \$10 45

HOPE Given

48 Point

Special Characters \$1 30 per font

3 A \$4 90 4 a \$3 50 \$8 40

**PRINTERMEN
Riding Contest**

42 Point

Special Characters \$1 00 per font

3 A \$3 75 4 a \$2 50 \$6 25

**ENGLISH RULE
Soldiers Desired**

36 Point

Special Characters \$0 75 per font

3 A \$3 00 4 a \$2 00 \$5 00

**SAILORS RETURN
Rebuked Executive**

Post Oldstyle Roman No. 2

30 Point

Special Characters \$0.70 per font

4A \$2.15 6a \$2.10 \$1.25

**REPORTS REDUCTION
Grand Historical Places
Sporting Men Returned**

24 Point

Special Characters \$0.55 per font

5A \$1.80 8a \$1.70 \$3.50

**BRITISH MUCH ENTHUSED
Prosecuted Theatre Manager
Inspiring Conditions Prevail**

18 Point

Special Characters \$0.50 per font

7A \$1.55 12a \$1.70 \$3.25

**HANDSOME CRICKET CHAMPION
German Home Decorated Profusely
Millionaire Secured Valuable Farms**

14 Point

9A \$1.45 14a \$1.55 \$3.00

**RENUMBERED DOCUMENTS DISAPPEAR
Demand Unusual Amendments Obliterated
Legitimate Institution Opened Permanently**

12 Point

10A \$1.30 17a \$1.45 \$2.75

**FRENCH BRIG WRECKED
Insults Prominent Resident
Demands Public Retraction
Stolen \$1234567890 Money**

8 Point

13A \$1.10 20a \$1.15 \$2.25

**RIDING ACADEMY RUINED
Five Pupils Severely Injured
Saved Many Valuable Horses
Heroic Boy Escapes Accident
Effects Quite Heavily Insured**

10 Point

11A \$1.20 18a \$1.30 \$2.50

**PRINTED REVISED HISTORY
Lady Related Greek Episodes
Editor Advised Large Edition
Young Author Praised Works**

6 Point

13A \$0.95 22a \$1.05 \$2.00

**SHERIFF TRAPS BOLD ROBBER
Found Hiding in County Saw Mill
Desperate Battle Fought in Swamp
Stone Jail Contains New Boarder
Big Reward Paid for Clever Arrest
Important \$1234567890 Contracts**

The of ct o f fi n S E O R @  

These Special Characters are put up with all fonts from 6 to 14 Point inclusive They are sold in separate fonts from 18 to 72 Point inclusive

Thanks

We are thankful that in the regular order of our yearly program there is time to pause and think of the many things that we may be thankful for. We are above all else thankful for your patronage and for your faith in our ability to produce good printing. We are thankful that you have become a user of the **KARN QUALITY** and the hearty commendation of our numerous patrons has been a great source of encouragement to us. We are thankful that our business outlook for the coming year seems bright and promising

KARN & SONS
PRINTERS AND BINDERS

Bewick Border Chap-Book Guidon

American Type the Best Type
American Line the Best Line

JUST MY STYLE

What everybody says. That's the way we make them. When they don't suit, let us know it. But it's all in the filler. We use good, clean stock, the best on the market. That's just why the

EAGLE BRAND CIGARS

bring 10 cents and why you get your money's worth. We also make, for smokers who cannot afford a dime, "Tomboy," the best 5 cent cigar on the market. "Who keeps them?" Reliable cigar dealers everywhere. The easiest way to obtain them is to

ASK FOR THEM

If the dealer offers you other brands of cigars, tell him they stand no comparison with ours



MILTON 8 FULTON ST. FENNET
JAMESTOWN

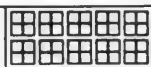

Post Condensed

72 Point

Special Characters \$0.40 per font

3 A \$5.50 4 a \$3.95 \$9.45

BRONZE Rack

60 Point

Special Characters \$0.30 per font

3 A \$4.25 4 a \$3.25 \$7.50

Bandits REMOVE

54 Point

Special Characters \$0.25 per font

4 A \$4.70 6 a \$4.30 \$9.00

DEMAND Equality

48 Point

Special Characters \$0.25 per font

4 A \$3.80 7 a \$4.05 \$7.85

**FURNISHED DOUGH
Brigadiers Disgraced**

42 Point

Special Characters \$0.25 per font

5 A \$3.25 8 a \$3.10 \$6.35

**GREATER ENTERPRISE
Professional Disqualified**

36 Point

Special Characters \$0.20 per font

5 A \$2.60 8 a \$2.55 \$5.15

**PROSPERING SHOEMAKER
English Gentlemen Returned**

Post Condensed

30 Point

Special Characters \$0.20 per font

5 A \$1.90 10 a \$2.35 \$4.25

RECLAIMED STRIKING DESIGNS
Introduce Many Original Features
Experienced Physicians Reminded

24 Point

Special Characters \$0.15 per font

6 A \$1.60 12 a \$1.95 \$3.55

TUTORS DEMAND ROMPING EXERCISE
State Boards Discarding Obsolete Method
Redecorated Heavy Hospital Automobiles

18 Point

Special Characters \$0.15 per font

10 A \$1.45 20 a \$1.80 \$3.25

ENTERPRISING FOREIGNER REQUIRED TEACHER
Mounted Soldiers Receive Extensive Encouragement
Greatest Parade Ground Attracts Visiting Scotchmen

14 Point

13 A \$1.30 26 a \$1.70 \$3.00

HONEST CLUB MEMBER DISCHARGED FAITHFUL SERVANT
Foreign Discoveries Unearth the Rarest of Biblical Manuscripts
American Type Founders Company Makes Post Condensed Type

12 Point

15 A \$1.10 31 a \$1.65 \$2.75

SAILOR RETURNED ABOARD CRUISER
Beautiful Creation Used by Advertisers
Abusive Baseball Fan Hurling Cushion
First Baseman \$1234567890 Suspended

8 Point

18 A \$0.95 38 a \$1.30 \$2.25

LAFAYETTE SECTION CHARMS VISITOR
Many Beautiful Parks Abounded Nearby
Five Lovely Girls Bathed in Newark Bay
Yacht Racing Enthused Retired Admiral
Largest Fish Caught Near Johnson Dock
Ocean Breeze Kept City Cool in Summer

10 Point

16 A \$1.00 35 a \$1.50 \$2.50

STUDENTS ACKNOWLEDGED PROFESSOR
Airship Flight Aroused Much Interest Here
Strongest Railroad Fireman Shoveling Coal
Disastrous Parachute Plunge Made Tuesday

6 Point

19 A \$0.80 42 a \$1.20 \$2.00

PROCURE THIS BEAUTIFUL CREATION AT ONCE
Including Exquisite Characteristics Throughout
Fine Automobile Crossed Overhead Bridge Today
Broad Jumpers Broke Records During Field Meet
Late Warm Weather Caused Much Trouble Here
Picnic Brought \$1234567890 Out Immense Crowd

a u f fi fl

These Special Characters are put up with all fonts from 6 to 14 Point inclusive. They are sold in separate fonts from 18 to 72 Point inclusive.

Post Oldstyle Italic

60 Point

Special Characters \$0 45 per font

3 A \$5 70 4 a \$3 40 \$9 10

BRIDGE Hold

48 Point

Special Characters \$0 45 per font

3 A \$4 15 6 a \$3 35 \$7 50

Crowns KINGDOM

36 Point

Special Characters \$0 30 per font

4 A \$2 60 7 a \$2 40 \$5 00

DESERVING Inhabitants

30 Point

Special Characters \$0 25 per font

4 A \$1 95 10 a \$2 40 \$4 35

**YOUNGSTER UNDECIDED
Secured Brightest Receptacles**

24 Point

Special Characters \$0 25 per font

5 A \$1 60 12 a \$1 90 \$3 50

**IMPROVED COUNTING DEVICE
Incorporate Investments Advancing**

18 Point

8 A \$1 50 18 a \$1 75 \$3 25
Special Characters \$0 20 per font

**BANKNOTE ROBBER
Dishonest Commissioners**

10 Point

14 A \$1 15 30 a \$1 35 \$2 50

**AMERICAN WORKINGMEN
Excited Manufacturer Applies
For Protection of His Property**

14 Point

10 A \$1 45 22 a \$1 60 \$3 05

**TYPOGRAPHY TAUGHT
Raise Trade Organizations**

8 Point

14 A \$1 00 33 a \$1 25 \$2 25

**DISCIPLES OF GUTENBERG RACE
For the Almighty Dollar a Life Time
Lack of Money is the Root of All Evil
No Epigrammatic Humor Attempted**

12 Point

12 A \$1 25 28 a \$1 50 \$2 75

**UNIVERSITY OPENS SEMESTER
Eighty-seven New Students Enlisted
Carney Offer \$1234567890 Rejected**

6 Point

16 A \$0 90 36 a \$1 10 \$2 00

**HIGHEST EXCHANGE PRICE RECORDED
Considerable Agitation for a Big Reduction
On Foreign Pulp Caused Domestic Dealers
After Months \$1234567890 of Deprivations**

N R a f si fl ft

These Special Characters are put up with all fonts from 6 to 14 Point inclusive They are sold in separate fonts from 18 to 60 Point inclusive

Post Oldstyle Italic in Practical Display



TIMBEL



Only Manufacturing Jeweler and Goldsmith in Venango County

ANNOUNCEMENT

I desire to call your attention to the fact that I buy old Gold. Look in those safe places in which you may have placed some trinkets that have been almost forgotten. Bring them to me and I will make an offer for them as old Gold, paying cash or exchanging for new. Jewelry though broken or out of style is nevertheless valuable.

*ALVIN TIMBEL
MACALMONTS, PENN.*

Della Robbia Festoons

*Send for Our Latest
Catalogues Showing
Some Winter Styles*



*Spruceup Shop was
Established in 1885
at Belmont, Maine*

Quality Clothing

In the world-famous IXL Clothing you are sure to receive best quality in material, elegance in style, and perfection in the fit. You get the experience of twenty-five years in the clothing business. Our work-shops are large, pleasant and comfortable. We are not in the sweat-shop zone. You will find an IXL sign at the door of every progressive clothier. If you will investigate our claims to superiority you will not wear any other. IXL is the Prince of ready-made clothing.

SPRUCEUP CLOTHIERS

Post Monotone

36 Point Special Characters \$0 45 per font 3 A \$2 65 6 a \$2 70 \$5 35

DESIGN SPECIMEN
Handsome Buildings

30 Point Special Characters \$0 35 per font 4 A \$2 10 7 a \$2 15 \$4 25

POST MONOTONE TYPE
Reliable American Series

24 Point Special Characters \$0 35 per font 5 A \$1 70 9 a \$1 80 \$3 50

NOTES ORIGINALITY SHOWN
Shipbuilder Repaired Lifeboats

18 Point Special Characters \$0 35 per font 7 A \$1 40 15 a \$1 85 \$3 25

POSTPONES GRAND POLICE REVIEW
Notable Mayors Discuss Bad Weather
Councilmen Smiled at Demonstrations

14 Point 9 A \$1 20 19 a \$1 80 \$3 00 8 Point 12 A \$0 85 29 a \$1 40 \$2 25

CAPTURES NIGHT RIDER
Visitor Climbing Mountain
Detectives Trailed Forgers

RAILROADS BEING REVIEWED
Wonderful Society Event Closing
New High Structures Demolished
Displaying Handsomest Qualities
Ingenious Device Made Saturday

12 Point 11 A \$1 10 25 a \$1 65 \$2 75 6 Point 12 A \$0 80 29 a \$1 20 \$2 00

RAPID COMPOSITOR MOVING
Prints Handsome Folder Monday
Beautiful Ornaments Being Made
Heaviest \$1234567890 Ordering

MODERN ROUNDHOUSE BURNING
Superintendents Holding Convention
Telephone Connections Made Friday
Monster Engine Saved by Brave Men
Read Paper Concerning Type Making
Valuable Reason Stated by Librarian
Post Monotone \$1234567890 Progress

10 Point 12 A \$1 05 25 a \$1 45 \$2 50 5 on 6 Point 14 A \$0 80 32 a \$1 20 \$2 00

BACHELOR WRITES LOVE POEM
Relates Early Experience with Girl
Picture Young Sweethearts Parting
Greatest Demand for First Editions

BICYCLE RACES PROVE INTERESTING
Making Boston Wire Stitchers Extensively
Buying Complete Series in Large Quantity
Express Train Broke Record During Trial
Making Sensational Run From West Point
Compositor Riding in First Car Forty Miles

The of a h m n o u E)

These Special Characters are put up with all fonts from 6 to 14 Point inclusive They are sold in separate fonts from 18 to 36 Point inclusive

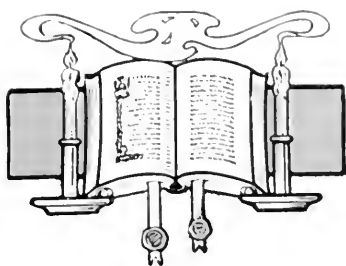

LORE

A MAGAZINE OF
THOUGHT

A promoter of the
new thought idea
and all advanced
theories of life, a
periodical for the
free. Independent
thinkers and men
of sound sense
support it

LORE COMPANY
LAKESIDE, OHIO

The Letter
for Artistic
Results in
Printing of
the Better
Class. The
Rich Effect
is Pleasing

"Back to Nature"

The Forest Club



List of the
Paid Membership
January First

JANUARY SALE



WILL CONTINUE
TEN DAYS ONLY

36 Point

4 A \$2 60 6 a \$2 40 \$5 00

TOUR ROMAN EMPIRE Delights Two Statesmen Prospector Brings Silver

30 Point

5 A \$1 90 10 a \$2 40 \$4 30

RETIRES OLDEST ADMIRAL Considers American Ensigns Sergeant Prepared Machinist

24 Point

6 A \$1 70 10 a \$1 80 \$3 50

MONTPELIER DAMSELS EXCITED Beautiful Maiden Disarmed Burglar Wise Police Captain Saw Dynamite

18 Point

9 A \$1 50 16 a \$1 75 \$3 25

GERMAN FINANCIERS Investigating New Theft Examine Smart Experts

10 Point

16 A \$1 15 32 a \$1 35 \$2 50

EXPLOSION INJURES PRINCE Noted Foreigner Escapes Death Bankrupt Policeman Explained Chorus Girls Fainted in Theatre Apprehend Automobile Owner

14 Point

13 A \$1 40 24 a \$1 60 \$3 00

BEAUTIFUL OPERA HOUSES Designed Eight Centuries Ago Architectural Beauty Pleasing

8 Point

17 A \$1 05 36 a \$1 20 \$2 25

GOVERNOR PARDONED PRISONERS State Executive Signed Papers Sunday Two Youthful Offenders Free Saturday Figured in Sensational Western Holdup Old Lawyer Aroused Public Sympathy

12 Point

16 A \$1 20 32 a \$1 55 \$2 75

FRENCH CRUISERS LEAVE TODAY Spent Eight Months in California Port Delighted Sailors Promising to Return Left Nearly \$1234567890 in Mexico

6 Point

18 A \$0 90 38 a \$1 10 \$2 00

DENTIST REMOVED TOOTH FROM MULE Pesky Creature Worries Shaky Molar Expert Six Farmhands Witnessed Novel Operation Animal Kicks Barn Door Into Kindling Wood Town Constable Ran Toward Moving Trains Railroad Fireman Consoled Nervous Officer Doctor Saw \$1234567890 Strange Persons

CAMPING IN THE ROCKIES



A GUIDE TO THE MORE DESIRABLE PLACES
FOR CAMPING AND TROUT FISHING IN THE
PICTURESQUE ROCKY MOUNTAINS



By GEORGE HAYNES

ISSUED BY THE GENERAL PASSENGER DEPARTMENT OF THE
COLORADO & NEW MEXICO RAILROAD

Blanchard Series

72 Point

3 A \$9 10 4 a \$5 70 \$14 80

HID Shirt

60 Point

3 A \$8 00 4 a \$5 25 \$13 25

Buys FIGS

48 Point

3 A \$4 90 4 a \$3 20 \$8 10

DINE Burglar

36 Point

4 A \$3 00 5 a \$2 00 \$5 00

Emperors HONEST

30 Point

4 A \$2 15 7 a \$2 10 \$4 25

PRINTERS Overheated

24 Point

5 A \$1 75 9 a \$1 75 \$3 50

Buying Stronger LINIMENTS

18 Point

7 A \$1 50 15 a \$1 75 \$3 25

**SUNBURN CURES
Make Useful Article**

10 Point

14 A \$1 20 26 a \$1 30 \$2 50

**DISCOVERED FORTUNE
Make Charming Ornament
Require Handsome Border**

14 Point

10 A \$1 40 21 a \$1 60 \$3 00

**COMPOSITOR WORKED
Secured Blanchard Series**

8 Point

16 A \$1 05 33 a \$1 20 \$2 25

**STORMING SEVERAL BAKERS
Wonderful Steamboat Constructed
Beautiful Bold Display Throughout**

12 Point

14 A \$1 40 22 a \$1 35 \$2 75

**FOUND MODERN SPECIMEN
Diving Exhibitions Witnessed
Request \$1234567890 Bonding**

6 Point

18 A \$1 00 34 a \$1 00 \$2 00

**TORPEDO EXPLODED NEAR TENANT
Shock Broke Large Plate Glass Windows
Report Awakens Policeman in Ball Park
Perpetrator Apprehended by Bold Sleuth
Magistrate Gives \$1234567890 Also Life**

Estates

ALONG THE HEALTHFUL AND PICTURESQUE SHORES OF THE WEST HEMINGSTONE RIVER AT BEAUTIFUL

Thistle Manor

MUIR & DEAN

879 ELIZABETH PLACE, ERIE



WALL DECORATORS

...w most desirable and and situated in a very u adjoining the finest recreation center that and affords the home improvements found and one of necessary purchasers free from onsequently splendid enjoyment instead of r special features not to be had in any other section of this country. The terms are indeed in the

Clothing

FOR DISCRIMINATING MEN



We have given a lot of attention to our latest stock of garments for men folks, and we feel sure that our clothing cannot be approached anywhere else for quality of the fabric, style and distinctiveness in tailoring. The number of handsome styles to choose from makes it easy for you to secure a satisfactory garment

HERMAN & STINER BROAD STREET HACKENSACK

72 Point

3 A \$8 95 4 a \$5 30 \$14 25

MEN Raid

60 Point

3 A \$8 15 4 a \$4 85 \$13 00

Rash GIRL

48 Point

3 A \$4 80 4 a \$2 95 \$7 75

HIRED Ladies

36 Point

4 A \$3 05 5 a \$1 95 \$5 00

Educated CHICKEN

30 Point

4 A \$2 20 7 a \$2 05 \$4 25

***MAD ACTOR
Grants Relief***

12 Point

14 A \$1 40 25 a \$1 35 \$2 75

***MIDNIGHT INTRUDER
Caught Behind Cornstalk
Prominent Doctor Named
Large \$1234567890 Sum***

24 Point

5 A \$1 70 10 a \$1 80 \$3 50

***LARGE FRAME
Mends Garments***

10 Point

14 A \$1 15 30 a \$1 35 \$2 50

***MANY STRANGE LADIES
Attended Grand Social Party
Daring Performer Prostrated
Policeman Overcome by Heat***

18 Point

8 A \$1 65 14 a \$1 60 \$3 25

***RETURNED HOME
Procures Advertisers***

8 Point

17 A \$1 10 36 a \$1 15 \$2 25

***CITY BOARDERS FOUND RELIEF
Delightful Lakes Refreshed Hundreds
Crowded Summer Resorts Triumphant
Excited Guest Admonished Proprietor***

14 Point

10 A \$1 40 21 a \$1 60 \$3 00

***HARMONY INCREASED
Operating Natural Spring
Neater Designs Advocated***

6 Point

19 A \$0 95 40 a \$1 05 \$2 00

***ACTORS RECEIVED GREAT APPLAUSE
Benevolent Societies Entertain Poor Children
Several Delinquent Cashiers Returning South
Pleasing Refined Musicales Recently Produced
Bright Country School Teacher Becomes Bride
Large Amount of \$1234567890 Money Inherited***



Order

*Your Printed Matter and
Advertising Typography
from Kinner*

N*EW methods in selling goods
have revolutionized all of the
business world during the last
ten years. A prominent advertising
expert struck twelve when he called
Printing the "Silent Salesman." As
a salesman Mr. Printing is a great
success. He never misrepresents you
and he never butts in when he isn't
wanted. He can always wait until
Mr. Prospect is ready. Unlike some
salesmen he doesn't try to tell all he
knows the first trip. He can call on
another day for two cents. Now is
the time to send your mail salesman
out talking for Fall business. Let me
dress him up for you. I have devoted
many years to the study of his needs
and know just what constitutes the
strongest appeal in his whole attire*



Boulton Kinner, Good Printer

Bruce Embellishers



*We desire to announce the addition of several hundred new
Records to our Talking Machine Department
We will be pleased to have you
come in and hear them*

THE MORGANTOWN MUSIC COMPANY

72 Point

3 A \$6 20 4 a \$4 15 \$10 35

DRINK Plenty

60 Point

3 A \$5 50 4 a \$3 80 \$9 30

Losing HEIFER

48 Point

4 A \$3 85 6 a \$3 65 \$7 50

MODERN Designers

36 Point

5 A \$2 55 8 a \$2 45 \$5 00

Honorable Games DISBAND

30 Point

5 A \$1 85 11 a \$2 40 \$4 25

CONDENSED Blanchard Showings

24 Point

7 A \$1 70 13 a \$1 80 \$3 50

**DISTINCT PRINTERS
Originating Specimen**

10 Point

20 A \$1 15 38 a \$1 35 \$2 50

**STYLISH CONDENSED BLANCHARD
Thousand Soldiers Marching South
Sailors Celebrate Splendid Victory
American Type Founders Company**

18 Point

10 A \$1 45 21 a \$1 80 \$3 25

**PRODUCTION CONSIDERED
Desirable Series Purchased**

8 Point

25 A \$1 00 50 a \$1 25 \$2 25

**LONGEST BUILDING BEING PAINTED RAPIDLY
Warmer Spring Weather Caused Untold Suffering
Eighty Orators Read Declaration of Independence
Farmers Crowd Every Available Spot Wednesday**

14 Point

16 A \$1 45 28 a \$1 55 \$3 00

**RUSHED SWIFT FREIGHT ENGINE
Marine Bugler Discharged Tuesday**

7 Point

26 A \$1 00 53 a \$1 25 \$2 25

**RUSHING SUBURBAN FREIGHT TRAIN JUMPS TRACK
Engine Traveling at Highest Speed When Rails Spread
Conductor Shouted Warning to Several Scared Women
Wrecking Crew Lifts Scalded Fireman into Ambulance**

12 Point

18 A \$1 30 33 a \$1 45 \$2 75

**SUBMIT HANDSOME ADVERTISEMENTS
Compositor Receiving Beautiful Souvenir
Visits Rockaway \$1234567890 and Bathes**

6 Point

26 A \$0 90 55 a \$1 10 \$2 00

**ONE TREMENDOUS UNDERTAKING PROVED SUCCESSFUL
Magnificent Country Home Burned Near Washington Heights
Society Leader Entertains Coaching Party Before Breakfast
Fine Ornaments and Borders Always Help Commercial Work
Many Reliable Workmen \$1234567890 Make Honest Fortunes**



PRINTING OF HIGHEST QUALITY

The Quality of printed matter depends largely on the style and originality displayed in the composition. Mechanical finish and good workmanship are only obtainable through the use of proper equipment. If you desire genuine quality use American Line type

AMERICAN LINE THE BEST LINE

Aerial Cuts Art-tile Tint Formers

SPRING

Will Soon be With Us

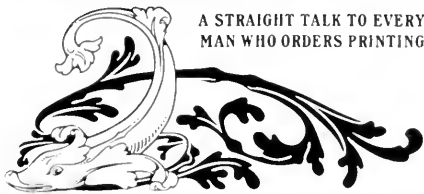

A STRAIGHT TALK TO EVERY
MAN WHO ORDERS PRINTING

The blue birds will soon be here and we are all well aware that the balmy days of Springtime mean a consequent change of stocks by all merchants and store-keepers. No matter what line, there will be a new article added or an old one dropped. You will then need some seasonable advertising. Our agent will call on you next week with a full line of Special Announcements

KANE PRINTING CO.

NORTH MILWARD STREET, KANE, PENNSYLVANIA

A long
streak
of gold



Versatile Border

72 Point

3 A \$8 55 4 a \$5 95 \$14 50

NICE Ride

60 Point

3 A \$7 65 4 a \$5 35 \$13 00

Kind GIRLS

48 Point

3 A \$4 80 4 a \$3 35 \$8 15

HOME Leased

36 Point

3 A \$2 75 5 a \$2 25 \$5 00

Interesting LECTURE

30 Point

4 A \$2 00 8 a \$2 25 \$4 25

MECHANICS Considered

24 Point

5 A \$1 75 9 a \$1 75 \$3 50

Distinguished PHILOSOPHERS

18 Point

8 A \$1 55 14 a \$1 70 \$3 25

ENEMIES FIGHTING Many Distant Points

10 Point

15 A \$1 15 30 a \$1 35 \$2 50

DISPENSING RIGID JUSTICE Long Sentences Given Crooks Unfortunate Boy Condemned

14 Point

12 A \$1 50 19 a \$1 50 \$3 00

PROMINENT PREACHER Discussing Historic Events

8 Point

18 A \$1 05 34 a \$1 20 \$2 25

LONG LOST BROTHER RETURNED Roamed Country Twenty-One Hours Detectives Recovered Stolen Property

12 Point

15 A \$1 35 24 a \$1 40 \$2 75

GIGANTIC SCHEMES EXPOSED Eminent People Organized Lodges Admired \$1234567890 Detective

6 Point

20 A \$0 90 40 a \$1 10 \$2 00

HANDSOME YOUNG ANIMAL TRAINERS Desperate Encounter With Ferocious Panther Several Assistants Gently Squeezed by Bruin Considerable Excitement Naturally Prevailed Band Rendered \$1234567890 Excellent Music

HOMIES IN THE COUNTRY

GRASP THIS GREAT OPPORTUNITY TO
SECURE ONE OF THESE FINE DWELLINGS

Paying Rent?

BY OUR ARRANGEMENT YOU CAN SOON OWN
YOUR OWN HOME AND BECOME INDEPENDENT
OF THE REGULAR VISITS OF RENT COLLECTORS

HOUSES of six, seven and eight
rooms in Garfield County, all
ready for you to move into.
Each of these houses has all modern
improvements; bath, toilet, running
water, steam heater and gas. They
are built on a plot of land 150x225
feet all graded, curbed and flagged.
The high elevation of this property
and its beautiful surroundings give
to it the necessary features for the
ideal location of a home in the open
country. Fine railway connections
and several very good roads make
commutation a pleasure. The close
proximity of Lake Wavecrest gives
access to one of the most delightful
bathing, boating and fishing resorts
that will be found in this section of
the country today. Send for booklet

JOHN KINGS & CO.
SPRINGDALE CENTER, SOUTH CAROLINA



72 Point

3 A \$9 50 4 a \$5 50 \$15 00

HIRE Birds

60 Point

3 A \$7 05 4 a \$4 20 \$11 25

Stylish RINK

48 Point

3 A \$4 65 4 a \$2 85 \$7 50

PRICE Chimneys

36 Point

4 A \$2 60 7 a \$2 40 \$5 00

Photograph PROCURED

30 Point

4 A \$1 90 10 a \$2 35 \$4 25

ENLIGHTEN Richest Student

24 Point

5 A \$1 60 12 a \$1 90 \$3 50

Charming Specimens REPRODUCED

18 Point

8 A \$1 50 18 a \$1 75 \$3 25

HONEST SERGEANTS
Magnificent Government

10 Point

16 A \$1 25 32 a \$1 25 \$2 50

SOLD MONSTER SWORDFISH
Contains Strong Display Features
Greatest Librarian Became Noted

14 Point

12 A \$1 45 24 a \$1 55 \$3 00

DETERMINED POLICEMEN
Hearst Italic Series Purchased

8 Point

20 A \$1 15 38 a \$1 10 \$2 25

DOUBLE COLUMN HEADING SECURED
Former Theatrical Stars Hold Big Banquets
Artistic Methods Originated by Compositors

12 Point

15 A \$1 30 30 a \$1 45 \$2 75

TREMENDOUS ORDERS RECEIVED
Composed Remarkable Advertisement
Handsome \$1234567890 Structures

6 Point

22 A \$1 00 42 a \$1 00 \$2 00

SEVERAL HUNTSMEN CAPTURE YOUNG BISON
Found Animals Near Large Swamp in North America
New Mascot Becoming Desperate When Securely Tied
Gentleman Fired Huge Rifle Several Times Yesterday
Trophy Presented \$1234567890 Zoological Gardens

The
Burk College
of Design



ARTISTS who received their training in this college are all holding responsible positions in the different designing and illustrating houses throughout the country. There is no other college in which the students' drawings are exactly the same as the practical work done in fashion and engraving houses and in the art departments of newspapers and magazines, and no other school which can get its students practically into the illustrating business

For tuition rates and particulars apply to

The Burk College of Arts & Crafts

HENRY W. BURK, Art Director

*Studio Building, 18 Market Street
Denmark, Maine*

72 Point

3 A \$725 4 a \$190 \$12 15

HUMBLES
Education

60 Point

3 A \$640 4 a \$400 \$10 40

TRICKSTER
Housewives

48 Point

4 A \$460 5 a \$295 \$7 55

STENOGRAPH
Romantic Story

42 Point

4 A \$375 5 a \$250 \$6 25

FINISHED TYPE
Beautiful Flowers
Society Magazine

36 Point

4 A \$2.05 7 a \$2.40 \$5.05

PRISONER FIGHTS Lovelorn Bridesmaid Productions Improve

30 Point

4 A \$2.05 8 a \$2.20 \$4.25

TRANSPORT SOLDIERY Sunshine Creates Beauty Modern Home Nuisances

24 Point

5 A \$1.60 10 a \$1.90 \$3.50

IMPECUNIOUS PUBLISHERS Company Receiving Demands Undergoes Excruciating Pains

18 Point

8 A \$1.60 15 a \$1.65 \$3.25

AMERICAN TOURS Theatre Quarantined Springtime Musings

10 Point

14 A \$1.15 30 a \$1.35 \$2.50

VICTORIOUS REGIMENTS Popular Magazines Prosper Ceased Dreaming Troubles Mendicant Became Banker Eternal Friends Are Scarce

14 Point

10 A \$1.45 20 a \$1.55 \$3.00

ARTIST THREW EDITOR Champion Acknowledged Retirement Now Probable

8 Point

17 A \$1.00 34 a \$1.25 \$2.25

AEROPLANES BECOME POPULAR Series of Aerial Cuts Now in Stock Cast in Type Molds by this Foundry Modern Printers Find Them Useful Publishers and Sportsmen Pleased

12 Point

14 A \$1.25 28 a \$1.50 \$2.75

MECHANICS AMUSE PEOPLE Popular Cosmopolitans Parade Disastrous Steamer Excursion Strange \$1234567890 Incident

6 Point

18 A \$0.90 38 a \$1.10 \$2.00

ADVERTISING HANDSOME SOUVENIRS Highly Developed Artistic Ability in Menus Procrastination Is The Embezzler of Years Distinguished Individuals Gather Secretly Excusable Phrases Occasionally Appearing Interesting Demonstration in Metaphysics Reliable Printers \$1234567890 Convention

Boston Breton in Practical Display

REX THEATRE

CORNER KING AND MONROE STREETS



The ideal vaudeville theatre, designed and conducted for the entertainment of ladies and gentlemen. During the four years of its existence it has buried the ghost of decollete variety, enlisted and secured the support of real people, thus establishing a standard in operation and entertainment to which few theatres of any class ever attain. There is a reason. Success does not come by accident; we have earned success through careful management, always preserving an atmosphere of refinement, and then the best combination of stars and skilled entertainers that can be found in the world

SEND FOR ILLUSTRATED BOOKLET

Strathmore Border Strathmore Ornament



HE FEEDS FOLKS RIGHT

Michael runs a restaurant; the restaurant does not run Michael. It is a restaurant that is more than a place to eat. Its fittings are in the most exquisite taste, and the meals are unsurpassed

MICHAEL'S HOME RESTAURANT

MASK

A MAGAZINE FOR THE STAGE

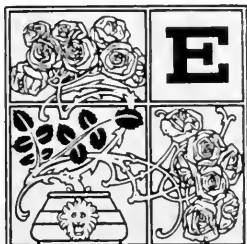

EVERY member of the profession now has a publication on which he can firmly rely. It will be truly representative and its columns will at all times be open to herald the advent of a new enterprise or tell of the continued glorious run of some real success. It will glean from every quarter of the

latest theatrical news. record the most up-to-s and keep managers productions of merit. l be devoted to make s advertising medium ssurances have been flattering description tion list will not only ut more than ordinar-The paper will go into l be read by people of vertisers, people with now how to spend it.



INK & SONS

HFIELD ROAD, ENGLAND

TREES

SHRUBBERY
AND HOTHOUSE
PRODUCTS



We are constantly improving our output, thus providing our patrons with the best stock

HENTZ & MINER

SHERIDAN, NEW JERSEY

144 Point

3 A \$12 80 4 a \$8 50 \$21 30

HER Cat

120 Point

3 A \$8 70 4 a \$5 65 \$14 35

**UNHITCH
Phantoms**

96 Point

3 A \$6 50 4 a \$4 15 \$10 65

**QUESTIONS
Investigated**

72 Point

3 A \$5.15 4 a \$3.35 \$8.50

UNBLEMISHED
Roguish Director

60 Point

4 A \$4.80 5 a \$3.20 \$8.00

MINTS OBSERVED
Destroying Mansion

48 Point

4 A \$3.20 7 a \$3.05 \$6.25

PREVIOUS ERUPTIONS
Establishments Deserted

42 Point

5 A \$2.80 8 a \$2.45 \$5.25

FLOURISHING COUNTRIES
Bravest Individuals Returned
Handsome Characters Stolen

36 Point

5 A \$2 15 8 a \$2 10 \$4 25

RECOVER STOLEN PENDANTS Distinguished Gentleman Ejected Sanctions Railroading Expedition

30 Point

6 A \$2 00 10 a \$2 00 \$4 00

EDITOR CONSIDERS TERMS UNJUST Southwestern Rangers Detained Ladies Monstrous Gathering Remains Standing

24 Point

8 A \$1 70 15 a \$1 80 \$3 50

HUMBLE PEASANTS RELISH ANGEL CAKES International Agreement Satisfies Unprejudiced Practical Designers Realized Stupendous Profits

18 Point

10 A \$1 45 23 a \$1 80 \$3 25

TRAMP STEAMER RETURNS Conductor Threatened Foreman Aged Swindler Deceives Banker

10 Point

22 A \$1 15 46 a \$1 35 \$2 50

SPURIOUS MONEY CAUSING TROUBLE Castles of Bonnie Scotland Attract Many Fascinating Widow Entertains Boarders New England Resorts Advertise Weekly Handsome Souvenirs For Country Ladies

14 Point

14 A \$1 30 34 a \$1 70 \$3 00

WELCOMING UNBIASED JUDGMENT Charitable Aristocrat Bequeaths Estate Remote Domicile Escapes Big Calamity

8 Point

24 A \$1 00 54 a \$1 25 \$2 25

JAPANESE MERCHANTS DESIRE ENGLISH TRADE Stylish Neckwear Bargains Continuing in Popularity Mirthful Seminary Instructor Apparently Unpopular Herculean Athlete Easily Defeats Amateur Favorite Inexperienced Mechanics Demanding Fabulous Sums

12 Point

19 A \$1 25 39 a \$1 50 \$2 75

SUBMARINE CAPTAIN RESCUES HUNDREDS Beautiful Imported Porcelain Dishes Destroyed Undesirable Features Eliminated From Booklet Extraordinarily \$1234567890 Handsome Type

6 Point

28 A \$0 85 60 a \$1 15 \$2 00

BENEVOLENT MANUFACTURERS TENDERED FISH DINNER Deafening Explosion Shatters Skyscrapers Within Eight Miles Intended Polar Expedition Considered Hazardous Undertaking Formidable Pugilist Seeking Undisputed Championship Honors Relegate Worn and Battered Type to the Hell Box and Instead Have New American Line Type Which Insures Largest Profits Conspicuous Ornamentation \$1234567890 Not Always Tasty

Wall Paper

One of the most important items in the art of home decorating is Wall Paper. To secure appropriate coverings for the walls of each of the different rooms is by no means an easy task and should invariably be left to an expert or one who is versed in the art. We have been doing this class of decorating for over twenty-one years and feel assured we can meet your most exacting wants

Furman & Morganson

Number 29 North Eighteenth St

LET US ESTIMATE ON YOUR
NEXT JOB OF DECORATING

Versatile Border Cheltenham Paragraph Mark

Telephone 139 Main

Established 1879

HARDMAINE & LANGFORD

No. 149 Market Street AUSTIN, ILL.

HIGH-GRADE CROCKERY OF
EVERY DESCRIPTION

Glassware

PROFIT

In the Composing Room

IS SECURED BY A JUDICIOUS USE OF
American Line Type

Noted for Its Great Wearing Qualities

Panel Border Art-tile Tint Formers

72 Point

3 A \$3 35 5 a \$2 70 \$6 05

SECURES MOUTHPIECE
Discover Reliable History

60 Point

4 A \$3 15 6 a \$2 85 \$6 00

REIGNING KINGS CONSPIRE
Desired Condensed Headings

48 Point

6 A \$3 15 10 a \$3 15 \$6 30

WESTERN HEMISPHERE SCENERY
Secure Convenient Printing Material

42 Point

6 A \$2 55 12 a \$2 70 \$5 25

PURCHASING SOUTHERN PROPERTIES
Distinct Type Material Pleases Customers
Merchants Reprimanded Tardy Workmen

36 Point

7 A \$2.00 11 a \$2.25 \$4.25

TOUGHS ENCOUNTER NERVOUS ENGINEMEN
Prompt Reliable Workmen Secured Knowledge

30 Point

10 A \$2.00 19 a \$2.15 \$4.15

RESEARCHING BEAUTIFUL HISTORICAL SPECIMENS
Newspapers Acquired Boston Breton Extra Condensed
Knighted Monarch Spending Inherited Money Lavishly

24 Point

11 A \$1.60 23 a \$1.90 \$3.50

TENTH INDEPENDENT CHAMPIONSHIP INTERESTS HUNDREDS
Healthful Mountain Atmosphere and Sparkling Spring Water Cure
Charming Useful Display Obtained By Using This Beautiful Series

18 Point

15 A \$1.45 31 a \$1.80 \$3.25

DISTINGUISHED ARTIST PRINTS FOLDER
Mountain Climbers Gained Headway Friday
This Bold Type Series Always Prominent

10 Point

27 A \$1.15 54 a \$1.35 \$2.50

MINERAL DEPOSITS PROVING VERY CREDITABLE
Proper Selection of Type Faces Repays Purchaser
Longest Railroad Train Ever Drawn by One Engine
First Entertainment Receiving Generous Patronage
Noted Arctic Explorer Received By Admiring Hosts

14 Point

20 A \$1.35 42 a \$1.65 \$3.00

OBSERVE BEAUTIFUL CHARACTER THROUGHOUT
Prosperous Farmers Raising More Wheat and Corn
Southwestern Excursion Sideswiped Freight Train
Modern Workmen Received Many Praising Words

8 Point

36 A \$1.00 70 a \$1.25 \$2.25

BURNING SHIP REPORTED SINKING AFTER BOILER EXPLOSION
Distinguished Curious Documents Being Unearthed in Jerusalem
Numerous Improvements Noted Throughout Several Departments
Serious Questions Wisely Answered By Experienced Investigator
Excellent Condensed Letter for Display Headings and Advertising
Powerful Dreadnaughts Anchor in North River After Long Cruises

12 Point

23 A \$1.25 47 a \$1.50 \$2.75

GREATEST EMPIRES MANIPULATING AMICABLE PEACE
Warmest Weather Makes Nature Come Forth With Flowers
Ships Returning From Abroad Report Damaging Earthquake
Specimen Printers Study S1234567890 Modern Workmen

6 Point

35 A \$0.90 70 a \$1.10 \$2.00

GREATEST EXHIBITION OF SOLID VESTIBULED TOURIST CARS IN BERLIN
Remarkable Enthusiastic Demonstration Shown Great Acrobatic Performers
Conservative Newspaper Publication Bought Boston Breton Extra Condensed
Merchants Advertising Numerous Holiday Specialties to Aid Prudent Buyers
Armies Crushed Owing to Mismanagement of the Cavalry After First Charge
Large and Influential Population Request New Buildings Be Erected at Once
May Celebrate the Birthday of S1234567890 the Greatest American Printer

WE PAY INTEREST

CAPITAL \$25,000,000
SURPLUS \$5,000,000



On all inactive or savings accounts we will pay interest twice a year, adding to deposits of this character three per cent. per annum—the earnings of your savings. This will make your money work and give you a safe, sound investment, backed by all the strength of this bank, without risk or trouble of any kind on your part. Better bank your savings than have them hidden around the house as bait for burglars. We guarantee absolute safety. Come in at your convenience and let us talk the matter over. We are always ready to open new accounts

JOHN C. HENDERSON, President
HENRY THORNE, Vice-President
FREDERICK KRAMLEER, Cashier

Private safes in our burglar and fireproof vaults are being rented rapidly by persons who appreciate the security and convenience obtainable for less than two cents a day. Don't delay; write for full information

THE FIRST WARD NATIONAL BANK

OF THE CITY OF PROVIDENCE, RHODE ISLAND ESTABLISHED 1842

Tabard Border — Versatile Ornament

THE VERY HIGHEST QUALITY

THE VERY FAIREST PRICES

WE will hold our Annual Winter Sale of Furniture during the first three weeks of February. A most liberal discount will be offered on every article of our stock. This stock of furniture comprises correct pieces for any room in the house

SPANGLER FURNITURE COMPANY

RUDENKLEM MOTORS

MOTORS of this character are especially suited for being used upon rotary, web and cylinder presses, and for other classes of machinery requiring six horse power or more for operation. They are all of the multipolar type and have round cast-iron frames with feet for attachment to rail-base or brackets. Poles are of steel cast-welded into the frame and journal boxes are supported by three-arm bronze brackets attached to each side of the frame. Shaft bearings are of the RM kind

Our Motors are supplied with a nameplate "R" cast into frame and absolutely guaranteed for highest quality of material and efficient power



R

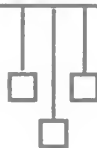

ESTABLISHED 1872

As pioneer makers of motors we have a great reputation to maintain. Quality and material of unequalled excellence are always embodied in each motor of our make



RUDENKLEM & MANFIELD

JOHN MANFIELD, Mgr. MAIN OFFICE AND FACTORY LOCATED AT ARLINGTON HEIGHTS, ILLINOIS

NEW YORK PHILADELPHIA CLEVELAND LOS ANGELES

84 Point

3 A \$9 60 4 a \$5 60 \$15 20

MENDER
Hand Sort

72 Point

3 A \$7 95 4 a \$4 55 \$12 50

BUNTINGS
Color Black

60 Point

3 A \$7 10 4 a \$4 00 \$11 10

GRUMBLER
Marks Never

48 Point

3 A \$4 45 5 a \$3 05 \$7 50

REMOUNTINGS
Bundle Delivered

42 Point

3 A \$3 35 6 a \$2 90 \$6 25

MISREPRESENTS Receiving Admiralty

36 Point

5 A \$2 70 7 a \$2 30 \$5 00

CONSTRUCT HOUSES Printing Beautiful Colors

30 Point

5 A \$2 20 9 a \$2 05 \$4 25

HISTRIONIC BURLESQUER Bestowed Compliments Galore

24 Point

6 A \$1 80 11 a \$1 70 \$3 50

DRINKING FOUNTS PRESENTED Sister Musicians Entertain Banqueter

18 Point

9 A \$1 60 18 a \$1 65 \$3 25

DELIGHTED PRINTER Foster Series Purchased Investment Brings Trade

10 Point

18 A \$1 25 37 a \$1 25 \$2 50

NOTED PIANO MOVER HIRED Thereby Gathering Finest Materials Ungoverned Mountain People Came Some Ships that Pass in the Evening Complete Victory Sometimes Defeat

14 Point

13 A \$1 50 25 a \$1 50 \$3 00

ENDURE MODERN METHOD Entire Fortune Slowly Consumed Destroying Magnificent Steamer

8 Point

22 A \$1 10 44 a \$1 15 \$2 25

CONTINUOUS PERFORMERS AMUSING Advance Geological Theory Concerning Rain Triangular Compartment Home Comfortable Musical Servants Greatly Astonish Japanese Obtained Beautiful Two-Color Arrangements

12 Point

16 A \$1 40 30 a \$1 35 \$2 75

NEMESIS CONSTRAINS TOURIST Transcontinental Railroaders Convene Removed \$1234567890 Obstruction

6 Point

24 A \$1 00 46 a \$1 00 \$2 00

WAVE MOTION THEORY QUICKLY ADVANCED Central Americans Enriched Through Tobacco's Sale Davy Jones' Locker Discovered by Submarine Boats Charming Princess Quickly Denies Royal Household Very Legible Face \$1234567890 A Useful Display

Holiday

FOLDERS AND BOOKS

REAL novelty and elegance are to be found in all the Christmas and New Year Cards, Greetings and Folders displayed at our store. Mottoes and bits of portable wisdom in rich designs. Holiday Booklets recommendable for young folks in large assortment. These have positive merit, being artistically bound with cover and well printed. They are sure to prove very interesting to the boy or girl. You are urged to come in and look these over at your earliest convenience



Folder containing Views of Niagara Falls
Free with every purchase

Ask to see the Mowrey X-mas Card
the Original Holiday Novelty

The Mowrey Store

South Buffalo, New York

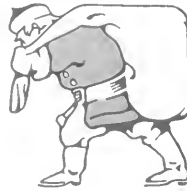



Oriental Rugs

IT WOULD STARTLE THE CRAFTY DEALERS OF THE FAR EAST TO SEE OUR GREAT STOCK OF VERY FINE SPECIMENS OF RUG MAKING WITH THE PRICE OF EVERY PIECE MARKED PLAINLY

The stock carried by this firm is selected by our experts who know every detail in the art of rug-making. We can therefore assure you an absolutely perfect and reliable purchase

MERICK RUG SHOP
CRAIG AND NEW STREETS, BURLINGTON



Roberts & Son

CORNER HARRISBURG AND HUNTERDON STREETS, NORTH DOVER

Wholesalers of the Finest Dry Goods

Embroideries

IN DESIRABLE WIDTHS UP TO NINE INCHES

HANDSOME patterns in Swiss, cambric and nainsook embroideries; both edges and insertions, solid, mixed and raised work designs; clean, crisp, fresh goods, desirable for almost every purpose where fine embroidery is required; widths range up to nine inches, permitting many unusual and attractive workings. To the out-of-town customer who may desire to take advantage of this fine assortment we will send our specially illustrated catalogue upon receipt of six cents to cover postage. It quotes many splendid bargains

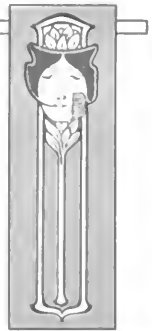

84 Point

3 A \$7.65 4 a \$1.60 \$12.25

FINISHERS
Design Knife

72 Point

3 A \$6.50 4 a \$4.00 \$10.50

EXTINGUISH
Rating Highest

60 Point

3 A \$5.75 4 a \$3.45 \$9.20

DESCRIPTION
Contains Quality

48 Point

4 A \$3.95 7 a \$3.55 \$7.50

PRINTED FOLDER
Beautiful Characters

42 Point

1 A \$3 10 8 a \$3 15 \$6 25

BRIGHTER STUDENT Used Condensed Series

36 Point

5 A \$2 70 8 a \$2 30 \$5 00

FOREIGNER PROSPERED Delightful Boating Excursion

30 Point

6 A \$2 20 10 a \$2 05 \$4 25

AMERICAN TOURIST RETURNS Shipwrecked During Heavy Storm

24 Point

7 A \$1 75 13 a \$1 75 \$3 50

GERMAN DESTROYS FORTIFICATION Souvenir Hunters Purchase Finest Picture

18 Point

11 A \$1 60 21 a \$1 65 \$3 25

SAFEBLOWER DESPISED Overcrowded Penitentiaries Hundred People Endangered

10 Point

20 A \$1 25 38 a \$1 25 \$2 50

NORTHERN RESORTS REMOVED Sunburned Bathers Paraded Beaches Clever Diving Exhibitions Given Once Numerous Damsels Among the Crowd Striking Costumes Being Worn Lately

14 Point

15 A \$1 45 30 a \$1 55 \$3 00

HANDSOME HISTORY PRINTED Contained Exclusive Military Stories Twenty Halftones Being Reproduced

8 Point

24 A \$1 05 48 a \$1 20 \$2 25

COMMENDED DELIGHTFUL STEAMER TOUR Visiting Important Coaling Stations While Enroute European Coast Dwellers Get Considerable Money Australian Herders Entertain Tourists with Feast Spanish King Amused Audience from High Balcony

12 Point

18 A \$1 35 35 a \$1 40 \$2 75

BUYING CONDENSED FOSTER SERIES Showing Handsome Characters Throughout Produces More Original Exquisite Features Lovely Figure \$1234567890 Gains Friend

6 Point

25 A \$0 95 50 a \$1 05 \$2 00

MARATHON CONTESTS PROVED GRUELING FRIDAY International Representative Making Game Attempt to Win American Type Founders Company Faces Receive Praises Ornaments and Brass Rule Used for Handsome Decorations Careful Buyers Secured Borders and Quads in Abundance Haberdashery Sold Genuine Paoama Hats Last New Years Youthful Office Devil \$1234567890 Asked Many Questions

American Lead and Rule Cutters

THEY ARE GUARANTEED TO BE ABSOLUTELY
ACCURATE AND WILL NOT GET
OUT OF ORDER

RECENT improvements make American Lead and Rule Cutters the best on the market. In the new models it is impossible for the front or lower gauge to slip or be forced out of position in cutting heavy slugs or rules. The accurate register of the gauges is absolutely maintained. The novel methods of adjusting and locking the gauges, together with several other improvements, met with the immediate approval of leading printers everywhere, and today the American Lead and Rule Cutters are generally conceded to be by far the best cutters made, not in one point, but all points. To begin with, the gauges can be set instantly, effecting a very material saving in time. They are locked automatically, there being no screws to change.

**AMERICAN
TYPE FOUNDERS CO.**

Sane Talks

THE FIRST OF A SERIES OF BRIEF TALKS
OF INTEREST TO THE LIVE ADVERTISER

HAS it ever occurred to you what good type style has to do with advertising? One of the best known advertisers in America has paid as high as fifty dollars for setting up a single advertisement, standard magazine page size. This man knows there is value in correct typography. Many years of analytical experience and careful tabulation of results have shown him that the selling power of an advertisement can be doubled by clean typography. A staff of high-priced competent workmen is most important. For years we have made a specialty of neat graphic typography

STEIN & KENT
89 John Street, Cleveland

We were awarded First Prize of Eight Hundred Dollars for excellence of Typographical Display in the recent advertising booklet contest open to the world, conducted by the Smyth Advertising Company. This booklet is devoted to the discussion of the cost of printing, matters pertaining to the successful management of an advertising campaign and to the showing of samples of fine paper in practical use. Send today for the beautiful booklet and you will be amply repaid

84 Point

3 A \$9 60 4 a \$5 60 \$15 20

DEMURE

Tired Man

72 Point

3 A \$7 95 4 a \$4 55 \$12 50

FREIGHTS

Ropes Buck

60 Point

3 A \$7 10 4 a \$4 00 \$11 10

SLUMBERS

Noisy Broker

48 Point

3 A \$4 45 5 a \$3 05 \$7 50

ENGLISH DUKE

Old Doctors Gone

42 Point

3 A \$3 35 6 a \$2 00 \$4 25

ELDER BROTHER
Bulgarians Migrated
Quarantined Tinkers

36 Point

4 A \$2 70 7 a \$2 30 \$5 00

NORTHERN CHEMIST
Celebrated Philosophers
Longest Building Noticed

30 Point

5 A \$2 20 9 a \$2 05 \$4 25

SOBER KINGS
Beautiful House
Hound Alarmed
American Ideas

18 Point

9 A \$1 60 18 a \$1 65 \$3 25

FINE PRODUCTS
Lonesome Klondike
Bought Gold Knives
Strangers Returned

14 Point

13 A \$1 50 25 a \$1 50 \$3 00

STOUT BLACKSMITH
Corporal Became Angry
Majors Disregard Order
Gentleman Catches Thief

24 Point

6 A \$1 80 11 a \$1 70 \$3 50

TRICKY HUNTER
Wins Championship
Modest Lieutenants
Journeys Eastward
Stylish Open Faces

12 Point

16 A \$1 40 30 a \$1 35 \$2 75

HONOR DUTCH BUGLERS
Performance Begins Tuesday
Egyptian Inspected Dungeons
Ladies View Ancient Sphinx
City \$1234567890 Printers

Elinhurst

MOTOR CARS

The Embodiment
of all that is Requisite
and Desirable in
Motor Car
Construction

New Grill Room

HOTEL MADISON
51 Bond Street, Miles, Pa.



JOHN N. MILERSON, Manager

Our new Grill Room is the finest in the city; a place for refined folks to dine and wine. The dining-room will seat three hundred people and in addition to this there are nine private rooms for parties that desire exclusiveness.

NORTHEAST & BERLIN

RAILROAD

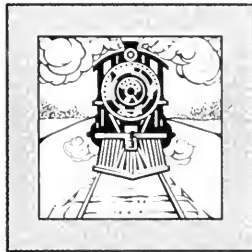

SPECIAL EXCURSION

July 4th

To Niagara Falls and Buffalo

For Tickets and General Information Write to
GEORGE W. HOLMES, General Passenger Agent

Room 12, Mountain Building
CHICAGO

84 Point

A \$7 65 4 a \$4 60 \$12 25

ENTRENCH

Rusty Sticks

72 Point

3 A \$6 50 4 a \$4 00 \$10 50

PERSPIRING

Rushing Alone

60 Point

3 A \$5 75 4 a \$3 45 \$9 20

KINGFISHERS

Insured Burglar

48 Point

4 A \$3 95 7 a \$3 55 \$7 50

EXPOSE METHOD

Uglier Hyena Caught

42 Point

1 A \$1 10 8 a \$1 15 \$6 25

MODERN BUILDINGS
Open Letter Purchased

36 Point

5 A \$2 70 8 a \$2 30 \$5 00

DETERMINED QUALITIES
Compositor Returns Monday

30 Point

6 A \$2 20 10 a \$2 05 \$4 25

SECURES PRINTING MECHANIC
Remarkable Physical Geographies

24 Point

7 A \$1 75 13 a \$1 75 \$3 50

PROMINENT SPEAKERS INTERESTED
Lecturing Knights Praise Condensed Webb
Useful Series for Registered Color Designs

18 Point

11 A \$1 60 21 a \$1 65 \$3 25

HIRE STRONG BUTCHERS
Owning Valuable Newspaper
Machinists Playing Checkers
Injuring Pigeons Near Castle

12 Point

18 A \$1 35 35 a \$1 40 \$2 75

EXTRAORDINARY STRENGTH
Graceful Spanish Beauty Dancing
Entertaining Neat Society Leader
Marvelous Development Exposed
Handsome Creations Satisfactory
Sixteen \$1234567890 Members

14 Point

15 A \$1 45 30 a \$1 55 \$3 00

FINEST SYSTEM THROUGHOUT
Ornamental Type Commands Notice
Untutored Diplomat Remained Silent
Educated Astronomer Finds Jupiter

10 Point

20 A \$1 25 35 a \$1 25 \$2 50

PRINCIPAL HOUSES REOPENING
Handsome Burlesque Maidens Charm
Greatest Land Fraud Exposed Today
Stalwart Farmer Plowing an Orchard
Handsome Greyhound Became Docile

Pipe Organs

INSTRUMENTS OF EXQUISITE TONE FOR HOME OR CHURCH

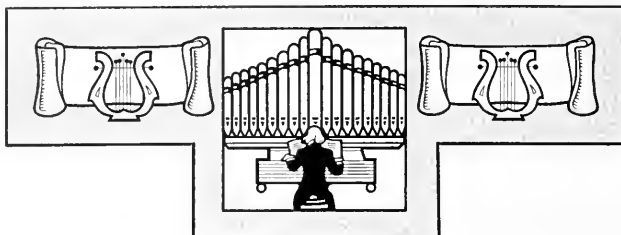

Known to the Musical World as the Perfection
of the Pipe Organ Maker's Art

MADISON ORGAN COMPANY

Versatile Ornaments Inland Border No. 240021

Institute of Arts

AMERICA'S BEST SCHOOL OF ILLUSTRATING

There are more of our students in good positions in the fashion and illustrating houses and in the art departments of newspapers and magazines than there are from all the big art schools of the City of Dover combined. Positions positively assured to graduates

HAMMOND SQUARE, CITY OF DOVER, NEW JERSEY

CARLTON THEATRE

NINTH AND WALNUT STREETS J. B. CARLTON, Manager

**Grand Revival of the Great English
Society Drama**

Moths

**Presented by the Eminent English
Actor and Author**

Charles Kenter

Supported by His Own Company



**Week Commencing Monday
December the Third**

Hobo Series

(Cast without descenders on Title Line)

48 Point

3 A \$4 25 5 a \$3 25 \$7 50

**MAIDEN LADIES
Handy Instructor
Eminent Bankers**

36 Point

4 A \$2 70 6 a \$2 30 \$5 00

**ADMIRABLE PRINTER
New Department Store
Slight Changes Noticed**

24 Point

6 A \$1 85 11 a \$1 75 \$3 60

**RESORT OPENED
Hobo Series Liked
Bought Type Stick**

10 Point

17 A \$1 15 35 a \$1 35 \$2 50

**FISHERMAN TURNED COURSE
Travel Many Miles Along Coast
One Lobster Found Under Sails
Bewildered Sailor Loses Anchor
Ocean Liner Saved Unfortunate
Large Storm Rocked Light Boat**

18 Point

9 A \$1 50 18 a \$1 75 \$3 25

**ADMIRER LARGE BOAT
Rare American Beauties
Magnificent Type Design**

8 Point

20 A \$1 05 39 a \$1 20 \$2 25

**FEMALE SLEUTH CLAIMED REWARD
Notorious Shoplifters Recently Caught
Young Lady Displays Unusual Courage
Floor Manager Praised Excellent Work
Advance in Salary Immediately Offered
Police Commissioner Changed System**

12 Point

15 A \$1 30 29 a \$1 45 \$2 75

**HANDSOME PRINTING MACHINE
Talented Artists Received Ovation
Performers Delight Country Editor
Business \$1234567890 Improving**

6 Point

24 A \$0 90 48 a \$1 10 \$2 00

**BEAUTIFUL CREATION PRODUCED WEDNESDAY
Purchased Many American Borders and Ornaments
Hobo Series Become Very Popular Among Printers
Modern Charming Features Preserved Throughout
Showing Contained Many Beautiful Characteristics
Very Unique and Catchy Advertising Display Letter
Unwise Speculation \$1234567890 Ruins Foreigners**

Hobo in Practical Display

REDOLENTIUM

NEW SKIN FOOD AND EXQUISITE TOILET PREPARATION FOR THE COMPLEXION

IT POSSESSES A DELIGHTFUL AND LASTING FRAGRANCE THAT
IS REDOLENT OF FLOWERS AND SUNSHINE

Beautifies Dainty Complexions

ADDS SMOOTHNESS TO THE SKIN AND STIMULATES NATURE'S
ACTION IN EVERY WAY. PREPARED FROM THE
MOST EXPENSIVE INGREDIENTS



Smyth's Redolentium Company

Manufactured by J. G. Smyth's Secret Process and Sold by the Leading Drug Stores throughout the United States
Offices and Selling Houses in every large City of the World. If not sold by your Druggist order from nearest Office

PARIS LISBON ROME LONDON TORONTO NEW YORK CHICAGO

Collins Florets

WE CHAIN THE SWEET SCENTED
ODOR OF JUNE'S BLUSHING ROSE

ALL THE FRAGRANT DELICACY OF
EARTH'S FINEST FLOWER IS NOW
CONDENSED IN MARS & BIKER'S

Soap

A Saponaceous Compound
for the Toilet, unrivalled for

QUALITY

This is a delightfully dainty
requisite for the luxurious
boudoir. A lasting perfume

Mars & Biker
MANUFACTURERS
JACKSON, MICHIGAN

INVALUABLE FOR MANY FINE
USES OF BATHS AND TOILETS

BAY RUM

A FRAGRANT LIQUID USEFUL
FOR COSMETIC OR MEDICINAL
PURPOSES. IT IS DISTILLED &
PREPARED IN THE WEST INDIES
FROM THE BAY BERRY LEAVES

O. K. CHEMICAL CO.

MAIN DISTILLERY, KEY WEST, FLORIDA

"O. K." BAY RUM is put up in
Original Packages

72 Point

3 A \$5 10 4 a \$3 50 \$8 60

RESIGNS Monday

60 Point

3 A \$4 40 5 a \$3 35 \$7 75

UNIQUE SOUVENIR
Oriental Style Guarded

48 Point

4 A \$3 15 7 a \$3 10 \$6 25

CONSIDERING REMARKS
Nobleman Predicted Disaster

36 Point

5 A \$2 10 9 a \$2 25 \$4 35

EXCUSE PRINTER
Kaleidoscopic Display

12 Point

20 A \$1 20 40 a \$1 55 \$2 75

RAILROAD PRESIDENT EXONERATED
Famous Horseman Rescues Historic Steeds
Decoration of the Golden Dragon Awarded
Courage Shown in Hazardous Undertaking
Extraordinary \$1234567890 Investment

24 Point

8 A \$1 60 16 a \$1 95 \$3 55

JUDICIOUS ADVERTISING
History of Early Development

10 Point

22 A \$1 15 48 a \$1 35 \$2 50

SHOWING TABARD SERIES IN NINE SIZES
Many Prominent Points Favor Legible Display
Commanding Distinct and Striking Personality
Novelty For Good Attractive Advertising Pays

18 Point

12 A \$1 50 25 a \$1 75 \$3 25

BEAUTIFUL EASTER CREATIONS
Promises Large Bachelor Contribution
Stylish Millinery Exhibited at Breslau

8 Point

28 A \$1 05 58 a \$1 20 \$2 25

AMERICAN TYPE FACES POPULAR WITH PRINTERS
Sold in Weight Fonts at Regular Body Type Prices and Discounts
Uniformity in Character and Design Attractively Demonstrated
Type Fashions For Every Progressive Publisher and Advertiser
Is Appreciated by Connoisseurs of Typographic Embellishment
Inventor and Maker \$1234567890 of Stylish Type Creations

Th b d e f m n o p r f u y

These special characters, in all sizes except 8 and 10 Point, are put up with fonts and included in font prices. Only e o s y Th f are supplied with 8 and 10 Point sizes

Tabard in Practical Display

PARIS, Grand Prix
ST. LOUIS, Gold Medal

MILANO, Supreme Award
CHICAGO, First Prize

BRUSSELS, Grand Prix
CALIFORNIA, Medal

Porcelain

ROYAL COPENHAGEN & DANISH ART

The recent Ceramic Exhibition of Porcelains held by this Company proved of the greatest interest to home makers, as well as to craft workers. Our stock comprises a large and comprehensive collection. Many specimens of unusual and artistic merit are on view, including some of the most beautiful designs of the Ceramic Art

The Morgan Pottery Company

TWO HUNDRED & TWENTY-SEVEN HINSDALE PLACE, CHICAGO, ILL.

72 Point

3 A \$6 20 4 a \$4 00 \$10 20

BEND RINGS
The Sanctum

60 Point

3 A \$5 05 4 a \$3 10 \$8 15

EXPECT MUCH
Rivals Combine

48 Point

3 A \$3 85 6 a \$3 65 \$7 50

ENGINE RUMBLES
Monsters Entertain

42 Point

4 A \$3 20 7 a \$3 05 \$6 25

HIGHER MONUMENT
Blamed Entertainment
Mischievous Directors

36 Point

4 A \$2.45 8A \$2.55 \$5.00

**NOBLE LECTURES GIVEN
Destroying Advertisement
Modern Rhetorical Printer**

30 Point

5 A \$2.00 10a \$2.25 \$4.25

**SIMPLE CITIZENS REGISTERED
Conventions Disturbed Landlord
Soldiers Marching South Friday**

24 Point

6 A \$1.80 11a \$1.70 \$3.50

**ORGANIZED HISTORICAL SOCIETY
Fourth Wonderful Marathon Finishes
Individualistic Declamations Inspired**

18 Point

9 A \$1.50 18a \$1.75 \$3.25

**DESIGNERS PROCURED
Modern American Series
Independent Celebration**

10 Point

18 A \$1.20 36a \$1.30 \$2.50

**INEVITABLE CONTEST RAGING
Helping Principal Manufacturers
Investigating Honorable Students
Startle Dishonest Chicken Fancier
Purchasing Boston Wire Stitchers**

14 Point

14 A \$1.50 26a \$1.50 \$3.00

**USING GOVERNMENT POLICE
Detective Captures Desperadoes
Expert Safecrackers Organizing
Always Remember Our Borders**

8 Point

20 A \$1.00 42a \$1.25 \$2.25

**LARGEST PICTURES BEING RETOUCHE
Printers Relished Combination Sandwiches
Heavyweight Wrestler Celebrating Victory
Continued Hot Weather Suffocates Stranger
Prosperous Merchants Approached Rapidly
Washington Recommended Great Specialist**

12 Point

16 A \$1.30 32a \$1.45 \$2.75

**PROMINENT COMPOSITOR COMING
Observing Desirable Features Readily
Unitype Operator Visits Mount Shasta
Arrange \$1234567890 Distinctively**

6 Point

24 A \$0.90 48a \$1.10 \$2.00

**SHOWING DIGNIFIED ADTYPE CHARACTERISTICS
Distinguished Foreigners Praised American Product
Transcontinental Railroads Beaten by Twenty Bums
Noting Wonderful Transformations in Type Foundry
Complete Printing Office Outfitter Benefited Owners
Handsome Catalogues Published Throughout Month
Burlesque Beauty \$1234567890 Malthusian Mogul**

Announcement



HAVING assumed full control of Reamer, Stern & Company we take great pleasure in announcing that this business will be combined with that of Bremford & Company and will in the future be conducted under one management as the Bremford & Reamer Company, thus giving to this city one of the largest and most up-to-date stores in the country

CFor the convenience of the many customers of both firms, the building heretofore occupied by Reamer Stern & Company will be devoted to Dry Goods and the Bremford building will be used for the sale of Household Goods of every description. We believe that this combination will be to the benefit of all concerned. The largest and most complete stocks will be kept in every facility and convenience for shopping, which has been such at the former Bremford establishment for so long. We are confident that the enterprise and foresight which have characterized the former general public has been greatly increased and will seek to uphold the reputation of the new establishment in the assurance that their wants will be met in the same manner that will leave no room for complaint. Every visit will be appreciated by the



ALL CARS TRANSFER TO OUR
BREMFORDD & CO.
THE LARGEST DEPARTMENT STORE IN BOSTON

VEST-POCKET EDITION
OF HIMES'

Directory OF Boston



BANGOR · ST. LOUIS
HIMES & JONES
Publishers

HINDIMEN TOY COMPANY



Mechanical

Toys



The name of HINDIMEN is acknowledged throughout the world of toy manufacturing as the symbol of perfection. The wide range of variety in the different types of modern toys designed and made by this company is indeed the greatest in the world. The retail dealer with practical business insight will promptly recognize and appreciate the rare profit-making qualities of our goods. There is the specially designed toy for every age of the boy or girl, ranging from infancy to the teens. The mechanical toys turned out by this company have secured first prizes in ten different exhibitions of the National Mechanical Fair. This record is unequalled

MAIN OFFICES AND GENERAL DISTRIBUTING SALES DEPARTMENT LOCATED AT

Blake Street, Richtown, Kansas

BRANCH SELLING HOUSES LOCATED IN ALL PRINCIPAL CITIES THROUGHOUT THE UNITED STATES

72 Point

3 A \$6 60 4 a \$4 55 \$11 15

MENTIONED
Earn Money
Honor Kings

60 Point

3 A \$6 00 4 a \$3 70 \$9 70

SPRING MAIDS
Modern Design
Artist Printers

48 Point

3 A \$3 85 6 a \$3 80 \$7 65

PERFECT STUDIES
Ship Drifts Rapidly
Handsome Homes

36 Point

4 A \$2.45 8 a \$2.55 \$5.00

**PROSPEROUS PRINTERS
Design Handsome Cover
Story Delighted Children**

24 Point

6 A \$1.70 11 a \$1.90 \$3.60

**STRUCTURAL BRIDGE DEMOLISHED
Usual Questions Thoroughly Solved
Purchase Beautiful Florentine Bold
Several Prominent Mountain Rivers**

18 Point

8 A \$1.50 17 a \$1.75 \$3.25

**WESTERN PRAIRIE FIRE
Printing Material Shown
Discuss Long Resolution
Reserve Hickory Forest**

8 Point

18 A \$1.00 39 a \$1.25 \$2.25

**GRAND LECTURE PLEASES DELEGATION
Marvelous Clown Amuses Many Children
Printers Requiring Convenient Materials
Completed Returns of the Late Election
Received Numerous Orders Every Night
Producing Historical Typographic Facts
Nine Soldiers Lost in Great Snow Storm
Many Startling Reports Claiming Frauds**

12 Point

14 A \$1.30 28 a \$1.45 \$2.75

**WORKMAN MAKES PIANO STRINGS
Reliable House Painters Demanded
Prominent Soldiers Ordered Home
Many Beautiful Maidens Returned
Largest \$1234567890 Purchasers**

6 Point

20 A \$0.90 43 a \$1.10 \$2.00

**PURCHASER HUNTING MODERN TYPE DESIGNS
Systematic Ideals of Production Caused Relief
Many Experiences Discussed Thoroughly Here
Beautiful Specimens by Using Florentine Bold
Reconstructing Original Questions Throughout
Completely Shattering Candidate's Aspirations
Suggesting Numerous Practical Improvements
Small Wages \$1234567890 Caused Discontent**

10 Point

16 A \$1.15 32 a \$1.35 \$2.50

**ADVERTISING SPECIAL BRANDS TODAY
Showing Many Favorable Results Herein
Handsome Designs Caused Competition
American Material Saves Valuable Time
Provides Much Character and Distinction**

5 on 6 Point

25 A \$0.90 50 a \$1.10 \$2.00

**SEVENTH ANNUAL EXHIBITION OF RELIABLE PAINTINGS
Twenty Thousand Men Killed in the Coal Mine Explosion
Remarkable Nephelomaniac Captured on the Pacific Coast
Mexican Border Patrolled by Detachment of the Cavalry
Complimentary Remarks Received With Unfolded Pleasure
Disgusted Knight Tried Many Schemes to Remain Strong
Beautiful Tourist Started for Home from Europe Today
Physical Culture Expert Advocates Strenuous Exercises
Capitalists Secure Worthless Railroad Stock Frequently**

120 Point

3 A \$9 40 3 a \$6 30 \$15 70

HEARING
Matching

96 Point

3 A \$7 75 3 a \$4 70 \$12 45

ENCAMPED
Richardson

72 Point

3 A \$6 30 4 a \$4 10 \$10 40

DISCERNMENT
Remonstrates

60 Point

3 A \$5.00 4 a \$3.30 \$8.30

HANDSOME KING
Noted Sculptures

48 Point

4 A \$3.50 6 a \$3.05 \$6.55

SPRINGTIME POETRY
Copy Elegant Designs

36 Point

4 A \$2.15 7 a \$2.10 \$4.25

ARCHITECTURAL EDUCATOR
Greatest Performer Showed

24 Point

7 A \$1.70 13 a \$1.80 \$3.50

DELIGHTFUL AMERICANIZED FOREIGNERS
Constant Friction Delays Great Production

18 Point

12 A \$1.65 20 a \$1.60 \$3.25

MAGNIFICENT PRINTING EXHIBITION GIVES PLEASURE
Remarkable Ingenuity Shown in Artistic Combinations

12 Point

18 A \$1.25 37 a \$1.50 \$2.75

MAJORITY LEADERS CONSIDER QUESTIONS
Typographical Journals Becoming Popular
Florentine Bold \$1234567890 Condensed

8 Point

24 A \$1.00 50 a \$1.25 \$2.25

FIFTY ADMINISTRATORS BECOME ENTHUSIASTIC
Beautiful Original Drawings Exhibited in Chicago
Remarkable Hunting Scene Reproduced on Canvas
Conspicuous Advertisements Printed in Magazine

10 Point

20 A \$1.15 38 a \$1.35 \$2.50

THE GRACEFUL FLORENTINE BOLD CONDENSED
Librarians Greatly Interested in Coming Author
Newly Opened Theatre Showing Dramatic Stars

6 Point

25 A \$0.90 50 a \$1.10 \$2.00

METAL FURNITURE INDISPENSABLE FOR REGISTER WORK
Incriminating Evidence Produced in Great River Mystery
Mastodon Skeletons Discovered Near Southern Mountain
Distinguished Visitors Admire Our Great Improvements
Considered Otherwise \$1234567890 Reaping Harvests

Wood Goods Quality

**ELEGANCE IN FINISH
DURABLE IN DETAIL**



The Very Finest and Best
Products of the Forest go
Into American Furniture

The intrinsic value possessed by every piece of furniture handled by the American Type Founders Company has been demonstrated wherever they have been installed. Both in space-saving and in labor-saving qualifies the American Wood Goods are unsurpassed

American Furniture Excels

Strathmore Border Holiday Decorator

Description

NEW Type Designs is the name of a book of select specimens of artistic job composition just completed by Walter Hancock in his shop which is in West Moxham. It has over forty pages containing ideas in arrangement of type and ornaments in practical display. Many of them are printed in color

**Type Des
in Color**



PRICE THIRTY CENTS EA

SENT POSTPAID ON RECEIPT OF ABOVE IN POSTAGE OR SIL

Versatile Ornaments

MEMORY CULTURE

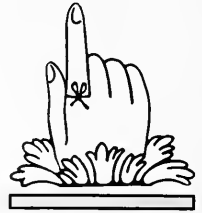

SYSTEMATIC AND
ORDERLY THINK-
ING TAUGHT BY
CORRESPONDENCE

A MAN IS AS STRONG
AS HIS MIND

Write for Booklet on
Power of Thought or
Mystery of the Mind

Dr. Arno Obstacles
Chief Instructor
Roxbury

Bullfinch Attractor



MENU

MORRIS & BALL
HOTEL



Manhattan Cocktail

OYSTERS and CLAMS

Blue Points Little Neck Clams

SOUPS

Chicken with Rice
Mock Turtle Vermicelli

RELISHES

Stuffed Mangoes
Rutshes Celery Olives

FISH

Stuffed Lobster
Sea Bass Halibut Steak

ENTREES

Saddle of Spring Lamb
Crab Plates Sweetbread

VEGETABLES

Potatoes
Green Corn French Peas

DESSERTS

Ice Cream Pies Cup Custard

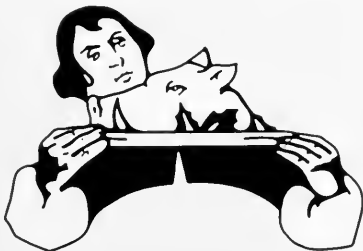

Grand Ball

Letter Carriers
Mutual Benefit
Association, Inc.



RICHFIELD HALL
Eighth and Elm Streets

Music Furnished by the
Heinrich Orchestra

SEPTEMBER SIXTH
SEVEN O'CLOCK



Tickets - \$1.00

OFFICERS

JAMES HILL President
HUGH MINER Vice President
WALTER OTIS Secretary
LEO MURKLER Treasurer

120 Point

3 A \$9 00 4 a \$5 70 \$14 70

ENDS GAME

Bolder Face

96 Point

3 A \$6 25 4 a \$4 05 \$10 30

TRAIN HOUND

Stronger Mind

72 Point

4 A \$5 40 5 a \$3 85 \$9 25

FRENZIED HUNTER

Printers Drowning

60 Point

1 A \$1 40 5 a \$1 10 \$7 50

MISINFORMED BANDIT Bohemian Player Shot

48 Point

5 A \$3 40 7 a \$2 85 \$6 25

CONVICT FOREIGN SOLDIER Reformers Dine Thousands

36 Point

5 A \$1 90 10 a \$2 35 \$4 25

YOUNGER INVENTORS CONSIDERING Desperadoes Elude Brave Policeman

24 Point

10 A \$1 80 16 a \$1 80 \$3 60

PAINTERS EXHIBITING SPLENDID VIEWS OF SPARTA Undesirable King Dethroned Without Causing Trouble

18 Point

12 A \$1 50 26 a \$1 75 \$3 25

PLUMBER CELEBRATED BIRTHDAY Enthusiastic Sports Honor Rangers Zealous Corporal Quickly Advanced

10 Point

25 A \$1 15 50 a \$1 35 \$2 50

SPENDTHRIFT APPARENTLY TIRED OF LIVING Absconder Returns Mysterious Black Packages Bright Scholar Receives Coveted Bronze Medal Chiropodist Discovers Greatest Bunion Remedy Diamonds and Heirlooms Stolen From Guardian

12 Point

22 A \$1 25 45 a \$1 50 \$2 75

MUSICAL COMEDY PERFORMER PLEASED MANAGERS Heroic Locomotive Firemen Have Miraculous Escape Suburban Lady Enjoys Beautiful Ozone at Rockaway Thousands of Surprised Onlookers Quietly Dispersed Noted Scientist \$1234567890 Gives Lectures Daily

8 Point

20 A \$1 00 55 a \$1 25 \$2 25

YOUNGER STATESMAN INVESTIGATING BANKING METHODS Gentleman Cracksman Surprises Unsuspecting Traveler Poison Victims Shrieked and Thereby Aided Detectives Somnambulist Falls From Eighteen Story Brick Mansion Farmers Enjoy Trip to New York and Promise to Return Wonderful Endurance Shown by Young Athletic Marvel Authors Criticised \$1234567890 Foremost Newspapers

72 Point

3 A \$5 05 4 a \$3 45 \$8 50

HOMER Pigeons

60 Point

3 A \$4 15 4 a \$2 85 \$7 00

Comedians FAINT

48 Point

4 A \$3 25 9 a \$4 25 \$7 50

WRITERS HYPNOTIZED
Understands Machine

36 Point

5 A \$2 30 10 a \$2 70 \$5 00

PRODUCING ORIGINAL FACES
Technical Scholar Graduating

24 Point

7 A \$1 55 14 a \$1 95 \$3 50

NOTED EARLS BRIBED
Southern Major Talks

10 Point

20 A \$1 10 40 a \$1 40 \$2 50

AMERICAN MATERIAL DEMANDED
Northern Lights Viewed From Boat
Hermit Discovers Wonderful Metals
Magnificent Structures Quickly Built

18 Point

10 A \$1 45 20 a \$1 80 \$3 25

ANCHOR CAUSING WRECK
Quaint Characters Inspired

8 Point

22 A \$1 05 44 a \$1 25 \$2 30

OBSERVANT CITIZENS REVIEWED BIG PARADE
Silent Partners Objected Strenuously to Game
Wealthy Stockholders Bequeath Largest Sums
Young Inventor Submits Diagram of Invention

12 Point

17 A \$1 20 35 a \$1 55 \$2 75

HUNTERS ENJOYED EXCITING HORSE RACE
Ranch Owner Inspects Wildest Bronchos
Wound Dangerous \$1234567890 Animals

6 Point

26 A \$0 95 52 a \$1 05 \$2 00

VISITOR ENJOYED SPLENDID CALIFORNIA CLIMATE
Desperate Character Demands Fabulous Sums of Money
Four Neat Poster Schemes Pleased Theatrical Manager
Brainy Lawyer Outwits Prominent Judge at Famous Trial
Influential Citizens Hold \$1234567890 Picnic at Oak Grove

BOOKLET ON RESORTS

ISSUED IN THE INTERESTS OF TOURISTS
AND PLEASURE SEEKERS OF EVERY LAND



Compliments of
GEORGE HADKIN
NEW YORK CITY

Art Ornament

What I Know About Gold Fish

By
I. KNOWITALL

PUBLISHED BY
THE GOLDFISH COMPANY
BOSTON : CHICAGO



Strathmore Ornament Panel Border

ENTERTAIN no thought of failure, no
foreboding of defeat, no distrust
in your powers of accomplishment,
no matter how frequently nor forcibly
they obtrude themselves — DOROTHY QUIGLEY

Matthews Series

72 Point

3 A \$8 30 4 a \$5 60 \$18 90

ONE Night

60 Point

3 A \$7 40 4 a \$5 10 \$12 50

Chefs RIDE

48 Point

3 A \$4 60 4 a \$3 10 \$7 70

HURT Serpent

36 Point

3 A \$2 50 6 a \$2 50 \$5 00

Publication BOUGHT

30 Point

5 A \$2 20 7 a \$2 05 \$4 25

FIND HERMIT Returns Child

12 Point

16 A \$1 40 24 a \$1 35 \$2 75

HUNGRY PRINCE DINES Printer Reforms Painter Astronomers Performed This \$1234567890 Won

24 Point

5 A \$1 55 10 a \$1 95 \$3 50

MODEL TINKERS Explosive Stolen

10 Point

16 A \$1 25 26 a \$1 25 \$2 50

LONG ISLAND STEAMSHIP Revealed Old Hiding Places Doctor Encouraged Student Foremost Sea Captain Here

18 Point

8 A \$1 50 15 a \$1 75 \$3 25

AUTHORS NOTIFIED Old Brother Printers

8 Point

22 A \$1 20 30 a \$1 05 \$2 25

JAPANESE SOLDIERS SEEK RELICS Many Notables Reviewed Fireworks English Inventors Studying German Polo Players Attended Picnic Today

14 Point

12 A \$1 50 18 a \$1 50 \$3 00

AERONAUTS UNDAUNTED Daring Performer Injured Talking About Wanderlust

6 Point

20 A \$0 95 36 a \$1 05 \$2 00

CHICAGO SLEUTH CAPTURES ABSCONDER Former Philadelphian Arraigned Saturday Was Director of the Soakem Savings Bank Prisoner Charged with Aiding and Abetting Weakens Under Fire of Old Insanity Expert Says He Stole \$1234567890 to Buy Candy

Matthews in Practical Display

AUTO EXHIBITION

Auto Chat

ABOUT WHAT IS WHAT AND WHY

THE POLICY OF THE WILDER CAR COMPANY IS HONESTY IN CONSTRUCTION AND TO MAKE THE BEST CAR THAT CAN BE PUT ON THE MARKET CONSISTENT WITH FAIR PROFIT

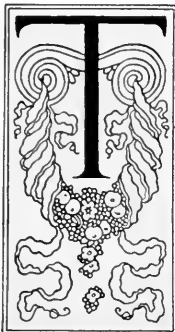

THE WILDER has made an enviable reputation for itself in the racing world. Invariably has it outdistanced all cars of equal price; has made better time and come through in better condition. Whenever it has been defeated in a speed contest it has been by cars costing hundreds of dollars more. In every contest held the Wilder has shown itself possessed of extraordinary motive power, great speed and endurance, cost considered. It has the high quality of construction, simplicity and strength of design that wins. In hill climbs its record has been just as brilliant; it has never been defeated; it stands triumphant.

Victory in speed contests means more than mere winning a prize; it proves endurance; it proves quality. The Wilder wins because it is right in design and right in construction. Its motor is extra powerful; every detail of the construction is in harmony with its motor. The brakes, the wheels, the frame, the axles, the bearings, are all built with a surplus efficiency. Lubricating system is correspondingly efficient

SANE REASONS FOR OUR BIG SUCCESS

THE WILDER PLANT IS NOVEL AND STRICTLY UP-TO-DATE. IT HAS EVERY ADVANTAGE BEGOTTEN FROM PROPER PLANNING, LIGHTING VENTILATION, LOCATION. "QUALITY PLUS VALUE" IS OUR MOTTO

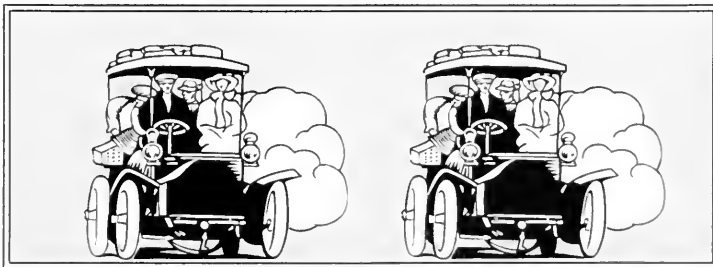

The Wilder Automobile Co.

Incorporated a Stock Company under the State of Pennsylvania Laws
Main Office and Factory, New Amsterdam, Pa.

A CAR OF QUALITY

72 Point

3 A \$6 15 4 a \$3 95 \$10 10

PRINT Cleanly

60 Point

3 A \$5 40 4 a \$3 45 \$8 85

Building DOCKS

48 Point

4 A \$3 65 5 a \$2 60 \$6 25

DESIGNS Lighthouse

36 Point

4 A \$2 05 8 a \$2 20 \$4 25

Modern Features PRODUCED

30 Point

6 A \$2 05 10 a \$1 95 \$4 00

SHOWED DIGNITY Provide Fine Races

12 Point

20 A \$1 35 34 a \$1 40 \$2 75

TRYING CONDENSED MATTHEWS Great Acrobat Performed on Beach Prominent Mechanic Badly Injured Advertise \$1234567890 Borders

24 Point

8 A \$1 85 12 a \$1 65 \$3 50

REFINING CHARACTER Bought Exquisite Types

10 Point

22 A \$1 25 38 a \$1 25 \$2 50

RESTRICT PROSPEROUS MERCHANTS Stenographer Given Bright Red Necktie Popular American Faces Widely Known Philanthropist Questions Faking Doctor

18 Point

12 A \$1 60 21 a \$1 65 \$3 25

MARVELOUS POINT SYSTEM Climbed High Mountain Peaks

8 Point

28 A \$1 15 45 a \$1 10 \$2 25

TREACHEROUS INDIAN CAPTURED IN CALCUTTA Northern Wheat Harvest Greatly Exceeded Previous Production Disastrous Tornadoes Overturned Large Haystack Monday Night Charming Entertainer Became Sick During Swell Social Function Nervy Burglar Overturns Large Safe During Scuffle Greater Magician Produced Marvelous Performance

14 Point

16 A \$1 50 28 a \$1 50 \$3 00

HIRED INDUSTRIOUS COMPOSITOR Charming Specimens Received Prizes Discovered Ancient History Thursday

6 Point

30 A \$1 00 52 a \$1 00 \$2 00

FASTEST PASSENGER TRAIN DITCHED ROUNDING MOUNTAIN Northern Wheat Harvest Greatly Exceeded Previous Production Disastrous Tornadoes Overturned Large Haystack Monday Night Charming Entertainer Became Sick During Swell Social Function Government Inspectors Thrown Overboard by Cruel Smugglers Fine Diamond Brought \$1234567890 from Southern America

Westmont vs. Moxham

THE CENTRAL PENNSYLVANIA AND MARYLAND INTER-STATE LEAGUE



The Old Highlanders of Westmont will pit their skill and strength against the Moxham Indians of Moxham on the Luna Park Base Ball Grounds next Saturday afternoon at three o'clock. Wolf Jordon the celebrated Indian pitcher has signed up for the season with the Moxham Boys and will pitch his first game. Young Jordon is said to be quite a twirler. All local fans are expected to be there and hurrah for their many favorites

day at Luna Park

Indian Border Baseball Series No. 2

KING MUSIC CATALOGUE



List of All New Sheet Music and Song Hits Added to Our Shelves Since January Tenth

KING MUSIC HOUSE

ROSEMONT BOULEVARD



UNCLE SAM OUR AGENT

GIVE HIM YOUR ORDER AND IT WILL REACH US

MOORE & ASHLEY
OFFICES, SENEGA, PENNA.

72 Point

3 A \$7 00 4 a \$1 50 \$11 50

BURN Huts

60 Point

3 A \$5 60 4 a \$3 65 \$9 25

TRIUMPHED
Duped Bandit

54 Point

3 A \$5 30 5 a \$4 05 \$9 35

FRIEND GONE
Great Diamond

48 Point

4 A \$4 60 5 a \$3 15 \$7 75

KNIGHTS FORM
Quickest Burglar

42 Point

4 A \$3 45 6 a \$3 00 \$6 45

PLUMBERS FIGHT
Huckster Condemns

36 Point

1A \$2.65 7a \$2.60 \$5.25

UNIFORMED DOCTOR Strangers Remonstrate

30 Point

5A \$2.05 9a \$2.20 \$4.25

GERMAN DAMSEL ELOPES Enemy Confirmed Statement Banished Dangerous Cowboy

24 Point

6A \$1.65 11a \$1.85 \$3.50

QUESTIONED SEVERAL BRITONS Ancient University Honoring Doctor Incapacitated Composer Pensioned

18 Point

9A \$1.50 18a \$1.75 \$3.25

DISCLOSED NEW FACT Improved Gothic Designs Tenor Singer Leaves City

8 Point

21A \$1.00 43a \$1.25 \$2.25

DESTROY PRINTING ESTABLISHMENT Mineral Water for Indigestion and Malaria Beautiful Island Situated in Eastern River Handsome Characters Shown in Catalog Superb Display Pleased Fastidious Tailors Persistent Methods Bringing Much Profit

14 Point

13A \$1.40 25a \$1.60 \$3.00

CHILDREN AMUSING ZEBRA New York Delegation Received Previous Chapter of Late Novel

7 Point

22A \$1.05 45a \$1.20 \$2.25

CIRCUS FREAKS HOLD THEIR ANNUAL BALL Generous Physician Befriends Young Designer Banker Desiring Loan of Eight Hundred Pounds Magnificent Steamer Was Only Partly Insured Handicap Race Attended by Many Young Folks Unique Designs Pleasing Famous Old Architect

12 Point

15A \$1.30 30a \$1.45 \$2.75

BANKERS ELECTING PRESIDENT Hunters Capture a Thousand Beasts American Type \$1234567890 Designs

6 Point

22A \$0.95 44a \$1.05 \$2.00

AGED FINANCIER GIVES FORTUNE TO PIRATES Gothamites Returned From Joyous Trip to England Notable Gatherings Demanding Impartial Treatment Landscape Painter Exhibits Most Beautiful Picture Thrilling Stories Read by Two University Students Profits Aggregating \$1234567890 Somewhere Near

10 Point

19A \$1.15 39a \$1.35 \$2.50

WONDERFUL DISCOVERY MADE BY KINGS Serious Problems Come Before Legislative Body Busy Printer Realizes Value of Good Composer Russian Mountain Climber Has Narrow Escape

5 1/2 Point

19A \$0.95 39a \$1.05 \$2.00

DARING PARACHUTE JUMPER CALMS THROUGH Two Excursionists Praise Brave Steamboat Captain Conservative Newspaper Made Startling Declaration Foremost Lawyer Reviewed Testimony of Secretary Remarkable Demonstrations by Professional Artists Informal Reception Attracts Twenty Famous People

DESIGN AND TYPE STYLES

New and Original Ideas
In Type Design will give
Printed Matter Distinct
Character, Securing the
Much Desired Emphasis

NEVER before in the history of the craft have the printers of the world had such a complete and attractive array of beautiful Type Faces and Advertising Accessories to use in producing good printing. In both fashion and finish the American Type Faces are recognized leaders. Style in type design has become a great factor in modern display and in advertising publicity. It has been the work of the American Type Founders Company to meet this demand for pleasing novelty and originality in types. How well we have succeeded may be determined by turning to the many new and forceful type faces displayed in this book. The progressive printers will buy liberally



The Finest Mail Order House in America

Rice & Burk

17-25 Stiles Road
AUSTIN, MO.

Style Book

IT IS absolutely necessary for the man who desires to dress well to secure a copy of our latest Style Book which is now ready for free distribution. This book contains all the best and most stylish ideas in modern tailoring and should be well studied by the man who considers personality as one of his most valuable assets

Bullfinch Attractor



EXTRACT OF

Violets

A Rare and Delicate Perfume
With a Sweet, Lasting
Fragrance



J. H. Mason & Co.

CHEMISTS
KALAMAZOO, OHIO



Beacon Combination Ornaments Versatile Ornament

Are You Protected

The subject of insurance is one that most people think they are thoroughly familiar with, but we venture to state that only the thousands of widows and orphans who have been helped by a policy realize the actual benefit which is derived from insurance. A ten year endowment policy will protect your wife and family and beside lay up a nice little sum to fall back upon when old age, with all its vicissitudes, shall come to you

Atlas Insurance Co.
Homes Building CAMDEN, MICH.



Shall we send our Agent to talk it over?

Horns Diagonal Corners Mission Toy

72 Point

3 A \$5 30 4 a \$3 65 \$8 95

USED BRICKS Hunter Sought

60 Point

3 A \$4 25 5 a \$3 40 \$7 65

POST RECORDS Demands Report

54 Point

3 A \$4 20 5 a \$3 35 \$7 55

HORSE SECURED Inspiration Lacked

48 Point

3 A \$3 15 6 a \$3 10 \$6 25

MODEL INSURGENT Questioned Reproach

42 Point

1 A \$2 70 7 a \$2 70 \$5 46

NIGHT EDITORS HIRED Slighted Ladies Retaliate

36 Point

4 A \$2 05 8 a \$2 20 \$4 25

MECHANIC JUMPED TRAIN Rubeville Constable Retained

30 Point

6 A \$1 95 11 a \$2 10 \$4 05

HANDSOME DESIGNS PRODUCED Serious Question Readily Explained

24 Point

8 A \$1 70 14 a \$1 80 \$3 50

EMINENT POLITICAL SPEAKER SECURED Regular Meetings Postponed During Election

18 Point

12 A \$1 50 23 a \$1 75 \$3 25

EXPOSED POLITICAL DEALS Senate Rush Matters Through Frequent Extra Sessions Held

10 Point

25 A \$1 15 50 a \$1 35 \$2 50

NUMEROUS COUNTY BUILDINGS ERECTED Serious Trouble Anticipated Throughout City Philadelphia Investors Secured Large Amount Dissatisfaction Reported Among Local Firms Buildings Constructed Under Strict Economy

14 Point

16 A \$1 50 30 a \$1 60 \$3 10

HANDSOME AMERICAN BEAUTIES Receiving Greatest Attention Abroad Printers Demand Improved Materials

8 Point

26 A \$1 05 52 a \$1 20 \$2 25

RECORD POSITIVELY SHOWS NEGLECTED DUTY Town Constables Captured Desperate Highwayman Country People Greatly Alarmed at Recent Robbery Many Barns Burned During the Absence of Farmers Sheriff With Deputies Arrived at Jayville Wednesday

12 Point

21 A \$1 25 40 a \$1 50 \$2 75

STRANGE PEOPLE CAPTURED MISSIONARY Refused Generous Offer From Wealthy Printer Broad Minded \$1234567890 Editors Discussed

6 Point

28 A \$0 90 58 a \$1 10 \$2 00

MARVELOUS PAINTINGS EXHIBITED IN GERMAN GALLERIES American Critics Pronounce Collection Grandest Ever Witnessed Oil Paintings by Popular Old Masters Brought Enormous Prices Boston Man Purchased Numerous Pictures While Visiting Abroad Large Incomes Spent Yearly \$1234567890 for Imitation Products

72 Point

3 A \$4 10 5 a \$3 40 \$7 50

SHOWING Qualities

60 Point

4 A \$3 55 6 a \$3 50 \$7 05

Handsome DESIGNERS

54 Point

4 A \$3 30 9 a \$4 20 \$7 50

FISHERMEN Seined River

48 Point

5 A \$2 90 9 a \$3 35 \$6 25

Visits Southern CALIFORNIA

42 Point

5 A \$2 40 10 a \$2 95 \$5 35

CONFECTIONER Bought Fountain

36 Point

6 A \$2 05 10 a \$2 20 \$4 25

Studies One METHOD

18 Point

16 A \$1 45 31 a \$1 80 \$3 25

POPULAR CONDENSED SERIES Every Branch of Printing Done

30 Point

9 A \$1 80 16 a \$2 20 \$4 00

WRECKING EXCURSIONS Demanding Useful Method

14 Point

22 A \$1 40 40 a \$1 60 \$3 00

USING SEVERAL ELECTRIC MOTORS Greatest Stadium Being Planned Here Savage Beast Makes Policeman Drop

24 Point

11 A \$1 65 20 a \$1 85 \$3 50

MAKING BEAUTIFUL SOUVENIR Secure Finest Advertising Letter

12 Point

25 A \$1 20 50 a \$1 55 \$2 75

EXPORTED HORSES RECEIVING FINER CARE Stylish Printers Always Pleasing Customers Observed These \$1234567890 Distinct Figures

DIRECT FROM THE ORIENT

Rare Curios

WE BEG to announce to our many friends and the public in general that we have just received a fine collection of rare curios and choice antiques which we will place on exhibition in our showrooms next week. This is one of the best assortments that has ever been shown in the city, and we can assure those who wish to attend that nothing will be left undone to make their visit a profitable as well as an instructive one

Fine
Antiques



Ridgley & Company

Sixth Street and Eighth Avenue

Times Border Twentieth Century Ornament

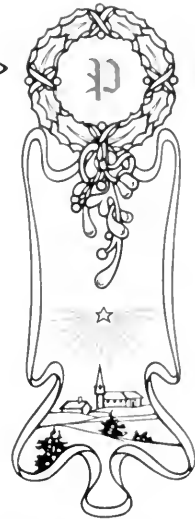

HYMNS AND SACRED CAROLS



PRINGLE & SONS
MERTON CITY, MO.

Monotone Border Holiday Decorator Maltese Cross

THE CRITERION DRAWING ROOMS

Thursday Afternoon and Evening, December 19th

(UNDER THE DIRECTION OF THE
CRITERION DRAMATIC SOCIETY)

Mr. John Campbell

Will Present the Charming
Elizabethan Comedy

The Love Philter



Assisted by His Own Players

The entire proceeds of the afternoon performance will be donated for the maintenance and education of young men and women deserving of support

Brockton Border Versatile Ornament Chap-Book Girdle

Lining De Vinne Italic No. 2

72 Point

3 A \$8 10 4 a \$4 90 \$13 00

DRINKING
Hide Canoe

60 Point

3 A \$6 25 4 a \$4 00 \$10 25

DOGS HUNT
Mineral Used

54 Point

3 A \$5 90 4 a \$4 05 \$9 95

SEIZE MINES
Rejecting King

48 Point

3 A \$3 90 6 a \$3 85 \$7 75

BRIGHT DIMES
Rivers Measured

Lining De Vinne Italic No. 2

42 Point

1 A \$1 35 6 a \$3 20 \$6 55

SIGNED PRINTER
Musical Receptions

36 Point

1 A \$2 60 7 a \$2 50 \$5 10

ARTISTIC METHODS
Showing Distinct Italic

30 Point

5 A \$2 25 8 a \$2 00 \$4 25

FIRES DESTROY LUMBER
Produces Exquisite Features

24 Point

6 A \$1 80 10 a \$1 70 \$3 50

STATE CAPITAL BURNS TODAY
Captured Convict Near South Beach

18 Point

9 A \$1 45 18 a \$1 80 \$3 25

NUMEROUS PURSUITS
*Display Handsome Plant
Building Modern Houses*

10 Point

20 A \$1 20 39 a \$1 30 \$2 50

EXTEND PATROLLING DISTRICTS
*Insures Great Amusement Enterprise
This Remarkable Type for Magazines
American Materials are Saving Labor
Most Popular of all Latest Inventions*

14 Point

12 A \$1 50 21 a \$1 55 \$3 05

CLERKS FIGURED PROFITS
*Unique and Bright Characters
Concerns Considered Reliable*

8 Point

18 A \$1 10 36 a \$1 15 \$2 25

RAILROAD ROUTE TO PACIFIC OCEAN
*California Resorts Being Much Patronized
Western Exposition Receive Great Praise
Experiments are Being Thoroughly Tested
Invented Some Practical Horse Shoe Nails*

12 Point

14 A \$1 25 28 a \$1 50 \$2 75

ENLIGHTEN HONEST CUSTOMER
*Stereopticon Views of Boston Harbor
Typographic \$1234567890 Specimens*

6 Point

28 A \$0 95 46 a \$1 05 \$2 00

REPORTED DAMAGING EARTHQUAKE TUESDAY
*Finest Machinery Used in the American Workshops
Successful Printers Realize the Worth of this Italic
First Horse Show Produced Many Unique Wonders
Gathering Old Coin \$1234567890 Interest Foreigners*

Lining De Vinne Extended No. 2

72 Point

3 A \$10 95 4 a \$6 45 \$17 40

MIXERS
Hundred

60 Point

3 A \$8 55 4 a \$5 45 \$14 00

FIRMEST
Big Home

48 Point

3 A \$5 70 4 a \$3 65 \$9 35

RESOURCE
Made Roads

42 Point

3 A \$4 05 4 a \$2 75 \$6 80

EIGHT MINES
Delighted Men

36 Point

3 A \$3 15 4 a \$2 05 \$5 20

**GRIPS BROKEN
Handsome Rings
Brightly Polished**

30 Point

4 A \$2 45 6 a \$2 10 \$1 55

**REQUIRES UMPIRE
Designs Ornamental
Mechanics Recruited**

24 Point

5 A \$1 95 8 a \$1 70 \$3 65

**EXPECTED REDUCTION
Positively Standard Grade
Experienced Public Printer**

18 Point

7 A \$1 60 12 a \$1 65 \$3 25

**CLEAN IMPRINT
Emphasis Sought
Splendid Qualities**

10 Point

13 A \$1 15 26 a \$1 35 \$2 50

**BOLDNESS REQUIRED
Readability Unsurpassed
Demand Extended Faces
Legible Letter for Display
Clearly Most Serviceable**

14 Point

9 A \$1 45 16 a \$1 60 \$3 05

**UNLIMITED RANGE
Beauties Undisputed
Masterfully Designed**

8 Point

13 A \$1 00 26 a \$1 25 \$2 25

**PRINT ADVERTISEMENTS
Adaptable to Various Work
Impressing Clean Imprints
Readable Sharpness Given
Surprisingly Good Qualities**

12 Point

10 A \$1 25 20 a \$1 50 \$2 75

**BEST ENDORSEMENTS
Unreachable Attractions
Designedly Conservative
Much \$1234567890 Used**

6 Point

16 A \$0 90 31 a \$1 10 \$2 00

**PURCHASED EXTENDED FONTS
Things Peculiar to Extended Type
Display Series Effectively Strong
American Line Type Give Results
Forceful Shapes and Proportions
Figure \$1234567890 Handsomest**

Lining De Vinne Open No. 2

72 Point

3 A \$7 00 4 a \$4 50 \$11 50

MIND Bank

60 Point

3 A \$5 60 4 a \$3 65 \$9 25

Strange MEN

54 Point

3 A \$5 30 5 a \$4 05 \$9 35

DUTCH Father

48 Point

4 A \$4 60 5 a \$3 15 \$7 75

Questioned KING

42 Point

4 A \$3 45 6 a \$3 00 \$6 45

PUBLISH Magazine

36 Point

4 A \$2 65 7 a \$2 60 \$5 25

Eight HENS

18 Point

9 A \$1 50 18 a \$1 75 \$3 25

AMERICAN IDEAS
Inspector Promoted

30 Point

5 A \$2 05 9 a \$2 20 \$4 25

HURT KNIGHT
Factory Opened

14 Point

13 A \$1 40 25 a \$1 60 \$3 00

BUNDLES RETURNED
Improved Many Designs
Latest Fashion Ridiculed
Triumphant Roumanian

24 Point

6 A \$1 65 11 a \$1 85 \$3 50

REMODEL SHOPS
Chairs Upholstered

12 Point

15 A \$1 25 30 a \$1 50 \$2 75

HANDSOME ROMAN FACE
Two Inventors Demonstrate
Prodigal Son Returns Home
Flawless \$1234567890 Metal

Lining De Vinne Italic Outline No. 2

72 Point

1A \$5.00 1a \$1.00 \$3.00

KIND *Mare*

60 Point

3A \$6.25 1a \$1.00 \$10.25

Brands *PIGS*

54 Point

3A \$5.00 1a \$1.00 \$9.00

HUNT *Caribou*

48 Point

3A \$3.00 6a \$3.85 \$7.75

Grangers *TIMED*

42 Point

1A \$3.35 6a \$3.20 \$6.55

FOUND *Geography*

36 Point

4A \$2.60 7a \$2.50 \$5.10

Sends *COIN*

18 Point

9A \$1.45 1a \$1.80 \$3.25

OUTLINED IDEAS
Removes Structure

30 Point

5A \$2.25 8a \$2.00 \$4.25

TIMID *HYENA*
Jackals Escape

14 Point

12A \$1.50 20a \$1.55 \$3.05

MODEL CITY VISITED
Foreigner Hunts Friend
Retire Brainy Foreman
Norwegian Barkantine

24 Point

6A \$1.80 10a \$1.70 \$3.50

EXTRA *MACHINE*
Questioned Banker

12 Point

11A \$1.25 28a \$1.50 \$2.75

BOUGHT EIGHTY POUNDS
South American Lion Caught
Youngster Improved Method
Typical \$1234567890 German

12 Point

16 A \$1 35 32 a \$1 40 \$2 75
9 A \$0 50

10 Point

18 A \$1 20 36 a \$1 30 \$2 50
12 A \$0 50

THE TIMES WHEN ADVERTISERS INSISTED UPON A HEAVY BLACKFACE OR Gothic in displaying advertisements are past. The educational forces that are at work in printing have wrought so well that there is widespread appreciation in evidence of the beauty and value of the refined and \$1234567890 neat light faces

FOUR YARDS OF CLOTH THAT ARE NOT UP TO THE STANDARD MAY be forgiven the merchant if all the rest are good. The letter-head that is not properly set offends tomorrow the same as it did today; it is bound to irritate the artistic eye as long as the supply lasts or until it gets upon the nerves of the man it represents so much that he discards it forever

BIOGRAPHIES OF ELEVEN PROMINENT JURISTS



AFTER all our doubts and our suspicions and speculations on the subject of government we must return to an important truth, that when we have formed a constitution upon sound and free principles, when we have given a proper balance to the many lines of administration, fixed the representation upon pure and equal principles, we may with safety furnish it with all the powers necessary to answer in the most ample manner the purposes of government. The great desiderata are a free representation and mutual checks. When these are obtained all our apprehensions of the extent of powers are unjust and imaginary. One branch of the legislature is to be elected by the people, by the same people who choose state representatives. Its members are to hold their office two years and then return to their constituents. Here they act by their representatives. You are constituted by your state legislatures, but place the highest confidence, and form a branch. Then again you have an executive by the form of an election which merits of this government and in the mode of i

MAY RUTH BLANCHARD
MANICURIST

718 RING STREET SPRINGFIELD, CONN.

Della Robbia Initial

8 Point

19 A \$1 10 38 a \$1 15 \$2 25
16 A \$0 50

6 Point

24 A \$0 95 48 a \$1 05 \$2 00
18 A \$0 50

IT WAS A FALLACY IN YEARS GONE BY AND THE MISTAKEN IDEA IS STILL PREVALENT THAT ANY man can learn his trade in three or four years. At the end of that time he is supposed to be a compositor able to earn the full scale of wages. That should not be the end of his ambitions. He should keep abreast of the times, keep on studying, become efficient. The first effect noticeable will be that he will be retained while others are laid off at dull times; next perhaps a substantial increase in salary. Following this may be advancement to assistant foreman, or foreman, or a superintendency, or maybe a better paying position

INDIVIDUALITY IS CHARACTERISTIC OF LIFE NO BUSINESS AMOUNTS TO VERY MUCH WHICH DOES not show some distinguishing trait that divides it from all others of its kind. There may be similarity in both stock and methods; there is also a difference, else it is a dead enterprise. Perhaps no other business acquires its special brand of character as quickly as the printing business. Printers come in contact with the most alert business men in all walks of life, men who are used to sizing up others with keen discretion. Then, the printer's work is constructive; it reflects his character or else it is not his work. The product of the presses is also compelled to run the gauntlet of very careful scrutiny, because it permanently affects the standing of each patron. A reputation once established is not so easily gotten rid of. To change the known and ancient policy makes enemies \$1234567890 of many customers

DeVinnie Roman Slope

12 Point

15 A \$1.25 31 a \$1.50 \$2.75

*PRESENT ELEGANT SLOPE FACE
Considers This Beautiful Type Perfect
Horticultural Show Starts at Baltimore
Grand Entertainments Pleased Critics
Famous Aeroplane King Soars Higher
Discharges Old Government Employe
Greatest Defenses Erected at Gibraltar
Designing Marvelous Buildings Lately
Handsome \$1234567890 Distinct Faces*

10 Point

15 A \$1.25 31 a \$1.25 \$2.50

*FINED NATIONAL SALESMEN
Grant Holiday Saturday Afternoon
Gorgeous Fourth of July Paraders
Muskets Crack and Cannons Roar
Hospital Ambulance Keeps Going
Giant Dynamite Cracker Exploded
Sky Illuminated by Roman Candle
American Type Leading the World
Twilight Observations Made Here
Printer Purchased DeVinnie Slope
Handsome Burlesque Performers*

THE CORRECT USE OF HARMONIOUS COLORS



COLOR in design carries with it the responsibility of using not only the right color but the proper amount. As many neat designs are spoiled by prodigality of warm tints as are made offensive by inharmonious combinations. This being so, it is a pleasure to call attention to the refined color treatment that is displayed in a catalog printed for the Stearns Company by Samuel Brown of Blakeland, Ohio. This is a handsome book, the cover and inside of which were printed in two colors from type furnished by American Type Founders Company. The initial offers a new suggestion that is adaptable in many ways, consisting as it does of a half-tone with a colored initial set in. The headpiece is notable for the restraint exercised in the use of color. The dainty tint effect gives a warmth to the entire catalog

CHARLES HEISER

Proofreader

South Third Street

COSHOCTON, IOWA

the color on the attention. Five initials, but merely with sufficient prominence lack letters of the design. More fine jobs manufacturer insisting on the use of this artistic form and often repelling in all we would drop a word to manufacturers ther adorn or delace most of the printed

Della Robbia Initial

8 Point

18 A \$1.05 37 a \$1.20 \$2.25

*AWKWARD SOLDIERS PRACTICED MARCHING
Sailor Ties Two Hawsers Securely with Square Knot
Faking Magicians Advertised Great Disappearing Act
Feed Hungry Harvest Workers on Indian Corn Meal
Rushing Printer Crossed Street with Foaming Bucket
Best Authorities on Agriculture Claiming Discovery
Magazine Publishers Kick Strenuously at Ceremony
Acknowledged Finest Artist in Daily Morning Paper
Bowling Tournament Becomes Exciting at Cleveland
Imports Famous Italian Statuary and Ceramic Ware
Centertown Noted Widely for Beautiful Pine Forests
Brilliant Social Discourse Pleases Lonesome Visitor*

6 Point

21 A \$0.95 42 a \$1.05 \$2.00

*POLITICIAN HUMILIATED SUFRAGETTES
Countrymen Interested While Passing Old Houses
Counsels Interview Defendant Regarding Damage
Persistent Methods Brought Enormous Patronage
Ordered American Type Founders Company Faces
Running His Entire Establishments Day and Night
The Latest and Most Popular Ornaments and Border
Advertisers and Job Printers Both Obtain Results
Most Aristocratic Dukes Sought Fortunes in Paris
Members of Congress Went Fishing at Cape Henry
Precisely Review Important Historical Happening
Largest Phonographs Making Instrumental Music
Professional Athletes Astonishing Circus Owners
Dame Nature Stubbornly Giving Way to Progress
Beautiful Figures \$1234567890 Always Print Lovely*

Bold Antique

72 Point

3 A \$8 25 4 a \$5 60 \$13 85

FRIENDS
Monarchy

60 Point

3 A \$6 25 4 a \$3 90 \$10 15

HISTORIES
Kind Mother

48 Point

3 A \$4 30 5 a \$3 20 \$7 50

ENRICHMENT
Boldest Soldiers

42 Point

4 A \$3 80 5 a \$2 60 \$6 40

FIRST CONCERT
Sanctioned Games
Unsound Treasure

Bold Antique

36 Point

4 A \$2.80 6a \$2.40 \$5.20

DISTURBS HERMIT Elephants Frightened Magnificent Chamber

30 Point

4 A \$2.05 8a \$2.20 \$4.25

INVENTORS UNKNOWN Remodel Suburban House Quarantine Many Doctors

24 Point

5 A \$1.65 11a \$1.90 \$3.55

NOVELIST PRACTISED IDEA Knights Banished From Europe Inducements Offered Promoters

18 Point

8 A \$1.60 15a \$1.70 \$3.30

GRECIAN COUNSEL Rhode Island Scenery Hilarious Composer

10 Point

14 A \$1.20 26a \$1.30 \$2.50

BEGUILE CRAFTY THIEF Noble Americans Examined Candidates Expect Presents Army Lieutenant Suspected Stealthy Tiger Bites Hunter

14 Point

11 A \$1.40 23a \$1.60 \$3.00

POLICE CAPTURE FOUR Historians Desire Building Spanish Fencer Challenges

8 Point

17 A \$1.05 35a \$1.20 \$2.25

GENUINE RUBY QUIETLY TAKEN Desert Victims Unknown in Montana Romantic Adventuress Seeks Friends Kansas Cyclone Demolishes Building Beautiful and Eccentric Lady Invited

12 Point

13 A \$1.30 26a \$1.45 \$2.75

VIRGINIA JUDGE DEFENDED Phrenologist Startled Audiences Generous Woman Loses Fortune Speculator Given \$1234567890

6 Point

17 A \$0.95 35a \$1.10 \$2.05

GENTLEMAN BURGLAR STOLE PEARL Arkansas Justice Reprimanded Detective Unorganized Troops Retreat Very Hastily Temporary Structure Quickly Abandoned Modest Athlete Coaching University Crew American Greyhound Won Large Amount Yielding Wonderful Profits \$1234567890

Will You be There

Next
July
4th?

WILL
YOU
?

ROSEFIELD'S ROUGH RIDERS will have a Grand Bucking Bronco Riding Contest and General Independence Celebration. Free Busses will leave from Hotel Hobart every five minutes beginning at 12 o'clock noon for

Lone Butte Camp Tuesday, July the 4th

Everybody is invited. There will be other sports such as Coyote Chase, Shooting Contest, Lariat Throwing Exhibition, Races for the Women and Children and, last and best, the Great Western Free for All Roast Beef Barbecue followed immediately by a Wonderful Display of Fireworks

Rough Riders League
Salt Creek Junction, So. Dakota



Chap-Book Cut Chap-Book Guidons Inland Border No 2470

Something doing soon

WISE UP ON IT IN TIME

A jolly good time is being prepared for every man, woman and child in Way Station and the surrounding country. This event is intended to bring together old acquaintances and to make new ones and for all to join in and make next

July 4th

doubly memorable. A committee has secured some of the most amusing attractions of Bill's Big Buffalo Show. Races, games and contests. Many other interesting and attractive features.

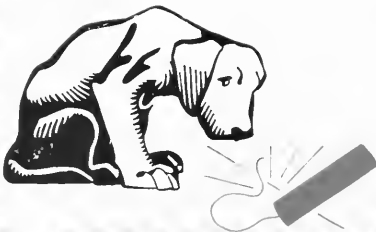

Chap-Book Cut Swastika Borders

Bold Antique in Practical Display

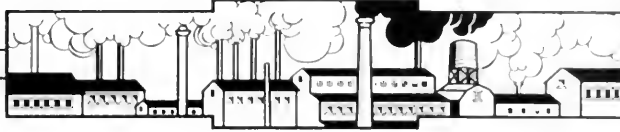

SCIENTIFIC MANAGEMENT

THE greatest economic problems of the present day can be solved by scientific management. In every factory and shop where the output is more or less dependent on human activity and influence, the real value of management can be at once appreciated. This subject has been fully covered in Ransom Sprockett McBride's great masterpiece of business literature, "The Factories." Every phase of this subject has been fully developed by an expert factory man and business promoter. In addition to work-room economics the volume contains several very interesting and valuable chapters on commercial law and legal information concerning the labor

A New Name for the New House

Our Patrons are requested to take note of the slight change in the firm name as printed below. The senior partner having retired, the firm will hereafter be called

THE BEN JOHNSON PUBLISHING HOUSE

Industrial Ornament

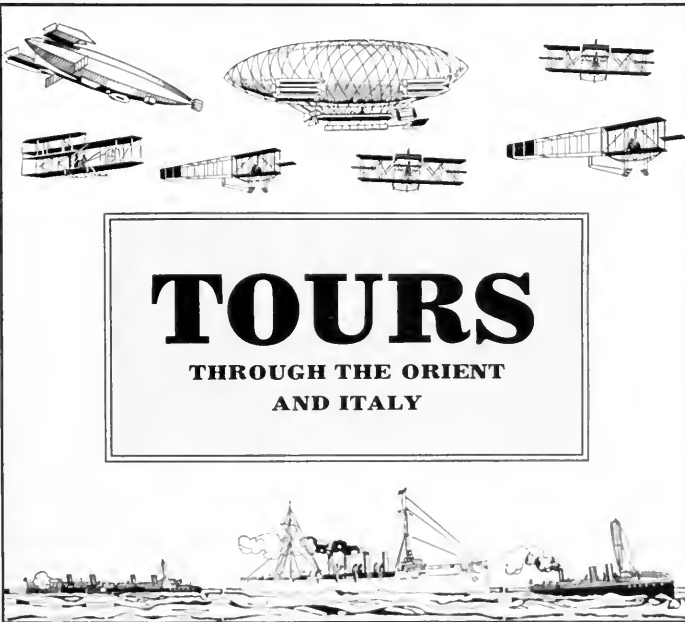

Bold Antique Condensed

72 Point

3 A \$7 35 4 a \$4 65 \$12 00

**EXTENDING
Merchandise**

60 Point

3 A \$5 75 5 a \$4 20 \$9 95

**TYPOGRAPHY
Quaint Building**

48 Point

4 A \$4 05 6 a \$3 45 \$7 50

**EARNEST CRITICS
Burglars Repenting**

42 Point

4 A \$3 10 8 a \$3 30 \$6 40

**UNINJURED MENTOR
Considering Freshman
Treasurer Satisfactory**

Bold Antique Condensed

36 Point

5 A \$2.50 9 a \$2.50 \$5.00

INSTRUCTIVE READINGS
Philosophers Transformed
Unsophisticated Bostonian

30 Point

5 A \$2.05 10 a \$2.20 \$4.25

COMPOSITION SAFEGUARDED
Thoughtful Musicians Enthusing
Nonsensical Statement Resented

24 Point

6 A \$1.70 12 a \$1.85 \$3.55

LINGUIST INTRODUCES NOVEL GAME
Highwaymen Show Wonderful Strength
Important Document Received Monday

18 Point

10 A \$1.60 18 a \$1.65 \$3.25

KINETOSCOPE PLEASED
Tremendous Jovial Crowd
Comedy Dismal Otherwise

10 Point

18 A \$1.15 36 a \$1.35 \$2.50

REPORTS TERRIBLE DISASTER
Medical Fraternity Regrets Trials
Exemplary Pupil Advises Brother
Farmers Organizing Associations
Congested Thoroughfare Doomed

14 Point

14 A \$1.40 29 a \$1.60 \$3.00

ZEALOUS GENERAL RETIRING
Compliment Sensational Athlete
Restricting Academy Graduates

8 Point

20 A \$1.00 42 a \$1.25 \$2.25

IMPRESSIVE SPEAKER DEFENDS YOUTH
Beautiful Scenery Attracting Gay Travelers
Undeclared Athletes Received Neat Trophy
English Writer Censures Popular Musician
Stevadore Rescues Comely Gotham Actress

12 Point

16 A \$1.30 32 a \$1.45 \$2.75

BEAUTIFUL CHARACTERS POPULAR
Discriminating Printers Remove Doubt
Gentleman Tourist Seeking Recreation
Unprecedented \$1234567890 Values

6 Point

22 A \$0.90 46 a \$1.10 \$2.00

HOSTILE REVOLUTIONISTS ACCEPT PROMISES
Representative Delegation Honor Former Adviser
Pioneer Manufacturer Complimenting Magistrate
Government Lawyer Reviews Mysterious Charges
Successful Printers Appreciate Good Type Design
Characteristics of Famous Martyrs Just Published
Humiliated Detective \$1234567890 Informs Police



Skilled Men

**ARE IN DEMAND AND
HAVE NO TROUBLE
IN SECURING GOOD-
PAYING POSITIONS
IN ANY SECTION OF
THE UNITED STATES**

Our courses in mechanics have been the means of paving the way for many poorly-paid men, both old and young, to secure good positions in all parts of the country. If you are not satisfied with your position, and have no objection to spending a few nights each week studying our course, we can help you to double your salary. It makes no difference whether or not you have had any previous experience in the studies you desire to take up, our lessons are so easy to understand, and at the same time so instructive, that it is really a pleasure to study them. Now is the time to start

**WRITE FOR
BOOKLET
GIVING FULL
PARTICULARS**

Atlas Correspondence School

**10 Oak Street, DETROIT, Mich.
HAROLD M. BRANKTON, President**

Bold Antique Condensed in Display

Bramdock Institute of Music

NORTH HUDSON BOULEVARD, HARRISTOWN, PENN.

THIRTY-SEVENTH SUCCESSFUL YEAR

Instruction in the Higher Classes of Music

**The Science
and Principles of Harmony and
Musical Composition**



**PROFESSORS FROM
GREAT AMERICAN AND EUROPEAN
UNIVERSITIES**

72 Point

3 A \$7 70 4 a \$4 50 \$12 20

PRINT Shop

60 Point

3 A \$6 30 5 a \$4 25 \$10 55

EXTINGUISH
Ninety Burglars

54 Point

3 A \$4 75 6 a \$4 00 \$8 75

REBOUNDDING
Contrary Pilgrims

48 Point

3 A \$3 80 7 a \$3 70 \$7 50

ENCOURAGING
Measure Electricity

42 Point

4 A \$3 40 7 a \$2 85 \$6 25

MACHINE RUINED
Disturbed Compositor

36 Point

4 A \$2 00 8 a \$2 40 \$5 00

FORMER MECHANICS
Grocer Distributes Biscuits
Found Muscular Harlemiter

30 Point

5 A \$2 20 10 a \$2 25 \$4 45

BANKERS HOME BURNING
Congratulates College President
Discharged Impudent Carpenter

24 Point

6 A \$1 85 11 a \$1 65 \$3 50

DOCTORS CONDEMN DRINKING
Students Disconcerted Cranky Teacher
Desperate Desmond Forgets Rosamond

18 Point

9 A \$1 60 18 a \$1 75 \$3 35

FIREMAN PROMOTED
Graduate Returns Diploma
Champion Billiard Players

10 Point

18 A \$1 25 36 a \$1 30 \$2 55

DESIGNED AMERICAN SERIES
Handsome Singer Pleases Audience
Determination Always Wins Success
Merchandise Stolen From Foreigner
Clever Monkey Amuses Vast Throng

14 Point

13 A \$1 55 25 a \$1 45 \$3 00

BROKER SURPRISES LADIES
Nine Minutes From Herald Square
Treats Senators From Indianapolis
Building Inspector Loses Situation

8 Point

24 A \$1 15 46 a \$1 10 \$2 25

CHAMPION HURDLE RACER COMPETES
Received Ninetieth Prize at Colorado Exhibition
International Running Championship Thursday
Entertain Compositors Financially Embarrassed
Insignificant Mechanics Approached Alderman
Prisoner Escaped Without Unnecessary Trouble

12 Point

16 A \$1 40 32 a \$1 35 \$2 75

GIRL DANCER CAUSED TROUBLE
Retired Printer Becomes School Teacher
Educated Irishmen Holding Conventions
Discovered \$1234567890 Behind Stairs

6 Point

24 A \$1 00 50 a \$1 00 \$2 00

BACHELOR REFUSES PRESENTS FROM FEMALES
Immense Gathering Witnessed Daring Acrobatic Performer
Contractors Started Negotiations for Million Dollar Subway
Inferior Mitering Machines Continue to Worry Compositors
Policeman Promenading Broadway Recognizes Absconder
Bank Cashiers Shortage Amounted to Nine Hundred Dollars
Children Enjoying \$1234567890 Bathing at Midland Beach

Home Welcome for
all Maine Tourists at

KUIR'S

OLD HAMPTON ROAD

INN

Special Attention Always Given
Automobile Parties and Campers
Who Desire all the Comforts of
a Good Country Inn Like Kuir's

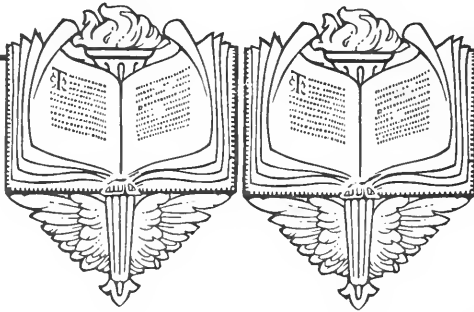

Strathmore Oldstyle



A PLAIN, direct type, with an individuality which makes it attractive for fine printing as well as for varied forms of open display work and modern advertising publicity. Particularly appropriate for artistic announcements and places where attractive type designs are desirable.

PRINTED MATTER THAT IS COMPOSED IN THE STRATHMORE FACE HAS QUALITY AND STYLE.

The Strathmore Oldstyle

**AMERICAN
TYPE FOUNDERS CO.**

MAKER OF STRATHMORE OLDSTYLE

SILVER WARES

FOR THE HOME

There is nothing so delightful to make as the Home Beautiful as artistic Silver Ware. It reflects very good taste and brightens the atmosphere of every room in which it may be placed. Distinctiveness in design and elegance in appearance are the characteristics of our large stock. The choicest and best are here.

HANCOCK & GORDON

WASHINGTON, PA.

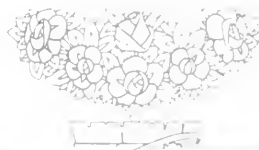

AGENTS FOR THE FAMOUS OLD GOLDEN GRAIN FLOUR

R. H. PERKINS & COMPANY

WHOLESALE GROCERS

Managed by

EDWARD CUMMINGS

COLUMBUS, O.

Strathmore Model Design

Fancy Stationery



THIS company now carries the largest and most exclusive line of writing papers in the state of Ohio. All stock is selected with special reference to salability. Our facilities for production at a very low cost are unequalled. Write for samples.

HENDERSON PAPER COMPANY, LORAIN, OHIO

72 Point

3 A \$6 45 4 a \$4 30 \$10 75

MINERS DIE
Smoke House

60 Point

3 A \$5 85 5 a \$4 05 \$9 40

BEST HUNTER
Heading Desired

48 Point

4 A \$3 95 7 a \$3 55 \$7 50

HERDERS FRISKY
Require Nifty Prints

42 Point

4 A \$3 05 9 a \$3 35 \$6 40

FOUND NEW THINGS
Using Cushing Antique
Shortened Canal Routes

36 Point

5 A \$2 50 9 a \$2 00 \$5 10

KEPT FORMER PRINTER
Prominent Designer Sought

30 Point

5 A \$2 10 10 a \$2 15 \$4 25

SHOWED BEAUTIFUL ENGINE
Building Disadvantages Overcome
Signify Wonderful Characteristics

24 Point

7 A \$1 80 13 a \$1 75 \$3 55

PROSPEROUS MODERN REMINDERS
Requiring Every Important Consideration
Cold Weather Prediction Scared Aeronaut

18 Point

10 A \$1 65 20 a \$1 60 \$3 25

COURT ORDERS CEASED
Faces Original Charge Daily
Youthful Elopers Serenaded

10 Point

18 A \$1 20 38 a \$1 35 \$2 55

SUNSHINE FOLLOWED TEMPEST
Printing Made a Pleasure Nowadays
Wrestler Failed to Perform Tuesday
Perfect Workmanship Very Scarce
Showing Natural Grace and Beauty

14 Point

14 A \$1 40 28 a \$1 60 \$3 00

MUSIC ENTERTAINS PAUPER
Snowstorm Blocks Railroad Train
Reliable Guides Found Fresh Meat
Their Handsomest Souvenir Given

8 Point

22 A \$1 05 44 a \$1 20 \$2 25

COUNTRYMEN INTERESTED SPECTATORS
Fighting Council Thwarts Large Indian Brave
Prosperous Countries Encouraging Expansion
Liberal Education Resulting Very Satisfactory
Protecting Every American Interest Promptly
Startling Experiences Relating to War Stories

12 Point

16 A \$1 35 32 a \$1 40 \$2 75

FOREIGN HOUSE OBSCURED SCENES
Adventurous Explorer Returns Disgusted
Procure Lining Type Faces for Real Profit
Largest Factories \$1234567890 Gaining

6 Point

24 A \$0 90 48 a \$1 10 \$2 00

RENOVATE AUDITORIUM IN CAREFUL MANNER
Patrons Rented Opera Chairs Every Saturday Evening
Ancient Tombs Unearthed in Egypt and Nile Country
Gibraltar Contains Heavy Fortifications on Lofty Rock
French Soldiers Saluted Foreign Navy With Ten Guns
Agricultural Movement on Prosperous Idaho Ranches
Largest Governments \$1234567890 are Losing Many

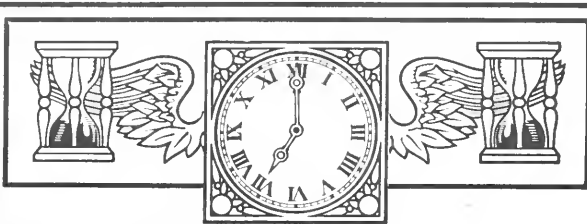

THE SEVEN-HOUR WHITE TRAIN

MODERNLY EQUIPPED FAST TRAIN
FOR THE BUSINESS MEN, BETWEEN

Poughtown and Lynn

OVER W. & M. NEWLY BUILT TRACK

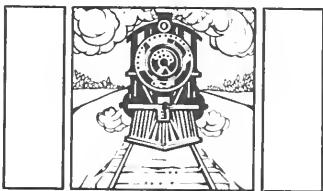

To ensure better business relations, more speedy connections between these two charming cities, and for greater convenience and safety of the traveling public, we have just inaugurated a new express service

FOR INFORMATION APPLY TO

FRANCIS S. MUNDSELL

GENERAL AGENT

SHERIDAN BUILDING, POUGH TOWN



Versatile Ornaments

BETON HOUSE

LONESHORE, R. I.

JAMES M. BETON, Proprietor
CHARLES DUREIN, Manager

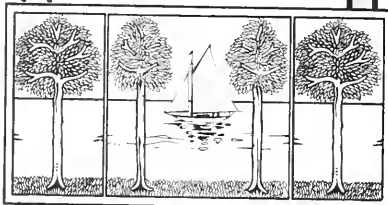

WHY seek other climes and endure the many great disadvantages of foreign languages and conditions that you must necessarily come in contact with, when you can enjoy all the pleasures that are found in life, and the most entrancing scenery that nature has bestowed, at the Beton House? Being located amid health-giving pine-clad hills and close to the river and lake it affords all the advantages that one seeking rest and recreation could ask for, and at low rates



Cast Squares Department Store Initial Versatile Ornaments



BORDERS

MANY new and original ideas in combination borders appear for the first time in this book. They constitute a distinct and unique innovation in border designs. The various characters are so designed that they may be used in combination or individually as the compositor's best judgment may dictate. For department store advertising and newspaper publicity they should prove most valuable and attractive. The Celebration Border used on this page will surely afford opportunity for the most tasteful and artistic display. These new borders have a wide range of usefulness and may be used to embellish printing of a most varied character. In appropriateness and in elegance of design they are unsurpassed

These new and original border designs are cast in type molds accurately to the point system

American Type Founders Co.

ORIGINATOR AND DESIGNER OF USEFUL BORDERS, TYPES AND ORNAMENTS

Celebration Border

AMERICAN TYPE DESIGNS ARE MOST POPULAR

Lining Central Antique No. 2

54 Point

3 A \$6 25 4 a \$3 80 \$10 05

PRINT Light

48 Point

3 A \$4 75 4 a \$2 75 \$7 50

Heard CHIME

42 Point

3 A \$3 40 6 a \$3 20 \$6 60

DESIGN Engines

36 Point

4 A \$2 90 6 a \$2 40 \$5 30

Purchasers REMIND

30 Point

4 A \$2 10 8 a \$2 15 \$4 25

THIMBLE Manufacturing

24 Point

5 A \$1 60 11 a \$1 90 \$3 50

MENTION HISTORICAL NOTE
Shows Physical Culture Student

18 Point

8 A \$1 65 15 a \$1 65 \$3 30

CYLINDERS NOISY
Men Require Solitude

10 Point

18 A \$1 20 36 a \$1 30 \$2 50

CHAPERON BEAUTIFUL GIRLS
Mails Descriptive Pamphlets Free
Owners Sold Many Timber Tracts

14 Point

11 A \$1 45 21 a \$1 55 \$3 00

CATCH STRONG KNIGHT
Build Modern Opera House
Soldiers Return From India

8 Point

18 A \$1 05 37 a \$1 20 \$2 25

PIGEON CAPTURED IN MIDOCEAN
Foundation Laid for Modern Dwelling
Principal Port Visited on World Cruise
Horse Raising Opens Field for Printers
Declare First Dividend on Every Share

12 Point

14 A \$1 30 28 a \$1 45 \$2 75

TRAINED SEA LIONS ESCAPED
Broke Marvelous Pitcher Sunday
Distinct \$1234567890 Modern Set

6 Point

20 A \$0 95 40 a \$1 05 \$2 00

SILENT NIGHT BIRDS RESTED FREQUENTLY
Ocean Bathing Strengthens and Develops People
Honorable Method Used in Obtaining the Money
Reader Spent Considerable Time in South Africa
Six Masted Ship \$1234567890 Lost Anchor Chain

POET KINGS

A SELECTED LIBRARY OF POETRY



IN ORDER to meet the long felt desire for a complete collection of high-class poetry at medium price, the publishers undertook the great task and now offer to the reading public the result. "Poet Kings" is issued in separate volume form, each of which contains the complete works of one or more great poets, translated into English. Nearly every known country, from classic to modern, tells us, through the medium of one of her most gifted sons, of the pleasures and woes that surrounded the lives of its people. Therefore has this edition not only educative value, but has immense historic worth as well. It will prove a mine of art and wisdom to students, and a revelation to all the lovers of thought in rhyme forms. Nine volumes, leather bound, gilt stamped letters. Sold either separate or collectively. Leading dealers act as our representatives

Price for the entire edition, postpaid, \$25.00

Single volumes, \$3.00 each, postage 14c extra

BRESIGER, PUBLISHER

TENTH AVENUE AND SIXTH STREET, YONKERS

42 Point

3 A \$4 10 4 a \$2 40 \$6 50

MINER Insured

36 Point

3 A \$2 65 6 a \$2 45 \$5 10

BIRDS FIND NEST Kind Ladies Report

30 Point

4 A \$2 15 8 a \$2 10 \$4 25

RIGHT SOUND BANKS Introduced Mining Stock

24 Point

6 A \$1 80 12 a \$1 80 \$3 60

MATE RESCUED SINKING MAN Dreadful Mine Explosion Described

18 Point

8 A \$1 50 17 a \$1 75 \$3 25

REPORTS CONFLICT Made Particular Brand Familiar Faces Present

8 Point

18 A \$1 10 38 a \$1 15 \$2 25

DEMANDS REFUSED POLITICIANS City Fathers Asked Important Point Eminent Lawyer Retained by Banker Prominent Societies Organized Band Grand Reception Given Haughty Duke

12 Point

14 A \$1 25 30 a \$1 50 \$2 75

HONEST SALESMEN COMBINE Rich Americans Entertained Lord Explains Ancient Historical Event Some Bet \$1234567890 Big Stack

7 Point

24 A \$1 00 48 a \$1 25 \$2 25

BANKERS USED VERY CURIOUS METHOD Funds Vanished Quickly From Ironclad Bank Depositors Arrange for Immediate Statement Sound Institution Advanced Necessary Fund Farmer Spends Large Fortune During March Grand Charity Entertainment Given Recently

10 Point

16 A \$1 20 35 a \$1 30 \$2 50

MERCHANTS ERECT MANY EDIFICES Numerous Ancient Residences Destroyed Society People Invading Southern Resort Inside Decorations Pronounced Beautiful

6 Point

20 A \$0 95 40 a \$1 10 \$2 05

PROMINENT CITIZENS RETURNED SOUTH Summer Vacations Granted Young Musicians Money Promptly Advanced Business Project High Mountain Climbing Expert Found Dead American Faces Always Command Attention Runaway Boy \$1234567890 Received Cash

9 Point

20 A \$1 15 40 a \$1 35 \$2 50

FIRM SECURED GENEROUS CONTRACTS Construction Parties Arrange Practical Work Builder Refused Special Inducements Offered Important Discovery Made During Argument

5½ Point

22 A \$0 90 40 a \$1 10 \$2 00

REMARKABLE DISCOVERIES CAUSED CONFUSION Scientific Research Explains Some Difficult Problems Merchants Received Important Letters From Abroad United States Government Erected New Department Great Enthusiastic Meetings Held During Campaign Newspaper Managers Expect Very Pleasing Results

24 Point

6A \$1.80 11a \$1.70 \$3.50

HANDSOME JOBS PRINTED
Magazine Contributors Delighted

20 Point

7A \$1.55 11a \$1.80 \$3.35

JUST COMPLETING BIOGRAPHIES
Astronomers Questioned Philanthropist

18 Point

9A \$1.65 1-a \$1.60 \$3.25

COUPLE UNITED THROUGH NEWSPAPER
Unquestionably Superior American Type Faces

12 Point

14A \$1.25 29a \$1.50 \$2.75

STRANGER DELIGHTS ACTOR
Oldest Suburbanites Defied Police
Received \$1234567890 Positions

6 Point

20A \$1.00 41a \$1.00 \$2.00

DEMONSTRATING NEW HAIR TONICS
Young Sleuths Overtaking Daring Cracksmen
Gigantic Benefit in Aid of Injured Bostonian
Six Incomparable Bargains Offered to Ladies
Tremendous Crowds \$1234567890 Gathering

10 Point

16A \$1.15 35a \$1.35 \$2.50

STRONG KNIGHT BUYS GOLD RINGS
Handsome Original Design Came Today
Useful and Distinct American Job Letter

5 on 6 Point

24A \$0.90 50a \$1.10 \$2.00

REFORMED BURGLARS SEEKING EMPLOYMENT
Magistrate Questions Fourteen Beautiful Young Ladies
Sculptor Exhibits Beautiful Works Before Six Hundred
New Haven Salesman Retiring From Business Concern
Humane Society Received Congratulations From Many

8 Point

18A \$1.10 38a \$1.15 \$2.25

STEAMSHIP CAPTAIN RESCUED ACROBAT
Beautiful Display Page Designed by Composer
Young Architect Won Coveted Golden Medallion

LINING ANTIQUE NO. 526

5 Point

22A \$0.95 42a \$1.05 \$2.00

SOLDIERS RETURNED HOME FROM TROPICAL COUNTRIES
German Enters University After Tedious Preparatory Course
Journalist Makes Eloquent Speech at Tenth Annual Banquet

Lining Ionic No. 522

18 Point

9A \$1.60 16a \$1.65 \$3.25

DETERMINED STUDENTS MENTIONED
Enthusiastic Members Receive Testimonials

12 Point

14A \$1.20 28a \$1.55 \$2.75

STRENUOUS PHYSICAL EXERCISES BECOME POPULAR
European Acrobats Perform \$1234567890 Gymnastic Stunts

10 Point

16A \$1.15 34a \$1.35 \$2.50

PROCURING ENCHANTED MANSION
Remarkable Building Lately Constructed
Benevolent Institutions Securing Control

6 Point

18A \$0.95 42a \$1.05 \$2.00

RESTRICT FARMERS AND MERCHANTS
Comely Singer Befriended Former Playwright
Enterprising Member Detained for Nine Days
Parisian Artist \$1234567890 Wins Hundred

8 Point

18A \$1.05 39a \$1.20 \$2.25

PERSONAL QUESTIONS WISELY ANSWERED
Bright Maidens Entertain Brilliant Editorial Writer
Interesting Report Submitted by Charming Females

5 Point

17A \$1.00 40a \$1.10 \$2.10

MANY EXTRAORDINARY PROBLEMS SOLVED
Excursionists Having Glorious Times at New Resort
Foremost Publishers Returning From European Trip
Armed Bandits Surprise Brave Locomotive Fireman

120 Point

3 A \$6 40 4 a \$4 60 \$11 00

BROKEN Medals

96 Point

3 A \$5 60 4 a \$4 40 \$10 00

Educational HUMOR

84 Point

3 A \$4 40 5 a \$4 10 \$8 50

RENUMBER Steamboat

72 Point

4 A \$4 25 6 a \$4 10 \$8 35

Demonstrators EXAMINED

60 Point

4 A \$3 60 6 a \$3 35 \$6 95

MERITORIOUS Designs Secured

48 Point

5 A \$2 80 10 a \$2 50 \$6 30

**MODERNIZED FINANCIAL INVESTMENTS
Generous Individuals Demanding Result**

42 Point

6 A \$2 40 11 a \$2 85 \$5 25

HANDSOME KNIGHTS TENDERED RECEPTION Beautiful Damsels Serenading Brave Soldiers

36 Point

6 A \$2 15 11 a \$2 20 \$4 35

MAGNIFICENT AUTOMOBILE EXHIBITION CONCLUDED Some Remarkable Mechanical Achievements Viewed

30 Point

8 A \$1 80 16 a \$2 30 \$4 10

EXTRAORDINARY CHRYSANTHEMUMS IMPORTED FROM EUROPE Many Bright Rosebushes Mingling With Sweet Orange Blossoms

24 Point

11 A \$1 60 21 a \$1 90 \$3 50

REMARKABLE GYMNASTIC PERFORMANCES INTRODUCED AND ENCOURAGED Strenuous Exercises for Developing Muscles Recently Advocated by Professors

18 Point

16 A \$1 45 32 a \$1 80 \$3 25

NUMEROUS INSPIRING MANUSCRIPTS UNEARTHED Historical Documents Bearing Upon the Benevolent Nature and Brilliant Intellect of Benjamin Franklin

10 Point

26 A \$1 10 53 a \$1 40 \$2 50

INDIVIDUAL EFFORT MEANS GREAT ALERTNESS AND FORCE
Ambition is the world-moving lever that achieves. Numerous men whose ambition is not awake to life's opportunities fall far short of the possibilities which their powers encompass and consequently their remuneration is never very satisfactory

14 Point

22 A \$1 35 43 a \$1 65 \$2 00

INTELLIGENT SCHEMES CONCEIVED AND QUIETLY PROMOTED Stupendous Profit Making Concerns Inaugurating Progressive Methods Among Their Foreign and Domestic Trading Houses

8 Point

33 A \$1 00 63 a \$1 25 \$2 25

MAGNIFICENT NATURAL WONDERS ENHANCE THE PICTURESQUE HUDSON
Nowhere in the world is there a more beautiful water trip than a journey up the picturesque Hudson river that flows majestically through a valley of peace, still bearing the footsteps and scars of battle. The wonders of Nature which abound along this delightful waterway are beyond description

12 Point

26 A \$1 25 52 a \$1 50 \$2 75

PICTURESQUE DESCRIPTION OF A RECENTLY CONSTRUCTED MANSION Exquisite Decorations Adorn the Reception Rooms and Beautiful White Marble Statues Enrich the Appearance of the Sloping Lawn Which is Frequently the Scene of \$1234567890 Delightful Midsummer Banquets

6 Point

34 A \$0 90 68 a \$1 10 \$2 00

NUMEROUS PRACTICAL HINTS ON SECURING AND MAINTAINING TRADE IN MEXICO
Getting trade in Mexico has been made the subject of considerable comment on the part of travellers and foreign concerns, especially Americans. Many valuable hints are offered as to the best manner to secure a customer, generally referring to the possession of the Spanish language and other important qualifications, but reference is seldom made to agreements, the very foundation of the business transaction which serves as a basis \$1234567890 for future commercial relations

Checkers

A Story of the Pluck and Perseverance of John Dawson in His Great Search Through Russia

This new book is one that will please the most casual reader. One scene in particular that will not be forgotten is the description in the chapter relating to the poor, patient, betrayed Jane, who is on her way to the church in a very penitent mood, and is followed by the womenfolk of the village who abuse her with every vile insult that they can think of. The end of this romance depicts the taking of Jane's persecuted child to be a helper on the boat of his long lost father and the reconciliation. The great search of John Dawson is finally rewarded when he personally locates his foster-sisters and matters are then very successfully readjusted.

Written and Illustrated by the Great and Highly Esteemed Revolutionary War Hero

Captain Horace Driamford

Richard Manderson Book Publishing Company
 Corner South Madison Avenue and North Humboldt Street, San Francisco, California

The Brower Drum Cylinder

MADE IN ONE SIZE ONLY 26 x 38
 FOR INFORMATION AND PRICE LIST
 SEND FOR DESCRIPTIVE PAMPHLET

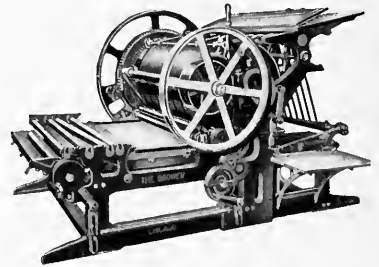

Better your facilities by the installation of a Brower and you will produce a handsome paper, thereby increasing the subscription list and helping you in securing advertising patronage, while at the same time placing you in a position to do first class pamphlet or book work, including county printing, which will in many cases keep you busy during the usual dull summer season.



**American Type Founders
 Company** General Selling Agent
 ORDER FROM NEAREST HOUSE

Happgood Florets

Week Ending

Commissioner

Weekly Statement of Expenditures of Municipal Street Cleaning Department

Section 28	SQ. YDS. IN SUB-SECTION	NUMBER OF CLEANERS EMPLOYED	NUMBER OF HOURS WORKED	RATE OF WAGES PER HOUR	TOTAL AMOUNT FOR CLEANERS	NO. HOURS FOREMAN WORKED	RATE OF WAGES FOR FOREMAN	TOTAL AMOUNT FOR FOREMAN	OTHER EXPENSE IF ANY	Total Cost
Sub-Sec. A										
Sub-Sec. B										
Sub-Sec. C										

Miehle Extra Condensed in Practical Display

The

BOSTON

WIRE



STITCHER

Proof

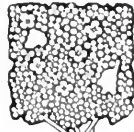

READ OVER CAREFULLY FOR ERRORS; "OK" AND RETURN TO US TOGETHER WITH THE ORIGINAL COPY AND PROOF



Jordan Press

17 HART ST., AKRON, O.



RAPID, SIMPLE
RELIABLE

A Stitcher that is as much different from and as much better than any other Stitcher as the modern printing press is from the Ben Franklin hand press

Mercantile Border Versatile Ornament

Chandler & Price Gordons

OVER 40,000 OF THESE PRESSES HAVE BEEN MANUFACTURED AND SOLD IN TWENTY YEARS

JOHN EMERSON, President
OWIGHT FRANKLIN, Vice-President



Long Distance Phone, 57 Main
Local Phone, 1269 Cramercy

The JOHN H. EMERSON & COMPANY

Book, Commercial and Society



Printing

Up-to-date methods enable us to do
the Finest Artistic Printing of every description

THAT ATTRACTS CUSTOMERS

Corner Greenwich Square and Hickock Street, Blainstown, Maine

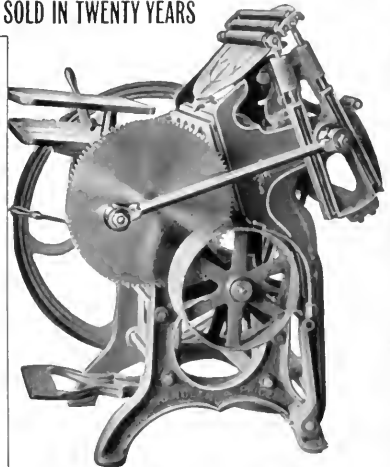

Each press is furnished with throw-off, depressible grippers, three chases, a brayer, two wrenches, two sets of roller stocks, a treadle and one roller mould. If desired, two extra chases or three cast rollers will be furnished instead of one roller mould

AMERICAN TYPE FOUNDERS COMPANY

96 Point

4 A \$5 55

BRIGHTER KINGS

84 Point

5 A \$5 25

**MODERN DESIGNER
HANDSOME CHAIRS**

72 Point

5 A \$5 50

**BANKERS ORGANIZING
EXHIBITIONS CLOSING**

60 Point

5 A \$4 20

**STRONG RACING MACHINE
REMARKABLE HANDICAPS**

48 Point

7 A \$3 75

AMERICAN PRODUCT EXCELLENT
INTERESTING STORIES RELATED

36 Point

10 A \$2 85

DISTRIBUTE HANDSOME EASTER PRESENTS
SMALL MONEY CONTRIBUTIONS WELCOMED

30 Point

14 A \$2 00

REMARKABLE SHOWING SPECIAL HOLIDAY PRESENTS
PARISIAN JEWELRY STOCK DESIRABLE IMPORTATION

24 Point

20 A \$2 50

ARRANGEMENTS NOW CONCLUDED
EARTHQUAKES REPORTED COMING
MANY NEW BUILDINGS DESTROYED

12 Point

35 A \$1 50

PROSPEROUS TOURISTS TRAVEL WITH COMFORT
ENGAGED COUPLE ELOPING MEET STORMY SEAS
ANGRY PARENTS SEEK LOST CHILD EVERYWHERE
PRODIGAL DESIRES \$1234567890 FATTED CALF

18 Point

26 A \$2 00

ANCIENT SCIENTIFIC MINERAL DISCOVERIES
EXPLORATION AMALGAMATED ASSOCIATION
NUMEROUS DARING ADVENTURERS HONORED

10 Point

40 A \$1 40

OUR PRESENT METHOD OF SELLING WEIGHT FONTS OF
JOB TYPE AT OUR BODY TYPE PRICES AND DISCOUNTS
GIVES THE UP-TO-DATE PRINTER AN OPPORTUNITY TO
STOCK UP HIS COMPOSING ROOM WITH MODERN TYPE

14 Point

33 A \$1 75

NUBIAN BURLESQUERS REHEARSING NEW BURLETTA
SCENIC PRODUCTION REVOLUTIONIZES STAGECRAFT
SUNBEAMS DETERIORATE WONDERFUL PERFORMANCE
ENCOURAGEMENT GALORE TENDERED BRAVE HEROES

8 Point

45 A \$1 25

NEW AND STYLISH FASHIONS IN TYPE AND BORDER DESIGNS
ARE VERY ESSENTIAL FEATURES IN SMART PRINTING AND AS
AMERICAN TYPE IS NOTED FOR THESE VERY POINTS IT IS NOT
NECESSARY THAT WE ADVANCE ARGUMENT MORE CONVINCING

6 Point

50 A \$1 00

PROFESSOR JUMBO'S UNEXCELLED WILD ANIMAL SHOW AND CIRCUS MENAGERIE
FINAL APPEARANCE IN THIS COUNTRY OF THE WORLD'S CELEBRATED TRAINER
WONDERFUL AND ORIGINAL ACROBATIC FEATS BY THE MOST FAMOUS ATHLETES
REMARKABLE EXHIBITION OF SNAKE CHARMING \$1234567890 MATINEES DAILY



CONEY OPERA HOUSE

EAST HERMIS BOULEVARD
TELEPHONES 3256-3257 STUYVESANT

SEVENTEEN WEEKS
MATINEE ON SATURDAY ONLY
BEGINNING
FRIDAY FEB. 23

MESSRS. KETCHUM & SHOWM
BEG TO ANNOUNCE THE
ENGAGEMENT OF

MARJORIE KING

"THE BELLE"

IN THE STUPENDOUS
STAR CAST REVIVAL
OF HERN'S COMEDY

THE BELLE JERWIN

AUGMENTED ORCHESTRA
ELABORATE PRODUCTION

Strathmore Ornament



BOOK BARGAINS

G We beg to announce that we have just placed a large number of miscellaneous books on our bargain counter. These fine books are very slightly shopworn, just enough to prevent them from being classed as new. Some of the best-known authors are represented in the accompanying list. We have a few complete sets.

**THE BINDINGS ARE ALL OF THE BEST QUALITY
AND ARE FULLY GUARANTEED IN EVERY WAY**

To make these books move quickly we have marked the prices at about one-half the publisher's regular rate.

Among the lot are four sets of Dickens' works previously sold at \$40; each to be sold at **\$24**

THE HERITAGE OF THE WESTERN PLAINS

By VIOLA HELENA GRAYHURST

We have also secured the complete second edition of this famous novel and are selling them at a low figure. "An appealing love story, pure as the far water brooks," says one well known reviewer, in the latest issue of the Scribe, of this new and fine novel

**VOLTAIRE
ADDISON
MARK TWAIN
BROWNING
DE FOE
BUNYAN
PAINE
CHAUCER
DICKENS
LONGFELLOW
ELIOT
HUGO
AND MANY OTHERS
EQUALLY WELL
KNOWN**

THE EAST BRADFORD BOOK EXCHANGE

CORNER MASONIC AND EAST EIGHTH STREETS, EAST BRADFORD



GOVERNOR BURNS RESIGNS MONDAY

NOTIFIES LEGISLATURE THAT HE MUST SEEK NEW CLIMATE TO BENEFIT HEALTH

BY ADVICE OF NEW MINBURN SPECIALIST HE WILL LEAVE FOR PHOENIX MONDAY ON THE SOUTHERN PACIFIC

BANNERTON, August 27.—Governor Thomas Holcomb Burns sent a special message to the Legislature this afternoon making known his intention to relinquish the Governorship on Monday next. The reason given is ill health. Dr. Maurice Stanwix, the noted specialist on stomach troubles recently informed the family of the Governor that his only hope for ultimate recovery was to get entirely away from the duties and cares of public office and breathe

MOB DEFIES F

BOHNVILLE POLITICAL SITUATION MADE MORE UNCERTAIN BY DEATH OF BRADY

The death of Senator Brady has added to the uncertainty of the political mixup in the Fourteenth District. Chairman Foster of the State Committee literally threw up his hands in despair yesterday and left for his home in Monroe. Mr. Foster declared before leaving that it seemed that almost every man in the district had gone office mad and insisted on being nominated for some elective position. There are fourteen well developed boomlets for the vacancy caused by Senator Brady's death, and no possible compromise is in sight.

PARENTS OF MINERVA HURSTING OFFER REWARD FOR RETURN OF THEIR CHILD

The search for Minerva Hursting, the eight year old daughter of the millionaire printer, has been further stimulated by an additional offer of \$5,000 for the return of the child by

HUNDRE REFUS

Fully five thousand f congregated at the int avenue and Halsey str threw curb stones and policemen from station tain Devereux. The p injured and hurried to others were carried to t Many bystanders were attacked by the frenzi ed had it not been for carried through the mo risk of his life. Captai

CONVENTION DEMANDS MODERN COST SYSTEM

PRINTERS SEEK TO FIND SCIENTIFIC SYSTEM OF ESTIMATING

SPECIAL COMMITTEE APPOINTED TO FIND FIXED EXPENSES OF PRINTING PLANT

If the temper of the Master Printers' Convention, now being held in the ballroom of the Algonquin, reflects the attitude of employing printers in general, we may soon see the old cut-price system done away with and a new

printing had not yet begun its influence as a business. Printing is a business upon which all other businesses must lean to a greater or less extent. Therefore, dignify it by doing your best work, and by demanding a fair and legitimate return for your work.

"Every printer should have a sample room, where his work can be displayed to advantage. Most printers' samples consist of a bunch of odds and ends that mean nothing. Printers should take as much care in displaying their samples as shoe men, hardware men or other trades do. Be sure to have a sample room."

The next convention will be held at Holton on Thursday, August 25, 1913. It is hoped that a larger number of printers will be present.

PASSENGER AIRSHIP OF RICHMOND LINE BUMPS INTO A DERELICT OVER DOSWELL

WASHINGTON, August 27.—The 8:14 airship from Richmond entered the slip at the Georgetown terminal tonight fifteen minutes late. Aviator Richards reports having run into a ten-cylinder derelict while passing over Dos-

CUBS BE ORIO

The Cubs batted Curl three singles and a ho sixth inning. As usual off the batting honors f



BASEBALL
SERIES NO. 7

BALTIMORE 20 CHICAGO 13

Base Hits—Off Curle First Base on Balls—Off Brown, 3. Struck Out-

72 Point

4 A \$3 70 6 a \$3 55 \$7 25

EXCHANGE COMPLIMENTS
Printed Handsome Leaflet

60 Point

5 A \$3 70 9 a \$3 20 \$6 90

CONTRASTING ARCHITECTURE
American Lettering Handsome

48 Point

6 A \$3 10 10 a \$3 15 \$6 25

RECOGNIZE MERITORIOUS CONDUCT
Historical Characters Predominating

42 Point

7 A \$2 60 11 a \$2 65 \$5 25

WONDERFUL MACHINERY IMPROVEMENT
Excellent Sanitary Conditions Noticeable
Manufacturers Receiving Congratulations

36 Point

7 A \$2 05 12 a \$2 20 \$4 25

**LEADING CONFIDENTIAL AGENTS HARMONIZING
Demonstrated Practical Printing at the Academy
Photography and Engraving Inseparable Chums**

30 Point

9 A \$1 80 17 a \$2 20 \$4 00

**ARTISTIC COMPOSITION SIMPLE WITH AMERICAN TYPE
Reconstructed Designs Sometimes Meet With Approval
Father Knickerbocker Causing Universal Astonishment**

24 Point

12 A \$1 70 20 a \$1 80 \$3 50

**BEAUTIFUL MUSICAL ENTERTAINMENTS CREATING ENTHUSIASM
Artistic Printers Generally Pleased With Our Latest Productions
Magazines and Newspapers Becoming Particular in Advertising**

18 Point

16 A \$1 45 30 a \$1 80 \$3 25

**FREQUENT MISTAKES ARE UNNECESSARY AND SHOULD BE DISPENSED WITH
Unmistakable Evidence Produced to Show the Prosperity of the American
People Frequently Crossing the Brooklyn Bridge in Good Physical Condition**

14 Point

20 A \$1 30 41 a \$1 70 \$3 00

**SYSTEM MEANS EVERYTHING FOR PROSPERITY
Metropolitan Dailies Furnishing Latest Models
European and American Merchants Celebrated**

10 Point

23 A \$1 05 48 a \$1 45 \$2 50

**MAGNIFICENT DRAWINGS SHOWN PRINTERS
Individual Scholarships Tendered Students
Frisky College Boys Dined Bohemian Girls
Stereotyped Expression Became Mildewed**

12 Point

22 A \$1 15 46 a \$1 60 \$2 75

**EXISTING CONDITIONS BETOKEN FUTURE PROSPECTS
Boulevards and Walks Strewn With Scented Flowers
Ancient Structures \$1234567890 Become Modernized**

8 Point

25 A \$0 90 52 a \$1 35 \$2 25

**AMERICAN MECHANICS HOLD CONVENTION TUESDAY
Increasing Popularity Shown by Our Large Orders
Practical Display Featured Throughout Our Leaflets
Shows Handsome and \$1234567890 Useful Printing**

60 Point

6 A \$4 30

RENOWNED AMERICAN LINE

48 Point

8 A \$4 15

BEAUTIFUL ROMANCE DEPICTED

42 Point

8 A \$3 25

WESTERN TOWN INSPIRED AUTHORS

36 Point

9 A \$2 75

UNEXPECTED HELPFUL PHILANTHROPIST
THOUSANDS RETURNED FROM ARKANSAS

30 Point

11 A \$2 50

COMEDIANS ENTERTAIN LONESOME TRAGEDIANS
POPULAR CITIZEN INSTRUCTS COUNTRY BANKER

24 Point

16 A \$2 50

UNARMED BRIGANDS CAUGHT
EDITOR WARNED FOUR TIMES

14 Point

27 A \$1 75

HOSPITAL MATRONS SAVED BOYS
WINE DEALER REMAINED SEATED
COUNSEL ADVISED YOUNG JUROR

20 Point

20 A \$2 25

JUNGLE CAMP DESERTED QUIETLY
HYPNOTIZED YOUTHFUL SOLDIERS

12 Point

26 A \$1 50

HUCKSTER EMPLOYED WEALTHY MAN
LADIES PROPOSED RADICAL CHANGES
ROCKLAND \$1234567890 COUNTRIES

18 Point

21 A \$2 00

HUGE FOREIGN ARSENAL DESTROYED
AMATEUR BURGLAR DEFIED LABORER

10 Point

31 A \$1 40

BEAUTIFUL MANSION DESERTED BY FAMILY
STRONG GENERAL DESIRED FOUR SOLDIERS
JOB PRINTER PLEASED CRANKY OLD CRITIC



BISEN HE

Vol. XLI. No. 234.

MONDAY, JUNE

BEAUTY CONTEST POPULAR FOUR NEW CONTESTANTS JOIN RACE TODAY

MISS FRANCES CINDERS LEADS BY 15,000 VOTES THIS MORNING
MISS GRACE PRICE A CLOSE SECOND

The contest editor has great reason to rejoice this morning. On page five of this paper you will find yesterday's big vote in detail. The excellent showing made by a young lady from the Third Ward shows what loyalty and hustle on the part of schoolmates and friends will do. To Miss Cinders go the laurels today. Her friends and admirers certainly gave her a handsome vote. They will have to hustle if they keep her in the lead, for the nurses in the Garland Hospital are going to give that beautiful diamond ring to Miss Price if they can. The number of contestants was increased by four in yesterday's returns. The friends of Miss Bertha Lacey, Miss Lucy Baker, Miss Edith Hamson and Miss

Alma Miller placed them among the contestants with a good vote. The people of Bisen must award the \$500 diamond ring offered by the Herald to the most beautiful girl in the city, before July 19. Only six more weeks left. Coupons will appear on this page with each issue.

Select your favorite and vote early and often. Extra papers may be obtained at the Herald circulation department. Send them to friends residing in other places.

Watch for the big surprise that is sure to come some day this week. While the votes have been coming in large numbers we have reason to believe that someone is holding back many more. Saturday's big edition will contain pictures of the leaders.

A PRIMA DONNA YOUNG ARTIST SINGS OPERA HOUSE

Anna Davin, one of the most promising members of the Metropolitan company, too young in her career yesterday noon, when she appeared as Moli, in "La E Till then Mme. Davin ally restricted to small in two operas, "Il Maes and "Pacilagi," had shed with important role

The part of Moli, with charm, her grace and power for her. Rarely if ever more beautifully interpreted yesterday. It was an unheard of girlish artist, gifted with a fresh, tuneful voice and a conscience and an often found, sing Moli

In all respects Mme. Davin's delight in the engaging Pinucci's heroine. She with an impeccable intonation phrased daintily and simply and prettily.

POLICE HUNTING CLEVER TOURIST

PALMS HIMSELF OFF AS A GRAND ARMY
MAN LOOKING FOR LOST SONS
SLEEPS IN LIMBO

An East End lady who conducts a large boarding house came to the police headquarters very early yesterday morning to report the disappearance of a new boarder who overlooked his board bill when he left. Chief McGrawly next received a call from a prominent Grand Army man from the Third Ward. He had been buncoed to the tune of \$5, via the bogus check system and sympathy racket. From the descriptions given, the chief is certain that the man wanted is the "Gentleman Tramp" who spent a night in the city lock-up last Monday night, and told the chief he was looking for his two sons who were on the

been annoyed, and he was willing to withdraw the book out of deference to his colleagues in the conference.

Professor Ezra H. Tripp, of Dean Theological Seminary, presented the report of the West End Conference Commission on "Increased Pastoral Support," in which he said that the minimum salary of the average pastor should not be less than \$800 per annum. The report was approved.

MAGISTRATE'S FORTUNE TOLD

PARRAKEET AND MOUSE PROMISE HIM
SUCCESS AND LONG LIFE

Magistrate Hosen had his fortune told in Harrison Market Court yesterday, by a green and pink parrakeet and a black mouse. The bird picked out one of a tray of envelopes, which contained a message that promised luck and profit and a life of seventy-five years.

The mouse did better. It picked up an envelope with the statement that the court would be successful and live to be eighty-

PAYS \$13 FOR

WOULD HAVE BEEN \$2
FEW MINUTES THROUGH
OFF A DAY

"Thirteen, an unlucky deed!" quoth Al Pamuro into his pockets for prisoners in the old to yesterday. The thirteen arrested for "causing a lect" in Broadway and "What is all this?" said Fischer, looking up at handcuffed and shackled "Is this Russia?"

The unlucky thirteen advertising a vaudeville press agent, I. P. Ewin hit upon a novel scheme to attract the public bore on his back a white which was written in

"Magistrate Cannon a letter. Al Pamuro started a play about the same

72 Point

3 A \$1 25 4 a \$2 80 \$7 05

FRIENDS Departing

60 Point

3 A \$3 35 5 a \$2 65 \$6 00

Handsomest GARDENS

48 Point

5 A \$3 35 8 a \$3 00 \$6 35

CHRISTMAS Present Stolen

42 Point

5 A \$2 40 10 a \$2 85 \$5 25

Beautiful Pamphlets REPRINTED

36 Point

6 A \$2 10 10 a \$2 20 \$4 30

QUESTIONED EIGHT Brazilian Artisans

30 Point

8 A \$1 85 15 a \$2 15 \$4 00

Unfortunate AUTHORITY

12 Point

22 A \$1 25 46 a \$1 50 \$2 75

PHYSICAL INSTRUCTOR SCOLDS YOUTH More Designs \$1234567890 Submitted

24 Point

10 A \$1 65 20 a \$1 85 \$3 50

ELEPHANT HUNTER INJURED Inspect Automobile Mechanism

10 Point

26 A \$1 15 52 a \$1 35 \$2 50

TOURIST ENJOYING TRIP AROUND CAPE HORN Famous Actor Makes Pronounced Hit in Scotland Norwegian Sailor Completes the Perilous Voyage Eastern Police Expecting Arrival of Clever Sleuth

18 Point

14 A \$1 55 28 a \$1 70 \$3 25

VICTORIOUS MARATHONER LIONIZED Juvenile Cracksman Makes Restitution

8 Point

30 A \$1 00 63 a \$1 25 \$2 25

CONDENSED FACES INDISPENSABLE FOR PROPER DISPLAY Wonders of Egyptian Architecture Discovered Near Museums History Told of Sterling Fighting Qualities of Roman Gladiator Some Beautiful Examples of Typography Shown in This Book

14 Point

20 A \$1 40 40 a \$1 60 \$3 00

NOTORIOUS RUSTLER EXILED FROM NEVADA Pontiac Series Welcomed by Many Compositors

6 Point

34 A \$0 90 68 a \$1 10 \$2 00

GREAT AMERICAN DESERT CROSSED BY TWENTY GERMAN BACHELORS Thirty Youthful Philosophers Reorganized Prominent Savings Institution Building Inspectors Condemned Largest Exchange House in Empire State Superintendents and Foremen \$1234567890 Guests at Annual Banquet

PIANOS

OF RARE TONE AND GREAT BEAUTY

Hundreds of our pianos have been sold throughout the country in the past ten years and we have yet to hear of one dissatisfied purchaser. Every one of our pianos have that rare, sweet tone which is only found in pianos of the better grade. Come and hear them as they smile, sob, laugh or whisper tender words of love. They are as responsive to the human touch as only wonderfully-toned pianos can be. We like to have you come in frequently. No one will ask you to buy, for selecting a piano is a serious matter and requires time and discretion. No family need be without an H. & M. piano as our terms are so flexible that we can make them fit almost every emergency.

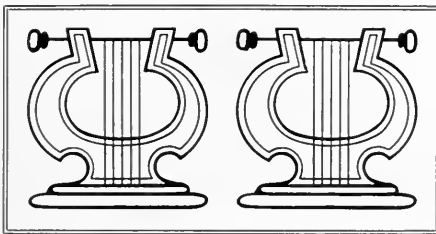

OUR LARGE STOCK OF HIGH-GRADE MUSICAL INSTRUMENTS IS THE BEST IN THE COUNTRY

HERBANK & MORGAN
 MANUFACTURERS OF HIGH-GRADE MUSICAL INSTRUMENTS
 4978 Bradford Street, CHICAGO, ILL.

Shredded Wheat

The Greatest Nerve and
Tissue Builder on
the Market



A Remarkably Wholesome
Breakfast Dish

ENDORSED BY LEADING DOCTORS

THE MARDON CEREAL CO.
Kansas City, Missouri

Domestic

DU MARTE French Perfume

This delicate and rare perfume is made from a secret formula known only to the makers. It is used and endorsed by many of the leading women of Paris and London. Put up in beautifully ornamented bottles it makes a handsome gift for any occasion



Du Marte & Son
New York London Paris

Strathmore Ornament

72 Point

3 A \$6 00 4 a \$4 45 \$10 45

HUNTS Pigeon

60 Point

3 A \$4 50 4 a \$3 40 \$7 90

Mention PRINTS

54 Point

3 A \$4 15 5 a \$3 85 \$8 00

HONEST Demands

48 Point

4 A \$3 50 6 a \$3 50 \$7 00

Beautiful SHOWINGS

42 Point

4 A \$2 85 6 a \$2 85 \$5 70

BURN House

36 Point

4 A \$2 10 7 a \$2 40 \$4 50

Display TUBES

30 Point

6 A \$2 00 10 a \$2 05 \$4 05

RECORD Smashed

24 Point

7 A \$1 55 14 a \$2 00 \$3 55

**DESIGNING SPECIMENS
Manufactured Novelty**

18 Point

11 A \$1 40 22 a \$1 85 \$3 25

**PRODUCES EXQUISITE EFFECT
Secured Honorable Methods**

14 Point

15 A \$1 25 30 a \$1 75 \$3 00

**NEWEST DISTRICT FORMING
Handsome Qualities Within
Greatest General Returned**

12 Point

17 A \$1 20 35 a \$1 55 \$2 75

**PROMINENT QUENTELL SHOWING
Buys Superior Finished Product
Desiring \$1234567890 Figures**

10 Point

24 A \$1 10 48 a \$1 40 \$2 50

**RICHEST GENTLEMAN RETURNED TUESDAY
Reporting Many Magnificent Productions
Special Attention Given Any Short Orders**

8 Point

24 A \$1 00 48 a \$1 25 \$2 25

**GREAT EXCURSION TRAIN WRECKED YESTERDAY
Most Startling Discovery Reported at Princeton
Bewildered Pedestrian in Dreadful Predicament**

6 Point

25 A \$0 90 50 a \$1 10 \$2 00

**SOLICITORS REMAINED SILENT THROUGHOUT PROCEEDINGS
Having Systemized Facilities Aids All Modern Workmen
Greatest Building Contractors Meeting Heavy Reverses
Depositors Drawing \$1234567890 Every Other Century**

SPECIALS

WALL PAPER
DISPLAYS AT
FINK'S

We have for Friday and Saturday of this week another of our unique Wall Paper Displays. Following the plan of our last great showing we will offer ten Specials at very reduced prices. Included in this new stock are several absolutely new ideas in Wall Paper that have not been shown in this country at any time previous to the middle of July when we first placed them on sale

FINK'S BIG STORE
58 UNION STREET

Please Note that New Patterns are Now on Display

Art Ornament Mercantile Border

DECORATION

BUNTING in all the red, white and blue combinations and in different designs at reduced prices until May thirtieth. We also have a big line of American Flags in all sizes and materials that we will close out this week

Bell Dry Goods Co
THE TRAVEL CENTER OF CUSTER CITY AND

Celebration Border

LAWN SUPPER

JULY FOURTH

Kindly fill out blanks on other side regarding number plates wanted and mail

CHARLES TRANSON CARROLLS
CHAIRMAN OF COMMITTEE

Versatile Ornament

54 Point

3 A \$4 45

MUSICAL SKETCH

48 Point

5 A \$3 90

BINDERS RESIGNING

42 Point

5 A \$3 25

NUMEROUS MONKEYS

36 Point

6 A \$2 95

HORSEMEN DISCONTINUE

30 Point

7 A \$2 50

PLEASING NORTHERN HOMES

24 Point

9 A \$2 50

DISTINGUISHED LADIES PROPOSED

20 Point

13 A \$2 25

MEMBERS INDISPOSED
GREAT IMPROVEMENT

10 Point

26 A \$1 40

BASHFUL MAID VISITS DENTIST
DREAMS OF MOTHER AND HOME
SMART STUDENT WRITES POEMS

18 Point

16 A \$2 00

EDUCATED BRIGHT GIRLS
CAGED STRANGE ANIMAL

9 Point

28 A \$1 25

RIVER PIRATES ESCAPED DETECTIVE
SAILORS REFUSED TO OBEY CAPTAIN
FUGITIVES FROM JUSTICE REMANDED

16 Point

19 A \$1 75

HUNTER DISCOVERED FREAK
ROAMING THROUGH KEARNY

8 Point

31 A \$1 25

SHIPWRECK SIGHTED OFF OF FIRE ISLAND
FRANTIC PASSENGERS REMOVED HASTILY
LIFE-SAVING CREW RENDERS HEROIC WORK

12 Point

20 A \$1 50

PRACTICAL MECHANIC PROMOTED
NORTHERN \$1234567890 MERCHANT

7 Point

38 A \$1 25

COUNTRY PRINTER INHERITS ENORMOUS FORTUNE
RICH UNCLE IN CALIFORNIA LOCATED RELATIVES
ENTERTAINS YOUNG FRIENDS IN RURAL DISTRICT
SEVERAL CASES \$1234567890 STILL REMAINING

72 Point

3 A \$5.00 5 a \$3.90 \$8.90

BRIGHT Printing

60 Point

3 A \$1.00 5 a \$1.10 \$7.10

Charming DESIGNS

54 Point

3 A \$3.85 6 a \$3.65 \$7.50

STYLISH Characteristic

48 Point

4 A \$3.15 8 a \$3.10 \$6.25

Cross RIVER

18 Point

13 A \$1.50 27 a \$1.75 \$3.25

GREATEST EXPOSITION
Buy American Ornaments

42 Point

5 A \$2.65 9 a \$2.60 \$5.25

MAKES Engine

14 Point

15 A \$1.40 32 a \$1.60 \$3.00

HISTORICAL CONCEPTIONS
Obtained Our Beautiful Border

36 Point

5 A \$2.20 8 a \$2.05 \$4.25

Helped INDIANS

12 Point

22 A \$1.25 44 a \$1.50 \$2.75

HANDSOME STRUCTURE BURNS
More Lobsters \$1234567890 Secured

30 Point

6 A \$1.90 12 a \$2.10 \$4.00

AMERICAN Captain

10 Point

21 A \$1.20 18 a \$1.30 \$2.50

STRIKING BEAUTIES EXTERMINATED
Unearthing Artistic Specimens in Australia

24 Point

7 A \$1.60 15 a \$1.90 \$3.50

Beautiful FRENCH GIRL

9 Point

26 A \$1.10 58 a \$1.40 \$2.50

OBTAINING PROMINENT WESTERN PRINTER
German Composer Left Jersey City for Texas
Philadelphia Elevated Trainmen Become Tired

20 Point

11 A \$1.55 21 a \$1.70 \$3.25

DEMANDING Manufacturers

8 Point

25 A \$1.00 55 a \$1.25 \$2.25

YOUTHFUL MAIDEN WAITS TABLE IN RESIDENCE
Highest Buildings Shaken by Dynamite Explosion
Charming Poems Written During Summer Cruises

Lining Oldstyle No. 523

24 Point

6 A \$1 90 10 a \$1 60 \$3 50

KENTUCKY RIDER INVITED
Northeastern Police Overtake Thugs

20 Point

7 A \$1 70 15 a \$1 60 \$3 30

JUMPED FROM HIGHER BUILDING
Largest Amphitheatre Destroyed by Cyclone

18 Point

*6 A \$0 50

11 A \$1 65 23 a \$1 60 \$3 25

LIEUTENANT PRESENTED WITH EMBLEMS
Michigan Philanthropist Invented Electric Garden Sprinkler

12 Point

*9 A \$0 50

14 A \$1 30 32 a \$1 45 \$2 75

8 Point

*14 A \$0 50

21 A \$1 10 43 a \$1 15 \$2 25

NEVER FORGETS NAPOLEON
Prehistoric \$1234567890 Animals Seen

MERCHANT DEMANDED EVIDENCE
Salesmen Notified Manager Regarding Prices
Bankers Invite Farmers to Attend Big Outing

10 Point

*14 A \$0 50

18 A \$1 15 40 a \$1 35 \$2 50

6 Point

*18 A \$0 50

22 A \$0 90 52 a \$1 10 \$2 00

DIVERS RECOVERING LOST TREASURE
Sharks and Whales Attacking Nervy Workmen
Port Side of Battleship Bombarded by Enemy

REPORTERS INVESTIGATED NINE CHARGES
Airships Lost in Flight From Philadelphia to Gotham
Game Warden Retires After Twenty Years of Service
Judgment Rendered \$1234567890 Against Rich Banker

*Small Caps for sizes from 6 to 18 Point inclusive are fonted and priced by themselves and only sent when ordered

Lining Oldstyle Italic No. 523

24 Point

6 A \$1 90 11 a \$1 60 \$3 50

FOREIGN AIRSHIP WELCOME
German Contestants Delighted Inventor

20 Point

7 A \$1 60 15 a \$1 65 \$3 25

BREAKING RECORD AT MADRID
Tourist Printers Helped Country Proprietor

18 Point

10 A \$1 70 20 a \$1 55 \$3 25

FRENCHMAN SURPRISED OLDEST KINGS
Spanish Contortionist Amused Massachusetts Chiropodist

12 Point

15 A \$1 35 30 a \$1 40 \$2 75

8 Point

21 A \$1 10 43 a \$1 15 \$2 25

BUILDERS AND ARCHITECTS
Denver Girls \$1234567890 Enter School

SUMMER RESORT LOSING MONEY
Bathers Enjoying Swim at Long Island City
Handsome Combinations Pleased Aristocrats

10 Point

19 A \$1 20 40 a \$1 30 \$2 50

6 Point

22 A \$0 95 49 a \$1 05 \$2 00

STREET MUSICIAN ENTERTAINS TUTOR
Famous Author Exposed Methods of Bank Cashiers
Reformers Speaking Before Tremendous Gathering

ABANDONS LONESOME TOWN FOR YEAR
Burglars Mistake Resident for Watchman and Shoot
Resourceful Cracksmen Escaped From Rubetown Jail
Citizen Offered Reward of \$1234567890 for Their Arrest

Lining Oldstyle Title No. 2

36 Point

3 A \$2 65 6 a \$2 70 \$5 35

PRINTED FINEST Compare Selections

30 Point

4 A \$2 25 6 a \$2 00 \$4 25

HUNTED ELEPHANT Discovering Great Lake

24 Point

5 A \$1 80 8 a \$1 70 \$3 50

PROMISING ORNAMENTS Designed Beautiful Specimen

18 Point

7 A \$1 60 13 a \$1 65 \$3 25

CLEAR BORDERS Modernized Stitcher

14 Point

10 A \$1 40 21 a \$1 60 \$3 00

RECEIVES PROPERTY Extraordinary Statements

12 Point

12 A \$1 25 24 a \$1 50 \$2 75

GRANTING INTERVIEWS Making \$1234567890 Money

10 Point

13 A \$1 10 27 a \$1 40 \$2 50

PROVING GRAND INVESTMENT Detective Headquarters Destroyed

9 Point

14 A \$1 10 30 a \$1 40 \$2 50

OWNER BUYS AMERICAN SERIES Use Comfortable Ocean Going Barge

8 Point

14 A \$1 00 30 a \$1 25 \$2 25

HIGHEST QUALITY PRODUCT SOLD Many Highly Imaginary Stories Printed

6 Point

14 A \$0 90 31 a \$1 10 \$2 00

RAINSTORM CAUSED GREAT RACE TODAY Compositor Defeats Pressman Playing Croquet Hire Delightful \$1234567890 Song Entertainer

DINE AT SMYTH'S

High Class Instrumental
and Vocal Entertainment
by Selected Local Artists



The cleanest
restaurant on
Storm Island

SMYTH

SELECT RESTAURANT
STORM ISLAND, IDAHO

Cloister Border Versatile Ornament

Lining Condensed Title No. 523

54 Point

3 A \$4 60 6 a \$4 30 \$8 90

TOURED Empires

48 Point

4 A \$3 70 8 a \$3 90 \$7 60

Mechanic **SECURED**

42 Point

4 A \$2 95 9 a \$3 30 \$6 25

SUPERIOR Job Printer

36 Point

4 A \$2 35 9 a \$2 65 \$5 00

American **EXPERIMENTS**

30 Point

6 A \$2 15 11 a \$2 10 \$4 25

IMPERCEPTIBLE Measurements

21 Point

8 A \$1 65 16 a \$1 85 \$3 50

GENEROUS BUILDER
Reliable Type Founders

10 Point

17 A \$1 15 38 a \$1 35 \$2 50

THE CONDENSED TITLE HEAD
Progressive Printers Well Stocked
Material Now Cheaper Than Labor
Always Enough Type in the Cases

18 Point

10 A \$1 50 21 a \$1 75 \$3 25

SOUTHEASTERN PRINTS
Atlanta Completely Stocked

8 Point

21 A \$1 05 44 a \$1 20 \$2 25

PROGRESSIVE WORKERS IN THE ART
Demand Originality and Variety in Faces
Meet Varying Tastes and Ideas of Patrons
Wonderfully Beautiful Ornaments Shown

14 Point

14 A \$1 35 29 a \$1 65 \$3 00

MEXICAN PRINTERS DINING
Supply House Getting All Orders
American Type and Gatling Guns

6 Point

25 A \$0 85 52 a \$1 15 \$2 00

ADVERTISING IS THE MOST FORCEFUL SALESMAN
Printing of Taste and Originality the Best Advertising
American Type Designs Combine Taste and Originality
Borders, Ornaments and Brass Rules in Great Variety
Designers Busy on Latest Creations for the Printshop
Grand Occasional Exhibition and Type Demonstration

12 Point

15 A \$1 25 32 a \$1 50 \$2 75

NEWSPAPER PUBLISHERS FACE
For Heads and Display Advertising
Excellent Series for Any Newspaper

5 Point

24 A \$0 85 48 a \$1 15 \$2 00

TYPE SUITABLE FOR EVERY CONCEIVABLE KIND OF PRINTING
Made in Numerous Nicely Graded Sizes and a Great Variety of Faces
Suitable for Advertisements, Commercial, Job and Society Printing
Catalogues, Booklets, Programs, Menus, Announcements, Et Cetera
The Small Sizes are Accurately Cut and Perfectly Fast as the Large
Many of the Largest and Most Important Newspapers Use This Face

72 Point

3 A \$5 60 4 a \$3 65 \$9 25

HUNTED Lizard

60 Point

3 A \$1 30 5 a \$3 40 \$7 70

General CENSURED

48 Point

5 A \$3 25 11 a \$4 25 \$7 50

TREMBLING Lighthouses

36 Point

6 A \$2 45 11 a \$2 55 \$5 00

Beautiful Scenery ENCOUNTERED

24 Point

8 A \$1 65 15 a \$1 85 \$3 50

LARGE PUBLISHERS Elected Their Leader

20 Point

10 A \$1 50 20 a \$2 00 \$3 50

SEVEN HONEST SOLDIERS
Destroying Several Buildings

10 Point

17 A \$1 15 38 a \$1 35 \$2 50

HIRE COURTEOUS POLICEMAN
Newest Creations Constantly Used
Originating Marvelous Machinery

18 Point

13 A \$1 50 24 a \$1 75 \$3 25

HUSKY TOURIST REJECTED
Much American Quality Shown

9 Point

23 A \$1 20 45 a \$1 30 \$2 50

GERMAN SAILOR MAKING SPEECHES
National Emblems Purchased by Woman
Observation Trains Just Passed Through

14 Point

15 A \$1 30 30 a \$1 70 \$3 00

MAKES RELIABLE ORNAMENTS
Complete Printing Office Outfitter

8 Point

20 A \$1 00 40 a \$1 25 \$2 25

WATCH DANGEROUS PERFORMANCES
Mailing Latest Editions with Much Speed
Boston Wire Stitchers Deliver the Goods

12 Point

18 A \$1 25 36 a \$1 50 \$2 75

COMPOSITOR STRAINS BACK TODAY
Record Made \$1234567890 During Game

7 Point

25 A \$1 00 50 a \$1 25 \$2 25

GIRLS DISPLAYING CONSIDERABLE INTEREST
Many Exemptions Stopped at Reno on July Fourth
Broad-Shouldered Negro Gained Great Reputation

11 Point

18 A \$1 25 40 a \$1 50 \$2 75

FISHERMEN CATCH MONSTER PORPOISE
Desperate Desmond was Defied by Rosamond

6 Point

22 A \$0 90 49 a \$1 10 \$2 00

SHOWING FINEST NEWSPAPER HEAD LETTERS
Fancy Printer Gains Great Reputation in Spokane
Many Iron Dollars \$1234567890 and Lead Nickels

LINING TITLE NOS. 524 AND 534

48 Point No. 534

4 A \$5 00

DETERMINED

42 Point No. 534

5 A \$4 50

REBURNISHED

36 Point No. 534

6 A \$3 75

WHISTLE BROKEN

30 Point No. 524

7 A \$3 00

DESIGNING SPECIMENS

24 Point No. 524

9 A \$2 50

TOURIST WRITES HISTORY

20 Point No. 524

9 A \$2 25

GRINDSTONES TURNED ABOUT

18 Point No. 524

11 A \$2 05

NUMEROUS OLD TREES PROSTRATE

16 Point No. 524

11 A \$1 75

TRUCKS FURNISHED
HUNTSMAN RETIRES

11 Point No. 524

18 A \$1 45

CLEARs ARMY MYSTERY
CENSURES LIEUTENANT
SMOKE CHEAPER CIGAR

14 Point No. 524

15 A \$1 75

INDIAN FIRING RIFLES
MISSED CLUB RECORD

10 Point No. 524

21 A \$1 45

SHOW HIGHEST QUALITY
TEMPEST CAUSING SCARE
AGENT GRANTED CLAIMS

12 Point No. 524

17 A \$1 50

MISER BOUGHT WEAKFISH
SPENT \$1234567890 HER TIME

9 Point No. 524

22 A \$1 30

BUYING HUNDRED BUILDINGS
SPACE CASES SORTED FRIDAY
MOUNTAIN SCENERY CHARMS

30 Point

5 A \$2 05 9a \$2 20 \$1 25

LIKED MERCIFUL JUSTICE
Government Pensions Artists

24 Point

6 A \$1 85 10a \$1 70 \$3 55

SOLDIER HELPING FIREMEN
Inventor Explained New Schemes

20 Point

7 A \$1 65 13a \$1 60 \$3 25

PRODUCERS BOUGHT GROCERIES
Eloquent Statesman Cautioned American

18 Point

9 A \$1 60 16a \$1 65 \$3 25

OLDER COMEDIANS
Hundreds Enjoy Drama
Useful Lightface Pleases

10 Point

16 A \$1 15 32a \$1 35 \$2 50

WYOMING PHILOSOPHERS
Confident Athlete Overtaken
Poet Instructs Young Writer

8 Point

17 A \$1 00 35a \$1 25 \$2 25

MINSTREL SHOW RENTS HOTEL
Quiet Teacher Expels Noisy Pupil
Foreigner Surprised Old Chemists

12 Point

15 A \$1 30 30a \$1 45 \$2 75

REQUIRED BEAUTIFUL FACES
Farmers Delighting City Gardener
Ideal Resting Places Near Gotham
Bequeathed \$1234567890 to Sports

6 Point

20 A \$0 95 39a \$1 05 \$2 00

BINDERS HOLD NINTH ANNUAL PICNIC
Stern Gentleman Questioned Learned Sister
Physical Instructor Takes Dip in the Briny
Great Mansions \$1234567890 Destroyed Here

LINING TITLE No. 551

24 Point

8 A \$2 50

KIDNAP MIRTHFUL GIRLS

20 Point

9 A \$2 25

FOUND MORE ANTIQUE TYPE

18 Point

9 A \$2 00

KINDEST PEOPLE
ABLEST WRITERS

12 Point

14 A \$1 50

REBUILD FOLDERS
BUY \$1234567890 TIN

14 Point

12 A \$1 75

EXPERT LOCKSMITH
PUBLISHER RETIRES

10 Point

17 A \$1 40

INJURED YOUNG LIONS
STOLE BRONZE TABLET
NORTHERN PHYSICIAN

Lining Open Title No. 520

14 Point

9 A \$1 35 21 a \$1 65 \$3 00

DESIRING AMERICAN OPEN TITLE SERIES
Strikingly Beautiful Creation Presented Critic

12 Point

11 A \$1 25 25 a \$1 50 \$2 75

MAKING FINEST BORDER
Buying Splendid Ornaments
Figures \$1234567890 Pleased

8 Point

16 A \$1 05 36 a \$1 20 \$2 25

ARTIST DESIGNED SPECIMENS
Rapid Composition During Contest
Participants Acknowledged Judge
Stylish Gowned Women Spectators

11 Point

15 A \$1 30 32 a \$1 45 \$2 75

SECURE STRONG BLACKSMITH
Appreciate Marvelous Undertaking
Husky Boilermakers Working Hard

7 Point

21 A \$1 10 44 a \$1 15 \$2 25

DEMOLISH GRAND HEALTH RESORT
Cyclone Strikes with Untold Fury Yesterday
Destroys Forests and Orchards Stricken Bare
Newspaper Prints Several Columns of Items

10 Point

15 A \$1 20 31 a \$1 30 \$2 50

STOCK EXCHANGE IMPROVING
Beautiful Electrical Displays Shown
Throws Circus Rider During Parade

6 Point

20 A \$1 00 42 a \$1 00 \$2 00

TOURIST PRINTER BECOMES RESTED
Covers First Hundred Miles Before Lighting
Aeroplane Destroyed by Contrary Air Waves
Hours Dreaming \$1234567890 Costs Money

9 Point

18 A \$1 15 40 a \$1 35 \$2 50

SAILOR ERECTED HIGHEST BUILDING
Finest Quality Reigns Supreme Throughout
Delightful Excursion Entertained Delegates

5½ Point

20 A \$0 90 40 a \$1 10 \$2 00

MODERN PRINTERS INTERESTED PUBLISHER
Detectives Pursued Chinaman Through Central Park
Courteous Fishermen Gave Many Lobsters to Public
Dancing Master Returned Unclaimed Cheap Jewelry

Lining Condensed Title No. 524

14 Point

15 A \$1 40 29 a \$1 60 \$3 00

ENTERTAINERS HEARTILY WELCOMED BY AUDIENCE
American Quality Standing Tests Against European Competitors

12 Point

16 A \$1 35 32 a \$1 40 \$2 75

HUNDRED SOLDIERS CAPTURE DESPERATE BORDER BANDIT
Specimen Artist Received Diamond Medal While at Rockaway Beach

11 Point

17 A \$1 35 38 a \$1 40 \$2 75

DESTROYS FEDERAL GOVERNMENTS
Beautiful Maiden Created Great Sensation
Useful Figures \$1234567890 Count Them

8 Point

21 A \$1 10 43 a \$1 15 \$2 25

FOREIGNER OBTAINS KNOWLEDGE
Japanese Butler Fought Russian Cossack
Panama Canal Being Dredged Continually
Smken Vessels Raised in Havana Harbor

10 Point

17 A \$1 15 37 a \$1 35 \$2 50

KINGS OFTEN VISITED HOT SPRINGS
Great Farming Lands Opened in Montana
American Type Founders Company Faces

7 Point

24 A \$1 05 50 a \$1 20 \$2 25

PORTLAND MULTIPLE PUNCHING MACHINES
Expert Physical Instructors Training Composer
Big Heavyweight Wrestler Raced Freight Train
Youthful Acrobat Performs Great Muscular Feat

9 Point

21 A \$1 20 45 a \$1 30 \$2 50

ORGANIZE RHODE ISLAND CLAM BAKERS
Long-Haired Historian Doubt Famous Astrologist
Astronomy Students Prepared Stories on Comets

6 Point

25 A \$0 90 48 a \$1 10 \$2 00

BUYS BOSTON WIRE STITCHING MACHINES
Young Operator Attended Annual Entertainment
Sporty Printer Escorts Fairest Damsels Saturday
Spending Pay \$1234567890 While Riding Ponies

Lining Boldface No. 520

12 Point

12A \$1 25 26a \$1 50 \$2 75

**DELEGATES RECEIVED INSTRUCTION FROM LOCAL
Prominent Enthusiastic Southern Statesman Corresponds
Usual Interest Paid \$1234567890 Rather Small Depositor**

11 Point

16A \$1 30 31a \$1 45 \$2 75

**SECRET SERVICE FORCE TAKING EXTRAORDINARY PRECAUTION
Detective Sherlocko Discovers Several Undesirable Citizens in Westport
Considerable Excitement in Europe Caused by Great Coronation Parade**

10 Point

15A \$1 15 32a \$1 35 \$2 50

**UNSOPHISTICATED FARMER DECIDES TO VISIT NEW YORK CITY
His Description of the Wonderful Sights Interested Numerous Relatives
Young Man Returns and Finds Old Homestead Devoid of Real Pleasure**

9 Point

18A \$1 15 38a \$1 35 \$2 50

**FIERCE STORM SWEEPS NEWARK BAY
Ten Lives Lost and Narrow Escapes Reported
Grave Fear Felt for Missing Pleasure Parties**

6 Point

20A \$0 90 42a \$1 10 \$2 00

**MYSTERIOUS OLD LADY CREATES SCENE
Finally Subdued After Struggle With Firemen
Disastrous Conflagration Demolishes Institute
Ruined Building Will be Rebuilt Immediately**

8 Point

16A \$1 05 32a \$1 20 \$2 25

**LIGHTNING STRIKES BRASS FOUNDRY
Feather Factory Blown Seven Hundred Miles
Handsome Penitentiary Completely Wrecked**

5½ Point

18A \$0 90 38a \$1 10 \$2 00

**FAMOUS AMERICAN DESIGNER RETURNS
Honorable Mention Received in Foreign Land
Clearly Explained Rare Italian Marble Design
Refused Permanent Position with Noted Artist**

7 Point

20A \$1 05 44a \$1 20 \$2 25

**MANY SHIP PASSENGERS IN CONSTANT DREAD
Captain Finally Succeeds in Quieting Excited Throng
Eminent People Preparing for European Celebration**

5 Point

16A \$0 95 36a \$1 05 \$2 00

**MAGNIFICENT SCENERY ALONG THE HUDSON
Visitor to West Point Delighted with Pleasing Sights
Sunday Excursions Enjoyed by City Working People
Young Inventors \$1234567890 Received Large Sum**

Lining Boldface Italic No. 520

12 Point

12A \$1 25 26a \$1 50 \$2 75

***MUSICAL FESTIVITIES INTERESTED NOBLEMAN
Recent Reductions in \$1234567890 Big Department Store***

11 Point

15A \$1 25 31a \$1 50 \$2 75

***STRIKING METHOD USED BY MONSTER PRINTING CONCERN
Disruption Throughout Entire State Considered Detrimental to Politics
Several Defeated Candidates Hastily Demand Thorough Investigation***

10 Point

14A \$1 15 30a \$1 35 \$2 50

***SUPREME COURT DECISION SETTLED LENGTHY ARGUMENT
Many Celebrated Lawyers Listened Very Attentively to Technical Points
Interested Students Amazed at Unusual Clerer Demonstration Advanced***

9 Point

18A \$1 20 38a \$1 30 \$2 50

***ATHLETIC SPORTS FOR YOUNG LADIES
Exercises Very Beneficial in Summer or Winter
Newark High School Girls Form Driving Club***

7 Point

16A \$1 00 40a \$1 25 \$2 25

***IRISHMAN DISCOVERS NORTH POLE
Relates Strange Experience to Chinaman
Numerous Explorers Question Discovery
Examination of One Chart Proves Claim***

8 Point

16A \$1 00 35a \$1 25 \$2 25

***BOY RETURNED IMPORTANT RECORDS
City Officials Denounce Methods Used by Police
German Band Played Latest Hungarian Tune***

6 Point

20A \$0 95 42a \$1 05 \$2 00

***PROMINENT CITIZENS CHEER SOLDIER
Defended Bravery Sixth Regiment's Reputation
Brave Young Hero Escapes Through Open Fence
Large Rewards \$1234567890 Paid for Bravery***

Lining Regal Italic No. 2

18 Point

7 A \$1 55 14 a \$1 70 \$3 25

*EIGHT MEDICAL STUDENTS RACE
Presents Greatest Electrical Discovery*

14 Point

11 A \$1 45 21 a \$1 55 \$3 00

*BEAUTIFUL PRINTING FROM REGAL ITALIC
Graceful Women Parade Concourse Every Night
Midnight Serenaders Arouse Handsome Mothers*

12 Point

13 A \$1 30 25 a \$1 45 \$2 75

*WHIP STORMING KNIGHTS
Stronger Prince Leading Battle
Demands \$1234567890 Thinker*

8 Point

18 A \$1 10 35 a \$1 15 \$2 25

*USING PRINCIPAL INDICTMENT
Highest Chimney Shaken by Winds
Piano Movers Playing Lawn Tennis
Beating Freight Trainmen a Lost Art*

10 Point

17 A \$1 25 35 a \$1 25 \$2 50

*CRUISER MAINE AGAIN IN BOSTON
Eastern Traveler Killed on High Ledge
Boy Scouts Appear at Brooklyn Circus*

6 Point

19 A \$0 95 39 a \$1 05 \$2 00

*EXQUISITE AND DIGNIFIED ORNAMENT
Boston Wire Stitchers are Exclusively Used
Freight Train Crossing Panama Very Slowly
Large Shipment \$1234567890 Started North*

LINING VICTORIA ITALIC

24 Point No. 552

6 A \$2 50

DESIGNED SPECIMENS

20 Point No. 552

9 A \$2 35

*RESHIPMENT
FINDS HOUSE*

12 Point No. 554

24 A \$1 50

*GUARDS CAPTURING JAILBIRD
SENTENCE FINE SAFE BLOWER
COMPOSITOR DEMANDS WORK*

18 Point No. 552

9 A \$2 00

*DISTINGUISHING
STRIKE HARDER*

6 Point No. 551

20 A \$1 00

*SIX SPANISH DANCERS WERE KILLED
ENGLISH SOLDIERS WON FIRST GLORY
AUTOMOBILE INJURES WILD ANIMALS
FINISH FINE \$1234567890 TEXT BOOKS*

12 Point No. 551

12 A \$1 50

*EXQUISITE BEAUTIES
FINE \$1234567890 PAID*

6 Point No. 552

22 A \$1 00

*CAPTURE WILD MAN NEAR AMAZON RIVER
HAPPY LOVERS STROLLED HOLDING HANDS
TELLS MARVELOUS EXPERIENCES NIGHTLY
ENTERTAINS NATIVES WITH AWFUL TALES*

12 Point No. 552

16 A \$1 50

*EXPERIENCED TEACHERS
CANDIDATE FOR SHERIFF*

6 Point No. 553

29 A \$1 00

*SIXTY YOUNG COUNTRY PAINTERS WIN PRIZES
THOUSANDS OF VISITORS WERE AT CORONATION
LEADING PRINTERS HAVE BOUGHT THIS OUTFIT
BENEFICIAL CHANGES WERE CONSTANTLY MADE*

12 Point No. 553

19 A \$1 50

*DUPLICATED EVERY MOVEMENT
BURNING CLUBHOUSE TUESDAY*

6 Point No. 554

30 A \$1 00

*GATHERING BEAUTIFUL MAGNOLIAS IN LOWER GEORGIA
CHARMING SCHOOL TEACHER HELD DELIGHTFUL PARTY
LUMBERMEN WORKED IN MICHIGAN UPPER PENINSULA
SOUTHERN GENTLEMEN TRAVEL MILES ON STEAMBOAT*

Lining Law Italic No. 522

18 Point

10A \$1.20 20a \$1.50 \$3.00

DEMANDS CONFERENCE OF STOCKHOLDERS AND VICTIMS
Simple Country Gentleman Mourning Loss of Savings for Automobile
New Jersey Constable Hoodwinked by Notorious Philadelphia Thief
Victim Claims He Was Relieved of Five Dollars in American Money

12 Point

16A \$1.30 37a \$1.45 \$2.75

RAINSTORM STRIKES SOUTHERN CITY
Many Homes Totally Destroyed by Cyclones
Louisiana Town Nearly Blown Into the Gulf
Women and Children in Panic as Rain Falls
Farmer Loses \$1234567890 in Nightmare

8 Point

21A \$1.00 54a \$1.25 \$2.25

BRITISH COMEDIANS ENGAGED YESTERDAY
Will be Seen in Their Twelve Latest Farce Comedies
Every Prominent Actor Made Bids for Reserved Box
Several Policemen Keep Impatient Jesuits in Line
Hunan Line Seven Blocks Long Awaits Ticket Seller
Orchestra Chorus Selling at Seventeen Dollars Apiece
Chorus Contains Many Famous Railroad Conductors

10 Point

18A \$1.15 16a \$1.35 \$2.50

COMANCHE INDIANS INITIATE TENDERFOOT
Western Individual Treated Kindly by Young Braves
Lucky Paleface Finally Elopes with Handsome Squaw
Big Chief Sitting Dog Offers Much Wampum for Furs
More Rifle Practice Ordered in Anticipation of Battle
Rusty Tomahawks Will Surely Do Service This Friday

6 Point

25A \$0.90 60a \$1.10 \$2.00

GERMAN SOLDIER LEADING GREAT MILITARY PARADE
One Hundred School Children Review Longest Line Ever Seen
Beautiful Trained Horses Delight Four Thousand Spectators
Versatile Drum Major Performs Startling Feats with Baton
Stupid Teamsters Injured Twelve Innocent Candy Merchants
Two Pitchpockets Reap Harvest as People Jostle One Another
Armed Highwayman Chased Through Crowd by Opera Singer
Mad Canines Caused Panic Among Bystanders Near Library
Jaytown Citizens Lost \$1234567890 at the Leading Hotel

Lining Law Italic No. 520

11 Point

13A \$1.40 26a \$1.60 \$3.00

SEVEN ENTERPRISING DOCTORS TOURING ICELAND
Expert Physicians Gone to Search for the Famous Cold Spring
Authority Says Discovery Will Prove Boon to Bald Headed Men
One Experiment on Billiard Ball Satisfied Doubting Thomases

12 Point

16A \$1.25 32a \$1.50 \$2.75

UNITED STATES CRUISER RETURNS AFTER LONGEST VOYAGE
Jackies Related Thrilling Experiences on Board Ship During the Storms
Young Mascot Jumped Overboard as Giant Cruiser Neared Eastern Port
Admiral Promoted Ambitious \$1234567890 Boston Youth Last Thursday

10 Point

17A \$1.15 10a \$1.35 \$2.50

BLACKSMITH CHLOROFORMS PANTHER
Jungle Beast Overpowered After Game Combat
Continuous Roaring Brought Out County Clerk
Officers of Law Sought Circus Manager in Vain
Bear Cheers Rubber Bars in Rear of Big Wagon

8 Point

20A \$1.00 40a \$1.25 \$2.25

FREIGHT TRAIN STRIKES BUCK DANCER
Young Engineer Sleeps at Critical Moment
Railroad President Discharged Strong Boy
Superintendents Cautioned All Employees
Deaf Fireman Heard Whistle Shriek Twice
Englishmen Defended Unfortunate Victim

Prices for Circular Fonts Lining Law Italic No. 520

8 Point	20A \$1.00	115a \$3.65	\$4.65	12 Point	16A \$1.10	90a \$3.85	\$5.25
10 Point	17A \$1.25	110a \$3.90	\$5.15	11 Point	13A \$1.55	81a \$1.80	\$6.35

72 Point

4 A \$4 80 6 a \$4 55 \$9 35

HANDSOME Department

60 Point

4 A \$4 05 6 a \$3 55 \$7 60

DECLINES INTRODUCTION
Reproduction Unsatisfactory

48 Point

5 A \$3 05 9 a \$3 20 \$6 25

CHAMPION WRESTLER THROWN
Brawny Blacksmith Captures Title

36 Point

5 A \$2 10 9 a \$2 15 \$4 25

COMBINATION OFFER
Higher Position Secured

18 Point

15 A \$1 40 31 a \$1 85 \$3 25

SEVERAL BEAUTIFUL CREATIONS
Remarkable Improvements Proposed
Elected Bright and Enterprising Men
Prominent Ladies Arrange Exercises

30 Point

7 A \$2 05 11 a \$1 95 \$4 00

WEARY WILLIE RESTED
Absolutely Declined Work

12 Point

21 A \$1 25 42 a \$1 50 \$2 75

ILLUSTRATED ADVERTISEMENT ACCEPTED
Marvelous North American Harpooner Rescued
The Submerged Object Wrecked the Rambler
Unusual Large \$1234567890 Money Advanced

24 Point

9 A \$1 65 18 a \$1 90 \$3 55

KIND OLD LADIES OFFER ALMS
But the Wood Remains Unchopped

10 Point

23 A \$1 10 46 a \$1 40 \$2 50

PRACTICAL DESIGNING DISPLAYED THROUGHOUT
Ingenious Composer Invents Wonderful Demijohn
Large Concerns Kept Busy Supplying Great Demand
Several Wealthy Chinamen Purchase Rice Industry

30 Point

1 A \$1 90 9 a \$2 35 \$4 25

SHOW MODERN DESIGN
Display Feature Exquisite
Charters Swiftest Cruiser

24 Point

5 A \$1 55 11 a \$1 95 \$3 50

SECOND PRESIDENT RETIRING
Dreamland Lion Captured Friday
Bravest Policemen Hunt Fugitive

18 Point

8 A \$1 50 18 a \$1 75 \$3 25

SOLDIERS ENDURED MANY HARDSHIPS
Heavy Marching Order Comes from Major
Bugle Sounded General Muster Repeatedly
Knapsacks and Blankets Carefully Packed

14 Point

13 A \$1 40 27 a \$1 60 \$3 00

NIGHT EDITORS EDUCATED
Time Rapid Vaudeville Singers
Railroad Detective Chased Men
Guards Plunder Fine Buildings

8 Point

15 A \$1 00 32 a \$1 25 \$2 25

SEARCHING PARTY RETURNS
Youngsters Taken by Policemen
Lost Children Found Near Woods
Slept Beside Monument of Kelley
Boston Newspapers Giving Facts
Receives Liberal Reward Monday

12 Point

13 A \$1 25 29 a \$1 50 \$2 75

HUNTERS CAPTURED QUAILS
Buffalo Pursued While Browsing
Chasing Foxes Through Meadow
Spending \$1234567890 Fortune

6 Point

16 A \$0 90 37 a \$1 10 \$2 00

TINSMITH WROTE TOUCHING STORY
Describing Life Among the Norwegians
Resident Pictured Beyond Comparison
Scene Based Upon Historical Thoughts
Enormous Demands Received Tuesday
Love and Pathos Played Important Part
Brought \$1 234567890 and Five Cents

10 Point

14 A \$1 10 29 a \$1 40 \$2 50

NOTORIOUS BURGLAR SUBDUED
Brave Constable Shackled Criminal
Safeblower Defied Brutal Detective
Country Gentlemen Arousing Jailer
Judge Found Nervy Prisoner Guilty

5-on-6 Point

21 A \$0 90 48 a \$1 10 \$2 00

PRINTING INDUSTRY BECAME WONDERFUL
American Type Founders Company Ornament
Produce Only Finest Borders and Brass Rules
Charming Typographical Characters Observed
Exquisite Featuring Abound Throughout Output
Known as Complete Printing Office Outfitter
Every Device Originated Benefits Entire Craft

42 Point

3 A \$3 00 7 a \$3 25 \$6 25

STRANGE HOUSE Trains Fierce Lion

36 Point

3 A \$2 00 6 a \$2 50 \$5 10

RETURNS FORTUNE Hunter Injured Tiger

30 Point

4 A \$2 05 8 a \$2 20 \$4 25

DESIGNER CENSURED Learned Counsel Advises

24 Point

5 A \$1 65 9 a \$1 85 \$3 50

PICKED FOR LEADING ACTS Graduated From Third School New England Printer Retired

18 Point

7 A \$1 60 12 a \$1 65 \$3 25

EXCITED CROWD Boys Studied Law Southern Captain

10 Point

15 A \$1 10 31 a \$1 40 \$2 50

PRECIOUS GEMS STOLEN Eight Midstrels Entertained Desirable Citizens Organized Speaker Charmed Publisher Dynamiting Historic Bridge

14 Point

11 A \$1 45 24 a \$1 55 \$3 00

REMARKABLE BEAUTY Third Annual Shore Dinner Journeys Through Scotland

8 Point

20 A \$1 05 44 a \$1 20 \$2 25

LIGHT OPERA SINGER RETURNED Young Duke Rewards Lady for Honesty Desperate Thief Caught by a Policeman Californian Befriended Former Citizens Famous Theatre Manager Weds Beauty

12 Point

13 A \$1 30 25 a \$1 45 \$2 75

FAMOUS CIRCUS ACROBAT Wild Animals Inhabited Jungle Splendid \$1234567890 Cooking

6 Point

17 A \$0 90 42 a \$1 10 \$2 00

RECEIVED TWO THOUSAND MESSAGES Inspector to Condemn Largest Fire Trap Contains Attractive and Beautiful Ideas Producing the Highest Grade of Printing Aeronaut Made \$1234567890 Flight in Air

72 Point

3 A \$6.90 3 a \$1.00 \$10.90

HERD Seized

60 Point

3 A \$5.40 4 a \$3.90 \$9.30

Clear DRINKS

48 Point

3 A \$4.05 5 a \$3.45 \$7.50

DESIGN Producers

42 Point

4 A \$3.00 8 a \$3.30 \$6.30

Singular COINCIDENT

36 Point

4 A \$2.50 8 a \$2.65 \$5.15

MARVELOUS Coal Product

30 Point

6 A \$2.10 12 a \$2.15 \$4.25

Copyrighting DISTINCT PRINTS

24 Point

7 A \$1.75 12 a \$1.80 \$3.55

CONSTRUCTS TOWER Makes Exquisite Series

10 Point

17 A \$1.05 34 a \$1.45 \$2.50

ENTERTAINING RICHER CHILDREN
Practical Knowledge of Operation
Handsome Scholar Returned Home
Buy Useful Labor-Saving Material

18 Point

10 A \$1.45 22 a \$1.80 \$3.25

NIGHT RIDERS DISPERSING Great Labor-Saving Machines

8 Point

18 A \$1.00 36 a \$1.25 \$2.25

WITNESSED GREAT ACROBATIC FEAT
Produces Wonderful Electric Display
Containing Distinct Original Qualities
Stylish Modern Antique Repays Buyer

12 Point

15 A \$1.20 32 a \$1.55 \$2.75

BEFRIENDS MAGAZINE PUBLISHING More Harmonious Musical Selections Superintend \$1234567890 Erections

6 Point

20 A \$0.90 40 a \$1.10 \$2.00

AMERICAN TYPE SPECIMENS INTERESTING
Job Printers Readily See Attractive Feature
The Craft Realizing the Artistic Possibilities
Wheel of Progress Kept Turning Every Hour
Bankers are \$1234567890 Always Welcomed

ENGRAVERS BOLD

36 Point

3 A \$4 05

CHAMPIONS
MINEHURST

30 Point

4 A \$3 10

QUICK PRINTS
TIRED WOMAN

24 Point

5 A \$2 50

SOMETHING SOLID
HOUSE WRECKING

18 Point No. 2

7 A \$2 00

RESUMING OPERATIONS
TAPESTRIES EXHIBITED

18 Point No. 1

8 A \$2 00

VERY HARMONIZING BORDER
STUPENDOUS UNDERTAKINGS

12 Point No. 3

10 A \$1 50

TEACHER PRAISED
AMERICAN PUBLIC

6 Point No. 4

20 A \$1 00

MUSIC RENDITIONS ARE PLEASANT
LARGE DELEGATIONS ENTERTAINED
GREAT ACHIEVEMENTS IN PRINTING
KINDLY ATTENDING OUR RECEPTION

12 Point No. 2

12 A \$1 50

GENERAL REDUCTIONS
ORNAMENTAL BORDER

6 Point No. 3

27 A \$1 00

MONSTROSITY CAPTURED WHILE EXPLORING
NOW EXPECTING SCIENTIFIC EXAMINATIONS
BEAUTIFUL SOUVENIRS PRESENTED VISITORS
CREATIONS OF ARTISTIC PRINTER DISPLAYED

12 Point No. 1

17 A \$1 50

RELIABLE HOME PRODUCTION
BEAUTIFUL FOR THE PRINTER

6 Point No. 2

30 A \$1 00

RATHER EXTRAORDINARY MECHANICAL RESOURCES
GIVING NUMEROUS REPORTS CONCERNING BANKERS
DEMONSTRATION FAVORABLE TO LATEST INVENTION
REMARKABLY INCREASED POPULATION REGISTERED

6 Point No. 5

16 A \$1 00

FOUR BEAUTIFUL BUILDINGS ERECTED
HANDSOMELY ENGRAVED INVITATIONS
GENEROUS PEOPLE PROPOSED DINNER

6 Point No. 1

34 A \$1 00

PROFESSOR RANDOLPHUS WEISENHEIMER TALKS AT LENGTH
INTERESTING DISCOURSE CREATED GENERAL EXCITEMENT
HE STUDIED POLITICAL ECONOMY INDUSTRIOSLY AND FAILS
PRODUCED RESULTS WITH PROMINENT AMERICAN PRODUCTS

ENGRAVERS BOLD

FRANKLIN TRAINING SCHOOL

MISS BEATRICE FITZHUBERT
PRINCIPAL

TERM
SEPTEMBER 1ST TO JUNE 30TH

IF NOT DELIVERED IN FIVE DAYS
RETURNS TO
MISS BEATRICE FITZHUBERT
LOCK BOX 283
EAST ROCKLAND, ME.

MISS BEATRICE FITZHUBERT

PRINCIPAL
FRANKLIN TRAINING
SCHOOL

157 GRANT BOULEVARD
ROCKLAND, ME.



GRADUATING EXERCISES

M

YOU ARE INVITED TO ATTEND THE
GRADUATING EXERCISES OF
KINGSBRIDGE PREPARATORY SCHOOL
WEDNESDAY EVENING, JUNE ELEVENTH
NINETEEN HUNDRED AND TWELVE
AT EIGHT O'CLOCK
IN PHI DELTA NORMAL HALL.

PLEASE PRESENT THIS CARD AT THE DOOR

CARD MERCANTILE

30 Point No. 10

5 A \$3 25

REDUCED STOCK
QUICK PRINTERS
STUNG BUTCHER

24 Point No. 9

5 A \$2 50

EJECTING FRIENDS
STUDIED QUESTION
LOST MINES FOUND

18 Point No. 8

7 A \$2 10

NINE PROMINENT MEN
IMPROVED SCULPTURE
REMARKABLE FLIGHT

12 Point No. 7

10 A \$1 50

CLEVER SCHEMER
MECHANIC HIRED
SPEND \$1234567890

6 Point No. 4

16 A \$1 05

MEP SATISFIED GENTLEMEN
DISPLEASED CHEMIST WEPT
GROTESQUE DESIGN SHOWN
SWIFT MAIL CLERK PLEASES

10 Point No. 6

13 A \$1 45

POPULAR MAN DYING
INDICT FIVE BROKERS
EXAMINES HUCKSTER

6 Point No. 3

17 A \$1 00

NICE AND LEGIBLE CHARACTER
SWEETER MAGNOLIAS IN BLOOM
ACTORS ENJOY ANNUAL DINNER
MICHIGAN \$1234567890 FARMERS

8 Point No. 5

16 A \$1 25

BEAUTIFUL GRANITE MANSION
SEVERAL INVENTIONS BOUGHT
DUKE INVITES ELEVEN BARONS
ONE HOMELY WOMAN PRESENT

6 Point No. 12

22 A \$1 00

CHARITABLE SOCIETY ELECTS OFFICERS
COMEDIAN ENTERTAINS THIRTY WOMEN
PREHISTORIC ANIMAL RECENTLY FOUND
BURGLARS RANSACKED NEW MANSIONS

6 Point No. 11

30 A \$1 00

REPUTABLE PHYSICIAN DISCOVERS LOST TREASURES
COLLEGE FACULTY DISCIPLINE ATHLETIC INSTRUCTOR
REMARKABLE DEMONSTRATIONS CONVINCED BUYERS
MONSTER BENEFIT PROVIDES WONDERFUL ATTRACTION
GOVERNMENT AUTHORITIES INVESTIGATING MATTER

CARD MERCANTILE IN DISPLAY

MERK & CRONIN

CASTURNS
FOR LAWNS AND
CEMETERIES



WE FURNISH
SPECIAL DESIGNS
PROMPTLY

FAIRVIEW AND OAKWOOD STREETS
MUNROE, OHIO

BRANCH OFFICES
ALBANY CHICAGO PORTLAND ST. LOUIS BOSTON

GEORGE HENDER

CHARLES L. ROMINE

HENDER & ROMINE BONDS

MORTGAGES, SECURITIES

ROOM 23
TITLE BUILDING

31 MERCER STREET
BALTIMORE



OAK TAVERN

OAKWOOD BOULEVARD
ACORN, OHIO

WINES

	QTS.
DUNN'S EXTRA DRY	\$4.00
IMPORTED BURGUNDY	3.75
PUNCH CHARTRUSE	3.00
ROMAN PUNCH	3.75
CANADIAN COGNAC	3.50
SAUTERNE	3.00
SHERRY	3.00
MOSEILLE	2.50

CIGARS

CUBA DE PERFECTO	\$0.50
LA ROSA PUERTO RICO50
PRIDE OF HAVANA50
OAK TAVERN SPECIAL50
HOTTIAN HOUSE25
KEY WEST BOUQUET25

CLASS EXERCISES

MISS MAZIE ROXTON'S SCHOOL

YOU ARE CORDIALLY INVITED TO ATTEND
THE CLASS EXERCISES FROM TWO
TO FIVE O'CLOCK P. M.

WEDNESDAY, JUNE 30TH

IN THE CLASS ROOM

10 CHESTNUT ST.

PHILADELPHIA

MERCANTILE BOLD

48 Point

3 A \$5 00

FOREIGNER

36 Point

5 A \$4 00

RIGHT NUMBER

24 Point

6 A \$3 00

AMERICAN PRODUCT

20 Point

9 A \$2 25

PRODUCES DISTINCT SERIES

18 Point

10 A \$2 05

RIGHTEOUS \$1234567890 MANAGER

MERCANTILE SERIES

16 Point No. 29

10 A \$1 75

COMPETING PRINTERS HARMONIZE
EASTERN EXCURSIONISTS RETURN

14 Point No. 28

13 A \$1 75

DESIGNS NEW TYPES
CLOSE NEGOTIATION

8 Point No. 24

18 A \$1 25

GOVERNMENT ISSUED ORDERS
INGENIOUS BAKING MACHINES
CONFECTIONERS REMARKABLE
PURCHASE MERCANTILE TYPE

12 Point No. 27

12 A \$1 50

SIMPLE FACTS KNOWN
GETS \$1234567890 COIN

6 Point No. 23

21 A \$1 00

BOSTON WIRE STITCHER IS POPULAR
INVALUABLE AS GOOD PROFIT MAKER
ALL BINDERS RECOGNIZE ITS MERITS
REGULATED \$1234567890 TIME CLOCK

12 Point No. 26

15 A \$1 50

MOST NOTORIOUS FAMILY
VENTILATING APPLIANCE

6 Point No. 22

26 A \$1 00

THE UNITED SOCIETIES OF GLORIOUS ORDERS
MIDNIGHT SUBURBANITES ELECTED ANOTHER
DELEGATE TO THE SEMI-ANNUAL CONVENTION
RECEPTION COMMITTEE EXTENDED WELCOME

10 Point No. 25

18 A \$1 40

REVEAL UNPLEASANT TIDINGS
EIGHTEEN MILLIONS INVESTED

6 Point No. 21

35 A \$1 00

LUXURIOUS APARTMENT APPROPRIATED BY THE SONGBIRDS
INTERESTING ARTICLE PUBLISHED IN FOREIGN PERIODICALS
DELIGHTFUL SERIES OF CONCERTS GIVEN IN CENTRAL PARK
ARTIFICIAL LAKE SURROUNDED BY FRAGRANT GERANIUMS
SOME NATIONAL INSTITUTIONS MAKE PAYING ENTERPRISES

LINING COPPERPLATE ROMAN

10 Point No. 555

17 A \$1.40

HANDSOME RECEPTIONS
BRIGHT DESIGN SOUGHT
CONVINCING QUESTIONS
GOME 81234567890 HOME

8 Point No. 554

16 A \$1.25

BRIGHT COPPERPLATE EFFECT
ENGRAVERS WORK IMITATED
DESIRE ARTISTIC PERFECTION
CHARMING SCENERY VIEWED
USEFUL Q R S & T CHARACTERS

LEADER MODES

MRS CHARLES BRICE

STYLISH DRESSMAKER

NO. 1211 SOUTH EIGHTH STREET
AUSTIN, MISSOURI

THE NATIONAL ARTS CLUB OF KANSAS



GRANT THE HONOR OF YOUR COMPANY IN THE GALLERIES OF THE ASSOCIATION AT NUMBER TWENTY SEVEN NORTH CLEVELAND STREET, BETWEEN TWO AND SIX IN THE AFTERNOON OF JANUARY NINETEENTH, AND BETWEEN SEVEN AND TEN IN THE EVENING OF JANUARY TWENTY, TO VIEW AN EXHIBITION OF LANDSCAPE SCENES SKETCHED BY SOME OF THE MOST NOTED ARTISTS OF THE COUNTRY. THE PROCEEDS OF THE EXHIBITION WILL BE DEVOTED TO FURTHERING THE ART EFFORTS OF STUDENTS IN OUR LOCAL EDUCATIONAL INSTITUTIONS, WHERE MUCH EVIDENCE OF REAL TALENT HAS BEEN DISCOVERED. TICKETS MAY BE SECURED

HERMAN J. RUTHERFORD, JR.
MORTON R. VANDERGOULD
RICHARD M. CREGGTON

Old English Border — Dutch Initial



ORPHAN AUTOMOBILE CLUB

NO. 257 WEST SEVENTEENH STREET
SPRINGFIELD, ILL.

THE OBJECT OF THIS ORGANIZATION IS TO FURNISH ILLINOIS AUTOMOBILE CLUBS TO THE POOR ORPHANS AND DESERVE CHILDREN OF THIS CITY. DAILY RIDES ALONG THE LEAF BANK COUNTRY ROADS WITH ABO UNION BUS AND ONLY AND AN OCCASIONAL DAY SEAT AT ONE OF THE MANY CHARMING RESORTS ALONG THE LAKE FRONT HAVE DONE A GREAT DEAL TOWARD FURNISHING KNOWLEDGE AND HOPE INTO THESE POOR WAYS AND WE AGAIN DESIRE TO MAKE OURSELVES OF YOU TO HAVE CONFIDENCE IN OUR SAVING US THE SEED OF YOUR CAR FOR THIS VALUABLE PURPOSE ALL OFFICES WILL BE OBLIGED TO ACCEPT OF YOU

MARLEN J. MOORE (PRES)
ELIZABETH RANDALL
EDDIE H. LEWIS
BELOUA MAY (CLERK)

ELEANOR BEAN (HARD)
SECRETARY

GENERAL COMMITTEE

6 Point No. 551

24 A \$1.00

NEAT ANNOUNCEMENTS EASILY COMPOSED
DIGNIFIED BUSINESS AND VISITING CARDS
ATTRACTIVE SOCIETY PRINTING PROCURED
ENTERPRISING MERCHANTS REMAIN FIRM
SHOWING REMARKABLE CHARACTERISTICS

6 Point No. 552

28 A \$1.00

MRS AND MRS HAMILTON MONTGOMERY, JR. AT HOME
TWENTY-SECOND ANNUAL RECEPTION AND DANCE
WEDNESDAY AFTERNOON, JUNE 21ST, VISITORS' DAY
MODERN SUMMER FURNISHINGS BEGIN NEXT MONTH
SPRINGTIME BREEZES REFRESH THE ATMOSPHERE

6 Point No. 553

31 A \$1.00

DISINGERSHEDDORRENTS RECEIVING BOYAL WELCOME
PARADEAD OF DEALS PROVE WONDERFUL EXPLANATIONS
SOME INTERESTING RECIPES ON DELICIOUS RECIPES
AUTOMOBILE AND SEAMING RECIPES DELICIOUS ENJOYED
BANKING METHODS 21234567890 VERNER HIGHLY COMBINED

BRANDON AND BRANDON GOTHIC

24 Point

6 A \$2 50

SPECIMEN PRODUCED
HISTORIES INTEREST

18 Point No. 2

8 A \$2 00

BRANDON SERIES PLEASED
HANDSOMEST LIGHTHOUSE

18 Point No. 1

9 A \$2 00

DESIGNS SUBMITTED IMPROVING
CONTAINING MODERN STRENGTH

12 Point No. 4

12 A \$1 50

MONSTER TORNADO DISTURBED CHILD
WORK DEMANDS CAREFUL COMPOSITOR
DIGNIFIED \$1234567890 FIGURES CAST

12 Point No. 3

14 A \$1 50

BEAUTIFUL MAIDEN SWINGS IN THE HAMMOCK
PLOWING STARTED IN NORTHWEST MONTANA
SOLD TREMENDOUS SHIPMENT OF MACHINERY

12 Point No. 2

18 A \$1 50

INTEREST HOTEL PROPRIETOR
ADVERTISE COMING RESIDENTS
USING BOSTON WIRE STITCHER

6 Point No. 1

26 A \$1 00

SPASMODIC INDIGESTION CAUSING SICKNESS
COLLECTORS CONFISCATE LINCOLN PICTURE
CELEBRATIONS FINANCIALLY UNSUCCESSFUL
HOMECOMING CAUSED MANY ACHING HEARTS
STRING INSTRUMENTS MAKING SWEET MUSIC

12 Point No. 1

21 A \$1 50

CROWN ANOTHER MONARCH TODAY
MAGAZINE BEGAN FOURTH VOLUME
YOUNG STONEMEN LEARN RAPIDLY

6 Point No. 0

36 A \$1 00

MUSICIANS DISCOURAGED BEAUTIFUL CORNET PLAYERS
REPRODUCE NEAT PLATE PRINTING WITH MOVABLE TYPE
HANDSOME MENU AND BUSINESS CARDS BEING SECURED
VISITORS SHOWN ANY COURTESY BY EXPERIENCED GUIDE
INQUIRIES BY MAIL ALWAYS RECEIVE PROMPT ATTENTION

6 Point No. 3

18 A \$1 00

HORRIBLE PLAGUES DESTROYED EMPIRE
PRESENT EXTREMELY GRACEFUL MAIDEN
DISCRIMINATING FLORIST MERITS HONOR
BANKERS WENT \$1234567890 TO KANSAS

6 Point Brandon Gothic No. 2

20 A \$1 00

DEMONSTRATIONS PROVING VERY DELIGHTFUL
INDISPENSABLE ORIGINALLY CROWNED EFFORT
NUMEROUS WILD FLOWERS FOUND IN FORESTS
GOOD NATURED FIREMEN SACRIFICED CLOTHES
FIREPROOFING \$1234567890 EVERY BUILDING

6 Point No. 2

22 A \$1 00

BRANDON SERIES BRINGS MANY RETURN ORDERS
MUTUAL ADMIRATION SOCIETY FORMED IN CHINA
RAPID STEEL AND IRON INDUSTRY DEVELOPING
COLORADO MOUNTAIN SCENERY STILL PLEASING

6 Point Brandon Gothic No. 1

24 A \$1 00

ENTHUSIASTIC DEMONSTRATIONS ALARM STUDENTS
BIOGRAPH SHOW PICTURES HOME LIFE AMONG IRISH
MATRIMONIAL SCHEMERS REPORT MUCH PROGRESS
THIS GOTHIC USED IN CONJUNCTION WITH BRANDON
CURIOUS GIRL DETECTIVE REGARDED WITH CAUTION

BRANDON IN PRACTICAL DISPLAY



ANNOUNCEMENT



TO THOSE SPENDING THEIR VACATION IN OLD VIRGINIA

LANDMARK RAILROAD

WE ANNOUNCE SPECIAL RATES FOR THOSE DESIRING TO SPEND THEIR VACATION IN THE STATE OF VIRGINIA. ALL RETURN TICKETS GOOD FOR SIXTY DAYS. DURING JULY AND AUGUST SPECIAL TRAINS WILL BE RUN TO ALL THE LEADING SUMMER RESORTS AND WATERING PLACES. FULL INFORMATION AND ARTISTIC FOLDERS SENT ON REQUEST

JOHN BURNS
GENERAL PASSENGER AGENT
LANDMARK, VA.

Wayside Ornaments

JAMISON B. HUDSON
PRESIDENT

WRIGHT CR
SECRETARY

THE POMI COMPANY CHEMISTS SOAP AND PERFUME

REPRESENTED BY
JOHN CALDWELL, M.D.



BOSTON SKATING CLUB 112 ALDER STREET

OPENING NIGHT JANUARY FIRST

WE DESIRE TO ANNOUNCE NEXT FRIDAY NIGHT THE OPENING OF THE BOSTON SKATING CLUB IN ROOMS RECENTLY SECURED FOR THE SEASON IN CHARLES HOTEL AT WALDEN POND. EVERY EFFORT HAS BEEN PUT FORTH TO MAKE THIS OLD WINTER SPORT THE SOURCE OF MUCH PROFIT

REFRESHMENTS WILL BE SERVED MEMBERS DURING THE EVENING AND SKATING ON THE POND, WEATHER PERMITTING, WILL BE THE MAIN FEATURE OF THE EVENING. THE WRIGHT ORCHESTRA WILL FURNISH MUSIC. LET THE MEMBERS ALL ATTEND

BOSTON SKATING CLUB
WAIN HANCOCK, SECRETARY

1891 7 YEARS OLD THIS DAY 1898



LUCY MAY OSMUND

ASKS THE PLEASURE
OF YOUR COMPANY ON HER SEVENTH
BIRTHDAY
THURSDAY AFTERNOON

Kate Greenway Mignonette

Dutch Initial

TYPO GOTHIC

(Name changed from Tiffany Gothic)

24 Point No. 2

7 A \$2 50

ENDURING FISHERMEN

24 Point No. 1

7 A \$2 50

COMPOSITOR ENTRUSTED

18 Point No. 2

9 A \$2 00

DEMANDING MODERN GOTHICS

18 Point No. 1

12 A \$2 00

REQUIRED JUDGMENT WHEN CHOSEN

PRINTED MATTER

FROM

JOHN RANKIN
& COMPANY



Strathmore Ornament

235 STATE STREET
HAMBURG

THIS PACKAGE CONTAINS PRINTED STOCK CONSISTING OF VALUABLE WORK DONE BY US, AND THE CARRIER HEREOF SHALL BE HELD RESPONSIBLE FOR ITS DELIVERY IN AS FIRST CLASS CONDITION AS WHEN IT WAS GIVEN IN HIS CHARGE. AS ONE PREVENTIVE OF DAMAGE WOULD SUGGEST THAT YOU KEEP THIS COVERED DURING DAMP OR RAINY WEATHER AND ALSO SEE THAT THE FLOORING ON WHICH IT STANDS IS KEPT DRY. JOHN RANKIN & CO.

FIGURES \$1234567890 DOLLARS

12 Point No. 3

15 A \$1 50

GENTLEMEN CREDITORS PRINT PROMINENT CARD

6 Point No. 4

20 A \$1 00

PROPERTY OWNERS INTERESTING USE FOLDERS, PAMPHLETS, CARDS FORTUNES SMILED ON FOREIGNER

12 Point No. 2½

18 A \$1 50

PRAISED YOUTHFUL DESIGNER REQUIRE MODERN TYPE FACES

6 Point No. 3

23 A \$1 00

PREPARING CAREFUL PRINTING ORDERS RELIEVE COMPOSITORS WHEN REQUIRED PRINTERS PREFER AMERICAN PRODUCTS

12 Point No. 2

21 A \$1 50

CANCELING PREVIOUS LISTINGS INSTRUCTIONS GIVEN MECHANIC

6 Point No. 2

29 A \$1 00

GREATER SNOWSTORM HEADING EASTWARD TODAY JOB PRINTERS INCLINING LOVINGLY TOWARD BOLD ATTRACTIVE DESIGNS THAT CONTAIN ORIGINALITY

12 Point No. 1

23 A \$1 50

WITHOUT BALANCE NOTHING ARTISTIC BEING LIKE LARGE SHIPS MINUS SAIL

6 Point No. 1

34 A \$1 00

HARMONIOUS TYPOGRAPHICAL PRINTINGS BEARING IDEAL FEATURES, WHICH ADVERTISERS WANT NOWADAYS, GAINED CONSIDERABLE HEADWAY; MADE WITH THE GOTHIC SERIES

TYPO GOTHIC

Name changed from Titling Gothic

THE
AMERICAN TYPE FOUNDERS
COMPANY

EXTENDS A CORDIAL INVITATION
TO ALL
PRINTERS AND PUBLISHERS

TO VISIT ITS CENTRAL PLANT
LOCATED AT
300 COMMUNIPAW AVENUE
JERSEY CITY, N. J.

WITHOUT DOUBT THIS IS THE LARGEST AND BEST ARRANGED
TYPE FOUNDRY IN THE WORLD. ANYONE INTERESTED IN
TYPE OR PRINTING WILL FEEL WELL REPAID FOR
THE TIME SPENT IN INSPECTING THE PLANT

ORDER OF DANCE

FIRST HALF

1 GRAND MARCH

2 WALTZ

3 TWO-STEP

4 PORTLAND FANCY

5 SCHOTTISCHE

6 WALTZ

SECOND HALF

7 TWO-STEP

8 LANCIERS

9 WALTZ

10 SCHOTTISCHE

11 WALTZ

GOOD NIGHT

THE BRINKTOWN TRUST COMPANY

IMPROVED FARM OR CITY PROPERTY FOR
SALE WITHIN EASY COMMUTING
DISTANCE OF NEW YORK

MRS. THOMAS MORTON

AT HOME
THURSDAYS

906 NORDAIN STREET



CHARLES L. DAILEY, PRESIDENT
HUGH BARRIE, TREASURER

MARKUS S. BRONSON
MINING ENGINEER

THIRD AND MAPLE STREETS
OPPOSITE POST OFFICE

ROOM No. 156

MONTMORENCY BUILDING
BUFFALO

Veritable Ornament

Lightline

36 Point

6 A \$2 75 9 a \$2 25 \$5 00

MODERNIZED NUMBERING
General Improvement Noticed

30 Point

6 A \$2 05 12 a \$2 25 \$4 30

EUROPEAN MERCHANT SOUGHT
Northern Hunting Excursion Returns

24 Point

8 A \$1 75 14 a \$1 75 \$3 50

DISTINGUISHED PUBLISHERS ADVISED
Noted Literary Exponents Received Mention

18 Point

11 A \$1 55 22 a \$1 75 \$3 30

ENTHUSIASTIC PRINTERS PROMOTING HARMONY
Popular American Line Type Styles Strongly Advocated
Successful Advertisers Are Demanding Quality Printing

14 Point

17 A \$1 50 32 a \$1 50 \$3 00

REMARKABLE DESIGNS BOUGHT
Distinctive and Picturesque Conceits
Bright Color Blending Acknowledged

6 Point No. 4

26 A \$0 95 52 a \$1 05 \$2 00

BOSTON WIRE STITCHERS INSURE SATISFACTION
Especially Recommended for Its Labor-Saving Features
Invaluable as a Profit-Maker for the Up-to-Date Bindery
Self-Regulating and Easily Adjusted, It Excels all Others
Leading Printers and Publishers Recognize its Merits

12 Point

19 A \$1 30 39 a \$1 45 \$2 75

EXPERIENCED CUSTOMER DELIGHTED
American Faces Charm the Most Exacting
Recovering \$1234567890 Owner Pleased

6 Point No. 3

31 A \$0 95 61 a \$1 05 \$2 00

HANDSOME LETTER FOR GENERAL COMMERCIAL PRINTING
American Type Leads the World for Originality and Distinctiveness
Beautiful and Effective Printing Continually Being Distributed
Proper Material is the Real Secret of Profit Making in Production
Keep Your Plant Modern \$1234567890 and in Good Condition

10 Point

22 A \$1 20 43 a \$1 30 \$2 50

SECURE YOUR JOB TYPE IN WEIGHT FONTS
Avoid the Expensive Habit of Picking Live Matter
Full Cases of Display Letter Mean Larger Profits

6 Point No. 2

40 A \$1 00

ENTERPRISING MEASURES PLANNED BY EXPERIENCED STATESMEN
FOREIGN NOBLEMEN GREATLY PLEASED WITH OUR TRADE METHODS
DELIGHTFUL SERIES OF MUSICAL CONCERTS GIVEN IN THE SPACIOUS GARDEN
ARTIFICIAL LAKE SURROUNDED BY FRAGRANT ROSEBUSHES AND GERANIUMS
TREMENDOUS CROWDS OF FASHIONABLY DRESSED WOMEN PROMENADE DAILY
CHARMING ENTERTAINERS SCORE GREAT SUCCESS IN LIGHT OPERATIC ROLES

8 Point

24 A \$1 10 47 a \$1 15 \$2 25

MANY CHARACTERISTIC AND STRIKING TYPE DESIGNS
Popular American Line Faces Increase the Value of Printing
Always Bear This Fact in Mind When Ordering New Material

6 Point No. 1

46 A \$1 00

SUMPTUOUS APARTMENTS APPROPRIATED BY MANY PROFESSIONAL SONGBIRDS
DELIGHTFUL SERIES OF MUSICAL CONCERTS GIVEN IN THE SPACIOUS GARDEN
ARTIFICIAL LAKE SURROUNDED BY FRAGRANT ROSEBUSHES AND GERANIUMS
TREMENDOUS CROWDS OF FASHIONABLY DRESSED WOMEN PROMENADE DAILY
CHARMING ENTERTAINERS SCORE GREAT SUCCESS IN LIGHT OPERATIC ROLES

JAMES MARTINDALE, President
WILLIAM T. AMES, Vice President

H. MARTINDALE, Secretary
HENRY BRADSON, Cashier

Martindale, Bradson & Company

Number 1934 East One Hundred and Sixteenth Street

NEW BEDFORD, VERMONT

Telephone 4-1-1-1-5

EXTEND to their friends and customers a cordial invitation to attend their Annual Exhibition and pass judgment on the recent importation of Oriental Carpets, Rugs and Tapestries which their special European agent, Mr. Herbert Mason, after visiting the principal marts and trade-centers of Europe, Asia and India, has selected for them. This selection is undoubtedly the finest that has ever been displayed and offered for sale in this city. No matter how keen the eye may be for color harmony, or how fastidious the taste in harmonious interior decoration, the subtle charm embodied in the making of these creations cannot fail to appeal to you. To have a beautiful and comfortable home is the ambition of every person of intelligence, and how to make the home as beautiful as one's purse will permit is an art in which every householder should be interested and to further this end a special staff of skilled housefurnishers and decorators is at your service

Dated September 3

MONTHLY STATEMENT

Portland, Ore.,

191

M

TO MONTGOMERY & HENDERSON, Dr.

MANUFACTURER OF

Automobiles and Motor Boats

Manufacturer of
NOTRAM SIX-CYLINDER MOTOR

SOLE U.S.A. AGENTS
No. 1026 North Plainfield Avenue

24 Point No. 40

8 A \$2 50

EXPOSED STRANGE METHOD

24 Point No. 39

10 A \$2 50

PROSPEROUS YOUNG MERCHANTS

18 Point No. 40

11 A \$2 00

BEAUTIFUL DESIGNS RECEIVE MENTION

18 Point No. 39

14 A \$2 00

MEDICAL JOURNALS EXPLAIN HARMFUL DRINK

SUMMER ANNOUNCEMENT

THE FAIRMOUND COMPANY
MANUFACTURING SILVERSMITHS

ANNOUNCES THAT IT HAS MANUFACTURED A DISTINCTIVE AND ARTISTIC LINE
OF NOVELTIES IN THE SILVERSMITHS ART AND WILL BE PLEASED
IF YOU WILL SHOW YOUR APPRECIATION WHEN

MR. HURBERT CHURCHSON WORTHINGTON

CALLS AT YOUR OFFICE WITH SAMPLES COMPRISING ITS COMPLETE LINES
AND YOU MAY EXPECT HIM ON OR ABOUT THE

TWENTY-FIRST DAY OF THE MONTH OF AUGUST

KNOWING THAT OUR LINES WILL MEET WITH YOUR
APPROVAL WE THANK YOU FOR YOUR KIND CONSIDERATION
OF THE SAME AND FOR MANY PAST FAVORS

THE FAIRMOUND COMPANY
SHOE LANE. LONDON, E. C.

DURABLE \$1234567890 HANDSOME

12 Point No. 38

18 A \$1 50

PROMINENT SPEAKER FOUND
SOME INTERESTING READING

12 Point No. 37

22 A \$1 50

ENERGETIC MAIDENS SUBSTITUTED
RICH RESIDENT PRESENTED NAMES

12 Point No. 36

26 A \$1 50

HANDSOME AMERICAN PRODUCTS USED
REASONABLE REQUIREMENTS PROPOSED

12 Point No. 35

29 A \$1 50

LARGE DEMANDS GRANTED COUNTY OFFICIALS
NUMEROUS CONTRACTS REPORTED DEFECTIVE

6 Point No. 34

27 A \$1 00

HARMONY PREVAILED DURING CONVENTION
EXTRAORDINARY SCENES EXCITED MEMBERS
MUSICAL TEAM \$1234567890 FORMED BAND

6 Point No. 33

31 A \$1 00

BRAVE SOLDIER RETURNED FROM THE BATTLEFIELDS
WITH EMBLEMS OF VICTORY BEDECKING HIS BREAST
FIGHTING DESPERATE BATTLES WITH LIMITED MEANS

6 Point No. 32

37 A \$1 00

BRIGHTER INDUSTRIAL CONDITIONS SAID TO BE INCREASING
FINANCIERS PREPARE RESOURCES FOR DISTRIBUTING MONEY
VERY REMARKABLE MEASURES ANNOUNCED BY LARGE DEALER

6 Point No. 31

42 A \$1 00

DOWN IN THE BOWELS OF BIG STEAMSHIPS ENGINEERS CONSTANTLY
AND DILIGENTLY WATCH EVERY SHAFT AND BOILER GAUGE THROUGH
MANY LONG WEARY DAYS AND NIGHTS WHILE PLOUGHING THE OCEAN

24 Point No. 20

8 A \$2.41

EXPOSED STRANGE METHOD

24 Point No. 19

10 A \$2.50

PROSPEROUS YOUNG MERCHANTS

18 Point No. 20

11 A \$2.00

BEAUTIFUL DESIGNS RECEIVE MENTION

18 Point No. 19

11 A \$2.00

MEDICAL JOURNALS EXPLAIN HARMFUL DRINK

HENRY CONKLIN

DANIEL BEARING

THE AKRON MINING & MILLING CO.

DEVELOPING AND OPERATING
MINING PROPERTIES, TIMBER TRACTS
AND COAL LANDS

MAIN OFFICE
MANDRAKE BUILDING

WASHINGTON, D. C.

ESTABLISHED 1866

MR. RUDOLPH M. WORTHINGTON
HOME DECORATOR

36 AMSTERDAM STREET
HURON BUILDING

TELEPHONE 862 SPRINGFIELD

PIKERSTOWN, N. M.

DURABLE \$1234567890 HANDSOME

12 Point No. 18

18 A \$1.50

PROMINENT SPEAKER FOUND
SOME INTERESTING READING

6 Point No. 14

27 A \$1.00

HARMONY PREVAILED DURING CONVENTION
EXTRAORDINARY SCENES EXCITED MEMBERS
MUSICAL TEAM \$1234567890 FORMED BAND

12 Point No. 17

21 A \$1.50

ENERGETIC MAIDENS SUBSTITUTED
RICH RESIDENT PRESENTED NAMES

6 Point No. 13

31 A \$1.00

BRAVE SOLDIER RETURNED FROM THE BATTLEFIELDS
WITH EMBLEMS OF VICTORY BEDECKING HIS BREAST
FIGHTING DESPERATE BATTLES WITH LIMITED MEANS

12 Point No. 16

25 A \$1.50

HANDSOME AMERICAN PRODUCTS USED
REASONABLE REQUIREMENTS PROPOSED

6 Point No. 12

37 A \$1.00

BRIGHTER INDUSTRIAL CONDITIONS SAID TO BE INCREASING
FINANCIERS PREPARE RESOURCES FOR DISTRIBUTING MONEY
VERY REMARKABLE MEASURES ANNOUNCED BY LARGE DEALER

12 Point No. 15

29 A \$1.50

LARGE DEMANDS GRANTED COUNTY OFFICIALS
NUMEROUS CONTRACTS REPORTED DEFECTIVE

6 Point No. 11

42 A \$1.00

DOWN IN THE BOWELS OF BIG STEAMSHIPS ENGINEERS CONSTANTLY
AND DILIGENTLY WATCH EVERY SHAFT AND BOILER GAUGE THROUGH
MANY LONG WEARY DAYS AND NIGHTS WHILE PLOUGHING THE OCEAN



EXHIBITION OF RARE CURIOS
AND
FINE ANTIQUES

BEGINNING MONDAY, JANUARY 17TH, AND CONTINUING THE ENTIRE WEEK, OUR ANNUAL EXHIBITION OF RARE CURIOS AND FINE ANTIQUES WILL BE HELD IN THE WAREROOMS OF OUR NEW BUILDING. WE CAN TRUTHFULLY ANNOUNCE, WITHOUT FEAR OF CONTRADICTION, THAT OUR DISPLAY THIS YEAR WILL BE THE BEST EVER SEEN IN THE CITY. A SPECIAL EFFORT HAS BEEN MADE BY OUR TRAVELING PURCHASER TO OUTDO HIMSELF ON THIS OCCASION, AND THAT HE HAS SUCCEEDED TO AN ADMIRABLE DEGREE WILL BE AT ONCE APPARENT TO THE MOST FASTIDIOUS OF ART CONNOISSEURS AND COLLECTORS OF CURIOS AND ANTIQUES

A BEAUTIFULLY PRINTED CATALOGUE HAS BEEN ARRANGED AND THE ARTICLES ENUMERATED, WITH A BRIEF HISTORY OF EACH. PATRONS WHO FEEL INTERESTED AND FIND IT INCONVENIENT TO ATTEND THE EXHIBITION IN PERSON MAY SECURE A COPY BY SENDING THEIR ADDRESS TO THIS DEPARTMENT

THE KINGSFORD ART CO.
SECOND AND BRINK STREETS
AUSTIN, ILLINOIS

Renaissance Ornament

SILVER NOVELTIES

RARE STATUARY

THE KINGSFORD ART COMPANY
IMPORTER OF
ANTIQUES AND CURIOS

REPRESENTED BY
CHARLES N. MASON

SECOND AND BRINK STREETS
AUSTIN, ILLINOIS

COPPERPLATE GOTHICS IN COMBINATION

ORGANIZED 1845

NERM BANK

OF NORTH AMERICA

OFFICERS

EDWIN MUNSEY . . . PRESIDENT
 NORMAN BROWN . VICE-PRESIDENT
 HERMAN BRODER . . . SECRETARY
 WILLIAM SMITH . . . TREASURER

DANIEL ANDERSON
 COUNSEL

DIRECTORS

GEORGE BRENNEN
 RICHARD STEVENSON
 CHARLES KENTEN
 THOMAS ROBERTSON
 LOUIS KNOX

MANER INSTITUTE OF MUSIC AND ART



DEARBORNE PLACE
 DENVER

ANNOUNCEMENT

ON THURSDAY THE TWENTIETH DAY OF AUGUST THE REGULAR ADVANCED COURSE OF ART AND MUSIC WILL BEGIN IT IS OF THE UTMOST IMPORTANCE THAT ALL STUDENTS DESIRING TO START THE WINTER SEASON'S COURSE MUST POSITIVELY HAVE THEIR NAMES ENROLLED BEFORE THE SIXTEENTH OF SAID MONTH TO INSURE THEM A GUARANTEE OF ADMISSION IT IS ALSO DESIRED ON THE PART OF THE MANAGEMENT THAT THE EXACT LENGTH AND EXTENT OF THE COURSE TO BE TAKEN SHOULD BE DEFINED IN WRITING ON THE ABOVE DATE

MAURICE HENNING
 DIRECTOR

Strathmore Ornament

EDWIN MERDMEN COMPANY

EXTENDS TO THE GENERAL BUYING PUBLIC AN INVITATION TO VISIT ITS LARGE AND SPLENDIDLY STOCKED WAREHOUSES OF EUROPEAN AND HOME CREATIONS IN FINE

HARNESS EQUIPMENTS

THIS MAGNIFICENT COLLECTION OF HORSEMEN'S FURNISHINGS AND REQUISITES STANDS BEYOND CRITICISM FOR THE FINE QUALITY AND STYLISH TRIM APPEARANCE



FACTORY
 BRAM PLACE
 DETROIT

SHOWROOMS
 HIRN STREET
 BOSTON

Versatile Ornament

MENU

SOUP

CONSOMME ROYAL
 SALTED CRACKERS

FISH

MOUNTAIN BROOK TROUT
 POTATOES LETTUCE CELERY

BAKED BLUE FISH
 GREEN CORN

BAKED SPANISH MACKEREL
 BRUSSELS SPROUTS

ENTREES

ROAST SPRING LAMB
 BAKED POTATOES

ROAST CANVAS BACK DUCK
 CRANBERRY SAUCE CRAB APPLE JELLY

DESSERT

PINEAPPLE ICE CREAM
 LADY FINGERS

COFFEE TEA CIGARS

LIGHT COPPERPLATE GOTHIC

24 Point No. 10

6A \$2 50

HUMOROUS QUESTION

24 Point No. 9

7A \$2 50

CONSTRUCTION MACHINES

18 Point No. 10

9A \$2 00

DISHONEST BROKERS RETURN

18 Point No. 9

11A \$2 00

MODERN ENTERPRISES DEMOLISHED

THE ECONOMIC CLUB OF BOSTON

REQUESTS THE HONOR OF YOUR COMPANY AT AN INFORMAL DINNER ON THE EVENING OF WEDNESDAY, THE FIRST OF JUNE, ONE THOUSAND NINE HUNDRED TWELVE, AT HALF AFTER SIX O'CLOCK, AT

THE GREAT NORTHERN HOTEL

SUBJECT FOR DISCUSSION

IS THE OVER-CAPITALIZATION OF OUR RAILROADS AN EVIL

SPEAKERS

JAMES S. MONTGOMERY, JR

PROF. CHARLES LEON MORTON

DOCTOR MARCUS RADBURN

REV. PERCY ANDERSON

FRED WARREN ATHERINGTON

MAYOR HENRY MARKSON

DOCTOR ROBERT BOYCE KOTH

ANDREW H. CONARSIÉ

DAVID M. ROTHERFORD

PROFESSOR GEORGE N. NOSTRON WILL PRESIDE

RECEPTION WILL BE HELD AT HALF AFTER SIX

DINNER AT SEVEN

SPEAKING FROM HALF AFTER EIGHT UNTIL HALF AFTER TEN

STRONG \$1234567890 FIGURES

12 Point No. 8

13A \$1 50

MERITORIOUS DESIGNS
CABINET RENUMBERED

12 Point No. 7

16A \$1 50

INGENIOUS KINGS CONFER
HEROIC MAIDEN HONORED

12 Point No. 6

19A \$1 50

REMARKABLE SOUVENIR PRIZES
CURIOUS GERANIUM EXHIBITION

12 Point No. 5

24A \$1 50

ENTHUSIASTIC JUVENILE SERENADER
MAGNIFICENT SPRINGTIME COSTUMES

6 Point No. 4

21A \$1 00

REHEARSING WONDERFUL DRAMAS
DIGNIFIED CHARACTER PRESENTED
CHOICE MIDNIGHT PERFORMANCES

6 Point No. 3

26A \$1 00

ROMANTIC SUMMER GARDENS PURCHASED
MODERNIZED FINANCIERS DESIRED MONEY
ANCIENT COLONIAL MANSIONS SEARCHED

6 Point No. 2

32A \$1 00

MUSCULAR GENTLEMEN EXHIBIT GREAT ENDURANCE
STRENUOUS EXERCISE RECOMMENDED BY PHYSICIAN
MANY EXTRAORDINARY ACROBATIC ACHIEVEMENTS

6 Point No. 1

37A \$1 00

BEAUTIFUL STRAINS OF INSPIRING MUSIC DELIGHT LOVERS
ALPINE MOUNTAIN CLIMBER ENJOYING SPECIAL PRIVILEGE
PERFUMED BREEZES PERMEATE THE GENTLE ATMOSPHERE

HEAVY COPPERPLATE GOTHIC

24 Point No. 30

6 A \$2.70

HUMOROUS QUESTION

24 Point No. 29

7 A \$2.50

CONSTRUCTION MACHINES

18 Point No. 30

9 A \$2.00

DISHONEST BROKERS RETURN

18 Point No. 29

11 A \$2.00

MODERN ENTERPRISES DEMOLISHED

ANNOUNCEMENT

THE FIRM OF

MARKTON, BUCKRAND & COMPANY

MINING ENGINEERS

WISH TO INFORM THEIR MANY CUSTOMERS THAT THEY HAVE ASSOCIATED WITH THEM IN THE CAPACITY OF MASTER DRAUGHTSMAN

MR. EDGAR MURTENS

WHO WILL DIRECT THE DRAUGHTING DEPARTMENT AT THE OFFICES OF THIS COMPANY

No. 2345 MONTGOMERY STREET

HUDSON, N. J.

CHARLES MARKTON, MANAGER

SOAPS AND PERFUMES

VALUABLE HINTS ON THEIR MAKE AND GRADE



COPYRIGHTED 1908

MASON & SON NEW YORK

Auriol Ornament

STRONG \$1234567890 FIGURES

12 Point No. 28

13 A \$1.50

MERITORIOUS DESIGNS CABINET RENUMBERED

6 Point No. 21

21 A \$1.00

REHEARSING WONDERFUL DRAMAS DIGNIFIED CHARACTER PRESENTED CHOICE MIDNIGHT PERFORMANCES

12 Point No. 27

16 A \$1.50

INGENIOUS KINGS CONFER HEROIC MAIDEN HONORED

6 Point No. 23

26 A \$1.00

ROMANTIC SUMMER GARDENS PURCHASED MODERNIZED FINANCIERS DESIRED MONEY ANCIENT COLONIAL MANSIONS SEARCHED

12 Point No. 26

19 A \$1.50

REMARKABLE SOUVENIR PRIZES CURIOUS GERANIUM EXHIBITION

6 Point No. 22

32 A \$1.00

MUSCULAR GENTLEMEN EXHIBIT GREAT ENDURANCE STRENUOUS EXERCISE RECOMMENDED BY PHYSICIAN MANY EXTRAORDINARY ACROBATIC ACHIEVEMENTS

12 Point No. 25

21 A \$1.50

ENTHUSIASTIC JUVENILE SERENADER MAGNIFICENT SPRINGTIME COSTUMES

6 Point No. 21

37 A \$1.00

BEAUTIFUL STRAINS OF INSPIRING MUSIC DELIGHT LOVERS ALPINE MOUNTAIN CLIMBER ENJOYING SPECIAL PRIVILEGE PERFUMED BREEZES PERMEATE THE GENTLE ATMOSPHERE

COPPERPLATE GOTHICS IN COMBINATION

ESTABLISHED 1908

INCORPORATED 1909

MERIM NORTHEASTERN BUILDING AND LOAN

OFFICERS:

JAMES P. MARTIN, PRESIDENT
E. J. MOAN, VICE-PRESIDENT
SILAS DUMONT, SECRETARY
JOHN F. FOX, TREASURER
EDWARD L. DOYLE, CASHIER

ROOM 4, BURD BUILDING
HAMLIN, OHIO

DIRECTORS:

RICHARD M. HARKINS, M. D.
SYLVESTER R. GRAHAM
PROF. ARTHUR HEBRAND
JOHN W. MARKES, JR.
CHARLES H. MONTGOMERY

IN ORGANIZING THE MERIM NORTHEASTERN BUILDING AND LOAN IT HAS BEEN THE PURPOSE OF ITS OFFICERS AND MEMBERS TO FURNISH A SOURCE OF STRONG FINANCIAL AID TO THE HOUSEHOLDERS AND BUSINESS MEN OF THIS RAPIDLY GROWING SECTION OF HAMLIN. ITS BOARD OF DIRECTORS IS COMPOSED OF MEN WHOSE REPUTATION FOR ACTIVITY AND HONESTY IN THE PROFESSIONAL AND BUSINESS WORLD HAS BEEN WELL ESTABLISHED THOROUGHLY INFORMED ON ALL LOCAL CONDITIONS IT WILL BE THE EFFORT OF THIS BOARD TO FURNISH EVERY CONSERVATIVE AND PRUDENT AID TO THE DEVELOPMENT OF HOMES FOR THOSE STOCKHOLDERS WHOSE AMBITION LIES IN THAT DIRECTION AND TO LEND AID TO ALL THOSE WHO DESIRE TO ENGAGE IN LEGITIMATE BUSINESS ENTERPRISES STOCKHOLDERS REQUIRING LOAN ACCOMMODATIONS MAY ALWAYS FEEL PERFECTLY FREE TO PRESENT THEIR NEEDS, WITH THE ASSURANCE THAT THEY WILL BE GRANTED COURTEOUS ATTENTION: WHEN THESE REQUESTS ARE BASED ON GOOD SOUND BUSINESS PRINCIPLES, CUSTOMERS MAY EXPECT LIBERAL CONSIDERATION SO FAR AS POSSIBLE. WITHIN THE LIMITS OF CONSERVATIVE BANKING, OUR RESOURCES WILL BE DEVOTED TO THE ABOVE MENTIONED METHOD OF AIDING AND BENEFITING STOCKHOLDERS A SPECIAL EFFORT HAS BEEN MADE TO MEET THE REQUIREMENTS OF LADIES BY THE INSTALLATION OF A CONVENIENT AND AGREEABLE CONSULTATION AND WRITING ROOM WHICH HAS BEEN THOROUGHLY FITTED FOR THEIR EXCLUSIVE USE

MERIM NORTHEASTERN BUILDING AND LOAN

SILAS DUMONT, SECRETARY

DATED JANUARY FIFTEENTH

AMERICAN TYPE FOUNDERS CO.

ORIGINATOR OF THE COPPERPLATE GOTHIC FAMILY

JOHN N. HENDERSON, PRESIDENT

ORGANIZED 1890

CHARLES D. MORAN, SECRETARY

THE HENDERSON & MORAN COMPANY

INVENTORS AND MAKERS OF THE CELEBRATED CRITTERDON ORGANS AND UPRIGHT PIANOS



MUSICAL INSTRUMENTS
OF EVERY DESCRIPTION CARRIED IN STOCK



MAIN OFFICE, 34-36 SOUTH BAINBRIDGE STREET, LANCASTER, MICHIGAN

CHARLES L. DARLINGTON
GENERAL MANAGER

SOLE AMERICAN AGENTS FOR THE
MANTZ PIANOLA

JOHN HARTMING & SONS
MANUFACTURERS OF HIGH-GRADE
MOTOR CYCLES
HOLMS BUILDING KENTON AND MARK STREETS

No. _____ LANSING, OHIO, _____ 191 _____

THE SECOND NATIONAL BANK

PAY TO _____ OR ORDER _____
DOLLARS

\$ _____ PRESIDENT _____

LIGHT COPPERPLATE GOTHIC EXTENDED

24 Point No. 70

5 A \$2 55

HANDSOME MINER

24 Point No. 69

6 A \$2 50

MEMBER DENOUNCED

18 Point No. 70

8 A \$2 05

REMARKABLE MANSIONS

18 Point No. 69

9 A \$2 00

NUMEROUS DESIGNS BROKEN

PORT HURON, MICH., _____ 19____ M. _____ TO HERMAN BURON, M. D., DR. HOMEOPATHIST <div style="display: flex; justify-content: space-between;"> <div style="width: 30%;"> <p>OFFICE HOURS: {</p> <ul style="list-style-type: none"> 8 TO 10 A. M. 2 TO 3 P. M. 7 TO 9 P. M. SUNDAY, 9 TO 11 A. M. </div> <div style="width: 60%; text-align: right;"> <p>No. 9186 MUNFORD AVENUE TELEPHONE 214 HURON</p> </div> </div>			
AFTER FIVE DAYS RETURN TO HERMAN BURON, M. D. PORT HURON, MICH.	MRS. HERMAN BURON No. 9186 MUNFORD AVENUE PORT HURON, MICH.		

SPLENDID \$1234567890 FIGURES

12 Point No. 68

11 A \$1 50

STRONG REMARKS
HUMOROUS MUSIC

12 Point No. 67

13 A \$1 50

BROKERS DISHONEST
MODEST FOREIGNERS

12 Point No. 66

15 A \$1 50

MECHANICS DISCOUNTED
CURIOUS HOMES BOUGHT

12 Point No. 65

18 A \$1 50

SHORTHAND EXPERTS FOUND
MANY CHARMING DIVERSIONS

6 Point No. 64

17 A \$1 00

PICTURESQUE SCENES GIVEN
BIOGRAPH SHOW PROCURED
GROTESQUE PERFORMANCES

6 Point No. 63

22 A \$1 00

ANTIQUE FURNITURE THROUGHOUT
REASONABLE ENOUGH INTENTIONS
SPLENDID REMEMBRANCES RETURN

6 Point No. 62

27 A \$1 00

ENTHUSIASTIC DEMONSTRATOR REJOICING
JUVENILE STUDENTS DECLINE PROMOTION
UNDIMINISHED \$1234567890 RAINSTORMS

6 Point No. 61

30 A \$1 00

DELIGHTED SPINSTERS REMOVING HARSH LINES
CURIOUS GIRL DETECTIVE BECOMES INTERESTED
MATRIMONIAL SCHEMERS REPORTING PROGRESS

HEAVY COPPERPLATE GOTHIC EXTENDED

24 Point No. 80

5 A \$2.55

HANDSOME MINER

24 Point No. 79

6 A \$2.50

MEMBER DENOUNCED

18 Point No. 80

7 A \$2.00

REMARKABLE MANSIONS

18 Point No. 79

8 A \$2.00

NUMEROUS DESIGNS BROKEN

CHARLES W. HENDER, PRESIDENT
HENRY BRINK, SECRETARY

CAMDEN, MISSOURI, JANUARY TENTH

OWING TO THE WITHDRAWAL OF MR. HAROLD WINTERBY FROM THE SHOE AND RUBBER CONCERN KNOWN AS HENDER & WINTERBY, THE NAME OF THE COMPANY HAS BEEN CHANGED AND WILL BE CALLED

THE HENDER-BRINK CO.

THIS COMPANY, UNDER THESE NEW CONDITIONS, WILL ENDEAVOR TO AFFORD ITS MANY CUSTOMERS AND FRIENDS THE SAME QUALITY OF SERVICE THAT HAS CHARACTERIZED ITS ACTIVITIES IN YEARS PAST

VERY RESPECTFULLY

THE HENDER-BRINK COMPANY

SPLENDID \$1234567890 FIGURES

12 Point No. 78

11 A \$1.50

STRONG REMARKS
HUMOROUS MUSIC

6 Point No. 71

17 A \$1.00

PICTURESQUE SCENES GIVEN
BIOGRAPH SHOW PROCURED
GREATEST MONETARY VALUE

12 Point No. 77

13 A \$1.50

BROKERS DISTURBED
MODEST FOREIGNERS

6 Point No. 73

22 A \$1.00

SUBLIME FURNITURE THROUGHOUT
REASONABLE ENOUGH INTENTIONS
SPLENDID REMEMBRANCES RETURN

12 Point No. 76

15 A \$1.50

MECHANICS DISCOUNTED
CURIOUS HOMES BOUGHT

6 Point No. 72

27 A \$1.00

ENTHUSIASTIC DEMONSTRATOR REJOICING
JUVENILE STUDENTS DECLINE PROMOTION
GROTESQUE PERFORMANCE DISCONTINUED

12 Point No. 75

18 A \$1.50

SHORTHAND EXPERTS FOUND
MANY CHARMING DIVERSIONS

6 Point No. 71

30 A \$1.00

DELIGHTED SPINSTERS REMOVING HARSH LINES
CURIOUS GIRL DETECTIVE BECOMES INTERESTED
MATRIMONIAL SCHEMERS REPORTING PROGRESS

COPPERPLATE GOTHICS IN COMBINATION

THE FRANKLIN PRINTING CLUB

HEREBY INVITES YOU TO BE PRESENT AT ITS SIXTEENTH ANNUAL ENTERTAINMENT AND BANQUET, TO BE HELD IN ELBERON ASSEMBLY HALL ON THE EVENING OF MARCH TWENTY-SECOND. THIS EVENT WILL MARK THE CLOSE OF THE MOST PROSPEROUS YEAR IN THE HISTORY OF THIS CLUB. REPORTS ON THE BETTERMENT OF THE PRINTING INDUSTRY WILL BE DISCUSSED, WHICH MAKES IT VERY IMPORTANT THAT YOU SHOULD ATTEND THIS BANQUET

FIVE DOLLARS THE PLATE

VEST POCKET
EDITION

WINTER TRIPS

RELIABLE
INFORMATION
FOR PLEASURE
SEEKERS

ISSUED BY
THE TROPICAL
RAILROAD

FINE BANKING HOME

HUNT & MIRDE

TRUSTWORTHY
BANKING

ARTHUR BOWLES
PRESIDENT

ROBERT MUNN
CASHIER

IT IS WITH EXTREME PLEASURE AND GRATIFICATION THAT THE MEMBERS OF THIS RELIABLE INSTITUTION BEG TO ANNOUNCE THE COMPLETION OF THE NEW HOME ON SIXTEENTH AND DERAM STREETS. IT IS A HANDSOME STRUCTURE DEVOTED ENTIRELY TO OUR OWN BANKING INTERESTS. THE INTERIOR ARRANGEMENT HAS BEEN COMPLETED WITH A VIEW TO BEAUTY AND THE CONVENIENCE OF BANKING

SIXTEENTH AND DERAM STREETS, PARIS

REMOVAL NOTICE

THE GEM CLUB

HEREBY CALLS YOUR ATTENTION TO THE CHANGE IN ADDRESS OF THE MEETING-PLACE OF THE CLUB AFTER MARCH TWENTIETH TO ITS NEW AND VERY COMFORTABLE QUARTERS LOCATED AT

MAIN AND ELDRIDGE STREETS
KEASBOROUGH

NEW YORK

BOSTON

PRODUCERS OF QUALITY

HANDER-BEHMON

MANUFACTURERS OF
PRINTING INKS

DRY COLORS, OILS, TURPENTINE AND
VARNISHES

CHICAGO

BALTIMORE

COPPERPLATE GOTHICS IN COMBINATION

TELEPHONE 894 BURN

ESTABLISHED 1895

HENRY MARKSON

1209 MAINE STREET, CHICAGO

HIGH-GRADE TOILET
ARTICLES

SELECTED PARISIAN
PERFUMES

Strathmore Border

LINDEN

HARVEY BURTON

CLOTHES DRESSMAKER

LAKESIDE MANOR

FRANK H. SMITH, PRESIDENT
J. H. ROSE, VICE-PRESIDENT

R. L. SIRE, SECRETARY
JOHN R. WISE, TREASURER

BOND INSURANCE Co.

ROBERTA BUILDING, SPRINGFIELD

CAPITAL \$150,000

SOME EVERYDAY
JOBGING
ARRANGEMENTS

FIRE, LIFE, ACCIDENT
AND
PLATE GLASS
POLICIES

FLORAL DESIGNS

CUT FLOWERS

MARTIN & RICHARDSON

HIGH-GRADE FLORISTS
AND ARTISTIC *DECORATORS*

CORNER BRIGHT AND NERM STREETS, KANSAS CITY, MO.
SPECIAL PLANS SUBMITTED FOR CHURCH AND SOCIAL FUNCTIONS

FOR UP-TO-DATE
COMMERCIAL
PRINTING

TELEPHONE 124 BELL

JOHN H. BURS

REPRESENTING
THE BINDER AUTOMOBILE COMPANY
ST LOUIS MISSOURI

ESTABLISHED 1885

REORGANIZED 1902

THE LINGSTON WOOLEN Co.

DEALERS IN IMPORTED AND DOMESTIC

FABRICS

MAIN OFFICE
1234 MARTIN STREET

NEW BRUNSWICK

24 Point No. 60

6 A \$2 50

MODERNIZED NUMBER

24 Point No. 59

8 A \$2 65

STRENUOUS EXAMINATION

18 Point No. 60

9 A \$2 00

CURIOUS NECKWEAR BOUGHT

18 Point No. 59

11 A \$2 00

REMARKABLE KINGDOM UNEARTHED

OUR NEW AND ATTRACTIVE LINE OF

FINE SUITINGS

HAS JUST BEEN RECEIVED AND IS NOW OFFERED FOR YOUR CAREFUL INSPECTION. ALL OF THE LATEST IDEAS IN FASHION CONCEPTION AS WELL AS THE HIGHEST QUALITY OF FABRICS HAVE BEEN INCORPORATED IN THIS ASSORTMENT. COMPLETE LINES IN SERGES, THIBETS AND CHEVIOTS, ALSO IN WEARWELL CLOTH, THE NEW FABRIC FROM THE FACTORY OF MUNDHEIM & FRERES, PARIS. GUARANTEED ALL-WOOL, OF THIS SEASON'S SHEARING. THE LININGS ARE IN STRICT CONFORMITY WITH THE HIGH QUALITY OF THESE SUITINGS. YOU HAVE NEVER BEFORE HAD SUCH A CHANCE AS THIS TO SECURE THE BEST QUALITY WINTER SUITS FOR SO SMALL AN OUTLAY OF MONEY

FOR STYLISH
DRESSERS

**HERUM &
BURK**

STATE AND OAK STREETS
BOSTON, MASS.



ORDER OF DANCE

PART ONE

WALTZ _____

SCHOTTISCHE _____

TWO-STEP _____

LANCIERS _____

POLKA _____

GRAND MARCH _____

WALTZ _____

SCHOTTISCHE _____

TWO-STEP _____

QUADRILLE _____

WALTZ _____

INTERMISSION

PLEASING **\$1234567890** FIGURES

12 Point No. 58

12 A \$1 50

**HISTORICAL ROMANCE
STRANGE HOMESTEAD**

12 Point No. 57

16 A \$1 50

**HANDSOME MAIDS RETURN
DEMURE GIRLS INDIGNANT**

12 Point No. 56

18 A \$1 50

**HUMOROUS EPISODE REPORTED
DESIRE CONSIDERABLE MONEY**

12 Point No. 55

22 A \$1 50

**MAGNIFICENT CARPETS PURCHASED
OFFERING SOME CHOICE BARGAINS**

6 Point No. 54

21 A \$1 00

**NEW MEMBER REMAINING NEUTRAL
WONDERFUL RECEPTION TENDERED
STRONG STUDENTS BECOME QUIET**

6 Point No. 53

25 A \$1 00

**FASHIONABLE GIRLS DESIRE PROMINENCE
STARTLING EXPERIENCE VIVIDLY DEPICTED
DETERMINED LEADERS SUGGESTING IDEAS**

6 Point No. 52

32 A \$1 00

**PROSPEROUS EUROPEAN COUNTRIES LENDING HELP
THOSE MIDNIGHT RAMBLES DECIDEDLY UNHEALTHY
IMPRESSIVE RELIGIOUS CEREMONIES INTERRUPTED**

6 Point No. 51

37 A \$1 00

**MECHANICAL DEPARTMENT BECOMING HIGHLY PROFITABLE
ENTHUSIASTIC CONVENTIONS PRESENTING GRAND REPORTS
INTERNATIONAL ASSOCIATIONS OF AMBITIOUS MECHANICS**

COPPERPLATE GOTHIC BOLD

24 Point No. 50

6 A \$2.50

MODERN SHORTHAND

24 Point No. 49

7 A \$2.50

RENUMBERING FURNITURE

18 Point No. 50

9 A \$2.00

HONEST MERCHANTS RETURN

18 Point No. 49

11 A \$2.00

MAGNIFICENT REPORTS PRESENTED

ESTABLISHED 1894

CAPITAL \$120,000

TELEPHONE 340 BOND

HENDERSON & MORGAN

RAILROAD
STOCKS AND BONDS
MUNICIPAL

MEMBERS OF THE NEW YORK, PHILADELPHIA
AND CHICAGO STOCK EXCHANGES

BROWN AND MARKET STREETS

DANIEL G. MONROE

LEWIS M. HARTMAN

MONROE & HARTMAN
ACCOUNTANTS

INVENTORS
OF THE
EUREKA CARD
SYSTEM

No. 1345 NORTH MORTON STREET
BOSTON, MASS.

CHARLES W. MERIDITH

REPRESENTING
HENDERSON & MORGAN

STRIKING \$1234567890 FIGURES

12 Point No. 48

13 A \$1.50

**ENORMOUS DECREASE
MEMBERS DENOUNCED**

6 Point No. 44

22 A \$1.00

**STRONG PROPOSITION PRESENTED
WONDERFUL MUSCULAR EXERTION
NUMEROUS STRANGE ENCOUNTERS**

12 Point No. 47

16 A \$1.50

**TREMENDOUS EXCURSIONS
SPLENDID PRESENT GIVEN**

6 Point No. 43

25 A \$1.00

**DISTINGUISHED PHOTOGRAPHERS RECEIVE
CORRECT PICTURE RECENTLY ADVERTISED
DESTRUCTIVE AUTOMOBILE TOURNAMENTS**

12 Point No. 46

19 A \$1.50

**MONSTER PERFORMANCE GIVEN
STRENUOUS ENGINES INVENTED**

6 Point No. 42

34 A \$1.00

**PUZZLING QUESTIONS CONFRONTING PEDESTRIANS
UNEXPLAINED PROBLEM BECOMING VERY ANNOYING
CONSIDERABLE EXCITEMENT AT MONSTER EXHIBITS**

12 Point No. 45

24 A \$1.50

**IMPOSING SQUADRONS OF SOLDIERS
BEAUTIFUL MAIDENS BIDDING ADIEU**

6 Point No. 41

37 A \$1.00

**INTERESTING CONUNDRUMS EXAMINED AND PARAGRAPHED
SCIENTIFIC INVESTIGATION DECLARES AGAINST MANUSCRIPT
INSUFFICIENT EVIDENCE PRODUCED AND QUICKLY REJECTED**



MASQUERADE AND RECEPTION

IN THE HUDSON STUDIO RECEPTION PARLORS
BROADWAY AND FORTIETH STREET, DETROIT

MR. EDWIN MAURICE HARRINGTON

THIS EVENT MARKS THE
FIFTIETH SUCCESSFUL
YEAR OF THE GREATEST
DEPARTMENT STORE IN
THE STATE OF MICHIGAN

REQUESTS THE PLEASURE OF YOUR COMPANY
ON THE EVENING OF THIS OCCASION TO TAKE PART IN THE FESTIVITIES
THAT HAVE BEEN ARRANGED IN HONOR OF THE BUSINESS
SUCCESS OF THE HARRINGTON STORE



MONDAY EVENING, MARCH TWENTY-SECOND

MUSIC BY CRITERION BAND

DANCING AT TEN

SUPPER AT TWELVE

Holiday Decorators

S. S. AMERICA

MAY EIGHTH



RECEPTION

ON BOARD THE STEAMSHIP AMERICA IN HONOR OF
THE FOUR HUNDRETH VOYAGE OF CAPTAIN

HERMAN REDIN

SONG

LIFE ON THE OCEAN DEEP
MR. GEORGE DANBURY

PIANO SOLO

LAUNCHING THE LIFEBOAT
MRS. CHARLES ROBINSON

RECITATION

THE LIFE OF A CAPTAIN
MRS. DANIEL CLEREMONT

SONG

OVER THE BOUNDING MAIN
MR. HORACE MARSHALL

MENU FOR LUNCHEON
IS ON THE REVERSE SIDE OF THIS
PROGRAMME

SCORE CARD

ELITE CLUB

FRIDAY AFTERNOON
MARCH SIXTH



TABLE No.	POINTS
1
2
3
4
5
6
7
8

EACH PLAYER MUST REMAIN AT
HIS OR HER RESPECTIVE TABLE

**BERMINGHAM
DRAMATIC CIRCLE
EIGHTH GRAND MASK**



OFFICERS

HERMAN WILLIAMSON
PRESIDENT
MARTIN ROBINSON
VICE PRESIDENT
GEORGE ANDERSON
SECRETARY
FRANKLIN CLEMENS
TREASURER

COMMITTEE

NORMAN WENTWORTH
ROBERT MONAHAN
FREDERICK JOHNSON
HENRY DAVIDSON
CLARENCE KENNEDY
STEPHEN KILLRAIN

MONDAY, MARCH SECOND
SMITH EXCELSIOR AUDITORIUM
DANCING BEGINS AT EIGHT O' CLOCK SHARP

Strathmore Ornament

SPECIAL CATALOGUE AND PRICE LIST OF
HERBING & SCHERUN
OHIO'S LARGEST AND MOST PROGRESSIVE
MAKERS OF FLORAL DESIGNS FOR EVERY
OCCASION. CUT FLOWERS FOR FUNERAL
PIECES AND FOR BOUQUETS. CONTRACTS
TAKEN FOR THE INTERIOR DECORATION
OF CHURCHES, SCHOOLS AND THEATRES



LOCATED AT THE CORNER OF HENDERSUN
PLACE AND SOUTH EASTERN BOULEVARD
CUMBERLAND, GUERNSEY COUNTY, OHIO

Strathmore Ornament

MAIN BUILDING CLUB



THE MOST RELIABLE INSTITUTION
OF THIS KIND IN THE NORTHWEST
MONEY LOANED
ON REAL ESTATE AND PERSONAL
PROPERTY OF LEGITIMATE VALUE



HENDERSON AND MONTCLAIR STREETS, CHICAGO

Versatile Ornament

BLAIR SERIES

21 Point No. 2

5 A \$2 50

NICE DISCERNMENT
PRINTS FIT DESIGNS

21 Point No. 1

6 A \$2 50

REFINEMENT DELIGHTS
SUPERIOR EXPERIENCE

18 Point No. 2

8 A \$2 00

PRINTING MINDS CHARMED
INSPECTED SOME DESIGNS

18 Point No. 1

9 A \$2 00

SUBMERGE TREMBLING CHICK
MANY REMARKS CONDEMNED

12 Point No. 4

11 A \$1 50

USERS OF PRINTING
REQUIRE SOME FINE
WORK \$1234567890

6 Point No. 4

16 A \$1 00

FULL CASES EARN DIVIDENDS
MOST EXPENSIVE ITEM IS TIME
SEE THE \$1234567890 DIGITS

12 Point No. 3

14 A \$1 50

INCREASE PRODUCTION
BY ABOLISHING UNWISE
IMPRACTICAL METHODS

6 Point No. 3

19 A \$1 00

THIS FACE WILL REMAIN MODERN
SUCH DIGNITY IS ALWAYS IN STYLE
USEFUL ON MENU AND JOB CARDS

12 Point No. 2

16 A \$1 50

PICKING SORTS IS A FUTILE
HABIT CAUSING PROFIT AND
EQUANIMITY TO TAKE WING

6 Point No. 2

23 A \$1 00

DOCTORS AND LAWYERS WANT DIGNIFIED
PRINTED MATTER BECAUSE THEY HAVE TO
SUSTAIN DECENT PROFESSIONAL DIGNITY

12 Point No. 1

18 A \$1 50

QUADS IN SPECIAL CASES SERVE
THEIR PURPOSE WELL BUT A FEW
KEPT IN TYPE CASES SAVE STEPS

6 Point No. 1

29 A \$1 00

WHERE IS THAT BADLY BANGED COPPER THIN SPACE
IN THE CASE WHERE YOU TOOK PAINS TO RETURN IT
SUCCESS IS ACQUIRED THROUGH PERSEVERANCE

6 Point No. 0

46 A \$1 00

A WRITER IN ONE OF THE TRADE PAPERS, EVIDENTLY OF A STATISTICAL TURN OF
MIND, HAS THIS TO SAY CONCERNING PICKING IN THE COMPOSING ROOM OF A
LARGE PLANT I SAW A COMPOSITOR MAKING UP THE STANDING ADVERTISEMENT

BLAIR IN PRACTICAL DISPLAY

NEW THEATRE

SOUTH AVENUE PARK

THE NEW THEATRE COMPANY DESIRES TO ANNOUNCE THAT NEXT FRIDAY EVENING THE NEW PLAYHOUSE WILL OPEN ITS DOORS TO THE PUBLIC. YOUR PRESENCE WILL BE EXPECTED AND APPRECIATED. RESERVED SEAT OR BOX FOR THE ENTIRE SEASON MAY BE ARRANGED FOR AT THE BOX OFFICE. ONE OF THE LEADING ATTRACTIONS IN THE BIG NEW YORK THEATRES LAST WINTER HAS BEEN SECURED FOR THIS OPENING EVENT

GRACE MILLER THE FAMOUS LADY FROM CALIFORNIA WILL MAKE HER FIRST APPEARANCE IN DAYTON ON THE OPENING DATE OF THE NEW THEATRE IN THE MOST THRILLING DRAMA

KILLING THE CUPIDS

Typotect Border

YEAR BOOK

CADMUS
ART
MUSEUM

PRESENTED BY
THE TRUSTEES
TO PATRONS IN
OUR CITY WITH
THEIR SINCERE
APPRECIATION
FOR THE MANY
CURTESIES RE-
CEIVED BY THE
MUSEUM

OLEAN, NEW YORK
MAY FIRST

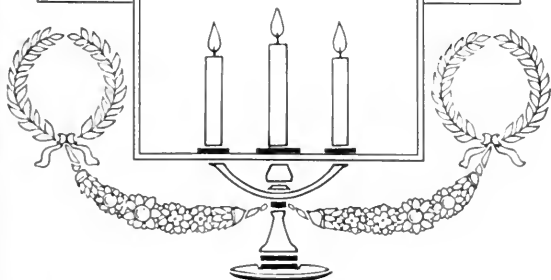

Renaissance Ornament

UNIQUE DESIGNS

WE WILL BE PLEASED
TO SEND YOU SOME OF
OUR SPECIMENS AND
SPECIAL DESIGNS. WE
DO SOCIETY PRINTING



TO HOST
AND
HOSTESS

WE WANT YOUR
GUESTS TOGETHER
JUST THE INVITATION OR THE
CARD WHICH IN
EVERY WAY CAN
AND WILL MAKE
THE AFFAIR AN
APPROPRIATE
ONE FROM THE
VERY START IT
IS TO THIS END
WE INVITE YOU
TO VISIT US BEFORE
PLACING AN ORDER FOR
INVITATION OR
CARDS WE CAN
PRINT THEM TO
PLEASE YOU IN
EVERY DETAIL

RENO & HART

OLD COLONIAL
TELEPHONE 24

THE ARCADE
PRINTERS IN
BRAMDOCKS

Holiday Decorator

CONDENSED BLAIR

24 Point No. 2

9 A \$2 50

USEFUL CONDENSED TYPE FACE
CHARACTER AND QUIET DIGNITY
DELIGHT THEIR ARTISTIC SENSE

24 Point No. 1

11 A \$2 50

REMARKABLE UNIFORMITY IN SPACING
FASTIDIOUS CUSTOMERS ADMIRE THIS
CERTAIN TO REMAIN LONG IN FASHION

18 Point No. 2

14 A \$2 00

DELIBERATE AND PLAN
IF YOU DESIRE TO BE A
PROFICIENT WORKMAN

12 Point No. 2

27 A \$1 50

PERHAPS YOU WORK TOO HARD WITH
HANDS AND FEET WHILE YOUR SKULL
MUSCLE IS TAKING IT EASY, WAKE UP

12 Point No. 1

33 A \$1 50

PUZZLING QUESTION CONFRONTS THE BOSS
HANDS ARE ALL WORKING AT UTMOST SPEED
YET WHY IS IT THAT RESULTS ARE MEAGRE

18 Point No. 1

16 A \$2 00

DEMAND MAY BE CREATED
BY EXAMPLE QUITE OFTEN
GET OUT NICE LITERATURE

6 Point No. 4

30 A \$1 00

IT IS NOT UNCOMMON TO SEE COMPOSITORS BUSILY
ENGAGED IN PULLING SORTS AND IN PUTTING THEM
BACK AGAIN OR IN TAKING LONG JAUNTS IN PURSUIT
OF MATERIAL WHICH \$1234567890 SHOULD BE HANDY

6 Point No. 3

34 A \$1 00

BLAIR CONDENSED HAS ITS PURPOSE AND USEFULNESS AND
THAT SIMPLICITY SO NECESSARY TO DIGNIFIED PRINTING
FACES THAT COMPOSITORS ALSO ADMIRE ARE NOT LIKELY TO
REMAIN LONG IDLE IN THE CASE AND TYPE THAT WEARS OUT
IN USEFULNESS IS THE KIND TO BUY BECAUSE PROFITABLE

12 Point No. 4

19 A \$1 50

THE CHARACTERISTIC DIGNITY SO
MANIFEST IN THIS TYPE MAKES IT
ESPECIALLY \$1234567890 LIKABLE

6 Point No. 2

40 A \$1 00

THE BUSINESS MEN OF THE UNITED STATES ARE BETTER EDUCATED ON
PRINTING AND TYPE THAN ARE THOSE OF ANY OTHER COUNTRY IN THE
WORLD. THE PRINTING PRESS IN THIS COUNTRY IS RAPIDLY EDUCATING
EVERYONE TO DEMAND BETTER PRINTING. PRESENT AND FUTURE CALL
FOR TYPOGRAPHY THAT IS SIMPLE, WELL PRINTED AND EASY TO READ

12 Point No. 3

22 A \$1 50

GREAT TYPOGRAPHICAL EXCELLENCE IS
OFTEN A MATTER OF SENSIBLE REGARD
FOR THE FINER ETHICAL REQUIREMENTS

6 Point No. 1

48 A \$1 00

MODERN PRINTING IS GETTING AWAY FROM ECCENTRICITY, TYPE SHOULD NOT BE SET
IN ECCENTRIC DESIGNS NOR SHOULD IT BE CROWDED WITH OVER-ORNAMENTATION, IT
MUST BE EASY TO READ AND YET IT MUST BE DISTINCTIVE. THE EASIEST WAY TO GET
THIS DISTINCTIVENESS IS WITH NEW TYPE FACES, AND THE PRINTER HAVING THE MOST
NEW FACES CAN CREATE THE MOST NEW BUSINESS. CUSTOMERS WELCOME NEW FACES

MORGENSTEIN & HENDRICKS

REAL ESTATE AND MANAGEMENT OF PROPERTIES

MADISON AND BERGINDALE ROADS, RICHMOND

THE VALUE OF REAL PROPERTY AS AN INVESTMENT DEPENDS UPON ITS PROPER MANAGEMENT. IT OFTEN HAPPENS THAT A PROPERTY OWNER IS SO SITUATED THAT HE HAS NEITHER TIME NOR OPPORTUNITY TO GIVE HIS LAND AND BUILDINGS ANY PERSONAL SUPERVISION, BUT MUST OF NECESSITY DELEGATE THIS TRUST TO ANOTHER. IN ORDER TO MEET THIS NECESSITY AND TO PROVIDE A RESPONSIBLE AGENCY FOR RICHMOND PROPERTY OWNERS, THIS COMPANY HAS ORGANIZED ITS REAL ESTATE DEPARTMENT. THE PROPER MANAGEMENT OF INCOME BEARING REAL ESTATE CONSISTS CHIEFLY IN THE CAREFUL OBSERVANCE OF ALL THE

IMPO
TRAS

CKEN
EIGH

MEMBER'S TICKET

GOOD FOR ENTIRE SEASON

RUBIKEN CLUB DANCES

HERMAN, INSTRUCTOR

EVERY WEDNESDAY EVENING

EXCEPTING LEGAL HOLIDAYS

NEW AUDITORIUM

MAIN AND BROAD STREETS

CLUB OF HE
ME

ND ANNIVERSARY
IMENT
PHAN HOME BENEFIT

BLUE POINTS
HALF SHELL

STRAINED GUMBO
HOT OR COLD

RUSSIAN CAVIARE ON TOAST

BROILED DUCKLING
APPLE SAUCE

ROAST SPRING LAMB
MINT DRESSING

LOBSTER SALAD
MAYONNAISE

FRUIT CAKE

CRACKERS CHEESE

DEMI TASSE

CIGARS CIGARETTES
IMPORTED

CLUBROOMS, SATURDAY, DECEMBER EIGHTH
EIGHT O'CLOCK

PROGRAMME

PART ONE

HEarken UNTO ME SOLO AND CHORUS
MISS SMITH AND CHOR

THEN SHALL THE REDEEMED QUARTET
THE ELECT FOUR

OH' COME, EMMANUEL SOLO AND CHORUS
MR. FRANKLIN RICHARD CHOR

THE PEOPLE THAT WALKED IN DARKNESS DUET
M SSES GRACE RYAN AND EVELYN KAND

OH' LIGHT OF LIFE SOLO
MR. GEORGE MATHEWS

DIVINE REDEEMER QUARTET
THE ELECT FOUR



WEDDING GOTHIC

36 Point No. 13

3 A \$4 00

REDESIGNING

30 Point No. 12

4 A \$3 25

GOTHIC DESIGN

24 Point No. 11

5 A \$2 50

FOR MODERN CUT

24 Point No. 10

6 A \$2 50

HANDSOME DIGNIFIED

18 Point No. 9

6 A \$2 00

GENERAL JOB PRINTER

14 Point No. 8

8 A \$1 75

ESTABLISHED TYPOGRAPHY
NICEST COMMERCIAL WORK

12 Point No. 7

10 A \$1 50

ECONOMICAL CAPITAL CHARACTERS
ORIGINATE \$12,345,678.90 AMERICAN

10 Point No. 6

13 A \$1 50

DAINTY ENVELOPES
WEDDING PRINTING

6 Point No. 3

17 A \$1 00

MENTION WEDDING GOTHIC SERIES
EVERY OCCASION WHEN INTENDING
DESCRIBING PROFITABLE PRINTING

8 Point No. 5

13 A \$1 25

HANDSOME PROGRAMS
GRAND DANCE ORDERS

6 Point No. 2

25 A \$1 00

PROFESSIONAL CARDS AND LETTER HEADINGS
LEGIBLE INSURANCE COMPANY CIRCULARS OR
DIGNIFIED AND IMPRESSIVE BANKING NOTICES

8 Point No. 4

16 A \$1 25

PROFITABLE TRANSACTION
OFFICE STATIONERY TYPE

6 Point No. 1

31 A \$1 00

DECIDEDLY USEFUL FOR GENERAL COMMERCIAL PRINTING
EMBODIED IN THE TYPOGRAPHICAL EQUIPMENT OF EVERY
MODERN EQUIPPED ESTABLISHMENT ON THIS CONTINENT

WEDDING GOTHIC



BOOK MARK

WHEREVER USED,
AT THE OFFICE OR
IN YOUR HOME, IT
WILL REMIND YOU
OF OUR FACILITIES
FOR DOING SOME,
IF NOT ALL, OF THE
BETTER PRINTING
YOU WILL REQUIRE

COMPLIMENTS OF

RICE

MODERN PRINTER
52 DOANE STREET

Versatile Ornament

NEW SIZES

WEDDING GOTHIC IS
NOW MADE UP TO AND
INCLUDES

36 POINT

AMERICAN
TYPE FOUNDERS CO.



AMERICAN TYPE FOUNDERS COMPANY
COMPLETE PRINTING OFFICE OUTFITTER



DELIVER TO THE PRINTER, WHOSE NAME
AND ADDRESS IS WRITTEN ON THE REVERSE OF
THIS ORDER, DUPLICATE FONTS OR ORIGINAL SIZES

WEDDING GOTHIC

AND TWO FONTS EACH THE SIX RECENTLY ADDED SIZES ALSO,
ONE FONT EACH 36 AND 48 POINT BRIDAL BORDER.

USUAL IMMEDIATE
DELIVERY

William H. Upton,

CITY SALESMAN

MITCHELL

36 Point

3 A \$3 75

FISHER HOME

30 Point

4 A \$3 00

SINGER IMPRINT

24 Point No. 1

5 A \$2 50

MONEY EXPENDED

24 Point No. 2

6 A \$2 50

TOURISTS INTERESTED

18 Point

7 A \$2 00

SMILE CHILDREN PLEASE

14 Point

9 A \$1 75

INCREASED STRIKING DESIGNS

12 Point No. 1

11 A \$1 50

HONEST MIKE RETURNED FIVE CENTS

12 Point No. 2

13 A \$1 50

POLITICIANS REVIEWING
EXHIBITED \$1234567890

6 Point No. 2

19 A \$1 00

ATTENTION IS CALLED TO ENGRAVED
APPEARANCE OF MITCHELL MADE IN
FIFTEEN SIZES IN DIFFERENT NICKS

12 Point No. 3

16 A \$1 50

DENIED TOURIST CHARITIES
COMPOSITORS DUPLICATING

6 Point No. 3

24 A \$1 00

THE VERY HIGHEST STANDARD NOT ONLY
IN DESIGN BUT ALSO IN THE MECHANICAL
ACCURACY AND ALIGNMENT \$1234567890

12 Point No. 4

18 A \$1 50

BUILT REMARKABLE AEROPLANE
SHOWED AMERICAN ORNAMENTS

6 Point No. 4

28 A \$1 00

TO TWENTIETH CENTURY ADVERTISERS FAMILIAR
WITH MODERN METHODS IN MAGAZINE PUBLICITY
AMERICAN FACES DISTINCTIVE AND ATTRACTIVE

6 Point No. 1

17 A \$1 00

EXHIBITION UNSTINTINGLY PATRONIZED
POSTPONED GAMES CONTESTED IN RAIN
MONEY FOR \$1234567890 JOY PRINTING

6 Point No. 5

37 A \$1 00

VERY CLEAR AND DISTINCT FOR THE SIZE AND USEFUL FOR NEAT
IMPRINTS OR UNIMPORTANT WORDS IN MATTER CONFINED TO A
VERY SMALL COMPASS. REMEMBER THE HIGHWAY TO SUCCESS
LIES IN GRASPING OPPORTUNITY WHENEVER IT COMES ALONG

MERCANTILE GOTHIC

36 Point

3 A \$1.80

MENAGERIES

30 Point

4 A \$1.00

COWS GRAZING

24 Point

6 A \$2.55

HANDSOME GOTHIC

18 Point

6 A \$2.00

PRINTERS OWN HOMES

16 Point

8 A \$1.90

BUSINESS MAKING GOTHIC

12 Point

9 A \$1.50

BANKERS' PRINTING CONCERN
READING \$1234567890 FIGURES

10 Point

11 A \$1.40

MORSE COMMERCIAL PRINTING HOUSE
EXTENDING GENERAL IMPROVEMENTS

8 Point No. 2

15 A \$1.25

GROW HANDSOME ROSES
UNDER FINE PEACH TREE

6 Point No. 3

18 A \$1.00

THIRTEEN CHAMPION PRINTERS
MAKING TOUR THROUGH NORTH
ENTER TYPESETTING CONTESTS

8 Point No. 1

16 A \$1.25

WITH SUNSHINE AND SHOWERS
PANSIES GROW IN SPRINGTIME

6 Point No. 2

19 A \$1.00

NEAT EXTENDED MERCANTILE FACE
FOR FINE COMMERCIAL STATIONERY
ALSO FOR PROFESSIONAL PRINTING

6 Point No. 4

15 A \$1.10

NEW CHERRY BLOSSOM PERFUME
FLOATING ON THE APRIL BREEZES
TEN ROBINS \$1234567890 SINGING

6 Point No. 1

22 A \$1.00

SMALL SIZES ARE AS USEFUL AS THE LARGE
IN PRINTING BUSINESS AND VISITING CARDS
FULL SERIES IS A MONEY MAKER EVERY TIME

Monotone Gothic

48 Point

4 A \$4 00 7 a \$3 55 \$7 55

GRAND SCENERY
Interesting Methods

42 Point

5 A \$3 30 8 a \$3 00 \$6 30

DESIRING CHANGES
Enjoying Performance

36 Point

5 A \$2 30 8 a \$2 75 \$5 05

HUMOROUS COMEDIAN
Remarkable Organizations

30 Point

5 A \$2 05 10 a \$2 20 \$4 25

HONOR GUEST
Presented Prizes

12 Point

16 A \$1 35 31 a \$1 45 \$2 80

SECURE FINE SPECIMEN
Historic House Demolished
Interesting Scene Reviewed
Beautiful Souvenirs Printed

24 Point

7 A \$1 75 13 a \$1 80 \$3 55

CHARMING HOME
Modern Equipment

10 Point

17 A \$1 20 34 a \$1 30 \$2 50

DESIGN HANDSOME TYPES
Grand Showing of New Types
Delightful Summer Excursion
Elaborate Display of Printing

18 Point

9 A \$1 55 19 a \$1 70 \$3 25

SENATORS ENCORED
Produce Artistic Printing

8 Point

20 A \$1 05 42 a \$1 25 \$2 30

IMPROVED CONDITIONS NOTICED
Boston Printers Hold Yearly Meeting
Dangerous Performance Every Night
Printers Create Many Artistic Designs

14 Point

13 A \$1 40 26 a \$1 65 \$3 05

ADMIRE BEAUTIFUL SCENE
Pleasing Conditions Expected
Display \$1234567890 Types

6 Point

22 A \$0 95 44 a \$1 05 \$2 00

MONOTONE GOTHIC PLEASED PRINTER
Buys this Useful Series for General Display
Striking Modern Design of American Letter
Specimen Contains More Original Qualities
Our Handsome and Dignified Types Satisfy
Reliable Face \$1234567890 Shown Here

Monotone Gothic in Practical Display

Greater Investments

BEFORE YOU INVEST A DOLLAR IN ANYTHING SEND FOR THIS GREAT BOOK ON THE PROPER KNOWLEDGE OF INVESTMENTS



This book tells you about everything you should know before making an investment of any kind, either for a large or small amount. It tells how you may safely start on the road to wealth. It explains the rapid growth of capital and how small investments have brought fortune to others. It explains how an investment in a development enterprise may pay profits equal to one hundred up to five hundred per cent on the money originally invested. This great book will furnish you with good, sound advice and will help you to invest your surplus earnings

Greater Investments Publishing Company

NEW YORK BOSTON SEATTLE DALLAS CHICAGO RICHMOND

Versatile Border Cast Squares

Announcement

Spring Styles

We are very pleased to announce an advance display of beautiful Spring Models in the finest imported and domestic waists. They are exquisite specimens of the most popular and original designs, created with individual and very distinctive features. An unusually large collection of the predominating styles to enable you to make a prompt and satisfactory selection. These waists combine the most artistic designing and only the finest of needlework, and will please all those in search of exclusive and becoming styles. They will be shown in the French Room, on the second floor of our new annex, during the week of May, beginning on the sixth

MADISON & COMPANY
IMPORTERS

Thirty-Second Grand Annual

Concert

of the

San Francisco Musical
Association



Mendelssohn Hall
October First

Under Direction of Harry Muson

MONOTONE TITLE

36 Point No. 14

6 A \$3 75

ROMAN COLISEUMS

30 Point No. 13

7 A \$3 00

UNIFORMS FURNISHED

24 Point No. 12

8 A \$2 50

BENEFIT SOCIETY HELPFUL
ORGANIZED STRONG FORTS

24 Point No. 11

9 A \$2 50

EASTERN BANKERS ADVERTISED
FOREMOST STUDENTS PRESENT

18 Point No. 10

11 A \$2 00

CHARMING SINGER CALMED VICTIMS
NOISY THRONG EXCITES MARAUDER

18 Point No. 9

13 A \$2 00

YOUTHFUL ABSCONDERS DETERMINING
STUPID WORKMEN CAUSING EXPLOSION

12 Point No. 8

16 A \$1 50

PLUCKY GIRLS WON FAME
FOUR MEN DENY STORIES

6 Point No. 4

20 A \$1 00

ORGANIZING MARINES AND SOLDIERS
INACTIVE MERCHANTS PARTICIPATING
SOUND BANKING HOUSE LOST TRADE

12 Point No. 7

20 A \$1 50

MORBID CURIOUS INTERESTED
RAPID \$1234567890 PRINTERS

6 Point No. 3

27 A \$1 00

MANUFACTURER RETURNS FROM AUSTRALIA
FAMOUS PHILOSOPHER BUYS COUNTRY LOT
SMALL TOWNS \$1234567890 BECOME NOISY

12 Point No. 6

22 A \$1 50

PROMENADE NEAR CENTRAL DEPOT
DEALERS POSTPONED CONVENTION

6 Point No. 2

32 A \$1 00

GREAT CONSTERNATION IN THE PRINTING TRADES
BEAUTIFUL CHARACTERS FOR COMMERCIAL WORK
RAINY WEATHER PREVENTS TEAMS FROM PLAYING

12 Point No. 5

26 A \$1 50

NOVEL INVENTIONS AMAZING FOREIGNERS
YOUNGSTERS SURPRISING AGED EXPERTS

6 Point No. 1

31 A \$1 00

MAGNIFICENT DOMICILES DESTROYED BY FIERCE FIRES
BURGLAR CAPTURED AFTER LONG AND EVENTFUL RACE
MANY PROMINENT MEN REVIEW FINE MILITARY PARADE

REGIS SUITS AND COATS

THE STANDARD OF STYLE



REGIS GARMENTS ARE NOTEWORTHY FOR THEIR REFINEMENT, FIT AND GRACEFUL LINES. REGIS DRESSED WOMEN ARE RECOGNIZED BY THE DAINTY REFINEMENT OF THEIR PERFECTLY TAILORED COSTUMES

ROBERT GRANBIRD COMPANY

YORKVILLE PARIS, FRANCE BRIGHTON

ANNOUNCEMENT

RUSHMORE SCHOOL OF SCULPTURE

FOURTH SEASON



JOS. B. LEMENSHOW, PRESIDENT
CENTER STREET, RUSHMORE, INDIANA

FOR FULL INFORMATION, PRICES, CONDITIONS OF ENTRANCE, ETC., WRITE TO THE PRESIDENT

TERM OPENS TUESDAY, OCTOBER SEVENTH

BELDEN SILK UNDERWEAR

A DAINTY NECESSITY FOR PARTICULAR WOMEN



MANUFACTURED BY

WISCO MILLS COMPANY

APPLETON, IOWA

72 Point

3 A \$6 45 4 a \$4 25 \$10 70

MINER HOME
National Song

60 Point

3 A \$5 05 5 a \$3 85 \$8 90

DUKE MANSION
Handsome Pinks

48 Point

4 A \$3 70 8 a \$3 95 \$7 65

SINGERS CHARMED
Chorus Girls Pleased

42 Point

5 A \$3 20 9 a \$3 25 \$6 45

RIGHTEOUS MANAGER
Honest Merchant Seizes
Determine Householder

36 Point

5 A \$2.50 9 a \$2.65 \$5.05

MANSION BEING ERECTED
Build Handsome Apartment
Furnishes Elaborated Suites

30 Point

6 A \$2.15 10 a \$2.10 \$4.25

PROTECT FOREIGN MERCHANTS
International Proclamation Ruined
Obscure Matrimonial Engagement

24 Point

7 A \$1.70 14 a \$1.90 \$3.60

ENTERPRISING STUDENT CONSIDERED
Sought Disfranchising Education Boards
Detectives Contesting Forged Signatures

18 Point

11 A \$1.50 22 a \$1.75 \$3.25

MODERN PICKET SERVICE
Guard Maneuvers Detected
Overturn Numerous Camps

10 Point

21 A \$1.15 42 a \$1.35 \$2.50

MEDICAL EXAMINATIONS DECIDED
International Question Now Settled
Quietly Advocate Practical Theories
Demoralizing Circumstances Found
Radical Discourse Lately Eliminated

14 Point

15 A \$1.35 29 a \$1.65 \$3.00

POPULAR AMERICAN LINE TYPE
Strong and Durable Gothic Letters
Beautiful Display Faces Produced

8 Point

23 A \$1.05 45 a \$1.20 \$2.25

BUY YOUR JOB TYPE IN WEIGHT FONTS
Job Printers Know the Value of Full Cases
Handsome Designs Continually Originated
American Line Type Faces Lead the World
Up-to-Date Printing Machinery and Material

12 Point

17 A \$1.30 34 a \$1.45 \$2.75

MERITORIOUS CONCEPTIONS DESIRED
Some Choice Oriental Designs Submitted
Midsummer Romances Become Popular
Beautiful Homes \$1234567890 Pleasant

6 Point

25 A \$0.90 50 a \$1.10 \$2.00

ENORMOUS MARINE ENTERPRISES LAUNCHED
Improved Transportation Facilities Are Promised
Financial Giants Startle Foreign Shipping Firms
Interesting Statement Regarding New Company
Huge Steamship Remodeled and Sent Northward
Fabulous Amount of Money Desired \$1234567890

SPRING GOWNS

MANY charming styles are now here for the critical inspection of our customers. All the latest London and Parisian creations have been I Expert designers ar employed in all the ments. This grand of fashionable gow will be classed with the social and lunc functions held in t

Latest Effect in Gown

The prices listed b give a brief idea of remarkable bargain embodied in this fi lection. We wish th to our friends and public in general th here shown is only

of the magnificent gowns that we now have in stock

MORNING GOWNS.—Made of soft, clinging material which gives to the wearer an air of distinction and grace, \$7.98

AFTERNOON GOWNS.—Artistically made; just the thing for afternoon teas and socials. Sure to please, \$8.50

EVENING GOWNS.—Made of stylish medium-weight material; finely finished and suitable for all occasions . . . \$9.75

MOWER'S

HIGH-GRADE SUITS FOR WOMEN

Sixth and Main Streets

Buy Practical Weight Fonts

In every instance full cases of type are most economical to printers as there is no waiting for sorts and no necessity for pulling letters from

MEN'S GARMENTS



Holiday Decorator

In accordance with our usual custom we again call attention of patrons to our annual Christmas Display of NEW importations in Men's Haberdashery. We've established a standard catering to men who wish style and quality without extra cost. Will you afford us the pleasure of a call on your shopping tour?

Xmas Gifts

SLICK & CO., 15 Broadway

again, there is great satisfaction to know that you can depend on having enough type to set the job, which also insures better work. The use of a distinctive face of type for a booklet or circular is sure to add to its effectiveness; and this big advantage now involves no additional expense for type



Chap-Book Guidon Versatile Ornament

AMERICAN TYPE FOUNDERS CO.



The many beautiful and useful Type Faces which are continually being originated by the American Type Founders Company exceed in variety and utility the combined product of all the other type foundries. This Company carries in stock the best of everything for the newspaper or job printer



American Line Type Faces

PUBLICITY is the vital spark that keeps alive the public interest in a business enterprise, and the professional man or merchant who neglects to heed this fact is in danger of finding himself lost in a fog of dangerous oblivion. It has become worth while, very necessary, in fact, for printers and advertisers to study designs of type and educate their community up to a realization of the great advantages to be gained from advertising. The new and stylish Type Faces designed and also manufactured by this Company, and so consistently assembled in a related family, have proved of great potency in stimulating the demand for better printing in both the commercial and advertising fields. A casual examination will demonstrate the great worth of American Line Type Faces



American Type
Founders Co.



72 Point

3 A \$4 80 4 a \$3 15 \$7 95

HONEST MEMBER
Charming Damsels

60 Point

4 A \$4 15 6 a \$3 65 \$7 80

MONEY INTERESTING
Enterprising Merchant

48 Point

5 A \$3 30 8 a \$3 10 \$6 40

REMARKABLE CHARACTER
Delightful Conventions Held

42 Point

5 A \$2 60 9 a \$2 65 \$5 25

MODERNIZED HOME SECURED
Sumptuous Apartments Bought
Extraordinary Bargain Proposed

36 Point

6 A \$2 10 9 a \$1 95 \$4 35

NORTHERN RAILROADS COMBINING
Broadminded Legislators Denounced
Indignant Stockholders Unrecognized

30 Point

7 A \$1 85 11 a \$2 20 \$4 05

PROMINENT PUBLISHERS DESIRE QUALITY
Distinctive and Original American Type Faces
Superior Material Brings General Satisfaction

24 Point

10 A \$1 70 18 a \$1 85 \$3 55

INTERESTING SOUVENIRS CAREFULLY DISTRIBUTED
Enthusiastic Boys Present Splendid Bronze Ornaments
Picturesque Costume Adorns the Gallant Masquerader

18 Point

15 A \$1 45 30 a \$1 80 \$3 25

DOMESTIC INVENTORS PROCURED
Foreign Mechanics Win Recognition
Extraordinary Improvement Noticed

10 Point

26 A \$1 15 51 a \$1 35 \$2 50

STRONG AND SERVICEABLE GOTHIC LETTER
Distinct in Character and Durable in Quality
Indispensable in Newspaper and Job Offices
American Point Line, Point Body and Point Set
Bright and Legible Magazine Advertisements

14 Point

21 A \$1 40 40 a \$1 60 \$3 00

INTERESTING DIPLOMATIC ACHIEVEMENTS
Brilliant Statesmen Decide Baffling Question
Gifted Senators Show Great Executive Ability

8 Point

28 A \$1 05 55 a \$1 20 \$2 25

BRIGHT NEWSPAPER AND MAGAZINE ADVERTISING
American Line Type Styles Insure Effective Results
Most Remarkable Profit-Making Faces in the World
The Art of Pleasing Your Patrons Should be Studied
Distinctive Printing Demands American Line Designs

12 Point

25 A \$1 25 48 a \$1 50 \$2 75

WEIGHT FONTS OF JOB TYPE AT BODY TYPE PRICES
Modern Printers Recognize the Value of Full Cases
Continually Picking Live Jobs Means Smaller Profit
Plenty of Sorts \$1234567890 Saves Time and Temper

6 Point

30 A \$0 90 60 a \$1 10 \$2 00

PRINTING MACHINES OF EVERY DESCRIPTION FURNISHED
American Products Excel in Durability and Attractiveness
Complete Plants Equipped With Modern Printing Material
Cylinder and Job Presses, Paper Cutters and Wire Stitchers
Everything Needed in the Printing Trade Promptly Supplied
Beautiful Ornaments \$1234567890 Delightful Conceptions

HEROIC PRINTERS

Cool and Level-Headed Craftsmen Show Great Courage
At Their Regular Annual Celebration

FEARLESS BOWLING EXPERTS

Thrilling Bareback Rides on the Hobby Horses, Combined With the
Delights of the Toboggan, Make an Enjoyable Event

The annual celebration and outing, given by the printers employed on the *Blairsville Courier*, was held at Freeman's Grove last Saturday. To say that the event was an enjoyable one is putting it mildly

h games indulged in and eball was a feature that encourage the players to running races and high teresting bowling game dinner table was all that o some bright addresses

Bargains in Summer Clothing

Snappy Suits for Business

The latest designs in Tweeds, Serges and Worsteds are now here. Price, **\$9.75**

Latest Styles in Low Shoes

The finest line of patent-leather and russet ties ever offered in this town at **\$2.25**

Light Summer Underwear

Some beautiful suits of silk and knitted underwear at the low price of . . . **\$2.30**

Nobby White Flannel Suits

Two-piece flannel suits that will please the most fastidious taste. Price. **\$7.50**

THE MONTGOMERY CLOTHING EMPORIUM

NINTH AVENUE AND TWENTY-FOURTH STREET

D HOME

quiet Hints on the Best complexion Cream

n Madam Andrews gives weekly lectures on how autify the skin and hair physical exercise taken ry morning and evening uable hints on their use.

WEDDING GUESTS EX

Strange Disappearance of Many Valuable Presents Discon
Witness the Marriage Ceremony at the Bride's Ho

MODERN DETECTIVE METHODS SOLVE

Wonderful Ingenuity Displayed by Female Sleuth Quickly Dispel
and the Supposed Mystery is Converted Into a Huge Joke

GOLD HUNTERS RETURN HOME

Unsuccessful Seekers After the Bright and Elusive Metal Return in Disgust From the Scenes of Their Discouraging Effort

The little band of intrepid gold seekers which left North Point last September to try their luck in the new El Dorado continue to return. Many declare that

News Gothic Condensed in Practical Display

CHARLES W. FORBS, President

RICHARD MASON, General Manager

Mason-Forbs Electrical Supply

American Agents
for the Celebrated
Rex-Gorden
Magneto Flash



INVENTORS AND SOLE MANUFACTURERS OF

Mason Electric Motors

Electric Supplies of Every Description

Office and Factory, Number 1284-1286 North Pennsylvania Avenue

KANSAS CITY, MO., _____ 191 _____

No. 36907

Port Huron, Mich.,

191

THE SECOND NATIONAL BANK

Pay to the order of _____ Dollars

the sum of _____ Dollars

and charge to the account of _____

THE AMERICAN PRINTING COMPANY

\$ _____ President

AMERICAN TYPE THE BEST TYPE
AMERICAN LINE THE BEST LINE

AMERICAN TYPE FOUNDERS CO.

ORIGINATOR OF TYPE FASHIONS

TYPE, BORDERS, ORNAMENTS

AND BRASS RULE



SELLING HOUSES AND SELLING AGENCIES IN ALL THE LARGE CITIES OF THE WORLD

72 Point

4 A \$3 90 6 a \$3 55 \$7 45

UNDERMINE BRICK BUILDING
Magazine Syndicate Printing

60 Point

4 A \$3 15 6 a \$2 95 \$6 10

NEWS GOTHIC EXTRA CONDENSED
Americanized Method Satisfactory

48 Point

6 A \$3 00 11 a \$3 35 \$6 35

NEWS HEADING DEMANDING PROMINENCE
Display Startling Investigations Exclusively
Hempstead Receiving Unfavorable Mention

42 Point

6 A \$2 40 13 a \$2 85 \$5 25

EMBODIES KNOWLEDGE CONCERNING METHODS
Management Indisposed Regarding Enlargement
Distributing Literature Congratulating Financiers

36 Point

6A \$1.95 13a \$2.55 \$4.90

NORTHERN RAILROADS GRANTED ELEVENTH INTERVIEW
Objectionable Stockholders Receiving Many Disrespectful
Solicitations Regarding Important Documents Mentioned

30 Point

9A \$1.90 17a \$2.15 \$4.05

COMPETENT MAGAZINE COMPOSITORS FREQUENTLY HANDICAPPED
Prominent Newspaper Advertisements Require Condensed Headlines
Distinction Gained Through American Type Founders Company Type

24 Point

12A \$1.60 23a \$1.90 \$3.50

SHREWD ADVERTISING MANAGERS DEMAND AMERICAN PRODUCTS EXCLUSIVELY
Attractive Display Means the Reading of Advertisements and Increasing Sales
Enlightening Literature Brought Before the Public in Great Monthly Magazines

18 Point

19A \$1.50 38a \$1.80 \$3.30

BOURDEN CONCERN USED MODERN MINING ENGINES
Recent Disturbances Exhibited Exterior Manifestations
Invaluable Scientific Data Secured by German Explorer
Stock Market Unsteady Over Late Seismic Disturbance

10 Point

31A \$1.15 63a \$1.35 \$2.50

THIS STRONG DISPLAY SERIES ADAPTED FOR NARROW MEASURES
Cast on American Point Line, Point Body and Point Set This Useful
Letter is Primarily Suited for Newspaper and Magazine Advertising
Appropriate for Headings, Tabular Work, Time Tables and Tariffs
Requiring Clean, Condensed Figures and the Many Needs of the
Compositor For a Forcible Type in Every Day Commercial Printing

14 Point

25A \$1.35 49a \$1.65 \$3.00

WRITERS CONSIDER DEMAND FOR CHANGE IN MAGAZINE READING
Marked Improvement Noticeable in General and Denotes Executive
Ability in Mastering Minor Details Regarding Artistic Creations in
Several Modern Outline Studies Pertaining to Lithographic Design

8 Point

35A \$1.00 70a \$1.25 \$2.25

AN INDISPENSABLE GOTHIC LETTER FOR LEADING COMMERCIAL PRINTERS
Absolutely Perfect and Especially Adapted For Display Newspaper Headings
Characters Are Distinctive and Effective Throughout with Uniform Figures
Admirable Gothic Letter Suitable For Every Class of Printing and Advertising
The Opportunity For Obtaining Job Type in Weight Fonts at Body Type Prices
Purveyor of Printing Material and Originator of Fashionable Type Designs

12 Point

28A \$1.25 56a \$1.50 \$2.75

THE BOSTON WIRE STITCHER INSURES PERFECT SATISFACTION EVERYWHERE
An Invaluable Time and Money Saver is the Single Adjustment Feature of
the Celebrated Boston Wire Stitcher; it is Self Regulating and Easily Adjusted
Modern Machinery Is Necessary \$1234567890 News Gothic Extra Condensed

6 Point

34A \$0.85 68a \$1.15 \$2.00

SOME UNIQUE COLLECTIONS OF MISCELLANEOUS CONTRIBUTIONS TO LITERATURE
Library Donates Rare Volumes of Historical Data to Several Educational Institutions
Congressman Desires Numerous Amendments to Constitution of the New Republic
Magnificent Celebration on the Birthday Anniversaries of Lincoln and Washington
The Grand Patriotic Demonstration and Review of Troops from Fort Montmorency
Publishers Advertise Judiciously \$1234567890 County Improvements Made Yearly

72 Point

5 A \$4 10

GOVERNORS DENOUNCE

60 Point

6 A \$4 55

DISTINGUISHED FOREIGNERS

48 Point

8 A \$3 90

INTERBOROUGH LINE MODERNIZED

36 Point

10 A \$2 80

HONORABLE MERCHANT DEMANDS RECOGNITION

14 Point

35 A \$1 75

FOREIGN STATESMEN ADVOCATING REFORMS DOMESTIC INVENTORS SECURE RECOGNITION ADVERTISER PRESCRIBES CONDENSED SERIES

30 Point

15 A \$2 50

GORGEOUS SCENERY EFFECTS CHARACTERIZED PRODUCTION

12 Point

40 A \$1 50

DECIDED APPLAUSE GREET'S CLEVER CARICATURISTS SEQUESTERED VALLEYS AND BEAUTIFUL HIGHLANDS SAD REALIZATION \$1234567890 CHRISTMAS NIGHT

24 Point

21 A \$2 50

MODERN PHOTOGRAPHIC EXHIBITION REVEALED SPLENDID ACHIEVEMENTS

10 Point

46 A \$1 40

BEAUTIFUL MEADOWS AND LAWNS DELIGHT THE TOURISTS NUMEROUS WILD FLOWERS AND PLANTS WERE DISCOVERED PICTURESQUE HOMES AMONG EXQUISITE SYCAMORE TREES

18 Point

30 A \$2 00

NEWS GOTHIC EXTRA CONDENSED TITLE HEADS ARE ATTENTION ATTRACTORS AND VERY LEGIBLE

8 Point

49 A \$1 25

DEMONSTRATION SHOWS PERSEVERANCE ABSOLUTELY INDISPENSABLE THE MERRY DAYS OF CHIVALRY AND POLISHED COUNTRY GENTLEMEN INCONSEQUENTIALS NEVER MIND WHAT THE WILD WAVES ARE SAYING MANY BULLFROGS CROAKING TEARFULLY FOR THEIR MISSING SPOUSES

6 Point

49 A \$1 00

SWEET YOUNG LADIES OF NEWARK WITH CACOPHONOUS VOICES MUST DISAPPEAR PROFESSOR HENDRIK LIGHTFOOT'S GAY MAIDENS SKIPPING THE LIGHT FANTASTIC INEBRIATED MODN MAKING FACES AS BIRDS SWEETLY WARBLE TO SMILING STAR SCIENTIST DISCOVERED AMPHIBIDUS \$1234567890 MONSTERS AMID GRANDEURS

HOME EDITION

The Cla

No. 9,931

Copyright, 1912, by
The Clarion-Ledger Publishing Co.

MONDAY, SEPTEMB

CONTRACT FOR BUILDING WARSHIPS

CONNECTICUT BUILDERS MAKE BUSINESS TRIP ABROAD TO COMPLETE
DETAILS FOR ENORMOUS NAVAL ARMAMENT

WASHINGTON, Sept. 23—George A. Sims and Silas Young will sail for Russia within the next few weeks, where they hope to close negotiations with the Russian Ministry for the construction of seven battle-ships and their accessories, and with other naval armament, at a cost of \$100,000,000.

Mr. Sims admitted yesterday that Mr. Young and himself would leave for St. Petersburg to discuss and probably conclude negotiations with the Russian government. These negotiations have been in progress several weeks. It was stated, however, that the propositions which Mr. Sims made on behalf of the Martinburgh Steel Company have not been closed. It was known among the large shipbuilders

of the world that Russia proposes to begin immediately the reconstruction of her navy and tentative propositions have been given by several English and German concerns.

WHAT CONSTITUTES A SUBSCRIBER

AN INTERESTING COURT DECISION RENDERED IN THE
STATE OF MASSACHUSETTS

A court decision has lately been rendered in Massachusetts on what constitutes a subscriber. The judge held that the man who received the paper, although he never subscribed, must pay for it. It appears that James Thompson moved, and William

contest between William John Maher, the Aust 8:30 the club building and Thirty-ninth street to the roof with spect ages, had announced t police stationed at the men with him, all in

GAVE AW
ENTIRE

The firm for which trusted employee for decade has discovered system of writing che sums than the check cated he had taken at their money, accordin made and his former tached his bank accou safe, the contents of

AUTO SUPERIOR TO
HORSE IN FAIR TESTAFTER TWO DAYS OF EXPERIMENT
MACHINE PROVES CHEAPER
AND MORE DURABLEENTRANTS IN THE FAMOUS WANNACOOPER CUP
EVENT REEL OFF LIGHTNING TRIALS
DRIVERS READY TO RACE

With a view of showing the economy, speed and reliability of the motor car over the horse-drawn type of vehicle, and the operative cost of same, the Moto-car Company is conducting an interesting test in which a Moto-car and a horse-

GHOST MADE JANITO
FORGET HIS DEAR

SECOND WIFE SAYS THESE MADE HIM DI

FIGHT FOR ESTATE EVOKES STARTLING AND SENSATIONAL TEST!
POWER OF THE SPIRITIST BELIEF AND SPIRIT MESSA

(Special to The Clarion-Ledger)

WINDYS LOCKS, Sept. 23—Gray twilight shadows gave a spooky air to the town hall on Oak street yesterday as there was told the astounding tale of a ghost wife sending from the grave messages of re-

the man. He died last years, leaving more th was the founder of th main offices in Sarana In the Saranac branch Miss Elsie Green, con

Lining Gothic No. 544

60 Point

3 A \$5 35 4 a \$3 35 \$8 70

GRIND Coarse

54 Point

3 A \$4 95 5 a \$3 80 \$8 75

Barons REFUSE

48 Point

3 A \$3 90 6 a \$3 60 \$7 50

UMPIRES Chosen

42 Point

4 A \$3 40 6 a \$2 85 \$6 25

Aspirant EXAMINED

36 Point

4 A \$2 60 7 a \$2 40 \$5 00

DETECTIVE Found Clue

30 Point

5 A \$2 25 9 a \$2 05 \$4 30

Pirates SNEAK

12 Point

14 A \$1 30 28 a \$1 45 \$2 75

DESTROYS SHIPMENTS
Plain \$1234567890 Figures

24 Point

6 A \$1 80 12 a \$1 75 \$3 55

EASTERN TRAINS
Imports Much Paper

10 Point

17 A \$1 20 36 a \$1 30 \$2 50

WISEST ENGLISH AUTHORITY
New American Materials Satisfied
Foremost European Philanthropist
Advertisements Please Customers

18 Point

9 A \$1 50 19 a \$1 75 \$3 25

REFORMED CRIMINAL
Overtake Hungry Badger

8 Point

18 A \$1 05 38 a \$1 20 \$2 25

GERMAN COUNT HIGHLY PLEASED
Bank Wrecker Got Maximum Sentence
Scientific Exhibitions Given Every Hour
Opera Singer Played Long Engagement

14 Point

12 A \$1 40 25 a \$1 60 \$3 00

CLEAREST GOTHIC FACES
New England Folks Gathering

6 Point

18 A \$0 90 40 a \$1 10 \$2 00

CONSTABLE SERVED TOWN NINE YEARS
Young Scientist Betrayed Wealthy Importers
New York Delegation Enjoyed Trip to Arizona
Hunter Disposes \$1234567890 Ancient Relics

Lining Gothic Nos. 519, 527, 528, 529

18 Point No. 519

10 A \$1.55 20a \$1.75 \$3.30

USEFUL GOTHIC SERIES HELPED PRINTING
Purchased Great Amount of Machinery in Idaho
Handsome American Borders Pleased Everybody

12 Point No. 519

16 A \$1.35 32a \$1.50 \$2.85

NOTICE MARVELOUS CHANGE
Honest Butchers Returned Today
Banquets Grand Civil War Veteran
Prominent \$1234567890 Figures

6 Point No. 519

22 A \$0.90 44a \$1.10 \$2.00

NEW NATURAL HISTORY PROVED INTERESTING
Corrects Spacing and Justification of Reset Lines
Fire Department Makes Record While Practicing
Heavy Storm \$1234567890 Caused Great Damage

6 Point No. 529

26 A \$1.00

USEFUL TITLE SERIES DELIGHTED CUSTOMERS
BRIGHT MAGAZINE AND NEWSPAPER HEADING
INTERESTING DIPLOMATIC ABILITY PRODUCED
AMERICAN PRODUCT SHOWS REAL DURABILITY

10 Point No. 519

19 A \$1.25 38a \$1.35 \$2.60

PROPER ADVERTISEMENTS INCREASE
Making an Exceedingly Strong Display Letter
High Tornado Destroyed Largest Structures
Substantial Foundation Laid for the Building

6 Point No. 528

33 A \$1.00

INTERESTING SOUVENIRS BEING CAREFULLY DISTRIBUTED
ENTHUSIASTIC BOYS PRESENT SPLENDID BRONZE MEDALS
PICTURESQUE COSTUME ADORNS GALLANT MASQUERADER
SUPERIOR MATERIALS CAUSING A GENERAL SATISFACTION

8 Point No. 519

20 A \$1.05 40a \$1.25 \$2.30

SUBMIT VERY NICE SPECIMENS FREQUENTLY
Prosperous Owner Met Representative at Long Beach
Startling Beauty Ingeniously Exhibited Predominating
Case Hardened Armor Plate Used on Latest Warship
Shells from Heavy Guns Hit Small Target Frequently

6 Point No. 527

43 A \$1.00

BROADMINDED LEGISLATORS DENOUNCING UNREASONABLE PLATFORMS
INDIGNANT STOCKHOLDER VOTED FOR THE REORGANIZATION OF COMPANY
DISTINCTIVE PRINTING DEMANDS THE CHARMING AMERICAN LINE DESIGNS
IMPROVED TRANSPORTATION FACILITIES IS PROMISED SURURRAN TRAFFIC

Commercial Gothic

24 Point

3 A \$1.70 6a \$1.80 \$3.50

DISTRICT PRINTERS
Manufactures Binder

20 Point

4 A \$1.50 9a \$1.85 \$3.35

NUMEROUS UPRISINGS
Inspect American House

18 Point

5 A \$1.45 12a \$1.90 \$3.35

HANDSOMEST
Bought Gothics

12 Point

8 A \$1.20 18a \$1.60 \$2.80

BAND CONCERT
Fine Sailor Signs

10 Point

10 A \$1.15 20a \$1.45 \$2.60

EXTEND NEW ROAD
Built Largest Station

14 Point

6 A \$1.25 18a \$1.75 \$3.00

SECRET MINERS
Largest Detective
Captured Burglar

8 Point

12 A \$1.00 24a \$1.25 \$2.25

BOUGHT MODERN TYPES
Receive Handsome Design
Best \$1234567890 Facts

72 Point

3 A \$4 25 4 a \$2 75 \$7 00

DESIGNED Buildings

60 Point

3 A \$3 50 6 a \$3 50 \$7 00

Manufacture FENCINGS

48 Point

5 A \$3 20 9 a \$3 05 \$6 25

EXTRAORDINARY Comparison

36 Point

5 A \$1 85 10 a \$2 40 \$4 25

American Producer DISTINGUISHED

30 Point

7 A \$1 75 14 a \$2 25 \$4 00

ERECTED STRUCTURE
Readily Proved Claims

12 Point

22 A \$1 25 45 a \$1 50 \$2 75

CONSTRUCTS BEAUTIFUL BUILDING
Leaves Southern Farming Region Today
Highest Prices Obtained at Auction Sale
Useful and \$1234567890 Distinct Face

24 Point

10 A \$1 80 19 a \$1 75 \$3 55

CAREFUL METHODS USED
Showing Prominent Display

10 Point

25 A \$1 15 54 a \$1 35 \$2 50

MONSTER CROCODILE ESCAPED FROM BOY
Several Miners Caught by Landslide in Wyoming
Longest Railroad Passenger Train Moved Slowly
Great Gambling Scheme Unearthed by Detective

18 Point

12 A \$1 40 24 a \$1 85 \$3 25

CONTAIN STRONG FEATURES
Provide Marvelous Printing Idea

8 Point

32 A \$1 05 65 a \$1 20 \$2 25

GREATER EXPOSITION OPENING CAUSED MUCH RELIEF
Bought Lining Gothic Number Five Hundred and Twenty Four
Imported Diamonds Bring High Tariff Duties for Governments
Swift Sailing Yacht Rounding Cape Horn Under Full Headway

14 Point

19 A \$1 40 38 a \$1 60 \$3 00

NEWSPAPER ADVERTISEMENTS REPAYED
Desperate Character Easily Outruns Police
Courts Decide Against Crafty Safeblowers

6 Point

31 A \$0 95 63 a \$1 05 \$2 00

PROSPEROUS TOURISTS TRAVEL THROUGH TURKEY IN STYLE
Larger Bullfrogs Croaking Hoarsely for Their Wandering Spouses
Inebriated Moon Hides His Face Behind Dense Cloud for Shy Lovers
Much Applause Greet Clever Caricaturists in Vaudeville House Lately
Great Baseball Pitcher Who has Marvelous Control Trained in Texas
Highest Salaries Paid \$1234567890 Managers with Executive Ability

GREAT SALE OF SPRING HATS

These hats are from one of New York's leading importers and creators of millinery. We mention a few of these bargains here but all will be sold at

<p>Ribbons in plain colors plaids, stripes 10c up</p>	<p>Exceptionally Low Prices</p> <p>\$5.00 to \$7.00 Trimmed Hats, the best American made hat ever sold at only \$2.98 \$13.50 to \$15.00 Trimmed Hats, Paris Importation of good grade and design, only \$8.48 \$30.00 to \$50.00 Finest Parisian Trimmed Hat ever offered at this price \$20</p>	<p>Flowers all the latest kinds, special 15c up</p>
---	---	---

MERMOND DRY GOODS & MIL
EXCLUSIVE MILLINERY :: Center Street ::

PUBLIC LIBRARY DEDICATION

Monday
Evening
April 16

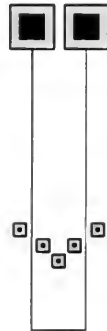

DEDICATION ADDRESS
SAMUEL P. WORTH
MUSIC

ANNOUNCEMENT

To Those About to Entertain

□ "Such and so various are the tastes of women" □

In the usual interchange of hospitality and merrymaking in polite society the success of social gatherings is greatly added to by appropriately printed invitations, programs, menu cards, place cards, or anything of that kind. From my shop I can furnish you with artistically printed things and for special entertainments I can furnish printing that will harmonize with the general color scheme and decoration.

MARSH FAIRBANKS & CO
AT THE SIGN OF THE ELECTRIC LIGHTS, ERMINE, TE

You Are Hereby Invited

to freely make use of
any of the books and
magazines belonging
to the Maldus Library

Board of Trustees Library Association

Inland Gothic No. 6

24 Point

6 A \$1 85 10 a \$1 65 \$3 50

FINEST SAMPLE
Concerns Explorer

20 Point

7 A \$1 60 15 a \$1 65 \$3 25

TOURISTS RESTED
Questions Dictionaries

18 Point

12 A \$1 70 20 a \$1 55 \$3 25

PRESS MODERN TICKET
Numerous Camps Overturn

16 Point

12 A \$1 55 20 a \$1 45 \$3 00

REMARKABLE DRAWING
Picturesque Mountain Scene

14 Point

13 A \$1 45 26 a \$1 55 \$3 00

INCREASING THEIR PROFITS
Careful Attention to Type Display

12 Point

17 A \$1 40 32 a \$1 35 \$2 75

BRIGHT ORIGINAL EFFECT
Erecting Wonderful Structures
Checks \$1234567890 Payable

10 Point

20 A \$1 25 36 a \$1 25 \$2 50

HUMOROUS COMEDIANS LEAVE
Oldest Tree Destroyed by Lightning
American Type Faces Please Critic
Countless Beautiful Ornaments Sold

8 Point

20 A \$1 10 40 a \$1 15 \$2 25

USING STYLISH PRINTING MATERIAL
Producing Latest Specimens with Gothics
Claim Santa Claus Story a Historical Myth
Mother Hubbard Sold Valuable Cupboard

6 Point

22 A \$0 95 46 a \$1 05 \$2 00

WELL KNOWN PRINTER MADE STATEMENTS
Heavy Newspaper and Magazine Advertising Shown
Hebrew Publishers Discussing Prosperity Fervently
Alaskan Miners Get \$1234567890 Under Mountains

5 Point

24 A \$0 95 46 a \$1 05 \$2 00

POPULAR AMERICAN TYPE SERIES ARE PROFITABLE AND PLEASING
Buys this Valuable Face Without Delay for Beautiful and Distinct Work
Many Printers Caught Large Catfish While in Camp on Walthonding River
Cement Pavements Caused Husky Farmer Great Torture While Walking
Trustworthy Manufacturers Holding Good Cheer Meeting in Schoolhouse

TITLE GOTHIC No. 7

20 Point

9 A \$2 25

MICHIGAN ORPHEUM OPENED

18 Point

11 A \$2 00

MOST COMPLETE LOT OF GOTHICS

14 Point

(Cast also as 18 Point No. 72 14 A \$2 00)

15 A \$1 75

LABOR SAVING SYSTEMS FOR THE PRINTERS

12 Point

16 A \$1 50

DESIGNERS OF TYPE SERIES
HANDY \$1234567890 TYPES

6 Point No. 71

24 A \$1 00

PRINTERS CONTINUALLY PICKING LIVE JOB
MOST REMARKABLE PROFIT-MAKING FACES
PROMINENT PUBLISHERS DESIRE QUALITY

10 Point

(Cast also as 12 Point No. 72 19 A \$1 50)

20 A \$1 40

ALL PRINTERS ADMIRE OUR TYPE
THE MOST DURABLE EVER MADE

6 Point No. 72

28 A \$1 00

HUGE STEAMSHIP REMODELED AND SENT EASTWARD
INTERESTING STATEMENT REGARDING OLD COMPANY
FINANCIAL GIANTS STARTLE FOREIGN SHIPPING FIRMS

9 Point

(Cast also as 12 Point No. 73 22 A \$1 50)
(Cast also as 10 Point No. 72 25 A \$1 40)

20 A \$1 25

LABOR SAVING MATERIAL FOR PRINTERS
THE LINING SYSTEM WILL SAVE LABOR

6 Point No. 73

35 A \$1 00

IMPROVED TRANSPORTATION FACILITIES ARE PROMISED SHORTLY
ENTERPRISING MEASURES PLANNED BY EXPERIENCED STATESMEN
HUMOROUS QUESTIONS ANSWERED IN A GOOD-NATURED MANNER

8 Point

(Cast also as 12 Point No. 74 26 A \$1.50)

25 A \$1 25

NEWSPAPER AND MAGAZINE ADVERTISEMENTS
THESE TYPE STYLES GIVE PROMPT RETURNS

6 Point No. 74

45 A \$1 00

DELIGHTFUL SERIES OF MUSICAL CONCERTS GIVEN IN SPACIOUS GARDENS
CHARMING ENTERTAINERS SUCCEEDED IN LIGHT OPERATIC ROLES LAST MONDAY
TREMENDOUS CROWD OF FASHIONABLY GOWNED WOMEN PROMENADE DAILY

72 Point

5 A \$4.40 8 a \$4.30 \$5.70

HINDERS CERTAIN Great Ideas

60 Point

6 A \$1.10 9 a \$1.85 \$7.95

Reconsiderations PLEASED HOUSE

54 Point

9 A \$3.50 12 a \$4.00 \$7.50

EDITOR REBUKES Magazine Proprietor

48 Point

6 A \$3.05 10 a \$3.20 \$6.25

Invigorating Climate REBUILDING VISITOR

42 Point

6 A \$2.45 11 a \$2.80 \$5.25

MELODRAMATIC WRITERS Review Performance

36 Point

6 A \$1.85 13 a \$2.40 \$4.25

QUALIFICATION EXCEPTIONAL Stylish Elaborate Decorations

18 Point

16 A \$1.45 33 a \$1.80 \$3.25

CONSTABULARY DETACHMENTS ARRIVED University Students Celebrate Birthdays Bacteriological Professor Loses Fortune Aristocratic Organizations Incorporated

30 Point

9 A \$1.70 18 a \$2.30 \$4.00

DANGEROUS CONTENDER ENTERED Advertising Schemes Indispensable

14 Point

20 A \$1.30 45 a \$1.70 \$3.00

POPULAR STATESMAN MAKES SEVERAL VISITS Unsolicited Testimonials Apparently Fictitious Incomparable Bargains Detain Comely Women Lucky Speculators Realize Tremendous Profit

24 Point

12 A \$1.65 21 a \$1.85 \$3.50

BEAUTIFUL OBSERVATORIES CONDEMNED Circumnavigating Tour Interests Couples

12 Point

23 A \$1.20 48 a \$1.55 \$2.75

ACCURATE JUSTIFICATION PREVENTS MUCH TROUBLE Literary Genius Completes Remarkable Biographies Metropolitan Communities Enjoying Decreased Rate Graduating Scholars Receive Flowers \$1234567890

60 Point

7 A \$5 90

EASTERN RESIDENT DECAMPING

48 Point

8 A \$3 90

MONSTER INDUSTRY RECEIVED CHECK

42 Point

8 A \$3 50

HUMOROUS PUBLICATIONS REPROACHED
EDITORS REPORTED WESTERN DISASTER

36 Point

8 A \$2 75

POLICEMAN SUSPENDED WITHOUT CEREMONY
HERALD EXTRA CONDENSED COMPLIMENTED

30 Point

12 A \$2 70

RAILROADS EXTENDING INTERESTS THROUGH HUDSON
PIOUS CLERGYMAN PREACHED INSTRUCTIVE LECTURE

24 Point

16 A \$2 50

HARMONIOUS TYPE INDISPENSABLE
AMERICAN PRODUCTIONS DESIRED

12 Point

28 A \$1 50

NUMEROUS BUILDINGS ERECTED RECENTLY
BANKER SECURED OPTION ON LARGE LANDS
CONTRACTOR REFUSED FLOWERY PROPOSAL
ELABORATE \$1234567890 DEMONSTRATIONS

18 Point

20 A \$2 05

BEAUTIFUL DESIGNS RECEIVED FERVENTLY
PROUD FARMERS REFUSE HELPING HANDS

10 Point

31 A \$1 40

YOUNG MAN INVENTS WONDERFUL FLYING MACHINE
HANDSOMELY DECORATED RUGS ARRIVED YESTERDAY
LARGE IMPORTATIONS CONSTANTLY IMPORTED HERE
PERPETUAL MOTION DISCOVERED THROUGH ACCIDENT

Her Times

FIFTH EDITION

WEDNESDAY, FEBRUARY 27

No. 2,465

JEWELLER SHOT DOWN S CURTISS SLAIN IN SIGHT OF MANY IN UPTOWN STREET

ASSASSIN RESENTING ALLEGED INSULT

Jeweller, with a place Twenty-third street y, was shot down and yesterday afternoon Sixth street near Sixth ailant, a negro, gave George Davis and de- licie that the jeweller n had insulted him, mployed in an auction 75 West Twenty-first

street, was sent on an errand shortly before 3 o'clock. He returned with his purchases and then got a revolver. He left the store, walking in the direction of Sixth avenue.

Less than one hundred feet from the store was Curtiss and a man who gave his name as Frank Hagerty and said he lived at No. 1391 Seventh avenue. The men were walking in the same direction as the negro. On the opposite side of

MET IN HOSPITAL NOW DOCTOR WILL WED HIS PATIENT

COLLEGE CHUMS ARE INVITED TO BE PRESENT

YOUNG PHYSICIAN MADE RECORD AS ATHLETE WHEN A STUDENT

Miss Dorothy Orth, daughter of Mr. and Mrs. Louis H. Orth of No. 54 East Ninety-seventh street, and Dr. George F. Garmer of Watertown, N. Y., are to be married this evening. Two years ago Miss Orth was a patient at the Kohnemann Hospital. Dr. Garmer, fresh from medical school, was an interne there at the time. The two met and liked each other instantly. When Miss Orth left the Kohnemann Hospital her health was

SEVERE JUSTICE VES TWO YOUNG MEN LONG SENTENCES

arettes in an elevated g on the floor when a them, two men were ht Court to the work- s each, by Magistrate ing last night. rthbound, stopped at the rush hour at 6:55 d the two men got on ere in a crowded car, e faces of passengers Andrew McCaffrey, a o make them behave, six passengers testi- e prisoners, who said ough, a clerk of No. undred and Eightieth hlater, an employee ment store of No. 21 en nearly collapsed.

AMINE BROKEN

17. Boston's lobster broken by the arrival ston from Yarmouth, es of lobsters. Today

BIGGEST MEXICAN BATTLE DOUGLAS AGAIN UNDER FIRE

DESPERATE INSURRECTOS REPULSE FIERCE ATTACK CAPTURE FEDERALS' MACHINE GUNS

More than half of Douglas was under fire to-day by Mexican Federal troops, who made no attempt to obey the warn- ing of the citizens that the lives of this lovely city's residents must not be

endangered in fights on the border with Mexican insurrectos. Six men and one woman in Douglas were injured. Shots fell a mile from the international line. Eleven hundred Mexican Federals, with



WEATHER FORECAST

FAIR TO-NIGHT AND TO-MORROW; RAIN FRIDAY NIGHT; SATURDAY CLOUDY.

Average temperature yesterday59
Average temperature for corresponding date last year.....56
Average temperature for corresponding date last ten years...54
Average temperature for same day last thirty-three years...52

48 Point

5 A \$3 00 9 a \$3 25 \$6 25

HARMONIZED **Compartment**

42 Point

5 A \$2 40 10 a \$2 85 \$5 25

Discovered **CURIOUS DOCUMENT**

36 Point

6 A \$2 10 10 a \$2 15 \$4 25

ENTERPRISING **Institutions Advanced**

30 Point

7 A \$1 85 14 a \$2 15 \$4 00

SOUTHERN RAILROADS IMPROVED SYSTEM Historical Exhibit Pleased Country Residents

24 Point

9 A \$1 65 17 a \$1 85 \$3 50

CONTRIBUTIONS FROM BENEVOLENT SOCIETIES Important Politician Refused Nomination Recently

18 Point

14 A \$1 50 27 a \$1 75 \$3 25

HUMOROUS EDITION SUSPENDED Editor Severely Criticised Preachers

9 Point

29 A \$1 15 58 a \$1 35 \$2 50

DISTINGUISHED WINTER GUESTS RETURN HOME Rich Bankers Absolutely Refused Special Invitations Grand Reception Tendered Departing Married Couple Matrimonial Question Discussed by Anxious Mother

14 Point

20 A \$1 50 34 a \$1 50 \$3 00

BEAUTIFUL YOUNG LADY MUCH ADMIRER Printers Quickly Recognize American Faces Discontented Soldier Returns to His Family

8 Point

29 A \$1 00 58 a \$1 25 \$2 25

ENTHUSIASTIC FEMALES DENOUNCE POLITICAL CLUBS Various Lady Newspaper Reporters Make Strong Demand University Students Unanimous Regarding Denunciation Extraordinary Interest Manifested in Political Exposures Members Heartily Congratulate Handsome Young Leader

12 Point

23 A \$1 25 45 a \$1 50 \$2 75

INCONSISTENT GENTLEMAN REFUSED COURTESIES Gifted Orators Delivered Wonderful Lectures Abroad Save Expenses by \$1234567890 Buying New Type

6 Point

31 A \$0 90 63 a \$1 10 \$2 00

INTERESTING HISTORICAL STORIES RELATED BY YOUNG PUPILS Prosperous Merchants Advertise Extensively Throughout the Country Obtain Good Results by Using Best Materials Such as American Types Recent Designs Produced Certainly Denote Remarkable Advancement Satisfactory Material Combined With Experience Brings Good Results Valuable Time and Money \$1234567890 Can be Saved if you Desire

10 Point

25 A \$1 15 50 a \$1 35 \$2 50

DISTINGUISHED LAWYER CONDUCTED INVESTIGATIONS Numerous Schemes Unearthed by Modest Newspaper Man Several European Acrobats Displaying Remarkable Energy

5 Point

28 A \$0 90 55 a \$1 10 \$2 00

CONTINUOUS GRAND PERFORMANCE BY CELEBRATED NEW JERSEY ACTORS Excited Citizens Surround Theatre Anxiously Awaiting Introduction of Great Star Many Institutions Discontinue Business, Thereby Increasing the Large Audience Decayed Vegetables and Superannated Eggs Quickly Became Necessary Articles Authorities Maintain that Rubeville Never Experienced Such Extraordinary Levity Curtain Descends and the Sheriff with His Many Trusty Deputies Acts as Escort

CONDENSED TITLE STAR GOTHIC

48 Point 6 A \$3 75
GOTHIC DESIGN STRIKING

42 Point 6 A \$3 25
USEFUL CONDENSED TYPES

36 Point 7 A \$2 75
SHOWING AMERICAN QUALITIES

30 Point 9 A \$2 50
PRINTERS REQUIRE DISTINCT FACES

24 Point No. 2 12 A \$2 50
DELIGHTFUL ENTERTAINMENTS PLEASING

24 Point No. 1 14 A \$2 50
NEW SUBMARINE SUBMERGED FOR LONG PERIOD

18 Point No. 3 16 A \$2 00
SETS CHARMING SPECIMENS
DISCOVERS NORTH AMERICA

12 Point No. 3 31 A \$1 50
CAPTURED SIXTY DESPERATE CHARACTERS
BOLD THIEVES ENTERED INHABITED HOUSE

18 Point No. 2 19 A \$2 00
READING MARVELOUS HISTORIES
STEAMERS WHISTLED FOR HELP

12 Point No. 2 36 A \$1 50
STARVING INDIANS WANDERED INTO SACRAMENTO
REPORTS HEAVY FIRING AT WAR HEADQUARTERS

18 Point No. 1 21 A \$2 00
SIDETRACKED OBSERVATION TRAINS
MODERN LODGING HOUSE RENAMED

12 Point No. 1 40 A \$1 50
CHARACTERISTIC DESIGNS ACKNOWLEDGED YESTERDAY
MONSTER GATHERING CROWDED IN THE GRANDSTANDS

12 Point No. 5 23 A \$1 50
RELIABLE STYLES PRESENTED TO PUBLIC
HONORABLE \$1234567890 COURTSIPS

6 Point No. 4 36 A \$1 00
INTERESTING SPEAKER HELD HIS LARGE AUDIENCE SPELLBOUND
CONDENSED TITLE STAR GOTHIC SERIES FOR BEAUTIFUL WORK
OLD GUTENBERG BIBLE \$1234567890 SOLD AT PUBLIC AUCTION

12 Point No. 4 28 A \$1 50
GERMAN PRINTER SUBMITS MANY NICE SPECIMENS
HOT WEATHER PREDOMINATING IN SOUTH INDIANA

6 Point No. 3 44 A \$1 00
SWEET YOUNG LADIES OF NEWARK WITH MASCULINE ESCORTS DISAPPEAR
PROFESSOR STRONGARM AND COMPANY TRIP THE LIGHT FANTASTIC DAILY
AMERICAN PRODUCTS ALWAYS EXCEL IN DURABILITY AND ATTRACTIVENESS

6 Point No. 2 45 A \$1 00
ARTIFICIAL LAKE SURROUNDED WITH FRAGRANT CANYATIONS AND ROSEBUSHES
CHARMING ENTERTAINERS SCORE GREAT SUCCESS IN LIGHT OPERATIC ROLES
SUMPTUOUS APARTMENTS APPROPRIATED BY THE PROFESSIONAL MARATHONER

6 Point No. 1 54 A \$1 00
MINDFUL AND ORIGINAL SCENIC TEXTS PERFORMED BY FAMOUS STYLISH DIGHT
FIRST APPEARANCE OF BRILLIANT ACTORS AT MADISON SQUARE GARDEN BY WENTWORTH
DIBBETH'S CONFIRMATION STARTED FROM DYNAMITE EXPLOSION IN GEMENT OF H. L. L.

84 Point

3 A \$3 70 5 a \$3 20 \$6 90

CONDENSED Reliable Series

72 Point

4 A \$3 50 6 a \$3 25 \$6 85

Designers Highly INTERESTING

60 Point

4 A \$3 15 6 a \$3 10 \$6 25

NEWSPAPER Headings Instructive

54 Point

6 A \$3 40 11 a \$1 10 \$7 50

Building Modern Stable HEADQUARTERS

48 Point

6 A \$2 85 11 a \$3 40 \$6 25

KINDERGARTEN Children Enjoyed Sunshine

42 Point

7 A \$2 40 13 a \$2 85 \$5 25

Advertise Best MAGAZINES

24 Point

12 A \$1 45 24 a \$2 05 \$3 50

CLEVER FIGHTERS BADLY INJURED
Umpire Gives Unpopular Decision

36 Point

7 A \$2 00 13 a \$2 25 \$4 25

DISTINGUISHING LIGHTHOUSES
Reliable Conditions Mentioned

18 Point

18 A \$1 45 33 a \$1 80 \$3 25

LIGHTNING STRUCK CHURCH DURING STORM
Juvenile Runaway Captured After Tussle

30 Point

9 A \$1 80 17 a \$2 20 \$4 00

STARTLING DISCLOSURES REVEALED
Guests Remained Quiet During Stay

14 Point

23 A \$1 30 46 a \$1 70 \$3 00

STARVING NEGROES RECEIVED MUCH CHICKEN PIE
Large Bowling Scores Made at Roscoe Tournament

12 Point

27 A \$1 20 53 a \$1 55 \$2 75

HANDSOME SPECIMENS RECEIVING FIRST PRIZE IN CONTEST
Warm Climate Found in Bermuda During Winter Months
Useful and Heavy \$1234567890 Condensed Figures Shown

72 Point

4 A \$3.85

BOUGHT EXTRA CONDENSED

60 Point

4 A \$3.60

INCLUDES CHARMING PRINTER

54 Point

7 A \$4.25

NEWSPAPERS GIVE FINE HEADINGS

48 Point

8 A \$3.75

FOREMAN MAKES EXQUISITE SELECTION

42 Point

8 A \$3.25

MORE REMARKABLE METHODS UNEARTHED

36 Point

9 A \$2.75

MAGAZINE ADVERTISEMENTS PROPERLY DISPLAYED

30 Point

11 A \$2.50

ANCIENT FACES ARE REPLACED

16 Point

26 A \$1.75

COMPOSITORS GIVEN DELIGHTFUL BANQUETS
USED THIS RENOWNED SERIES EXTENSIVELY

24 Point

17 A \$2.50

ORIGINAL NOVELTIES FORTHCOMING

12 Point

30 A \$1.50

ARTISTIC SPECIMENS REPAYED CAREFUL PRINTER
WINTER SAVINGS \$1234567890 SPENT AT CONEY

20 Point

23 A \$2.25

CONTAINS DISTINCT FEATURES THROUGHOUT

10 Point

37 A \$1.40

DECORATIVE MATERIALS USED EXTENSIVELY FOR DISPLAYS
GOTHIC TYPES MAKING ADVERTISEMENT PRINTING POPULAR

72 Point

3 A \$3 75 5 a \$3 10 \$6 85

BEAUTIFUL FLOWERS
Exclusive Confection

60 Point

3 A \$3 20 6 a \$3 45 \$6 65

HANDSOMEST CHILDREN
Shipwrecking Fishermen

48 Point

6 A \$3 05 10 a \$3 30 \$6 35

NORTHERN EMIGRANTS INVEST
Daily Continuous Performances
Grandest Astronomical Display

42 Point

7 A \$2 60 10 a \$2 65 \$5 25

MECHANICS MODELING STEAMSHIP
Inventors Noteworthy Contribution
Enthusiastic Americans Receptions

36 Point

7 A \$2.00 13 a \$2.25 \$4.25

**BINGHAMTON ORGANIZES LEADING POETS
Numerous Artistic Typographical Students
Youthful Gourmands Matured Dyspeptics**

30 Point

9 A \$1.80 16 a \$2.20 \$4.00

**AMERICAN TYPE FOUNDERS COMPANY ORNAMENTS
State Ultimately Rewards Conscientious Workmen
Procrastination and Ambition are Impossible Mates**

24 Point

11 A \$1.55 22 a \$2.00 \$3.55

**DEMANDING EXTRAORDINARY ADVERTISING IN PUBLICATIONS
Burlesque Maidens Demand Increased Wages of Management
Foreign Characteristics Produced in Metropolitan Art Lately**

18 Point

16 A \$1.40 34 a \$1.85 \$3.25

**TREMENDOUSLY UNREASONABLE PRICES ASKED FOR NORTH POLE FLOWERS
Financial Troubles Should Be Stimulating Enough to Create Further Ambition
Condensed Advertising Work Demands Type Like Alternate Gothic Number One**

14 Point

24 A \$1.30 48 a \$1.70 \$3.00

**SEVENTY THOUSAND BEAUTIFUL STRUCTURES DEMOLISHED DURING THE PROLONGED EARTHQUAKE
Much Interest Experienced at the Academy of Science by Exhibiting Metallic Article Specimens
Many Demoralizing Circumstances Readily Eliminated Through the Discharge of Leading Agitator**

12 Point

25 A \$1.25 50 a \$1.50 \$2.75

**EXPERIENCED CHORUS GIRL DECLARES HER INDEPENDENCE
Spring Sunrise Imparts Lovely Blushes to Dimpled Cheeks
Valuable Parliamentary \$1234567890 Documents Missing**

8 Point

32 A \$1.05 63 a \$1.20 \$2.25

**FINE CONDENSED GOTHIC FOR GENERAL DISPLAY ADVERTISING
Wonderful Steamboat Rides Taken Along Beautiful Missouri River
Financial Giants Procuring Magnificent Headquarters in Baltimore
Interesting Statement Made Ouring Fiscal Year Concerned Taxes**

10 Point

30 A \$1.10 60 a \$1.40 \$2.50

**COUNTRY CONVENTIONS PROFUSE WITH HANDSOME DECORATIONS
Two Renowned College Professors Introduce Popular Resolutions
Brilliant Entertainments Proposed for the Coming Winter Season**

6 Point

35 A \$0.90 70 a \$1.10 \$2.00

**REMARKABLE EXPEDITIONS PERFORMED BY PROMINENT OCEAN NAVIGATORS
Enthusiastic Students Present Splendid Ornaments to Great Hebrew Professor
Superior Material Always Brings General Satisfaction Whenever Properly Used
Industrious Compositor Saved \$1234567890 for the Trip to European Countries**

72 Point

3 A \$4 30 4 a \$2 85 \$7 15

MODERN DESIGNS
Scene Remarkable

60 Point

3 A \$3 40 5 a \$2 95 \$6 35

CHARMING SPECIMEN
Players Extraordinary

48 Point

5 A \$3 10 9 a \$3 15 \$6 25

DISTINGUISHED FOREIGNER
Entertain English Merchant

42 Point

6 A \$2 80 9 a \$2 55 \$5 35

DESIGNS HANDSOME PICTURES
Enthusiastic Audience Delighted
Delightful Story Printed Monday

36 Point

6 A \$1 90 12 a \$2 35 \$4 25

**PERFORMANCES AMUSED AUDIENCE
Honored Prominent American Senator
Grand Mansions Recently Demolished**

30 Point

8 A \$2 00 13 a \$2 00 \$4 00

**ENTERTAINMENTS UNDOUBTEDLY HUMOROUS
Produced Extraordinary Handsome Specimens
During Summer Delightful Excursion Arranged**

24 Point

9 A \$1 60 18 a \$1 90 \$3 50

**PROMINENT MEMBERS RECEIVE BEAUTIFUL SOUVENIRS
Artistic Printer Producing Magnificent Border Designs
Distinguished Easterner Opens Photographic Exhibition**

18 Point

15 A \$1 50 30 a \$1 75 \$3 25

**BEAUTIFUL SINGERS WIN APPLAUSE
Enormous Crowds Attend Exhibitions
Interesting Plants Were Discovered**

10 Point

26 A \$1 15 52 a \$1 35 \$2 50

**SEVERAL STRIKING LIBRARIES CONSTRUCTED
Unconsciously Exposing Unpopular Ownership
American Type Founders Company Brass Rule
Our Ornaments and Borders Always Charming
Boston Wire Stitchers Pleased Crafty Buyers**

14 Point

20 A \$1 35 41 a \$1 65 \$3 00

**ANTICIPATE DELIGHTFUL ENTERTAINMENT
English Electricians Hold Annual Convention
Remarkably Enthusiastic Demonstration Held**

8 Point

29 A \$1 00 58 a \$1 25 \$2 25

**MOST MODERN PRINTERS DEMAND ORIGINAL SPECIMENS
Prominent Citizens Entertaining President with Shad Supper
Extraordinary Characteristics Lately Developed in Drawings
Several Distinguished Compositors Visiting Lake Hopatcong
Unprejudiced Managers Securing Lovely Burlesque Maidens**

12 Point

24 A \$1 20 48 a \$1 55 \$2 75

**MANUFACTURERS WILL EXHIBIT VARIOUS MACHINES
Tremendous Reception Given Famous Baseball Players
Manager Engages \$1234567890 Grand Vaudeville Star**

6 Point

33 A \$0 90 65 a \$1 10 \$2 00

**EUROPEAN WRESTLER DEVELOPS MARVELOUS LIGHTWEIGHT STUDENT
Councilmen Seriously Consider Numerous Subway Propositions Monday
Curious Scheme was Nicely Described to Interested Suburban Resident
Enthusiastic Pedestrian Chosen to Present Inscribed Souvenirs to Girls
Seventeen Magnificently Gowned Women Parade on Amsterdam Avenue
Holiday Expenditures Caused \$1234567890 Many Happy Girls and Boys**

Strength of Printing



Concerning Effective Display

Obtained through
the use of
the Alternate
Gothics

In this rush and roar of our twentieth century commercialism it is essential that display in advertising has strength and character that recognition may be obtained. The strong and virile characters of the dignified and versatile Alternate Gothics will enable every printer to produce advertising with stronger display and tone that will demand attention anywhere. If you desire strength and character in your product add this useful gothic family to your composing room. It will enable you to give just the right display in the right place. They have been properly called the gothic family par excellence. They have the style and finish to be seen in all of the beautiful and versatile type faces which are continually being originated by this Company. Emphasis is the thing desired in publicity of any kind and is obtained only through original faces and strong display



In Strength of
Character
and Beauty of Line
These Excel

American Type Founders Company

ARROW DAY

EACH WEEK DAY DURING MONTH OF MARCH

Here you may choose from stocks, on display or accessible for selling, far greater than the combined stocks of ALL the other department stores in the city, at prices readily appreciated by people thoroughly familiar with market conditions in this country. Our motto is: Everything for Everybody

Men's and Boys' Hats
and Woolen Goods ➔

Cut Glass, Carpets ➔

Kitchen Utensils, Fine
Domestic Lingerie ➔

Boots, Shoes, Toys ➔

Table Ware, Furniture
Draperies, Jewelry ➔

1912 MARCH 1912						
Sun	Mon	Tue	Wed	Thu	Fri	Sat
					1	2
3	4	5	6	7	8	9
10	11	12	13	14	15	16
17	18	19	20	21	22	23
24	25	26	27	28	29	30
31						

Sectional Calendar
No. 6—\$3.00

At Service Desk, on Main Floor, Howard Street side, we have placed our express agent, who will receive express packages for all express companies, and accept money in prepayment, for which we will give you our receipt, saving you all the trouble of having express wagon call at your home. We will take care of any package, whether bought here or not, so that people will feel at home

ROPLEY DEPARTMENT STORE

ROCHESTER AND HAMBURG AVENUES

Twentieth Century Quality Store for People with Refined Taste

72 Point

3 A \$4 95 4 a \$3 25 \$8 20

HUDSON SHORE
Chesapeake Bay

60 Point

3 A \$4 30 4 a \$2 90 \$7 20

CHARLES DICKENS
Safest Investment

48 Point

5 A \$3 25 8 a \$3 20 \$6 45

AMERICAN EXPOSITION
Rocky Mountain Scenes

42 Point

5 A \$2 65 9 a \$2 85 \$5 50

STRONGEST ADVERTISERS
Brave Soldiers Dismounted
Constructed Ancient House

36 Point

6 A \$2 25 9 a \$2 05 \$4 30

KLEPTOMANIAC PERFORMANCE **Attractive and Distinctive Display** **Considerably Increases Business**

30 Point

7 A \$1 95 12 a \$2 15 \$4 10

FOREIGN DEMONSTRATOR RECOGNIZED **Ancient German Industry Demonstrated** **In Our Printing Department on First Floor**

24 Point

8 A \$1 70 15 a \$1 85 \$3 55

CONDUCTED UNDER STRANGE CIRCUMSTANCE **Lifeboats are Finally Launched and Some Seven** **Hundred Women and Children Leave the Vessel**

18 Point

12 A \$1 45 25 a \$1 80 \$3 25

COMMISSIONERS EXAMINATION **Largest Shipment From English** **And French Pottery Shops Lost**

10 Point

23 A \$1 10 46 a \$1 40 \$2 50

DEVELOPMENT OF THE SUGAR INDUSTRY **Has Made Rapid Strides During the Last** **Century and Thousands of Workmen are** **Employed in Sugar Refineries East and** **West; Many Million Dollars are Invested**

14 Point

18 A \$1 40 35 a \$1 60 \$3 00

INTERESTING MAGAZINE ARTICLES PAID **Catalogue of Handsome Prizes Offered** **For Short Stories of Life in the South**

8 Point

27 A \$1 05 54 a \$1 25 \$2 30

TYPE, BORDERS, ORNAMENTS, PRINTING MATERIAL **Ordered from the American Type Founders Company** **Excel in Design, and Their Durability is Assured by** **Use of the Best of Material. A Print Shop Equipped** **Completely With its Production is Worth Something**

12 Point

20 A \$1 25 40 a \$1 50 \$2 75

IMPORTED CROCKERY AND PORCELAIN GOODS **Lately Received at the Marshall Wickersham** **Stores, also Useful and Ornamental Glassware** **Challenge Sale \$1234567890 Prices Reduced**

6 Point

30 A \$0 90 60 a \$1 10 \$2 00

EVERY PROGRESSIVE PRINTER WILL CONCEDE IT FAR BETTER **Policy to Have a Series or Two of Full Cases Rather Than Six** **or Eight Series of Job Fonts. This is About the Proportion at** **Which This Condition Should be Used in the Determining of** **What Faces Can be Used Under Special Requirements and it** **Would Seem that the Alternate Gothic is a Desirable Face for** **Any Job Office to be \$1234567890 Plentifully Supplied With**

Lining Gothic No. 545

72 Point

3 A \$8 20 4 a \$4 80 \$13 00

FIND Bride

60 Point

3 A \$7 05 4 a \$4 00 \$11 05

Silver KINGS

54 Point

3 A \$5 65 4 a \$3 10 \$8 75

PRINCE Arthur

48 Point

3 A \$4 55 5 a \$2 95 \$7 50

Greatest PROFIT

42 Point

3 A \$3 45 6 a \$2 95 \$6 40

MODERN Designer

36 Point

4 A \$2 85 6 a \$2 15 \$5 00

Back BENT

14 Point

11 A \$1 45 22 a \$1 55 \$3 00

**SHOWING STYLES
Have Delicate Aroma**

30 Point

5 A \$2 55 8 a \$2 00 \$4 55

BIRD Walking

12 Point

13 A \$1 35 26 a \$1 40 \$2 75

**CHARMED STUDENTS
Reprints \$1234567890**

24 Point

6 A \$1 90 10 a \$1 60 \$3 50

**HUNTING STYLE
Draw Good Buyers**

10 Point

15 A \$1 15 30 a \$1 35 \$2 50

**UNIVERSITY LIBRARIES
Contain Useful Information**

9 Point

18 A \$1 20 36 a \$1 30 \$2 50

**GUTENBERG AND SCHOEFFER
Advanced Progress and Knowledge**

8 Point

18 A \$1 05 36 a \$1 20 \$2 25

**DISTINCT AND EXQUISITE CHARM
Beautiful American Creation Displayed**

18 Point

8 A \$1 60 17 a \$1 65 \$3 25

**BUYS LINING TYPES
Finest American Design**

6 Point

18 A \$0 95 36 a \$1 05 \$2 00

**REMARKABLE STATEMENT RETURNED
These Figures \$1234567890 are Handsome**

LINING GOTHICS Nos. 520 TO 526

60 Point No. 520

3 A \$7 90

MENDING

54 Point No. 520

3 A \$7 15

HUNGRIER

48 Point No. 520

3 A \$5 00

PROMOTING

42 Point No. 520

5 A \$5 05

ROBIN HUNTS

36 Point No. 520

5 A \$4 05

HOUSES

8 Point No. 526

20 A \$1 25

COMPOSING NEWEST DESIGN
USEFUL GOTHIC PURCHASED
SHOWING DISTINCT QUALITY

30 Point No. 520

6 A \$3 00

BEND IRON

8 Point No. 525

23 A \$1 25

MOVED LUNCH COUNTERS TODAY
FISHERMEN CAUGHT LARGE BASS
COWBOY DELIVERED LARGE HERD

24 Point No. 520

8 A \$2 75

CONFECTION

6 Point No. 524

23 A \$1 00

COMFORTABLE WARM WINTER CLOTHING
MAGNIFICENT BUILDING CAUSED WORRY
DESCRIPTIVE \$1234567890 CIRCULATION

18 Point No. 520

10 A \$2 15

STRIKE GUSHER
BOUGHT SERIES

6 Point No. 523

30 A \$1 00

PERSEVERANCE IS ABSOLUTELY INDISPENSABLE
PRINTING MATERIAL AT RIGHT PRICES ALWAYS
MANY REMARKABLE MEMOIRS FOUND MONDAY
AMERICAN TYPE FOUNDERS COMPANY STYLES

12 Point No. 520

15 A \$1 55

CONSTRUCTS BRIDGES
SPECIMEN DESTROYED

6 Point No. 522

33 A \$1 00

STUPENDOUS EARNINGS REPORTED ON THE RAILROADS
WESTERN TEACHERS RECEIVE UNIVERSAL RECOGNITION
BOUNTIFUL NATURE BESTOWING MANY VALUABLE IDEAS
HEARTY APPETITE REQUIRED AROUND EVERY MEAL TIME

10 Point No. 520

18 A \$1 40

EXPLODES LARGEST TORPEDO
TUTORS INSTRUCT STUDENTS

6 Point No. 521

37 A \$1 00

TREMENDOUS UPRISINGS EASILY CHECKED BY NOBLE CITIZENS
MIDNIGHT SUPPERS CERTAINLY ENCOURAGING RESTAURANTS
OWNERS UNQUESTIONABLY ADVANCING ORIGINAL SUGGESTION
FINE GOTHIC LETTERS MORE USEFUL FOR GENERAL PURPOSES

CONDENSED TITLE GOTHIC No. 11

72 Point

3 A \$5 00

LEGIBLE GOTHIC

60 Point

3 A \$4 25

BINDER TRIUMPHS

54 Point

4 A \$4 25

STONEMAN RETIRED

48 Point

5 A \$3 75

LIZARDS PERFORMING

42 Point

5 A \$3 25

PROMOTIONS

12 Point

23 A \$1 50

**IF FRANKLIN WERE ALIVE NOW
FORMS \$1234567890 SPOILED**

36 Point

6 A \$2 75

KINGS ESCAPED

10 Point

27 A \$1 40

**WESTERN TOURIST RETURNING HOME
COUNTRY PRINTER BOUGHT PRODUCT**

30 Point

9 A \$2 50

FOREIGNER JOKING

9 Point

27 A \$1 25

**MARCHED THROUGH GEORGIA AND TEXAS
TEACH APPRENTICES THE POINT SYSTEM**

24 Point

13 A \$2 50

BEAUTIFUL DAIRY MAID

8 Point No. 112

32 A \$1 25

**INDEPENDENT WORKMEN CONSIDERING YOUTH
BEAUTIFUL GOTHIC DESIGN SHOWN CUSTOMER**

20 Point

16 A \$2 25

HUNTERS TRAILED BADGERS

8 Point No. 111

37 A \$1 25

**CANCEL LONG ENGAGEMENT WITH BURLESQUE SHOW
OKLAHOMA COWBOYS ENTERTAINED YOUNG INVENTOR**

16 Point

20 A \$1 75

STUDENT DETAINING PHILOSOPHERS

6 Point No. 113

37 A \$1 00

**COMPLETING MOST IMPOSING MONUMENT IN PUMPKIN CENTER
ATLANTIC CITY BOARD \$1234567890 THROGDED WITH TOURISTS**

6 Point No. 111

45 A \$1 00

**COMPOSITORS SUBQUE PRESSMEN IN THEIR FIFTH ANNUAL BASEBALL GAME
PITCHER FOR TYPE STICKERS PROVED STUMBLING BLOCK FOR OPPONENTS
NOTWITHSTANDING THREATENING WEATHER JERSEY NOTABLES WERE THERE**

72 Point

3 A \$1 70 5 a \$3 00 \$6 70

MARINES Discouraged

60 Point

3 A \$3 45 5 a \$2 55 \$6 00

Improving NEW BUILDING

48 Point

6 A \$3 35 10 a \$3 05 \$6 40

EXCURSION Returning Homeward

42 Point

6 A \$2 60 11 a \$2 70 \$5 30

Democratic Convention DEADLOCKED

36 Point

6 A \$1 95 12 a \$2 30 \$4 25

INDEPENDENT Political Society Reorganized

30 Point

9 A \$1 90 17 a \$2 10 \$4 00

Unfortunate BLACKSMITHS

12 Point

28 A \$1 25 55 a \$1 55 \$2 80

VARIOUS IMPORTANT QUESTIONS DISCUSSED
Older Members \$1234567890 Propose Change

24 Point

12 A \$1 65 25 a \$1 85 \$3 50

PROMINENT AMERICAN BEAUTIES Reporters Exposed Counterfeit Gang

10 Point

31 A \$1 10 65 a \$1 40 \$2 50

DISCOURAGED FISHERMEN RETURNING HOME HUNGRY
Prominent Business Men Formed Large Hunting Parties
Brave Constables Arrested Numerous Bold Highwaymen
Country Newspaper Gives Full Details of Great Robbery

18 Point

17 A \$1 45 36 a \$1 85 \$3 30

NUMEROUS YOUNG STUDENTS GRADUATED Parent Severely Chastised Impudent Children

8 Point

35 A \$0 95 70 n \$1 30 \$2 25

EDUCATED ANIMALS RECENTLY AMUSED COUNTRY CHILDREN
Bright Detectives Unearthed Dastardly Plot to Kidnap Millionaire
Young Printer Invents Labor-Saving Device for Newspaper Press
Several Enlightened Speakers Addressed Large Political Meeting

14 Point

22 A \$1 40 46 a \$1 60 \$3 00

BEAUTIFUL HARMONIOUS DESIGNS CONSTRUCTED Important Discoveries Made by Eminent Physicians

6 Point

35 A \$0 85 70 n \$1 15 \$2 00

HANDSOME BURLESQUE PERFORMER ENTERTAINED LARGE AUDIENCE
Twenty Distinguished Gentlemen Returned From Prolonged Vacations
Patrons Greatly Delighted When Extraordinary Features Were Introduced
Considerable Money Spent \$1234567890 During Our Summer Vacations

42 Point

8 A \$3 80

**EXAMINE DELINQUENT SOLDIER
PUBLISHERS LEASED BUILDINGS**

36 Point

8 A \$3 00

**MEXICAN CONFECTIONERS REMAIN
OBSERVANT REFORMER LECTURING**

30 Point

10 A \$2 60

**GOTHAMITE DISCOVERS BANISHED PRINCE
COMICAL IRISHMEN ENTHUSE NORWEGIAN**

24 Point

15 A \$2 50

**INDUSTRIOUS PERFORMER INSTRUCTED NOVELIST
MECHANIC INVENTED AUTOMATIC BLOCK SIGNAL**

20 Point

20 A \$2 25

**FORMER PRESIDENTS PERSUADED
DISTINGUISHED ORATOR TRAVELS**

10 Point

35 A \$1 40

**FIREMEN AND POLICEMEN ORGANIZE SOCIETY
SOME PHILANTHROPIC GENTLEMEN REJECTED
EXPLORERS RETURN AFTER HAZARDOUS TRIP**

16 Point

24 A \$1 75

**SPANISH PHILOSOPHER EXPECTED MONDAY
CONSCIENTIOUS WORKMEN GET VACATIONS
FASHIONABLE BURGLAR DEMANDS REWARD**

9 Point

38 A \$1 25

**ASTRONOMERS EXPERIMENTING WITH NEW MACHINE
RANCHMEN AND COWBOYS WELCOMING TENDERFOOT
PRINTERS WALKED FROM BALTIMORE TO RICHMOND**

8 Point

48 A \$1 25

**GREAT AMERICAN DESERT SWARMED WITH GOLD PROSPECTORS
HUNTERS ABANDON CHASE OVER DANGEROUS HIGH MOUNTAINS
BANKS CLOSING DOORS OWING TO UNEXPECTED HEAVY STRAIN**

12 Point

29 A \$1 50

**BRAVEST CONSTABLES INJURED NEAR PORTLAND
TRANSFORMED MAGNIFICENT SUBURBAN DEPOTS
PLAINEST GOTHIC \$1234567890 FIGURES CAST**

6 Point

44 A \$1 00

**COUNTY JUDGE IMPOSED HEAVY FINE FOR TRESPASSING ON GARDEN
SOMNAMBULIST ESCAPED UNINJURED AFTER JUMP FROM FLAGPOLE
ATHLETIC CARNIVAL BRINGS TOGETHER MANY WONDERFUL RUNNERS
BOUGHT MATERIAL THAT \$1234567890 GAVE UTMOST SATISFACTION**

72 Point

3 A \$1.95 4 a \$2.00 \$7.85

SIGNED Plumber

60 Point

3 A \$1.55 4 a \$2.65 \$7.20

Important DISTRICT

48 Point

4 A \$3.15 8 a \$3.10 \$6.25

KNOWLEDGE Considered

42 Point

5 A \$2.90 8 a \$2.35 \$5.25

Replenished REQUIREMENTS

36 Point

5 A \$2.15 9 a \$2.10 \$4.25

HUNTED Elephant

14 Point

17 A \$1.40 35 a \$1.60 \$3.00

ADOPT STRONGER METHODS

Studious Compositors Hustling
Clever Printer Instructs Artist

30 Point

7 A \$1.75 16 a \$2.25 \$4.00

Foremen REORDERING

12 Point

19 A \$1.25 38 a \$1.50 \$2.75

MOUNTING DIAMOND BROOCHES

Many Costly Paintings are Stolen
Has Useful \$1234567890 Figures

24 Point

8 A \$1.60 18 a \$1.90 \$3.50

FAMOUS BANK CLOSING

Cashier Decamped Tuesday

10 Point

22 A \$1.15 44 a \$1.35 \$2.50

GRAND ROCKY MOUNTAINS PICTURED

Colorado River Contains Beautiful Sights
Golden Gate Harbor Receives Large Boat

20 Point

10 A \$1.50 20 a \$1.75 \$3.25

AUTHORITIES EXPLAINING

Experts Investigated Methods

8 Point

26 A \$1.00 50 a \$1.25 \$2.25

WORKMEN RECEIVED UNEXPECTED REWARDS

Finest Mechanics Loafed Around Park Row Clubs
Artistic Designer Spending Vacation Near Resort

18 Point

13 A \$1.50 28 a \$1.75 \$3.25

INTERESTED SUPERINTENDENT

Charming Gothic Specimen Pleases

6 Point

26 A \$0.90 52 a \$1.10 \$2.00

PROMINENT MERCHANTS FORM NEW ORGANIZATIONS

American Type Founders Company Make Fine Ornaments
Brass Rule and Border Rightly Used Help Most Printing
Stylish and Dignified \$1234567890 Figures Furnished

72 Point

3 A \$4 40

DISTRICT HUNTED

60 Point

4 A \$4 25

WRITE SHORT STORY

54 Point

5 A \$4 25

DISTINCT PRODUCTIONS

48 Point

6 A \$3 75

CONTAIN HONEST QUALITY

42 Point

7 A \$3 25

SHORT CONFECTIONER ENLISTS

36 Point

7 A \$2 75

ERECT FACTORIES

12 Point

26 A \$1 50

SUBMITTING HANDSOMEST SPECIMEN
USEFUL AND \$1234567890 DURABLE

30 Point

9 A \$2 50

POWERFUL KINGDOM

10 Point

32 A \$1 40

BOSTON WIRE STITCHER INVESTMENTS PAID
PLAIN ADVERTISEMENT LETTER SHOWN NOW

24 Point

15 A \$2 50

DEMAND MODERN DESIGNS

9 Point

33 A \$1 25

WANDERING COMPOSITOR INTERESTED GATHERINGS
REAL DELIGHTFUL MYSTERIES SOLVED BY SCIENTIST

20 Point

20 A \$2 25

PRINTING BEING GIANT INDUSTRY

8 Point

42 A \$1 25

FEATURING BEAUTIFUL GOTHIC CHARACTERS IN COLLECTION
TYPOGRAPHICAL HISTORY DATING BACK SEVERAL CENTURIES
ABSOLUTELY HONEST BLACKSMITH DAMAGES MUCH MATERIAL

16 Point

22 A \$1 75

AMERICAN ORNAMENTS AND BRASS RULE

6 Point

37 A \$1 00

IDEAL CONDITIONS MEAN BETTER RESULTS IN COMPOSING ROOMS
PRINTERS LIKE PLAIN MANUSCRIPT IN PREFERENCE TO SCRIBBLING
CHAMPIONSHIP MARATHON \$1234567890 OCCURS EVERY DAY HERE

MERBINE BEACH

THE FINEST SUMMER RESORT

SITUATED WHERE THE OCEAN AND MOUNTAINS MEET

MERBINE IS NOTED FOR ITS PICTURESQUE AND ROMANTIC SCENERY. THE GLORIOUS AIR, THE MAGNIFICENT VIEWS AND COMFORTABLE ACCOMMODATIONS ARE GREAT ATTRACTIONS IN THIS GREAT MOUNTAIN AND SHORE REGION, WHICH IS A PARADISE FOR CHILDREN AND A WONDERFUL SANITARIUM FOR EVERYBODY. THE BEACH IS ONE OF THE FINEST IN THE COUNTRY AND AFFORDS EXHILARATING BATHING. THE CLOSE PROXIMITY OF THE GREAT SILVER MOUNTAINS OFFERS THE VACATIONIST THE CHOICE OF RECREATION AT THE SHORE OR AMONG THE HIGHLANDS OF THE ADJOINING MOUNTAINS WHICH ARE SWEEPED BY OCEAN BREEZES. AMONG THE MANY DIVERSIONS ARE GOLF, TENNIS, BOATING, FISHING, DRIVING AND MOUNTAIN PATHWAYS THAT TEMPT THE TRAMPER, AND OPPORTUNITIES FOR EXCURSIONS TO MOUNT CHRISTOPHER

THE NORTH STAR RAILWAY, IN CONNECTION WITH THE MOUNTAIN & SHORE RAILROAD, FORMS AN ALL-RAIL THROUGH CAR LINE BETWEEN NEW YORK AND ALL POINTS IN THIS FAMOUS SECTION. THE SUMMER TIME TABLE IS NOW IN EFFECT. AN ILLUSTRATED BOOKLET MAILED ON RECEIPT OF SIX CENTS



ADDRESS ALL COMMUNICATIONS TO
THE MERBINE BEACH ADVERTISING AND PUBLICITY DEPARTMENT
MERBINE COUNTY, MAINE

Franklin Gothic

96 Point

3 A \$9 60 4 a \$6 15 \$15 75

THE Dog

84 Point

3 A \$7 70 4 a \$5 10 \$12 80

Cat RUNS

72 Point

3 A \$7 65 4 a \$4 90 \$12 55

KINGS Dine

60 Point

3 A \$6 05 4 a \$3 90 \$9 95

Made BRICKS

48 Point

3 A \$4 00 6 a \$3 85 \$7 85

**PUMAS LEAPING
Demands Regular**

42 Point

4 A \$3 55 6 a \$3 00 \$6 55

**ANCIENT MANSION
Special Employment**

Franklin Gothic

36 Point

4 A \$2.65 7a \$2.55 \$5.20

**ASTRONOMER WROTE
Prominent Incorporator
Linguist Bought Stones**

30 Point

5 A \$2.20 8a \$2.05 \$4.25

**SPEAKER REFORMS GUIDE
Great Entertainer Preparing
Englishman Leaving Gotham**

24 Point

5 A \$1.65 11a \$1.85 \$3.50

**HUSKY SAILOR DROPS ANCHOR
Considered Beautiful Decorations
Nervous Printer Became Alarmed**

18 Point

8 A \$1.50 17a \$1.75 \$3.25

**FOUND NEW NECKTIE
Near Manchuria Rocks
Mariners Hunt Caribou**

10 Point

16 A \$1.20 32a \$1.30 \$2.50

**YOUNG UNITYPE OPERATOR
Philadelphia Detective Sighed
Expert Chemist Puzzled Child
Inquisitive Woman Explaining**

14 Point

12 A \$1.40 24a \$1.60 \$3.00

**HELD BRAVE COMPOSITOR
Delightful Winter Excursions
Police Capture Daring Youth
Constable Examined Burglar**

8 Point

19 A \$1.10 38a \$1.15 \$2.25

**FAMOUS PEDESTRIANS EXHAUSTED
Octogenarian Breaks Walking Record
Jumping From Bunker Hill Monument
New Type Bought by Country Printer**

12 Point

14 A \$1.25 29a \$1.50 \$2.75

**OLDEST MEMBERS PROTESTING
Regulations Strenuously Enforced
Denverite Closely Guarding Secret
Beautiful \$1234567890 Damsels**

6 Point

21 A \$0.90 44a \$1.10 \$2.00

**MARINER STRANDED ON BARREN ISLAND
Large Steamer Abandoned by Mutinous Crew
Dangerous Insects Infested Tropical Country
Horse Thief Departing From Oklahoma Town
Faithful German \$1234567890 Won Reward**

5 Point

22 A \$0.90 46a \$1.10 \$2.00

**COMPOSITOR TRYING TO ESTABLISH NEW RECORD
Pled Eight Pages of Four Point While Sprinting Around
Seven Stonemen Kept Busy Justifying Magazine Pages
Alleged Printer Served Apprenticeship With Carpenter
Proofreader Wore Out Fourteen Beautiful Blue Pencils**

Franklin Gothic Condensed

72 Point

3 A \$6 15 4 a \$4 20 \$10 35

UNREMINDED
Knight Racing

60 Point

3 A \$5 10 4 a \$3 95 \$9 05

RETURN PIGEON
Design Steamers

48 Point

4 A \$3 80 7 a \$3 70 \$7 50

SECURING FORTUNE
Introducing Irishman

42 Point

5 A \$3 40 8 a \$3 15 \$6 55

FOREIGNERS PRINTING
Contain Beautiful Series
Makes Lovely Character

Franklin Gothic Condensed

36 Point

6 A \$2 15 9 a \$2 55 \$5 00

PROCURE ADVERTISEMENT Erects Magnificent Theatres

30 Point

6 A \$2 15 10 a \$2 10 \$4 25

EXQUISITE AMERICAN PRODUCTS Franklin Gothic Condensed Bought Distinguished Features Maintained

24 Point

7 A \$1 65 14 a \$1 90 \$3 55

INSPECTING HANDSOMEST INSTRUMENT Bright University Students Playing Cricket Enterprising Schemes Being Quickly Used

18 Point

11 A \$1 55 20 a \$1 70 \$3 25

MERCHANT FOUND MONEY Fisherman Catching Sucker Rambling Printer Continued

10 Point

19 A \$1 15 38 a \$1 35 \$2 50

HUNTERS CHASED TIMBER WOLF Files Important Document Monday Experienced Gardeners Plant Roses Charming Specimen Being Printed Huntsmen Found Strange Creature

14 Point

15 A \$1 35 30 a \$1 65 \$3 00

SECURING HONEST BLACKSMITH Apprentices Damaged Your Nerves Thirty Guests Stayed Around Town Several Performers Bathed Friday

8 Point

22 A \$1 00 45 a \$1 25 \$2 25

FOREMAN RETURNING FROM MOUNTAINS Great Trip Planned by Rambling Composer Expects to Visit Atlantic City and Coshocton Saves Many Dollars During the Sojourn Here Printer Secured Franklin Gothic Condensed Purchasing Beautiful American Ornaments

12 Point

17 A \$1 30 34 a \$1 45 \$2 75

HUSKY SOLDIERS PERFORMED DUTIES Escaped Guardhouse by Unlocking Doors Desperate Character Purchased Shotgun Handsome \$1234567890 Display Figure

6 Point

24 A \$0 95 46 a \$1 05 \$2 00

GREATER DESIGNERS SUBMIT FINE SPECIMENS Our Satisfactory Borders Distributed Everywhere Noble Features Being Exposed Throughout Series Purchases Many Wonderful Boston Wire Stitchers Large Milwaukee Salesman Entertains Composer Remarkable Characters Becoming Useful Articles Exquisite Letters \$1234567890 Shown Customer

The Little Ministers

An Entertainment given by St. Paul's Sunday School



This beautiful little Playlet goes straight to the hearts of fathers and mothers as it tells the story of the boy life. It has a



most peculiar charm that will be iated by everyone. It shows that t real preparation for this present l in the philosophy and teachings o An ennobling faith in which all se has been in every way very carefu out. **COME**, and bring your Boys and attend this instructive and inspiring piece The proceeds will be devoted exclusively to p new hymnals for the church. These are much and will be of great service to both pastor an

Thursday Evening, March

WAGNER MUSIC HALL, ON EAST LIBERTY ST



Acme Border Holiday Decorators

Cast Panel Pieces Versatile Ornament

HELLO

YOUR ATTENTION IS CALLED TO THIS NEW AND HANDSOME FACE FRANKLIN GOTHIC CONDENSED

Get on the Line



The careless printer who doesn't keep up with modern demands will be all alone, he will be left in the rear. The buying public is beginning to appreciate good work and demand the latest and best in type design

FINE SUMMER COTTAGE

Furniture

CHAIRS, TABLES, BEDSTEADS
AND PARLOR SUITES

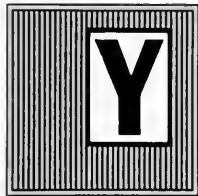

YOU must not get the impression that our stock is higher priced than others. But it is, however, very exclusive in design, and it is also true that we have the patronage of the most discriminating and particular people in all sections of the United States. Our cottage furniture is especially adapted for both shore or country houses where a simple, harmonious and artistic effect is desired, conforming with the surroundings and not sacrificing one particle of comfort.

THE REPUTATION OF OUR FURNITURE HAS BEEN BUILT
ON ITS SIMPLE ARTISTIC LINES, SOLIDITY OF
CONSTRUCTION, AND A VARIETY OF
CUSTOM FINISHES

HEMAN & STERN

MANUFACTURERS OF FINE FURNITURE

46 Hamilton Street, Melone, Ohio

Shipments are carefully crated insuring safe delivery. Send for latest booklet No. 24

120 Point

3 A \$8 00 4 a \$5 60 \$13 60

MINE Shaft

96 Point

3 A \$6 25 4 a \$4 25 \$10 50

Rented HOME

84 Point

3 A \$5 20 4 a \$3 40 \$8 60

FROM Saturday

72 Point

3 A \$4 95 4 a \$3 35 \$8 30

Machines REMIND

60 Point

3 A \$3 70 6 a \$3 95 \$7 65

STRENGTH REQUIRED
Modest Construction

Franklin Gothic Extra Condensed

48 Point

4 A \$2.00 8 a \$3.35 \$6.25

**MERCHANT PRODUCTIONS
Educated Horses Continue**

42 Point

5 A \$2.60 9 a \$2.80 \$5.40

**CURIOUS ENTERPRISES NOTED
Dishonorable Method Expected**

36 Point

5 A \$1.80 11 a \$2.45 \$4.25

**DETERMINED BANKER CONSIDERING
Strenuous Remark Answered Quietly**

30 Point

7 A \$1.90 14 a \$2.20 \$4.10

**DESIRABLE TYPE FACE
Excellent Gothic Letter**

12 Point

21 A \$1.25 44 a \$1.50 \$2.75

**HISTORICAL DOCUMENTS DISCOVERED
Some Mysterious Investigations Made
Dignified Professors Procure Evidence
Many Individual \$1234567890 Plants**

24 Point

9 A \$1.60 18 a \$1.90 \$3.50

**HANDSOME PRIZE SECURED
Strong Competitors Remain**

10 Point

25 A \$1.15 48 a \$1.35 \$2.50

**AMERICAN LINE STYLES LEAD THE WORLD
Distinct and Attractive Type Combination
The Weight Font System Increases Profits
Desirable and Useful Gothic Letters Found**

18 Point

14 A \$1.45 29 a \$1.80 \$3.25

**DISTINGUISHED SCHOLARS NAMED
Charming Afternoon Performances**

8 Point

28 A \$1.00 55 a \$1.25 \$2.25

**EFFECTIVE GOTHIC DESIGNS ARE ALWAYS POPULAR
Strong and Durable Types Bring Favorable Results
The Franklin Gothic Extra Condensed Insures Merit
Procure Your Job Type in Serviceable Weight Fonts**

14 Point

18 A \$1.40 36 a \$1.60 \$3.00

**BEAUTIFUL AMERICAN LINE TYPE STYLES
Popular and Serviceable Creations Bought**

6 Point

30 A \$0.90 60 a \$1.10 \$2.00

**UNEXCELLED FOR SHOW CARDS AND NEAT POSTER WORK
Every Printing Office Should Contain This Striking Series
Sold in Weight Fonts at Body Type Prices and Discounts
Discerning Printers \$1234567890 Will Recognize Its Value**

The Great Popularity of Brass and Copper Thin

SPACES

Q Brass and Copper Thin Spaces make justification so easy that no printing office, large or small, can successfully attempt to do without them. These spaces are put up in special cases, made the size of the regular Wisconsin Quarter Cases, four of which just fit in a regular blank case. They

can thus be kept where they are most accessible, or can be placed in the stone. They are a valuable and valuable article in the composing room, and will save a large unnecessary amount of labor. They will prove a valuable adjustment on the press. In fact, they are a quick and accurate justification boon to any printing office.

busy composing room. That these Thin Spaces may be readily distinguished, the Half Point are made of Copper and the One Point are made of Brass. For prices and further information in regard to the Brass and Copper Thin Spaces write to nearest Selling House for pamphlet

HAROLD W. MORTON

WILLIAM H. HENDERSON

MORTON & HENDERSON CO.

1239 North Market Street, OAKFORD, WIS.

HIGH-GRADE INTERIOR AND EXTERIOR WORK

Decorators

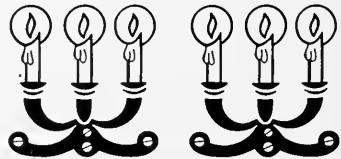

American Type Founders Co.

THE LARGEST AND MOST COMPLETE TYPE FOUNDRY IN THE WORLD. EVERYTHING FOR THE PRINTER

NOVELTIES

For Making Your Home Attractive

To the man or woman of good taste the subject of making the home as beautiful and attractive as possible is always one of great interest. Our novelties are selected by experts in the art of home decorating, and always with the view of giving our patrons and the general public the best and most original ideas for their money. A visit to our show rooms, and a casual examination of our stock, will convince the most skeptical that our claims to art in the way of house decorations have been substantiated in every detail. We will have special displays

Columbia Novelty Company

Number 27 Market Street KANSAS CITY, MO.

Chap-Book Guidon Versatile Ornament

VALENTINE SALE HERE

All the Latest Designs in Valentines, some original motto Folders for mailing



THE RED HEARTS AND
FRENCH CUPIDS WILL
SURELY PLEASE YOU

Ask to see the little
Austrian Valentines

MAX GORDON
SOUTH STREET BOOK STORE

Versatile Ornament Brass Diagonal Corners

Ordering by Telephone

A Word to Housewives Regarding New Residence Line



The Benscreek and Turtle Point Telephone Company in making several very important changes and extensions in its system has provided for resident lines of three parties or more. This change will enable every housewife in town to order her household goods by telephone. Your orders for installation of telephones may be placed at once

Chap-Book Guidon Hello Cut

Inland Gothic No. 8

72 Point

3 A \$8 40 4 a \$5 30 \$13 70

FINE Shop

60 Point

3 A \$7 45 4 a \$4 70 \$12 15

**CONSIGNS
Pirate Chief**

54 Point

3 A \$5 80 4 a \$3 70 \$9 50

**MENTIONED
Gothic Figure**

48 Point

3 A \$4 65 4 a \$2 85 \$7 50

**INDENT KNIFE
Enjoys Bathing**

42 Point

3 A \$3 60 5 a \$2 65 \$6 25

**GRAND METHOD
Exquisite Heading**

Inland Gothic No. 8

36 Point

4 A \$2.00 6 a \$2.40 \$5.20

DISTINCT PRINTING Handsome Discovery

30 Point

4 A \$2.05 5 a \$2.20 \$4.25

PRODUCED MERCHANTS Observe Charming Dignity

24 Point

5 A \$1.65 10 a \$1.85 \$3.50

MITERED BORDERS REJOINED Cub Dumping Ancient Ornament Demand Greatest Achievements

18 Point

8 A \$1.50 16 a \$1.75 \$3.25

UNITYPE STUDENTS Continually Improved Machine Remarkable

9 Point

18 A \$1.20 35 a \$1.30 \$2.50

FREIGHT ORDERS UNTOUCHED Building Magnificent Brick House Strong Display Letters for Printer Advertisers Wanting Bold Gothics Presents Beautiful Type Creation

14 Point

12 A \$1.40 23 a \$1.60 \$3.00

DEVELOP LARGE MUSCLE Husky Composer Working Largest Daily Average Made Strong Hermit Routed Thug

8 Point

20 A \$1.10 38 a \$1.15 \$2.25

REDUCING FRACTURED THIGHBONES Hospital Students Performed Operation Train Jumper Thrown Heavily from Rods Fast Express Rounding Curves Rapidly Covers Seventy Miles Without Stopping Natives Awed by Swift Moving Monster

12 Point

15 A \$1.30 27 a \$1.45 \$2.75

SUNBURN TORTURED MOTHER Cornhuskers Enjoying Festivities Showed Business Making Gothic Burglar \$1234567890 Searched

6 Point

24 A \$1.00 44 a \$1.00 \$2.00

AMERICAN FAKIRS EXPOSED BY NATURALIST Lecturing Before Crowned Heads of Europe Friday Bewildered Pedestrians in a Dreadful Predicament Shaky Water Wagon Being Ridden About Newark Expert Horseman Judges Heavy Team Competition New Jersey Mosquitoes Exported in Big Quantities Composer Makes \$1234567890 In Each Week

10 Point

16 A \$1.20 30 a \$1.30 \$2.50

AMERICAN DESIGN SUITED BUYER Sawyers Hold Fifth Annual Convention Remarkable Steamer Cleared Norfolk Cardboard Justifications Unnecessary Introducing Graduated Point Systems

5 Point

21 A \$1.00 38 a \$1.00 \$2.00

SUPERINTENDENT PRESENTING UNIQUE DESCRIPTION Handsome Athletes Returning from Extended Tours Abroad Desperate Female Shoplifter Captured by Large Detectives Educated Horse Being Driven Through Montgomery Avenue Technical School Teaches Youthful Apprentices Fine Style Secretary Declining Renomination After Heated Arguments Consult American Specimen Book When Selecting Material Manufacturers and Newspapermen Combining Publications

TITLE GOTHIC No. 9

72 Point

3 A \$9 40

REMARK

60 Point

3 A \$8 25

HORNETS

54 Point

3 A \$6 75

KIND MAID

48 Point

3 A \$5 40

BLOND MAN
WINS BRIDE

42 Point

4 A \$4 50

DEMAND RIDE
SHOP GAINED

36 Point

4 A \$3 75

DESIGN POSTER
FRIEND SHARED

TITLE GOTHIC No. 9

30 Point

5 A \$3 00

EMINENT ADVISERS HUSBAND PLEASED

24 Point

7 A \$2 50

MODERN YOUNG PUPILS FORM PROMINENT CLUB

20 Point

9 A \$2 25

SOCIETY GIRLS PLAN OUTING RUDE BOYS VEXED MATRONS

16 Point

10 A \$1 75

PECULIAR COSTUME FOUND RUINED FOREST FIRE DAMAGED INSTITUTION

12 Point

14 A \$1 50

GRAND PRIZE PROCURED FOUR \$1234567890 BOYS

8 Point No. 92

24 A \$1 25

COMPLICATED DESIGNING IMITATED RECEIVED AMERICAN PRODUCTIONS DEMONSTRATES POPULAR MACHINE

10 Point

17 A \$1 40

DESERTING OLD HOMESTEADS POPULAR ENERGETIC DOCTOR

6 Point No. 91

25 A \$1 00

DILIGENT YOUTH RECEIVED SPECIAL MENTION HIGH SCHOOL GRADUATE STUDIES DENTISTRY BECAME RICH \$1234567890 VERY QUICKLY

10 Point No. 92*

18 A \$1 40

ADMIRING BEAUTIFUL LANDSCAPE PRODUCING EXCELLENT RESULTS

6 Point No. 92

26 A \$1 00

PROFESSORS ADVANCING DIFFERENT THEORIES FIVE EMINENT PHYSICIANS ENTER DISCUSSION PROMINENT LAWYERS ADVISED YOUNG WIDOWS

9 Point*

17 A \$1 25

REMARKABLE DESIGNS EXECUTED DONATING CONSIDERABLE MONEY

6 Point No. 93

28 A \$1 00

NINETEEN HUNDRED SOUTHERN DELEGATES CONVENE BEAUTIFUL SPECTACLE WITNESSED BY MANY LADIES SEVERAL WESTERN BUSINESS MEN SIGNED PETITION

8 Point No. 91

20 A \$1 25

ESTABLISHED GRAND PRINTING PLANT JOINED COUNTY PROTECTIVE SOCIETY

6 Point No. 94

32 A \$1 00

MONUMENTS ERECTED THROUGHOUT NORTHERN DISTRICTS VARIOUS LARGE CONTRIBUTIONS RECEIVED DURING MONTH EXTRA APPROPRIATIONS DEMANDED BY LEADING CITIZENS

*The same face

Times Gothic

96 Point

3 A \$9 60 4 a \$6 40 \$16 00

HIS Belt

84 Point

3 A \$8 50 4 a \$5 50 \$14 00

Red MEN

72 Point

3 A \$7 55 4 a \$5 50 \$13 05

IRON Step

60 Point

3 A \$6 70 4 a \$4 80 \$11 50

**CONSUMES
Heroine Real**

54 Point

3 A \$4 85 5 a \$3 90 \$8 75

**MISER DINES
Reports Extra**

48 Point

3 A \$3 85 5 a \$3 80 \$7 65

MINER RESIGN Defective Miter

42 Point

3 A \$3 10 6 a \$3 20 \$6 30

MODERN ENGINE Bristol Cardboard

36 Point

3 A \$2 65 6 a \$2 50 \$5 15

NUMEROUS GAMES Desired Scholarships

30 Point

5 A \$2 15 8 a \$2 10 \$4 25

BRAVE HERO Grand Stands

12 Point

13 A \$1 30 25 a \$1 50 \$2 50

FINE RECEPTION GIVEN Generous Spring Weather Elegant Service Rendered Fine \$1234567890 Design

24 Point

5 A \$1 50 11 a \$2 00 \$3 50

DEMAND HOME Interest Counter

10 Point

14 A \$1 10 28 a \$1 40 \$2 50

GOVERNOR ENTERTAINED Exclusive Autumn Bargains Publisher Secured Souvenir Remarkable Border Designs

18 Point

7 A \$1 45 14 a \$1 80 \$3 25

HANDSOME DESIGN Investor Remarkable Recognized Senators

8 Point

17 A \$1 00 32 a \$1 25 \$2 25

ELABORATE AUTOMOBILE SHOW Celebrated English Touring Cars American Line Type Bring Results Twelve Special Prizes Were Given Modern Improvement Noticeable

14 Point

11 A \$1 45 20 a \$1 55 \$3 00

MANSIONS DEMOLISHED Representative Candidates Grand Performance Nightly

6 Point

18 A \$0 85 36 a \$1 15 \$2 00

DESTROY MUNICIPAL ELECTRIC STATION Having Recently Established New Plant Numerous Printing Materials Supplied Congratulate Elected American Senator Celebrated \$1234567890 Establishments

Times Gothic Italic

96 Point

3 A \$9 10 4 a \$6 90 \$16 00

HE Bids

84 Point

3 A \$8 80 4 a \$6 20 \$15 00

Neat INK

72 Point

3 A \$7 75 4 a \$5 75 \$13 50

DIG Gems

60 Point

3 A \$6 95 4 a \$4 95 \$11 90

NICE SHINE
Strong Cask

54 Point

3 A \$5 20 5 a \$4 05 \$9 25

HEROIC MEN
Bond Cashed

Times Gothic Italic

48 Point

3 A \$4.10 5 a \$3.50 \$7.60

BROKEN ROCK
Royal Garment

42 Point

3 A \$3.40 5 a \$2.85 \$6.25

DESIGN BORDER
Grand Deposition

36 Point

3 A \$2.60 6 a \$2.65 \$5.25

GOVERNOR RESIGN
Member Questioned

30 Point

4 A \$1.95 8 a \$2.30 \$4.25

BRIGHT IDEA
Heroic Maids

12 Point

12 A \$1.25 22 a \$1.50 \$2.75

PRINT FINE SOUVENIR
*Generous Girls Received
Prominent Type Designs
Fine \$1234567890 Type*

24 Point

5 A \$1.55 10 a \$1.95 \$3.50

RENT MANSION
Serious Episode

10 Point

13 A \$1.10 25 a \$1.40 \$2.50

CHANGE SCENE ENTIRELY
*Choice Pictures Described
Beautiful Flower Gardens
Enthusiastic Performance*

18 Point

8 A \$1.45 15 a \$1.80 \$3.25

ELECTED SENATORS
*Handsome Ornament
Enjoyed Conversation*

8 Point

16 A \$0.95 32 a \$1.30 \$2.25

ENORMOUS AUDIENCES ATTEND
*Victorious Grenadiers Welcomed
Statesman Propose Great Scheme
Enjoyed Delightful Entertainment
American Soldiers Complimented*

11 Point

10 A \$1.35 21 a \$1.65 \$3.00

SPEAKER ENTERTAINED
*Many Female Candidates
Deliver Delightful Oration*

6 Point

17 A \$0.85 33 a \$1.15 \$2.00

CONSIDERABLE EXCITEMENT AROUSED
*Ingenious Comedians Desire Protection
Romantic Escapade Prevented Recently
Renowned Comedian Causes Laughter
Tremendous \$1234567890 Consignment*

Times Gothic and *Times Gothic Italic*

Printed Matter

FROM **JOHN MERSH**

56 Washington Street, corner Seventh
MUSKEGONVILLE, MASSACHUSETTS



Phones
965
Main
437
Extra

Mr. _____

If you want your printing quick come here

Inland Border No. 1271 Hello Cut

BASEBALL

Game
Called
3:30



When you are
in need of any
Clothing, Hats
Shoes, Collars
and Neckwear
Drop In

NO doubt all the fans will attend the first game of the season today to root for our home club. We are going to encourage attendance at the games this season by giving away tickets each week, not only one, but as many as you want so that everyone may get them. The conditions for obtaining the tickets are few and simple. Call at our store for details. While in our store it will be to your advantage to examine our goods whether you purchase or not

BORSH & RIBMAN

Baseball Uniforms a Specialty

58 MINDEN AVENUE AND KAY STREET
BIRMINGHAM, FLORIDA

Inland Border No. 698 Baseball Series No. 2

AMERICAN LINE

Leads

Cut Labor-Saving

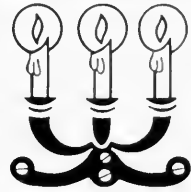

These special fonts of Labor-Saving Leads are cut from one em to twenty ems for use with type cast on American Point Line or the lining system of other foundries. They are accurately cut from 1 Point, 2 Point and 3 Point Leads and are put up as follows:

1 Point Brass Leads Font contains seven pieces each 1 to 10 ems graduated by 6 Points; seven pieces each 11 to 14 ems graduated by 12 Points; five pieces each 15 to 20 ems graduated by 12 Points. Font measures about two hundred and sixty inches **Price \$1.00**

2 Point Metal Leads Each font contains twelve pieces each 1 to 10 ems graduated by 6 Points; also twelve pieces each 11 to 20 ems graduated by 12 Points. Font weighs four pounds **Price \$1.00**

3 Point Metal Leads Font contains eight pieces each 1 to 10 ems graduated by 6 Points; also eight pieces each 11 to 20 ems graduated by 12 Points. Font weighs four pounds. Should be in every office **Price \$1.00**

American Type Founders Company

The Best of Everything for the Up-to-date Printing Office

RAILROAD GOTHIC

120 Point

3 A \$9 50

REMINDS

96 Point

3 A \$7 50

FURNITURE

84 Point

3 A \$6 00

SOME NIGHT

72 Point

3 A \$5 40

MIXERS HOME

60 Point

3 A \$4 75

BOUGHT CABINET

54 Point

4 A \$4 25

TRUSTING BUGLER

RAILROAD GOTHIC

48 Point

4 A \$3.75

INTRODUCE PRINTER

42 Point

5 A \$3.25

POSTER DESIGN FOUND

36 Point

6 A \$2.75

MISINFORMED LOCKSMITH

30 Point

8 A \$2.50

REMARKABLE SPECIMEN BOUGHT

24 Point

11 A \$2.50

ORGANIZE EXCLUSIVE AMERICAN CLUB

18 Point

15 A \$2.00

BRITISH SPENDTHRIFT DEGAMPS WITH THOUSANDS INSTRUCTING AMBITIOUS MICHIGAN DRAUGHTSMEN

14 Point

19 A \$1.75

SURGEON PERFORMED OPERATION NIMBLE FINGERS DECEIVE POLICE

8 Point No. 2

26 A \$1.25

TURKISH BATH VISITED BY YOUNG CASHIER FOOD FAIR CROWDS DELIGHTED EVERY DAY

12 Point

20 A \$1.50

FOREIGNERS INSPECTED MANSIONS EUROPEAN SINGER ENJOYED VOYAGE TEN GOTHIC \$1234567890 FIGURES

8 Point No. 1

30 A \$1.25

ADVERTISING HOUSE REPORTED SEVERAL FAILURES PLEASANT MEMORIES OF THE YEARS LONG GONE BY

10 Point No. 2

24 A \$1.40

COUNTRY MAIDENS DELIGHT NEW COMER NOISY THROG AWAITS VERDICT OF JURY AMATEUR SLEUTH TRACKED MEAN THIEF

6 Point No. 5

36 A \$1.00

COUNTRY NEWSPAPER SUSPENDS PUBLICATION FOR TWO MONTHS STATUE OF LIBERTY MOST IMPOSING OBJECT NEAR MANHATTAN BANKS LOST ABOUT \$1234567890 ON SOUTH AFRICAN COMPANY

10 Point No. 1

30 A \$1.40

GENUINE MONTANA DIAMOND SOLD TO OREGONIAN MAGIC REMEDY FOR RHEUMATISM AND DYSPEPSIA WESTERN HOME OFFERED TO CITIZENS OF JAYTOWN

6 Point No. 4

42 A \$1.00

HUNTERS TRAIL PUMA THROUGH MILES OF MOST DANGEROUS COUNTRY BOGUS CHECK EXHIBITED AT TRIAL OF ALLEGED FORGER AND ABSCONDER IMPORTANT DECISION OF LEARNED JUDGE INTERESTS ALL STOCKHOLDERS

6 Point No. 3

48 A \$1.00

ALWAYS USEFUL SERIES FOR THE GENERAL RUN OF NEWSPAPER AND COMMERCIAL OFFICES WEALTHY SPORTSMEN SPENDING LEISURE MOMENTS PLAYING EXCITING GAME OF SQUASH ONE THOUSAND POLICEMEN FAIL TO SCARE EIGHTEEN NOTORIOUS WESTERN PICKPOCKETS

6 Point No. 2

54 A \$1.00

BASEBALL ENTHUSIASTS THROG RIBBATIC STADIUM HOURS BEFORE START OF WONDERFUL GAME TREMENDOUS GATHERING WITNESSED DEMONSTRATION BY NINE HUNDRED CIRQUE PERFORMERS ORDEL COMEDIAN INVITED TO ATTEND FIFTH ANNUAL BEFFSTEAK OWNER OF THE BRUGH CLUB

84 Point

3 A \$5 30 4 a \$3 60 \$8 90

INSURE Steamer

72 Point

3 A \$4 50 4 a \$2 95 \$7 45

Condensed GOTHIC

60 Point

3 A \$4 05 4 a \$2 70 \$6 75

**STORMING KNIGHTS
Used Legible Method**

54 Point

4 A \$3 75 7 a \$3 75 \$7 50

**WRECK RUINS ENGINE
Shows Charming Grace**

48 Point

4 A \$2 80 9 a \$3 45 \$6 25

**RETURNS NICE SOUVENIR
Beautiful Birthday Parties**

Inland Condensed Gothic No. 10

42 Point

5 A \$2.40 10 a \$2.85 \$5.25

**INTRODUCE HELPFUL SYSTEM
Handsome Leaflets Distributed**

36 Point

5 A \$1.85 11 a \$2.40 \$4.25

**REQUIRING TYPOGRAPHICAL BEAUTY
Organize University Baseball Leagues**

30 Point

7 A \$1.85 14 a \$2.15 \$4.00

**CONSIDERING DETERMINED HOUSEHOLDERS
Strong Letter for General Advertising Purpose**

24 Point

9 A \$1.60 19 a \$1.90 \$3.50

**INTELLIGENT PRINTERS PURCHASE AMERICAN TYPE
Royalty Patronized Stronger Educational Departments**

18 Point

15 A \$1.45 30 a \$1.80 \$3.25

**SELECTING BRILLIANT COUNCILMEN
Always Increase Your Job Type Fonts**

9 Point

26 A \$1.15 54 a \$1.35 \$2.50

**PERFECTION REACHED IN OUR MODERN CASTING
Small Sizes Fine for Manifold and Ruled Headings
Handiest for Railroad Work Requiring Bold Display**

14 Point

18 A \$1.40 36 a \$1.60 \$3.00

**INDIAN REFUSED UNCLAIMED BUILDINGS
Very Trifling Accident Causes Much Alarm**

8 Point

26 A \$0.95 60 a \$1.30 \$2.25

**PECULIARITIES ELIMINATED THROUGHOUT UNIVERSITY
Gothic Style of Letters Probably the Oldest in Existence
Ancient Tablets and Monument Inscriptions Prove Doubt
Remodeling the Original Faces Makes this Style Popular**

12 Point

22 A \$1.25 44 a \$1.50 \$2.75

**CHOICE SERIES FOR BOLD ADVERTISING DISPLAY
Condensed Gothic Suitable for all Classes of Work
Figures Printed \$1234567890 Sharp and Distinct**

6 Point

30 A \$0.85 65 a \$1.15 \$2.00

**GREAT MERCHANT PRINCE EMBARKS PRIVATE YACHT MARYLAND
Important Turkish Mogul Drinks Perfumery and Smokes Cigarettes
August Gentlemen Become Intoxicated During Informal Social Allair
Complete Plants Equipped With Modern Brass Rule and Ornaments
Everything Needed is \$1234567890 Promptly and Carefully Shipped**

10 Point

22 A \$1.10 48 a \$1.40 \$2.50

**JUDICIOUS INVESTMENTS REWARD NORTHERN BUYER
The Latest American Type and Border Creations Shown
Capable Workmen Needed Useful Material in Abundance**

5 Point

28 A \$0.90 55 a \$1.10 \$2.00

**INTERESTING DIPLOMATIC ACHIEVEMENTS GAINED THROUGH STEADY EFFORTS
Brilliant Statesmen Decide Puzzling Question on Law Without Legal Precedent
Picturesque Costume Adorned the Gallant Masqueraders at Christmas Excursion
Oldest Inhabitant Fails to Recall Such a Heavy Rainstorm in Past Seventy Years
These Newly Published Timetables Were Set in Condensed Gothic Number Ten**

Lining Mid-Gothic No. 2

72 Point

3 A \$5 70 4 a \$3 95 \$9 65

DRINK Claret

60 Point

3 A \$5 35 4 a \$3 65 \$9 00

Honest SOLDIER

48 Point

4 A \$3 70 6 a \$3 40 \$7 10

DISPROVES Method

42 Point

4 A \$2 90 6 a \$2 50 \$5 40

Machines INTRODUCED

36 Point

5 A \$2 40 8 a \$2 35 \$4 75

OBSTRUCTION Indispensable

30 Point

6 A \$2 05 10 a \$2 15 \$4 20

**BRIGHT QUESTION
Answered Student**

12 Point

19 A \$1 20 38 a \$1 55 \$2 75

**GENEROUS MERCHANT HONORED
Recent Storm Destroyed Property
Boys Discovered Wonderful Mines
Exchange \$1234567890 Dividend**

24 Point

7 A \$1 55 15 a \$1 95 \$3 50

**INSPIRED REPORTERS
Newspaper Circulated**

10 Point

23 A \$1 15 46 a \$1 35 \$2 50

**SEARCHING PARTY DISCOVERED SILVER
Large Quantities Procured by Expert Miner
Western Residents Consider Generous Plan
Performers Received Magnificent Ovation**

18 Point

11 A \$1 45 22 a \$1 80 \$3 25

**FEMALE POLICE EMPLOYED
Chief Satisfied With Results**

8 Point

27 A \$1 00 53 a \$1 25 \$2 25

**MUSICIANS ENTERTAIN WEALTHY WESTERN MAN
Some Striking Characteristics Recently Displayed
Numerous Improvements Reported During October
Calm and Poetic Voices Resounding From Meadows**

14 Point

15 A \$1 35 31 a \$1 65 \$3 00

**AMERICAN GENTLEMAN RETURNED
Rich Guests Remain During Season
Marked Improvement Noticed Daily**

6 Point

30 A \$0 95 60 a \$1 05 \$2 00

**STRENUOUS TEACHERS RECEIVED UNIVERSAL RECOGNITION
Historic Mansion Demolished During Recent Destructive Storm
Remarkable Landscape Exhibitions Considered Most Beautiful
Bright Athletes Awarded Many Valuable Prizes for Superiority
Magnificent Display of \$1234567890 Early Spring Overcoats**

LINING INCLINED GOTHIC

24 Point No. 554*

6 A \$2 65

PRINTERS

20 Point No. 554*

8 A \$2 25

**USES GOTHIC
CROWN DUKE**

16 Point No. 554

10 A \$1 80

**CORNETS TUNED
EBONY FORESTS**

12 Point No. 554

11 A \$1 50

**CRUSHING SERPENTS
THE \$1234567890 END**

10 Point No. 554

16 A \$1 40

**CAPTURING BURGLAR
MODERN SPECIMENS**

8 Point No. 554

18 A \$1 25

**IMPORTANT WORKMANSHIP
EXQUISITE AMERICAN TYPE**

6 Point No. 557

18 A \$1 00

**RICHEST MAPLE SYRUP PRODUCT
SPLENDID \$1234567890 FIGURES**

6 Point No. 556

21 A \$1 00

**PRONOUNCED ORIGINAL TYPE SERIES
CONFECTIONER SECURES HIGH WAGE**

6 Point No. 555

23 A \$1 00

**PITCHER WAS THROWING WONDERFUL CURVE
AIRSHIP FLIES HIGH OVER COUNCIL BLUFFS**

6 Point No. 551

26 A \$1 00

**FORMED SUBURBAN RAPID TRANSIT COMPANIES
NICKEL PLATED COMPOSING STICKS SUIT BOYS**

Lining Gothic Italic No. 512

24 Point

6 A \$1 65 12 a \$1 90 \$3 55

**SHOWING PICTURES
Fine Richest Member**

18 Point

10 A \$1 50 22 a \$1 80 \$3 30

**MANY BEAUTIFUL HOUSES
Building Substantial Factory**

14 Point

15 A \$1 25 30 a \$1 75 \$3 00

**PRIVILEGED CHARACTER REJECTED
Contains Many Features of Prominence**

12 Point

18 A \$1 20 38 a \$1 55 \$2 75

**DRIVES DONKEY THROUGH TOWNS
Marble Fountains Erected in the Park
Spending \$1234567890 Much Time**

10 Point

20 A \$1 15 44 a \$1 50 \$2 65

**CUSTOMERS BUYING ESTABLISHMENTS
Notice Great American Face Shown Here
Graceful Dancer Enjoyed Beautiful Waltz**

8 Point

22 A \$1 00 46 a \$1 25 \$2 25

**EDUCATE SATISFIED MERCANTILE TRADERS
Doing Fine Work With Condensed Gothic Italics
This Series Always in Style and is Very Popular**

Lining Gothic Italic No. 524

12 Point

19 A \$1 25 38 a \$1 50 \$2 75

**MIDNIGHT SERENADERS RECEIVED COINS
Present Handsome Souvenir to Lieutenant
Ten New Figures \$1234567890 Count Them**

10 Point

22 A \$1 10 44 a \$1 40 \$2 50

**CONDENSED GOTHIC ITALIC SATISFIES EVERYONE
Several Tempting Designs Charmed Superintendent
Government Inspectors Chased Diamond Smugglers**

8 Point

22 A \$0 95 50 a \$1 30 \$2 25

**CONSIDERING SERVANT PROBLEM SERIOUSLY
Becomes Unconscious During Rowdy Fist Fight**

6 Point

25 A \$0 85 55 a \$1 15 \$2 00

**NITROGLYCERINE EXPLOSIONS WRECKED HUGE ENGINE
Advertising Specialties Amused Blind Children in Country
Thoughtful Minister \$1234567890 Preached Great Sermon**

5 on 6 Point

34 A \$0 85 68 a \$1 15 \$2 00

**HEROIC MEASURES UTILIZED IN SAVING DROWNING STEVEDORES
Careful Workmen Demand High Grade Materials for General Printing
Captain of Tank Steamer Used Megaphone While Giving Order to Crew**

120 Point

3 A \$12 20 4 a \$7 30 \$19 50

RED Hat

96 Point

3 A \$8 50 3 a \$5 00 \$13 50

Gold MINE

72 Point

3 A \$5 85 4 a \$4 15 \$10 00

**HUNTS KNIFE
Model Houses**

60 Point

3 A \$5 00 4 a \$4 00 \$9 00

**RESUME BONDS
Search Old Miner**

48 Point

4A \$3 55 8a \$3 95 \$7 50

CONVERTED BONDS Scholars Instruct Him

42 Point

5A \$3 20 8a \$3 05 \$6 25

RUSH ORDER FINISHED Invited Mexican Bankers

36 Point

5A \$2 45 9a \$2 55 \$5 00

HANDSOME BIRD SECURED Printing Convention Opened

30 Point

6A \$2 20 10a \$2 05 \$4 25

MODERN DESIGN Honest Merchants

12 Point

18A \$1 30 35a \$1 45 \$2 75

BEAUTIFUL AMERICAN WOMEN Designing New Type Ornaments Tasty Gothics For Advertisement Many \$1234567890 Thousands

24 Point

7A \$1 70 13a \$1 85 \$3 55

CURIOUS NEIGHBOR State Industries Taxed

10 Point

18A \$1 10 40a \$1 40 \$2 50

STRENUOUS PHYSICAL EXERCISES Numerous Improvements Described Received Several Good Inducements Satisfactory Results Easily Obtained

18 Point

10A \$1 50 21a \$1 75 \$3 25

INTELLIGENT FOREIGNERS Found Important Document

8 Point

23A \$1 00 48a \$1 25 \$2 25

REFURNISHED THE HANDSOME BUILDINGS Set Advertisements and Show Cards in Gothic Relieved Terrible Sufferings Caused by Famine Swift Printers Like to Have Full Cases of Type

14 Point

14A \$1 40 28a \$1 60 \$3 00

ROMANTIC AUTUMN EXCURSION Antique Ornament Richly Bronzed

6 Point

23A \$0 90 48a \$1 10 \$2 00

GOING DOWN SOUTH WITH MOTHER AND FRANK The Printer With New Ideas Usually Secures the Job Advertisements Neatly Set Enhance Our Newspaper The American Line \$1234567890 Types Were Used

120 Point

3 A \$10 50 4 a \$6 75 \$17 25

INKS Used

96 Point

4 A \$7 65 6 a \$6 85 \$14 50

Many HOMES

72 Point

4 A \$5 30 6 a \$4 80 \$10 10

**DESIGNS QUAIN
T Handsome Gothic**

60 Point

4 A \$4 35 7 a \$4 30 \$8 65

**BEAUTIES CHARMED
Energetic Proprietors**

18 Point

5 A \$3.20 8 a \$3.05 \$6.25

SPLENDID ACHIEVEMENTS
Deservedly Popular Gothic

12 Point

5 A \$2.50 9 a \$2.75 \$5.25

PERFECT HARMONY EXISTING
Many American Beauties Noted

36 Point

5 A \$1.90 10 a \$2.35 \$4.25

DISTINCTIVE QUALITIES PERCEIVED
Forceful Characters Entirely Suitable

30 Point

7 A \$1.95 13 a \$2.10 \$4.05

PLEASANT CREATIONS
Much Emphasis Sought

12 Point

22 A \$1.25 45 a \$1.50 \$2.75

LIBERAL GRADATION OF SIZES SHOWN
Compact, Legible and Harmonious Series
For in Beauty and Usefulness These Excel
Dignified and Impressive \$1234567890

24 Point

9 A \$1.65 17 a \$1.85 \$3.50

ORIGINAL AMERICAN FACE
Greatest Display Maintained

10 Point

24 A \$1.15 48 a \$1.35 \$2.50

ACKNOWLEDGED AS A LEADING TYPE STYLE
Appreciated by Judicious Users of Printing Ink
Modern Outfit Easily Selected from Desk Book
Knowing Printers Will Use Only the Very Best

18 Point

14 A \$1.50 27 a \$1.75 \$3.25

TWENTIETH CENTURY PUBLICITY
Rapid Medium With Positive Merit

8 Point

28 A \$1.00 58 a \$1.25 \$2.25

READABILITY AND CLARITY WITH BEAUTY INTENSIFIED
Who Treads in Another's Footsteps Must Travel in the Rear
Unnumerable Points of Superiority Easily Demonstrated
The Beauty and Grace Will Enhance Your Printing Values

14 Point

18 A \$1.40 37 a \$1.60 \$3.00

PREDOMINATING TYPOGRAPHIC FASHION
Distinctive Qualities Peculiar to Every Series

6 Point

30 A \$0.85 63 a \$1.15 \$2.00

PRINTERS WITH TYPE TASTE READILY RECOGNIZE THE QUALITIES
That Distinguish the Desirable and Popular American Type Faces
Globe Gothics are Beautiful and Swift, the Minions of Their Race
Type Family With Remarkable Magnetic Attributes \$1234567890

Globe Gothics in Combination

Gifts *for Men*

THE FINEST AND THE MOST EXTENSIVE
ARRAY OF OFFERINGS IN THE COUNTY

Our great stock of appropriate articles for gifts to men makes it easy for our patrons to select a satisfactory token. Our goods are of the highest grade and are backed by our many years of satisfactory service. We therefore request our friends and patrons to visit our store and view our great display

MAIL ORDERS DELIVERED FREE TO ALL PARTS OF THE STATE



THE HENDERSON & GRANER DEPARTMENT STORE
The Greatest and Most Popular Department Store in the State of Maryland

Holiday Decorator Cast Squares Inland Border No. 1870

Hotel Marhend

THE NEWEST AND THE BEST HOTEL IN THE CITY OF SPRINGFIELD



The opening of this new house has given the people of this city one of the finest hotels in the country. The structure is fire-proof and modern in every way. It is, first of all, one of the few hotels that have a separate section for women, and it is a home hotel with family accommodations



FRANKLIN BRINKER, Manager

Globe Gothics in Practical Display

NIMROD

MONTHLY JOURNAL

Volume 32 Number 2



Angling Number

SPECIALLY ILLUSTRATED BY JOHN ROBERT HAMERSIN

This issue is arranged exclusively for the coming spring and summer fishing season, and it contains many valuable hints and suggestions for the angler who intends to visit the different mountain lakes and streams among the haunts of the various game fish. The specially written articles on casting and on the many artificial and live baits that have proved to be so successful should be read very carefully by every angler so as to secure the correct tackle for the stream or lake that the angler may select

 **25** 
Cents

THE HENDIRSON & SUNDIRNE COMPANY

Publisher of *Nimrod Monthly Journal* and *Stream and Forest*

120 Point

3 A \$8 90 4 a \$6 10 \$15 00

HOUSE Builder

96 Point

3 A \$5 80 4 a \$4 00 \$9 80

Made HANDSOME

72 Point

4 A \$4 40 6 a \$4 10 \$8 50

**VERDICTS REASONABLE
Recites Pleasant Dream**

60 Point

4 A \$3 75 6 a \$3 50 \$7 25

**GOVERNMENTS CONSIDERED
Beautiful Flowering Meadow**

48 Point

6 A \$3.35 9 a \$3.05 \$6.40

PROMISCUOUS ADVERTISING DONE
Strangers Conversed Fascinatingly

42 Point

7 A \$2.60 11 a \$2.65 \$5.25

MUSICIAN WRITES BEAUTIFUL MELODIES
Handsome Photographic Reproduction

36 Point

6 A \$2.10 10 a \$2.15 \$4.25

STEAMSHIP UNDERGOING REGULAR INSPECTION
Geographical Students Harmonize at Portstown

30 Point

7 A \$1.85 14 a \$2.15 \$4.00

NUMEROUS PLAIN MECHANICS
Auctioned Chinaware Antiques

12 Point

24 A \$1.20 49 a \$1.55 \$2.75

TEMPORARY ABERRATION OF THE MENTAL FACULTIES
Knights of the Art Preservative to Have Lectures
Mountainous Countries are Prospering This Season
American Report Exciting \$1234567890 Adventure

24 Point

10 A \$1.65 19 a \$1.85 \$3.50

DEMANDS PRACTICAL ADVERTISING
Covetously Inclined People Impaired

10 Point

26 A \$1.15 52 a \$1.35 \$2.50

HISTORIES OF ANCIENT ROME VERY OFTEN CONTRADICTING
Educational Facilities Inadequately Supplied the Community
Brings Finely Engraved Silverware From Foreign Countries
Job Printing Machinery Improving With Surprising Rapidity

18 Point

15 A \$1.40 31 a \$1.85 \$3.25

POWERFUL DERELICT DESTROYER LAUNCHED
Undertaking Stupendous Bridge Construction

8 Point

34 A \$1.00 68 a \$1.25 \$2.25

HAPPENINGS FORETOLD UPON RECENTLY DISCOVERED ANCIENT MASONRY
Joyous Children Romping Merrily on the Smooth Lawns of Country Homes
Prettiest of Compliments Paid to Representatives of Foreign Governments
Manufacturers Acknowledge an Increased Prosperity for the Past Season

14 Point

20 A \$1.35 40 a \$1.65 \$3.00

PERSONAL ACTIONS SPEAK PLAINER THAN DICTIONARIES
Automobiles Breaking World's Records Near Jacksonville

6 Point

38 A \$0.90 75 a \$1.10 \$2.00

THE CLEVEREST WORKMANSHIP VERY PROMINELY SHOWN IN MODERN STRUCTURES
Many Transcontinental Railroads Reaping Enormous Sums From Increased Freightage
Grand Decorations Profusely Displayed for the Celebration Throughout Many Cities
Showing Ingenious Combinations \$1234567890 and Plainly Earning Their Worth

Globe Gothic Extended

72 Point

3 A \$10 05 4 a \$6 45 \$16 50

HUNTER
Fine Bird

60 Point

3 A \$7 80 4 a \$5 35 \$13 15

MENDING
Flying Kite

48 Point

3 A \$5 15 4 a \$3 35 \$8 50

EXTINGUISH
Ships Burned

42 Point

3 A \$3 90 4 a \$2 60 \$6 50

PRINT FOLDER
Desires System
Border Heavier

Globe Gothic Extended

36 Point

4 A \$3.45 5 a \$2.30 \$5.75

PICTURE DESIGN
Interesting House
Building Materials

30 Point

4 A \$2.40 6 a \$2.10 \$4.50

HONEST RECORDER
Many Lovely Children
Secures Useful Series

24 Point

4 A \$1.70 8 a \$1.80 \$3.50

RECEIVE EIGHT QUERIES
Modern Device Perfected
Reaching Beautiful Lakes

18 Point

7 A \$1.65 12 a \$1.60 \$3.25

SPRING POETRY
Requires Student
Honest Members

10 Point

12 A \$1.15 24 a \$1.35 \$2.50

STANDARD REPORTS
Aeroplane Flying Swift
Subdues Heavy Beasts
Bartering Lumbermen
Making New Steamers

14 Point

8 A \$1.30 18 a \$1.70 \$3.00

MODERN JOB WORK
Show Natural Beauty
Extend Display Series

8 Point

14 A \$1.05 28 a \$1.20 \$2.25

PRIZE DANCERS COMPETE
Heavy Seas Rock Big Liners
Sailors Using Electric Signal
Moist Sprays Cause Trouble
Predicts Very Stormy Month

12 Point

10 A \$1.30 20 a \$1.45 \$2.75

TYPE VERY PROMINENT
Heaviest Orders Received
Thoughts Remind Owners
Costs \$1234567890 Paid

6 Point

15 A \$0.95 30 a \$1.05 \$2.00

HANDSOME BORDER DESIGNED
Starting Another Newspaper Serial
Observe Graceful Acrobat Perform
Bareback Rider Turns Somersault
Novelty Advertiser Meets Reverses
Valuable \$1234567890 Shipments

Globe Gothic Bold

72 Point

3 A \$8 05 4 a \$5 10 \$13 15

**HERMETIC
Steals Ring**

60 Point

3 A \$6 40 4 a \$4 10 \$10 50

**HUNT MINER
Bustling Shop**

48 Point

3 A \$4 15 6 a \$3 95 \$8 10

**DISTINCT PRINT
Heavy Machinery**

42 Point

3 A \$3 30 6 a \$3 20 \$6 50

**DISTRUST OWNER
More History Study
Bold Display Shown**

Globe Gothic Bold

36 Point

4 A \$2.75 6 a \$2.40 \$5.15

RHYME INSTRUCTIVE
Characteristic Displays
Note Marvelous Change

30 Point

5 A \$2.05 9 a \$2.20 \$4.25

BUY GLOBE GOTHIC BOLD
Desired Honorable Methods
Marksman Shot Clay Pigeon

24 Point

5 A \$1.55 11 a \$1.95 \$3.50

DETERMINED CITIZEN SHOUTED
Shows Desirable Printing Features
Extra Reporter Proved Interesting

18 Point

8 A \$1.55 17 a \$1.75 \$3.30

SECURES FISHERMEN
Bright Diamond Miners
Desires Indian Wigwam

10 Point

16 A \$1.20 32 a \$1.35 \$2.55

STRANGE ANIMAL BOUGHT
Holding Lengthy Conversation
Disastrous Fire Burns Houses
Sketches Beautiful Mountains
Provided Best Transit Facility

14 Point

11 A \$1.35 23 a \$1.65 \$3.00

RESENTING INDUCEMENTS
Elimination of Obsolete Type
Original Country Homestead

8 Point

18 A \$1.05 36 a \$1.20 \$2.25

KINGDOMS PERFORM MORE WORK
More Startling Midnight Depredations
Genius Departs Alone Toward Ireland
Children Gathered Many Wild Flowers
Printer Produces Nifty Folder Design

12 Point

14 A \$1.25 29 a \$1.50 \$2.75

BESTOW AUTOMOBILE HONORS
Remarkable Historian Discovered
Costly Government Building Model
Spending \$1234567890 Promptly

6 Point

18 A \$0.95 38 a \$1.05 \$2.00

MAKING HIGHER BUILDINGS FIREPROOF
Foreigners Made Mistakes in Our Language
Administration Requests Improved Harbors
Interested Sportsmen Attending Convention
Klondike Miners Frozen Crossing Mountain
Discovering Rapid Postal Service Deliveries
Banking House \$1234567890 Reports Gain

RANGES

THE LATEST AND MOST SERVICEABLE KIND

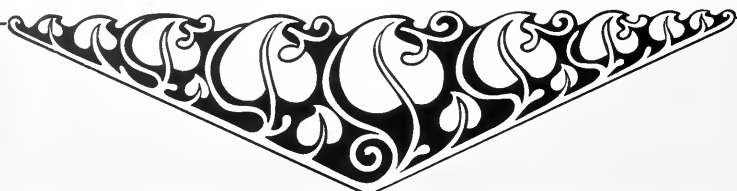

HUNDREDS of housewives who visit our store are astonished at the ease with which our new improved range can be adjusted to meet the demands of those who require a first-class cook-stove as well as a practical heater. This combination range is the most practical heater and cooker now on the market. It is fitted with attachments for both gas and electricity. We will be pleased to set up in your home an M. & D. Range at once and wait for the first payment on same until December 1, if you wish. We make this offer, anticipating rush of January orders. It will be worth your while to drop a postal for further details, or, better still, visit our store and see this wonderful combination range in practical service. By accepting our aforesaid offer you get immediate use of the range. We keep busy and avoid delays in later deliveries

Mason & Danvers

MANUFACTURERS OF GAS AND ELECTRIC RANGES

257 State Street CAMDEN, MO.

Gold

*Catalogue of Gold
Articles for Wear*



NEW RING

*We show herein
some designs in
Rings for ladies
or gentlemen. At
the present time
can price these a
little lower than*

*any of the
diamonds
the Spec
and all th
in any lin
can. We w
in this to
made for
to know a
a catalog*

RING

Mail Orders



RADE HOTEL OPENING

Charles Rade, for many years manager of Hotel Niagara, has bought the old Kinderton House of Moxham and will open to the public next week under the above name. Friday night the friends and patrons are invited to the Tap Room Opening. So this bids ye come share a flagon and joke; in the tap room an evening to dwell, and loiter awhile by the fire and smoke, kind sirs, at the Rade Hotel. Come early

*Rade Hotel
West Ren Street*

Mission Toy Cast Panel Pieces

Strength in Types

is essential in the rush and roar of twentieth century commercialism, a distinct character is necessary, that a real recognition may be obtained. The Globe Gothic Family will insure strength and style to the product of any printing plant



*The Globe Gothics
are noteworthy for
style and strength*

***Distinctly
American***

Twentieth Century Ornament

Globe Gothic Bold Italic Non-Kerning

72 Point

3 A \$8 60 4 a \$5 70 \$14 30

INSPIRED
Great Men

60 Point

3 A \$7 00 4 a \$4 60 \$11 60

RUSH BOND
Elegant Spot

48 Point

3 A \$4 60 4 a \$3 00 \$7 60

WILD ANIMALS
Misplaced Quad

42 Point

3 A \$3 35 6 a \$3 40 \$6 75

FIRE LINES OPEN
Outrages Exposed
Many Lives Sought

Globe Gothic Bold Italic Non-Kerning

36 Point

4 A \$2 70 6 n \$2 40 \$5 10

**WESTERN REPORTS
Large Profits Derived
Spruce Country Paper**

30 Point

4 A \$2 00 8 a \$2 30 \$4 30

**TRICKS HONEST FRIEND
Public Institutes Improved
Large Company Complains**

24 Point

5 A \$1 60 10 a \$1 90 \$3 50

**EMINENT PEOPLE ADVANCING
Regular Ticket Nominated Later
Broad Assertion Caused Trouble**

18 Point

8 A \$1 60 15 a \$1 70 \$3 30

**LONESOME INDIANS
Social Ladies Explain
Rough Riders Fought**

10 Point

15 A \$1 15 31 a \$1 35 \$2 50

**MANY STEEP MOUNTAINS
Upholstered Sofa Repaired
Delightful River Excursions
Society Entertainers Sailed
Examined Grand Institution**

14 Point

11 A \$1 40 22 a \$1 60 \$3 00

**FINE ARTISTIC PRINTER
Exquisitely Finished Faces
American Material Lauded**

8 Point

17 A \$1 05 35 a \$1 20 \$2 25

**ORIENTAL THEATRE FURNISHED
Large Type Faces Become Popular
Family Development Come to Stay
Contrast Makes Typographical Art
Important Members Prepare Rules**

12 Point

13 A \$1 30 25 a \$1 45 \$2 75

**WONDERFUL PLANT SECURED
Quaint Country House Thronged
Gamblers \$1234567890 Caught**

6 Point

19 A \$0 95 37 a \$1 05 \$2 00

**BEAUTIFUL NATURAL FORESTS AFIRE
Great American Type Founders Company
Latest Innovation by Silk Manufacturers
Imported Bologna Consumed in Hoboken
Reward Given \$1234567890 Honest Pupil**

36 Point

3 A \$3 05 4 a \$1 95 \$5 00

ERECTS MONUMENT Newest Style Pleased

30 Point

4 A \$2 50 5 a \$1 75 \$4 25

MINING ENGINE INSURED Unpretentious Composer

24 Point

5 A \$1 90 7 a \$1 60 \$3 50

TURNED HORSES WESTWARD Some Very Graceful Characters Comstock Popular with Printers

18 Point

7 A \$1 70 10 a \$1 55 \$3 25

MARBLE STAND ORNAMENTS PARLOR Strong Display Obtained Without Crudity Pleasing Face Showing Beauty and Style

14 Point

9 A \$1 50 15 a \$1 50 \$3 00

BOLD MONARCH DREAMS Mysterious Vehicle Coming Renews the Royal Prestige

12 Point No. 2

15 A \$1 50

WHO KICKS THE DEVIL IS ONE GREAT BOYS ONCE PRINTERS TAKE ROYAL ROADS TO FAME HOWEVER ALL ARE NOT WISE

12 Point No. 1

12 A \$1 40 20 a \$1 35 \$2 75

WHO KNOWS THE JOY OF WORK A Favorite Among Check Printers Mighty and S1234567890 Strong

12 Point No. 3

18 A \$1 50

PAUSE HERE AND GIVE YOUR OFFICE TOWEL A FEW JERKS TO HELP YOU TO REMEMBER THE NAME IS COMSTOCK FRANKLIN EDUCATED HIMSELF HERE

Comstock in Combination

ATTENTION OF PRINTERS
IS CALLED TO THE

COMSTOCK
AND
BLAIR

COMBINATION, WHICH PRODUCES
WITH LITTLE EFFORT A
BEAUTIFUL

**LITHOGRAPHIC
EFFECT**

KEPT IN STOCK AND FOR SALE AT
ALL SELLING HOUSES OF

**AMERICAN
TYPE FOUNDERS
COMPANY**

48 Point

4 A \$5 00

CHECKS REMIND

36 Point

5 A \$3 75

INSURE FINEST HOMES

30 Point

5 A \$3 00

**HIGHEST MARKET STOCKS
SENT INTERESTING BINDER**

24 Point

7 A \$2 50

**ENTERPRISING MINSTREL SHOWS
PUBLIC DESIRED MODERN PRINTS**

18 Point

10 A \$2 00

**SENATORIAL ELECTION
PROMISING CUSTOMER**

12 Point No. 3

17 A \$1 50

**DEMAND SOMETHING ORIGINAL
PRESERVING INDEX DOCUMENT
SOME MODERN REQUIREMENTS**

14 Point

13 A \$1 75

**ENGRAVED WEDDING CARDS
GENUINE TRADE INCREASER**

12 Point No. 2

21 A \$1 50

**ENTERPRISING COMPOSITOR SAVES
EARNS AMERICAN HUNTING OUTFIT
PROMOTIONS LARGE \$1234567890**

12 Point No. 4

15 A \$1 50

**HURT DIGNIFIED BANK PRESIDENT
THOROUGH WORKERS REWARDED**

12 Point No. 1

25 A \$1 50

**OBTAINED ELEGANT ENGRAVED APPEARANCE
COMMERCIAL WORK RECEIVING PROPER TONE
FINE PRODUCTION PLEASED GOOD PRINTERS**

CONDENSED COMSTOCK IN COMBINATION

STATEMENT

AS REPORTED TO SUPERINTENDENT OF
BANKS OF THE STATE OF MAINE

THE HARTEM BANKING COMPANY

ORGANIZED 1845

DIRECTORS:

RICHARD MATTHEWSON
DANIEL KNOWLES
CHRISTOPHER BARWIND
GEORGE BEMEN
CLAUDE REYNOLDS

Versatile Ornament

MADISON & CENTIMER

WHOLESALE CHEMISTS

BROADWAY AND FORTY-EIGHTH STREET, SAN FRANCISCO

R

ESTABLISHED 1841

REORGANIZED 1894

KENSINGTON DIME BANK

4 PER CENT INTEREST ON SAVINGS DEPOSITS

CAPITAL \$85,000

SAFE DEPOSIT BOXES

FOREIGN DRAFTS

MARTIN SMITH, PRESIDENT

PETER DONNELLY, SECRETARY

MAURICE HENDRICKS, TREASURER

DANIEL BRESTUN & COMPANY

MANUFACTURERS' SALES AGENTS AND WHOLESALE AND RETAIL

BOOKSELLERS

ENTIRE LIBRARIES BOUGHT, SOLD AND EXCHANGED

NINTH AND GRAND STREETS

SALEM, MASS.

IF NOT DELIVERED AFTER FIVE DAYS PE

KENT ELECTRIC DYNAM

CORNER EXCELSIOR AND THURSTON S
DETROIT, MIC

DR. RICHARD KIRSCHBIE

VETERINARIAN

574 MAIN STREET

BROOKLYN N Y

ENGRAVERS SLADED

ENGRAVERS SLADED

18 Point No. 1

6A \$2 50

UNIK MUCKED

18 Point No. 2

7A \$2 50

GAINS MORE

12 Point No. 1

10A \$2 00

HOARD MONEY

12 Point No. 2

12A \$2 00

SHOWING METHOD

12 Point No. 3

16A \$2 00

PLEASANT CUSTOMERS

6 Point No. 1

18A \$1 50

FINEST WEDDING STATIONERY
S1234567890 OBTAINING JOBS

6 Point No. 2

21A \$1 50

SECURES MANY BEAUTIFUL EFFECTS
PROFITABLE AMERICAN MATERIALS

6 Point No. 3

25A \$1 50

STURVED PRINTER HAS GREATEST RESULTS
SPECIAL DESIGN FOR TIGHTER GRADE JOBS

These specially mortised characters accompany each font

A P L P T V W Y

THE WINTER CLASS OF MONTROSE HIGH SCHOOL

REQUESTS THE HONOR OF YOUR COMPANY
ON THE OCCASION OF ITS

GRADUATING EXERCISES

TO BE HELD IN THE

MONTROSE AUDITORIUM
NORTH MADISON AND GREGORY STREETS

THURSDAY EVENING, MAY SIXTH

AT EIGHT O'CLOCK

GEORGE HANDEMAN, PRES.

JOSEPH GOODMAN, MGR.

FREDERICK HORNES, TREAS.

IRIDSON MINING COMPANY

INCORPORATED UNDER THE LAWS OF THE STATE OF OREGON

THE BLUE RIBBON GOLD MINES

66TH STREET, PORTLAND, OREGON

RODGENTON, OREGON

BOSTON

NEW YORK

DETROIT

SHERMAN & NEIDON

PLANNERS OF
PERPUNCH
MACHINE, PORTLAND, OREGON

1887-1888

FACTORY BUILDING

NEW YORK CITY

SPECIAL ANNOUNCEMENT

DURING THE REVENUE OF NOVEMBER WE WILL FURNISH FINE TABLES MADE FROM A SPECIAL PRODUCTION THE MASSIE PATENT CUTTING MACHINES, PLANS AND MATERIAL, THAT DESIGNED FOR ALL OUR CLIENTS WILL BE APPLIED TO THESE FINE TABLES. SPECIAL REPAIRS IN SHERMAN & NEIDON PERIODS OF BUSINESS AN ORDINARY REPAIRS TO BE MADE BY OURS. WE THEREBY RESERVE THE RIGHT TO REPAIRS INCLUDING ANY OTHER COST

IRIDSON & BERNDSON

REGISTERED TRADE MARK

TITLE SHADED LITHO

21 Point No. 2

3 A \$2 50

DISTINGUISH
TIRED KINGS

21 Point No. 1

4 A \$2 50

UNINTRODUCED
HIRED PRINTER

18 Point

6 A \$2 00

12 Point No. 1

15 A \$1 50

CONFINES
SHIP SILK

TITLE SHADED LITHO
PLEASING CUSTOMER
INTERESTS PRINTER

12 Point No. 3

7 A \$1 50

6 Point No. 2

16 A \$1 00

REMODELING
BRIDE FOUND

DEVELOPS GREAT STRENGTH
EXPOSED CHARACTERISTICS
MODERN FEATURES SHOWED
COUNTS \$1254567890 FIGURES

12 Point No. 2

12 A \$1 50

6 Point No. 1

20 A \$1 00

HUNTED PHEASANT
SPECIMEN SECURED

DISTINCT TYPOGRAPHIC MATERIAL
HELPING HANDSOME COMPOSITORS
HONORABLE BUSINESS DISSOLVING
AMERICAN TYPE FOUNDERS PICNIC

CLARENCE LEWIS

HAROLD MOHN

THE LEWIS-MOHN COMPANY

FORMERLY THE CURTIS COMPANY

HIGH GRADE JEWELERS

MANUFACTURERS OF

GOLD AND SILVER WEDDING GIFTS AND ART NOVELTIES

WATCH REPAIRERS

158 CALIFORNIA AVENUE

MR. ARTHUR KLINE

THEODORE WRIGHT, PRESIDENT

CHARLES HUDSON, VICE-PRESIDENT

FRANK MARTIN, TREASURER

HUNT-CRAMER COMPANY

OF HAMILTON, WEST VIRGINIA

MACHINERY

LATHES, CHUCKS AND GEAR CUTTING TOOLS

257 OAK STREET

NEW YORK

FACTORIES
HAMILTON, WEST VIRGINIA
CHARLESVILLE, MISSISSIPPI
EAST SHERIDAN, KENTUCKY

FOREIGN OFFICES
ENGLAND, 35 QUEEN'S LANE
PARIS, 89 RUE BOULEVARD
BERLIN, NEUER STRASSE, 8

THE WHITE AUTO COMPANY

REQUEST YOU TO CALL AT
THEIR SALESROOMS ON THURSDAY AFTERNOON
AT TWO O'CLOCK AND INSPECT
THEIR NEW MODEL "R"

WHITE TOURING CAR

NOW ON EXHIBITION AT
TWENTY EAST TENTH STREET
NEWTON CITY

PLEASE PRESENT THIS CARD MARTIN HIND, PRESIDENT

PURE LIFE ACCIDENT

HENRY M. JOHNSON INSURANCE

WRITES IN ALL COMPANIES

RESIDENT
53 GRAND STREET
78 EAST BOLLIVARD
ORANGE MAINE

Typo Text

(Name changed from Tiffany Text) Cast on Original Line

Sizes and Prices

24 Point 4 A \$1 60 11 a \$2 05 \$3 65

Distinctive Beauty

18 Point 6 A \$1 40 18 a \$1 85 \$3 25

Natural Grace Enhanced

14 Point 9 A \$1 25 28 a \$1 75 \$3 00

Knowing Printers Use Only the Best Material, that is American

12 Point 11 A \$1 20 31 a \$1 55 \$2 75

The unrivaled status of the American type designs are conceded everywhere

10 Point 11 A \$1 05 31 a \$1 45 \$2 50

There is a Decided Superiority in all Type that is American Line, Always the Best

8 Point 14 A \$0 95 40 a \$1 30 \$2 25

Pleasing Type Work now Possible with Our Modest and Attractive Faces, all the Progressive Printers of the Country will Appreciate the Many Artistic Series

The Big Seven

Annual Dance Programme

Waltz

Two-Step

Schottische

Waltz

Two-Step

Quadrille

Waltz

Two-Step

Grand March

Circle Two-Step

Waltz

Two-Step

Home Waltz

Mr. and Mrs. Andrew Hartman

request your presence
at a reception and ball given in honor of
their daughter

Margaret May Louise

Kind Hotel, Mary avenue
Tuesday evening, March seventeenth
at eight-thirty o'clock

Present Card at Door

Typo Text in Practical Display

(Name changed from Tiffany Text - Calligraphic)

Mr. and Mrs. Walter Price
request the honor of
your company at the marriage of their daughter
Grace Agnes
to
Mr. Francis Colegrove
on the evening of Monday, the seventh of May
at half after eight o'clock
at One hundred and five Celeron street
Garland, Indiana

Madame Patchery

hereby requests the pleasure of your attendance at
the opening of her
Dressmaking Parlors
to inspect the latest
importations of fabrics and styles
from the fashion centers
Tuesday afternoon, May Third
Morgantown, Va.

36 Point

3 A \$2 65 7 a \$2 35 \$5 00

Beautiful Invitations Produced
 Requesting Handsome Designs
 Delivered Desirable Stationery

30 Point

4 A \$2 30 8 a \$1 95 \$4 25

Modern Society Printers Advancing
 Engraved Effects Readily Obtained
 Originated for Particular Customers

24 Point

5 A \$1 95 9 a \$1 55 \$3 50

Popular Faces Universally Appreciated
 Harmonious Wedding Ceremony Ending
 Unusual Product Compelled Recognition
 Dignified American Beauties Considered

18 Point

6 A \$1 55 16 a \$1 70 \$3 25

Neatly Displayed Circulars
 Youthful American Printer
 Mailed Several Invitations
 Exquisite Designs Lauded

12 Point

10 A \$1 20 30 a \$1 55 \$2 75

Beautiful Professional Stationery
 Neat Wedding Invitations Printed
 Reducing \$1234567890 Expense

10 Point

11 A \$1 05 35 a \$1 45 \$2 50

Customers Delighted With Copperplate
 Satisfied People Generally Call Again
 Dainty Business Cards Very Effective
 Uniform and Modern Type Appreciated

14 Point

9 A \$1 35 26 a \$1 65 \$3 00

Engravers Imitated Type Productions
 Procured Copperplate Series Quickly
 Fastidious People Recently Satisfied
 Editor Admiring American Specimens

8 Point

13 A \$1 00 38 a \$1 25 \$2 25

Increasing Demand for Modern American Type
 Artistic Design Admired by Competent Judges
 Particular Printer Advocating Good Material
 Many Produce \$1234567890 Elegant Results

Mr. and Mrs. Charles Walter

request the pleasure of

your company at the marriage ceremony of their daughter

Alma Katharine

to

Mr. Gordon Carroll

on the morning of Thursday the sixth of June

at half after eleven o'clock

at One hundred and four Bird avenue

Rose Point

Announcement

We most respectfully announce to our patrons

the opening of our

Millinery Department

Tuesday, March the second

Afternoon Only

Souvenirs

The Moxham Stores

60 Point

3 A \$5 45 5 a \$3 80 \$9 25

PRINCE Delights

48 Point

4 A \$3 65 6 a \$2 80 \$6 45

Described BROCHURE

36 Point

5 A \$2 25 9 a \$2 00 \$4 25

ECONOMICAL COMPOSITION Noteworthy Workers Remembered

30 Point

6 A \$2 05 12 a \$1 95 \$4 00

CONSIDERED LOCAL ADVERTISING Prominent Longshoreman Visited Lafayette

24 Point

7 A \$1 60 16 a \$1 90 \$3 50

ELEVEN PAMPHLETS Northwestern Convention Predictions Extraordinary

12 Point

19 A \$1 35 38 a \$1 40 \$2 75

PURCHASING ENTIRE LIBRARY Great Realistic Experiences Related Travelers Journey Toward Indiana Compositor \$1234567890 Returned

18 Point

11 A \$1 55 23 a \$1 70 \$3 25

YOUR BINDERY FOREMAN Admiring Hardware Catalogues Located Materials Conveniently Mathematical Problems Solved

10 Point

21 A \$1 20 44 a \$1 30 \$2 50

EXPERIENCED WORKMEN SOUGHT Traveling Salesmen Remembered Homes Distribute Independence Day Programme Busy Printers Hover Around Space Cases

14 Point

17 A \$1 50 34 a \$1 50 \$3 00

INVESTING THOUSANDS MONTHLY Eighteen Distinguished Diplomats Recalled Fashionable Creations Originated Yesterday Mountain Climber Selects Rambling Guide

8 Point

24 A \$1 05 49 a \$1 20 \$2 25

INVESTIGATE OUR MODERN EQUIPMENT Celebrated Printing Authority Endorsed New Face Chronological Orders Reversed Through Systems Satisfactory Arrangement was Quietly Completed Largest Delegations Received Yesterday Morning

6 Point

28 A \$0 95 58 a \$1 05 \$2 00

MANUFACTURING COMPANIES RECEIVED SHIPMENTS Left School Because Many Predominating Influences Offended Numerous Selling Points Were Readily Recognized Every Time One Hundred Advertising Experts Compared Profitable Return Recent Canadian Copyright \$1234567890 Statutes Please Public

The Old Sol Watch

"ACCURATE AS THE ORB OF DAY"

The Philosopher has told us that Time is Life. A watch that just keeps "good time" is almost worthless to live men who make every second count. The "good time" watch is on a par with the inaccurate cash register or any faulty medium of measure.

To be punctual your time-piece must be exact, not "about." Come in and examine our guaranteed "Old Sol" Watches.

FELDMAN WATCH COMPANY

Rugged Brass Rule

SOCIAL EVENING



Loyal Order of Durham
Tuesday, March 17

Admit Bearer

Tabard Border

Ez-last Shoe

The ideal health shoe. Will out-wear any shoe sold at the same price. They are made in various leathers and are always stylish and attractive in every way. In these you will find the real comfort. Ask for "Ez-last"

SANDREW SHOE COMPANY
MANUFACTURERS
MILLERS FALLS, PA.

Newspaper Border

Our Ten Cent Collars

The life of your collars will be the same no matter how much you pay for them. Modern laundry methods have the same effect on all linens. Our ten cent collars have the wear and finish of the higher priced and more widely advertised article. We guarantee them to make as many trips to the laundry as any twenty-five cent article.

Seventeen Styles

Representing all the approved and fashionable shapes. We have them in quarter sizes which is another good feature not often found in the low price collar.

You will find anything you want in men's furnishings at our store.

WOOD & ALVIN

Men's Outfitters

Roycroft United

60 Point

Special Characters \$1 50 per font

3 A \$8 20 4 a \$4 95 \$13 15

HOME Beautiful

48 Point

Special Characters \$0 90 per font

3 A \$4 40 5 a \$3 20 \$7 60

KIND GENTLEMEN
Surprised Detectives

36 Point

Special Characters \$0 70 per font

3 A \$2 60 6 a \$2 40 \$5 00

PAINTER COMING BACK
Enterprising Householders

30 Point

Special Characters \$0 60 per font

4 A \$2 15 8 a \$2 10 \$4 25

COUNCILMEN HONOR GUEST
Champion American Composer

24 Point

Special Characters \$0 50 per font

5 A \$1 70 10 a \$1 90 \$3 60

REMARKABLE MANSION BOUGHT
Inspiring Orations Delighted Hundreds

18 Point

8 A \$1 65 14 a \$1 60 \$3 25
Special Characters \$0 40 per font

WONDERFUL PICTURE
Some Curious Ornaments

12 Point

12 A \$1 30 24 a \$1 45 \$2 75
Special Characters \$0 35 per font

MAGNIFICENT CONCERTS
Experienced Horsemen Riding
Spent \$1234567890 in Year

Th e d h l l e u e w v a () R M

These Special Characters are sold in separate fonts

Roycroft Tinted in Display

Pleasing Silver

In our superior table Silver we offer you
thirty years of experience and the
largest and richest stock
in all the wide
world

LARGE CATALOGUE SENT
UPON REQUEST

Harry Olds (S) Company
62 Bedford Street, Johnstown, Pa.

Linear Border No. 2

CAMERA OWNERS

THIS IS FOR YOU

Send your name and address to us
and receive a sample of the most
interesting modern photographic
magazine in the country

THE PICTURE MAGAZINE

SPRINGFIELD, MASS.

Curtis-Post

72 Point

Special Characters \$1 65 per font

3 A \$10 35 4 a \$7 00 \$17 35

HIS Cape

60 Point

Special Characters \$1 20 per font

3 A \$7 45 4 a \$5 55 \$13 00

Doing FINE

54 Point

Special Characters \$1 20 per font

3 A \$7 25 4 a \$4 75 \$12 00

NINE Bargés

48 Point

Special Characters \$1 20 per font

3 A \$5 65 4 a \$3 95 \$9 60

Coming BACK

42 Point

Special Characters \$0 95 per font

3 A \$4 45 4 a \$3 05 \$7 50

BARBER Singés

36 Point

3 A \$3 55 4 a \$2 50 \$6 05
Special Characters \$0 75 per font

18 Point

6 A \$1 65 10 a \$1 60 \$3 25
Special Characters \$0 45 per font

Huge GUN

CONDESCEND
Billiard Expert

30 Point

3 A \$2 45 5 a \$2 00 \$4 45
Special Characters \$0 70 per font

14 Point

7 A \$1 45 12 a \$1 55 \$3 00

NINE Played

GERMAN COUNT
Closing Exercises

24 Point

4 A \$1 80 6 a \$1 70 \$3 50
Special Characters \$0 50 per font

12 Point

8 A \$1 25 15 a \$1 50 \$2 75

Maine GUIDES

ELEGANT PARLORS
Child Found Emerald
Lay \$1234567890 Out

The of c o f f i n s e o r ✨

These Special Characters are put up with 12 and 14 Point fonts They are sold in separate fonts from 18 to 72 Point inclusive

Unique Card

NEW AND COMIC

Something new and original, with catchy verses and clever pictures. A regular valentine in itself. This card is printed in striking colors, presenting a pretty, attractive and artistic appearance. Twenty Cards enclosed in most novel folder for Fifteen cents. Send some of these nobby Valentine Cards to friends

Gillespie & Smith
Company

Curtis Border

LEMONICE TOKENS

A dessert confection with delicateness of flavor and sweetness that will delight any taste for the exquisite

ASK YOUR HOME GROCER
ONE DIME PACKAGES

Boxhead Gothics

5 Point No. 3 26 A \$1 50
EXQUISITE AMERICAN PRODUCTS PRINTERS USE BOXHEAD GOTHIC DESIGNED FOR MANIFOLD WORK EASTERN \$1234567890 PAPERS

5 Point No. 23 26 A \$1 50
THEATRICAL STARS REHEARSING PREDICT DESTRUCTIVE TORNADO DELEGATES PRAISE CONVENTION SOUVENIR \$1234567890 POSTAL

5 Point No. 13 31 A \$1 50
ADVERTISING GRAND ENTERTAINMENTS MANY REMARKABLE GENTLEMEN SPOKE ADMIRE TWENTY GORGEOUS COSTUMES FORWARDED \$1234567890 CHECKBOOK

4 1-2 Point No. 2 32 A \$1 50
MODERN CREATIONS PLEASING CRITICS COMMERCIAL COMPOSITORS DELIGHTED ORIGINATED TYPOGRAPHICAL MATERIAL RULED HEADINGS PRINTED DISTINCTLY

4 1-2 Point No. 22 32 A \$1 50
EXPERT GOLD MINERS CLIMB MOUNTAIN ONE HONEST LAWYER REFUSED BRIBES OWNED MAGNIFICENT FOREST RESERVE GIGANTIC STEAMER ENTERED NEWPORT

4 1-2 Point No. 12 37 A \$1 50
BEAUTIFUL SEPTEMBER DAYS PLEASE WALKER STRONG APPRENTICE INHERITS LARGE HOUSES HIGH BUILDING BEING REPAIRED BY WORKMEN GREAT AEROPLANE FLIGHT STARTS WEDNESDAY

4 Point No. 1 37 A \$1 50
AMERICAN TYPE FOUNDERS COMPANY SERIES MODERN BRASS RULE, ORNAMENTS AND TYPE SELLING COMPLETE PRINTING OFFICE OUTFIT HANDSOME AND USEFUL BORDERS PRODUCED

4 Point No. 21 37 A \$1 50
ENERGETIC RAILROAD PRESIDENTS RECEIVED ITALIAN STATUES REMOVED FROM NEW PARIS FOREIGN NOBLEMAN COURTS AMERICAN GIRL DELIVERING MUCH INTERESTING LITERATURE

4 Point No. 11 42 A \$1 50
LONESOME BACHELOR READS MARVELOUS LOVE TALE EXPERIENCED LUMBERMEN WORKED LAST CHRISTMAS IMPORTANT DOCUMENTS MAILED BY PROMINENT LADY GOVERNMENT INSPECTOR FOUND SATISFACTORY MAN

5 Point No. 103 34 A \$1 50
INTERESTING REPORT MADE BY DETECTIVE EXCURSIONISTS HAVING VERY FINE OUTING FOREMOST PUBLISHER VISITING AUSTRALIA BRAVE FIREMAN \$1234567890 FOUND DIME

5 Point No. 33 31 A \$1 50
WESTERN COWPUNCHER ENJOYS VERSE YOUNG FOREMAN DEMANDED INCREASE TRAVELING SALESMAN INSPECTS PRESS HANDSOMER \$1234567890 STRUCTURE

Boxhead Gothics, comprising the smaller sizes of the Copperplate Gothic Family and also the small sizes of the Lightline Series are cast on the smallest practical bodies, and intended to be used where the space is very limited. This series will be found particularly useful in tabular and index card work where a large number of words are often required in a limited space. The illustrations below give but a vague idea of the usefulness of Boxhead Gothics. Printers with up-to-date ideas will readily see the advantages of this up-to-the-minute series.

4 1-2 Point No. 102 40 A \$1 50
BRIGHT MAIDENS ENTERTAIN BRILLIANT TEACHERS ARMED BANDITS SURPRISE OLD RAILROAD PORTER COMELY SINGER BEFRIENDS HONEST PLAYWRIGHTS FINEST DISPLAY PAGES DESIGNED BY COMPOSITOR

4 1-2 Point No. 32 37 A \$1 50
FORTUNE HUNTER SEIZED WONDERFUL PLANTS ROBINS MIGRATE SOUTHWARD BEFORE AUTUMN FOREIGN WARSHIPS LEFT EUROPEAN COUNTRY GERMAN SAILOR REMAINED ASHORE OVERTIME

4 Point No. 101 46 A \$1 50
GERMAN ENTERS UNIVERSITY AFTER PREPARATORY COURSE YOUNG ARCHITECT WON COVETED GOLD MEDALLION FRIDAY MAGISTRATE QUESTIONING CONVICTS ABOUT BANK ROBBERY NUMEROUS HINTS GIVEN ON SECURING TRADE IN ENGLAND

4 Point No. 31 42 A \$1 50
SUFFICIENT EVIDENCE WAS PRODUCED AND REJECTED SEVERAL DOMICILES DESTROYED BY TERRIBLE STORM BURGLAR CAPTURED AFTER LONG AND TIRESOME RUN PROMINENT MEN REVIEW MONSTER MILITARY PARADE

EXAMPLES SHOWING HOW SPACE MAY BE ECONOMIZED BY USING BOXHEAD GOTHICS

LIST OF DEPARTMENT ORDERS					
NUMBERS OF THE DEPARTMENT ORDER	OBJECT OF THE DEPARTMENT ORDER	QUANTITY TO BE MADE	DESIGNATION AND DESCRIPTION OF EACH ARTICLE WHICH IS SUBJECT OF THIS DEPARTMENT ORDER	DATE ENTIRE JOB WAS FINISHED	PREPARATIONS BEFORE EXECUTING THE ORDER

YOU CAN WORK CLOSE TO THE RULE WITH BOXHEAD GOTHIC

NAME		EXPIRATION		
BUSINESS				
NO. MEN	PAY ROLL	NO. TEAMS	NO. LOADS	PER HOUR
INTERVIEWS				
DATE	RATE	RESULT		

OFFSET LIGHT LITHO GOTHIC

12 Point 15 A \$2 70 30 a \$2 80 \$5 50

PRODUCES EXQUISITE DESIGN
 Praised Received Daily from Printers

6 Point No. 1 19 A \$2 00 38 a \$2 00 \$4 00

EXPERT MECHANIC ENJOYED RIDING
 Italian General Demands Entire Command Foreign Noblemen Welcome Rich Spansard

10 Point 16 A \$2 50 31 a \$2 50 \$5 00

MAKES WONDERFUL DISCOVERY
 Important Inventions Patented Recently

6 Point No. 2 25 A \$2 00 48 a \$2 00 \$4 00

SHOWING DESIRABLE AMERICAN TYPE FACE
 Honorable Saliors Receive \$1234567890 Salary Today Great Adventurers Conquerable Remarkable Change

8 Point 18 A \$2 30 35 a \$2 20 \$4 50

TYPOGRAPHICAL ARTIST BECAME BLIND
 Marvelous Building Being Repaired by Contract

5 Point 18 A \$2 00 35 a \$2 00 \$4 00

WITNESS REFINED BURGLES PRODUCTION
 Extraordinary Typographical Printing Show Customers Modern Equipments Supplied Promptly and Responsibly

TITLE OFFSET LIGHT LITHO GOTHIC

6 Point No. 4 20 A \$2 00

SHOWING TITLE OFFSET LIGHT LITHO GOTHIC
 STRONGER BANKING \$1234567890 INSTITUTION

6 Point No. 2 29 A \$2 00

PURCHASE HANDSOME BORDERS AND ORNAMENTS
 PRISTINE MATERIAL MADE BY THIS COMPANY

6 Point No. 3 25 A \$2 00

HEBREW MAGICAL AMUSED VAST AUDIENCE DURING FAIR
 COMPICATOR DISPLAYED CLEAR ORIGINALITY IN DESIGN

6 Point No. 1 34 A \$2 00

PRODUCING LITHOGRAPHIC REPRODUCTION HERE
 USING BRASS RULES AND QUADS IN IMMENSE QUANTITIES

Sizes and Prices

18 Point 8 A \$1 10 22 a \$1 85 \$3 25

Rough Sailing Weather

11 Point 10 A \$1 25 33 a \$1 75 \$3 00

Purchased Beautiful Souvenir
Gymnasium Exercises Taught

12 Point 13 A \$1 25 37 a \$1 50 \$2 75

Splendid American Type Required
Patrolled Treacherous Waterfront
Educating \$1234567890 Printers

10 Point 14 A \$1 10 41 a \$1 40 \$2 50

Artistic Figures are Remarkable
Natural Grace is Shown Most Distinctly
Welcomes Youthful Elopers Bride Home

8 Point 16 A \$1 00 48 a \$1 25 \$2 25

Novel Type Design Containing Modern Feature
Stylish Printers Obtained this Attractive Series
Interesting also Pleasing Historical Production

A Announcement

According to our annual custom we again call the attention of our patrons to the spring display of special importations of beautiful foreign fabrics which are used in our distinctive tailoring for men of fashion. A glance in our store windows on Friday, September ninth, the opening day, will more than satisfy you that our stock of

English Suitings

comprises some of the richest as well as exclusive designs shown anywhere this season. You have never worn a suit or topcoat such as we make to your measure for thirty dollars. A combination of workmanship, style and service in these garments at this price is not to be duplicated by any tailor

Hunter & Graham

South Cothorton

Roscoe Musical and Singing Society

request the honor of your presence
on the occasion of their

First Recital and Entertainment

to be held in District School

Monday evening, August twelfth
at eight-thirty o'clock

48 Point

4 A \$3 75 10 a \$3 75 \$7 50

University Golfers Competing

42 Point

4 A \$2 95 11 a \$3 30 \$6 25

Deposits Received Large Interest

36 Point

4 A \$2 35 13 a \$2 65 \$5 00

Improvements Concerning Themselves
Having Marvellous Speakers Entertain

30 Point

5 A \$2 05 15 a \$2 20 \$4 25

Washington Smithsonian Institution Opens
Printer Contributes Beautiful Announcement

24 Point No. 1

6 A \$1 70 18 a \$1 90 \$3 60

Numerous Wonderful Inventions Discovered Recently
Latest Remodeled Machinery Invariably Appreciated

24 Point No. 2

7 A \$1 70 19 a \$1 80 \$3 50

Change Austrian Establishment
Favorable Decision Withdrawn

12 Point

12 A \$1 15 45 a \$1 60 \$2 75

Banker Renewing Temporary Loans
Experienced Railroadings Associations
Show Legible \$1234567890 Figures

18 Point No. 1

9 A \$1 40 30 a \$1 85 \$3 25

Fine Grades of Beautiful Stationery
Important Notice Sent Membership

10 Point

15 A \$1 10 50 a \$1 40 \$2 50

Broadway Department Stores Remodeled
Prairie Fires Cause Inestimable Damage
Marvellous Workman Shows Ingratitude

18 Point No. 2

10 A \$1 50 30 a \$1 75 \$3 25

Increase Delights Circulation Manager
One Premium Given With Subscription

8 Point

16 A \$1 00 54 a \$1 25 \$2 25

Thoughtful Lieutenant Promises Increased Rations
Elected Former Corporation President Unanimously
Warehouse Capacity Guaranteed Sufficiently Large

14 Point

13 A \$1 35 40 a \$1 65 \$3 00

The Secretary Inhibits Competitive Bidders
Former Treasurer Elected as Representative
Club Renobating Old Bachelor Apartments

6 Point

18 A \$0 90 60 a \$1 10 \$2 00

Greatest Exhibitions Shown Anywhere Containing Originality
Mischievous Children Circulating Terribly Damaging Evidence
Nest and Clear Effects can be Obtained by Every Good Printer
Advertising Must Attract Public Attention When Done Right
Regarded Exceptionally \$1234567890 Brilliant College Career

Wedding Text

"Qui non proficit deficit"

Class of Nineteen Hundred and Twelve

Mountclair College

requests the pleasure of your presence at the

Commencement Exercises

in College Hall, Wednesday evening
September the twenty-third, at eight o'clock

Class Members

Nadene Baley Madison
Vira Williams Dexheimer
Charles Swenarton

Edmund M. MacGregor
Oswald Hendricks
Dwight Kingsley Crocker

Mr. and Mrs. Philip Hoffman

request the pleasure of

company at dinner

on the evening of Wednesday, the twenty-seventh of February
at half after seven o'clock

Hotel Savoy

R. s. b. p.

48 Point

4 A \$1 15 8 a \$3 35 \$7 50

Remarkable Experiences
Satisfy Critical Printers

36 Point

4 A \$2 35 11 a \$2 65 \$5 00

Beautiful Heiress Writes Experience
Indestructible Organ Demonstrated

30 Point

5 A \$2 00 14 a \$2 25 \$4 25

Monthly Entertainment Provokes Laughter
Sensational Developments Reported Untrue
Valuable Information Concerning Portraits

24 Point

5 A \$1 50 16 a \$2 00 \$3 50

Preliminary Events Conducted Without Ceremony
Representative Gathering Indorsed Propositions
Unusually Attractive Designs Pleasing Everyone

18 Point

8 A \$1 45 25 a \$1 80 \$3 25

Conservative Bankers Mistaken
Mystery Surrounds Flopements
Agricultural Experts Banqueted

10 Point

16 A \$1 10 50 a \$1 40 \$2 50

While Good Judgment in Any One Direction is to be Commended, it does not Necessarily Mean a Successful Business, and a Big Improvement in the Way of Conducting Printing Offices Will Come Only With Highest Degree of Perfection

14 Point

13 A \$1 40 38 a \$1 60 \$3 00

Enterprising Fisherman Organizes Business
Massachusetts Professor Disappears Quietly
Unfortunate Prospector Accidentally Injured

8 Point No. 1

18 A \$1 00 54 a \$1 25 \$2 25

The Highest State of Perfection in the Internal Affairs of any Printery is the Natural Aim of Every Ambitious Printer. He Strives to Have the Best of Everything. He Realizes that with the Best Class of Workmen He Loses Something Unless He has a Thoroughly Equipped Plant

12 Point

15 A \$1 25 45 a \$1 50 \$2 75

A New Monthly Publication Containing Exhibits of Papers Printed in Choice Color Schemes and With Typographic and 51234567890 Other Decorations

8 Point No. 2

22 A \$1 00 65 a \$1 25 \$2 25

Never be Afraid of Getting a Pointer From a Subordinate. There Isn't Anyone who Possesses All the Wisdom in the World, and Very Helpful Suggestion Often Come From Most Unexpected Quarters. When You do Secure a Bright Idea Give 51234567890 Credit to the Originator

Dr. Frederick McCoombs

Office Hours:
8 to 9 a. m., 5 to 7 p. m.

Cleveland

Mr. and Mrs. James Henry Smith

announce the marriage of their daughter

Alice Emily

to

Mr. Harold Williams

on Wednesday, November the twenty-second

one thousand nine hundred twelve

Philadelphia

At Home

after December the twenty-second

Mrs. Horace Brown Hall

Fifty Clifton Avenue

72 Point

3 A \$7 25 5 a \$4 40 \$11 65

Daring Brigade

60 Point

3 A \$5 65 5 a \$4 10 \$9 75

Americans Return

48 Point

3 A \$3 75 7 a \$3 75 \$7 50

Dignified Management

42 Point

4 A \$3 35 7 a \$2 90 \$6 25

Extraordinary Statements

36 Point

4 A \$2 60 8 a \$2 40 \$5 00

Society Entertainments Given

30 Point

5 A \$2 05 11 a \$2 25 \$4 30

Constitution Saved
Rightly Disregards

24 Point

5 A \$1 65 12 a \$1 85 \$3 50

Eliminate the Objection
Truest Workmen Pride

18 Point

8 A \$1 40 22 a \$1 85 \$3 25

Presentation at the Exposition
Garden Musicale with Supper

14 Point

10 A \$1 25 33 a \$1 75 \$3 00

At the Sixteenth Street Baptist Church
Please Present this Card of Admission

12 Point

13 A \$1 25 37 a \$1 50 \$2 75

Johustown Night School Requests
Horse Racing at Manhattan Beach
Graduating Exercises on Thursday
Beautiful \$1234567890 Parisian

10 Point

14 A \$1 10 44 a \$1 40 \$2 50

Reasonable Offers Given Consideration
Gallant Soldiers Promoted to High Rank
Numerous Officials Entertained Women
Many Distinguished European Students

8 Point

16 A \$1 00 48 a \$1 25 \$2 25

Victorious Grenadiers Receiving Highest Praise
Spontaneous Combustion Starts Conflagration
Curious Ornaments Confiscated by Highbinders
Some Romantic Escapades Recently Discovered

6 Point

16 A \$0 85 50 a \$1 15 \$2 00

Hungarian Comedians Demanded Insurance Protection
The Magnificent Records Surpassed Previous Trials
Government Employes Have Vacation Time Extended
Acrobat Performs \$1234567890 Eleven Risky Stunts

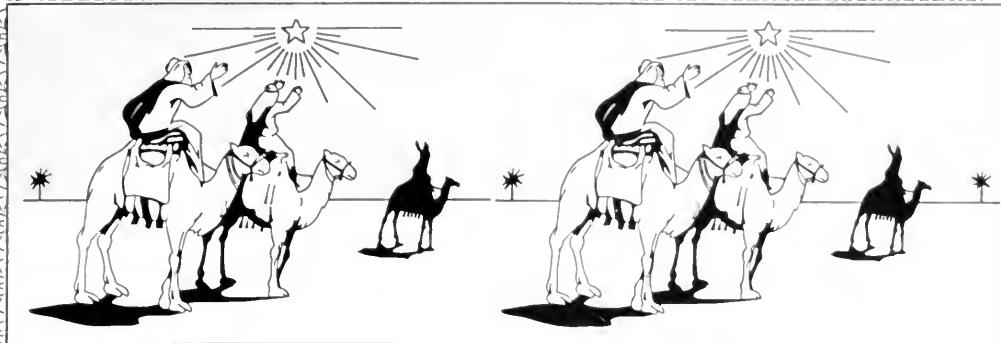

Order of Services

The Star of Bethlehem	-	-	-	Duet
Miss Elizabeth Knowles	Miss Georgina Bandson			
The Gathering Shepards	-	-	-	Recitation
Mr. George Henry Matthews				
Christ, The Lord, Has Risen	-	-	-	Quartette
Miss Clara Nelson	Miss May Drew	Messrs. Brown and Drew		
Praises Unto Christ, The Lord	-	-	-	Solo
Mrs. William Stevenson				
The Everlasting Light	-	-	-	Duet
Mr. Maurice Dawson	Miss Grace Newman			
Peace On Earth, Good Will Toward Men	-			Quartette
The Presbyterian Sunday School Quartette				
Light Shining Out of Darkness	-	-	-	Solo
Mr. Samuel Nathan Cunningham				
For the Love of His People	-	-	-	Sermon
Reverend Henry M. Saddington				

O lovely voices of the sky, that hymned the Saviour's birth,
 Are ye not singing still on high, who once sang, "Peace on earth!"
 Shall o'er us float those holy strains, wherewith, in days gone by,
 Ye blessed the lonely Syrian swains, O voices of the sky!

Protestant Church of Stuckem

Reverend Samuel M. Hornblower Paul Stone, Assistant

Engravers Old English Bold

72 Point

3 A \$8 35 4 a \$4 85 \$13 20

Rich Design

60 Point

3 A \$6 80 5 a \$4 65 \$11 45

Durable Metal
Copper Alloys

48 Point

3 A \$4 20 6 a \$3 85 \$8 05

Handsome Cards
Popular Material

42 Point

3 A \$3 65 6 a \$3 15 \$6 80

American Line Type
Handsome Creation

36 Point

3 A \$2 65 6 a \$2 35 \$5 00

Excellent Display Lines
Wonderful Typography

Engravers Old English Bold

30 Point

4 A \$2 10 9a \$2 15 \$4 25

Satisfactory Display Letters
Given Favorable Advantage
Desirable Stationery Printed

24 Point

4 A \$1 55 12a \$1 95 \$3 50

Magnificent Opportunity Tendered
Designs Contain Exceptional Merit
Enthusiastic Advertisers Rejoicing

18 Point

7 A \$1 40 20a \$1 85 \$3 25

The hope of the Printer for Better Prices will
be Realized Gradually but Positively by the
Public Becoming More Familiar With Faces

14 Point

9 A \$1 25 28a \$1 75 \$3 00

When anything in Art or Style gets established in Printing
Shops there is sure to be a Reaction. Printing Buyers of
today want Variety in their Work and the Up-to-Date Type
Faces that are Attractive and Catch the Eyes of the Public

12 Point

11 A \$1 20 31a \$1 55 \$2 75

When a Printing Office gets into a
rut in style and clings persistently
to a limited few Faces of Type, no
matter how good they may be, it is
bound to lose trade \$1234567890

8 Point

14 A \$1 00 41a \$1 25 \$2 50

When you find a Printer who is selling
his Product as so much paper smeared
with Ink, you have found One who has
missed his real Vocation in Life. The
Successful printer of the Future must
sell Business-getting Potentiality. He
will Educate his Customers to this idea

10 Point

12 A \$1 10 36a \$1 40 \$2 50

The effective and progressive Printers of
the Country are Educating the Public to a
better Appreciation of what Real Quality
in Printing consists of. It is not the paper
ink and binding, but it is Stylishness, the
Expression of Fine Art. It is intellectual

6 Point

16 A \$0 90 47a \$1 10 \$2 00

The publisher who neglects the study of good
Typographic Style is not onto his Job. He is
advertising himself adversely, or, to be more
explicit, he is Glaringly Advertising the Fact
that his interest in the Advertiser ceases when
the space contract is signed. Those who place
the great Advertising contracts, and also those
Intelligent Advertisers on a Lesser Scale are
Illustrations \$1234567890 Original Designs

Printer's ink widens the world of every business. If a business is worthy and managed well, printing is the next great factor in its success.—Selected.

Hapgood Floret Art-tiles and Outline Art-tiles

Bertram Manor



Seventh Souvenir Book



Versatile Ornament Century Border

Citizens Bank of Holland

Worcester Street
and Lenox Avenue
Holland, Maine



The wealth and frugality of a people may be best judged by the records of a progressive bank located in its midst. For this reason we take pride in reciting the growth of the Citizens Bank, reflecting credit as it does both to its careful management and the development of the community which it has served. Back in those days of General Grant's presidency, 9 years after the close

Floral Basket Piece

Christmas Day

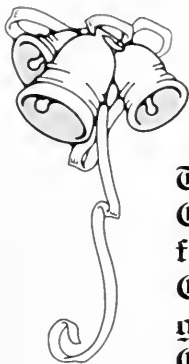

St. Paul's Church



The Members of St. Paul's Church desire to invite their friends and neighbors to the Christmas Day service to be given in the new St. Paul's Church on Main Street Park and can assure all who come a most cordial welcome. The morning service will begin at ten thirty o'clock sharp, and the afternoon service opens at three o'clock. A selected choir of fifty voices will be on hand to render sacred carols

Services
Morning and Afternoon

French Cast Squares Art-tile Tint Formers Holiday Decorators

Musical

Thursday Evening
May Second

In aid of Saint Peter's Home for Destitute Children. To be held in the Church Annex Main and Norton Streets, Harper, Illinois

Card of Admission
Fifty Cents

Concert

An Excellent Letter
for High-Grade
Church and
Society Printing

American
Type
Founders
Company

Originator and Maker

72 Point

3 A \$7 40 5 a \$4 25 \$11 65

Grand Singers

60 Point

3 A \$6 25 6 a \$4 60 \$10 85

Outfight Rangers

48 Point

4 A \$4 40 7 a \$3 10 \$7 50

Mathematical Problem

42 Point

4 A \$3 60 8 a \$2 70 \$6 30

Incapacitated Ambassador

36 Point

4 A \$2 80 9 a \$2 40 \$5 20

Burlesque Comedian Stranded

30 Point

5 A \$2 30 11 a \$2 00 \$4 30

Insurance Company
Diplomats Honored

24 Point

5 A \$1 70 14 a \$1 80 \$3 50

Harmoniously Arranged
Surprise and Conviction

18 Point

8 A \$1 60 22 a \$1 70 \$3 30

Newest Business Proposition
Lightning Calculator Outdone

14 Point

10 A \$1 40 32 a \$1 60 \$3 00

Renowned Scientist Makes Discovery
Magnificent Combinations Appreciated

12 Point

12 A \$1 30 36 a \$1 45 \$2 75

Education of Its People Has Been
and is Now the Most Vital Concern
of Every Good Government in This
Progressive \$1234567890 World

10 Point

14 A \$1 20 42 a \$1 30 \$2 50

World's Foremost Printers Recognize
Superiority of American Type and Rule
The American Productions Embrace All
the Latest Styles in Type and Material

8 Point

16 A \$1 05 52 a \$1 20 \$2 25

There Are Few Positions in Which More Diplomacy
and Tact is Required than that of Publisher or Editor
of a Country Newspaper. In Order to be Successful
One Must be Resourceful, Practical and Observing

6 Point

17 A \$0 95 55 a \$1 05 \$2 00

When a Customer enters Your Office and Seeks Information
Concerning the Doing of a Piece of Printing with the Evident
Intention of Ordering the Job, We Should be Met by Some
Person Capable of Giving \$1234567890 Such Information

Sader Glass Works

Manufacturers and Wholesale Dealers in

Ornamental Art Windows
For Churches and Libraries

Office and Works: Corner Star Road and Broadway, Milwaukee, Wisconsin



Inland Border No. 2405 Panel Borders Art Ornaments

The Cruise of the Tartan

A drama taken from the book of that name, written by Paul Habel

The Stevens Institute Dramatic Club

Elite Theatre
Nason Street



June Twelve
Eight P. M.

Benefit of the Home for Disabled Seamen
Tickets Two Dollars

Inland Border No. 2405 Art Ornament

96 Point

3 A \$8 60 4 a \$3 40 \$12 00

Wined Riches

72 Point

3 A \$6 60 5 a \$3 40 \$10 00

Fight Quarantined

60 Point

3 A \$5 50 5 a \$2 75 \$8 25

Representative Elected

48 Point

4 A \$4 30 6 a \$2 20 \$6 50

Winter Homes

42 Point

3 A \$2 85 9 a \$2 40 \$5 25

Brother Suspects

36 Point

3 A \$2 15 10 a \$2 15 \$4 30

Remarkable Cabinet

30 Point

5 A \$2 05 15 a \$1 95 \$4 00

Elegant Wearing Styles

24 Point

6 A \$1 85 19 a \$1 70 \$3 55

Great Legislature Candidates

18 Point

10 A \$1 70 30 a \$1 60 \$3 30

Prominent Social Leaders Assembled Washingtonian Respects Baltimorean

14 Point

13 A \$1 55 42 a \$1 45 \$3 00

Explosion Damages Large Factories Quickly Restored Business Methods Great Demonstration Shown Today Amendments Considered and Adopted

12 Point

13 A \$1 25 52 a \$1 50 \$2 75

Financial Assistance Comes to Rich Woman More Automobiles Returned Without Notice Discerning Painters Appreciated Enthusiasm Hunting Stolen \$1234567890 Machines

10 Point

15 A \$1 10 58 a \$1 40 \$2 50

Insurance Company Requires Efficient Attorneys Two Hundred Miles Promised Before Next Month Immediately Recognizes Distinguished Englishman United States Marine Band Entertains President

8 Point

16 A \$0 95 68 a \$1 30 \$2 25

Indignant Creditors Devise Means to Apprehend Bank Cashier Some Marvellous Evidence Obtained Through Constant Work Hundreds Perish While Returning From Perilous Sea Voyage Curious Specimens and Ancient Pottery Received by Americans

6 Point

18 A \$0 85 72 a \$1 15 \$2 00

Railroads Extending Through Principal Counties and Cities of the West Wore and Better Racing This Summer Than Ever Before at Wood Park The Process of Making Folding Paper Boxes is Simple and Wonderful Beneficial Results Obtained From Swimming in the Mediterranean Water Economical People Always \$1234567890 Save their Money and Time

Wenstrom Photographic Studio



Keep these proofs from strong light and do not roll or wrinkle. These are photographer's proofs only and have not the fine finish or distinctness of the completed portrait from retouched negative. All proofs should be approved or rejected within ten days. Mail them or return in person, the latter preferred

These Proofs remain the property of Harlow Wenstrom and must be returned

Inland Border No. 1240 Swastika Outline Border

Holidays

Will soon be here and you will want a suitable gift or remembrance for your boys and girls. The great story feature of *Our Little Folk* will interest all the children

Baptist Publishing Co.

Holiday Decorator Linear Border Cast Panel Pieces

Six Dollars the Year

Book Lore

A Magazine for Readers



Kindly save this slip and use as book mark until you are ready to subscribe

One Coupon

like this and Five Dollars will bring the Book Lore to You

Floral Basket Piece

72 Point

3 A \$6 00 5 a \$3 85 \$9 85

Brave Imperialist

60 Point

3 A \$4 35 6 a \$3 90 \$8 25

Endanger Prosperity

54 Point

3 A \$3 75 8 a \$3 90 \$7 65

Translates Manuscript

48 Point

3 A \$3 00 8 a \$3 30 \$6 30

Makes Beautiful Creation

42 Point

3 A \$2 40 9 a \$2 85 \$5 25

Showing American Character

36 Point

4 A \$2 30 9 a \$2 25 \$4 55

Ancient Language
Distinctive Quality

30 Point

5 A \$1 90 13 a \$2 15 \$4 05

Published Magazines
Corporation Treasure

24 Point

6 A \$1 60 17 a \$1 90 \$3 50

Dangerous Combinations
Opportunity Disappeared

18 Point

9 A \$1 40 26 a \$1 85 \$3 25

Experienced Pressman Wanted
Hospitable Citizens Threatened

12 Point

13 A \$1 15 40 a \$1 60 \$2 75

The Selection of Designs Produced
by This Company Exceeds in Both
Utility and Variety the Products of
All other \$1234567890 Foundries

10 Point

14 A \$1 10 44 a \$1 40 \$2 50

The Business Men in the United States
Are Better Educated on Type Than Are
Those of Any Other Country. The Press
of This Country is Educating Everyone
Interested to Demand First Class Work

8 Point

16 A \$0 95 50 a \$1 30 \$2 25

The Early Advertisers All Used the Same Styles
and Sizes of Types. From this Ruck of Monotony
at Intervals an Advertiser Emerged with a Grain
of Individuality. Nowadays Your Advertisement
Must have Individuality in Order to be Effective

6 Point

17 A \$0 85 53 a \$1 15 \$2 00

A Sure Sign of the Amateur in Types is the Tendency
Toward Ornamental Types, Just as the Novice in Art
Turns to Chromos with Delight. One Cannot go Wrong
if the Style of Types Shown in this Specimen Book and
Supplement are \$1234567890 Occasionally Referred to

Annual Convention Number

The Mission Star of Hope

An Illustrated Monthly Magazine in the Interest
of Missionary Work Abroad



September

An Old Manchurian Church Yard

True Story by Sister Agnes, Port Arthur

The Lama's Flight to Hongkong

By Rev. A. Talbot, Peking

Revolt in Persia and Its Origin

By Bishop Dr. Darklegh, Teheran

Missionaries in Eskimo Regions

By Pastors J. Rock and W. Gary

State and Religion in Montenegro

By U. S. Consular Agent Fred. Holden

Progressive Missions in Turkey

Annual Report by Deacon D. T. Crombie

China and Our Baptist Missions

By Bishop J. D. Wolcott, Hongkong



The United Mission Society
of the State of West Virginia

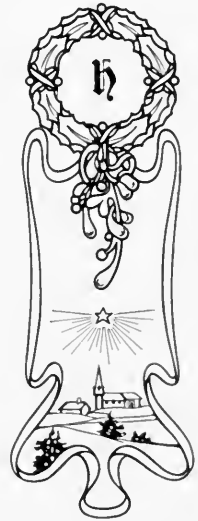
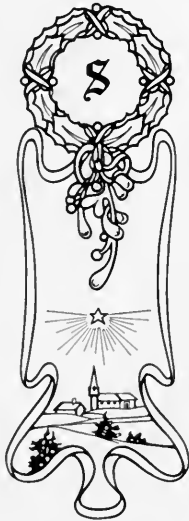

Volume 14

Number 11

Cathedral Text

60 Point

3 A \$8 05 5 a \$6 20 \$14 25

Grand Wife

48 Point

3 A \$4 90 7 a \$5 20 \$10 10

Draw Contests

42 Point

3 A \$3 95 7 a \$3 85 \$7 80

Pleasant Memory

36 Point

3 A \$3 05 8 a \$3 40 \$6 45

**Bandit Shows Guns
Absconder Drowned**

30 Point

4 A \$2 50 10 a \$2 85 \$5 35

**Snake River
Wanderlust**

12 Point

9 A \$1 15 27 a \$1 60 \$2 75

**Practical and Ambitious
Compositors Appreciated
Where Artistic Printing
is Required \$1234567890**

24 Point

5 A \$2 40 12 a \$2 20 \$4 60

**Able Statesman
General Orders**

10 Point

10 A \$1 05 30 a \$1 55 \$2 60

**Beautiful Text Letters Seem
to Have That Hand-Lettered
Effect Used in Fine Printing
American Line is Prominent**

18 Point

6 A \$1 70 16 a \$2 10 \$3 80

**Metropolitan Dairy
Printshop Foreman**

8 Point

12 A \$1 00 36 a \$1 30 \$2 30

**Affability and Good Manners Should
be Assets of the Person Who Comes in
Contact with the Public. Discourtesy
Has Lost Many a Paying Customer**

14 Point

6 A \$1 15 22 a \$1 85 \$3 00

**Artistic Catalogue Shops
Retirements Involuntary
Dynamite Causes Deaths**

6 Point

14 A \$0 90 40 a \$1 20 \$2 10

**Whenever a Printing Office Gets into a Rut
in Style and Adheres to a Limited Few Kinds
of Types Its Popularity Will Wane. You can
Distribute a Confirmed Typographic Style in
a Varied Community, up to a Certain Point
Without Being Monotonous \$1234567890**



Pottery of the King Louis Pattern is conceded by all judges to be the most durable made and with ordinary use will last for years and years

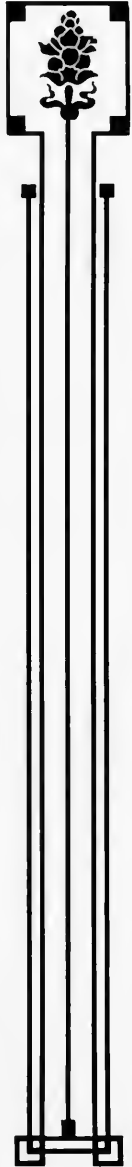

King Louis Pottery

This ware is the product of hard fire. The aim is not only to produce beautiful form, decoration and color, but by the high temperature reached to give to the dead glaze a texture and the quality seldom found outside the ancient Chinese pots. Dull yellows, blues, browns, greens, grays, pinks and blacks, in many shades and varieties of effect, represent the widest range in color. Human and animal forms are used in the decoration. We believe it better to bring out a limited edition of a beautiful and carefully thought out design, varying in each piece the color and glaze effect, than to seek and execute hastily some new design for each piece. A catalogue, for which we are often asked, would be unsatisfactory, for each piece is taken up and the price made according to individual value. This description will also give an idea of what we

are doing in tiles suitable and interior decorations. This pottery has been set and in operation for a century has acquired the skill that experience alone can give. Its ideal product has long standard in art pottery and will so continue as long as the aristocracy are and those fortunate enough to have you call and inspect with beautiful photograph.



Ellis & A
Red Harbor Road



The factory is one of the being established more ago and is considered by

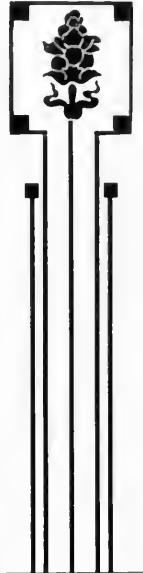

Winter Outings

A Booklet of Information for Winter Pleasure Seekers Containing Many Illustrations of Various Resorts Within Reach

Compliments of
Haynes & Williams
Portland, Ohio

72 Point

3 A \$6 85 4 a \$4 35 \$11 20

Dairy Maiden

48 Point

3 A \$4 20 6 a \$3 50 \$7 70

California Damsels

42 Point

4 A \$3 60 6 a \$2 80 \$6 40

Publisher Wandering

36 Point

4 A \$2 70 7 a \$2 30 \$5 00

Veterinary Surgeon Retired
Destroy Quaint Bungalows

30 Point

4 A \$2 00 10 a \$2 30 \$4 30

Returning Handsome Specimens
Eccentric Performers Applauded

24 Point

5 A \$1 65 13 a \$1 90 \$3 55

Testimony Considered
Beautiful and Dreamy

10 Point

10 A \$0 95 36 a \$1 55 \$2 50

One of the Great Advantages in
the Point System Applied to the
Spaces is the Convenience with
which Corrections Can be Made

18 Point

7 A \$1 50 18 a \$1 75 \$3 25

Many Logical Conclusions
Wealthy Authors Embark

8 Point

14 A \$0 95 40 a \$1 30 \$2 25

Magnificent Specimens Delivered Today
Tornado Destroying Beautiful Mansions
Railroad Trainmen Received Paymaster
Missouri River Beauty Being Enhanced

12 Point

10 A \$1 15 30 a \$1 65 \$2 80

Every Original and Good Type Style
Stimulates Orders and Brings Trade
to the Many \$1234567890 Printers

6 Point

16 A \$0 85 50 a \$1 15 \$2 00

Our Ornamental Faces Command Particular Attention
American Type Foundry Company Make Tudor Black
The Entire Series Being Useful for Beautiful Display
Bachelor Compositor Returned from Extended Vacation
Claimed to have Spent \$1234567890 While Rambling



Easter Offerings

Many charming Gowns for Easter-tide are now here for the critical inspection of our customers. All the latest German and French styles are shown in faithful reproduction by our tailoring experts. We cordially invite you



Our new beautifully illustrated Style Book is just off the press. It will be found full of valuable hints. Sent free for the asking.

E. Honestdealer Dry Goods Company
Bloomingdale and Thornrose Avenues, St. Bernardsville
Exclusive Styles for Fashionable Ladies Who Know



Easter Border Strathmore Ornament

Grand Entertainment



The ninth annual reception and ball will be held at Elks Hall, corner First and King Streets, Passaic, on Friday evening, at nine o'clock; the committee cordially extends you an invitation to attend



Federal Printing and Binding Company



Cheltenham Border Strathmore Ornaments

60 Point

3 A \$4 90 4 a \$3 10 \$8 00

RECENT HOMES Handsome Waiter

48 Point

3 A \$3 20 6 a \$3 05 \$6 25

RETURNED PRESENT Prudent Consideration

36 Point

4 A \$2 00 9 a \$2 25 \$4 25

RENOWNED HAND WORKMAN Strange Theories Cause Laughter

24 Point

6 A \$1 40 18 a \$2 10 \$3 50

BANKER FOUND SHORT Big Development Expected

12 Point

16 A \$1 10 48 a \$1 65 \$2 75

NORTHERN REPORTER GOES HOME Demented Publisher Caused Excitement Rich Baker \$1234567890 Lost Dough

18 Point

9 A \$1 20 29 a \$2 05 \$3 25

HANDSOME CLERK RETURNS Clean Face for Prominent Display Printers Demanding Neat Effects

10 Point

18 A \$1 00 53 a \$1 50 \$2 50

GRAND PARADE POSTPONED THURSDAY Disappointed Citizens Return Home Disgusted Eight Policemen Charged on Angry Gathering Numerous Serious Injuries Reported Recently

14 Point

13 A \$1 20 39 a \$1 80 \$3 00

DEPENDENT FATHER CONDONES SON Consultation Proves Rather Unsatisfactory Several Eminent Throat Specialists Advise

8 Point

22 A \$0 90 65 a \$1 35 \$2 25

RECOVERED TWENTY THOUSAND DOLLARS TUESDAY Experts Claim Situation to be Rather an Unpleasant Affair Western Engraving Company Locates in Greater New York Profitable Business \$1234567890 Transaction Reported

60 Point

3 A \$6 95 4 a \$4 30 \$11 25

BIRDS Light

48 Point

3 A \$1 30 5 a \$3 20 \$7 50

Honest FRIEND

36 Point

4 A \$2 70 6 a \$3 30 \$5 00

FIREMEN'S Excursion

30 Point

4 A \$1 90 9 a \$2 35 \$4 25

LEASED DENVER RANCH Enjoyed Picturesque Scenes

24 Point

5 A \$1 55 11 a \$1 95 \$3 50

RUINED RAILROAD PRESIDENT Contractors Disclosed Imperfection

18 Point

9 A \$1 50 16 a \$1 75 \$3 25

DILIGENT STUDENTS Received Long Vacation Fine Mountain Scenery

10 Point

12 A \$1 00 36 a \$1 50 \$2 50

EXCITED BARBER SUBDUED Great Discord in Western Town Cow Puncher Demands Apology Serious Trouble Often Predicted Eminent Mechanic Found Work

14 Point

10 A \$1 25 26 a \$1 75 \$3 00

STRANGE BARGE SIGHTED Heading Direct for Fort Killen Eighty Tons of Dynamite Gone

8 Point

15 A \$0 90 46 a \$1 35 \$2 25

STRENUOUS THEATRICAL ASPIRANT Enormous Salary Offered Great Tragedian Grand Opera Singers Retiring From Stage Boy Actor Declines European Engagement Renowned Piano Players Touring America

12 Point

12 A \$1 20 30 a \$1 55 \$2 75

MANY INTERESTING SUBJECTS Prominent Citizen Attended Lecture Learned Judge Announced Speaker Rich Man \$1234567890 Signs Bond

6 Point

16 A \$0 80 48 a \$1 20 \$2 00

AMERICAN FAMILIES SOUGHT EVERYWHERE Five Foreign Newspaper Editors Visit United States Became Very Much Infatuated With New York City Mighty Buildings the Topic of General Conversation Paris Gentleman Refused to Leave Upper Broadway Society Leaders Entertained Distinguished Visitors The Hotel Bills Are \$1234567890 Increasing Rapidly

Most Graceful Letter
Handsome Script Design Bought

Beautiful Cards and Invitations
American's Latest Creations Satisfied Critics
Newport Lady Invited

Causing Envy Amongst the Engravers
Highest Grade Society and Commercial Stationery
Demonstrated Before Experts

Manuscripts Deciphered
Pleases Those Shrewd Customers
Original Creation

Indian Beauty Arrived
European Knights Return East
Strange Compositors
Justice Reprimands Sergeant

Six Fashionable Gentlemen
German Student Honoring Architect
Recent Invention
Magnificent Interior Decorations

Harrisburg Couple Honored
University Doctors Attend Annual Dance
Received Diplomas
Army Lieutenant Seeks Promotion
King Requested to Attend
Youthful Banker

The Rayden & Labelle Company
begs to announce an advance showing of
Importations of French Millinery
commencing April twenty on the eleventh floor of the
Weyman Building

Open even

elevator

Madame Elizabeth Thornley

Hat Millinery

The Crawford

Sixth Avenue

Yourself and company are cordially invited to attend an

August Garden Musicale

to be rendered by

The Herman Banerstein Symphony Orchestra

to be held on the lawn of Grace Church

Wednesday evening, August sixteenth

eight thirty to ten thirty

60 Point

3 A \$4 60 8 a \$5 45 \$10 05

*Kidnaps Old Merchant
Destroys Beautiful Photograph*

48 Point

3 A \$2 80 10 a \$4 70 \$7 50

*Norwegian Philanthropists
Superintendent Questions Apprentice*

36 Point

4 A \$2 55 14 a \$3 95 \$6 50

*Rockaway Beach Thronged Friday
Gettysburg Veteran Honored Brave Lieutenant's
Costly Pyrotechnic Display*

30 Point

4 A \$1 90 17 a \$3 60 \$5 50

*Magnificent Building
Briton Derided New Scheme
Stormy Weather*

18 Point

8 A \$1 70 24 a \$2 80 \$4 50

*Foreign Architect Explained
Condemns Another Big Steamship
Graduation Exercises
August Garden Musicale
Grand Opera*

24 Point

6 A \$1 90 20 a \$3 10 \$5 00

*Harpist Entertained Banjoist
Charming Singer Returned Today
California Resort
Hungry Soldiers Honored*

14 Point

8 A \$1 30 32 a \$2 45 \$3 75

*Confectioners Gathering Near Baltimore
Wyoming Mathematicians Received Diplomas
Philadelphia Spendthrift
Imported Porcelain Quickly Sold
Famous Singers
Unhealthy Communities*

Mrs. Harold Gay Buterwick

cordially invites you to attend a series of

Lectures on Physiognomy

to be held in the

East Room, Hotel Normandie

Tuesday and Friday evenings

Miss Justin Gray

Brooklyn, N. Y.

Dr. Robert Partridge

Office Hours

9 to 11:50 A. M.

578 Church Avenue

Exhibition of Oil Paintings

by the pupils of

Workman's Outdoor Art Class

of Wilder Heights, Rhode Island

Tuesday evening, September the eighteenth

Seven hundred and eleven

The pictures on view will be offered for sale after the exhibition is over

*Popular Writers
Invites Young. Nohleman*

*Beautiful. Maidens
Honoring English. Adventurer*

*Typographic Student Elated
Famous Emperor. Rewards. Philosopher
Attend Grand Opening*

*Yellowstone Park
California Lady Eloped
Job Printers*

*Many Exciting Contests
Visited the Rocky Mountains
Useful Faces
Letterpress Perfected*

*Wonderful Performer
Seven United States Marines
New York Fashions*

*Boy Mastered Print System
Musician Instructs Ambitious Friend
Journeying Eastward*

*Clever Inventor Solved Problem
Quiet Fearist Crossed the Lonesome Desert
Modern Equipment
Neat \$1234567890 Styles*

Mr. and Mrs. Nathaniel Richardson

*request the honor of your presence at the
marriage of their daughter*

Ethel Irene

to

Mr. George Davidson

on the afternoon of Wednesday, the sixth of May

at four thirty o'clock

at the First Baptist Church

Lowell

Mr. and Mrs. David Krainer

*At Home
after seventh of October*

*Seventy Church Place
Manhattan*

48 Point

3 A \$3 50 10 a \$4 00 \$7 50

Wedding Invitations Sent
European Stenographers Promoted

36 Point

4 A \$3 00 14 a \$3 50 \$6 50

Originated Famous American Styles
Detectives Climbing Adirondack Mountains
Artist Submits Quaint Drawing

30 Point

5 A \$2 35 18 a \$3 15 \$5 50

Specimen Book Contains Many Designs
Discriminating Customer Admired Beautiful Letter
Progressive Job Printers Rejoicing

24 Point No. 1

6 A \$2 15 21 a \$2 85 \$5 00

Generous Publisher Retires
Valuable Black Diamond Stolen
Lion Hunter Fired

18 Point

9 A \$1 80 35 a \$2 70 \$4 50

Discovered Hidden Treasure
Lighthouse Captain Signals Hero
Old Minstrel Stranded

24 Point No. 2

7 A \$2 20 26 a \$2 80 \$5 00

Questioned Popular Geographer
Music Teacher Invites Famous Earl
Huge Ocean Liners
Secretary Informs Citizen

14 Point

9 A \$1 40 44 a \$2 35 \$3 75

Independent Publishers Congratulated
Accomplished Pianist Entertained President
Surprised Aged Pedestrian

12 Point

10 A \$1 30 48 a \$2 20 \$3 50

Editors Condemn Sensational Story
Mexican Journalist Questioned Young Soldiers
Script \$1234567890 Characters

Tu Th P of h d r rs s o' . / : ;

These Special Characters accompany each font

The Uniontown
Association of Wise Philosophers

and legal fraternity of Fayette County
will celebrate Franklin Day January Seventeenth

You are cordially invited to be present

Klingsmeth's Millinery

at the Klingsmeth Store

on Tuesday Evening

The Season's Best Creations

You are urged to attend this Opening

and bring your friends

Special Musical Program

Beautiful Souvenir given

to Every Lady

You are Cordially Invited to
Attend the next

Musical

Given by the
Pupils of Carlton D. Wright
of Rocky Grove

Tuesday Evening

13 Evans Street

The Klingsmeth Millinery Store
125 Oakleaf Avenue

18 Point

3 A \$2 75 9 a \$4 75 \$7 50

*Engravers Bewildered
Printing Trade Revolutionized*

36 Point

4 A \$2 35 11 a \$4 25 \$6 60

*Buxom Lady Demonstrating
Spanish Matadors Injured at Phoenix
Young Neapolitan Actor*

30 Point

4 A \$1 90 13 a \$3 60 \$5 50

*Music Inspired Specimen Printer
Famous Orators Enthused Gotham Delegation
Tourist Becoming Fatigued*

24 Point No. 1

5 A \$1 80 16 a \$3 20 \$5 00

*Lonely Arkansas Desert
From Benton to Hot Springs
Miles of Dry Sand*

18 Point

7 A \$1 50 23 a \$3 00 \$4 50

*Author Surprised Producer
Boston Sailor Resumes Work
Prehistoric Dungeon*

24 Point No. 2

5 A \$1 65 19 a \$3 35 \$5 00

*Foreign Lieutenant Resigned
Fitchburg Damsel Advised Youth
Very Neat Script
Hospitable Old Gentlemen*

14 Point

8 A \$1 30 27 a \$2 45 \$3 75

*Prominent Nebraskan Speaks
Western Beauties Arrived Here Friday
Lengthy Monologue*

12 Point

9 A \$1 20 32 a \$2 30 \$3 50

*Rejuvenated Champion Defeated
South American Hunter Explored Jungles
Shrewd \$1234567890 Tailor*

The Tu rs r r sp o's . . .

These Special Characters accompany each font

Type Style

Name changed from Letter 41

Auditing Department

Johnstown Steel Company

Theodore Davenport, President

Long Distance Telephone

Cable Address Jostoko

Johnstown, Pennsylvania

Mr. Francis B. Howells

announces an Exhibition of

Hand Painted China

at his store in the Cummings Building

Franklin, Pennsylvania

Thursday, December Nineteenth

and continuing for ten days

You are invited, and are privileged to bring friends

Open Evenings until Ten o'clock

*The Collection is shown by
Courtesy of Mr. Kinner*

Mr. Stephen Carter

Seattle, Wash.

60 Point

3 A \$5 15 9 a \$4 85 \$10 00

Modern Delineator
Ruins Important Kingdom

48 Point

3 A \$3 60 10 a \$3 90 \$7 50

Beautiful Ornaments
Huntsmen Surprising Rhinoceros

36 Point

4 A \$3 00 13 a \$3 50 \$6 50

Using Ordinary Geography
Determined Compositor Ordering Material

30 Point

5 A \$2 60 16 a \$3 00 \$5 60

Elegant Conversation
Marvelous Light Shining

18 Point

9 A \$2 10 29 a \$2 40 \$4 50

Unitype Operator Engaged
Clever Detective Receives Visitor
Unfortunate Lieutenant

24 Point No. 1

7 A \$2 50 20 a \$2 50 \$5 00

Destructive Rain Storm
Explains Historical Researches

14 Point

11 A \$1 80 32 a \$1 95 \$3 75

Youngest Government Inspector
Graceful Bareback Rider Engaged Here
Marvelous Development

24 Point No. 2

8 A \$2 40 23 a \$2 60 \$5 00

Demanding American Type
Several Lighthouses Observed Today

12 Point

11 A \$1 45 45 a \$2 05 \$3 50

Energetic Salesman Rewarded Wednesday
Prosperous Merchants Reclaiming Government
These Figures \$1234567890 Shown

Exhibit of Rare China

Keeping in touch with the leading
makers enables us to exhibit
some Rare Pieces

Imported China is especially shown Wednesday
and you are most cordially invited
to attend the exhibit

Lichtenstein & Greenwood Co.
Eighteen Madison Avenue

Your Presence at our
Twelfth Annual Spring Millinery Opening
on Wednesday, April the Second,
will be appreciated

Lining Royal Script

48 Point

3 A \$4 65 6 a \$2 95 \$7 60

*Detaining Sailors
Bought Handsome Cloaks*

36 Point

4 A \$3 50 11 a \$3 00 \$6 50

*Originating Modern Script
Impersonated Northwestern Confectioners*

30 Point No. 551

4 A \$2 35 12 a \$3 80 \$6 15

*Duplicate Finest Manuscripts
Remarkable American Conception Pleased*

30 Point No. 552

4 A \$2 35 12 a \$3 40 \$5 75

*Earthquake Destroyed Buildings
Stagecoach Overturned Nearing Riverside Park*

24 Point No. 551

6 A \$2 35 18 a \$3 25 \$5 60

*Government Authority
Contestant Received Medals
Christmas Chime*

18 Point No. 551

7 A \$1 85 21 a \$2 95 \$4 80

*Nicer Typography
Produces Lovely Stationery
Praise Styles
Educated Students*

24 Point No. 552

6 A \$2 35 18 a \$3 10 \$5 45

*Legible Series Produced
Requires Honorable Gentlemen
Describe Machinery*

12 Point No. 551

9 A \$1 40 36 a \$2 65 \$4 05

*American Type Faces Pleasing
Reward Mercantile Printer
Purchase Lining Royal Script Faces
Modern Equipment
Clear \$1234567890 Decks*

Dining, Royal Script

Hackensburgh Automobile Club

*requests the honor of your company
at the*

Charity Ball

*to be given at Broadway Hall
on Wednesday evening, September the first
at eight thirty*

R. S. v. p.

The Secretary

The pleasure of your company is requested

at a birthday dinner to be given

in honor of

Miss Grace Burnside

on the evening of Saturday, the third of February

at half after seven

at North End Banquet Hall

Commercial Script

60 Point

3 A \$5 80 5 a \$4 20 \$10 00

*German Dukes
Imported Hardware*

48 Point

3 A \$4 40 5 a \$3 10 \$7 50

*Dreadful Explosions
Captured Mean Burglar*

36 Point

3 A \$2 90 10 a \$3 60 \$6 50

*Metropolitan Skyscraper
Oregonian Entertains Mechanic
Stranger Nominated*

30 Point

4 A \$2 65 10 a \$2 85 \$5 50

*Jovial Inspector
Michigan Farmers
Large Boats*

18 Point

6 A \$2 00 19 a \$2 50 \$4 50

*Nervous Publishers
Wise Japanese Painters
Fashion Paper*

14 Point

8 A \$1 75 23 a \$2 00 \$3 75

*International President
Dishonest Railroad Magnates
Scientific Exhibition*

24 Point

4 A \$2 05 14 a \$2 95 \$5 00

*Reward Young Hero
Question Clever Banker
Wild Ducks
Typical Britons*

12 Point

8 A \$1 40 32 a \$2 15 \$3 55

*Confectioner Injured Panther
Temperance Advocate Refuses Aid
Shrewd Financier
Quaint \$1234567890 House*

The Directors of the
Storrs National Bank
of Fairport, Pennsylvania

desire to inform you that the regular
semi-annual meeting of the
Board will be held
Wednesday Afternoon, May Seventh
in the office of the President
at three o'clock

Frank Musgood, Secretary

Modern Tailor Shop

An event of more than ordinary interest to business men in
this locality, as well as our regular patrons, is our showing
of Spring and Summer Styles. They are the latest from a
well-known house and promise much in both style and fit

Gus Overman, Manager

Young Steeple Script

30 Point No. 551

4 A \$2 05 12 a \$3 45 \$5 50

*Containing Steeple Script Bought
Has Remarkable Printing Qualities Observed
Interesting Demonstrations
Handsome Specimens Received*

24 Point No. 551

6 A \$2 25 18 a \$3 25 \$5 50

*Beautiful Resort Destroyed Wednesday Night
American Type Founders Company Original Borders
Complete Printing Plant Outfitter
Marvelous Production Received Praise*

Mrs. E. J. Brown

Mr. Frank S. Heiser

24 Point No. 552

6 A \$2 25 18 a \$2 75 \$5 00

*Elegant Visiting Cards Printed
American Typographical Ornament
Boston Wire Stitchers
Describe Natural Resources*

12 Point No. 550

8 A \$1 25 32 a \$2 75 \$4 00

*Brilliant Social Event Planned
Reliable Information
Famous Japanese Admiral Comes
Promote Government Employe
Handsome Gentlemen
Startling Elopement Failed
Use \$1234567890 Figure*

60 Point

3 A \$1 65 7 a \$5 55 \$10 20

*Handsome Designs
Exposing Important Features*

48 Point

3 A \$3 05 10 a \$4 55 \$7 60

*Prosperous Merchants
Finest Specimen Printing Delighted*

36 Point

8 A \$2 65 12 a \$3 85 \$6 50

*Wonderful Buildings. Remored
Purchasing Beautiful Lining American Script*

30 Point

5 A \$2 50 15 a \$3 60 \$6 10

*Remarkable Government
Shows Exquisite Characteristic
Useful Material*

18 Point

8 A \$1 95 24 a \$2 75 \$4 70

*Deductive Captains. Chief
Relicman. Discerning. Long. Clubs
Santlers. Retain
Composers. Resting*

24 Point

6 A \$2 20 18 a \$3 00 \$5 20

*Manuscripts Became Sealed
Charming Excursions Started Today
Complete Encyclopedia*

12 Point

9 A \$1 35 36 a \$2 45 \$3 80

*Archives. Culture. Young. Superintendent
Urban. Valuable. Luscious. Type
Modern American. Quarters. Dearest. Custom
Islands. Lesson
Leprosy \$125; 10, 1880. Legend*

60 Point

3 A \$6 05 6 a \$7 10 \$13 15

*Fine Weather
Composition Easy*

48 Point

3 A \$4 15 9 a \$6 00 \$10 15

*Hunting Pigeons
Draftsmen Wanted*

36 Point

4 A \$3 45 12 a \$4 65 \$8 10

*Treasure Island
Foreigners Entertained Californian
Presidential Possibilities*

24 Point

5 A \$2 40 15 a \$3 35 \$5 75

*Cash Customers Desirable
Reception Committee Receiving Congratulations
Temptations Successfully Resisted*

18 Point

7 A \$2 10 21 a \$2 75 \$4 85

*Orders for Printed Wedding Invitations Increased
Northern Speculators Imprisoned for Swindling Financial Operators
Numerous Having \$1234567890 Highwaymen Sentenced*

30 Point

1A \$2.00 12a \$8.00 26 11

Wonderful Encyclopedias Bought
This Beautiful American Character Procured
Elegant Manuscripts Desired

21 Point

5A \$2.25 15a \$2.75 \$5.00

Contains Handsome Features Throughout
Striking Originality Seen in University Script Designs
Graceful Athletes Returned
Desirable Series Purchased Monday

Mrs. C. B. Smith

Mr. Horace Flower

18 Point

7A \$2.00 21a \$2.55 \$4.55

14 Point

8A \$1.95 24a \$2.10 \$4.05

Prosperous Merchants Returning
Large Warships Enters Newport Harbor
Remarkable Demonstrations
Strongest Lighthouse
Highest Buildings Completed

Superior American Type Faces
Educated Superintendent
Older Historical Description Printed
Show Ancient Maps
Baroque Chorus Girls Hired
Ten \$1234567890 Men

(c) (C) H Th Mh . H² M²

60 Point

3 A \$5 85 4 a \$2 95 \$8 80

Destroyed Building

48 Point

4 A \$4 40 8 a \$3 50 \$7 90

*Artistic Printer
Experienced Blacksmith*

36 Point

4 A \$2 70 9 a \$2 50 \$5 20

*Reward Policeman
Using Fancy Livermore Series*

30 Point

4 A \$2 00 12 a \$2 30 \$4 30

*Large Church
Handsome Pianola*

12 Point

13 A \$1 20 40 a \$1 55 \$2 75

*Wealthy Farmers Retiring
Competent Workmen are Demanded
Fireman Received Medal
Female Detectives
Lost \$1234567890 Monday*

24 Point

5 A \$1 65 15 a \$1 85 \$3 50

*Cleverly Executed
Hoboken Count Missing
Ice Cold Soda*

10 Point

14 A \$1 15 41 a \$1 35 \$2 50

*Reproducing Art Pictures
Bold Intruders Discovered in Mansion
United States Senators Returning
Lincoln Square Hotel
Electrician Wiring North Pole
Election Primaries Held*

18 Point

8 A \$1 50 24 a \$1 75 \$3 25

*Washington Square Arch
Daring Burglar Escaped Friday
Congress Adjourned
Great English Soprano Here*

8 Point

13 A \$1 00 41 a \$1 25 \$2 25

*Bachelor Club Entertains Ladies
Displays Great Courage
Honoring Spanish-American War Heroes
United States Naval Parade
Amateur Runner Turns Professional
Wonderful Dancer
Compositors Improved Greatly*

*Banknotes Quickly Engraved
Exquisite Drawings
Modern Commercial Printing*

*Handsome Birthday Present. Unlaid
Regularity. Maintained
Pleasing Effects in Original Designing*

*Delightful Summer Resorts Visited by Society Ladies
Producing Superior Workmanship
Unusual Interest Recently Taken in Foreign Matters*

*Very Appropriate and Serviceable for General Commercial Printing
Favorite Script for Legal Documents
Strange Parties Departing for Unexplored Fields
Beautiful Suburban Residences Entirely Destroyed by Fierce Storm*

*This Excellent Series of Script Type Adds Dignity to Modern Printing Establishments
Quaint Historical Books Frequently Read at Literary Gatherings
Young Students Produced Numerous Specimens of Original Anglo-Saxon Handwriting
Remarkable \$1234567890 Characteristics*

Announcement

IN DOING IMITATION TYPEWRITER PRINTING,
THE FOLLOWING DIRECTIONS SHOULD
BE STRICTLY ADHERED TO:

1. *Always* wash your type-ribbons with soap and water before using.
2. Have the press and all its parts *immaculately clean*.
3. Have new rollers for each color and use them for that color *only*.
4. A good fountain is *necessary*.
5. *Always* secure your shade before starting to run job, using typewriter color sheet.
6. Be careful to run job *evenly*.
7. *Do not* try to get match by mixing inks. Get special ribbons.
8. Train your stenographers as to correct touch. *Do not let them get careless*.



Typewriter Faces

*For Silk
and
Plain Printing*

Typewriter faces should be selected to match the work of the typewriting machines used in adding addresses, etc. Small typewriter faces are made to enable advertisers to reprint seeming reproductions in facsimile of real typewritten letters. The following collection of Typewriter faces is the best and by far the most complete manufactured.



American Type Founders Company

AMERICAN TYPE FOUNDERS COMPANY

ORIGINATOR OF ARTISTIC EMBELLISHMENTS FOR THE

PRINTING ART

To the Printer of Judgment,
In Any Country.

Dear Sir:-

With the increased amount of attention that is being given to the subject of printing costs, comes the realization that while the cost is not, by any means, the entire expense of doing work, it is still a most important item. At least one-third of every printer's time is non-productive. This is a larger percentage of waste time, a larger percentage than will be found in most manufacturing businesses. Of course, some of this unproductive time is legitimate and unavoidable--necessary because of the business. But to anyone who studies actual shop practice carefully it becomes evident that some, at least, of this unproductive time could be put to more actual use. Perhaps the most obvious cause of wasted time is the search, and often the futile search, for enough material and sorts to complete work in hand. Some of this time is charged into the time spent in doing the job and is paid for by the customer; much of it comes under the head of unproductive time, and helps to increase the expense of doing the work to the employer. However, it figures in the time checks and it lessens the productive capacity of the office. Now it is always because of unwillingness on the part of the management to buy sufficient supplies.

Take an example: A job comes into an office well supplied, perhaps, with sufficient job type for any ordinary work. The press runs heavily on some particular face, or some special work. Working time is limited. The foreman may not see the wisdom of having additional type for just one job. He may be too busy or he may have other matters to give the problem careful consideration, and, in fact, much of any consideration. So the copy is headed up, and the plates that comes are empty is too often met with the order to look for sorts, or to turn for letters. Now a man can easily spend two or three hours a day of the firm's time in the search for sorts and at the end of that time be unsuccessful. An eighteen-dollar man, for instance, whose time, taking all things into consideration, is worth a dollar an hour to his employer, may spend two or three dollars' worth of time in the futile search for sorts, when the entire supply could have been secured at the type foundry at slight cost. It would have been money saved to buy the type and throw it away at the completion of the job. Every printer should realize that looking for sorts is an item of expense beside which type bills are almost nothing.

NEW MODEL ELITE REMINGTON

The following characters are furnished with each complete font:

a b c d e f g h i j k l m n o p q r s t u
v w x y z A B C D E F G H I J K L M N O P
Q R S T U V W X Y Z 1 2 3 4 5 6 7 8 9 0 \$
& % ¢ # * @ / - () . , ; - ' ' " ! :

NEW MODEL ELITE REMINGTON

(Printed through silk)

10 Point 20 A \$1 35 100 a \$4 15 \$5 50

Justifiers in 1 and 5 pound fonts 56 cents per pound

AMERICAN TYPE FOUNDERS COMPANY

MAKER OF BEAUTIFUL DESIGNS IN

TYPE

BORDERS AND ORNAMENTS

To Mr. Hostling Printer,

Located Anywhere.

Dear Sir:

Imitation typewritten letters have found a permanent place in the industrial system of to-day. To a large extent this has been brought about through the facilities for such work offered by the American Type Founders Company. Not only does this Company furnish type cut accurately to match the characters used on various styles of typewriting machines, but it also furnishes the process inks and typewriter ribbons to match. Every printer with business instinct is prepared to take orders for this class of work. Many offices have found the production of imitation typewritten letters very profitable and have developed what has proved an almost independent business along this line.

This new face, 12 Point Silk Remington, is designed to be printed through silk, crepe chiffon or regular ribbon cloth. By varying the quality and amount of cloth used an impression of any weight and character may be obtained. The ribbon cloth is heaviest, and gives most weight to type face. Crepe chiffon is lightest.

If the addresses are to be filled in on a typewriter have the stenographer of the firm for whom the work is being done write a sample letter. Use this as a color sheet and have the pressman work to it, for the depth of the color and the weight of the impression may easily be controlled on the press, while it is impossible to do this on the typewriter.

You then have the assurance that the ink used in printing will exactly match the ribbon used on the typewriter for filling in the address. The result is sure to be satisfactory to the customer.

SILK REMINGTON TYPEWRITER

The following characters are furnished with each complete font, except the fractions, which are fonted and priced separately:

a	b	c	d	e	f	g	h	i	j	k	l	m	n	o	p	q	r	s
t	u	v	w	x	y	z	A	B	C	D	E	F	G	H	I	J	K	L
M	N	O	P	Q	R	S	T	U	V	W	X	Y	Z	1	2	3	4	5
6	7	8	9	0	\$	&	¢	%	/	@	#	()	.	,	:	;	-
—	'	"	!	?	*	$\frac{1}{4}$	$\frac{1}{2}$	$\frac{3}{4}$	$\frac{1}{8}$	$\frac{3}{8}$	$\frac{5}{8}$	$\frac{7}{8}$						

SILK REMINGTON TYPEWRITER

(Printed through silk)

12 Point 20 A \$1 85 100 a \$5 50 \$7 35

Fractions 75c. per font

Justifiers in 1 and 5 pound fonts 52 cents per pound

Special high period, comma, colon, semi-colon and apostrophe furnished to order

American Type Founders Company

Originator and Maker of All the Latest and Most Artistic Fashions in

Printing Type

Mr. Printer,
Typewriterman.

Dear Sir:-

The work of the typewriter, which was formerly closely imitated by using our 12 Point New Model Remington Typewriter. There are hundreds of job printers printing constantly on this typewriter work in the large cities. The rapid increase in the mail order business and use of follow-up systems has created an enormous demand for this work, and no hustling printer can afford to overlook this avenue for profit.

This is our New Model Remington printed through silk. All American Typewriter faces are made from all-furnished by the makers of typewriters and they duplicate typewritten work. If you wish to match the work of any typewriter not mentioned here, send us a sample and we can undoubtedly furnish the type you want.

As the productions of the American Type Founders Company are the admitted standard of excellence throughout the world, due regard for the reputation of its own productions will not permit it to recommend anything that is not the best procurable in its class.

In the line of type faces to enable the printer to handle orders for imitation typewritten letters, the American Type Founders Company is the acknowledged leader. In this American Book of Type Styles will be found specimens of type faces, which absolutely match the work of the leading makes of typewriting machines. A specialty has also been made of Reproducing Typewriter Faces, to meet the constantly increasing demand for fac-simile letters in reduced size. Any printer can now successfully print "fac-simile" typewriter circulars in unlimited numbers, easily, quickly and with profit.

NEW MODEL REMINGTON

The following characters are furnished with each complete font, except the fractions, which are fonted and priced separately:

a	b	c	d	e	f	g	h	i	j	k	l	m	n	o	p	q	r	s
t	u	v	w	x	y	z	A	B	C	D	E	F	G	H	I	J	K	L
M	N	O	P	Q	R	S	T	U	V	W	X	Y	Z	1	2	3	4	5
6	7	8	9	0	\$	&	¢	%	/	@	#	()	.	,	:	;	-
-	'	'	"	!	?	*	$\frac{1}{4}$	$\frac{1}{2}$	$\frac{3}{4}$	$\frac{1}{8}$	$\frac{3}{8}$	$\frac{5}{8}$	$\frac{7}{8}$					

NEW MODEL REMINGTON

(Printed through silk)

12 Point 20 A \$1 85 100 a \$5 50 \$7 35

Fractions 75c. per font

Justifiers in 1 and 5 pound fonts 52 cents per pound

American Type Founders Company

ORIGINATOR AND MAKER OF ALL THAT IS ARTISTIC AND BEAUTIFUL IN

Borders **TYPE** Ornaments

... of a sentiment
 ... with little desire for
 ... so closely
 ... of mankind, it perforce must
 ... and duty! And a number of the
 ... of this old idea. While
 ... the effect has been to retard
 ... than to develop the greatest of all agencies for
 ... education of the people. If growth is to come in any
 ... the man engaged in it must be fitted for their
 ... Their reward should be sufficient to give time for
 ... and research, for investigation and experiment. Just
 ... poverty is the implacable enemy of the social up-lift,
 ... it the most formidable foe to business development.
 ... nowadays, with free libraries and the dissemination
 ... of well printed literature, poverty can not stand in the
 ... of self-culture.

A study of the beautiful "print pictures" that can be
 ... from a thorough acquaintance with the latest up-to-
 ... American Type Faces and an intelligent use of their
 ... many delightfully pleasing combinations, will well repay
 ... any printer. The type books of the type founders are in
 ... themselves an education in the high arts of printing.

Your customers can be induced to order a vastly in-
 ... creased amount of printing if you show them how they can
 ... increase their trade by having you furnish them with up-
 ... to-date styles in printing.

The experiment is worth your trial: it will pay you a
 ... percent, on your investment—many times the legal
 ... rate. Your interest is your interest, and your interest
 ... our interest. If you order some of our latest type,
 ... and ornaments, you will get profitable results.

NEW MODEL REMINGTON No. 3

The following characters are furnished with each complete font:

a b c d e f g h i j k l m n o p q r s t
 u v w x y z A B C D E F G H I J K L M N
 O P Q R S T U V W X Y Z 1 2 3 4 5 6 7 8
 9 0 \$ & % / # () . , : ; - ' " ! ?

NEW MODEL REMINGTON No. 3

(Printed through silk)

12 Point 20 A \$1 65 100 a \$4 95 \$6 60

Justifiers in 1 and 5 pound fonts 52 cents per pound

American Type Founders Company

THE EMPORIUM OF THE PRINTING INDUSTRY FOR

TYPE

Borders and Ornaments

To the Progressive Printer,

Everywhere.

Dear Sir:-

This new face of 10 Point Elite Oliver typewriter reproduction of the work done on the Oliver Machine, and we therefore commend itself to the printer who requires a high quality imitation typewritten letters requiring this particular face.

There is a constantly increasing demand for the printing imitation typewritten letters, and in all the leading cities, progressive printers are taking advantage of the opportunity and are increasing their facilities for doing this work.

This face can be used in the production of imitation typewritten letters by the process of printing through silk. This can best be done by printing through crepe cloth stretched on the grippers, leaving the cloth a little slack, and using process ink. This method will give most satisfactory results when used on a platen press.

When on a cylinder press, use Japanese ink of good quality, but light in weight. Lock up the silk loosely in the form, between the type and the furniture; draw several impressions from double thicknesses of stock to be used on the job, forming a matrix on the cloth.

At all times have cloth washed thoroughly with soap and water before using. Use CLEAN rollers and bearers. Use typewriter ribbons that have been saturated with the same ink for filling in the names and addresses. We furnish the regular process ink and the typewriter ribbons to match for this work. In using these materials you have the assurance that the ink used in printing will match the ribbon used on the typewriter to fill in the addresses.

Distribute the process ink on the plate as usual, then put in form. The first few rollings will saturate the silk with ink and it will act as an inked ribbon, giving an impression like that of a typewriting machine. The silk will last a long time and when filled up can be washed in benzine and used again.

Ten Point Elite Oliver may be obtained from the nearest selling house of the American Type Founders Company. Printers are invited to study the merits and possibilities of this face--a most desirable size for the fac-simile letters needed by professional men, clubs, libraries, and similar sources of new customers.

ELITE OLIVER TYPEWRITER

The following characters are furnished with each complete font:

a b c d e f g h i j k l m n o p q r s
t u v w x y z A B C D E F G H I J K L
M N O P Q R S T U V W X Y Z 1 2 3 4 5
6 7 8 9 0 \$ & % / @ # () . , : ; -
_ ' " ! ? * = ^

ELITE OLIVER TYPEWRITER

(Printed through silk)

• 10 Point 9A \$0 75 32a \$1 75 \$2 50

Justifiers in 1 and 5 pound fonts 56 cents per pound

Special high period, comma and underscore furnished to order

American Type Founders Company

The World's Largest Furnisher of

Borders and
Ornaments

TYPE

Brass Rule and
Wood Goods

TO THE MASTER PRINTER,
In Every Country.

Dear Sir:-

Imitation typewritten letters are the most profitable specialty open to the Job Printer. They can be turned out as fast as any job press will run. Your customers need them, and if you can not do the work, will purchase elsewhere. You must have special ink and type adapted for this work, then a few cents for silk completes the outfit.

Our Process Inks and Typewriter Ribbons exactly match. We guarantee them. It is a waste of time to try and match a customer's ribbon. Print the job and send the ribbon with it.

Our ribbons and process inks are used by the largest concerns. Write us for complete instructions for this work.

Typewriting ink will not dry or harden, so the press needs no washing from day to day. The particular kind of cloth used is not important. The crepe chiffon, China or Japanese silk or regular ribbon cloth are used. The ribbon cloth is heaviest and gives most weight to the type face. Crepe chiffon is the lightest. China silk is usually used. The work is done on linen or hard finish paper. By varying the cloth from crepe chiffon through China silk up to the ribbon cloth, the operator can get any desired weight of face. In other words, our New Model type will print very light with chiffon, moderately light with China silk, and will give a heavy blurred impression with the ribbon cloth.

Any printer can now successfully print "fac-simile" typewriter circulars in unlimited numbers, easily and quickly--with profit.

OLIVER TYPEWRITER

The following characters are furnished with each complete font:

a b c d e f g h i j k l m n o p q r s
t u v w x y z A B C D E F G H I J K L
M N O P Q R S T U V W X Y Z 1 2 3 4 5
6 7 8 9 0 \$ & ¢ % / @ # = ^ () . , :
; - _ ' " ! ? *

OLIVER TYPEWRITER

(Printed through silk)

12 Point 9 A \$0 95 32 a \$1 80 \$2 75

Justifiers in 1 and 5 pound fonts 52 cents per pound

American Type Founders Company

THE LARGEST AND MOST PROGRESSIVE

Type Maker and Printers' Outfitter

1 THE WILL-AWAY-PRINTERS.

Everywhere.

Dear Sir:-

Get on top of your business. It is not at the top of you. A great many of us are kept busy enough not to have time to expand. They are so busy with ourselves that we can not find time to do the important things. Our business becomes a job to make a living by it, but there is little if any profit in conducting it. We are always "up against it" then we should be on top of it, expanding our business.

Perhaps we are located in a small town, and when we come we filled a "long felt want." A certain part of the community needed our services, that was our foundation. Are we building on it by expanding into that have not been felt? This is the edge of our business. To realize this fact, and act upon it, is the important step towards a larger success.

If you have no time to operate your printing business, your business, as a rule, is not a big one. If you are not getting out of it all it is worth in it for you. Therefore, take time to study your business problem. There is no need to hurry, but do it quickly, thoughtfully, but some will persistently. There will be better to hire some one to help you. Do not disdain the help of a sign printer, but get him to you with the sign he printed better than you can do it. Possibly you are a better printer than you think, if so hire a little of the time, then you will be able to continue the business, and all the while that they are neglecting a lot of your business, and your printing facilities.

NEW MODEL SMITH-PREMIER

The following characters are furnished with each complete font:

a b c d e f g h i j k l m n o p q r s
t u v w x y z A B C D E F G H I J K L
M N O P Q R S T U V W X Y Z 1 2 3 4 5
6 7 8 9 0 \$ & % / # () . : ; - ' " ?

NEW MODEL SMITH-PREMIER
(Printed through silk)

12 Point 20 A \$1 85 100 a \$5 50 \$7 35

Justifiers in 1 and 5 pound fonts 52 cents per pound

American Type Founders Company

DESIGNER OF TRADE-COMPELLING

Type, Borders and Ornaments

The art of printing in America has improved wonderfully. Beneath this, so well known, is the manufacture of the printers. It is a business steadily rising in public estimation, and it is more and more coming to be recognized as the keystone of commerce and manufacturers. If the printing presses for three months and a day would stagnate, this knowledge of the printing power of printed advertising should be un-erringly propagated by the printers. Their motto to the public should always be: "There is nothing so valuable to stimulate trade as printing." On the other hand, the printers require more to know themselves that that motto is true. Let each cultivate a high appreciation of the value of his product to his customers. The printer is not always selling paper smeared with ink. When he is selling the breath of life to his customer's business. Consider the big advertising. He is told that they are sold to the advertiser at the cost of production, or less, and that the advertisers pay the profits. The publisher bases their charges to the advertisers on the cost of printing and editing. They base their charges on a large degree on the value of the advertising and the returns the advertisers get from it. Whenever possible, the printer should use the advertiser's value for estimating the value of his product. It is to be expected that all printers can secure a position where they may secure what may be called a professional profit, as distinct from a mechanical profit, but many are doing it.

NEW MODEL SMITH-PREMIER No. 3

The following characters are furnished with each complete font:

a	b	c	d	e	f	g	h	i	j	k	l	m	n	o	p	q	r	s
t	u	v	w	x	y	z	A	B	C	D	E	F	G	H	I	J	K	L
M	N	O	P	Q	R	S	T	U	V	W	X	Y	Z	1	2	3	4	5
6	7	8	9	0	\$	&	¢	%	/	#	()	.	,	:	;	-	—
'	"	!	?															

NEW MODEL SMITH-PREMIER No. 3

(Printed through silk)

12 Point 16 A \$1 70 80 a \$4 85 \$6 55

Justifiers in 1 and 5 pound fonts 52 cents per pound

American Type Founders Company

THE WORLD'S LEADING AND MOST PROGRESSIVE DEALER IN

Printing Material

... to write, ...
...-existing machine-making ...
... What are they? ...
... know that every printer is ...
... to make money. ...
... types many dollars of profit ...
... pay the profit, but may pay ...
... thousands of profits. There is still another really
pleasant reflection. Almost all the printing done with
these types is immensely profitable to the printers'—
customers, extending their trade, widening their
profits, and enlarging their business world.

Really, now, is there anything more ...
quite as wonderful as types? They bridge the space
between mankind's thoughts and mankind's need. These
little metal things are the messengers of thought. They
are, you know, the most important things in a printing
office, at once the root and the fruit of the business.

Nevertheless, there are printers and are concerned
in the selection of their types, buying inferior ...
type instead of the real vitalizing thing ...
You should be studious and critical when you buy these
wonder workers. We say this, deliberately ...
the more you study and think about types, and the more
critical you become, the more difficult it will ...
you to get along with an American Type—the best type.

As the productions of the American Type Founders
Company are the admitted standard of excellence throughout
the world, due regard for the reputation of its own
productions will not permit it to concern itself with
that is not the best procedure in the world.

NEW MODEL UNDERWOOD TYPEWRITER

The following characters are furnished with each complete font:

a	b	c	d	e	f	g	h	i	j	k	l	m	n	o	p	q	r	s
t	u	v	w	x	y	z	A	B	C	D	E	F	G	H	I	J	K	L
M	N	O	P	Q	R	S	T	U	V	W	X	Y	Z	1	2	3	4	5
6	7	8	9	0	\$	&	#	°	%	¢	/	@	-	*	()	.	,
:	;	-	'	!	"	!	?											

NEW MODEL UNDERWOOD TYPEWRITER

(Printed through silk)

12 Point 20 A \$1 85 100 a \$5 50 \$7 35

Justifiers in 1 and 5 pound fonts 52 cents per pound

AMERICAN TYPE FOUNDERS COMPANY

ORIGINATOR OF STYLISH

Type, Borders and Ornaments

TO THE PRINTING SPECIALISTS,
Found Everywhere.

Dear Sir:-

A youth once had an aged, affluent, wealthy uncle, who died and left said youth with several cart-loads of coin. Up to the time of the aged one's demise the youth had known naught of the family's wealth, nor, in fact, of any relatives closer than an uncle who periodically let him have the price of a meal, providing collateral was deposited.

Heretofore, the youth had wrung from the world the price of two or three meals a day and a place to sleep by various and sundry methods. In the summertime he was usually to be found outside a "inselled palace at a summer resort, explaining in raucous tones to the passing multitudes the wonders of the show inside, dilating vigorously upon the educational value of the exhibit and talking with persuasive power. One summer he took the role of actor; he was Cupid, strapped to a wheel of fortune in a show labeled "A Trip Through Purgatory."

At any rate he was usually at the same resort in some capacity.

The winter months found him, as a rule, selling baking powder, books or patent lamp wicks from door to door--house to house canvassing they call it.

And then the aged, affluent uncle died.

The youth had notions of the fitness of things. He felt that he must live up to the responsibilities thrust upon him. No gilded-youth business in his! The only course left open to him, as he saw things, was to go into business, some legitimate, dignified business that would harmonize with his bank account.

He looked about him and presently he said, "Ah!" just like that. He said, "Ah! I have it!"

He hired an office. It was a nice, perfectly good office, with a soft, springy rug on the floor and a set of dignified mission furniture scattered about. It had a door with a frosted glass window leading out into the hall of a great office building. A sign painter came and emblazoned the youth's name on the frosted glass, and underneath was inscribed, in letters of no modest proportions--ADVERTISING SPECIALIST.

The youth did not know the difference between a half-tone and an engraved calling card; to him Chaucer Text and Century Expanded looked alike; he had never written anything but an I O U or two; he knew that the blood was accused of circulation, but he couldn't imagine that the word had any application to publications; he was firmly convinced that all mediums were spiritualists.

He hired a stenographer and showed up regularly at the office. Once or twice some one did open the door and come in to see him. But two minutes and a half of conversation were sufficient to convince those with money to spend that it was no place for anyone but the youth and stenographer.

Now this is not a treatise on advertising, but the apparent lesson from this youth, who is still paying office rent, telephone charges, light bills, stationery bills (although these are not large), stenographer's salary and all such numerous incidental expenses, and all from the wealth of the late aged uncle, may be applied for the benefit of the printer-man.

Tacking up a sign on a doorway, or on the end of a desk, does not make a man a specialist.

A specialist, as we are told, is one who devotes himself to some specialty, and a specialty is "that for which a person is specially distinguished."

A man never becomes specially distinguished for anything unless he has demonstrated superiority along the line for which he claims to be a specialist. And this means not only an intimacy with the specialty but a knowledge of other branches as well. Perspective is a large asset to the specialist. A pain in the head may originate from a cold in the feet, and a head specialist who did not know this would not be a specialist--he'd probably be called a grafter or a quack.

There is a place in the printing business for specialization, just as there is in every other line, but such places are reached by other methods than tacking a sign on the door. They are reached after the same manner that a specialist in any branch reaches his goal, by the pathway of unstinted study and thought, and by practice and unlimited observation of kindred subjects.

The specialist-printer is a man who knows and appreciates the opportunities of one particular branch of the printing art above all others. That is not saying, by any means, that he does not know a great deal about other branches. It is necessary that he should. Just as the inspiration for a mural frieze may come from an intelligent appreciation of a pastel sketch, so may an idea for a booklet cover come from the composition of a newspaper advertisement. Things are co-related always.

The specialist-printer grows into his specialty. In a sense he does not make himself a specialist; the people to whom his work is attractive make him one. A man may say on embarking in the printing business, "I'm going to be a specialist on automobile catalogues." But simply saying so does not make him a specialist. If he went about forever and ever with a megaphone, remarking in calliophonic tones, "I am a specialist on auto catalogues!" it wouldn't make him a specialist. The public would look on and say quietly, tersely, and meaningly, "Show us!"

But if the same man went to work to study the methods of printing that might be applicable to automobile catalogues, received a contract for such a job, did it well, and on the strength of its attractiveness received another contract, into which he put much thought and originality; if he did all work of such a nature better than others could do it, because he had given the subject much more thought, there would be a demand for his services on that class of work, and people would call him a specialist. If he should care to, then, he might tack a sign up on his door announcing that he made a specialty of the preparation of auto catalogues.

It is, however, seldom advisable to limit one's self entirely to one's specialty, even though much money may be made in that way. If a man does this he is quite likely to become set in his methods and lose that breadth of view that enhances work of any nature. As remarked before, perspective is an asset for the specialist, and the printer-specialist obtains a sense of perspective from a study of printing as a whole rather than from a concentrated study of a segment of the matter.

AMERICAN TYPEWRITER

The following characters are furnished with each complete font:

a b c d e f g h i j k l m n o p q r s t u v w x y z
A B C D E F G H I J K L M N O P Q R S T U V W X Y Z
1 2 3 4 5 6 7 8 9 0 \$ % & ' / @ # () . : ; -
' " ! ? * + - = > < & # % & #

AMERICAN TYPEWRITER

6 Point 28 A \$1 15 85 a \$2 35 \$3 50

Justifiers in 1 and 5 pound fonts 79 cents per pound

AMERICAN TYPE FOUNDERS COMPANY

CREATOR OF DECORATIVE FEATURES AND
TYPE FAMILIES

TO THE MASTER PRINTER.

In Any Country.

Dear Sir:—

At a meeting of the Typothetae, one of the members, in referring to hand composition, said: "Every one of you has been taught, since entering a printing office, that hand composition is a sink-hole, that the composing room is simply an adjunct, which you are compelled to carry in order to feed the large pressroom. How many of you have heard that statement before? How many of you, who were smaller and wanted to grow larger, only prayed for the day when you could have cylinder presses and make some real money? I want to tell you, that for the last twelve months, my composing room made a profit every month except two, and that was close, and I want to tell you that my large cylinder room of ten cylinder presses, running all of them but two 56-inch, showed a profit only during three months of the twelve. Your composing room today, I venture the assertion from my cost system experience of three years, is the more profitable of the two departments.

"I want to tell you that my experience is that the most profitable machinery I have in my place is the platen press, always. The next one is the job cylinder press. I have it divided in that way. Those two departments have never failed since we had a cost department, in three years, in showing a profit. Now, think of it! For only twenty-five per cent of the time last year did the large cylinder room show a profit, and the first year I had a cost system it did not show a profit one month. Why? Because this cost system puts upon the large cylinder pressroom the investment, the amount of money which I have in those big presses and in the automatic feeders and in the blocks and the chases, which I lost sight of. We don't charge enough. I don't know when we can get up to the point, but we must. The investment in the average man's cylinder pressroom is sometimes, yes, usually, fifty per cent of the total investment that he has in his business, and then he only figures it on a pro rata worked out on some guesswork of percentage, when the truth is that it is the sink-hole of his business."

Printers should give consideration to this statement about composing room profits, realize that it was brought out by actual business records and not hearsay or guesswork. If you are a master printer, look into conditions in your own plant, consider the comparatively small composing room investment: credit this department with all its actual accomplishments, and don't burden it with charges that belong to other departments, thus making out of it the sink-hole above referred to.

AMERICAN TYPEWRITER

The following characters are furnished with each complete font:

a b c d e f g h i j k l m n o p q r s t u v w x y z
A B C D E F G H I J K L M N O P Q R S T U V W X Y Z
1 2 3 4 5 6 7 8 9 0 \$ £ # % / @ () . , : ; - ' " !
? *

AMERICAN TYPEWRITER

(Cast on Original Line)

10 Point 20 A \$1 35 100 a \$4 15 \$5 50

Justifiers in 1 and 5 pound fonts 56 cents per pound

AMERICAN TYPE FOUNDERS COMPANY

PRODUCER OF DISTINCTIVE AND EXQUISITE DESIGNS IN

TYPE BORDERS AND ORNAMENTS

TO WHOM IT MAY CONCERN:

In examining any large quantity of job printing, one cannot help being impressed at the widespread influence that the type founders exert through the medium of their specimen sheets. The forthcoming style in typography can be forecasted as accurately by means of these specimen sheets as the new styles of clothing are predetermined by the fashion plates of the London or the Paris tailors. The whole history of job composition may be studied by turning the leaves of the old specimen books. It is encouraging to note the improvement that is shown in these sheets one cannot help but feel that the type founders are not only leaders in type fashions and styles of composition, but that their influence is ever in the direction of better and more effective work. One of the latest improvements and greatest services that they have rendered the printer is in the creation of type families the production of type faces in closely related series and faces.

Of course the object of the founders in issuing specimen sheets is not entirely disinterested. These displays exert a strong educational influence, but their object, primarily, is to induce the printer to purchase new supplies in type series, ornaments and borders. In the production of their specimen sheets the type founders employ some of the best talent in the country, so that it is, perhaps, not surprising that the results are well worth preserving for their educational value. It might be said here, that while specimen books are almost as old as is type founding itself, the idea of introducing into their pages specimens of jobs, set in the series advertised, is comparatively new. It is an extremely valuable feature, and one that seems capable of still further expansion.

Of course it is good business policy for the type founders to exploit new type faces, and equally of course it is good policy for the job printer to buy these new job faces, for many are the customers, and good ones, too, whose demand is for something new and original. A great deal may be accomplished by a thoroughly competent compositor, with only a few faces of type at his command, but there is a distinct stimulus in a new series of type. On the whole, nothing gingers up the work of a shop like a new series, especially now when type faces are issued in related families, and it is possible to add a new series that will harmonize with the rest of the faces in the shop, merely adding to their usefulness, and detracting in no way from the distinctive character of the shop's output. A new series is an inspiration to the compositor and an attractive offering to

REPRODUCING TYPEWRITER

The following characters are furnished with each complete font:

a	b	c	d	e	f	g	h	i	j	k	l	m	n	o	p	q	r	s	t	u	v	w	x	y	z
A	B	C	D	E	F	G	H	I	J	K	L	M	N	O	P	Q	R	S	T	U	V	W	X	Y	Z
1	2	3	4	5	6	7	8	9	0	\$	&	#	%	-	/	.	:	;	-	'	"	!	?		

REPRODUCING TYPEWRITER

6 Point 20 A \$1 15 78a \$2 35 \$3 50

Justifiers in 1 and 5 pound fonts 79 cents per pound

TO THE PRINTERS OF THE FUTURE,
IN ALL COUNTRIES.

DEAR SIR:-

Once upon a time, not so long ago, the apprentice lived with his master or employer until he became a journeyman; and it frequently came about that a likely lively apprentice would marry his master's daughter, and, in time, become master himself. When they had found those to whom, if Dan Cupid so decreed, they would be willing to marry their daughters, they were just the lads who would do honor to their calling.

Perhaps those ancient printers were loath to introduce into their printing offices any who would not honor the typographic calling; but it seems that in our more "enlightened" age, the average master printer is careless of the qualifications and qualities of the lads now entering the printing trade. In a school of printing, the pupils of which are procured from printing offices, under an agreement by which they first work a short time in a printing office (presumably to ascertain their fitness), and are then sent to school, it was depressing to find that the first task of the able and conscientious instructor was to teach those strapping lads how to spell easy words! Some of the best printing plants in that city were deliberately hiring and entering into apprenticeship agreements with semi-illiterates. Shades of Franklin and Greeley!

The lads of fifteen or sixteen who have not had sufficient ambition to learn how to spell passably well have thereby advertised their unsuitableness to enter our semi-literary art-craft: if it is less than semi-literary or less than an art-craft it is because so many ignorant, unteachable people have been allowed

REPRODUCING TYPEWRITER

The following characters are furnished with each complete font

a	b	c	d	e	f	g	h	i	j	k	l	m	n	o	p	q	r	s	t	u	v	w	x	y	z	A
B	C	D	E	F	G	H	I	J	K	L	M	N	O	P	Q	R	S	T	U	V	W	X	Y	Z	1	2
3	4	5	6	7	8	9	0	\$	&	#	%	-	/	()	.	:	;	-	'	"	!	?			

REPRODUCING TYPEWRITER

8 Point 18 A \$1 15 65a \$2 35 \$3 50

Justifiers in 1 and 5 pound fonts 64 cents per pound

American Type Founders Company

Designer and Maker of
Type, Borders and Ornaments
 Everything for the Printer

THE NEW MASTER PRINTER

The new Master Printer... (The following text is extremely faint and largely illegible due to low contrast and blurring in the original image. It appears to be a descriptive paragraph about a printing machine or process.)

REPRODUCING TYPEWRITER

The following characters are furnished with each complete font :

a b c d e f g h i j k l m n o p q r s t u
 v w x y z A B C D E F G H I J K L M N O P
 Q R S T U V W X Y Z 1 2 3 4 5 6 7 8 9 0 \$
 & # % ^ _ / () . , : ; - ' " ' ! ?

REPRODUCING TYPEWRITER
 10 Point 15 A \$1 20 52 a \$2 30 \$3 50

Justifiers in 1 and 5 pound fonts 56 cents per pound

AMERICAN TYPE FOUNDERS COMPANY

MAKER OF

TYPEWRITER TYPE

BORDERS AND DECORATIVE MATERIAL

Mr. Growing Printer.

In Any Location.

Dear Sir:--

Every man has his limitations and so has every shop. It is well for the printer, particularly the small printer, to bear this in mind and not bite off more than he can chew. It is well to hustle for business and it is good to get it. But getting business isn't all of the printing game; there's the doing of it.

In an Eastern city there was a youth who started a small shop, which he opened while studying at one of the technical schools. His work bore all the earmarks of originality and attractiveness. He had a pleasing personality and in his soliciting he used it to good advantage. He hired two men and left school to devote his entire time to his plants. The business was well on the high road to success.

And then his business grew some more. He failed to consider the limitations of his plant, failed to see that it was incapable of doing all the business that came in to him. Orders began to pile up, and customers were continually complaining about the delays. Still the youth went right on soliciting more work and promising its completion at any dates the customers asked.

An advertising agency had been giving him all its work, was chronically delayed, and finally, in disgust, it turned its jobs over to another concern. Others of his customers followed suit because they discovered that it was impossible to learn even approximately when they would get their work.

The youth, a few weeks ago, gave up the business--said he was losing money, which he was. Customers who accepted their work after having been put off for weeks were in no hurry to pay the bills. "He held us up on the job; we'll hold him up on the payment," was their

OLIVER PRINTYPE

The following characters are furnished with each complete font:

a b c d e f g h i j k l m n o p q r s
t u v w x y z A B C D E F G H I J K L
M N O P Q R S T U V W X Y Z 1 2 3 4 5
6 7 8 9 0 \$ & % ¢ @ _ / # = ^ * () "
. , - ; : ! ? ' !

OLIVER PRINTYPE

(Printed through silk)

12 Point 20 A \$1 85 100 a \$5 50 \$7 35

AMERICAN TYPE FOUNDERS COMPANY

ORIGINATOR AND DESIGNER OF THE LATEST
STYLES IN

TYPE

BORDERS, ORNAMENTS AND BRASS RULE

Mr. Progressive Printer,
Most Any Land,

Dear Sir:

There are hundreds of job presses constantly used in the production of imitation typewriter circular letters in our large cities. The rapid increase in the mail order business and use of follow-up systems has created an enormous demand for this work, and no ambitious printer can afford to overlook this avenue of profitable business endeavor.

The accurately reproduced typewriter faces offered by the American Type Founders Company, in such liberal variety, afford any progressive printer the opportunity of engaging in the manufacture of imitation typewritten letters as a specialty. Above the natural satisfaction that comes with success, as evidenced by the growth of business and plant, the American Type Founders Company has the higher satisfaction of knowing that this success is based on the appreciation, by the printers, of good and conscientious work.

Your customers can be induced to order a vastly increased amount of printing if you can show them the value of the modern circular letter. It is an experiment worthy of a serious trial, for many printers have built up a practically independent specialty business in this line of work.

The printing of "duplicate letters" is a profitable business, as good prices can be always maintained. The general effects of a circular letter, or "silent salesman", as it is sometimes called, are usually so remunerative that repeated orders flow in to the printer who can execute them with taste and despatch. Why not specialize along this line, Mr. Progressive Printer? It will pay you.

LINING REMINGTON No. 2

The following characters are furnished with each complete font:

a b c d e f g h i j k l m n o p q r s t
u v w x y z A B C D E F G H I J K L M N
O P Q R S T U V W X Y Z 1 2 3 4 5 6 7 8
9 0 \$ & % # / - () . , : ; - ' " ! ?

LINING REMINGTON TYPEWRITER No. 2

12 Point 20 A \$1 60 100 a \$5 15 \$6 75

Justifiers in 1 and 5 pound fonts 52 cents per pound

American Type Founders Company

Acknowledged Leader in Type Fashions
Complete Printing Office
Outfitter

...type that has
...more than twenty
...friend, and we
...without a parting
...type! We have
...long years. We
...your impassive
...you have done your
...in the composi-
...expressions have
...bound to the
... You have re-
...to speak your mind
...for the news and
... You have
...uttered every
...news from far
...events that were
...embodied jests
...track with
...that has opened
...any weather
...the "last
...! How have
...of the
...to catch the
...now gleefully
...the news"!
...learn." and as
...of that aston-
... "courageous and
... and how you have

LINING SMITH-PREMIER TYPEWRITER No. 2

The following characters are furnished with each complete font :

a b c d e f g h i j k l m n o p q r s t
u v w x y z A B C D E F G H I J K L M N
O P Q R S T U V W X Y Z 1 2 3 4 5 6 7 8
9 0 \$ & % # @ / () . , : ; - ' " ! ?

LINING SMITH-PREMIER TYPEWRITER No. 2
12 Point 20 A \$1 85 100 a \$5 50 \$7 35
Justifiers in 1 and 5 pound fonts 52 cents per pound

American Type Founders Company

DESIGNER AND MAKER OF THE LEADING FACES IN

Typewriter Type

To the Editor, Sir,

Amosite.

Dear Sir:-

Richard Lee is the only one who has
 no other town in the world, and
 sample of the paper which is
 table. The paper which
 the first of the world, and
 workers of the world, and
 are the only one who has
 with the only one who has
 a single copy of the
 try, and the only one who
 which is the only one who
 parts of the world, and
 officials. The only one who
 its numerous copies, and
 time and labor of the
 Indian, is the only one who
 are the only one who
 condition of the world, and
 system of the world, and
 first of the world, and
 needs the only one who
 sexes and race, and
 eight. The only one who
 the world, and

The ideal of the world
 is growing in popularity, and
 Second Part of the world, and
 compel the "particular" of the world, and
 copies per month.

There is no local authority, and
 it being freely distributed to the world, and

YOST TYPEWRITER

The following characters are furnished with each complete font:

a b c d e f g h i j k l m n o p q r s t
 u v w x y z A B C D E F G H I J K L M N
 O P Q R S T U V W X Y Z 1 2 3 4 5 6 7 8
 9 0 \$ & % / ' # () . , : ; - ' " ! ?

YOST TYPEWRITER
(Cast on Original Line)

12 Point 20 A \$1 75 100 a \$5 90 \$7 65

Justifiers in 1 and 5 pound fonts 52 cents per pound

American Type Founders Company

Home of the Famous, Artistic, Business-Getting

Type Families

Brass Rule, Borders, Etc.

Mr. Printerman,
Typewriterville.

Dear Sir:-

The Standard Typewriter is a reproduction of the work done by the Remington Standard Machine--the matrices being obtained from fac-simile impressions furnished by the manufacturers. This face commends itself to the printer producing imitation typewritten letters, because it is easy to read, does not tire the eyes, matches work of this Standard Typewriter, and the type is clean cut and durable.

There is a constantly increasing demand for the printing of imitation typewritten letters, and in all the leading cities wide-awake printers are taking advantage of this and increasing their facilities for doing this work.

If you will instal in your printing plant a good supply of this Standard Typewriter Type and let your customers know that you have it, many remunerative orders will undoubtedly be secured from this investment on your part.

The American Type Founders Company expends more each year than all other type founders in the world in producing new types and showing them attractively. With its immense business and great facilities it can afford to do this as no other founder can.

It will cost no more to buy American Type than it will to buy inferior designs or imitations. We are sending you periodically beautiful Specimens showing our new types, borders and ornaments. Not only is this rapidly enlarging our business, but if our material is used effectively it will largely increase your business.

Our interest is your interest, and your interest is our interest. If you order some of our latest type,

STANDARD TYPEWRITER

The following characters are furnished with each complete font :

a b c d e f g h i j k l m n o p q r s t
u v w x y z A B C D E F G H I J K L M N
O P Q R S T U V W X Y Z 1 2 3 4 5 6 7 8
9 0 \$ & % # / - () . , : ; - ! ? " ' "

STANDARD TYPEWRITER

(Cast on Original Line)

12 Point 20 A \$1 75 100 a \$6 00 \$7 75

Justifiers in 1 and 5 pound fonts 52 cents per pound

AMERICAN TYPE FOUNDERS COMPANY

DESIGNER OF AND LEADER IN

TYPE FASHIONS

To the Trade Associations,

In Every City.

Gentlemen:-

In the assembly room of the Franklin Printing Trades Association, of San Francisco, propositions long dreamed of are becoming realities. The binding of the various branches of the graphic arts into one is almost accomplished. Each division has awakened to the fact that in one manifest principle, the one actuating motive of education and advancement can only be attained by unity. At this end all are working.

The invitation sent out by the Franklin Printing Trades Association has been enthusiastically accepted by the Lithographers Board of Trade of California and the Employing Bookbinders Association. The result is that regular weekly and numerous special meetings of these associations are held in the assembly room for the purpose of devising the best means of consolidation, with no obliterating clauses. That is, merging only on general principles, retaining individuality, while sharing expense and uniform system.

A sequence of events has brought about this healthy get-together spirit. There was the installation of a uniform cost system, which opened men's eyes to their own mistakes instead of their neighbors' misdeeds and showed them that financial failures were wrought by ignorance rather than rivalry. Then the pleasant trip to Portland, with its mutual sympathies and understandings, drew them together as friends, where before they had been merely acquaintances.

The power and scope of the Allied Association will be to deal only with matters which pertain to more than one branch of the trade, except when requested in writing by the delegates of an affiliated association to deal with matters which directly affect them alone.

STENOGRAF

The following characters are furnished with each complete font:

a b c d e f g h i j k l m n o p q r s t
u v w x y z A B C D E F G H I J K L M N
O P Q R S T U V W X Y Z 1 2 3 4 5 6 7 8
9 0 \$ £ & % # / () . , : ; - ' " ! ?

STENOGRAF

(Cast on Original Line)

12 Point 20 A \$1 70 100 a \$5 25 \$6 95

Justifiers in 1 and 5 pound fonts 52 cents per pound

AMERICAN TYPE FOUNDERS COMPANY

DESIGNER AND MAKER OF

TYPE

The Devil is
 a good master
 , and he is
 the best of the
 kind of a young-
 man is and
 men
 all suffer
 to a
 in the future.
 are able
 be
 the
 collection
 place
 work
 shop
 ,
 and
 and
 along
 easily

RIBBON-FACE TYPEWRITER

The following characters are furnished with each complete font :

a b c d e f g h i j k l m n o p q r s t
 u v w x y z A B C D E F G H I J K L M N
 O P Q R S T U V W X Y Z 1 2 3 4 5 6 7 8
 9 0 \$ % / - # % () . , : ; - ' " ?

RIBBON-FACE TYPEWRITER

(Cast on Original Line)

12 Point 15 A \$2 00 60 a \$5 00 \$7 00

Justifiers in 1 and 5 pound fonts 52 cents per pound



**German
Hebrew
Greek
Armenian
Rabbinic
Gaelic
Russian
Esperanto
Music Type**



American Type Founders Company

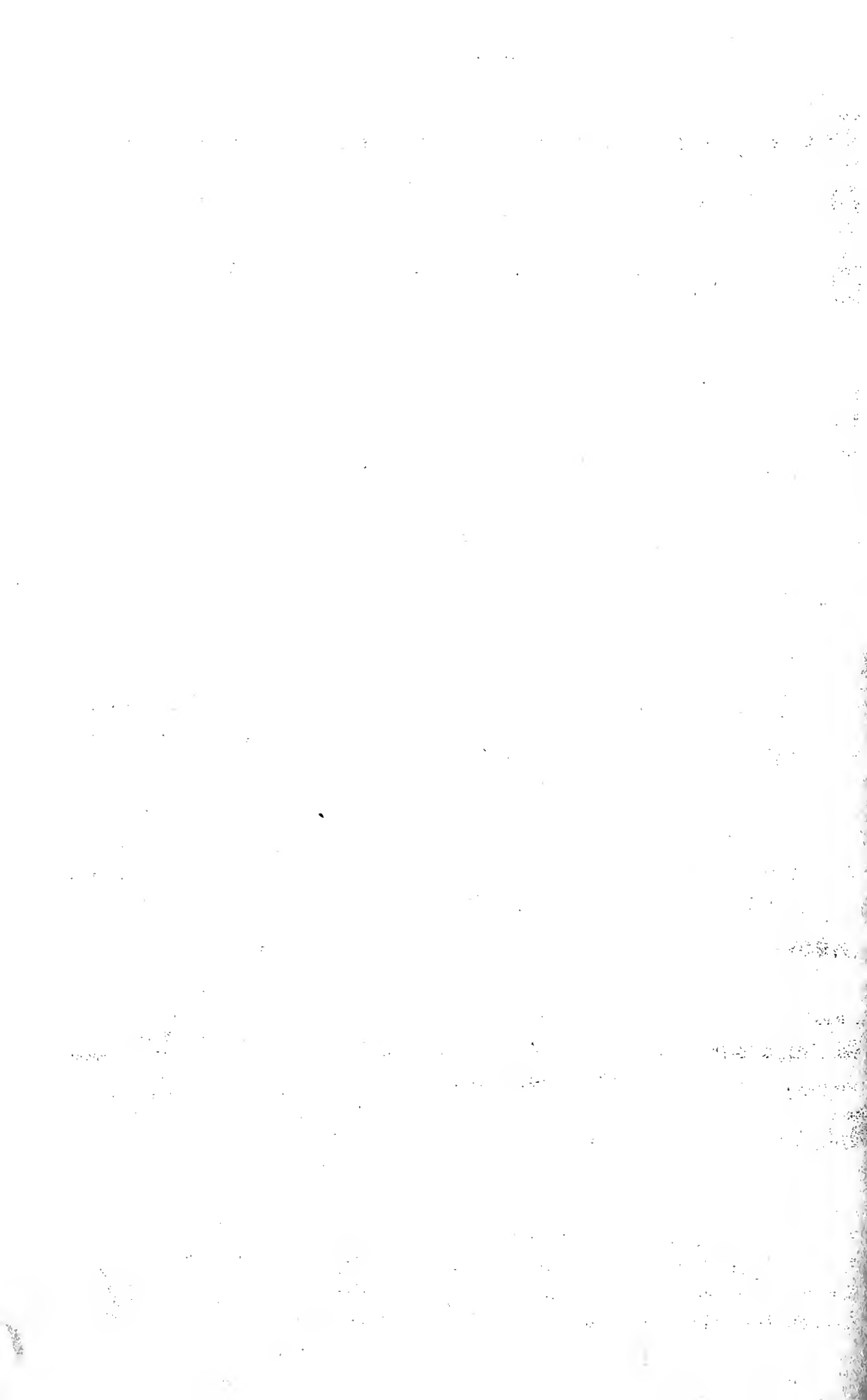

36 Point

4 A \$2 75 8 a \$2 70 \$5 45

Für Jede Deutsche Druckarbeit
Die Größten Berliner Institute
Schriften und Ornament Buch

30 Point

5 A \$2 20 11 a \$2 65 \$4 85

Hofft heute Morgen in Wien zu landen
Ein großartiger Tag für Räumungen
Hiel von Homeroy Brücke und ertrank

24 Point

5 A \$1 60 12 a \$2 05 \$3 65

Zwölf Große Vergnügungsplätze in Amerika
Die Sehenswürdige Alte Dekorationsmalerei
Prächtige Scenerie im Nördlichen California

18 Point

8 A \$1 50 22 a \$2 00 \$3 50

Bau neuer Carnegie-Bibliothek
Theoretische Deutsche Studien
Moderne Schriften Lehrbücher

10 Point

14 A \$1 10 44 a \$1 40 \$2 50

Ihr Sinnbild ist eine Seele in dem Körper
Muntere Brüder sitzen neben dem Bierfaß
Ban Dampfer Kaiser Wilhelm der Große
Fünfter Verein der Buchdrucker gehalten
Nur Zwölf wöchentliche Unterhaltungen

14 Point

10 A \$1 25 33 a \$1 80 \$3 05

Weltberühmte Humoristische Schriften
Großartige Schneeweisse Alpenhöhen
Hütte schön mit Gold und Perlen verziert
Volksfest in dem neuen Schützen Park

8 Point

16 A \$0 95 48 a \$1 40 \$2 35

Verlag des Bibliographischen Instituts in Berlin
Die Eisenbahnen von Madrid und Constantinople
Zwei Fahrten um die Welt mit Dampfer Anstro
Auseinanderlegung der Geschwindigkeitsbekannt
Warnungen und Ratsschläge für unsere Großen
Sehr gutes Lehrbuch für Kinder und Erwachsene

12 Point

13 A \$1 25 37 a \$1 65 \$2 90

Bundesverfassung der Greifenberg Republik
Eleganz Neuer Amerikanischer Eisenbahnen
Die Freuden und Leiden in dem Ehestande
Erlaubt Interessen \$1234567890 Depositen

6 Point

16 A \$0 80 50 a \$1 20 \$2 00

Erkundungen und Fortschritte der Studenten im Baden
Stereoptische und musikalische Unterhaltung vorgezogen
Vergnügungswelt um die Erde im ersten Jahrhundert
New Yorker beim Brand des Frontenar Hotels gerette
Zeitschriften und Sammelwerke über das Freskomalen
Bequemste und billigste Reisegeheimheit nach Süd Italien
Jahrenberichte zeigen \$1234567890 mitglieder im Verein

60 Point

3 A \$4 90 5 a \$3 80 \$8 70

Prächtiges Grönland Zwei Schöne Bücher

48 Point

3 A \$3 35 8 a \$4 15 \$7 50

Hamburger Sonntags Blatt Fünf Theoretische Studien

36 Point

4 A \$2 05 10 a \$2 95 \$5 00

Elegante Amerikanische Menschen Die Schwiegermutter und Pantoffel

24 Point

6 A \$1 55 15 a \$1 95 \$3 50

Die Moderne Lehrbücher Praktisches Schriften Buch Fünf Theoretische Studien

10 Point

14 A \$0 90 42 a \$1 60 \$2 50

Schöne Sommernacht im Nördlichen Berlin Morgen schön mit Gold und Perlen verziert Konkurrenzentwürfe des Schützen Vereins Eisenbahn von Madrid nach Constantinople Zeitschrift für die deutschen Schulen in Wien Sehr Großartige Schneeweiße Alpenhöhen

18 Point

8 A \$1 20 25 a \$2 05 \$3 25

Amerikanische Transport Geschäfte Die Aufführung von Deutscher Opern Volksfest der Hamburger Schützen

8 Point

15 A \$0 80 44 a \$1 45 \$2 25

Hervorragender Roman und Novellen Erzähler Lehrreiches Institut für Kinder und Erwachsene Wunderschöne Kleine Bäume im Schwarzwalde Praktische Methoden für Ackerbaugesellschaften Wahre Freundschaft ist gleich einer Schaumünze Zwei Muntere Brüder sitzen neben dem Bierfaß

12 Point

13 A \$1 10 35 a \$1 65 \$2 75

Erstes Volksfest im Schützen Park am Samstag Die Versammlung des Deutschen Vereins Arion Erlaubt Interessen \$1234567890 für Depositen

6 Point

17 A \$0 75 49a \$1 25 \$2 00

Debatten zwischen Erkermann und Göthe über Deutschland Edelsinn und Philanthropie der Gross New Yorker Bürger Biographie des Hans Wilhelm Schuster und Poet in Schriften Ein Grosses Volksfest im Alten Schützen Park am Samstag Zwei Jahresberichte zeigen \$1234567890 viele neue Mitglieder

Thlenburg Extended

(Cast on original line)

60 Point

3 A \$5 05 4 a \$4 45 \$9 50

Buch für Kinder

48 Point

3 A \$3 75 6 a \$4 25 \$8 00

Neue Fachzeitschrift Glückliche Arbeiter

36 Point

3 A \$2 30 7 a \$2 75 \$5 05

Sehr Kleine Blaue Augen Elegante Vereins Zeitung

30 Point

4 A \$2 15 9 a \$2 15 \$4 30

Prächtige Weihnachts Bäume Deutsche Studenten Duelliren

24 Point

4 A \$1 45 12 a \$2 30 \$3 75

Praktische Theorie Bekränzt mit Laub

10 Point

11 A \$0 90 32 a \$1 60 \$2 50

Nach Regen Folgt Sonnenschein Uereine Enttäuschter Liebhaber Letzter Bericht der Kommissäre Arbeit ist die Würze des Lebens

18 Point

6 A \$1 25 18 a \$2 00 \$3 25

Neuste Eisenbahn Brücke Sieben Deutsche Soldaten

8 Point

12 A \$0 75 35 a \$1 50 \$2 25

Das Deutsche Tageblatt in Hamburg Bekränzt mit Laub das Volle Glas Zufschneider und Graue Dummköpfe Die Schriften von Johann Gutenberg

12 Point

9A \$0 95 27 a \$1 80 \$2 75

Nur Fünf Erzählungen aus Indien Die Handelsfrage in Nord Amerika Bezahlt heute \$1234567890 in Gold

6 Point

13 A \$0 70 39 a \$1 30 \$2 00

Flammen Drohten Luna Park zu Vernichten Werthvolle Prachtvögel und Schmetterlinge Deutscher Novellenschatz in Wort und Bilder Ihr Sinnbild ist eine Seele in Zwei Körpern Neue Bank \$1234567890 Empfehlenswerth

48 Point

3 A \$3 80 6 a \$3 70 \$7 50

Rheinwein Handlung Prächtige Mondschein

36 Point

3 A \$2 35 8 a \$2 65 \$5 00

Weihnachtsabend für Kinder Glückliche Jugendherrlichkeit

30 Point

4 A \$2 00 10 a \$2 30 \$4 30

Neues Amerikanisches Schriftbuch Unterhandlung Zwischen Piraten Bilder für Kinder und Erwachsene

24 Point

5 A \$1 60 13 a \$1 90 \$3 50

Neueste Berliner Moden Sehr Glückliche Arbeiter Kleine Schwarze Bären

10 Point

12 A \$1 00 36 a \$1 50 \$2 50

Arbeit und Geld regiert die ganze Welt
Sieben Humoristische Bilder für Kinder
Der New Yorker Schulmeister Zeitung
Hoch klingt das Lied von braven Mann
Ansicht eines Naturforschers aus Wien
Das Abschiedslied der fröhlichen Sänger

14 Point

9 A \$1 25 26 a \$1 75 \$3 00

Hier sind die Billets für das Gepäck
Soldaten kehren vom Kriege Zurück
Nehmen Sie noch eine Tasse Kaffee

8 Point

14 A \$0 95 41 a \$1 30 \$2 25

Gleich nach der Erfindung der Buchdruckerkunst
Preiset unsere Reben sagt ein altes Sprichwort
Zwei Wunderschöne kleine Telegraphenstation
Gemälde Institut für Kinder und Erwachsene
Schöne Sommernacht im Nördlichen Denmark

12 Point

11 A \$1 10 33 a \$1 70 \$2 80

Der Knabe hat das deutsche Gedicht gelernt
Heute habe ich meine Klavierstunde gehabt
Die Mutter \$1234567890 macht den Kaffee

6 Point

15 A \$0 70 46 a \$1 30 \$2 00

Wundervolle Deutscher Novellenschag in Wort und Bild
Prächtiger Amerikanischer Blumengarten in Deutschland
Erfindungen und Fortschritte der Studenten in Hamburg
Freunde in Marburg, wo er studiert hat, Zugeschickt
Bezahlen Sie das Porto \$1234567890 haben Sie den Brief

Am frühen Morgen
Im Walde zu gehen

Schöne Eisenbahnbrücke
Ich liebe Schwarzes Brod

Schöne Häuser in Deutschland
Die deutsche Küche gefällt mir
Geben Sie mir die Alte Haube

Glückliche Schriftsetzer
Drei hübsche Blümlein
Pflanzen ohne Zweige

Großes Konzert im Walde
Windmühlen für Fabriken
Neueste Hamburger Moden
Bezahlt \$1254567890 Gold

Jerstäubung der Maikaser
Ein Glückliche Schriftsetzer
Geschichten und Loblieder

Es ist das Dampfboot von Berlin
Nehmen Sie ein Glas Roth Wein
Was für eine schöne Ueberfahrt
Der Zug geht in zehn Minuten ab
Kommen Sie nach dem Zollamte

Elegante Schriften Lehrbücher
Ornamente und Messinglinien
Große Meister Schöne Künste

Wir werden eine lange Ueberfahrt haben
Ich fahre mit dem ersten Zuge nach Wien
Lassen Sie uns hinab in der Kajüte gehen
Ich wünsche Ihnen eine glückliche Reise
Bringen Sie \$1254567890 die Rechnung

German Full Face No. 150

(Cast on original line)

30 Point

3 A \$1 90 8 a \$2 35 \$4 25

Wir sind Western hier Gewesen

24 Point

4 A \$1 65 11 a \$1 85 \$3 50

Ich wünsche Ihnen glückliche Rückfahrt

18 Point

7 A \$1 50 18 a \$1 75 \$3 25

Sie haben Zwei gute Lehrer

9 Point

13 A \$1 00 35 a \$1 50 \$2 50

**Er wohnt in der ersten Straße Numero ein
Ich fahre mit dem ersten Zuge nach Berlin**

12 Point

10 A \$1 15 26 a \$1 60 \$2 75

**Bringen Sie mir meine Schnupftücher
Gebrauch \$1234567890 viel Geld**

8 Point

13 A \$0 95 35 a \$1 30 \$2 25

**Lassen Sie uns bald das Abendbrod haben
Wachen Sie mich morgen früh um fünf Uhr
Von Dover mit der Eisenbahn nach Wien**

11 Point

12 A \$1 15 33 a \$1 60 \$2 75

**Die deutschen Winter sind kälter im Januar
Fünf große Vergnügungsplätze in Amerika**

7 Point

14 A \$0 90 42 a \$1 35 \$2 25

**Morgen und Abend ist es sehr kühl in September
Wir brennen Holz und Dorf, zuweisen Brammfohl
Sie können zu jeder Zeit nach der Karte inspiriren**

10 Point

12 A \$1 05 35 a \$1 45 \$2 50

**Erstes Volksfest im Schützen Park am Samstag
Die Versammlung des Deutschen Vereins Union**

6 Point

14 A \$0 85 42 a \$1 15 \$2 00

**Diese Thüre ist neun Fuß lang und sechs Fuß breit
Ich hätte meinen Namen hineinschreiben sollen
Haben Sie das bestellt \$1234567890 ja Ich habe**

Heintzemann Series

(Cast on original line)

30 Point

4 A \$1 90 10 a \$2 35 \$4 25

Soldaten kehren vom Kriege Zurück

24 Point

5 A \$1 55 13 a \$1 95 \$3 50

Er Hoffte heute Morgen in Hamburg zu landen

18 Point

8 A \$1 40 21 a \$1 85 \$3 25

Ich habe also Zwei Großväter, aber nur eine Großmutter

14 Point

8 A \$1 15 27 a \$1 85 \$3 00

Großartige Schneeweisse Alpenhöhen

9 Point

14 A \$1 00 41 a \$1 50 \$2 50

**Nur Vierzehn wöchentliche Unterhaltungen
Dieser Brief ist für meine Schwiegermutter**

12 Point

12 A \$1 20 33 a \$1 55 \$2 75

Erlaubt Interessen \$1234567890 Depositen

8 Point

14 A \$0 95 42 a \$1 35 \$2 30

**Verlag des Bibliographischen Instituts in Wien
Auseinanderlegung der Geschwindigkeitskurven**

10 Point

13 A \$1 00 40 a \$1 50 \$2 50

**Der Sohn des Lehrers schreibt der Schwester einen Brief
Schöner Neuer Amerikanischer Schützen Park gebaut**

6 Point

15 A \$0 70 46 a \$1 30 \$2 00

**Erfindungen und Fortschritte der Studenten in Ostend
Stereotypische und musikalische Unterhaltung vorgezogen
Jahresberichte zeigen \$1234567890 neue Spar Bank**

72 Point

3 A \$1 85 5 a \$3 15 \$8 00

Ein Paar Strümpfe

60 Point

3 A \$5 00 5 a \$3 50 \$8 50

Das Frühstück ist fertig

42 Point

3 A \$2 60 10 a \$3 65 \$6 25

Karl hat zwölf Mark in Silber

36 Point

3 A \$2 15 10 a \$2 85 \$5 00

Deutschland ist größer als Frankreich

30 Point

5 A \$2 05 13 a \$2 20 \$4 25

Ein deutsches Wiegenlied

41 Point

15 A \$1 10 44 a \$1 70 \$2 80

Hundert Herren wohnen in diesem Hause
Kellner, zeigen Sie mir die Spielkarte

20 Point

7 A \$1 60 18 a \$1 65 \$3 25

Das Papier war nicht zu finden

10 Point

13 A \$1 00 40 a \$1 50 \$2 50

Der Zug hält auf jeder Station für Gepäck
Lassen Sie uns bald das Abendbrot haben

18 Point

8 A \$1 30 27 a \$1 95 \$3 25

Es giebt dieses Jahr viel Champagner
Umsturz der Monarchie in Frankreich

9 Point

15 A \$0 95 46 a \$1 60 \$2 55

Die Arbeit und das Geld regiert die ganze Welt
Damen fahren mit dem ersten Zug nach Hamburg
Kneuzehn Soldaten kehren vom Kriege zurück

14 Point

11 A \$1 20 32 a \$1 80 \$3 00

Pflücken Sie viele Hyacinthen und Tulpen
Schwabenstriche der Deutschen Studenten

8 Point

14 A \$0 90 42 a \$1 35 \$2 25

Es ist ein wunderschöner Tag für Räumungen
Speziell für Patrioten, Abfahrt deutscher Wauer
Ich glaube wir werden bald einen Sturm haben

12 Point

13 A \$1 15 36 a \$1 60 \$2 75

Das Heidelberger Faß hat so manchen Durst gestillt
Bezahlen Sie in Gold \$1234567890 Ich habe es

6 Point

18 A \$0 75 52 a \$1 25 \$2 00

Das erste Buch der Natur liegt seit Jahrtausenden aufgeschlagen
Zwei Handwerker, Hein und Hans, machten einmal einen Fehler
Bringen Sie meine Rechnung \$1234567890 Versehen Sie Mich

6 Point No. 571

14 A \$0 80 42 a \$1 20 \$2 00

Ein reicher Mann hatte eine beträchtliche Geldsumme, welche in ein Tuch eingenäht war, verloren. Er machte seinen Verlust bekannt und bot dem ehrlichen Finder eine Belohnung von hundert Talern an. Da kam bald ein guter und ehrlicher Mann daher gegangen. „Dein Geld habe ich gefunden. Dies wird's wohl sein! So nimm dein Eigentum zurück!“ So sprach er mit dem heitern Blicke eines ehrlichen Mannes und eines guten Gewissens. Der andere machte auch ein fröhliches Gesicht, aber nur, weil er sein verloren geglaubtes Geld wieder hatte. Denn wie es um seine Ehrlichkeit ansah, das wird sich bald zeigen. Er zählte das Geld und dachte unterdessen geschwind nach, wie er den treuen Finder um seine versprochene Belohnung bringen könnte. „Guter Freund,“ sprach er hierauf, „es waren 800 Taler in das Tuch eingenäht. Ich finde aber nur noch 700 Taler. Du wirst wohl eine Raht aufgetrennt und deine hundert Taler herausgenommen haben. Da hast du wohl daran getan. Ich danke dir.“ Der ehrliche Finder, dem es weniger um die 100 Taler als um seine unbescholtene Rechtchaffenheit zu tun war, versicherte, daß er das Päcklein so gefunden habe, wie er es bringe. Am Ende kamen sie vor den Richter. Beide bekanden auch hier noch auf ihrer Behauptung; der eine, daß 800 Taler eingenäht gewesen seien, der andere, daß er von dem Befundenen nichts genommen und das Päcklein nicht verächt habe. Da war guter Rat teuer. Aber der kluge Richter, der die Ehrlichkeit des einen und die schlechte Bestimmung des andern vorans zu seinen Schien, griff die Sache so an: er ließ sich von beiden über

8 Point No. 571

12 A \$0 85 36 a \$1 40 \$2 25

Ein reicher Mann hatte eine beträchtliche Geldsumme, welche in ein Tuch eingenäht war, verloren. Er machte seinen Verlust bekannt und bot dem ehrlichen Finder eine Belohnung von hundert Talern an. Da kam bald ein guter und ehrlicher Mann daher gegangen. „Dein Geld habe ich gefunden. Dies wird's wohl sein! So nimm dein Eigentum zurück!“ So sprach er mit dem heitern Blicke eines ehrlichen Mannes und eines guten Gewissens. Der andere machte auch ein fröhliches Gesicht, aber nur, weil er sein verloren geglaubtes Geld wieder hatte. Denn wie es um seine Ehrlichkeit ansah, das wird sich bald zeigen. Er zählte das Geld und dachte unterdessen geschwind nach, wie er den treuen Finder um seine versprochene Belohnung bringen könnte. „Guter Freund,“ sprach er hierauf, „es waren 800 Taler in das Tuch eingenäht. Ich finde aber nur noch 700 Taler. Du wirst wohl eine Raht aufgetrennt und deine hundert Taler herausgenommen haben. Da hast du wohl daran getan. Ich danke dir.“ Der ehrliche Finder, dem es weniger um die 100 Taler als um seine unbescholtene Rechtchaffenheit zu tun war, versicherte, daß er das Päcklein so gefunden habe, wie er es bringe.

10 Point No. 571

10 A \$1 00 30 a \$1 50 \$2 50

Ein reicher Mann hatte eine beträchtliche Geldsumme, welche in ein Tuch eingenäht war, verloren. Er machte seinen Verlust bekannt und bot dem ehrlichen Finder eine Belohnung von hundert Talern an. Da kam bald ein guter und ehrlicher Mann daher gegangen. „Dein Geld habe ich gefunden. Dies wird's wohl sein! So nimm dein Eigentum zurück!“ So sprach er mit dem heitern Blicke eines ehrlichen Mannes und eines guten Gewissens. Der andere machte auch ein fröhliches Gesicht, aber nur, weil er sein verloren geglaubtes Geld wieder hatte. Denn wie es um seine Ehrlichkeit ansah, das wird sich bald zeigen. Er zählte das Geld und dachte unterdessen geschwind nach, wie er den treuen Finder um seine versprochene Belohnung bringen könnte.

12 Point No. 571

8 A \$1 20 24 a \$1 60 \$2 80

Ein reicher Mann hatte eine beträchtliche Geldsumme, welche in ein Tuch eingenäht war, verloren. Er machte seinen Verlust bekannt und bot dem ehrlichen Finder eine Belohnung von hundert Talern an. Da kam bald ein guter und ehrlicher Mann daher gegangen. „Dein Geld habe ich gefunden. Dies wird's wohl sein! So nimm dein Eigentum zurück!“ So sprach er mit dem heitern Blicke eines ehrlichen Mannes und eines guten Gewissens. Der andere machte auch ein fröhliches Gesicht, aber nur, weil er sein verloren geglaubtes Geld wieder hatte.

German Title Extra Condensed

(Cast on original line.)

24 Point

6 A \$1 60 17 a \$1 90 \$3 50

Ein reicher Mann hatte eine beträchtliche geldsumme in ein Tuch

20 Point

8 A \$1 35 22 a \$1 90 \$3 25

16 Point

11 A \$1 15 32 a \$1 85 \$3 00

Wessen Sie mich morgen früh um ein Uhr

Eine Frau trieb einen Esel in die Stadt

18 Point

10 A \$1 30 32 a \$1 95 \$3 25

12 Point

14 A \$1 10 42 a \$1 65 \$2 75

Der Schüler schreibt seinen Namen in sein Buch

Die Mutter macht ihrer Tochter ein Schürze
hatte beträchtliche \$1234567890 Geldsumme

GAELIC
(Cast on original line.)

8 Point Sold in Weight Fonts only
uob' uasal mo shean agus mo sinnsear, ba maic a bheoistim i leabhair agus i sgoilaid ba
crunn a seiall i seomhairleib ba luac a lam agus ba ealma a seoroide i seuruaid eadaid
ba eair ian te tashaid ba vana te namuaid, ba luctmar a leim as maad na seoc fe eairneam
spreme site i' uata eadga—stium ar stium, i' fuil u3 bfuil me, enan u3 genan me, fmuor u3 fmuor
me i' me oisre a mor eporde agus a mor meom asat an oisreacat fan i' uair ead
eap uadme an uoimam mo fmuor as fa, muor eair Dia a raruasaid maic ar ealam saeodal mife agus
im' saeodal tom so ueisru na seacat fmuorue ue epe eairte of mo eionn i' i' eire mo eir—tir zorbinn
ar uet dpu na ucomn, i' tuom fa i' dem' eapre fem om' fmuor as eire maorua na maiteann mban
eire na ngeal-rruc ceoil agus na ngeannca fpaic, i' tptom a toppaid 'n-a seoraid bpanair, i' mair

12 Point Sold in Weight Fonts only
saedual mise, nac uasal san, saedual im meon, saedual om'
'seacat sinnsear saedual, saedual mise agus me 'sa maorueam
a flan fe'n uoimam uite cine saedual a raruasaid, i' i' mo teangsa an saeduis uinn,
Teangsa na mairte fada buadon, an eamnt uorb eprean, an eamnt eum ceoil, an
eamnt lionmar luac-foctac, an tpruc-eamnt sradad, an uorb-eamnt eadca, an uoar-
eamnt fite agus fadid' agus fup-leisinn, i' i' mo rosa i' eap teangseid an uoimam
mair, om i' saedul uo eap i, 'i' i' saedul uo eap i, 'i' i' saedul uo iub, a teangsa
uafal mo fmuor as, ni cloirfear om' beul so bpaic acat tu loirbinn an ceol ceol

ARMENIAN
(Cast on original line.)

10 Point Sold in Weight Fonts only
ՈՒՇԱԴՐՈՒԹԻՒՆ .— ՌՈՒԲԷՆ Ն . ԱՄԻՐԽԱՆՆԱՆՅ Ամերիկա եկաւ 1903 Մայիս 20ին .
մի ժամանակ յետոյ ծանօթացաւ Ամերիկեան Թայփ Ֆասունարիի Ընկերութեան
Հեար . որչեց տպագրութեամբ պարապիլ . Ամերիկեան Թայփ Ֆասունարիի գորա-
ւոր , ճաշակաւոր և գեղեցիկ տասերը կը գործածէ մինչև Հիմայ : Ամերիկեան Թայփ
Ֆասունարիի տնեցած այս 10 փոխիթ տասը շատ յարմար է Լրագրի և Գրքի . Հաւա-
տար է Ամերիկեան տասերու : Տպագրութեան ժամանակ դժուարութիւն չ'կայ երբ
օտար բառեր գրուին մէջը : ՌՈՒԲԷՆ Ն . ԱՄԻՐԽԱՆՆԱՆՅը բաժնեակը Արարատ
Տպագրական Ընկերութեան և 1912 Յունիլ : Չին բացարձակ Տէր և Տնօրէն Արարատ
Տպագրական Ընկերութեան' որ ներկայիս կը գտնուի 159 Իսթ 2Տրդ փողոց , Նիւ Եորք .
վերջապէս ՊՐ . Ռ . ԱՄԻՐԽԱՆՆԱՆՅը կը թելադրէ բոլոր այն հայրենակիցներուն
որոնք որ կ'ուզեն տպագրական գործ բնել ամերիկայի մէջ պէտք է որ այս ճաշա-

14 Point Sold in Weight Fonts only
ՈՒՇԱԴՐՈՒԹԻՒՆ .— ՌՈՒԲԷՆ Ն . ԱՄԻՐԽԱՆՆԱՆՅ Ամ-
երիկա եկաւ 1903 Մայիս 20ին . մի ժամանակ յետոյ ծանօթացաւ
Ամերիկեան Թայփ Ֆասունարիի Ընկերութեան Հեար . որչեց
տպագրութեամբ պարապիլ . Ամերիկեան Թայփ Ֆասունարիի գո-
րաւոր , ճաշակաւոր և գեղեցիկ տասերը կը գործածէ մինչև Հի-
մայ : Ամերիկեան Թայփ Ֆասունարիի տնեցած այս 14 փոխիթ
տասը շատ յարմար է Լրագրի և Գրքի . Հաւատար է Ամերիկ-
եան տասերու : Տպագրութեան ժամանակ դժուարութիւն չ'կայ
երբ օտար բառեր գրուին մէջը : ՌՈՒԲԷՆ Ն . ԱՄԻՐԽԱՆ-
ՆԱՆՅը բաժնեակը Արարատ Տպագրական Ընկերութեան և

Hebrew Type

(Cast on original line)

60 Point No. 21

Per font \$9 20

מאססען פערזאמלונג
די אידישע ווארהייט

48 Point No. 21

Per font \$7 50

דיא שעהנע טייפ איז
אמעריקאנער ברויט

30 Point No. 21

Per font \$4 30

דער צוואמענפאחר פון די
די גרויס פון פאסיפיק איז
אמעריקאן טייפ און בוק

24 Point No. 1

Per font \$3 60

דיא סיסטעם ווערט אויסגעבעסערט
א לעקטשור און מיוזיקאל פראגראם
דיא נאציאנען דייטשלאנד רוסלאנד

24 Point No. 2

Per font \$3 50

דיא שעהנסטע און מאדערנסטע שריפטען אין פוך
לאנג איילאנד ביונעס קארפאראיישאן אף פרוקלין
טשיקאגא באסטאן פילאדעלפיה האמבורג אהאיו

Hebrew Type

(Cast on original line)

18 Point No. 1

Per font \$3 25

פאנגען אן מיט שמוחה און ענדיגען מיט טרויער
רוסלאנד אנארקענט פריפארלי אלס קאלאניע
קאפען און אגריקולטור-מאשינעריע בילדען אין

18 Point No. 21

Per font \$3 25

דיא פראגע איז דיסקוטירט געווארען אויף'ן
ענגלאנד האט חרטה אויף אזהר פאליטיק
דיא דזשורי האט ארויסגעטראגען א ווערדיק

18 Point No. 23

Per font \$3 25

דער בעריכט צייגט אז דיא ארבייט פארן נאציאנאל פאנד
א פראגע וואס איז פון גרויס אינטערעסע איז דא צוליעב די
דער אונטערשיעד צווישען דיא אמעריקאנער און רוסישע

12 Point No. 1

Per font \$2 75

דעפאזיטס ווערדען אנגענומען צאהלבאר געגען טשעקס אין
וויא ווייט דער מיטעל געגען דיא פארשפרייטונג פון קראנקע
רעפארט פון באארד אוו העאלטה האט איבערצייגט אז אויף
דיא פערקלענערונג פון טויטען-פעלע און דיא פערמעחרונג

8 Point No. 1

Per font \$2 25

דיא שטעלקייט מיט וועלכע מען לערנט זיך אויס
צו געברויכען געוויסע פראצען אין פאליטישען לער-
פען איז וואונדערבאר. אפט אין די לענדער וואו
מיניסטארען זיינען אויף מיטגליעדער פון פארלי-
מענט און זיינען צו איהם דירעקט פראנטווארט.

12 Point No. 2

Per font \$2 80

דיא שטעלקייט מיט וועלכע מען לערנט זיך אויס
צו געברויכען געוויסע פראצען אין פאליטישען לער-
פען איז וואונדערבאר. אפט אין די לענדער וואו
דיא מיניסטארען זיינען אויך
\$1234567890

8 Point No. 2

Per font \$2 25

10 Point No. 1

Per font \$2 50

PORSON GREEK

(Cast on original line.)

8 Point

Per Font \$7 50

Τοῦ δ' ἐπιγυγνομένου θέρους αἱ μὲν ἐνιαύσιοι σπονδαὶ διελέγυντο μέχρι Πυθίων· καὶ ἐν τῇ ἐκεχειρίᾳ οἱ Ἄθηναῖοι Δηλίους ἀνέστησαν ἐκ Δήλου, ἡγησάμενοι κατὰ παλαιὰν τινα αἰτίαν οὐ καθαρὸς ὄντας ἱερῶσθαι, καὶ ἅμα ἑλλιπέες σφίσι εἶναι τοῦτο τῆς καθάρσεως, ἣ πρότερό μοι δεδήλωται ὡς ἀνελόντες τὰς θήκας τῶν τεθνεώτων ὀρθῶς ἐνόμισαν ποιῆσαι. καὶ οἱ μὲν Δῆλιοι Ἀτραμύττειον Φαρνάκου δόντος αὐτοῖς ἐν

10 Point

Per Font \$7 50

Ἄλλο δὲ στράτευμα αὐτῷ συνελέγετο ἐν Χερρονήσῳ τῇ καταντιπέρας Ἀβύδου τονδε τὸν τροπον· Κλέαρχος Δακεδαμόνιος φύγας ἦν· τοῦτ' αὖτε συγγενόμενος ὁ Κύρος ἠγάσθη τε αὐτὸν καὶ δίδωσιν αὐτῷ μυρίους δυρεικοῖς· ὁ δὲ λαβὼν τὸ χρουσίον στράτευμα συνέλεξεν ἀπὸ τούτων τῶο χρημάτων, καὶ

11 Point

Per Font \$7 50

Ἐπεὶ δὲ ἦσαν ἐν τῇ ἄνω χώρᾳ οἱ Ἕλληνες, ὅποια τῶν χωρίων τοῖς Δρίλαις ἀλώσιμα εἶναι ἐδόκει, ἐμπιπράντες ἀπήεσαν· καὶ οὐδὲν ἦν λαμβάνειν, εἰ μὴ ὡς βοῦς ἢ βοῦς ἢ ἄλλο τι κτήνος τὸ πῦρ διαπεφευγός. Ἐν δ' ἦν χωρίον

12 Point

Per Font \$7 50

Ἄλλὰ γὰρ οὐ τὰ μέλλοντα ἔσεσθαι βούλομαι λέγειν, πραχθέντα ὑπὸ τούτων οὐδυναίμενος εἰπεῖν· οὐδὲ γὰρ ἀπώλεσε· τιμώμενος δὲ καὶ τῶν μεγίστων ἀξιούμενος σώσειν τὴν πόλιν αὐτὸς ἀπώλεσε,

GREEK No. 2

(Cast on original line.)

6 Point No. 2

Per Font \$7 50

Γινώσκω γὰρ, ἔφη, ὅτι, εἰ μὴ τινα καρπὸν γήφονται τῶν, πόνων, οὐδυναίσομαι αὐτοὺς πολὺν χρόνον πευδομένους ἔχειν. Διαρπάσαι μὲν οὐν αὐτοῖς ἐφείναι τὴν πόλιν οὐ βούλομαι· τὴν τε γὰρ πόλιν νομίζω ἂν διαφθάρηαι, ἐν τε τῇ ἀρπαγῇ εὐ οἶδ' ὅτι οἱ ποιηρότατοι πλεονεκτήσειαν ἂν. Ἀκούσας ταῦτα ὁ Κροῖσος ἔλεξε, Ἄλλ' ἐμὲ, ἔφη, ἔασον λέξαι, πρὸς οὓς ἂν ἔγω Λυδῶν, ἐθέλω, ὅτι διαπέπραγμαί παρὰ σοῦ μὴ ποιῆσαι ἀρπαγὴν, μηδὲ ἔασαι ἀφανισθῆναι παῖδας καὶ γυναῖκας· ὑπεσχόμην δέ σοι ἀπὸ τούτων, ἣ μὴν παρ' ἐκόντων Λυδῶν ἔσεσθαι

8 Point No. 2

Per Font \$7 50

Ἄλλ' ἂν, ἔφη, ἄνασχόμην πλεονεκτοῦντας ὀρῶν τοὺς ἀτακτοῦντας. Καὶ εὐ μὲν, ἔφη, ἐπίστασθε, ὅτι παρεσκευασθῆναι ἐγὼ ὑμᾶς πασι Χαλδαῖοις μακαριστοὺς ποιῆσαι· νῦν δ', ἔφη, μὴ θανατώετε, ἦν τις καὶ ἀπιούσιν ὑμῖν κρείττων ἐντύχη. Ἀκούσαντες ταῦτα οἱ Χαλδαῖοι ἐδεισάν τε καὶ ἰκέτεον παύσασθαι ὀργιζόμενον, καὶ τὰ χρήματα πάντα ἀποδοῦσιν ἔφασον. Ὅ δὲ εἰ πεν, ὅτι οὐδὲν αὐτῶν δέοιτο.

10 Point No. 2

Per Font \$7 50

Ὡς δὲ ἐγένετο τοῦτο δῆλον, ὅτι εἶχετο τὰ ἄκρα, πάντες δὲ ἔφευγον οἱ Λυδοὶ ἀπὸ τῶν τειχῶν, ὅπη ἡδύνατο ἕκαστος τῆς πόλεως. Κύρος δὲ ἅμα τῇ ἡμέρᾳ εἰσῆγει εἰς τὴν πόλιν, καὶ παρήγγειλεν ἕκ τῆς τάξεως μηδένα κινεῖσθαι. Ὅ δὲ Κροῖσος κατακλι-

11 Point No. 2

Per Font \$7 50

Ταῦτα δὲ ποιῶν, κατὰ τὰ ἀποτομῶτατα δοκούντα εἶναι τοῦ Σαρδιανῶν ἐρύματος τῆς ἐπεούσης νυκτὸς ἀναβιβάζει Χαλδαίους τε καὶ Πέρσας. Ἠγήσατο δ' αὐτοῖς ἀνὴρ Πέρσας, δοῦλος γεγεννημένος τῶν ἐν τῇ ἀρχοπέλει τινός

12 Point No. 2

Per Font \$7 50

Καὶ οἱ μὲν ἀμφὶ τὸν Κύρον, δειπνοποιησάμενοι καὶ φύλακας καταστησάμενοι, ὕπερ ἔδει, ἐκοιμήθησαν. Κροῖσος μὲντοι εὐδύς ἐπὶ Σάρδεων ἔφευγε σὺν τῷ στρατεύματι τὰ δ' ἄλλα φύλα ὅποι ἐδύνατο προσωπάτω ἐν τῇ νυκτὶ τῆς ἐπ' οἶκον ὁδοῦ ἕκαστος ἄπεχ

HEAVY FACE GREEK

(Cast on original line.)

8 Point

Per Font \$7 50

Οὐκοῦν οὐδ' ἂν εἰς ἀντίποι ὡς οὐ συμφέρει τῇ πόλει καὶ Δακεδαμονίους ἀσθενεῖς εἶναι καὶ Θεβαίους τούτους. Ἔστι τοίνυν ἐν τινι τοιοῦτῷ τὰ πράγματα νῦν εἰ τι δεῖ τοῖς εἰρημένοις πολλάκις παρ' ὑμῖν λόγους τεκμήρασαι, ὥσπερ Θεβαίους μὲν Ὀρχομενοῦ καὶ Θεσπιῶν καὶ Πλα-

11 Point

Per Font \$7 50

Βοηθήσαντες δὲ ἐς αὐτὸ Πασιτελίδας τε ὁ Δακεδαίμωνιος ἄρχων καὶ ἡ παρούσα φυλακὴ προσβαλήντων τῶν ἠθηναίων ἡμύνοντο. καὶ ὡς ἐβιάζοντο καὶ αἱ νῆες ἅμα περιέπλε

RABBINIC

(Cast on original line.)

10 Point

Sold in Weight Fonts only

יחסי תהיה וזל לרשי י"ל רבשי דייק וידבתיז יירא חלוי
 ה ינה כתניז יירא ה חל הצרסס צסדיח חנה ידחי לכך נח
 נתייר חל הצרסס דקחי חרש ויילה הלעיל יתסס יתסס כתניז
 צסדיח חל הצרסס יח כ ליה נרחס חלוי יתן לחיור ויניה
 ייסף בר ויחס נחסס החרתיין ויחלחלתיש סט צוקלקן

8 Point

Sold in Weight Fonts only

יחסי תהיה וזל לרשי י"ל רבשי דייק וידבתיז יירא חלוי
 ה ינה כתניז יירא ה חל הצרסס צסדיח חנה ידחי לכך נח
 נתייר חל הצרסס דקחי חרש ויילה הלעיל יתסס יתסס כתניז
 צסדיח חל הצרסס יח כ ליה נרחס חלוי יתן לחיור ויניה
 ייסף בר ויחס נחסס החרתיין ויחלחלתיש סט צוקלקן

12 Point

Sold in Weight Fonts only

יחסי תהיה וזל לרשי י"ל רבשי דייק וידבתיז יירא חלוי
 ה ינה כתניז יירא ה חל הצרסס צסדיח חנה ידחי לכך נח
 נתייר חל הצרסס דקחי חרש ויילה הלעיל יתסס יתסס כתניז
 צסדיח חל הצרסס יח כ ליה נרחס חלוי יתן לחיור ויניה
 ייסף בר ויחס נחסס החרתיין ויחלחלתיש סט צוקלקן

RUSSIAN

8 Point Lining Russian

Sold in Weight Fonts only

Это должно было уведомлено въ прошломъ году,
 во время царствования АЛЕКСАНДРА ВТОРОГО,
 что въ столицѣ Петербургъ началась важная
 перемена полиціи, которая можетъ быть
 прибавляла мирному народу болѣе жадности къ
 революціонной славѣ. Одинъ остроумный про-

10 Point Century Expanded Russian Sold in Weight Fonts only

Общество Американскихъ Словолитниковъ
 рекомендуетъ свой богатый складъ
 Англійскихъ, Нѣмецкихъ, Греческихъ и
 Еврейскихъ шрифтовъ, сдѣланныхъ изъ
 самаго лучшаго матеріала. Печатныя и

12 Point Century Expanded Russian

Sold in Weight Fonts only

Общество Американскихъ Словолитниковъ
 рекомендуетъ свой богатый складъ
 Англійскихъ, Нѣмецкихъ, Греческихъ и
 Еврейскихъ шрифтовъ, сдѣланныхъ изъ
 самаго лучшаго матеріала. Печатныя и
 бумаго-рѣзные машины наилучшей
 конструкціи и всякіе типографическіе
 матеріалы по

12 Point Russian No. 10

Sold in Weight Fonts only

Общество Американскихъ Словолитниковъ
 рекомендуетъ свой богатый складъ
 Англійскихъ, Нѣмецкихъ, Греческихъ и
 Еврейскихъ шрифтовъ, сдѣланныхъ изъ
 самаго лучшаго матеріала. Печатныя и
 бумаго-рѣзные машины наилучшей
 конструкціи и всякіе типографическіе
 матеріалы по

12 Point Russian No. 10. Cast on Original Line.

ESPERANTO ACCENTS

8 Point No. 1 for Century Expanded
Per Font \$1 25

Ĉu vi scias kion povas fari Esperanto
 ĉe homo simploviva kaj ne inklina
 al eksterlandaj vojaĝoj? Ne? Aŭskultu do kion
 mi persone ĈĜĤĴŜŬĉĝĥĵŭ

8 Point No. 3 for Century Expanded
Italic. Per Font \$2 00

In 1903, mi ekdeziris viziti la
 europajn esperantistojn, sed mi ne havis
 sufiĉe da mono por pagi la transmaran
 vojaĝon. Tamen tio ĈĜĤĴŜŬĉĝĥĵŭ

8 Point No. 5 for Century Bold
Per Font \$1 25

Jes, alvenis tiu sento, kiu donas
 la veran fratamon al fremduloj,
 faras nian vividon brua kaj igas
 esperantiston propagandi eĉ ĈĜĤĴŜŬĉĝĥĵŭ

10 Point No. 2 for Century Expanded
Per Font \$1 50

Antaŭ nekalkuleblaj jaroj vivis
 maljunulo kaj maljunulino. La
 maljunulo, kiu havis ĈĜĤĴŜŬĉĝĥĵŭ

10 Point No. 4 for Century Expanded
Italic. Per Font \$2 25

Unu tagon, je la piedo de ia monto,
 la maljunulo renkontis la perditan
 birdon; kaj ĈĜĤĴŜŬĉĝĥĵŭ

10 Point No. 6 Century Bold
Per Font \$1 50

Tiam si demandis la edzon pri la vojo
 al la domo de la pasero, kaj ekiris
 je sia vojaĝo. ĈĜĤĴŜŬĉĝĥĵŭ

Type for Music Printers

EXCELSIOR MUSIC

Weight of smallest font, 15 pounds. Per pound \$3 60

THE STAR-SPANGLED BANNER

FRANCIS SCOTT KEY. 1814

Voices in unison

Oh, say, can you see, by the dawn's early light, What so proud-ly we hail'd at the

Musical score for 'The Star-Spangled Banner' in 3/4 time, key of B-flat major. The score is for voices in unison and piano accompaniment. The lyrics are: 'Oh, say, can you see, by the dawn's early light, What so proud-ly we hail'd at the'.

EXCELSIOR MUSIC No. 2

Weight of smallest font, 15 pounds. Per pound \$3 60

MY COUNTRY! 'TIS OF THEE

SAMUEL F. SMITH

H. CAREY

My country! 'tis of thee, Sweet land of lib - er - ty, Of thee I sing; Land where my

Musical score for 'My Country, 'Tis of Thee' in 3/4 time, key of B-flat major. The score is for voices and piano accompaniment. The lyrics are: 'My country! 'tis of thee, Sweet land of lib - er - ty, Of thee I sing; Land where my'.

EXCELSIOR MUSIC No. 3

Weight of smallest font, 15 pounds. Per pound \$3 60

Novello, or English Note

OLD HUNDRED

ISAAC WATTS

G. FRANC

Be - fore Je - ho-vah's aw - ful throne, Ye na - tions! bow with sa - cred joy:

Musical score for 'Old Hundred' in 4/4 time, key of D major. The score is for voices and piano accompaniment. The lyrics are: 'Be - fore Je - ho-vah's aw - ful throne, Ye na - tions! bow with sa - cred joy:'.

DIAMOND MUSIC No. 1

Weight of smallest font, 30 pounds. Per pound \$3 20

HOME, SWEET HOME

With expression

BISHOP

Mid pleas-ures and pal - a - ces though we may roam, Be it ev - er so

Musical score for 'Home, Sweet Home' in 2/4 time, key of B-flat major. The score is for voices and piano accompaniment. The lyrics are: 'Mid pleas-ures and pal - a - ces though we may roam, Be it ev - er so'.

AMERICAN TYPE FOUNDERS COMPANY
EVERYTHING FOR THE PRINTER

Type for Music Printers

DIAMOND MUSIC No. 2

Weight of smallest font, 30 pounds. Per pound \$3 20

ANNIE LAURIE

Tenderly

Max - wel - ton's braes are bon - nie, Where ear - ly fa's the dew,

The image shows a musical score for 'Annie Laurie' in G major and 3/4 time. It features a vocal line and a piano accompaniment. The tempo is marked 'Tenderly'. The lyrics are: 'Max - wel - ton's braes are bon - nie, Where ear - ly fa's the dew,'.

DIAMOND MUSIC No. 3

Weight of smallest font, 30 pounds. Per pound \$3 20

AULD LANG SYNE

ROBERT BURNS

CHORUS.

For auld lang syne, my dear, For auld lang syne;

The image shows a musical score for 'Auld Lang Syne' in G major and 3/4 time. It features a vocal line and a piano accompaniment. The tempo is marked 'CHORUS.'. The lyrics are: 'For auld lang syne, my dear, For auld lang syne;'. The score includes a key signature change to one sharp (F#) for the chorus.

DIAMOND MUSIC No. 4

Weight of smallest font, 30 pounds. Per pound \$3 20

Novello, or English Note

WATCH ON THE RHINE

WILHELM

Dear Fath - er - land, let peace be thine. Dear Fath - er - land, let peace be thine.

The image shows a musical score for 'Watch on the Rhine' in G major and 3/4 time. It features a vocal line and a piano accompaniment. The tempo is marked 'Novello, or English Note'. The lyrics are: 'Dear Fath - er - land, let peace be thine. Dear Fath - er - land, let peace be thine.'.

AGATE MUSIC No. 3

Weight of smallest font, 30 pounds. Per pound \$2 40

cantabile.

mf

The image shows a piano score for 'Agate Music No. 3' in G major and 3/4 time. The tempo is marked 'cantabile.'. The dynamic marking is 'mf'. The score consists of a single system with a treble and bass clef.

AMERICAN TYPE FOUNDERS COMPANY
EVERYTHING FOR THE PRINTER

AGATE MUSIC No. 3

Weight of Smaller Font, 30 pounds. Per pound \$2.40

VIVE L'AMERICA, HOME OF THE FREE

NONPAREIL MUSIC No. 3

Weight of smaller font, 30 pounds. Per pound \$2.00

EVER BE HAPPY

AMERICAN TYPE FOUNDERS COMPANY

EVERYTHING FOR THE PRINTER



Miscellaneous For Ordinary and
Extraordinary Uses

Types and Characters

Accents
Body Type Sundries
Footnote Indicators
Metal Braces and Dashes
Piece Fractions
Special Signs
Signs and Definitions
Imprints
Parentheses and Brackets
Per Cent and Cent Marks
Time-Table Figures
Job Type Fractions
Advertising Figures
Calendar Figures
Baseball Blanks
Card Pips
Stars and Crosses
Weather Indicators
Election Signs
Paragraph Marks
Etc., etc.

American Type Founders Company

Footnote Indicators and Calendar Figures

FOOTNOTE INDICATORS

Footnote Indicators were designed particularly for use in railroad work and tariff sheets, but may also be used for reference marks whenever required. Footnote Indicators may be used in place of asterisks, daggers, etc.

12 Point Footnote Indicators

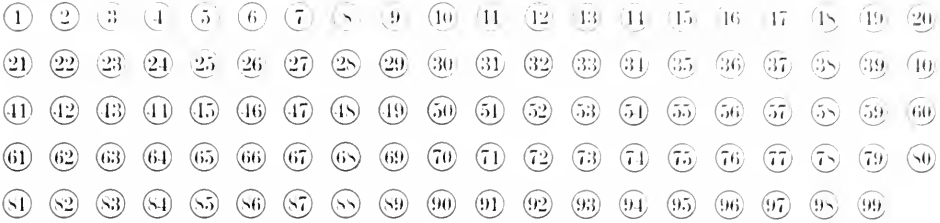

10 Point Footnote Indicators

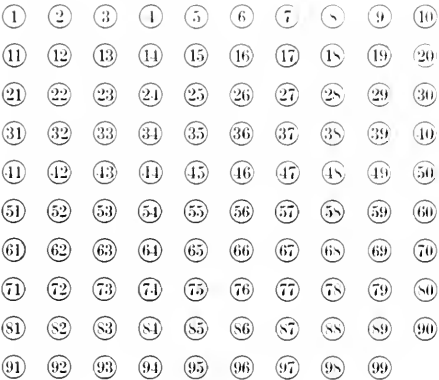

Scheme and Price of Footnote Indicators

6 Point No. 615	30 each, characters 1 to 6, inc. / 25 each, characters 7 to 15, inc.	\$1 00
6 Point No. 630	30 each, characters 16 to 21, inc. / 25 each, characters 22 to 30, inc.	1 00
6 Point No. 650	22 each, characters 31 to 42, inc. / 21 each, characters 43 to 50, inc.	1 00
6 Point No. 675	18 each, characters 51 to 57, inc. / 17 each, characters 58 to 75, inc.	1 00
6 Point No. 699	18 each, characters 76 to 99, inc.	1 00
8 Point No. 815	22 each, characters 1 to 9, inc. / 21 each, characters 10 to 15, inc.	1 00
8 Point No. 830	22 each, characters 16 to 24, inc. / 21 each, characters 25 to 30, inc.	1 00
8 Point No. 850	17 each, characters 31 to 34, inc. / 16 each, characters 35 to 50, inc.	1 00
8 Point No. 875	13 each, characters 51 to 74, inc. / 12, character 75	1 00
8 Point No. 899	14 each, characters 76 to 87, inc. / 13 each, characters 88 to 99, inc.	1 00
10 Point No. 1015	18 each, characters 1 to 3, inc. / 17 each, characters 4 to 15, inc.	1 00
10 Point No. 1030	18 each, characters 16 to 18, inc. / 17 each, characters 19 to 30, inc.	1 00
10 Point No. 1050	13 each, characters 31 to 48, inc. / 12 each, characters 49 to 50, inc.	1 00
10 Point No. 1075	11 each, characters 51 to 58, inc. / 10 each, characters 59 to 75, inc.	1 00
10 Point No. 1099	11 each, characters 76 to 93, inc. / 10 each, characters 94 to 99, inc.	1 00
12 Point No. 1215	12 each, characters 1 to 15, inc.	1 00
12 Point No. 1230	12 each, characters 16 to 30, inc.	1 00
12 Point No. 1250	9 each, characters 31 to 50, inc.	1 00
12 Point No. 1275	8 each, characters 51 to 55, inc. / 7 each, characters 56 to 75, inc.	1 00
12 Point No. 1299	8 each, characters 76 to 87, inc. / 7 each, characters 88 to 99, inc.	1 00

8 Point Footnote Indicators

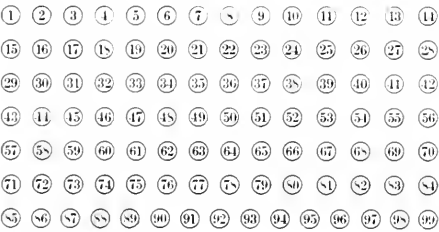

6 Point Footnote Indicators



MINIATURE CALENDAR FIGURES

These Calendar Figures make a very attractive calendar on blotters and for a multiplicity of commercial requirements. Many printers make a specialty of monthly blotters and other advertising forms which carry a calendar, and will readily appreciate the fact that these new figures will impart a distinctiveness to all such printing.

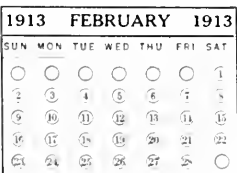

12 Point Calendar No. 1, per font \$1 25
 10 Point Calendar No. 1, per font 1 00
 8 Point Calendar No. 1, per font 1 00
 6 Point Calendar No. 1, per font 1 00

Miniature Calendar Figures are put up in usable fonts containing sufficient for yearly calendars in the 6 Point size, and for six months in the 8, 10 and 12 Point sizes, including blank circles.

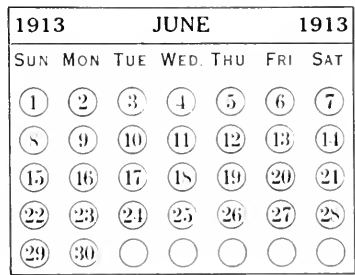

Accented Letters for Modern Languages

REGARDING OUR ACCENTED LETTERS

So great is the variety of accented letters made by the American Type Founders Company that it is impracticable to attempt to list the individual characters in this catalogue. Such a list would necessarily be incomplete before this book was off the press, because important additions are being made almost daily. The list printed herewith is therefore limited to the type faces shown in this specimen book for which accented letters are made. A complete list of accents for these and other faces is published by the American Type Founders Company in loose leaf form, for which a suitable leather cover is provided, and may be obtained from any of our Selling Houses, for temporary use, or the accent list may be purchased outright for \$2.00. This price includes the mailing of changes and additions as made from time to time. To those having considerable use for accents this book will be found a great convenience.

ACCENTED LETTERS USED IN VARIOUS MODERN LANGUAGES

<p>Bohemian Á Ě Í Ó Ú Ů Ý Ě Ć Ď Ň Ř Š Ť Ž á ě í ó ú ů ý ě ě ě ě ř š ť ž</p>	<p>German Ä Ö Ü ä ö ü</p>	<p>Polish Ó Ą Ę Ć Ł Ń Ś Ź Ż ó ą ę ć ł ń ś ź ż</p>
<p>Dutch Ÿ ŷ</p>	<p>Hungarian Á Ę Í Ó Ú Ő Ű Ö Ū á ę í ó ú ő ű ö ū</p>	<p>Portuguese Á Ę Í Ó Ú Ũ Ê Õ Ç Æ Õ Ñ á ę í ó ú ù ê õ ç æ õ ñ</p>
<p>French Ê Ä È Ì Ò Ù Ä Æ Î Õ Û Ä È Ì Ò Û Ç ê ä è ì ò ù ä æ î õ ù ä è ì ò ù ç</p>	<p>Italian Á Ę Í Ó Ú Ä È Ì Ò Û Î Õ á ę í ó ú ä è ì ò ù î õ</p>	<p>Spanish Á Ę Í Ó Ú Ñ Æ Í Ó Ú Ñ á ę í ó ú ñ æ í ó ú ñ</p>
	<p>Norwegian and Danish Æ æ Ø ø</p>	<p>Swedish Å Ö Ä å ö ä</p>

TABLE OF NUMBERS DESIGNATING ACCENTED LETTERS

Each accented letter is designated by an invariable number irrespective of face or size, as shown in the table below. In ordering it is only necessary to state the number of the accented letter and the name and size of the face.

NUMBER	ACCENT	NUMBER	ACCENT	NUMBER	ACCENT	NUMBER	ACCENT	NUMBER	ACCENT	NUMBER	ACCENT	NUMBER	ACCENT	NUMBER	ACCENT	NUMBER	ACCENT
1	á	101	Á	201	Á	18	ÿ	118	Ÿ	218	Ÿ	51	ø	151	Ø	251	ø
2	é	102	É	202	É	19	â	119	Â	219	Â	52	ç	152	Ç	252	ç
3	í	103	Í	203	Í	20	ê	120	Ê	220	Ê	54	ö	154	Ö	254	ö
4	ó	104	Ó	204	Ó	21	í	121	Î	221	Î	55	ü	155	Ü	255	ü
5	ú	105	Ú	205	Ú	22	ô	122	Ô	222	Ô	58	ą	158	Ą	258	ą
6	ý	106	Ý	206	Ý	23	û	123	Û	223	Û	59	ę	159	Ę	259	ę
7	à	107	À	207	À	37	č	137	Č	237	Č	60	ć	160	Ć	260	ć
8	è	108	È	208	È	38	ď	138	Ď	238	Ď	61	ł	161	Ł	261	ł
9	ì	109	Ì	209	Ì	39	ě	139	Ě	239	Ě	62	ń	162	Ń	262	ń
10	ò	110	Ò	210	Ò	41	ň	141	Ň	241	Ň	63	ś	163	Ś	263	ś
11	ù	111	Ù	211	Ù	42	ř	142	Ř	242	Ř	64	ž	164	Ž	264	ž
13	ä	113	Ä	213	Ä	43	š	143	Š	243	Š	65	ź	165	Ź	265	ź
14	ë	114	Ë	214	Ë	44	ț	144	Ț	244	Ț	70	ā	170	Ā	270	ā
15	ï	115	Ï	215	Ï	45	ű	145	Ű	245	Ű	73	ō	173	Ō	273	ō
16	ö	116	Ö	216	Ö	47	ž	147	Ž	247	Ž	79	ñ	179	Ñ	279	ñ
17	ü	117	Ü	217	Ü	50	æ	150	Æ	250	Æ	80	å	180	Å	280	å

All accents for capitals, small capitals and lower case shown in the above table are made for the following type faces in the size noted.

- Century Bold—Caps and Lower Case: 6, 8, 10, 12, 14, 18, 24, 30, 36, 42 and 48 Point.
- Century Expanded—Caps, Lower Case and Small Caps: 6, 8, 10, 12, 14 and 18 Point.
- Century Expanded Italic—Caps and Lower Case: 6, 8, 10, 12, 14 and 18 Point.
- Century Oldstyle—Caps, Lower Case and Small Caps: 6, 8, 10, 12, 14 and 18 Point.
- Century Oldstyle Italic—Caps and Lower Case: 24, 30, 36, 42 and 48 Point.
- Century Oldstyle Bold—Caps and Lower Case: 6, 8, 10, 12, 14, 18, 24, 30, 36 and 48 Point.
- Century Oldstyle Italic—Caps and Lower Case: 6, 8, 10, 12, 14, 18, 24, 30, 36, 42 and 48 Point.

- Cheltenham Bold—Caps and Lower Case: 6, 8, 10, 12, 14, 18, 24, 30, 36, 42 and 48 Point.
- Cheltenham Bold Condensed—Caps and Lower Case: 6, 8, 10, 12, 14, 18, 24, 30, 36, 42 and 48 Point.
- Cheltenham Bold Extended—Caps and Lower Case: 6, 8, 10, 12, 14, 18, 24, 30, 36, 42 and 48 Point.
- Cheltenham Bold Extra Condensed—Caps and Lower Case: 6, 8, 10, 12, 14, 18, 24, 30, 36, 42 and 48 Point.
- Cheltenham Oldstyle—Caps and Lower Case: 6, 8, 10, 12, 14, 18, 24, 30, 36, 42 and 48 Point.
- Cheltenham Wide—Caps and Lower Case: 6, 8, 10, 12, 14, 18, 24, 30, 36, 42 and 48 Point.

Our complete list of piece accents for job and body type faces will be found on page 914

Accented Letters for Modern Languages

SOME TYPE FACES FOR WHICH NUMEROUS ACCENTED LETTERS ARE MADE

In addition to the list given on the preceding page, the American Type Foundry Company makes an exceptionally liberal number of Accented Letters for its extensive line of popular type faces as is shown by the schedule below. As additions to these faces are also constantly being made the Loose Leaf Accent Book should be consulted when ordering.

- Adver Condensed**—Caps and Lower Case: 8, 10, 12, 14, 18, 24, 30, 36 and 48 Point.
- American Extra Condensed**—Caps and Lower Case: 12, 14, 18, 24, 30, 36, 42, 48, 54, 60 and 72 Point.
- Blair**—Caps: 6 and 12 Point.
- Bookman Oldstyle**—Caps and Lower Case: 6, 8, 9, 10, 12, 14, 18, 20, 24, 30, 36, 48, 60 and 72 Point.
- Clearface Bold**—Caps and Lower Case: 6, 8, 10, 12, 14, 18, 24, 30, 36, 42 and 48 Point.
- Compact**—Caps and Lower Case: 8, 10, 12, 14, 18, 24, 30, 36, 42, 48, 60 and 72 Point.
- Curtis Post**—Caps and Lower Case: 12, 14, 18, 24, 30, 36, 42 and 48 Point.
- Della Robbia**—Caps and Lower Case: 6, 8, 10, 12, 14 and 18 Point.
- Engravers Old English**—Caps and Lower Case: 6, 8, 10, 12, 14, 18, 24, 30, 36, 42, 48, 60 and 72 Point.
- Heavy Caslon**—Caps and Lower Case: 6, 8, 10, 12, 14 and 18 Point.
- Light Dorsey**—Caps and Lower Case: 5, 6, 8, 10, 12, 14 and 18 Point.
- Lining Boldface No. 520**—Caps and Lower Case: 5½, 6, 7, 8, 9, 10, 11 and 12 Point.
- Lining Boldface Italic No. 520**—Caps and Lower Case: 6, 8, 9, 10, 11 and 12 Point.
- Lining Caslon No. 540**—Caps and Lower Case: 6, 8, 10, 12 and 14 Point.
- Lining Condensed Title No. 523**—Caps and Lower Case: 5, 6, 8, 10, 12, 18, 24 and 30 Point.
- Lining DeVenne No. 2**—Caps and Lower Case: 5½, 6, 8, 10, 12, 18, 24, 30, 36, 48, 54, 60 and 72 Point.
- Lining DeVenne Condensed No. 2**—6, 8, 10, 12, 14, 18, 24, 30, 36, 42 and 48 Point.
- Lining French Oldstyle No. 552**—Caps, Lower Case and Small Caps: 6, 8, 9, 10, 12 and 18 Point.
- Lining Gothic No. 544**—Caps and Lower Case: 6, 8, 10, 12, 14, 18, 24, 30, 36, 42 and 48 Point.
- Lining Gothic No. 545**—Caps and Lower Case: 6, 8, 9, 10, 12, 14, 18, 24, 30, 36, 42, 48, 54 and 60 Point.
- Lining Gothic Condensed No. 523**—Caps and Lower Case: 6, 8, 10, 12, 18, 30 and 36 Point.
- Lining Gothic Condensed No. 529**—Caps and Lower Case: 12, 14, 18, 24, 30, 60 and 72 Point.
- Lining Oldstyle No. 523**—Caps, Lower Case and Small Caps: 5, 5½, 6, 8, 10 and 12 Point.
- Lining Oldstyle Italic No. 523**—Caps and Lower Case: 5, 5½, 6, 8, 10 and 12 Point.
- Lining Oldstyle No. 550**—Caps, Lower Case and Small Caps: 6, 7, 8, 9, 10 and 12 Point.
- Lining Oldstyle Italic No. 550**—Caps and Lower Case: 6, 7, 8, 9, 10 and 12 Point.
- Lining Oldstyle Antique No. 560**—Caps and Lower Case: 6, 8, 9, 10, 12, 14, 18, 20, 24, 30, 36, 48, 60 and 72 Point.
- Lining Roman No. 510**—Caps, Lower Case and Small Caps: 6, 8, 10, 11 and 12 Point.
- Lining Roman No. 524**—Caps and Lower Case: 6 Point.
- Lining Roman No. 527**—Caps and Lower Case: 5 and 5½ Point.
- Lining Ronaldson Oldstyle No. 551**—Caps, Lower Case and Small Caps: 6, 7, 8, 9, 10, 11, 12 and 14 Point.
- Lining Ronaldson Oldstyle Italic No. 551**—Caps and Lower Case: 6, 7, 8, 9, 10, 11 and 12 Point.
- Lining Schoeffer Oldstyle No. 2**—Caps and Lower Case: 8, 10, 12, 14, 18, 24, 30, 36 and 48 Point.
- MacFarland**—Caps and Lower Case: 6, 7, 8, 9, 10, 11, 12, 14, 16, 18, 20, 24, 30 and 36 Point.
- MacFarland Italic**—Caps and Lower Case: 6, 8, 9, 10, 12, 14, 16, 18, 20, 24 and 30 Point.
- New Caslon**—Caps and Lower Case: 5, 6, 8, 10, 12, 14 and 18 Point.
- New Caslon Italic**—Caps and Lower Case: 6, 8, 10, 12, 14 and 18 Point.
- New Model Remington Typewriter**—Caps and Lower Case: 12 Point.
- New Model Smith Premier Typewriter**—Caps and Lower Case: 12 Point.
- Oliver Typewriter**—Caps and Lower Case: 12 Point.
- Post Condensed**—Caps and Lower Case: 6, 8, 10, 12, 14, 18, 24, 30, 36, 42 and 48 Point.
- Post Monotone**—Caps and Lower Case: 5 on 6, 6, 8, 10, 12, 14, 18, 24, 30 and 36 Point.
- Post Monotone No. 2**—Caps and Lower Case: 6, 8, 10, 12, 14, 18, 24, 30 and 36 Point.
- Post Oldstyle Italic**—Caps and Lower Case: 6, 8, 10, 12, 14, 18, 24, 30, 36, 48 and 60 Point.
- Post Oldstyle Roman No. 1**—Caps and Lower Case: 6, 8, 10, 12, 14, 18, 24, 30, 36, 42 and 48 Point.
- Post Oldstyle Roman No. 2**—Caps and Lower Case: 6, 8, 10, 12, 14, 18, 24, 30, 36, 42 and 48 Point.
- Recut Caslon**—Caps and Lower Case: 6, 8, 10, 12, 14 and 18 Point.
- Recut Caslon Italic**—Caps and Lower Case: 6, 8, 10, 12, 14 and 18 Point.
- Ribbonface Typewriter**—Caps and Lower Case: 12 Point.
- Scotch Roman**—Caps and Lower Case: 6, 8, 10, 11, 12 and 14 Point.
- Scotch Roman Italic**—Caps and Lower Case: 6, 8, 10, 12 and 14 Point.
- Shaded Title Litho**—Caps: 6, 12 and 24 Point.
- Stenograf**—Caps and Lower Case: 12 Point.
- Typo Script**—Caps and Lower Case: 14, 18, 21, 30, 36, 48 and 60 Point.
- Typo Script Extended**—Caps and Lower Case: 12, 14, 18, 21, 30, 36, 48 and 60 Point.
- Typo Slope**—Caps and Lower Case: 12, 14, 18, 21, 30, 36 and 48 Point.
- Typo Text**—Caps and Lower Case: 8, 10, 12, 14, 18 and 24 Point.

Price List of Fonts of Accented Letters for Various Languages

POINT	BROOKLYN DANISH	FRENCH FRENCH ONLY	GERMAN ITALIAN	PORTUGUESE SWEDISH	SLOVENIAN SPANISH	FRENCH FRENCH ONLY	HUNGARIAN	HUNGARIAN	RUSSIAN	
5.....	\$0.20	\$0.20	\$0.20	\$0.20	\$0.20	\$0.35	\$0.35	\$0.50	\$0.50	\$0.50
5½.....	.20	.20	.20	.20	.20	.35	.35	.50	.50	.50
6.....	.20	.20	.20	.20	.20	.35	.35	.50	.50	.50
7.....	.25	.25	.25	.25	.25	.40	.40	.55	.55	.55
8.....	.25	.25	.25	.25	.25	.40	.40	.55	.55	.55
9.....	.25	.25	.25	.25	.25	.45	.45	.60	.60	.60
10.....	.25	.25	.25	.25	.25	.45	.45	.60	.60	.60
11.....	.30	.30	.30	.30	.30	.50	.50	.65	.65	.65
12.....	.30	.30	.30	.30	.30	.50	.50	.65	.65	.65
14.....	.30	.30	.30	.30	.30	.55	.55	.75	.75	.75
16.....	.30	.30	.30	.30	.30	.55	.55	.75	.75	.75
18.....	.35	.35	.35	.35	.35	.60	.60	.85	.85	.85
20.....	.35	.35	.35	.35	.35	.60	.60	.85	.85	.85
24.....	.40	.40	.40	.40	.40	.70	.70	1.00	1.00	1.00
30.....	.50	.50	.50	.50	.50	.85	.85	1.15	1.15	1.15
36.....	.60	.60	.60	.60	.60	1.00	1.00	1.35	1.35	1.35
42.....	.75	.75	.75	.75	.75	1.25	1.25	1.75	1.75	1.75
48.....	.85	.85	.85	.85	.85	1.50	1.50	2.10	2.10	2.10
Larger.....	10% of the list price of the font					20% of the list price of the font.		30% of the list price of the font.		

Our complete list of piece accents for job and body type faces will be found on page 914

Body Type Sundries

REFERENCES No. 1

En Set except Fists

18 Point Per lb. font \$0 50

14 Point Per lb. font \$0 50

12 Point Per lb. font \$0 52

11 Point Per lb. font \$0 55

10 Point Per lb. font \$0 56

9 Point Per lb. font \$0 60

8 Point Per lb. font \$0 64

7 Point Per lb. font \$0 69

6 Point Per lb. font \$0 79

COMMERCIAL MARKS No. 1

Em Set except Cent Mark

18 Point Per lb. font \$0 50

14 Point Per lb. font \$0 50

12 Point Per lb. font \$0 52

11 Point Per lb. font \$0 55

10 Point Per lb. font \$0 56

9 Point Per lb. font \$0 60

8 Point Per lb. font \$0 64

7 Point Per lb. font \$0 69

6 Point Per lb. font \$0 79

BRACES AND DASHES No. 1

18 Point Per lb. font \$0 50

9 Point Per lb. font \$0 60

14 Point Per lb. font \$0 50

8 Point Per lb. font \$0 64

12 Point Per lb. font \$0 52

7 Point Per lb. font \$0 69

11 Point Per lb. font \$0 55

6 Point Per lb. font \$0 79

10 Point Per lb. font \$0 56

5½ Point Per lb. font \$0 92

5 Point Per lb. font \$1 05

For many years the American Type Founders Company has enjoyed the reputation of making a most complete and satisfactory line of Body Type Sundries as well as the very best Body Type and Job Type Faces

Body Type Sundries

AMERICAN LINE LEADERS

AMERICAN LINE LEADERS SERIES 541

	One Dot to the Em	PER POUND
5 Point		\$1 05
5½ Point		\$0 92
6 Point		\$0 79
7 Point		\$0 69
8 Point		\$0 64
9 Point		\$0 60
10 Point		\$0 56
11 Point		\$0 55
12 Point		\$0 52
14 Point		\$0 50
18 Point		\$0 50

AMERICAN LINE LEADERS SERIES 543

	Three Dots to the Em	PER POUND
5 Point		\$1 05
5½ Point		\$0 92
6 Point		\$0 79
7 Point		\$0 69
8 Point		\$0 64
9 Point		\$0 60
10 Point		\$0 56
11 Point		\$0 55
12 Point		\$0 52
14 Point		\$0 50
18 Point		\$0 50

AMERICAN LINE LEADERS SERIES 542

	Two Dots to the Em	PER POUND
5 Point		\$1 05
5½ Point		\$0 92
6 Point		\$0 79
7 Point		\$0 69
8 Point		\$0 64
9 Point		\$0 60
10 Point		\$0 56
11 Point		\$0 55
12 Point		\$0 52
14 Point		\$0 50
18 Point		\$0 50

AMERICAN LINE LEADERS SERIES 544

	Fine Hyphen Face	PER POUND
6 Point		\$0 79
7 Point		\$0 69
8 Point		\$0 64
9 Point		\$0 60
10 Point		\$0 56
11 Point		\$0 55
12 Point		\$0 52
14 Point		\$0 50
18 Point		\$0 50

AMERICAN LINE LEADERS SERIES 545

Hyphen Face

	PER POUND		PER POUND
5 Point	\$1 05	10 Point	\$0 56
5½ Point	\$0 92	11 Point	\$0 55
6 Point	\$0 79	12 Point	\$0 52
7 Point	\$0 69	14 Point	\$0 50
8 Point	\$0 64	18 Point	\$0 50
9 Point	\$0 60		

The American Line Leaders herewith shown are the only correctly proportioned and accurately cut Leaders ever designed and cast. These have been cut in five distinct series, with a uniformity and harmony in the grading of the different sizes which will be appreciated by discriminating printers. This perfection has been attained only through the use of newly invented tools belonging exclusively to the American Type Foundry Company. On this page is an impression of each size of the five styles. These Leaders are cast from Copper Alloy type metal, which excels all other makes in lightness and in wearing qualities. For the special convenience of printers they are put up in job fonts of three and five pounds and sold at regular body type rates, the same as charged when ordered in bulk. The American Line Leaders line accurately with all American Line faces cast on larger or smaller bodies by justification with point leads and slugs. A practical illustration is given on the following page.

Body Type Sundries

AMERICAN LINE LEADERS

Examples showing how our Leaders print

Specimen of 12 Point American Line Leaders No. 541 signed with 18 Point 500 Point Copperplate

Shipped, in good order by _____ on board steamer
Copper Alloy, of American Line, articles as numbered below to be delivered
in good order to _____
at the port of _____ or his heirs or assigns,
_____ to pay the rate of _____ and charges \$ _____
Dated at _____ this _____ day of _____ 1912.

Specimen of 12 Point American Line Leaders No. 541 used with
12 Point Lining Caslon Italic No. 540

Hungarians Keler Bela
Clover Blossom Rogers
Serenade Beethoven
Who is Sylvia Schubert

Specimen of 12 Point American Line Leaders No. 541 used with
12 Point Century Oldstyle Italic

Allegro Mattei
Mattinata Nieniewski
Night Hymns Thomas
Leave Not Bullard

Specimen of 10 Point American Line Leaders No. 542 used with
10 Point Cheltenham Oldstyle

Maiden's Lament Scarlati
Mazurka in B Minor Saint Saens
Mandalay A. G. Thomas
Voci Di Primavera Strauss

Specimen of 10 Point American Line Leaders No. 543 used with
10 Point Clearface

Son of the Puzta Dillon
Sunset Elizabeth Coolidge
The Podsnap Hunt Hammel
Le Cygne Sir Harry Hoguet

Specimen of 8 Point American Line Leaders No. 541 used with
8 Point Della Robbia

Planet Venus February 14
La Champagne March 17
Montauk Point October 19
Virginian November 21

Specimen of 8 Point American Line Leaders No. 541 used with
8 Point Century Expanded

The Year's at the Spring Haydn
'Neath the Stars Sinzlee
Presto in E Major Beethoven
Fifth Nocturne Leybach

Specimen of 6 Point American Line Leaders No. 543 used with
6 Point Roman No. 590

Benefits of the Kindergarten Chickering
The Modern Child Lillian A. Robinson
Some Curious Information Grace Howard
American Husbands Kathie H. Porter

Specimen of 6 Point American Line Leaders No. 543 used with
6 Point Cheltenham Medium

Domestic Economy Mary Ottman Bates
Inventions of the Century Ramage
The Servant Question Rachel Lowentritt
Personation Alice Elizabeth Moran

Braces, Dashes, Fraction Marks and Canceled Figures

THREE POINT NEW METAL BRACES

Per dozen of any one size \$0 60										Per font \$1 25
3 Point	312	315	318	321	324	327	330	333	336	339
	342		348		351		354		360	366
	369		372		378		384			
	387		390				396			

Made in 12, 15, 18, 21, 24, 27, 30, 33, 36, 39, 42, 48, 51, 54, 60, 66, 69, 72, 78, 84, 87, 90 and 96 Point lengths
The last two figures of each number indicate the length of Brace in points

FOUR POINT NEW METAL BRACES

Per dozen of any one size \$0 60										Per font \$1 25
4 Point	412	416	420	424	428	432	436	440	444	448
	452		456		460		464		468	
	472		480		484					
	488		496							

Made in 12, 16, 20, 24, 28, 32, 36, 40, 44, 48, 52, 56, 60, 64, 68, 72, 80, 84, 88 and 96 Point lengths
The last two figures of each number indicate the length of Brace in points

SIX POINT NEW METAL BRACES

Per dozen of any one size \$0 50										Per font \$1 00
6 Point	612	618	624	630	636	642	648	654		
	660		666		672		678			
	684		690		696					

Made in 12, 18, 24, 30, 36, 42, 48, 54, 60, 66, 72, 78, 84, 90 and 96 Point lengths
The last two figures of each number indicate the length of Brace in points

SIX POINT METAL BRACES

Per dozen of any one size \$0 50										Per font \$1 00
6 Point	1	2	3	4	5	6				

Font contains six of each. The number also indicates the length of each Brace in 12 Point ems

SIX POINT BRACES AND DASHES No. 2

Per font \$1 25										
6 Point	1	2	3	4	5	6	7	8	10	11
		9		12						

Font contains eight each Nos. 1 to 7, four each Nos. 8 to 12
Nos. 1 to 7 are for piecing. Nos. 8, 9, 10, 11 and 12 are complete and are 2, 3, 4, 5 and 6 ems respectively

DIAGONAL FRACTION MARKS

Font containing three sizes	\$0 75	
12 Point	9 Point	6 Point
//////	//////	//////

Examples

$5\frac{1}{2}$ $8\frac{3}{8}$ $2\frac{7}{8}$ $24\frac{1}{100}$

$3\frac{4}{5}$ $2\frac{3}{8}$ $1\frac{1}{2}$ $3\frac{1}{4}$ $15\frac{1}{100}$

$5\frac{1}{2}$ $8\frac{7}{8}$ $4\frac{2}{3}$ $5\frac{3}{4}$ $7\frac{3}{4}$ $150\frac{1}{1000}$

CANCELED FIGURES

11 Point No. 40	Per font \$1 00
1 2 3 4 5 6 7 8 9 0	

10 Point No. 40	Per font \$1 00
1 2 3 4 5 6 7 8 9 0	

9 Point No. 40	Per font \$1 00
1 2 3 4 5 6 7 8 9 0	

8 Point No. 40	Per font \$1 00
1 2 3 4 5 6 7 8 9 0	

Radical Signs and Piece Fractions

SPECIAL RADICAL SIGNS

Notice. These Special Radical Signs are cast so that ordinary two-point single size will join at the top and line with them, as is shown in the following specimens:

5 Point	Per font \$2 80	10 Point > 20 Point	Per font \$1 30
$\sqrt{2}$ $\sqrt{3}$ $\sqrt{4}$ $\sqrt{5}$ $\sqrt{6}$		$\sqrt{7}$ $\sqrt{8}$ $\sqrt{9}$ $\sqrt{10}$ $\sqrt{11}$ $\sqrt{12}$	735 394
6 Point	Per font \$2 00		$\sqrt{13}$ $\sqrt{14}$ $\sqrt{15}$ $\sqrt{16}$ $\sqrt{17}$ $\sqrt{18}$
$\sqrt{2}$ $\sqrt{3}$ $\sqrt{4}$ $\sqrt{5}$ $\sqrt{6}$		10 Point > 24 Point	Per font \$1 30
8 Point	Per font \$1 60	$\sqrt{7}$ $\sqrt{8}$ $\sqrt{9}$ $\sqrt{10}$ $\sqrt{11}$ $\sqrt{12}$	724 + 60
$\sqrt{2}$ $\sqrt{3}$ $\sqrt{4}$ $\sqrt{5}$ $\sqrt{6}$	$\sqrt{13}$ $\sqrt{14}$ $\sqrt{15}$ $\sqrt{16}$ $\sqrt{17}$ $\sqrt{18}$	10 Point > 26 Point	Per font \$1 30
10 Point	Per font \$1 30	$\sqrt{7}$ $\sqrt{8}$ $\sqrt{9}$ $\sqrt{10}$ $\sqrt{11}$ $\sqrt{12}$	$\sqrt{19}$ $\sqrt{20}$ $\sqrt{21}$ $\sqrt{22}$ $\sqrt{23}$ $\sqrt{24}$
$\sqrt{2}$ $\sqrt{3}$ $\sqrt{4}$ $\sqrt{5}$ $\sqrt{6}$	$\sqrt{13}$ $\sqrt{14}$ $\sqrt{15}$ $\sqrt{16}$ $\sqrt{17}$ $\sqrt{18}$	12 Point > 36 Point	Per font \$1 20
12 Point	Per font \$1 20	$\sqrt{7}$ $\sqrt{8}$ $\sqrt{9}$ $\sqrt{10}$ $\sqrt{11}$ $\sqrt{12}$	$\sqrt{25}$ $\sqrt{26}$ $\sqrt{27}$ $\sqrt{28}$ $\sqrt{29}$ $\sqrt{30}$
$\sqrt{2}$ $\sqrt{3}$ $\sqrt{4}$ $\sqrt{5}$ $\sqrt{6}$	$\sqrt{13}$ $\sqrt{14}$ $\sqrt{15}$ $\sqrt{16}$ $\sqrt{17}$ $\sqrt{18}$	14 Point > 44 Point	Per font \$1 20
10 Point x 14 Point	Per font \$1 30	$\sqrt{7}$ $\sqrt{8}$ $\sqrt{9}$ $\sqrt{10}$ $\sqrt{11}$ $\sqrt{12}$	$\sqrt{31}$ $\sqrt{32}$ $\sqrt{33}$ $\sqrt{34}$ $\sqrt{35}$ $\sqrt{36}$
$\sqrt{2}$ $\sqrt{3}$ $\sqrt{4}$ $\sqrt{5}$ $\sqrt{6}$		14 Point x 48 Point	Per font \$1 30
10 Point x 16 Point	Per font \$1 30	$\sqrt{7}$ $\sqrt{8}$ $\sqrt{9}$ $\sqrt{10}$ $\sqrt{11}$ $\sqrt{12}$	$\sqrt{37}$ $\sqrt{38}$ $\sqrt{39}$ $\sqrt{40}$ $\sqrt{41}$ $\sqrt{42}$
$\sqrt{2}$ $\sqrt{3}$ $\sqrt{4}$ $\sqrt{5}$ $\sqrt{6}$		14 Point > 48 Point	Per font \$1 20
		$\sqrt{7}$ $\sqrt{8}$ $\sqrt{9}$ $\sqrt{10}$ $\sqrt{11}$ $\sqrt{12}$	$\sqrt{43}$ $\sqrt{44}$ $\sqrt{45}$ $\sqrt{46}$ $\sqrt{47}$ $\sqrt{48}$

SELF SPACING PIECE FRACTIONS

These fonts are supplied with spaces and can be used with any type

12 Point Self Spacing Oldstyle No. 25	Per font \$2 50
12 ¹¹ / ₃₂ 1234567890 1234567890 1234567890 1234567890 1234567890 49 ⁵ / ₁₆	
11 Point Self Spacing Oldstyle No. 25	Per font \$2 50
24 ¹¹ / ₃₂ 1234567890 1234567890 3 ₇ 4 ₅ 1234567890 1234567890 18 ⁷ / ₁₆	
10 Point Self Spacing Oldstyle No. 21	Per font \$2 50
90 ¹⁹ / ₃₂ 1234567890 1234567890 5 ₁₀ 1 ₃ 1234567890 1234567890 94 ⁵ / ₁₆	
9 Point Self Spacing Oldstyle No. 28	Per font \$2 50
73 ¹³ / ₃₂ 1234567890 1234567890 1 ₅ 2 ₅ 3 ₆ 4 ₉ 3 ₁₀ 1234567890 1234567890 37 ⁹ / ₁₆	
8 Point Self Spacing Oldstyle No. 22	Per font \$2 50
24 ¹² / ₅₅ 1234567890 1234567890 1 ₄ 1 ₂ 2 ₃ 4 ₅ 5 ₈ 7 ₈ 8 ₉ 7 ₂₀ 1234567890 1234567890 56 ² / ₁₆	
6 Point Self Spacing Oldstyle No. 27	Per font \$2 50
42 ¹¹ / ₃₂ 1234567890 1234567890 1 ₃ 2 ₃ 1 ₄ 1 ₂ 3 ₄ 1 ₈ 5 ₈ 7 ₈ 3 ₆ 5 ₆₅ 1234567890 1234567890 33 ¹ / ₁₆	
12 Point Self Spacing Roman No. 31 ¹ / ₂	Per font \$2 50
60 ²⁰ / ₃₂ 1234567890 1234567890 1234567890 1234567890 1234567890 14 ⁹ / ₁₆	
11 Point Self Spacing Roman No. 21 ¹ / ₂	Per font \$2 50
45 ¹¹ / ₃₂ 1234567890 1234567890 1234567890 1234567890 1234567890 21 ⁸ / ₁₆	
10 Point Self Spacing Roman No. 17 ¹ / ₂	Per font \$2 50
72 ¹³ / ₃₂ 1234567890 1234567890 2 ₉ 4 ₅ 1234567890 1234567890 36 ⁷ / ₁₆	
9 Point Self Spacing Roman No. 32 ¹ / ₂	Per font \$2 50
32 ¹² / ₃₂ 1234567890 1234567890 2 ₃ 4 ₅ 5 ₆ 7 ₈ 9 ₁₀ 1234567890 23 ⁸ / ₁₆	
8 Point Self Spacing Roman No. 18 ¹ / ₂	Per font \$2 50
19 ¹¹ / ₃₂ 1234567890 1234567890 1 ₈ 3 ₅ 5 ₆ 6 ₇ 7 ₁₀ 9 ₂₀ 10 ₂₀ 1234567890 1234567890 84 ⁵ / ₁₆	
7 Point Self Spacing Roman No. 23 ¹ / ₂	Per font \$2 50
39 ¹¹ / ₁₆ 1234567890 1234567890 1 ₆ 2 ₃ 3 ₅ 5 ₆ 6 ₇ 7 ₈ 8 ₉ 9 ₁₀ 10 ₁₁ 15 ₃₆ 1234567890 1234567890 93 ² / ₁₆	
6 Point Self Spacing Roman No. 20 ¹ / ₂	Per font \$2 50
20 ²⁰ / ₈₈ 1234567890 1234567890 1 ₃ 2 ₃ 1 ₄ 3 ₅ 5 ₆ 6 ₇ 7 ₈ 8 ₉ 9 ₁₀ 10 ₁₁ 11 ₁₂ 18 ₅₂ 1234567890 1234567890 40 ¹ / ₁₆	

Fractions, Special Figures and Root Signs

SUPERIOR AND INFERIOR LETTERS AND FRACTIONS

12 Point No. 150	Per font \$1 20
abcdefghijklmnopqrst	abcdefghijklmnopqrst
1234567890	1234567890
11 Point No. 150	Per font \$1 20
abcdefghijklmnopqrst	abcdefghijklmnopqrst
1234567890	1234567890
10 Point No. 150	Per font \$1 40
abcdefghijklmnopqrstuv	abcdefghijklmnopqrstuv
1234567890	1234567890
9 Point No. 150	Per font \$1 45
abcdefghijklmnopqrstuv	abcdefghijklmnopqrstuv
1234567890	1234567890
8 Point No. 150	Per font \$1 65
abcdefghijklmnopqrstuvwxy	abcdefghijklmnopqrstuvwxy
1234567890	1234567890
7 Point No. 150	Per font \$1 90
abcdefghijklmnopqrstuvwxy	abcdefghijklmnopqrstuvwxy
1234567890	1234567890
6 Point No. 150	Per font \$2 10
abcdefghijklmnopqrstuvwxy	abcdefghijklmnopqrstuvwxy
1234567890	1234567890
5½ Point No. 40	Per font \$2 40
abcdefghijklmnopqrstuvwxy	abcdefghijklmnopqrstuvwxy
1234567890	1234567890

The font prices quoted above are for single fonts of either Superior Letters, Inferior Letters, Superior Figures or Inferior Figures

PIECE FRACTIONS

12 Point No. 120	Per font \$2 00
1 2 3 4 5 6 7 8 9 0	
1 2 3 4 5 6 7 8 9 0	
2 3 5 13 9 33	
5 16 36 68 100 100	
11 Point No. 120	Per font \$2 40
1 2 3 4 5 6 7 8 9 0	
1 2 3 4 5 6 7 8 9 0	
2 3 5 4 35 7 68	
3 7 9 25 86 234 276	
10 Point No. 120	Per font \$2 80
1 2 3 4 5 6 7 8 9 0	
1 2 3 4 5 6 7 8 9 0	
2 3 4 7 9 10 24 45	
5 20 68 90 100 160 200	
9 Point No. 120	Per font \$3 20
1 2 3 4 5 6 7 8 9 0	
1 2 3 4 5 6 7 8 9 0	
3 4 3 12 17 31	
6 27 35 132 350 1000	
8 Point No. 120	Per font \$3 60
1 2 3 4 5 6 7 8 9 0	
1 2 3 4 5 6 7 8 9 0	
4 5 17 45 38 150 197 420	
7 Point No. 40	Per font \$5 00
1 2 3 4 5 6 7 8 9 0	
1 2 3 3 5 6 7 8 9 0	
1 2 3 7 28 45 82 73 349 100 1339	
6 Point No. 120	Per font \$5 00
1 2 3 4 5 6 7 8 9 0	
1 2 3 4 5 6 7 8 9 0	
5 7 9 47 38 45 71 106 150 236 323	

SUPERIOR AND INFERIOR FRACTIONS

12 Point	Per font \$1 20
25 ¹⁴ / ₂₅ 1234567890	1234567890 / 36 ²⁸ / ₅₇
11 Point	Per font \$1 20
62 ¹² / ₇₈ 1234567890	1234567890 / 98 ⁴⁵ / ₈₉
10 Point	Per font \$1 40
33 ⁵⁰ / ₈₅ 1234567890	1234567890 / 21 ¹⁹ / ₂₆
9 Point	Per font \$1 45
47 ³⁶ / ₅₂ 1234567890	1234567890 / 15 ¹⁹ / ₆₂
8 Point	Per font \$1 65
35 ¹⁹ / ₄₇ 1234567890	1234567890 / 46 ²¹ / ₄₆
7 Point	Per font \$1 90
69 ⁴⁷ / ₇₃ 1234667890	1234567890 / 82 ⁶⁹ / ₇₁
6 Point	Per font \$2 10
14 ³⁵ / ₆₁ 1234567890	1234567890 / 35 ⁵⁸ / ₆₄

SPECIAL FRACTIONS

8 Point No. 1528	Per font \$0 50
1 ₄ 1 ₂ 3 ₄ 1 ₃ 2 ₃ 1 ₈ 3 ₈ 5 ₈ 7 ₈	
7 Point No. 1528	Per font \$0 50
1 ₄ 1 ₂ 3 ₄ 1 ₃ 2 ₃ 1 ₈ 3 ₈ 5 ₈ 7 ₈	
6 Point No. 1528	Per font \$0 50
1 ₄ 1 ₂ 3 ₄ 1 ₃ 2 ₃ 1 ₈ 3 ₈ 5 ₈ 7 ₈	
5½ Point No. 1528	Per font \$0 50
1 ₄ 1 ₂ 3 ₄ 1 ₃ 2 ₃ 1 ₈ 3 ₈ 5 ₈ 7 ₈	
6 Point No. 154	Per font \$0 50
1 ₄ 1 ₂ 3 ₄ 1 ₃ 2 ₃ 1 ₈ 3 ₈ 5 ₈ 7 ₈	
5½ Point No. 154	Per font \$0 50
1 ₄ 1 ₂ 1 ₃ 3 ₄ 2 ₃ 1 ₈ 3 ₈ 5 ₈ 7 ₈	
5½ Point No. 40	Per font \$0 50
1 ₁₆ 3 ₁₆ 5 ₁₆ 7 ₁₆ 9 ₁₆ 11 ₁₆ 13 ₁₆ 15 ₁₆	

SPECIAL FIGURES

8 Point Two-Third Figures	Per lb. \$0 64
1 2 3 4 5 6 7 8 9 0 \$	
7 Point Five-Eighth Figures	Per lb. \$0 69
1 2 3 4 5 6 7 8 9 0 \$	
6 Point Three-Quarter Figures	Per lb. \$0 79
1 2 3 4 5 6 7 8 9 0 \$	
6 Point Five-Seventh Figures	Per lb. \$0 79
1 2 3 4 5 6 7 8 9 0 \$	
5½ Point Five-Seventh Figures	Per lb. \$0 92
1 2 3 4 5 6 7 8 9 0 \$	
5 Point Two-Third Figures	Per lb. \$1 05
1 2 3 4 5 6 7 8 9 0 \$	

PIECE ROOT SIGNS

For making Root Signs of any Power. Per font, any one size, \$1 00

20 Pt. 10 pt. body, 10 pt. set	16 Pt. 8 pt. body, 8 pt. set	10 Pt. 5 pt. body, 5 pt. set	8 Pt. 4 pt. body, 4 pt. set
√ /	√ /	√ /	√ /

Miscellaneous Signs and Definitions

ALGEBRAIC SIGNS No. 150

12 Point Per font \$1 16



10 Point Per font \$1 30

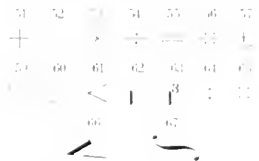

8 Point Per font \$1 60

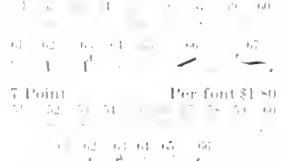

11 Point Per font \$1 22



9 Point Per font \$1 11



7 Point Per font \$1 80

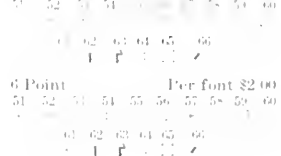

6 Point Per font \$2 00

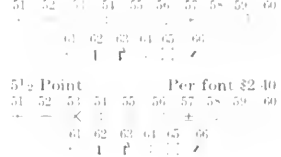

5½ Point Per font \$2 40

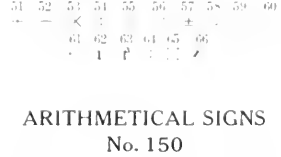

MEDICAL SIGNS No. 150

12 Point Per font \$0 50

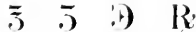

11 Point Per font \$0 50



10 Point Per font \$0 50



9 Point Per font \$0 50

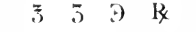

8 Point Per font \$0 50



7 Point Per font \$0 50

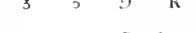

6 Point Per font \$0 50



PRICES

Medical, Arithmetical, Astronomical, Algebraic and Miscellaneous Signs are sold by the pound or single character as follows.

	Per Pound	Per Character
5½ Pt. . . .	\$2 10	\$0 05
6 Pt. . . .	2 00	05
7 Pt. . . .	1 80	05
8 Pt. . . .	1 60	05
9 Pt. . . .	1 44	05
10 Pt. . . .	1 30	05
11 Pt. . . .	1 22	05
12 Pt. . . .	1 16	05
14 to 20 Pt.	06

ARITHMETICAL SIGNS No. 150

12 Point Per font \$0 50



11 Point Per font \$0 50



10 Point Per font \$0 50



9 Point Per font \$0 50



8 Point Per font \$0 50



7 Point Per font \$0 50



6 Point Per font \$0 50



5½ Point Per font \$0 50

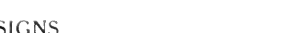

ILLUSTRATIONS AND DEFINITIONS OF SIGNS

Mathematical

- + plus
- minus
- × into, with
- ÷ divided by
- = equality
- ± plus or minus
- square
- ▭ rectangle
- △ triangle
- circle
- ∠ angle
- ⊥ right angle
- or > greater than
- or < less than
- ⊥ perpendicular
- ~ difference
- ∫ integration
- ≈ equivalency
- ∴ proportion
- * geometrical proportion
- difference, excess

Mathematical

- (Continued)
- ∴ therefore
 - ∵ because
 - √ radical
 - ° degree
 - ′ minute
 - ″ second
- ### Commercial
- @ at, to
 - ℔ per, each
 - lb pound
 - % percentum
 - sh shilling
 - c cent
 - ℳ account
- ### Medical
- R recipe, take
 - ℥ ounce
 - ʒ drachm
 - ℥ scruple

Ecclesiastical

- ∨ versicle
- R response
- ✝ or ✞ sign of the cross

Astronomical

- ♈ Aries
- ♉ Taurus
- ♊ Gemini
- ♋ Cancer
- ♌ Leo
- ♍ Virgo
- ♎ Libra
- ♏ Scorpio
- ♐ Sagittarius
- ♑ Capricornus
- ♒ Aquarius
- ♓ Pisces
- ☉ or ☌ Sun
- ☿ Mercury
- ♀ Venus
- ♁ Earth

Astronomical

- (Continued)
- ♂ Mars
 - ♃ Jupiter
 - ♄ Saturn
 - ♅ or ♁ Uranus
 - ♆ Neptune
 - ♁ New Moon
 - ☾ First Quarter
 - ☽ Full Moon
 - ☾ Last Quarter
 - ☾ Conjunction
 - ♌ Opposition
 - ♊ Trine
 - ♈ Quartile
 - ♋ Sextile
 - ♁ Dragon's Head
 - ♁ Dragon's Tail
 - ♁ Ceres
 - ♁ Pallas
 - ♁ Juno
 - ♁ Vesta

Astronomical Signs and Brackets

ASTRONOMICAL SIGNS

24 Point No. 150 Set of four \$0 40



20 Point No. 150 Set of four \$0 25



16 Point No. 150 Set of four \$0 25



12 Point No. 553 Per font \$1 00



12 Point No. 552 Per font \$1 00



11 Point No. 552 Per font \$1 00



10 Point No. 552 Per font \$1 00



9 Point No. 552 Per font \$1 00



8 Point No. 553 Per font \$1 00

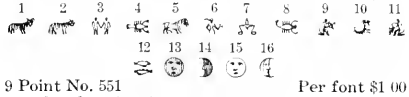

9 Point No. 551 Per font \$1 00

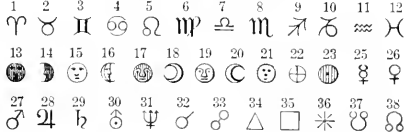

8 Point No. 551 Per font \$1 00

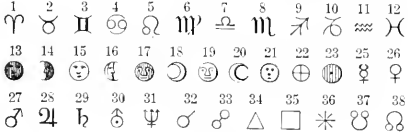

14 Point No. 551 Per font \$1 00

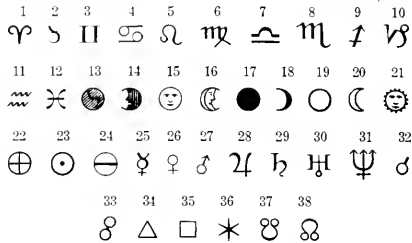

12 Point No. 551 Per font \$1 00

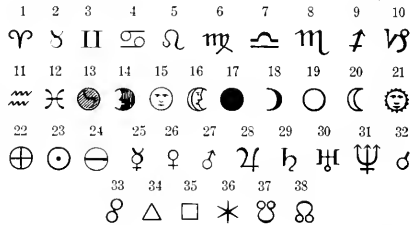

11 Point No. 551 Per font \$1 00

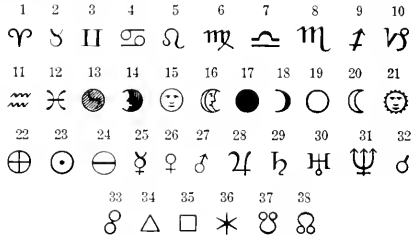

10 Point No. 551 Per font \$1 00

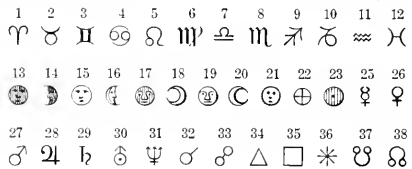

7 Point No. 551 Per font \$1 00



6 Point No. 551 Per font \$1 00



BRACKETS

42Pt. No. 150 Each \$0 15 30 Pt. No. 150 Each \$0 10

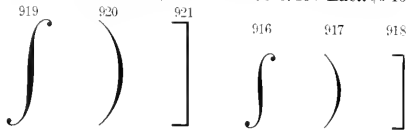

SIGNS

Nos. 849 to 853 Each \$0 10

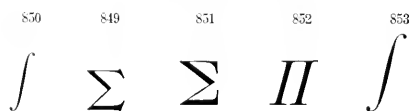

Miscellaneous Signs and Imprints

MISCELLANEOUS SIGNS

These Signs are cast to order promptly.

12 Point No. 150 Per lb. \$1.16

888	890	892	894	896	898	900
≠	∇	†	+	±	⊕	⊗

12 Point No. 129 Per lb. \$1.16

891	893	895	897	899	901	903
+	×	5	3	5	≠	

11 Point No. 150 Per lb. \$1.22

901	902	903	904	905	906	907
≠	∇	†	+	±		

10 Point No. 129 Per lb. \$1.30

908	910	912	914	916	918	920
≠	∇	†	+	±	⊕	⊗

10 Point No. 150 Per lb. \$1.30

893	894	895	896	897	898	899	900
≠	∇	†	+	±	⊕	⊗	

9 Point No. 129 Per lb. \$1.41

921	922	923	924	925	926	927	928
≠	∇	†	+	±	⊕	⊗	

9 Point No. 150 Per lb. \$1.41

883	884	885	886	887	888	889	890	891	892
≠	∇	†	+	±	⊕	⊗			

8 Point No. 129 Per lb. \$1.60

929	930	931	932	933	934	935	936
≠	∇	†	+	±	⊕	⊗	

8 Point No. 150 Per lb. \$1.60

874	874	875	876	877	878	879	880	881	882
≠	∇	†	+	±	⊕	⊗			

7 Point No. 129 Per lb. \$1.80

937	938	939	940	941	942	943	944
≠	∇	†	+	±	⊕	⊗	

7 Point No. 150 Per lb. \$1.80

895	896	897	898	899	900	901	902
≠	∇	†	+	±	⊕	⊗	

6 Point No. 129 Per lb. \$2.00

945	946	947	948	949	950	951	952
≠	∇	†	+	±	⊕	⊗	

5 1/2 Point No. 150 Per lb. \$2.40

857	858	859	860	861	862	863	864
M	°	∇	†	+	±	⊕	⊗

8 Point No. 129 Per lb. \$1.60

953	954	955	956	957	958	959	960
≠	∇	†	+	±	⊕	⊗	

6 Point No. 120 Per lb. \$2.00

550	551	552	553	554	555	556	557	558	559	560	561
≠	∇	†	+	±	⊕	⊗					

7 Point No. 129 Per lb. \$1.80

961	962	963	964	965	966	967	968
≠	∇	†	+	±	⊕	⊗	

6 Point No. 150 Per lb. \$2.40

562	563	564	565	566	567	568	569	570	571	572	573
≠	∇	†	+	±	⊕	⊗					

6 Point No. 120 Per lb. \$2.00

645	646	647	648	649	650	651	652	653	654	655	656
≠	∇	†	+	±	⊕	⊗					

6 Point No. 150 Per lb. \$2.40

574	575	576	577	578	579	580	581	582	583	584	585
≠	∇	†	+	±	⊕	⊗					

6 Point No. 120 Per lb. \$2.00

657	658	659	660	661	662	663	664	665	666	667	668
≠	∇	†	+	±	⊕	⊗					

6 Point No. 150 Per lb. \$2.40

589	590	591	592	593	594	595	596	597	598	599	600
≠	∇	†	+	±	⊕	⊗					

6 Point No. 120 Per lb. \$2.00

669	670	671	672	673	674	675	676	677	678	679	680
≠	∇	†	+	±	⊕	⊗					

6 Point No. 150 Per lb. \$2.40

601	602	603	604	605	606	607	608	609	610	611	612
≠	∇	†	+	±	⊕	⊗					

6 Point No. 120 Per lb. \$2.00

681	682	683	684	685	686	687	688	689	690	691	692
≠	∇	†	+	±	⊕	⊗					

6 Point No. 150 Per lb. \$2.40

613	614	615	616	617	618	619	620	621	622	623	624
≠	∇	†	+	±	⊕	⊗					

6 Point No. 120 Per lb. \$2.00

693	694	695	696	697	698	699	700	701	702	703	704
≠	∇	†	+	±	⊕	⊗					

6 Point No. 150 Per lb. \$2.40

625	626	627	628	629	630	631	632	633	634	635	636
≠	∇	†	+	±	⊕	⊗					

6 Point No. 120 Per lb. \$2.00

705	706	707	708	709	710	711	712	713	714	715	716
≠	∇	†	+	±	⊕	⊗					

6 Point No. 150 Per lb. \$2.40

637	638	639	640	641	642	643	644
≠	∇	†	+	±	⊕	⊗	

6 Point No. 120 Per lb. \$2.00

717	718	719	720	721	722	723	724
≠	∇	†	+	±	⊕	⊗	

COPPER ALLOY IMPRINTS

Cast in one piece; any of the faces here shown at the following prices:

Net Prices of Matrices

6 Point and smaller, up to one inch in length, each.....	\$4.00
Additional inches or fractions thereof.....	1.00

Price for Casting Imprints

These prices in addition to cost of matrices

50 type or less from one matrix.....	\$3.25	50 or less type from each of two matrices.....	\$5.75
51 to 100 type from one matrix.....	5.00	51 to 100 type from each of two matrices.....	9.50
200 or more type from one matrix.....	per 100, 4.50	200 or more from each of two matrices.....	per 100, 8.50

Style of Imprints

Style 10
ARTS PRINTING CO., TROY

Style 13
HENRY STILLMAN, PRINTER

Style 16
BRONX PRINT SHOP

Style 11
WYNDHAM PRESS, UTICA

Style 14
THE HARTSMAN PRESS

Style 17
HOWES PRINTING CO., N. Y.

Style 12
EAGLES PUBLISHING CO.

Style 15
STANDARD PRINTING COMPANY

Style 18
PRESS OF W. H. SMITH

Copper Alloy Imprints are recommended as they have a uniform clearness of face not obtainable in so small an electro line. When wanted in quantities the Copper Alloy Imprints would be cheaper than the electro.

ELECTROTYPED IMPRINTS

Electrotyped Imprints made from any of the type styles shown above for Copper Alloy Imprints. Price of single imprint 50 cents. If more than one is ordered, the duplicates at regular electrotype scale price.

Auxiliaries, Commercial Signs, Parentheses and Brackets

MISCELLANEOUS AUXILIARIES

Below is shown a comprehensive line of Inland Type Foundry's Miscellaneous Auxiliaries. For the convenience of our customers we have printed a circular giving complete detail as to the various characters, sizes, and the manner in which they are fonted. We will send this circular to any one interested. When requesting this circular be sure to mention that it is the Inland Type Foundry's Miscellaneous Auxiliaries that are wanted.

Mathematical

- 1 + plus
- 2 - minus
- 3 × multiplied by
- 4 ÷ divided by
- 5 = equal to
- 6 :: ratio
- 7 :: proportion
- 8 :: geometrical proportion
- 9 + or - plus or minus
- 10 < less than
- 11 > greater than
- 12 < or > not less than
- 13 > or < not greater than
- 14 ≡ equivalent to
- 15 ≠ not equal to
- 16 ≈ nearly equal to
- 17 Δ difference
- 18 Δ difference between
- 19 Δ variation
- 20 √ radical
- 21 √ cube root
- 22 ° degree
- 23 ' minute
- 24 " second
- 25 ○ circle
- 26 □ square
- 27 ▭ rectangle
- 28 ∠ angle
- 29 △ triangle
- 30 ∫ integration
- 31 ∫ integration of a quaternion
- 32 ± minus or plus
- 33 ∴ hence, therefore
- 34 ∵ because
- 35 ∫ integral of
- 36 ∞ infinity
- 37 ⊥ right angle
- 38 ⊥ perpendicular to
- 39 ≡ identical with
- 40 ± approaches

Arithmetical

- 1 + plus
- 2 - minus
- 3 × multiplied by
- 4 ÷ divided by
- 5 = equal to

Nautical

- 1 ⊙ sun's center
- 2 ⊕ sun's upper limb
- 3 ⊗ sun's lower limb
- 4 ☾ moon's upper limb
- 5 ☾ moon's lower limb

Medical

- R recipe
- ℥ ounce
- ℥ dram, drachm
- ℥ scruple

Astronomical

SIGNS OF THE ZODIAC

- 1 ♈ Aries
- 2 ♉ Taurus
- 3 ♊ Gemini
- 4 ♋ Cancer
- 5 ♌ Leo
- 6 ♍ Virgo
- 7 ♎ Libra
- 8 ♏ Scorpio
- 9 ♐ Sagittarius
- 10 ♑ Capricornus
- 11 ♒ Aquarius
- 12 ♓ Pisces

MOON'S PHASES

- 13 ☾ New Moon
- 14 ☽ First Quarter
- 15 ☽ Full Moon
- 16 ☾ Last Quarter
- 17 ☽ New Moon
- 18 ☽ First Quarter

MOON'S PHASES—Continued

- 19 ☽ Full Moon
- 20 ☾ Last Quarter

SUN AND PLANETS

- 21 ☉ Sun
- 22 ☾ Moon
- 23 ☿ Mercury
- 24 ♀ Venus
- 25 ⊕ Earth
- 26 ♂ Mars
- 27 ♃ Jupiter
- 28 ♄ Saturn
- 29 ♅ Uranus
- 30 ♆ Neptune

SIGNS OF POSITION

- 31 ☉ conjunction
- 32 ☉ opposition
- 33 △ trine
- 34 □ quadrature
- 35 * sextile
- 36 α variation
- 37 ♁ Dragon's head
- 38 ♁ Dragon's tail
- 39 ⌘ station mark

Commercial

- ℥ per
- @ at, to
- lb pound
- % per cent
- ℥ account
- ¢ cent

Miscellaneous

- * Maltese Cross
- # number
- / shilling mark
- direction
- ↖ arrow
- ♂ male

This line of Auxiliary material is most complete. It includes Superior and Inferior Letters and Figures, both in Roman and Oldstyle, Scored and Pointed Figures, Canceled Letters and Figures, and in addition the following Signs and Marks in the various bodies from 5 Point to 12 Point.

JOB COMMERCIAL SIGNS

36 Point

Per font \$0 50



1

2

3

30 Point

Per font \$0 50



1

2

3

18 Point

Per font \$0 50

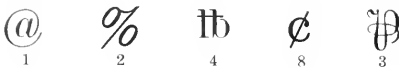

1

2

4

8

3

12 Point

Per font \$0 50

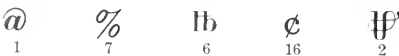

1

7

6

16

2

SPECIAL PARENTHESES

All Cast on 6 Point Body

These Parentheses are cast in the lengths indicated under each pair. Sold singly at 10¢ per pair, or \$1.28 per pound. Also put up in fonts containing 4 of each, at \$1.50 per font.

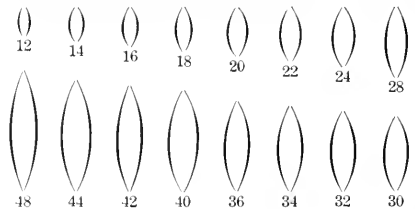

SPECIAL BRACKETS

All Cast on 6 Point Body

These Brackets are cast in the lengths indicated under each pair. Sold singly at 10¢ per pair, or \$1.28 per pound. Also put up in fonts containing 4 of each, at \$1.50 per font.

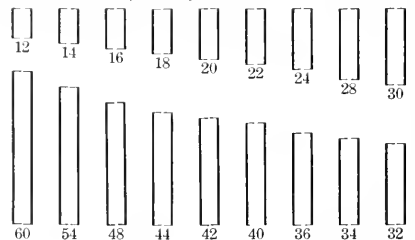

Per Cent Marks, Cent Marks and Quotation Marks

JOB FACE PER CENT MARKS

Series No. 1, Thin

Font A

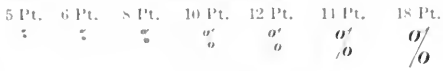
Containing 16 characters of each size Per font \$0 75
 5 Pt. 6 Pt. 8 Pt. 10 Pt. 12 Pt. 11 Pt. 18 Pt.

Font B

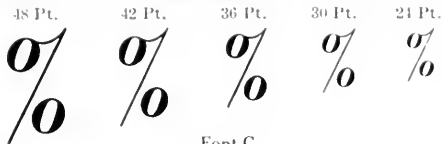
Containing 5 characters of each size Per font \$0 75
 48 Pt. 42 Pt. 36 Pt. 30 Pt. 24 Pt.

Font C

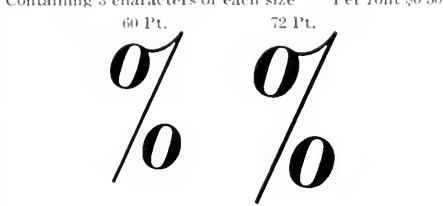
Containing 3 characters of each size Per font \$0 50
 60 Pt. 72 Pt.

Series No. 2, Thick

Font D

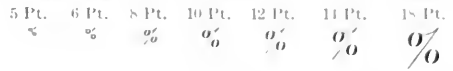
Containing 8 characters of each size Per font \$0 75
 5 Pt. 6 Pt. 8 Pt. 10 Pt. 12 Pt. 11 Pt. 18 Pt.

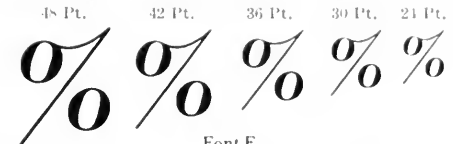

Font E

Containing 3 characters of each size Per font \$0 75
 48 Pt. 42 Pt. 36 Pt. 30 Pt. 24 Pt.

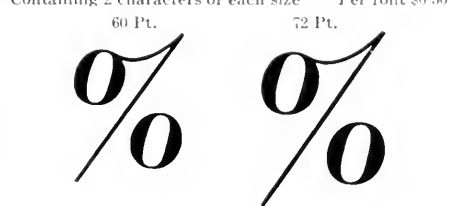
Font F

Containing 2 characters of each size Per font \$0 50
 60 Pt. 72 Pt.

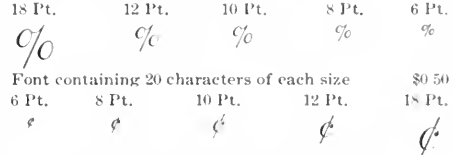

PER CENT AND CENT MARKS

Font containing 2 characters of each size \$0 50
 72 Point 60 Point

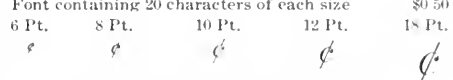
Font containing 10 characters of each size \$0 50
 18 Pt. 12 Pt. 10 Pt. 8 Pt. 6 Pt.





Font containing 20 characters of each size \$0 50
 6 Pt. 8 Pt. 10 Pt. 12 Pt. 18 Pt.

PER CENT AND CENT MARKS

Font containing 4 characters of each size \$0 50
 48 Point 36 Point 24 Point

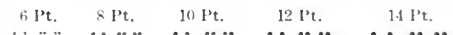



918, 15c 929, 15c 930, 6c 931, 6c 932, 5c 933, 5c

BODONI QUOTATION MARKS

6 Pt. 8 Pt. 10 Pt. 12 Pt. 14 Pt.

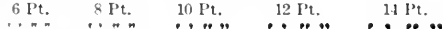
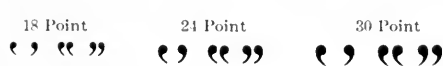
 18 Point 24 Point 30 Point

 36 Point 42 Point

 48 Point 60 Point

 72 Point

HEAVYFACE QUOTATION MARKS

Series No. 2

6 Pt. 8 Pt. 10 Pt. 12 Pt. 14 Pt.

 18 Point 24 Point 30 Point

 36 Point 48 Point

 60 Point

 72 Point

Put up in separate fonts of each body. Sizes 6 Point to 24 Point, inclusive, 25 cents per font; 30 point to 72 point, 50 cents per font.

Fonts of both Heavyface and Bodoni Quotation Marks contain the following number of each (right and left) of the different characters, the first figure representing the single quotes and the second figure representing the double quotes: 6 pt., 17-55; 8 pt., 15-45; 10 pt., 13-11; 12 pt., 10-32; 14 pt., 8-25; 18 pt., 5-16; 24 pt., 4-13; 30 pt., 5-16; 36 pt., 3-12; 48 pt., 2-6; 60 pt., 2-4; 72 pt., 1-3.

Put up in separate fonts of each body. Sizes 6 Point to 24 Point, inclusive, 25 cents per font; 30 Point to 72 Point, 50 cents per font.

Parentheses and Brackets

PARENTHESES AND BRACKETS FOR JOB FACES

Parentheses and Brackets No. 11 \$0 50
Contains 5, 6, 8, 9, 10 and 12 Point sizes

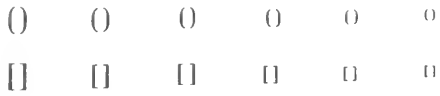

Parentheses and Brackets No. 21 \$0 50
Contains 5, 6, 8, 9, 10 and 12 Point sizes

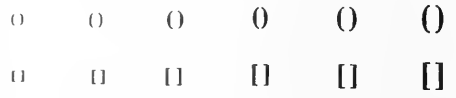

Parentheses and Brackets No. 12 \$0 75
Contains 14, 18, 24 and 30 Point sizes

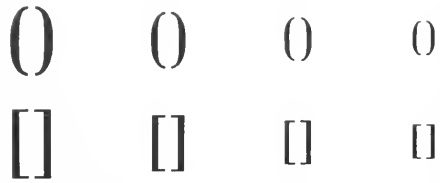

Parentheses and Brackets No. 22 \$0 75
Contains 14, 18, 24 and 30 Point sizes

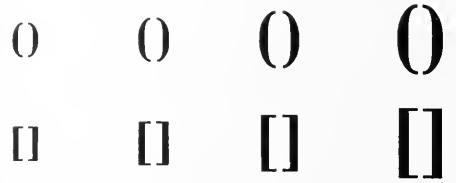

Parentheses and Brackets No. 13 \$0 90
Contains 36, 42 and 48 Point sizes

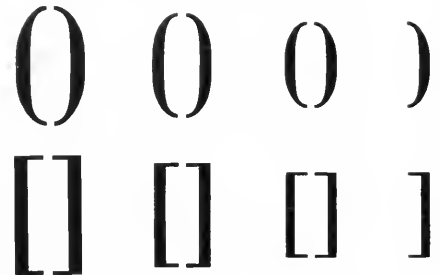

Parentheses and Brackets No. 23 \$0 90
Contains 36, 42 and 48 Point sizes

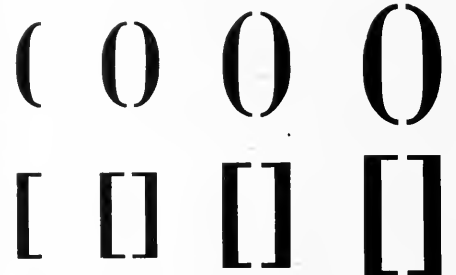

Parentheses and Brackets No. 14 \$1 25
Contains 54, 60 and 72 Point sizes

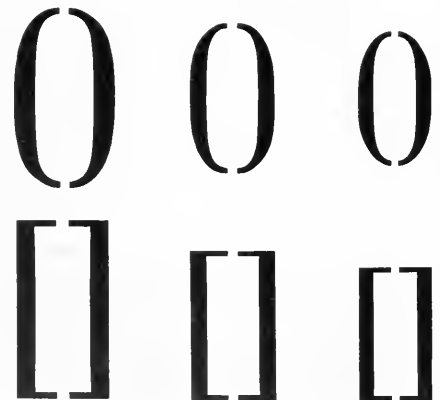

Parentheses and Brackets No. 24 \$1 25
Contains 54, 60 and 72 Point sizes

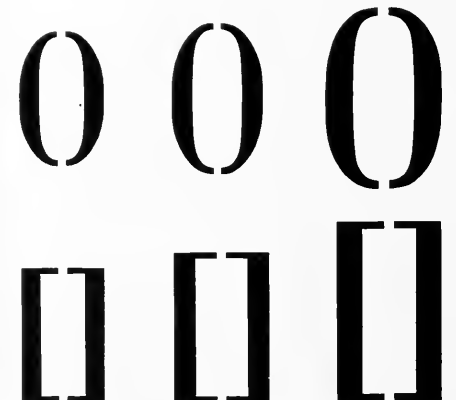

Parentheses and Brackets

PARENTHESES AND BRACKETS FOR JOB FACES

Parentheses and Brackets No. 31 \$0 50
 Contains 5, 6, 8, 9, 10 and 12 Point sizes



Parentheses and Brackets No. 41 \$0 50
 Contains 5, 6, 8, 9, 10 and 12 Point sizes



Parentheses and Brackets No. 32 \$0 75
 Contains 14, 18, 24 and 30 Point sizes

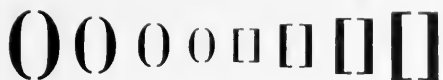

Parentheses and Brackets No. 42 \$0 75
 Contains 14, 18, 24 and 30 Point sizes



Parentheses and Brackets No. 33 \$0 90
 Contains 36, 42 and 48 Point sizes



Parentheses and Brackets No. 43 \$0 90
 Contains 36, 42 and 48 Point sizes



Parentheses and Brackets No. 34 \$1 25
 Contains 54, 60 and 72 Point sizes



Parentheses and Brackets No. 44 \$1 25
 Contains 54, 60 and 72 Point sizes



Parentheses and Brackets No. 51 \$0 50
 Contains 6, 8, 10 and 12 Point sizes

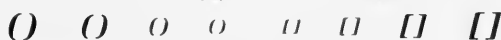

Parentheses and Brackets No. 52 \$0 80
 Contains 14, 18, 24 and 30 Point sizes



Parentheses and Brackets No. 53 \$1 10
 Contains 36, 48 and 60 Point sizes

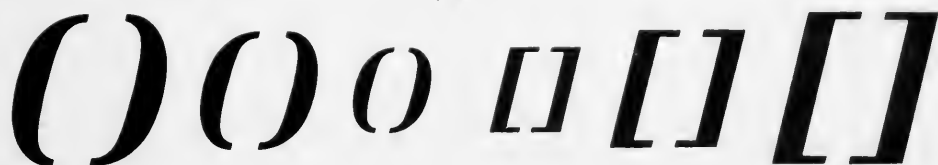

Time-Table Logotypes and Signs

TIME-TABLE LOGOTYPES

Sold in quantities of one pound or more per character, at body type prices
Can be cast on any wider set

5 Point

5 Point set

6 Point set

6½ Point set

7 Point set

7½ Point set

10 Point set

Time-Table References

2½ Point set

5 Point set

Can be cast on 5½ Point or 6 Point body or any wider set

5½ Point

5½ Point set

Time-Table References

2¾ Point set

6 Point

6 Point set

7½ Point set

8 Point set

9 Point set

11 Point set

12 Point set

12 Point set

6 Point—Continued

18 Point set

36 Point set

53 Point set

Time-Table References

3 Point Set

5 Point set

8 Point

4 Point set

8 Point set

12 Point set

18 Point set

48 Point set

12 Point

3 Point set

12 Point set

32 Point set

DAILY

DAILY EX. SUN.

DAILY EX. SUN.

36 Point set

A. M. P. M. 1 Mile
55 56 139

AM PM
69 70

Stations.
131

* † ‡ § ¶
28 29 30 31 32 33 34

a b
35 36

Ar M M
114 115

Ar M M PM
116 117 118 119

AM PM
57 58

A. M. P. M.
59 60

STATIONS.
71

A M P M
148 149

Lv Ar
132 133

Ex. Sun. Daily
74 75

DAILY SUNDAY ONLY
61 62

DAILY EX. SUN. DAILY EX. MON.
63 64

EXCEPT EXCEPT
72 73

18 Point

32 Point set

DAILY EXCEPT SUNDAY
65

DAILY EXCEPT MONDAY
66

Special Logotypes

5½ Point

3 Point set

8 Point set

6 Point

6 Point set

12 Point set

18 Point set

8 Point

3 Point set

4 Point set

8 Point set

10 Point set

12 Point set

14 Point set

15 Point set

21 Point set

26 Point set

A M M
78 79

AM PM
76 77

AM PM Ar Lv
80 81 82 83

am pm A.M. P.M.
84 85 86 87

A. M. P. M. A. M. P. M.
88 89 90 91

A A
134 148

M M A M
92 93

Lv Ar
94 95

A.M. P.M. A.M. P.M.
135 136 137 138

A.M. P.M.
96 97

M. A.M. P.M.
139 140 141

A.M. P.M.
142 143

M. A.M. P.M.
144 145 146

M.
147

SPECIAL TARIFF SIGNS

Sold in quantities of one pound or more per character, at body type prices

6 Point

600 601 602 603 604 605 606 607 608
609 610 611 612 613 614 615 616

8 Point

800 801 802 803 804 805 806 807 808 809 810 811
812 813 814 815 816 817 818 819 820 821 822

10 Point

1000 1001 1002 1003 1004 1005 1006

11 Point

1100 1101 1102

12 Point

1200 1201 1204 1205 1206 1207

12 Point

1202 1203

COPYRIGHT SIGNS

- 6 Point—6 point set: Nos. 600, 602, 603, 604, 605, 606.
- 6 Point—5½ point set (to order only): Nos. 604, 605.
- 6 Point—4 point set: Nos. 607, 608, 609, 610, 611, 612.
- 6 Point—3¾ point set: No. 601.
- 6 Point—3 point set: Nos. 613, 614, 615, 616.
- 8 Point—8 point set: Nos. 802, 804, 805, 807, 808, 809, 810, 811, 812, 813, 814.
- 8 Point—5 point set (to order only): Nos. 804, 805.
- 8 Point—4¾ point set: No. 803.
- 8 Point—4 point set: Nos. 800, 801, 806, 815, 816, 817, 818, 819, 820, 821, 822.
- 10 Point—10 point set: Nos. 1000, 1002, 1003, 1005, 1006.
- 10 Point—6 point set (to order only): Nos. 1002, 1003.
- 10 Point—5½ point set: No. 1001.
- 10 Point—5 point set: No. 1004.
- 11 Point—5½ point set: Nos. 1100, 1101, 1102.
- 12 Point—12 point set: Nos. 1200, 1202, 1203, 1204, 1205, 1206, 1207.
- 12 Point—6½ point set: No. 1201.

Explanation

- ▲ Increase passenger rate.
- Ⓐ Ⓐ Advance freight rate.
- Ⓜ Ⓜ Reduction freight rate.
- ● Reduction passenger rate.

Time-Table Figures

TIME-TABLE FIGURES

6 Point Lining Gothic

6 Point Lining Gothic No. 529 Figures, 3 1/2 Pt. set

ARRIVE AT	N. B.	N. 20.
NEW YORK	DAILY	DAILY
CORTLANDT STREET	7 20AM	2 20PM
DESSHOSES STREET	7 23AM	2 23PM
Twenty-third Street New York, New Haven & Hartford Railroad	7 33AM	2 33PM
	W. K. DAYS	SUNDAYS
NEW YORK	8 00AM	10 00AM
Ar STAMFORD	8 57AM	12 22AM
Ar SOUTH WALK	7 23AM	12 33AM
Ar NEW HAVEN	8 24AM	12 44AM

Set in 6 Point Lining Gothic Nos. 527, 528 and 529

5 Point Roman No. 527. Figures en set

5 Point Clarendon Time-Table Figures, en set

P. M.	A. M.	Lv	Ar	P. M.	A. M.
11 11	10 11	BURLINGTON	11 11	11 10	
	9 30	Latty	11 22	10 50	
11 21	9 55	Mediapolis	11 22	10 55	
11 26	10 00	MORNING SUN	11 25	10 40	
11 28	10 20	Wadello	11 38	10 20	
11 38	11 05	COLUMBUS JUNC	11 41	11 05	
11 45	12 20	NICHOLS	11 55	12 20	

5 1/2 Point Roman No. 527. Figures en set

5 1/2 Point Clarendon Time-Table Figures, en set

P. M.	A. M.	Lv	Ar	P. M.	A. M.
8 30	4 20	BURLINGTON	10 45	8 15	
		Latty			
7 01	4 55	Mediapolis	9 14	7 40	
7 15	5 11	MORNING SUN	9 15	7 25	
7 30	5 30	Wadello	9 16	7 15	
7 51	5 55	COLUMBUS JUNC	8 17	6 52	
8 20	4 25	NICHOLS	8 18	6 25	

6 Point Century Expanded. Figures en set

6 Point Clarendon Time-Table Figures, en set

AM	PM	Lv	Ar	PM	AM
8 40	6 30	BURLINGTON	10 45	8 15	
		Latty			
9 15	7 01	Mediapolis	10 14	7 40	
9 31	7 15	MORNING SUN	9 55	7 25	
9 48	7 30	Wadello	9 40	7 15	
10 15	7 51	COLUMBUS JUNC	9 15	6 52	
10 50	8 20	NICHOLS	9 46	6 25	

6 Point No. 31

Lightface

8 07	0 Lv	
8 27	6	
8 39	12	
9 00	21	
	22	
9 06	23	
9 13	26	
9 20	31	
9 31	33	
9 52	42	
10 00	45	
10 12	48	

Both en set

LOUISVILLE	Ar	273	5 42
New Albany		267	5 22
Edwardsville		261	5 07
Crandall		252	4 47
Mott		251	
Corydon Junction		249	4 43
Ramseys		246	4 28
De Pauw		243	4 25
Milltown		239	4 20
Temple		238	4 32
English		227	3 55
Lamar		212	3 35

6 Point No. 32

Heavyface

5 1/2 Point No. 31

Lightface

5 50	0 Lv	
5 25	10	
4 57	23	
4 22	39	
	48	
3 55	50	
3 42	59	
3 15	71	
3 05	82	
2 55	87	

Both en set

PLEASANT HILL	Ar	133	8 30
Harrisonville		123	8 52
Archie		110	9 23
Butler		94	9 58
Ovid		85	10 21
Rich Hill		83	10 26
Horton		74	10 46
Nassau		62	11 20
Sheldon		51	11 55
Irwin		46	11 52

5 1/2 Point No. 32

Heavyface

5 Point No. 31

Lightface

10 10	0 Lv	
10 30	6	
10 45	11	
11 00	18	
11 19	25	
11 42	34	
11 59	43	
12 08	45	
12 23	51	

Both en set

KANSAS CITY	Ar	760	5 45
Kansas City June		754	5 25
Leeds		742	4 09
Dodson		742	4 58
Martin City		735	4 37
Stillwell		726	4 20
Chiles		717	3 53
Wagstaff		713	3 47
Cedar Springs		703	3 27

5 Point No. 32

Heavyface

6 Point Antique No. 525

Figures, 1 Point set

10 05pm Ar	Grand Island	Lv 11 22am
10 06pm Ar	Crook	Lv 12 40am
11 44pm Ar	Sterling	Lv 12 43am
12 39pm Ar	Morling	Lv 11 56am
12 49pm Ar	Snyder	Lv 10 04am
2 53pm Ar	Et Morgan	Lv 10 34am
3 05pm Ar	Wadell	Lv 10 35am
4 33pm Ar	Orchard	Lv 10 26am
4 36pm Ar	Hardin	Lv 10 50am
4 44pm Ar	Korsov	Lv 10 59am

6 Point Antique No. 525

Figures, 5 Point set

Can be cast on four-fifth body if desired

10 00pm Ar	Geneva	Lv 4 00am
10 12pm Ar	DeKalb	Lv 4 05am
10 22pm Ar	Dixon	Lv 4 10am
2 45m Ar	Boone	Lv 4 21am
2 55m Ar	Jefferson	Lv 4 50am
2 58m Ar	Cedar Rapids	Lv 4 55am
3 00m Ar	Columbus	Lv 5 45am
3 04pm Ar	Grand Island	Lv 5 59am
3 10pm Ar	Des Moines	Lv 10 22am
3 24pm Ar	Missouri Junct	Lv 10 55am

5 Point Ionic No. 522

Figures, 1 Point set

759 Lv. PERU	12 00pm
797 Lv. Portland	12 15pm
799 Lv. North Manchester	10 10pm
796 Lv. Auburn	1 44pm
797 Lv. DETROIT	1 50pm
823 Lv. Rotterdam Junct	1 50pm
824 Lv. NEW YORK 42d Street	1 00pm
835 Lv. Niagara Falls	2 00pm
844 Lv. Suspension Bridge	2 00pm
856 Lv. Niagara Falls, N. Y	3 56pm

6 Point Ionic No. 522

Figures, 5 Point set

Can be cast on four-fifth body if desired

199 Lv. PERU	6 05pm
134 Lv. Portland	10 00pm
125 Lv. North Manchester	12 30pm
205 Lv. Auburn	1 09pm
413 Lv. Butler	1 64pm
239 Lv. Montpelier	1 08pm
399 Lv. Adrian	1 08pm
397 Lv. DETROIT	8 28pm
666 Lv. Windsor	9 54pm
644 Lv. Chatham	9 56pm

8 Point No. 31

Lightface

3 45 Lv	
3 10	
2 45	
1 15	
12 55	
12 12 Ar	
10 49 Lv	
10 12	
9 49	
9 12	
8 46	
8 22	

Both en set

ST. LOUIS	Ar	11 43
Alton		12 15
Texas Junction		
Clarksville		2 12
Louisiana		2 32
Hannibal	Lv	3 15
Hannibal	Ar	3 55
Palmyra		4 42
Ely		4 59
Lakenan		5 35
Shelbina		5 46
Macon		6 31

8 Point No. 32

Heavyface

7 Point No. 31

Lightface

8 35 Lv	
8 53	
9 35	
9 55	
10 05	
10 45	
11 10	
11 20	
11 47	
12 01	
12 12	
1 10	
1 34	
2 10	
2 20	

Both en set

ST. LOUIS	Ar	5 20
East St. Louis		5 00
Upper Alton		4 14
Brighton		3 55
Tiass		3 43
Greenfield		3 05
Whitehall		2 39
West Roadhouse		2 27
Winchester		2 01
Riggston		1 49
Chapin		1 34
Beardstown		1 07
Browning		12 46
Vermont		12 12
Table Grove		11 48

7 Point No. 32

Heavyface

Time-Saving Mail List Type and Logotypes

EIGHT POINT LINING MAILER TYPE—TIME SAVING

Rev. J J Jones 3Feb14
CINCINNATI OHIO

Every character is cast 5 Point set; therefore if stick is set to multiples of 5 Point, justification is eliminated and perfect adjustment is effected. The regular justifier, which accompanies font, is the only one needed.

Warner Jolly 9Apr12
HOUSTON TEX

John Clement 8Jan13
KENNEBUNKPORT ME

Rev. Wm Ansel 8Dec14
SAN BERNARDINO CAL

TEN POINT TIME-SAVING MAIL LIST TYPE

Example used without Logotypes

Pope Bicycle Co. 6Aug12
HARTFORD, CONN.

W.J.Becker 11Nov15
POULTNEY, VT.

J. S. Cushing 30Mar14
BOSTON, MASS.

Bureau of Engraving,
WASHINGTON, D. C.

Theo.L.DeVinnie 12Jan13
NEW YORK, N. Y.

Rev S E Post 7Aug12
CUSHING MISS

Example in combination with 10 Point Rural Free Delivery Logotypes

Jean Touraine 6Oct13
RFD4 GRANDPRE WIS

Miss L H Cushing RFD3
RYETOWN ME

Mr K C Tiffany 2Apr14
RFD4 MORISTON N Y

Mr O S Bookman 4May14
RFD3 MAYVILLE MO

Chas B Jenson 3May15
RFD6 HARMONY WIS

Dr Rob Boldface RFD7
LAGON TEX

Example in combination with 10 Point Mail List Logotypes No. 122

Dr Chauncey Depew 3 Mar 14

Every character is cast on en-quad set, and only en-quads and 4-to-em spaces are used for spacing. By setting sticks to a multiple of 10 Points, spacing and justification become mere child's play; in fact, this type is self-spacing. Although the face is large, on examination it will be found that Time-Saving Mail List Type is as condensed, on the average, as ordinary Mail List Type. Price same as 10 Point Roman.

Rev Abe Slupsky 30 Nov 14

Mrs Mary Walker 31 Oct 15

Miss B.Hesselburg 3 Dec 14

Mr James J. Corbett 3Jan15

Theo. Roosevelt 4 Apr 14

MAIL LIST LOGOTYPES

10 Point Em Set No. 122

Jan Feb Mar Apr May June July Aug Sep Oct Nov Dec
14 Mr Mrs Miss Box Dr Rev Esq 15

10 Point En Set No. 123

Jan Feb Mar Apr May June July Aug Sep Oct Nov Dec
Mr Mrs Miss Box Dr Rev Hon Eld Gen Maj Col 12 13 14 15

10 Point Em Set No. 120

Jan Feb Mar Apr May June July Aug Sep Oct Nov Dec

10 Point En Set No. 114

Jan Feb Mar Apr May June July Aug Sep Oct Nov Dec

9 Point En Set No. 150

Jan Feb Mar Apr May June July Aug Sep Oct Nov Dec

8 Point Em Set No. 150

Jan Feb Mar Apr May June July Aug Sep Oct Nov Dec
Cast also on 9 Point em set body

10 Point En Set No. 121 Figures on 4-to-Em Set

Miss Jan Mrs Feb Hon Mar Box Apr Rev May 1234567890 Mr Dr 1912 1913 1914

10 Point No. 124

Wis SDak Kan.

Ill. Mo Neb. Iowa Mich Ind

10 Point Mail List Logotypes for Rural Free Delivery RFD RFD Route

Sold at body type prices. These Logotypes may be used with any series of Mail List Type

MAIL LIST SPECIMENS

10 Point Century Expanded in combination with 10 Point Mail List Logotypes No. 114 and 10 Point Century Bold

CORNCOB IDAHO SAN JUAN PORT POQUONOCK CONN
Anna Mosity 6¹/₂14 No 1327 25¹/₂14 Hannah Bates 4¹/₂15



































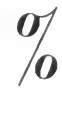









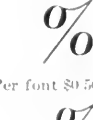







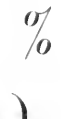



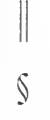





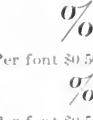







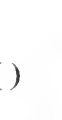
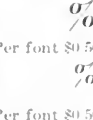



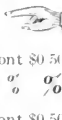

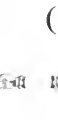
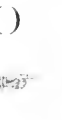
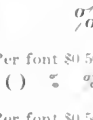





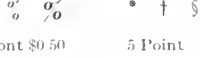









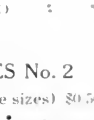

10 Point Century Expanded in combination with 10 Point Mail List Logotypes No. 121 and 10 Point Railroad Gothic No. 1

N MANCHESTER MICH WINDSOR LOCKS CONN RUSSIANVILLE IND
M P Radicals 6¹/₂12 M D Curemail 9¹/₂13 rev John Patrickson 8¹/₂14

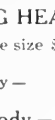
A complete font for 1000 single-line names, as above, will weigh as follows: Century Expanded including Spaces and Quads, 100 pounds; Century Bold Caps or Railroad Gothic No. 1 Caps, 10 pounds; Logotypes, 4 1/2 pounds. Where Counties and States are added (not using Century Bold or Railroad Gothic No. 1 Caps) from 25 to 50 pounds of extra sorts and quads would be required, for which a special sort order must be sent. Century Bold Caps and Railroad Gothic No. 1 Caps are the only faces of Post Office type furnished as per above specifications; are put up only in fonts of 10 pounds or multiples thereof.

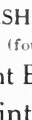
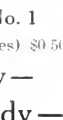
Auxiliaries for New Caslon and Heavy Dashes

AUXILIARIES FOR NEW CASLON

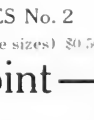
18 Point										Per font \$0.75	
42 Point										Per font \$0.75	
36 Point										Per font \$0.75	
30 Point										Per font \$0.50	
24 Point										Per font \$0.50	
18 Point											Per font \$0.50
14 Point										Per font \$0.50	
12 Point											Per font \$0.50
10 Point											Per font \$0.50
8 Point											Per font \$0.50
6 Point											Per font \$0.50

LINING HEAVYFACE DASHES No. 1

Font any one size \$0.50 Job fonts (four sizes) \$0.50
 6 Point Body — 10 Point Body —
 8 Point Body — 12 Point Body —

LINING HEAVYFACE DASHES No. 2

Font any one size \$0.50 Job fonts (three sizes) \$0.50
 14 Point — 18 Point —
 24 Point —

LINING HEAVYFACE DASHES No. 3

Font any one size \$0.50 Job fonts (two sizes) \$0.50
 30 Point — 36 Point —

LINING HEAVYFACE DASHES No. 4

Font any one size \$0.50 Job fonts (two sizes) \$0.75
 60 — 48 —

No. 1 — — — No. 2 — — — — — No. 3 — — — — — No. 4 — — — — —

Job Type Fractions in Fonts

CHELTENHAM FRACTIONS

18 Point

$\frac{1}{4}$ $\frac{1}{2}$ $\frac{3}{4}$ $\frac{1}{3}$ $\frac{2}{3}$ $\frac{1}{8}$ $\frac{3}{8}$ $\frac{5}{8}$ $\frac{7}{8}$ % ¢

Per font \$0 50

14 Point

$\frac{1}{4}$ $\frac{1}{2}$ $\frac{3}{4}$ $\frac{1}{3}$ $\frac{2}{3}$ $\frac{1}{8}$ $\frac{3}{8}$ $\frac{5}{8}$ $\frac{7}{8}$ % ¢

Per font \$0 50

12 Point

$\frac{1}{4}$ $\frac{1}{2}$ $\frac{3}{4}$ $\frac{1}{3}$ $\frac{2}{3}$ $\frac{1}{8}$ $\frac{3}{8}$ $\frac{5}{8}$ $\frac{7}{8}$ % ¢

Per font \$0 50

10 Point

Per font \$0 50

8 Point

$\frac{1}{4}$ $\frac{1}{2}$ $\frac{3}{4}$ $\frac{1}{3}$ $\frac{2}{3}$ $\frac{1}{8}$ $\frac{3}{8}$ $\frac{5}{8}$ $\frac{7}{8}$ % ¢

Per font \$0 50

6 Point

Per font \$0 50

$\frac{1}{4}$ $\frac{1}{2}$ $\frac{3}{4}$ $\frac{1}{3}$ $\frac{2}{3}$ $\frac{1}{8}$ $\frac{3}{8}$ $\frac{5}{8}$ $\frac{7}{8}$ % ¢

CHELTENHAM BOLD FRACTIONS

24 Point

$\frac{1}{4}$ $\frac{1}{2}$ $\frac{3}{4}$ $\frac{1}{3}$ $\frac{2}{3}$ $\frac{1}{8}$ $\frac{3}{8}$ $\frac{5}{8}$ $\frac{7}{8}$ % ¢

Per font \$0 50

18 Point

$\frac{1}{4}$ $\frac{1}{2}$ $\frac{3}{4}$ $\frac{1}{3}$ $\frac{2}{3}$ $\frac{1}{8}$ $\frac{3}{8}$ $\frac{5}{8}$ $\frac{7}{8}$ % ¢

Per font \$0 50

14 Point

$\frac{1}{4}$ $\frac{1}{2}$ $\frac{3}{4}$ $\frac{1}{3}$ $\frac{2}{3}$ $\frac{1}{8}$ $\frac{3}{8}$ $\frac{5}{8}$ $\frac{7}{8}$ % ¢

Per font \$0 50

12 Point

$\frac{1}{4}$ $\frac{1}{2}$ $\frac{3}{4}$ $\frac{1}{3}$ $\frac{2}{3}$ $\frac{1}{8}$ $\frac{3}{8}$ $\frac{5}{8}$ $\frac{7}{8}$ % ¢

Per font \$0 50

10 Point

$\frac{1}{4}$ $\frac{1}{2}$ $\frac{3}{4}$ $\frac{1}{3}$ $\frac{2}{3}$ $\frac{1}{8}$ $\frac{3}{8}$ $\frac{5}{8}$ $\frac{7}{8}$ % ¢

Per font \$0 50

8 Point

$\frac{1}{4}$ $\frac{1}{2}$ $\frac{3}{4}$ $\frac{1}{3}$ $\frac{2}{3}$ $\frac{1}{8}$ $\frac{3}{8}$ $\frac{5}{8}$ $\frac{7}{8}$ % ¢

Per font \$0 50

6 Point

Per font \$0 50

$\frac{1}{4}$ $\frac{1}{2}$ $\frac{3}{4}$ $\frac{1}{3}$ $\frac{2}{3}$ $\frac{1}{8}$ $\frac{3}{8}$ $\frac{5}{8}$ $\frac{7}{8}$ % ¢

OLDSTYLE FRACTIONS

42 Point

$\frac{1}{2}$ $\frac{1}{4}$ $\frac{3}{4}$

Per font \$0 50

20 Point

$\frac{1}{2}$ $\frac{1}{4}$ $\frac{3}{4}$

Per font \$0 50

30 Point

$\frac{1}{2}$ $\frac{1}{4}$ $\frac{3}{4}$

Per font \$0 50

18 Point

$\frac{1}{2}$ $\frac{1}{4}$ $\frac{3}{4}$

Per font \$0 50

24 Point

$\frac{1}{2}$ $\frac{1}{4}$ $\frac{3}{4}$

Per font \$0 50

ANTIQUE FRACTIONS No. 525

10 Point

$\frac{1}{2}$ $\frac{1}{4}$ $\frac{3}{4}$ $\frac{1}{3}$ $\frac{2}{3}$ $\frac{1}{8}$ $\frac{3}{8}$ $\frac{5}{8}$ $\frac{7}{8}$

Per font \$0 50

Job Type Fractions in Fonts

NEW CASLON FRACTIONS No. 1

18 Point

$\frac{1}{4}$ $\frac{1}{2}$ $\frac{3}{4}$ $\frac{1}{8}$ $\frac{3}{8}$ $\frac{5}{8}$ $\frac{7}{8}$ $\frac{1}{3}$ $\frac{2}{3}$ $\frac{1}{6}$

Per font \$0 75

12 Point

$\frac{1}{4}$ $\frac{1}{2}$ $\frac{3}{4}$ $\frac{1}{8}$ $\frac{3}{8}$ $\frac{5}{8}$ $\frac{7}{8}$ $\frac{1}{3}$ $\frac{2}{3}$ $\frac{1}{6}$

Per font \$0 75

36 Point

$\frac{1}{4}$ $\frac{1}{2}$ $\frac{3}{4}$ $\frac{1}{8}$ $\frac{3}{8}$ $\frac{5}{8}$ $\frac{7}{8}$ $\frac{1}{3}$ $\frac{2}{3}$ $\frac{1}{6}$

Per font \$0 75

30 Point

$\frac{1}{4}$ $\frac{1}{2}$ $\frac{3}{4}$ $\frac{1}{8}$ $\frac{3}{8}$ $\frac{5}{8}$ $\frac{7}{8}$ $\frac{1}{3}$ $\frac{2}{3}$ $\frac{1}{6}$

Per font \$0 75

24 Point

$\frac{1}{4}$ $\frac{1}{2}$ $\frac{3}{4}$ $\frac{1}{8}$ $\frac{3}{8}$ $\frac{5}{8}$ $\frac{7}{8}$ $\frac{1}{3}$ $\frac{2}{3}$ $\frac{1}{6}$

Per font \$0 50

18 Point

$\frac{1}{4}$ $\frac{1}{2}$ $\frac{3}{4}$ $\frac{1}{8}$ $\frac{3}{8}$ $\frac{5}{8}$ $\frac{7}{8}$ $\frac{1}{3}$ $\frac{2}{3}$ $\frac{1}{6}$

Per font \$0 50

14 Point

$\frac{1}{4}$ $\frac{1}{2}$ $\frac{3}{4}$ $\frac{1}{8}$ $\frac{3}{8}$ $\frac{5}{8}$ $\frac{7}{8}$ $\frac{1}{3}$ $\frac{2}{3}$ $\frac{1}{6}$

Per font \$0 50

12 Point

$\frac{1}{4}$ $\frac{1}{2}$ $\frac{3}{4}$ $\frac{1}{8}$ $\frac{3}{8}$ $\frac{5}{8}$ $\frac{7}{8}$ $\frac{1}{3}$ $\frac{2}{3}$ $\frac{1}{6}$

Per font \$0 50

10 Point

$\frac{1}{4}$ $\frac{1}{2}$ $\frac{3}{4}$ $\frac{1}{8}$ $\frac{3}{8}$ $\frac{5}{8}$ $\frac{7}{8}$ $\frac{1}{3}$ $\frac{2}{3}$ $\frac{1}{6}$

Per font \$0 50

8 Point

Per font \$0 50

6 Point

$\frac{1}{4}$ $\frac{1}{2}$ $\frac{3}{4}$ $\frac{1}{8}$ $\frac{3}{8}$ $\frac{5}{8}$ $\frac{7}{8}$ $\frac{1}{3}$ $\frac{2}{3}$ $\frac{1}{6}$

Per font \$0 50

5 Point

Per font \$0 50

ROMAN FRACTIONS

48 Point

$\frac{1}{2}$ $\frac{1}{4}$ $\frac{3}{4}$ $\frac{1}{3}$ $\frac{1}{2}$ $\frac{1}{4}$ $\frac{3}{4}$

Per font \$0 50

36 Point

Per font \$0 50

30 Point

$\frac{1}{2}$ $\frac{1}{4}$ $\frac{3}{4}$ $\frac{1}{3}$ $\frac{2}{3}$ $\frac{1}{2}$ $\frac{1}{4}$ $\frac{3}{4}$ $\frac{1}{3}$ $\frac{2}{3}$

Per font \$0 50

24 Point

Per font \$0 50

20 Point

$\frac{1}{2}$ $\frac{1}{4}$ $\frac{3}{4}$ $\frac{1}{3}$ $\frac{2}{3}$ $\frac{1}{2}$ $\frac{1}{4}$ $\frac{3}{4}$ $\frac{1}{3}$ $\frac{2}{3}$

Per font \$0 50

18 Point

Per font \$0 50

Job Type Fractions in Fonts

NEW CASLON FRACTIONS No. 2

48 Point

$\frac{1}{4}$ $\frac{1}{2}$ $\frac{3}{4}$ $\frac{1}{8}$ $\frac{3}{8}$ $\frac{5}{8}$
 $\frac{7}{8}$ $\frac{1}{3}$ $\frac{2}{3}$ $\frac{1}{6}$

Per font \$0.75

42 Point

$\frac{1}{4}$ $\frac{1}{2}$ $\frac{3}{4}$ $\frac{1}{8}$ $\frac{3}{8}$ $\frac{5}{8}$
 $\frac{7}{8}$ $\frac{1}{3}$ $\frac{2}{3}$ $\frac{1}{6}$

Per font \$0.75

36 Point

$\frac{1}{4}$ $\frac{1}{2}$ $\frac{3}{4}$ $\frac{1}{8}$ $\frac{3}{8}$ $\frac{5}{8}$ $\frac{7}{8}$ $\frac{1}{3}$ $\frac{2}{3}$ $\frac{1}{6}$

Per font \$0.75

30 Point

$\frac{1}{4}$ $\frac{1}{2}$ $\frac{3}{4}$ $\frac{1}{8}$ $\frac{3}{8}$ $\frac{5}{8}$ $\frac{7}{8}$ $\frac{1}{3}$ $\frac{2}{3}$ $\frac{1}{6}$

Per font \$0.75

24 Point

$\frac{1}{4}$ $\frac{1}{2}$ $\frac{3}{4}$ $\frac{1}{8}$ $\frac{3}{8}$ $\frac{5}{8}$ $\frac{7}{8}$ $\frac{1}{3}$ $\frac{2}{3}$ $\frac{1}{6}$

Per font \$0.50

18 Point

$\frac{1}{4}$ $\frac{1}{2}$ $\frac{3}{4}$ $\frac{1}{8}$ $\frac{3}{8}$ $\frac{5}{8}$ $\frac{7}{8}$ $\frac{1}{3}$ $\frac{2}{3}$ $\frac{1}{6}$

Per font \$0.50

14 Point

$\frac{1}{4}$ $\frac{1}{2}$ $\frac{3}{4}$ $\frac{1}{8}$ $\frac{3}{8}$ $\frac{5}{8}$ $\frac{7}{8}$ $\frac{1}{3}$ $\frac{2}{3}$ $\frac{1}{6}$

Per font \$0.50

12 Point

$\frac{1}{4}$ $\frac{1}{2}$ $\frac{3}{4}$ $\frac{1}{8}$ $\frac{3}{8}$ $\frac{5}{8}$ $\frac{7}{8}$ $\frac{1}{3}$ $\frac{2}{3}$ $\frac{1}{6}$

Per font \$0.50

10 Point

$\frac{1}{4}$ $\frac{1}{2}$ $\frac{3}{4}$ $\frac{1}{8}$ $\frac{3}{8}$ $\frac{5}{8}$ $\frac{7}{8}$ $\frac{1}{3}$ $\frac{2}{3}$ $\frac{1}{6}$

Per font \$0.50

6 Point

$\frac{1}{4}$ $\frac{1}{2}$ $\frac{3}{4}$ $\frac{1}{8}$ $\frac{3}{8}$ $\frac{5}{8}$ $\frac{7}{8}$ $\frac{1}{3}$ $\frac{2}{3}$ $\frac{1}{6}$

Per font \$0.50

CONDENSED STUDLEY FRACTIONS

48 Point

$\frac{1}{4}$ $\frac{1}{2}$ $\frac{3}{4}$ $\frac{1}{3}$ $\frac{1}{4}$ $\frac{1}{2}$ $\frac{3}{4}$ $\frac{1}{3}$

Per font \$0.75

36 Point

Per font \$0.75

30 Point

$\frac{1}{4}$ $\frac{1}{2}$ $\frac{3}{4}$ $\frac{1}{3}$ $\frac{1}{4}$ $\frac{1}{2}$ $\frac{3}{4}$ $\frac{1}{3}$

Per font \$0.75

24 Point

Per font \$0.50

18 Point

$\frac{1}{4}$ $\frac{1}{2}$ $\frac{3}{4}$ $\frac{1}{3}$ $\frac{1}{4}$ $\frac{1}{2}$ $\frac{3}{4}$ $\frac{1}{3}$

Per font \$0.50

14 Point

Per font \$0.50

Job Type Fractions in Fonts

QUENTELL FRACTIONS

36 Point

$\frac{1}{2}$ $\frac{1}{4}$ $\frac{3}{4}$ $\frac{1}{3}$ $\frac{2}{3}$ $\frac{1}{8}$ $\frac{3}{8}$ $\frac{5}{8}$ $\frac{7}{8}$

Per font \$0 75

30 Point

$\frac{1}{2}$ $\frac{1}{4}$ $\frac{3}{4}$ $\frac{1}{3}$ $\frac{2}{3}$ $\frac{1}{8}$ $\frac{3}{8}$ $\frac{5}{8}$ $\frac{7}{8}$

Per font \$0 75

24 Point

$\frac{1}{2}$ $\frac{1}{4}$ $\frac{3}{4}$ $\frac{1}{3}$ $\frac{2}{3}$ $\frac{1}{8}$ $\frac{3}{8}$ $\frac{5}{8}$ $\frac{7}{8}$

Per font \$0 50

18 Point

$\frac{1}{2}$ $\frac{1}{4}$ $\frac{3}{4}$ $\frac{1}{3}$ $\frac{2}{3}$ $\frac{1}{8}$ $\frac{3}{8}$ $\frac{5}{8}$ $\frac{7}{8}$

Per font \$0 50

14 Point

$\frac{1}{2}$ $\frac{1}{4}$ $\frac{3}{4}$ $\frac{1}{3}$ $\frac{2}{3}$ $\frac{1}{8}$ $\frac{3}{8}$ $\frac{5}{8}$ $\frac{7}{8}$

Per font \$0 50

12 Point

$\frac{1}{2}$ $\frac{1}{4}$ $\frac{3}{4}$ $\frac{1}{3}$ $\frac{2}{3}$ $\frac{1}{8}$ $\frac{3}{8}$ $\frac{5}{8}$ $\frac{7}{8}$

Per font \$0 50

10 Point

$\frac{1}{2}$ $\frac{1}{4}$ $\frac{3}{4}$ $\frac{1}{3}$ $\frac{2}{3}$ $\frac{1}{8}$ $\frac{3}{8}$ $\frac{5}{8}$ $\frac{7}{8}$

Per font \$0 50

8 Point

$\frac{1}{2}$ $\frac{1}{4}$ $\frac{3}{4}$ $\frac{1}{3}$ $\frac{2}{3}$ $\frac{1}{8}$ $\frac{3}{8}$ $\frac{5}{8}$ $\frac{7}{8}$

Per font \$0 50

6 Point

$\frac{1}{2}$ $\frac{1}{4}$ $\frac{3}{4}$ $\frac{1}{3}$ $\frac{2}{3}$ $\frac{1}{8}$ $\frac{3}{8}$ $\frac{5}{8}$ $\frac{7}{8}$

Per font \$0 50

INLAND GOTHIC FRACTIONS No. 1

36 Point

$\frac{1}{4}$ $\frac{1}{2}$ $\frac{3}{4}$ $\frac{1}{3}$

Per font \$0 75

30 Point

$\frac{1}{4}$ $\frac{1}{2}$ $\frac{3}{4}$ $\frac{1}{3}$

Per font \$0 75

24 Point

$\frac{1}{4}$ $\frac{1}{2}$ $\frac{3}{4}$ $\frac{1}{3}$

Per font \$0 50

18 Point

$\frac{1}{4}$ $\frac{1}{2}$ $\frac{3}{4}$ $\frac{1}{3}$

Per font \$0 50

14 Point

$\frac{1}{4}$ $\frac{1}{2}$ $\frac{3}{4}$ $\frac{1}{3}$

Per font \$0 50

12 Point

$\frac{1}{4}$ $\frac{1}{2}$ $\frac{3}{4}$ $\frac{1}{3}$

Per font \$0 50

10 Point

$\frac{1}{4}$ $\frac{1}{2}$ $\frac{3}{4}$ $\frac{1}{3}$

Per font \$0 50

9 Point

$\frac{1}{4}$ $\frac{1}{2}$ $\frac{3}{4}$ $\frac{1}{3}$

Per font \$0 50

8 Point

$\frac{1}{4}$ $\frac{1}{2}$ $\frac{3}{4}$ $\frac{1}{3}$

Per font \$0 50

6 Point

$\frac{1}{4}$ $\frac{1}{2}$ $\frac{3}{4}$ $\frac{1}{3}$

Per font \$0 50

INLAND GOTHIC FRACTIONS No. 8

36 Point

$\frac{1}{4}$ $\frac{1}{2}$ $\frac{3}{4}$ $\frac{1}{3}$

Per font \$0 75

14 Point

$\frac{1}{4}$ $\frac{1}{2}$ $\frac{3}{4}$ $\frac{1}{3}$

Per font \$0 50

30 Point

$\frac{1}{4}$ $\frac{1}{2}$ $\frac{3}{4}$ $\frac{1}{3}$

Per font \$0 75

12 Point

$\frac{1}{4}$ $\frac{1}{2}$ $\frac{3}{4}$ $\frac{1}{3}$

Per font \$0 50

24 Point

$\frac{1}{4}$ $\frac{1}{2}$ $\frac{3}{4}$ $\frac{1}{3}$

Per font \$0 50

10 Point

$\frac{1}{4}$ $\frac{1}{2}$ $\frac{3}{4}$ $\frac{1}{3}$

Per font \$0 50

18 Point

$\frac{1}{4}$ $\frac{1}{2}$ $\frac{3}{4}$ $\frac{1}{3}$

Per font \$0 50

8 Point

$\frac{1}{4}$ $\frac{1}{2}$ $\frac{3}{4}$ $\frac{1}{3}$

Per font \$0 50

Job Type Fractions in Fonts

GLOBE GOTHIC FRACTIONS

36 Point

Per font \$1 00

$\frac{1}{2}$ $\frac{1}{4}$ $\frac{3}{4}$ $\frac{1}{3}$ $\frac{2}{3}$ $\frac{1}{8}$ $\frac{3}{8}$
 $\frac{5}{8}$ $\frac{7}{8}$ $\frac{\sigma}{0}$ ¢

30 Point

Per font \$0 75

$\frac{1}{4}$ $\frac{1}{2}$ $\frac{3}{4}$ $\frac{1}{3}$ $\frac{2}{3}$ $\frac{1}{8}$ $\frac{3}{8}$
 $\frac{5}{8}$ $\frac{7}{8}$ $\frac{\sigma}{0}$ ¢

24 Point

Per font \$0 75

$\frac{1}{2}$ $\frac{1}{4}$ $\frac{3}{4}$ $\frac{1}{3}$ $\frac{2}{3}$ $\frac{1}{8}$ $\frac{3}{8}$ $\frac{5}{8}$
 $\frac{7}{8}$ $\frac{\sigma}{0}$ ¢

18 Point

Per font \$0 50

$\frac{1}{2}$ $\frac{1}{4}$ $\frac{3}{4}$ $\frac{1}{3}$ $\frac{2}{3}$ $\frac{1}{8}$ $\frac{3}{8}$ $\frac{5}{8}$
 $\frac{7}{8}$ $\frac{\sigma}{0}$ ¢

14 Point

Per font \$0 50

$\frac{1}{4}$ $\frac{1}{2}$ $\frac{3}{4}$ $\frac{1}{3}$ $\frac{2}{3}$ $\frac{1}{8}$ $\frac{3}{8}$ $\frac{5}{8}$ $\frac{7}{8}$ $\frac{\sigma}{0}$ ¢

12 Point

Per font \$0 50

10 Point

Per font \$0 50

$\frac{1}{2}$ $\frac{1}{4}$ $\frac{3}{4}$ $\frac{1}{3}$ $\frac{2}{3}$ $\frac{1}{8}$ $\frac{3}{8}$ $\frac{5}{8}$ $\frac{7}{8}$ $\frac{\sigma}{0}$ ¢ $\frac{1}{2}$ $\frac{1}{4}$ $\frac{3}{4}$ $\frac{1}{3}$ $\frac{2}{3}$ $\frac{1}{8}$ $\frac{3}{8}$ $\frac{5}{8}$ $\frac{7}{8}$ $\frac{\sigma}{0}$ ¢

8 Point

Per font \$0 50

6 Point

Per font \$0 50

$\frac{1}{2}$ $\frac{1}{4}$ $\frac{3}{4}$ $\frac{1}{3}$ $\frac{2}{3}$ $\frac{1}{8}$ $\frac{3}{8}$ $\frac{5}{8}$ $\frac{7}{8}$ $\frac{\sigma}{0}$ ¢ $\frac{1}{2}$ $\frac{1}{4}$ $\frac{3}{4}$ $\frac{1}{3}$ $\frac{2}{3}$ $\frac{1}{8}$ $\frac{3}{8}$ $\frac{5}{8}$ $\frac{7}{8}$ $\frac{\sigma}{0}$ ¢

CUSHING FRACTIONS

12 Point

Per font \$1 00

10 Point

Per font \$1 00

$\frac{1}{2}$ $\frac{1}{4}$ $\frac{3}{4}$ $\frac{1}{3}$ $\frac{2}{3}$ $\frac{1}{6}$ $\frac{1}{8}$ $\frac{3}{8}$ $\frac{5}{8}$ $\frac{7}{8}$ $\frac{1}{2}$ $\frac{1}{4}$ $\frac{3}{4}$ $\frac{1}{3}$ $\frac{2}{3}$ $\frac{1}{6}$ $\frac{1}{8}$ $\frac{3}{8}$ $\frac{5}{8}$ $\frac{7}{8}$

8 Point

Per font \$1 00

6 Point

Per font \$1 00

$\frac{1}{2}$ $\frac{1}{4}$ $\frac{3}{4}$ $\frac{1}{3}$ $\frac{2}{3}$ $\frac{1}{6}$ $\frac{1}{8}$ $\frac{3}{8}$ $\frac{5}{8}$ $\frac{7}{8}$ $\frac{1}{2}$ $\frac{1}{4}$ $\frac{3}{4}$ $\frac{1}{3}$ $\frac{2}{3}$ $\frac{1}{6}$ $\frac{1}{8}$ $\frac{3}{8}$ $\frac{5}{8}$ $\frac{7}{8}$

ANTIQUÉ FRACTIONS

36 Point No. 20

Per font \$0 50

30 Point No. 20

Per font \$0 50

$\frac{1}{2}$ $\frac{1}{4}$ $\frac{3}{4}$ $\frac{1}{2}$ $\frac{1}{4}$ $\frac{3}{4}$

18 Point No. 20

Per font \$0 50

12 Point Em Set No. 22

Per font \$0 50

$\frac{1}{2}$ $\frac{1}{4}$ $\frac{1}{4}$ $\frac{3}{4}$ $\frac{1}{8}$ $\frac{3}{8}$ $\frac{5}{8}$ $\frac{7}{8}$ $\frac{1}{2}$ $\frac{1}{4}$ $\frac{3}{4}$ $\frac{1}{8}$ $\frac{3}{8}$ $\frac{5}{8}$ $\frac{7}{8}$

18 Point En Set No. 22

Per font \$0 50

14 Point En Set No. 22

Per font \$0 50

$\frac{1}{2}$ $\frac{1}{4}$ $\frac{3}{4}$ $\frac{1}{2}$ $\frac{1}{4}$ $\frac{3}{4}$

In every printing office there are occasions when the possession of a font or two of fractions is particularly desirable. To meet such an emergency the above were cast and fonted at merely nominal prices

Job Type Fractions in Fonts

ROYCROFT FRACTIONS

18 Point

Per font \$1.25

$\frac{1}{2}$ $\frac{1}{4}$ $\frac{3}{4}$ $\frac{1}{3}$ $\frac{2}{3}$ $\frac{1}{8}$
 $\frac{3}{8}$ $\frac{5}{8}$ $\frac{7}{8}$ $\%$ ¢

12 Point

Per font \$1.15

$\frac{1}{2}$ $\frac{1}{4}$ $\frac{3}{4}$ $\frac{1}{3}$ $\frac{2}{3}$ $\frac{1}{8}$
 $\frac{3}{8}$ $\frac{5}{8}$ $\frac{7}{8}$ $\%$ ¢

36 Point

Per font \$0.50

$\frac{1}{2}$ $\frac{1}{4}$ $\frac{3}{4}$ $\frac{1}{3}$ $\frac{2}{3}$ $\frac{1}{8}$
 $\frac{3}{8}$ $\frac{5}{8}$ $\frac{7}{8}$ $\%$ ¢

30 Point

Per font \$0.75

$\frac{1}{2}$ $\frac{1}{4}$ $\frac{3}{4}$ $\frac{1}{3}$ $\frac{2}{3}$ $\frac{1}{8}$ $\frac{3}{8}$
 $\frac{5}{8}$ $\frac{7}{8}$ $\%$ ¢

24 Point

Per font \$0.60

$\frac{1}{2}$ $\frac{1}{4}$ $\frac{3}{4}$ $\frac{1}{3}$ $\frac{2}{3}$ $\frac{1}{8}$ $\frac{3}{8}$ $\frac{5}{8}$ $\frac{7}{8}$ $\%$ ¢

18 Point

Per font \$0.50

$\frac{1}{2}$ $\frac{1}{4}$ $\frac{3}{4}$ $\frac{1}{3}$ $\frac{2}{3}$ $\frac{1}{8}$ $\frac{3}{8}$ $\frac{5}{8}$ $\frac{7}{8}$ $\%$ ¢

12 Point

Per font \$0.50

$\frac{1}{2}$ $\frac{1}{4}$ $\frac{3}{4}$ $\frac{1}{3}$ $\frac{2}{3}$ $\frac{1}{8}$ $\frac{3}{8}$ $\frac{5}{8}$ $\frac{7}{8}$ $\%$ ¢

10 Point

Per font \$0.50

Per font \$0.50

$\frac{1}{2}$ $\frac{1}{4}$ $\frac{3}{4}$ $\frac{1}{3}$ $\frac{2}{3}$ $\frac{1}{8}$ $\frac{3}{8}$ $\frac{5}{8}$ $\frac{7}{8}$ $\%$ ¢ $\frac{1}{2}$ $\frac{1}{4}$ $\frac{3}{4}$ $\frac{1}{3}$ $\frac{2}{3}$ $\frac{1}{8}$ $\frac{3}{8}$ $\frac{5}{8}$ $\frac{7}{8}$ $\%$ ¢

Job Type Fractions in Fonts, Accents

IONIC FRACTIONS

48 Point

$\frac{1}{2}$

$\frac{1}{4}$

$\frac{3}{4}$

$\frac{1}{3}$

$\frac{2}{3}$

Per font \$0 75

42 Point

$\frac{1}{2}$

$\frac{1}{4}$

$\frac{3}{4}$

$\frac{1}{3}$

$\frac{2}{3}$

Per font \$0 75

36 Point

$\frac{1}{2}$

$\frac{1}{4}$

$\frac{3}{4}$

$\frac{1}{3}$

$\frac{2}{3}$

Per font \$0 50

24 Point

$\frac{1}{2}$

$\frac{1}{4}$

$\frac{3}{4}$

$\frac{1}{3}$

$\frac{2}{3}$

Per font \$0 50

18 Point

$\frac{1}{2}$

$\frac{1}{4}$

$\frac{3}{4}$

$\frac{1}{3}$

$\frac{2}{3}$

Per font \$0 50

30 Point

$\frac{1}{2}$

$\frac{1}{4}$

$\frac{3}{4}$

$\frac{1}{3}$

$\frac{2}{3}$

Per font \$0 50

12 Point

$\frac{1}{2}$

$\frac{1}{4}$

$\frac{3}{4}$

$\frac{1}{3}$

$\frac{2}{3}$

Per font \$0 50

IONIC FRACTIONS No. 122

18 Point

$\frac{1}{2}$

$\frac{1}{4}$

$\frac{3}{4}$

$\frac{1}{3}$

$\frac{2}{3}$

$\frac{1}{8}$

$\frac{3}{8}$

$\frac{5}{8}$

$\frac{7}{8}$

$\frac{1}{6}$

$\frac{5}{16}$

$\frac{7}{16}$

$\frac{9}{16}$

$\frac{11}{16}$

$\frac{15}{16}$

Per font \$1 00

CONDENSED GOTHIC FRACTIONS No. 1

48 Point

$\frac{1}{4}$

$\frac{1}{2}$

$\frac{3}{4}$

$\frac{1}{3}$

Per font \$0 75

30 Point

$\frac{1}{4}$

$\frac{1}{2}$

$\frac{3}{4}$

$\frac{1}{3}$

Per font \$0 75

42 Point

$\frac{1}{4}$

$\frac{1}{2}$

$\frac{3}{4}$

$\frac{1}{3}$

Per font \$0 75

24 Point

$\frac{1}{4}$

$\frac{1}{2}$

$\frac{3}{4}$

$\frac{1}{3}$

Per font \$0 50

36 Point

$\frac{1}{4}$

$\frac{1}{2}$

$\frac{3}{4}$

$\frac{1}{3}$

Per font \$0 75

14 Point

$\frac{1}{4}$

$\frac{1}{2}$

$\frac{3}{4}$

$\frac{1}{3}$

Per font \$0 50

PIECE ACCENTS

12 Point No. 6

Per font \$1 25

8 Point No. 2

Per font \$1 00

12 Point

Per font \$1 25

6 Point

Per font \$1 00

12 Point No. 2

Per font \$1 00

6 Point No. 2

Per font \$1 00

10 Point No. 2

Per font \$1 00

4½ Point No. 2

Per font \$1 00

9 Point

Per font \$1 10

4 Point Set (12 Point Body)

Per font \$0 65

2 Point Set (6 Point Body)

Per font \$0 50

Advertising Figures in Fonts

ADVERTISING FIGURES

Series No. 72

Series No. 73

60 Point No. 72

5 lbs. \$2.70

60 Point No. 73

5 lbs. \$2.70

1234 5

123 4

48 Point No. 72

5 lbs. \$2.70

48 Point No. 73

5 lbs. \$2.70

4567890

1234 5

42 Point No. 72

5 lbs. \$2.70

42 Point No. 73

5 lbs. \$2.70

1234567 8

1234567

36 Point No. 72

5 lbs. \$2.80

36 Point No. 73

5 lbs. \$2.80

1234567 890

12345678

30 Point No. 72

5 lbs. \$2.80

30 Point No. 73

5 lbs. \$2.80

1234567 \$8.90

12345678 9

24 Point No. 72

5 lbs. \$2.80

24 Point No. 73

5 lbs. \$2.80

1234567890 \$4.23

123456 \$8.90

18 Point No. 72

5 lbs. \$3.00

18 Point No. 73

5 lbs. \$3.00

12345678901234567 8

123456789 \$1.20

16 Point No. 72

5 lbs. \$3.00

16 Point No. 73

5 lbs. \$3.00

123456789012345 \$147.39

12345678901234 56

12 Point No. 72

5 lbs. \$3.30

12 Point No. 73

5 lbs. \$3.30

1234567890135812345678 1912

123456789123456 1913

Advertising Figures in Fonts

ADVERTISING FIGURES

Series No. 69

72 Point No. 69

10 lbs. \$5 20

598

60 Point No. 69

5 lbs. \$2 70

76 3

54 Point No. 69

5 lbs. \$2 70

12 4

42 Point No. 69

5 lbs. \$2 70

80 \$7

36 Point No. 69

5 lbs. \$2 80

1234 5

30 Point No. 69

5 lbs. \$2 80

1234567

24 Point No. 69

5 lbs. \$2 80

1234567 8

18 Point No. 69

5 lbs. \$3 00

12345 \$7.89

16 Point No. 69

5 lbs. \$3 00

1234567 \$1.98

12 Point No. 69

5 lbs. \$3 30

1234567890 \$3.47

Series No. 70

72 Point No. 70

10 lbs. \$5 20

12 3

60 Point No. 70

5 lbs. \$2 70

456 7

54 Point No. 70

5 lbs. \$2 70

890 6

42 Point No. 70

5 lbs. \$2 70

342 \$15

36 Point No. 70

5 lbs. \$2 80

123456 7

30 Point No. 70

5 lbs. \$2 80

12345678 9

24 Point No. 70

5 lbs. \$2 80

123456789 0

18 Point No. 70

5 lbs. \$3 00

12345678 \$8.90

16 Point No. 70

5 lbs. \$3 00

1234567890 \$4.98

12 Point No. 70

5 lbs. \$3 30

1234567890 \$146.53

Advertising Figures in Fonts

ADVERTISING FIGURES

Series No. 67

Series No. 68

72 Point No. 67

10 lbs. \$5 20

72 Point No. 68

10 lbs. \$5 20

598

12 3

60 Point No. 67

5 lbs. \$2 70

60 Point No. 68

5 lbs. \$2 70

76 3

456 7

54 Point No. 67

5 lbs. \$2 70

54 Point No. 68

5 lbs. \$2 70

12 4

890 6

42 Point No. 67

5 lbs. \$2 70

42 Point No. 68

5 lbs. \$2 70

80 \$7

342 \$15

36 Point No. 67

5 lbs. \$2 80

36 Point No. 68

5 lbs. \$2 80

1234 5

123456 7

30 Point No. 67

5 lbs. \$2 80

30 Point No. 68

5 lbs. \$2 80

1234567

12345678 9

24 Point No. 67

5 lbs. \$2 80

24 Point No. 68

5 lbs. \$2 80

1234567 8

123456789 0

18 Point No. 67

5 lbs. \$3 00

18 Point No. 68

5 lbs. \$3 00

12345 \$7.89

12345678 \$8.90

16 Point No. 67

5 lbs. \$3 00

16 Point No. 68

5 lbs. \$3 00

1234567 \$1.98

1234567890 \$4.98

12 Point No. 67

5 lbs. \$3 30

12 Point No. 68

5 lbs. \$3 30

1234567890 \$3.47

1234567890 \$146.53

Advertising Figures in Fonts

ADVERTISING FIGURES

Series No. 63

60 Point No. 63

5 lbs. \$2 70

123456 7

54 Point No. 63

5 lbs. \$2 70

1234567 8

48 Point No. 63

5 lbs. \$2 70

12345678 9

42 Point No. 63

5 lbs. \$2 70

123456789 0

36 Point No. 63

5 lbs. \$2 80

1234567890 \$1

30 Point No. 63

5 lbs. \$2 80

1234567890 78c

24 Point No. 63

5 lbs. \$2 80

1234567890 \$37.06

18 Point No. 63

5 lbs. \$3 00

1234567890 \$49,500.00

12 Point No. 63

5 lbs. \$3 30

1234567890 \$7329518.46

Series No. 66

60 Point No. 66

5 lbs. \$3 00

123 4

54 Point No. 66

5 lbs. \$3 00

456 7

48 Point No. 66

5 lbs. \$3 00

67890

42 Point No. 66

5 lbs. \$3 00

1234 5

36 Point No. 66

5 lbs. \$3 10

12345 6

30 Point No. 66

5 lbs. \$3 10

123456 7

24 Point No. 66

5 lbs. \$3 20

12345678 9

18 Point No. 66

5 lbs. \$3 30

1234567890 \$5

12 Point No. 66

5 lbs. \$3 70

1234567890 \$624395

A liberal sized font of Advertising Figures is a very handy adjunct to any composing room whether it be a job or newspaper office. The several series shown in this catalogue offer an excellent variety of faces to choose from.

Advertising Figures in Fonts

ADVERTISING FIGURES

Series No. 61

Series No. 62

60 Point No. 61

5 lbs. \$2.70

60 Point No. 62

5 lbs. \$2.70

123 4

1234 5

54 Point No. 61

5 lbs. \$2.70

54 Point No. 62

5 lbs. \$2.70

1234 5

12345 6

48 Point No. 61

5 lbs. \$2.70

48 Point No. 62

5 lbs. \$2.70

5678 9

4567890

42 Point No. 61

5 lbs. \$2.70

42 Point No. 62

5 lbs. \$2.70

12345 6

1234567 8

36 Point No. 61

5 lbs. \$2.80

36 Point No. 62

5 lbs. \$2.80

123456 7

12345678 9

30 Point No. 61

5 lbs. \$2.80

30 Point No. 62

5 lbs. \$2.80

12345678

123456789 0

24 Point No. 61

5 lbs. \$2.80

24 Point No. 62

5 lbs. \$2.80

123456789 0

1234567890 \$1

18 Point No. 61

5 lbs. \$3.00

18 Point No. 62

5 lbs. \$3.00

1234567890 \$

1234567890 \$3.95

12 Point No. 61

5 lbs. \$3.30

12 Point No. 62

5 lbs. \$3.30

1234567890 \$6435.29

1234567890 \$521437.95

A liberal supply of Advertising Figures should be in every composing room. They readily pay for themselves in a very short time.

Advertising Figures in Fonts

ADVERTISING FIGURES

Series No. 53

60 Point No. 53

5 lbs. \$2 70

1 2 3 4

48 Point No. 53

5 lbs. \$2 70

5 6 7 8 9

42 Point No. 53

5 lbs. \$2 70

1 2 3 4 5 6

36 Point No. 53

5 lbs. \$2 80

1 2 3 4 \$ 5 6

30 Point No. 53

5 lbs. \$2 80

1 2 3 4 5 6 7 8

24 Point No. 53

5 lbs. \$2 80

1 2 3 4 5 6 7 8 9 0

20 Point No. 53

5 lbs. \$3 00

1 2 3 4 5 6 7 8 9 \$ 3 0

18 Point No. 53

5 lbs. \$3 00

1 2 3 4 5 6 7 8 9 0 \$ 1 9 . 3 4

16 Point No. 53

5 lbs. \$3 00

1 2 3 4 5 6 7 8 0 9 0 1 3 5 8

12 Point No. 53

5 lbs. \$3 30

1 2 3 4 5 6 7 8 9 0 \$ 1 4 7 . 9 8

Series No. 54

60 Point No. 54

5 lbs. \$2 70

1 2 3 4 5

48 Point No. 54

5 lbs. \$2 70

6 7 8 9 0 4

42 Point No. 54

5 lbs. \$2 70

1 2 3 4 5 6 7 8

36 Point No. 54

5 lbs. \$2 80

1 2 3 4 5 \$ 9 . 6 7

30 Point No. 54

5 lbs. \$2 80

1 2 3 4 5 6 7 8 9 0 c

24 Point No. 54

5 lbs. \$2 80

1 2 3 4 5 6 7 8 \$ 9 . 9 0

20 Point No. 54

5 lbs. \$3 00

1 2 3 4 5 6 5 7 8 9 7 \$ 1 . 9 0

18 Point No. 54

5 lbs. \$3 00

1 2 3 4 5 6 7 8 9 0 1 2 3 4 \$ 1 8 . 7 6

16 Point No. 54

5 lbs. \$3 00

1 2 3 4 5 6 7 8 9 0 1 2 3 4 1 5 6 5 0 c

12 Point No. 54

5 lbs. \$3 30

1 2 3 4 5 6 7 8 9 0 1 2 3 4 5 6 7 8 \$ 1 6 2 . 9 8

Advertising Figures in Fonts

ADVERTISING FIGURES

Series No. 50

48 Point No. 50 5 lbs. \$2 70

123456

36 Point No. 50 5 lbs. \$2 80

123456 78

30 Point No. 50 5 lbs. \$2 80

12345 \$6.78

24 Point No. 50 5 lbs. \$2 80

12345678 90c

20 Point No. 50 5 lbs. \$3 00

123456780 \$6.32

18 Point No. 50 5 lbs. \$3 00

1234567890860 \$1.65

16 Point No. 50 5 lbs. \$3 00

1234567890135 \$9.27

12 Point No. 50 5 lbs. \$3 30

1234567890123456789 \$2.98

Series No. 51

48 Point No. 51 5 lbs. \$2 70

1234567

36 Point No. 51 5 lbs. \$2 80

1234567890

30 Point No. 51 5 lbs. \$2 80

12345678 30c

24 Point No. 51 5 lbs. \$2 80

123456789 \$1.80

20 Point No. 51 5 lbs. \$3 00

1234567890368 78c

18 Point No. 51 5 lbs. \$3 00

12345678906789 \$14.62

16 Point No. 51 5 lbs. \$3 00

12345678904567890 90c

12 Point No. 51 5 lbs. \$3 30

1234567890123456789 \$137.98

Series No. 52

48 Point No. 52 5 lbs. \$2 70

123456 7

36 Point No. 52 5 lbs. \$2 80

12345678 90c

30 Point No. 52 5 lbs. \$2 80

12345670 \$9.89

24 Point No. 52 5 lbs. \$2 80

123456789023 46c

20 Point No. 52 5 lbs. \$3 00

1234567890678 \$253.89

18 Point No. 52 5 lbs. \$3 00

12345678901234567891 60c

16 Point No. 52 5 lbs. \$3 00

1234567890135789 \$19.80

12 Point No. 52 5 lbs. \$3 30

1234567890 13588531 \$25341.89

60 Point is also made for the three Series shown on this page, 5 lbs. \$2 70

Advertising Figures in Fonts

ADVERTISING FIGURES

Series No. 65

60 Point No. 65 5 lbs. \$2 70

123 4

54 Point No. 65 5 lbs. \$2 70

567 8

48 Point No. 65 5 lbs. \$2 70

1234 5

42 Point No. 65 5 lbs. \$2 70

15678 9

36 Point No. 65 5 lbs. \$2 80

1234567

30 Point No. 65 5 lbs. \$2 80

12345678

24 Point No. 65 5 lbs. \$2 80

1234567890

18 Point No. 65 5 lbs. \$3 00

1234567890 \$

12 Point No. 65 5 lbs. \$3 30

1234567890 \$428.59

Series No. 60

60 Point No. 60 5 lbs. \$2 70

123 4

54 Point No. 60 5 lbs. \$2 70

567 8

48 Point No. 60 5 lbs. \$2 70

1234 5

42 Point No. 60 5 lbs. \$2 70

56789 0

36 Point No. 60 5 lbs. \$2 80

123456 7

30 Point No. 60 5 lbs. \$2 80

12345678 9

24 Point No. 60 5 lbs. \$2 80

12345678 \$90

20 Point No. 60 5 lbs. \$3 00

1234567890 \$8

18 Point No. 60 5 lbs. \$3 00

1234567890 \$4

16 Point No. 60 5 lbs. \$3 00

1234567890 \$248.3

12 Point No. 60 5 lbs. \$3 30

12345678901358 \$47.98

A liberal sized font of Advertising Figures is a very handy adjunct to any composing room whether it be a job or news office. The several series shown in this catalogue offer an excellent variety of faces to choose from.

Advertising Figures in Fonts

ADVERTISING FIGURES

Series No. 64

72 Point No. 64

10 lbs. \$5 20

56789 0

60 Point No. 64

5 lbs. \$2 70

123456 7

48 Point No. 64

5 lbs. \$2 70

23456789 0

36 Point No. 64

5 lbs. \$2 80

1234567890 \$2

30 Point No. 64

5 lbs. \$2 80

1234567890 \$43

24 Point No. 64

5 lbs. \$2 80

1234567890 \$25.90

18 Point No. 64

5 lbs. \$3 00

1234567890 \$28456.57

12 Point No. 64

5 lbs. \$3 30

1234567890 \$834269.75

Series No. 71

60 Point No. 71

5 lbs. \$2 70

123 4

54 Point No. 71

5 lbs. \$2 70

1234 5

42 Point No. 71

5 lbs. \$2 70

678 \$90

36 Point No. 71

5 lbs. \$2 80

123456 7

30 Point No. 71

5 lbs. \$2 80

12345 678

24 Point No. 71

5 lbs. \$2 80

123456789 0

20 Point No. 71

5 lbs. \$3 00

123456789 \$10

16 Point No. 71

5 lbs. \$3 00

1234567890 \$2.98

12 Point No. 71

5 lbs. \$3 30

1234567890345 \$147.49

Chessmen and Checkers

CHESSMEN

24 Point

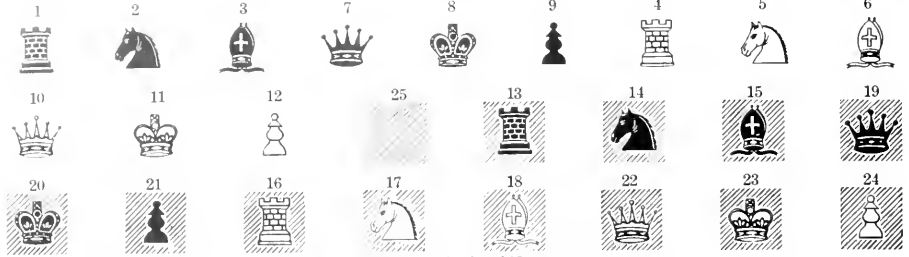

Per font \$4 80

24 Point Chessmen makes board 17 ems square

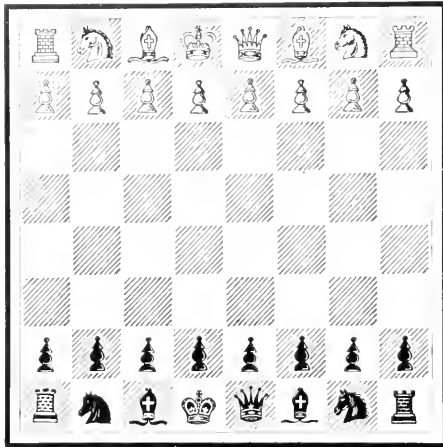

20 Point



Per font \$4 80

20 Point Chessmen makes board 14 1-3 ems square

16 Point

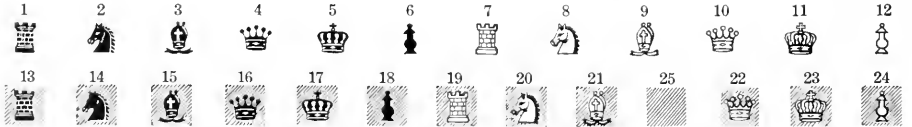

Per font \$3 40

16 Point Chessmen makes board 11 2-3 ems square

CHECKERS

24 Point



Per font \$3 40

24 Point Checkers makes board 17 ems square

20 Point



Per font \$3 40

20 Point Checkers makes board 14 1-3 ems square

16 Point



Per font \$3 40

16 Point Checkers makes board 11 2-3 ems square

11 Point

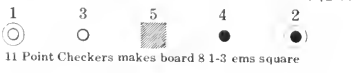

Per font \$2 00

11 Point Checkers makes board 8 1-3 ems square

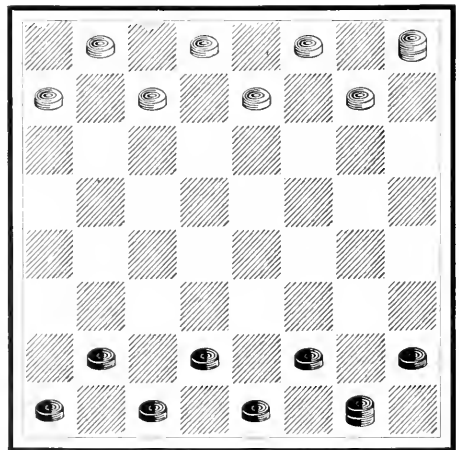

Prices for Chessmen and Checkers include brass rule border as shown in the above examples

Calendar Figures in Fonts

CALENDAR FIGURES

No. 6001 \$5 35

78

No. 1810 \$0 50

168

No. 6905 \$5 60

26

No. 1802 \$0 50

937

No. 2410 \$0 80

168

No. 2402 \$0 75

937

No. 5401 \$4 20

78

No. 3010 \$1 15

168

No. 5405 \$4 35

26

No. 3002 \$1 05

937

No. 4801 \$3 20

78

No. 3610 \$1 85

168

No. 4805 \$3 45

26

No. 3602 \$1 45

937

No. 4201 \$2 60

78

No. 4210 \$2 50

168

No. 4205 \$2 65

26

No. 4202 \$2 00

937

No. 3601 \$1 90

78

No. 4810 \$3 25

168

No. 3605 \$2 00

26

No. 4802 \$2 60

937

No. 3001 \$1 35

78

No. 5410 \$4 10

168

No. 3005 \$1 35

26

No. 5402 \$3 25

937

No. 2401 \$0 90

78

No. 6010 \$4 80

168

No. 2405 \$0 90

26

No. 6002 \$4 30

937

No. 1801 \$0 60

78

No. 1805 \$0 60

26

Each font contains sufficient figures for any one month of the year. You would often have occasion to set up a monthly calendar if you possessed a font of these figures. They are inexpensive and a good investment.

Improved Perpetual Calendars

24 POINT CHELTENHAM CALENDAR No. 14

1914 MAY 1914



Fonts include one each of the date logos, seven blanks, one each of the day logos, sufficient type, figures and spaces for every month of the year from 1912 to 1932 inclusive



12345678906876543

1 2 23

1913		MARCH					1913	
SUN	MON	TUE	WED	THU	FRI	SAT		
SEND FOR PAMPHLET SHOWING COMPLETE LINE OF THESE CALENDARS							1	
2	3	4	5	6	7	8		
9	10	11	12	13	14	15		
16	17	18	19	20	21	22		
23 30	24 31	25	26	27	28	29		

PRICES AND SIZES OF CHELTENHAM CALENDARS

With the Style of Figures Shown on this Page

10 Point No. 11, Complete, \$1.00
12 Point No. 12, Complete, 1.25

18 Point No. 13, Complete, \$1.75
24 Point No. 14, Complete, 2.25
36 Point No. 15, Complete, 4.00

48 Point No. 16, Complete, \$7.00
60 Point No. 17, Complete, 9.00

Send for pamphlet showing complete series

36 POINT CHELTENHAM CALENDAR No. 15

1913		AUGUST					1913	
SUN	MON	TUE	WED	THU	FRI	SAT		
THE AMERICAN TYPE FOUNDERS COMPANY SELLS THE BEST OF EVERYTHING FOR THE PRINTER					1	2		
3	4	5	6	7	8	9		
10	11	12	13	14	15	16		
17	18	19	20	21	22	23		
24 31	25	26	27	28	29	30		

SUN WED 23 30 24 31 SAT

Improved Perpetual Calendars

24 POINT CHELTENHAM CALENDAR No. 24

1914							AUGUST							1914						
Su	Mo	Tu	We	Th	Fr	Sa														
						1														
2	3	4	5	6	7	8														
9	10	11	12	13	14	15														
16	17	18	19	20	21	22														
23 30	24 31	25	26	27	28	29														

1912 FEBRUARY 1912



Fonts include one each of the date logos, seven blanks, one each of the day logos, sufficient type, figures and spaces for every month of the year from 1912 to 1932 inclusive



12345678901234567890513974

1	23 30	24 31	16	20	29	
---	----------	----------	----	----	----	--

PRICES AND SIZES OF CHELTENHAM CALENDARS

With the Style of Figures shown on this Page

10 Point No. 21, Complete, \$1.00
12 Point No. 22, Complete, 1.25

18 Point No. 23, Complete, \$1.75
24 Point No. 24, Complete, 2.00
36 Point No. 25, Complete, 3.50

48 Point No. 26, Complete, \$5.50
60 Point No. 27, Complete, 7.50

Send for pamphlet showing complete series

36 POINT CHELTENHAM CALENDAR No. 25

MARCH



Fonts include one each of the date logos, seven blanks, one each of the day logos, sufficient type, figures and spaces for every month of the year from 1912 to 1932 inclusive



123456789

5	24 31
---	----------

1915							NOVEMBER							1915						
Su	Mo	Tu	We	Th	Fr	Sa														
	1	2	3	4	5	6														
7	8	9	10	11	12	13														
14	15	16	17	18	19	20														
21	22	23	24	25	26	27														
28	29	30	WE SELL THE BEST OF EVERYTHING FOR THE PRINTER																	

Sectional Calendars

Rules and Figures for One Month with
Changes for Ten Years

Sun | Mon | **OCTOBER** | Fri | Sat

9 **18** **24** **30**

1912 **SEPTEMBER** 1

Sun | Mon | Tue | Wed | Thu | Fri

1	2	3	4	5	6	
8	9	10	11	12	13	14
15	16	<i>Sectional Calendar No. 8.—\$4.00</i>		20	21	
22	23	24	25	26	27	28
29	30					

1 2 3 4 5 6 7 8 9 0

12 Sun | **29**

Mon | Tue |

MARCH

1912 **AUGUST** 1912

Sun | Mon | Tue | Wed | Thu | Fri | Sat

				1	2	3
4	5	6	7	8	9	10
11	12	13	14	15	16	17
18	19	20	21	22	23	24
25	26	27	28	29	30	31

Sectional Calendar No. 5.—\$2.50

These figures are frequently used for baseball scores, and are sold separately at our pound prices.

1913 **JANUARY** 1913

Sun | Mon | Tue | Wed | Thu | Fri | Sat

			1	2	3	4
5	6	7	8	9	10	11
12	13	14	15	16	17	18
19	20	21	22	23	24	25
26	27	28	29	30	31	

*Sectional Calendar
No. 6.—\$3.00*

OUR SECTIONAL CALENDARS ARE DECIDEDLY LABOR-SAVING

Cards, Indicators, Arrows and Recipe Marks

CARD PIPS, Series No. 1

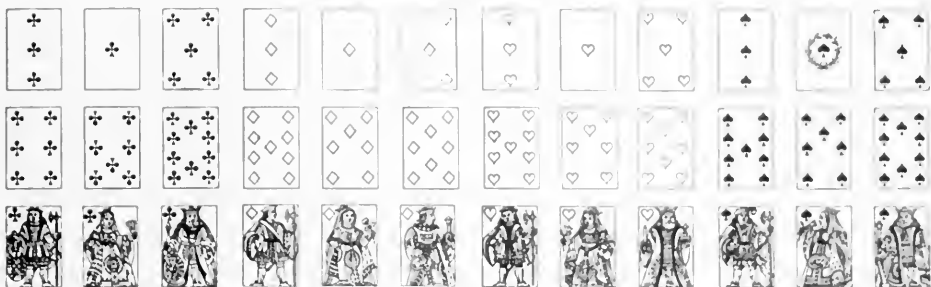

32 Point body, 24 Point set. Per font 52 Pieces \$5 00. Single character each 10c

CARD INDICATORS

Series No. 1



Set of four 40c

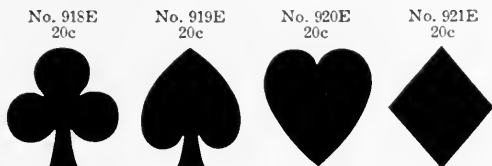

Set of four 50c

Series No. 2



24 Pt. Per font \$1 75

Series No. 3



10 Pt. Per lb. \$1 30
12 Pt. Per lb. \$1 16

Cast to order on 10 Point or 12 Point body

CARD INDICATORS

Series No. 4

3 ♠	A ♠	4 ♠	♠ 4
6 ◇	J ◇	K ◇	A ◇
7 ◇	9 ◇	2 ◇	Q ◇
♥ 9	♥ 10	5 ◇	10 ◇
♠ 2	♠ A	♠ 3	♠ 7
♥ 2	♠ J	♠ Q	♠ K
♥ 3	♥ 6	♥ A	♥ 4
2 ♠	♠ 5	♥ 5	♥ 5
5 ♠	♠ 6	K ♠	8 ◇
6 ♠	♠ 9	7 ♠	4 ◇
9 ♠	10 ♠	8 ♠	3 ◇
♥ Q	♥ K	10 ♠	♠ 8
♥ 7	♥ 8	Q ♠	♥ J

6 Point Per font \$5 50

Complete with rules, leads and spaces

The American Type Founders Company makes about everything that a printer can find use for. If you don't find what you want please write us.

WHIST MARKERS

18 Point
Per lb. \$1 00



ARROWS

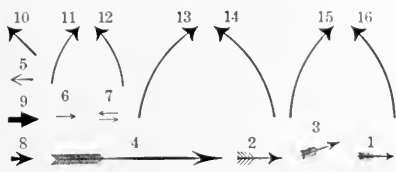

For Advertising Purposes. Per font \$1 00

RECIPE MARKS

1E

5c

R

2E

5c

R

4E

5c

R

8E

6c

R

9E

10c

R

10E

20c

R

7E

6c

R

6E

6c

R

5E

6c

R

3E

5c

R

11E 10c

R

12E 6c

R

2410F

15c

R

1999A

15c

R

12D

15c

R

2415F

15c

R

13E 6c

R

1991A

15c

R

2420F

10c

R

2412F

10c

R

Baseball Blanks, Figures, Seals and Brands

BASEBALL BLANKS

12 Point Baseball Blanks Per font \$0 50
Contains 90 Type—all 12 Point set



18 Point Baseball Blanks Per font \$0 75
Contains 72 Type—all 18 Point set



In order to save time in printing editions where forms are stereotyped, total runs may be stamped in the blanks by reversed dies.

BASEBALL FIGURES

12 Point Baseball Figures

Per font \$1 00

Lancaster 1 2 3 4 5 6 7 8 9
 Reading 2 0 0 0 1 3 0 0 2 — 8
 0 1 0 2 0 2 4 0 x — 9

Font contains 66 figure 1, 24 figure 2, 20 figure 3, 18 figure 4, 16 figure 5, 10 each figures 6, 7, 8, 9, and 154 figure 0, 8 character x, and 16 en blanks—all 6 Point set.

18 Point Baseball Figures

Per font \$1 50

New York 1 2 3 4 5 6 7 8 9
 0 0 0 0 0 1 0 3 1 — 5
 Detroit 1 4 3 4 1 0 3 0 x — 16

Font contains 56 figure 1, 20 figure 2, 16 figure 3, 14 figure 4, 12 figure 5, 10 each figures 6, 7, 8, 9, and 120 figure 0, 6 character x, and 12 en blanks—all 9 Point set.

SLOCUM SEALS

Per font of each character \$1 00



96 Point 40c



24 Point 10c



36 Point 15c



72 Point 30c



60 Point 25c

ENGRAVING BLANKS

The Numbers indicate the size in points—thus: No. 7218 is 72x18 points.

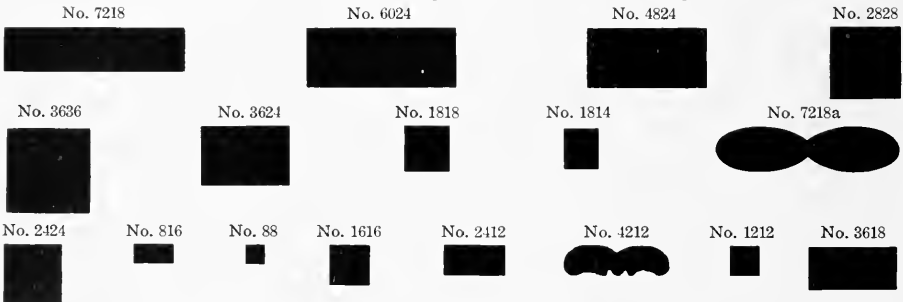

No.	Each	1 lb. and over per lb.	No. Characters to Pound
7218	\$0 25	\$0 58	16
7218a	25	58	16
6024	20	60	14
4824	20	60	18
4212	15	60	40
3636	15	62	16

No.	Each	1 lb. and over per lb.	No. Characters to Pound
3624	\$0 15	\$0 62	24
3618	15	62	32
2828	15	62	26
2424	10	64	36
2412	10	64	72
1818	06	66	64

No.	Each	1 lb. and over per lb.	No. Characters to Pound
1814	\$0 06	\$0 66	32
1616	06	68	80
1212	05	74	144
816	05	1 00	160
88	05	1 00	320

CATTLE BRANDS



No. 1 30c



No. 2 30c



No. 3 35c



No. 4 35c

Stars, Maltese Crosses and Seals

FIVE POINTED BLACK STARS

201F	202F	203F	204F	205F	206F	207F	208F	209F	210F	211F	212F	213F	214F	215F	
★	★	★	★	★	★	★	★	★	★	★	★	★	★	★	
220F			219F				218F			217F		216F			
201F, 50 type.....	\$0.50	206F, 50 type..	\$0.50	211F, 30 type	\$0.50	216F, 8 type	\$0.50	202F, 50 type.....	.50	207F, 50 type..	.50	212F, 30 type..	.50	217F, 8 type	.50
203F, 50 type.....	.50	208F, 50 type..	.50	213F, 15 type	.50	218F, 1 type	.50	204F, 50 type.....	.50	209F, 50 type..	.50	214F, 15 type	.50	219F, 4 type	.50
205F, 50 type.....	.50	210F, 50 type..	.50	215F, 15 type	.50	220F, 4 type	.50	201F to 215F, 4 of each size.....							\$1.00

FIVE POINTED OUTLINE STARS

230F	231F	232F	233F	234F	235F	236F	316B	317B									
☆	☆	☆	☆	☆	☆	☆	☆	☆									
230F, 50 type.....	\$0.50	234F, 10 type..	\$0.50	316B, 4 type	\$0.50	317B, 4 type..	.50	231F, 50 type.....	.50	235F, 10 type..	.50	232F, 50 type.....	.50	233F, 10 type.....	.50	236F, 4 type..	.50

FIVE POINTED SHADED STARS

323B	322B	321B	320B	319B	318B						
318B, 50 type..	\$0.50	321B, 8 type..	\$0.50	319B, 30 type..	.50	322B, 8 type..	.50	320B, 15 type..	.50	323B, 4 type..	.50

MALTESE CROSSES—BLACK

311B	310B	309B	308B	307B	306B	305B	304B							
301B	302B	303B	304B, 50 type.....	\$0.50	305B, 15 type..	.50	308B, 8 type..	\$0.50	309B, 8 type..	.50	310B, 4 type	.60	311B, 4 type	.60
301B, 50 type.....	\$0.50	302B, 50 type.....	.50	303B, 50 type.....	.50	306B, 15 type..	.50	307B, 15 type..	.50					

MALTESE CROSSES—OUTLINE

317B	316B	315B	314B	313B	312B						
312B, 4 type... ..	\$0.60	314B, 8 type..	\$0.50	316B, 15 type...	\$0.50	317B, 15 type...	.50	313B, 4 type...	.60	315B, 8 type..	.50

LOCUS SIGILLI

661E 15c	453E 10c	311E 10c	513E 10c	354D 10c	554D 15c

Weather Signals, Theatre Logos and Election Signs

WEATHER SIGNALS

36 Point
No. 1



Fair

No. 2



Rain or Snow

No. 3



Local Rain or Snow

No. 4



Temperature

Per set \$0 50
No. 5



Cold Wave

24 Point
No. 1



No. 2



No. 3



No. 4



Per set \$0 50
No. 5



INTERPRETATION OF DISPLAYS

No. 1, alone, indicates fair weather, stationary temperature.
No. 2, alone, indicates rain or snow, stationary temperature.
No. 3, alone, indicates local rain or snow, stationary temperature.
No. 1, with No. 4 above it, indicates fair weather, warmer.
No. 1, with No. 4 below it, indicates fair weather, colder.

No. 2, with No. 4 above it, indicates rain or snow, warmer.
No. 2, with No. 4 below it, indicates rain or snow, colder.
No. 3, with No. 4 above it, indicates local rain or snow, warmer.
No. 3, with No. 4 below it, indicates local rain or snow, colder.

WEATHER INDICATORS

36 Point
No. 1



No. 2



No. 3



No. 4



No. 5



No. 6



No. 7



No. 8



No. 9



No. 10



Each \$0 15 Per font \$1 75

THEATRE LOGOTYPES No. 1

12 Point Body Five of each character

Per font \$2 75

MONDAY TUESDAY WEDN'DAY THURSDAY FRIDAY
SATURDAY SUNDAY
JAN. FEB. MCH. APL. MAY JUNE JULY AUG. SEP. OCT. NOV.
DEC. EVG. EVENING MAT. MATINEE

THEATRE LOGOTYPES No. 2

20 Point Body Three of each character

Per font \$1 00

JAN FEB MAR APR MAY JUNE JULY AUG
SEP OCT NOV DEC

ELECTION TICKET SIGNS



12055



18055



18509



20502



30022

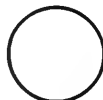

42502



42503



18517



20518



24519



36520

No. 18517, 18 Point body . each, 6c; per pound, 66c
 No. 20518, 20 Point body . each, 6c; per pound, 66c

No. 30022, 30 Point body . each, 10c; per pound, 62c
 No. 42502, 42 Point body . each, 15c; per pound, 60c
 No. 42503, 42 Point body . each, 15c; per pound, 60c

No. 24519, 24 Point body . each, 10c; per pound, 64c
 No. 36520, 36 Point body . each, 15c; per pound, 62c

Artistic Paragraph Marks in Fonts

PRIORY

Font No. 11
 (Containing 8, 10, 12, 14, 18, 24 and 30 Point sizes) \$1.00
 Font No. 12
 (Containing 36, 42, 48, 60 and 72 Point sizes) \$1.00

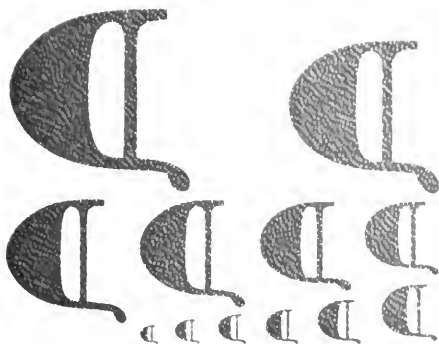

PRIORY OPEN

Font No. 13
 (Containing 8, 10, 12, 14, 18, 24 and 30 Point sizes) \$1.00
 Font No. 14
 (Containing 36, 42, 48, 60 and 72 Point sizes) \$1.00



CASLON TEXT

Font No. 21
 (Containing 6, 8, 10, 12, 14, 18, 24 and 30 Pt. sizes) \$1.00
 Font No. 22
 (Containing 36, 48, 60 and 72 Point sizes) \$1.00

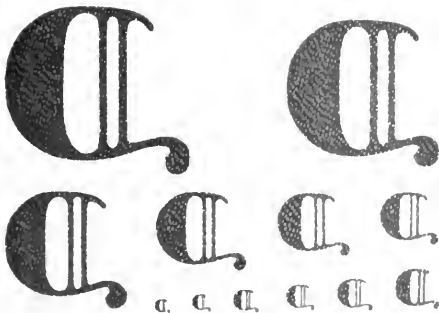

DOOLEY

Font No. 3
 (Containing 6, 8, 10, 12, 14, 18, 24 and 30 Pt. sizes) \$1.00
 Font No. 4
 (Containing 36, 42, 48, 60 and 72 Point sizes) \$1.00



CHELTENHAM

Font No. 4
 (Containing 6, 8, 10, 12, 14, 18, 24 and 30 Pt. sizes) \$1.00
 Font No. 5
 (Containing 36, 42, 48, 60 and 72 Point sizes) \$1.00

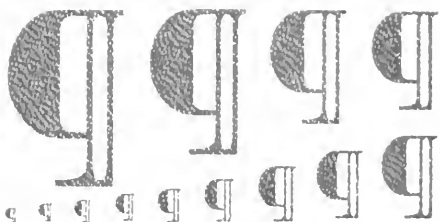

DELLA ROBBIA

Font No. 9
 (Containing 6, 8, 10, 12, 14, 18, 24 and 30 Pt. sizes) \$1.00
 Font No. 10
 (Containing 36, 42, 48, 54, 60 and 72 Point sizes) \$1.00



BEWICK

Font No. 6
 (Containing 6, 8, 10, 12, 18, 24 and 30 Point sizes) \$1.00
 Font No. 7
 (Containing 36, 48, 60 and 72 Point sizes) \$1.00



Chap-Book Guildons, which include a variety of Decorative Paragraph Marks, are shown on page 98 of this Catalogue

Trade Marks Made by the Adcut Process

ADCUTS



750

Telephone Connection



720



778



TRADE MARK

304



172



626



566



326

Lion Collars

755



771



570

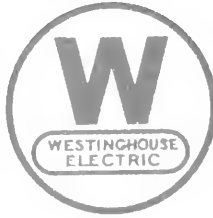

351



"LION BRAND"

756



625



619



560

SPECIAL ATTENTION TO TELEPHONE ORDERS

580



708



802



467



219



521



212



779



ESTABLISHED 1802

607



622



624



630



808



466



71



217



63



103



663



718



616



709



522



651

Remington-UMC

642



367

Agricultural Insurance Company of Watertown, N.Y.

628

TRADE MARKS CAST IN TYPE METAL

On this page are shown a number of well-known trade-marks and devices made by our Adcut process. By this process the original design is accurately reproduced in type metal at a figure conceded to be less than that charged for electrotypes, when one hundred or more Adcuts are ordered at a time. Every Adcut is of uniform height and cast on point body. We have published a handsome pamphlet giving the scale of prices of Adcuts besides much interesting information regarding trade-marks. If interested, send to our ADCUT DEPARTMENT for a copy of this pamphlet.

Trade Marks Made by the Adcut Process

ADCUTS



379



158



667



117



195



84



13



391



109



116



346



163



99



767



356



652
Color 653



404



406



261



221
Color 222



776



612
Color 611



73



11



161



165
Color 166



14

TRADE MARKS CAST IN TYPE METAL

The well-known trade devices shown on this page are but a few that have also been reproduced by our Adcut process. The cheapness of Adcuts makes it practicable to use all kinds of trade devices more generously and effectively than heretofore. It is not often that an article recommends itself as being cheaper and very much better in quality, but the examination of an Adcut, which will be sent on request, will convince at a glance that Adcuts form an exception. Printers prefer Adcuts to electrotypes because they are absolutely uniform in height and all other dimensions, and perfectly flat on top, justifying with the type better and also printing better.

Send to our ADCUT DEPARTMENT for a copy of our Adcut Pamphlet giving prices and any information desired.

ADCUTS and Cast Index Cuts

ADCUTS

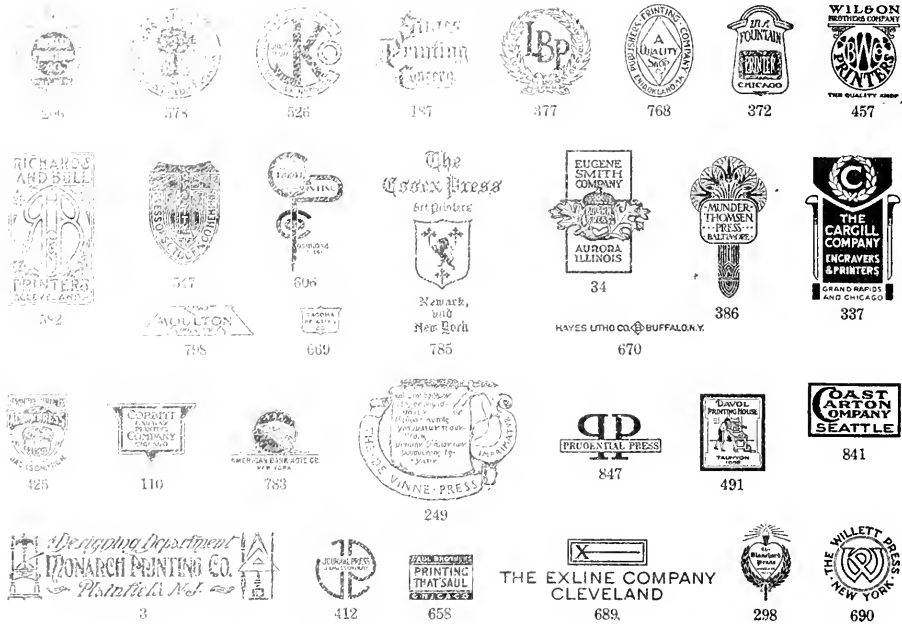

We have reproduced hundreds of imprints for printers and publishers by our Adcut process and our customers find them superior to electrotypes. Adcuts are sold only in quantities of one hundred or more each size and design. If you are interested ask for our Adcut pamphlet, which contains a complete scale of prices and gives much other valuable information regarding this new method of casting cuts in type molds.

CAST INDEX CUTS

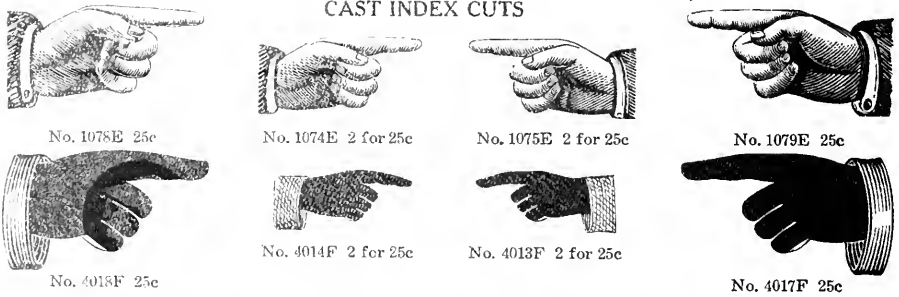

FONTED INDEX CUTS

Per font, one of each, 50c

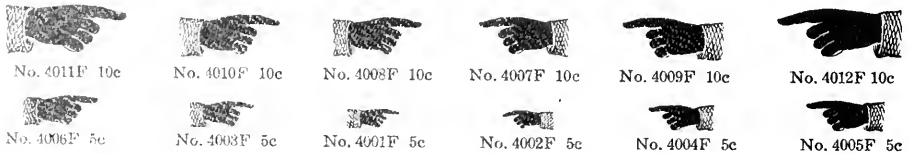

NEW CAST INDEX CUTS

Per font, one of each, 50c

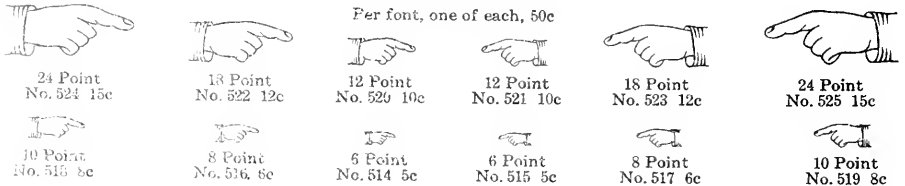

Decorative Material

The addition of suitable Decorative Material, costing but a trifle, will add dollars' worth of selling value to many kinds of Printing, without increasing the cost of production. Those who have had advertising experience know that an appropriate and emblematic ornament photographically impresses the mind of the reader of an advertisement and cinches the argument



AMERICAN TYPE FOUNDERS
COMPANY

Della Robbia Initials



1. Point No. 100. 2. Point No. 100. 3. Point No. 100. 4. Point No. 100. 5. Point No. 100. 6. Point No. 100.

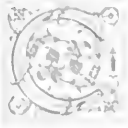

Point No. 100 7. Point No. 100	Point No. 100 8. Point No. 100	Point No. 100 9. Point No. 100
<p>In addition to the 11 Point and 12 Point sets of Faces and 12 Faces we can supply a complete set of Della Robbia Initials in 11 and 12 line sizes for various letterheads.</p>		



Versatile Initials



No. 12005 60c



No. 12006 60c Color 60c



No. 12007 60c



No. 7215 40c Color 40c



No. 7216 40c Color 40c



No. 7217 40c Color 40c



No. 7218 40c Color 40c



No. 7233 40c

AN ARRAY of new and original designs in Borders, Ornaments and Initials has been added to the Versatile Series. The Initials shown on this and the following page will add that subtle charm which is so often sought for in high-class job printing. Watch for our specimens, which are sent out from time to time, and keep your plant always up-to-date

**AMERICAN
TYPE FOUNDERS
COMPANY**

ORIGINATOR OF STYLISH TYPE DESIGNS



No. 7219 40c Color 40c



No. 7220 40c Color 40c



No. 7221 40c Color 40c



No. 7239 40c Color 40c



No. 9601 50c Color 50c

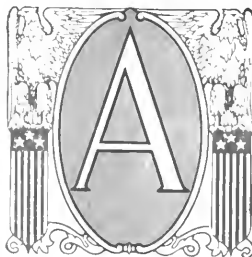

No. 9602 50c Color 50c



No. 7204 40c

Versatile Initials



No. 7034 (Color Plate)

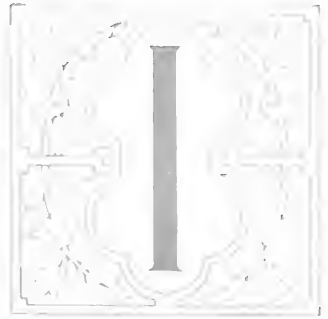

No. 7205 (Color Plate)



No. 7000



No. 7000



No. 7000



No. 7000

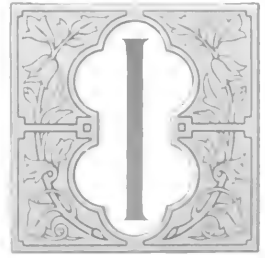

No. 7046 (Color Plate)



No. 7209 (Color Plate)



No. 7000

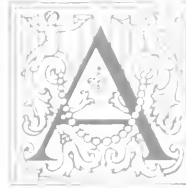

No. 7000



No. 7000



No. 7000



No. 7000



No. 7000



No. 7000



Burford Initials



48 Point

Single Letter 20c

3 A Font, including backgrounds, \$4.30



72 Point

Single Letter 25c

3 A Font, including backgrounds, \$7.50



60 Point

Single Letter 20c

3 A Font, including backgrounds, \$7.00



36 Point

Single Letter 15c

3 A Font, including backgrounds, \$3.00



Five backgrounds, for use in two-color work, are included with each font of Burford Initials



Hearst Initials



18 Point

Single Letter 10c

3A Font \$1.00



18 Point Single Letter 10c 3A Font \$1.00

A	B	C	D	E	F
G	H	I	J	K	L
M	N	O	P	Q	R

30 Point Single Letter 10c 3A Font \$2.00

A	B	C	D	E	F	G
H	I	J	K	L	M	N
O	P	Q	R	S	T	U

24 Point Single Letter 10c 3A Font \$1.00

A	B	C	D	E	F	G	H
I	J	K	L	M	N	O	P
Q	R	S	T	U	V	W	X

18 Point Single Letter 10c 3A Font \$1.00

A	B	C	D	E	F	G	H	I	J
K	L	M	N	O	P	Q	R	S	T

Font: <http://www.dafont.com> File: <http://www.dafont.com> & Cursive: <http://www.dafont.com>



Schoeffer Oldstyle Initials

A

B

C

D

E

F

48 Point

Single Letter 20c

Per Font \$2.00

Z

Y

X

W

V

U

T

S

36 Point	Single Letter 15c	Per Font \$1.25							
A	B	C	D	E	F				
G	H	I	J	K	L				
M	N	O	P	Q	R				
S	T	U	V	W	X				
24 Point	Single Letter 10c	Per Font \$1.00							
A	B	C	D	E	F	G			
H	I	J	K	L	M	N			
O	P	Q	R	S	T	U			
V	W	X	Y	Z	A	B			
15 Point	Single Letter 10c	3 A Font \$1.00							
A	B	C	D	E	F	G	H	I	J
K	L	M	N	O	P	Q	R	S	T
U	V	W	X	Y	Z	A	B	C	D

G

H

I

J

K

L

M

N

R

Q

P

O

Cincinnati Initials

No. 1160 64 Point Ornamental



Per Font \$3.00 Each 30c

No. 1157 64 Point Outline



Per Font \$3.00 Each 30c

No. 52 64 Point Two Color
Combination of Nos. 1148 and 1156



Per Font \$5.50 Each 50c

No. 1156 64 Point Plain



Per Font \$3.00 Each 30c

No. 1159 48 Point Ornamental



Per Font \$1.50 Each 20c

No. 1158 32 Point Ornamental



Per Font \$1.25 Each 15c

No. 1155 48 Point Plain



Per Font \$1.50 Each 20c

No. 1154 32 Point Plain



Per Font \$1.25 Each 15c

No. 51 48 Point Two Color
Combination of Nos. 1147 and 1155



Per Font \$2.75 Each 35c

No. 50 32 Point Two Color
Combination of Nos. 1116 and 1154



Per Font \$2.50 Each 30c

No. 1146 32 Point Outline



Per Font \$1.25 Each 15c

No. 1147 48 Point Outline



Per Font \$1.50 Each 20c

No. 49 24 Point Two Color
Combination of Nos. 1153 and 1157



Per Font \$1.40 Each 20c

No. 1157 24 Point Outline



Per Font 75c Each 10c

No. 1153 24 Point Plain



Per Font 75c Each 10c

American Type Founders Company

Caxton Initials and Missal Initials

CAXTON INITIALS

7 Point

3 A \$9.95

A B C D

60 Point

3 A \$6.75

E F  G H

This Ornament included with each Font

48 Point

4 A \$5.05

I J K L M N

36 Point

4 A \$3.70

O P Q R S T U

24 Point

5 A \$2.05

V W X Y Z A B C D E F

18 Point

6 A \$1.65

12 Point

8 A \$1.20

G H I J K L M N O P Q R S T U V W X

MISSAL INITIALS

60 Point

3 A \$7.00

A B C D E

48 Point

4 A \$5.00

F G H I J K

36 Point

4 A \$4.00

L M N O P Q R

24 Point

5 A \$2.50

18 Point

6 A \$1.75

S T U V W X Y Z A B C D E

12 Point

8 A \$1.25

10 Point

8 A \$1.00

F G H I J K L M N O P Q R S T U V W X Y Z A B C

Department Store Initials and French Cast Squares

DEPARTMENT STORE INITIALS

Accurately Cast in Type, Metal

36 Point



24 Point

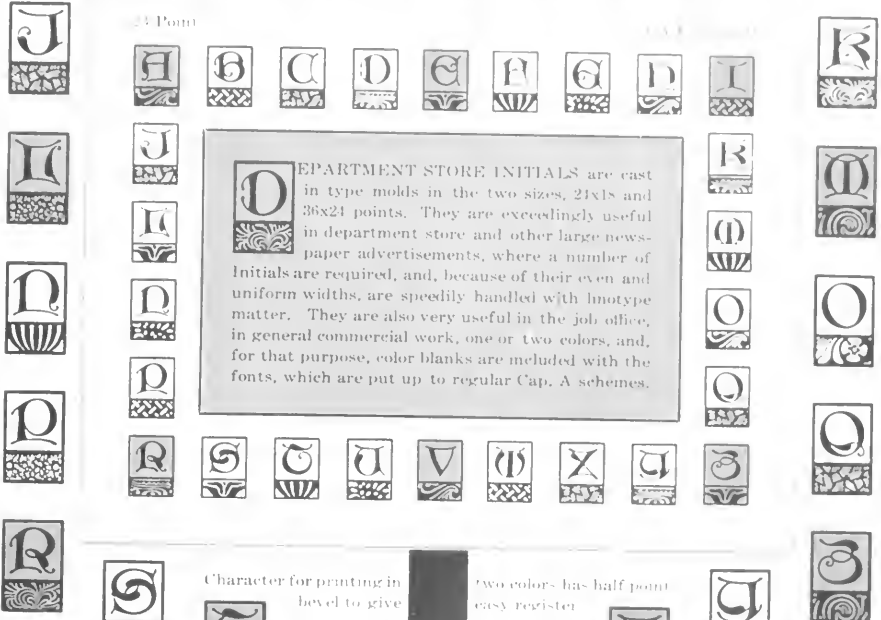

DEPARTMENT STORE INITIALS are cast in type molds in the two sizes, 24x18 and 36x24 points. They are exceedingly useful in department store and other large newspaper advertisements, where a number of initials are required, and, because of their even and uniform widths, are speedily handled with linotype matter. They are also very useful in the job office, in general commercial work, one or two colors, and, for that purpose, color blanks are included with the fonts, which are put up to regular Cap. A schemes.

Character for printing in
bevel to give

two colors, has half point
easy register

FRENCH CAST SQUARES

FRENCH CAST SQUARES are made in the five sizes, 12, 18, 24, 30 and 36 point, for printing in one or two colors. They are designed for use with one of the most useful brass rule faces with which a printing office can be provided: 1 point face, flush to side of a 1 1/2 point body. Two of these files, bevel to bevel, will "match up" with the little black corner squares in the 12 point size, and only require even point spacing for the other sizes. In the middle, or between these two parallel lines, place whatever material that is necessary to give "balance" to the word.

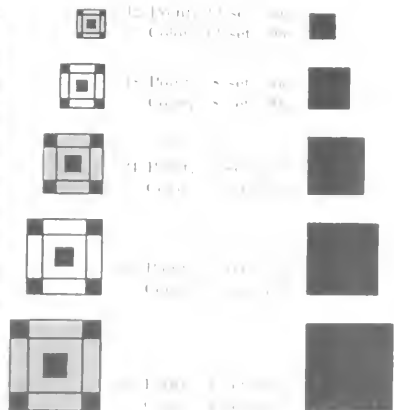

Dutch Initials

120 Point

Single Letter 60c

Font of 25 Characters \$11.00

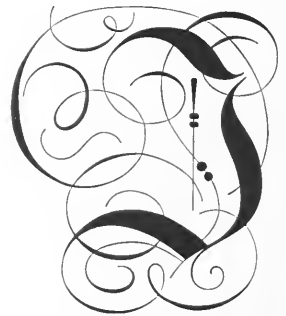
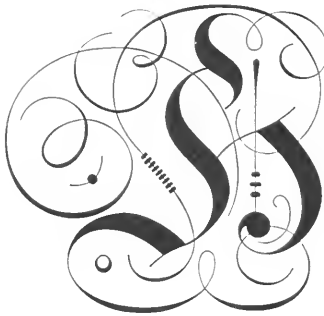
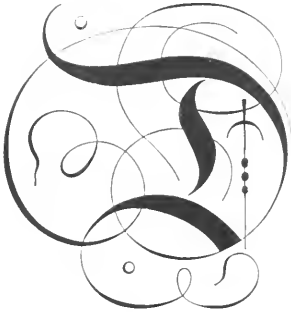
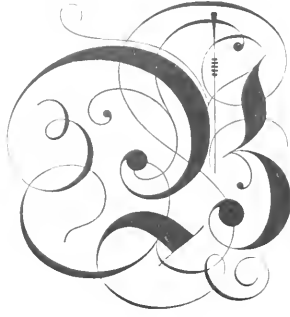
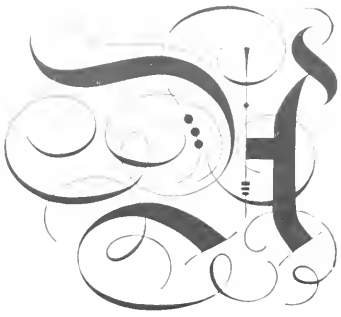

84 Point

Single Letter 35c

Font of 25 Characters \$6.50

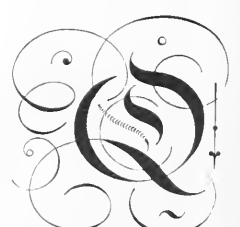
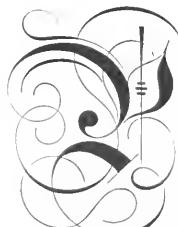
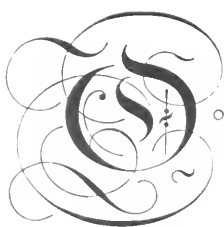
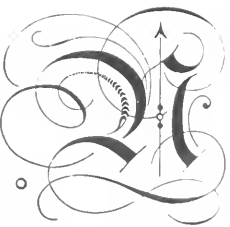
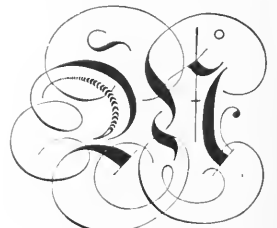

Dutch Initials are cast in type molds

Dutch Initials

60 Point

Single Letter 20

Font of 25 Characters \$1.75

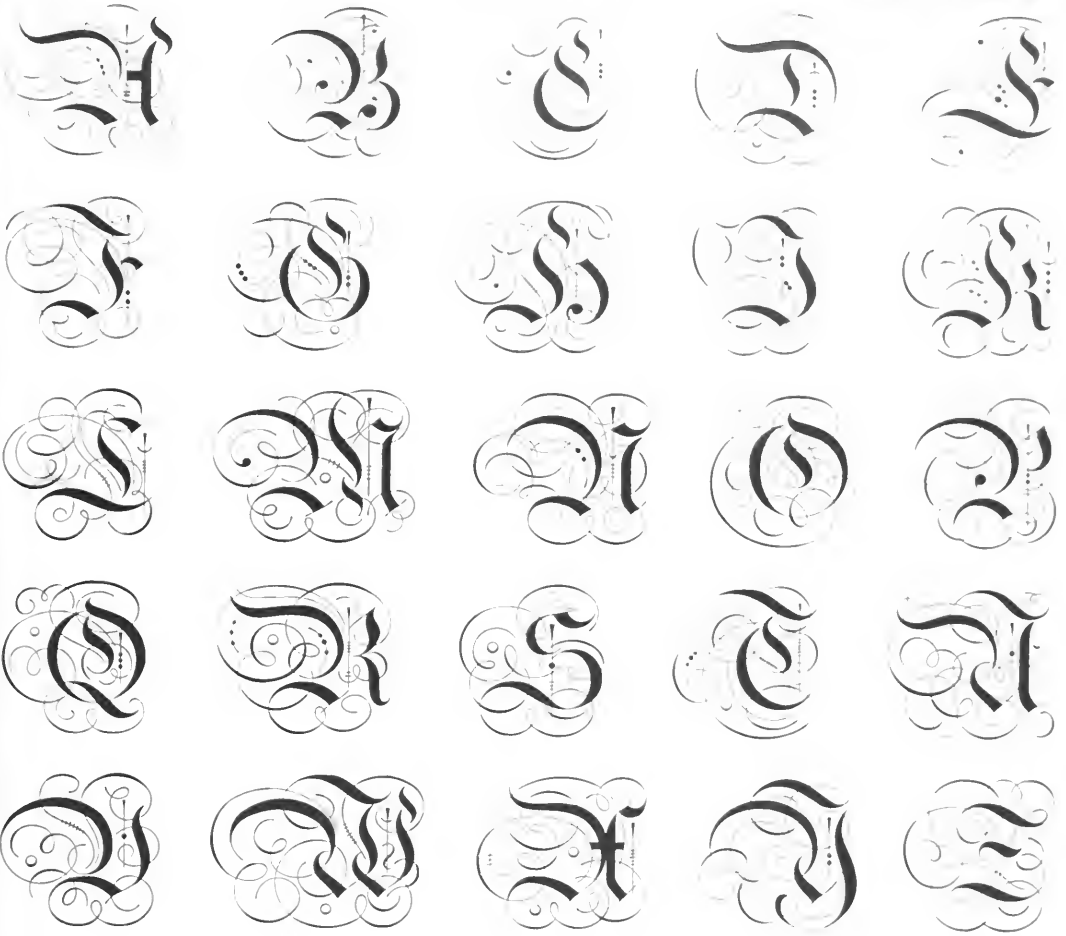

48 Point

Single Letter 20c

Font of 25 Characters \$1.75

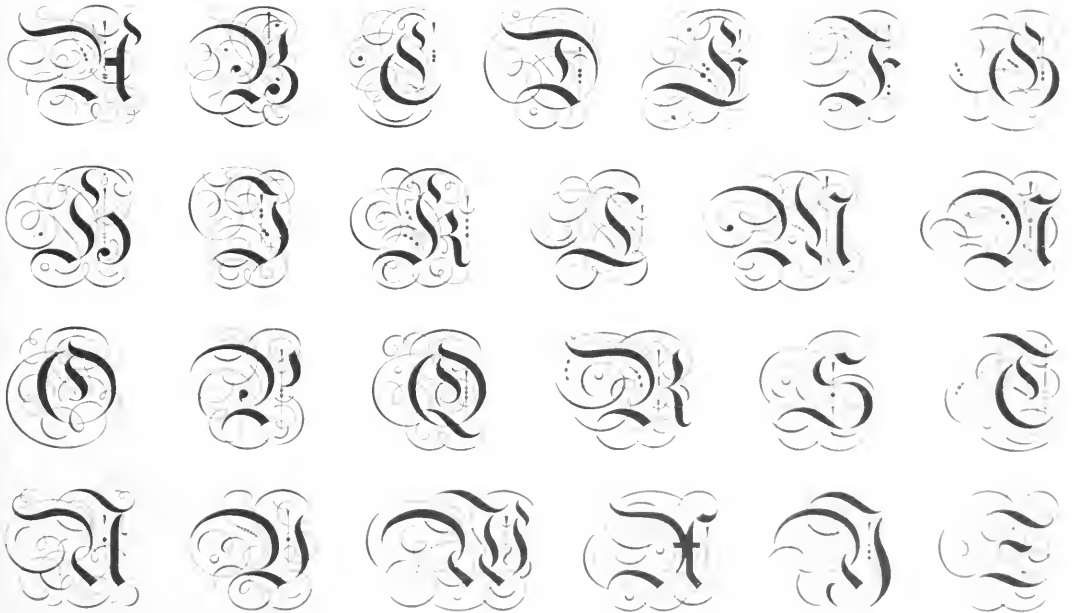

Dutch Initials are also made in 42 Point. Single Letter 15c
Complete Font of 25 Characters \$1.50

Jenson Initials and Busha Mortised Initials

JENSON INITIALS No. 79

72 Point

Single Letter 30c



No. 7213



No. 7218



No. 7211



No. 7225

JENSON INITIALS No. 80

18 Point

Single Letter 20c

Font of 23 letters (V X Z not made) \$2.00



JENSON INITIALS No. 82

30 Point

Single Letter 10c

Font of 24 letters (V X not made) \$1.00



72 Point

BUSHA MORTISED INITIALS

Single Character 35c



1C



2C



3C



4C



5C



6C



7C



8C



9C



10C



11C



12C

Jenson Initials and Busha Mortised Initials as shown on this page are cast in type molds.

Bradley Initials and Versatile Mortised Ornaments

BRADLEY INITIALS

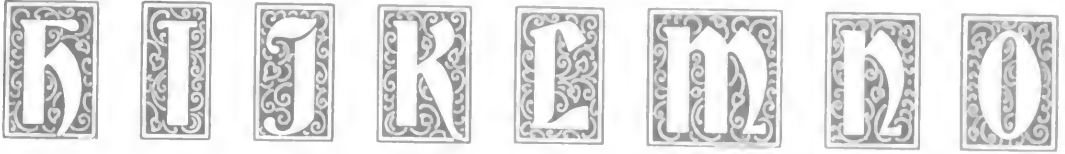

No. 1212 60c



No. 1211 60c

VERSATILE MORTISED ORNAMENTS

An original and striking series of initial designs. Cast in type molds on point body.

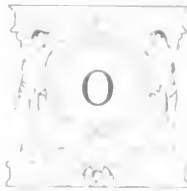

No. 1213 60c



No. 1214 60c

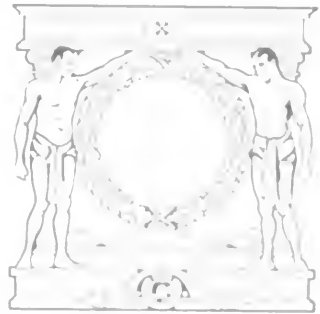

No. 1215 60c



No. 1217 60c

AMERICAN
TYPE FOUNDERS CO.

Strathmore Mortised Initials



120 Point No. 2 60c



120 Point No. 8 60c



120 Point No. 3 60c



96 Point No. 2 50c



72 Point No. 8 40c



72 Point No. 3 40c



96 Point No. 3 50c

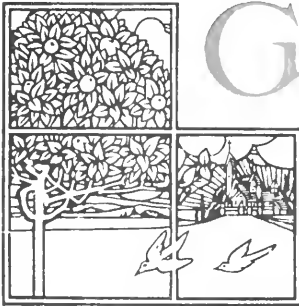

120 Point No. 4 60c



120 Point No. 5 60c



120 Point No. 7 60c



72 Point No. 2 40c



72 Point No. 7 40c



96 Point No. 6 50c



72 Point No. 10 40c

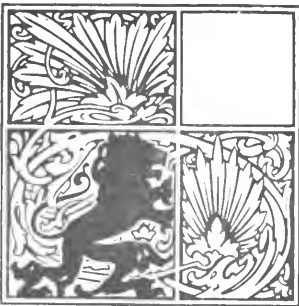

120 Point No. 1 60c



120 Point No. 10 60c



120 Point No. 6 60c

Strathmore and Renaissance Initials

STRATHMORE MORTISED INITIALS

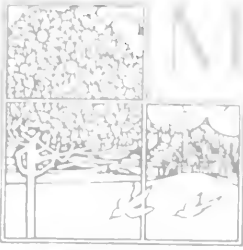

70 Point No. 111



70 Point No. 112

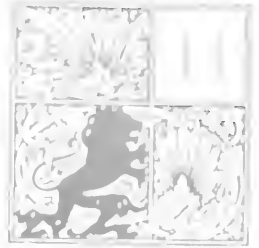

70 Point No. 113

Mortised in Letter

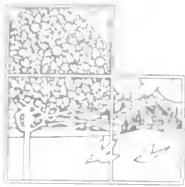

72 Point No. 114



72 Point No. 115
No. 211 Center

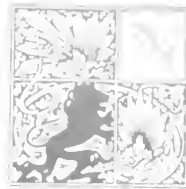

72 Point No. 116



72 Point No. 117



96 Point No. 118



72 Point No. 119

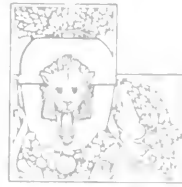

72 Point No. 120



72 Point No. 121

AMERICAN TYPE FOUNDERS
COMPANY

RENAISSANCE MORTISED INITIALS



100 Point No. 122

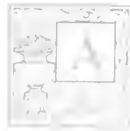

100 Point No. 123



100 Point No. 124



100 Point No. 125



100 Point No. 126

AMERICAN TYPE

THE BEST TYPE

Wood-Cut Mortised Initial Squares



No. 12026 60c



No. 12023 60c



No. 12025 60c

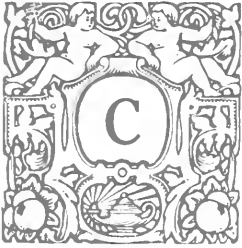

No. 9625 50c



No. 7227 40c

THE mortises in these initials are cast accurately to points both ways, so that types of the same body as the mortises fit without justification, while the smaller types are justified with point leads or spaces. This method of casting the mortises is used exclusively by the American Type Founders Co. and insures the printer a great saving of time and annoyance in both justification and printing. The body is also point set



No. 9623 50c



No. 7225 40c



No. 7224 40c



No. 9624 50c



No. 7226 40c



No. 7223 40c



No. 9626 50c



No. 12024 60c



No. 9627 50c



No. 12027 60c

Sectional Initial Formers

Group A



Group C Complete \$1.25

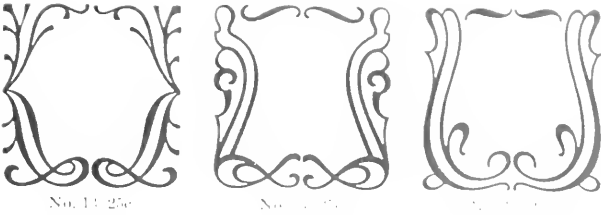

Group D Complete \$1.25

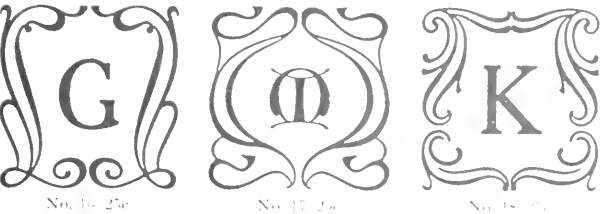

Group E Complete \$1.00

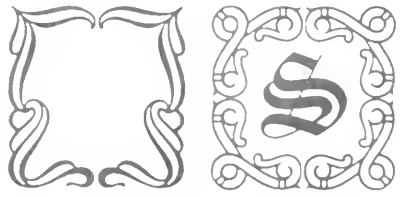
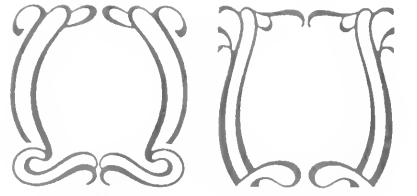
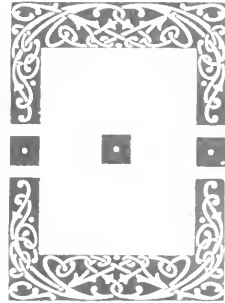

Group F Complete \$1.00

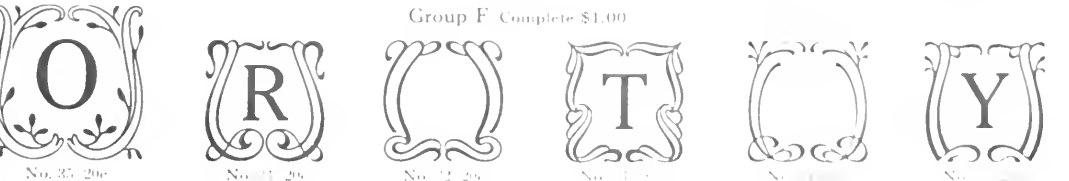

Baseball Series No. 2



No. 11 45c



No. 17 35c



No. 15 40c



No. 21 35c



No. 19 45c

BASEBALL SERIES No. 2

There are many times and places where our baseball illustrators may be used to a great advantage. Everybody is interested in the National game and attention to an advertisement or announcement is more readily attracted by their use. Our baseball cuts are made in convenient sizes and will add to the value of any baseball printing

Per Font \$3.25

Individual characters at prices quoted

Each font contains one each of characters 11 to 21 inclusive and three of character 22. All are cast in type molds on point body



No. 18 45c



No. 12 35c



No. 16 35c



No. 11 50c



No. 13 35c No. 22 10c



No. 20 50c

Baseball Series No. 3 and No. 1



No. 23



No. 24



No. 25



No. 26



No. 27



No. 28-29

BASEBALL SERIES No. 3

Per Font \$2.25

This font contains one each of characters Nos. 23 to 33 inclusive and three of character No. 34. Individual characters are furnished at prices quoted. All are cast in type molds on point body and point set, thus guaranteeing quick justification.



No. 30-31



No. 29-30c



No. 27-30c No. 34-10c



No. 29-10c



No. 27-10c

Single Character 25c

BASEBALL SERIES No. 1

Per Font \$1.00



No. 1



No. 6



No. 2



No. 3



No. 4



No. 5



No. 7



No. 8



No. 9



No. 10

Aerial Cuts

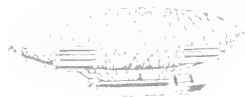

No. 6 20c

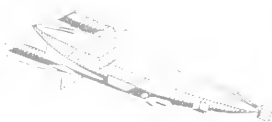

No. 21 30c

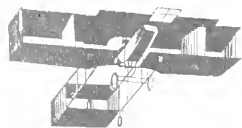

No. 3 25c

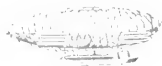

No. 5 15c



No. 9 15c



No. 8 10c



No. 15 15c



No. 11 10c

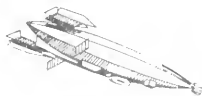

No. 20 20c



No. 2 20c



No. 11 15c



No. 24 25c



No. 23 20c



No. 18 15c



No. 17 10c

THIS original and attractive series of Aerial cuts is sure to be often used. It will be appreciated by advertisers and also will prove of value to the printer having the series in his composing room. You will have many opportunities to use these new aviation illustrators

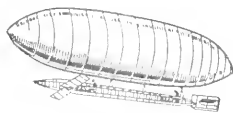

No. 12 20c

Per Font \$2.25

Separate characters at the prices indicated

Font contains four each of characters 8, 11 and 17, two each 5, 9, 11, 15, 18 and 23 one each 2, 3, 6, 12, 20, 21 and 24

**AMERICAN
TYPE FOUNDERS
COMPANY**

AMERICAN TYPE FOUNDERS CO.

ORIGINATOR OF STYLISH TYPE FACES

Army and Navy Shows, Navy Exercises

ARMY SHOWS



NAVY EXERCISES



Grand Military Celebration

MODERN AIR, FIELD AND SEA DEMONSTRATIONS

BEGINNING MONDAY, MARCH 29, 11:30 A. M. (S. E. TIME)
 ENDING SUNDAY, APRIL 10, 11:30 P. M.

Souvenir Programme



WARSHIPS - BATTLE LINE



CASUALTY REPORT



Golf Illustrators



No. 1. 60c



No. 19. 60c



No. 18. 70c



No. 10. 40c

THE GAME OF GOLF FOLLOWS CLOSELY TO BASEBALL AS TO POPULARITY. A SERIES OF GOLF ILLUSTRATORS WILL PROVE A GOOD INVESTMENT TO EVERY PRINTER

For additional golf cut see page 104.



No. 20. 60c

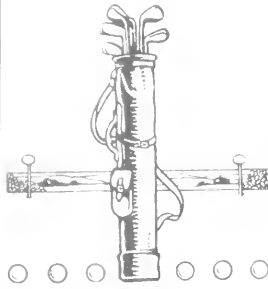

No. 16. 60c



No. 3. 35c

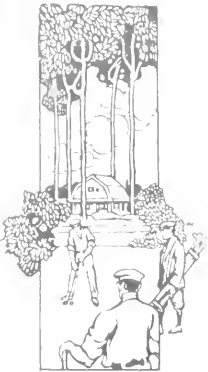

No. 11. 50c



No. 8. 35c



No. 14. 70c



No. 6. 35c

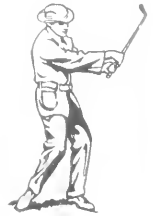

No. 7. 35c

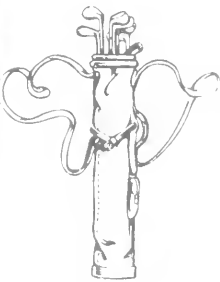

No. 15. 60c



No. 2. 35c



No. 14. 70c



No. 1. 35c



No. 9. 40c



No. 12. 40c



No. 13. 60c



No. 4. 35c



No. 5. 40c

Golf Illustrators



No. 13 1/2c



No. 14 1/2c



No. 15 1/2c



No. 18 1/2c



No. 21 45c



No. 28 50c



No. 31 50c

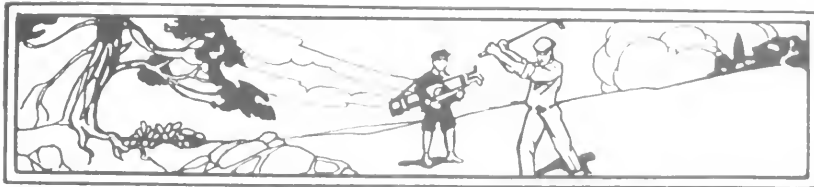

No. 39 51 1/2c



No. 23 45c



Bulfinch Attractors



No. 2 96 Point 40c

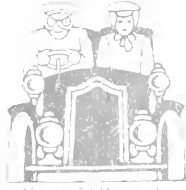

No. 11 72 Point 25c



No. 14 72 Point 25c

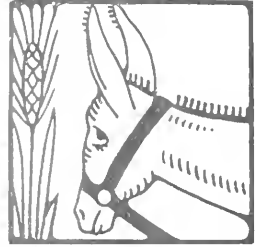

No. 5 96 Point 40c



No. 1 96 Point 40c



No. 13 72 Point 25c

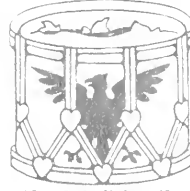

No. 15 72 Point 25c



No. 8 96 Point 40c



No. 17 72 Point 25c



No. 18 72 Point 25c

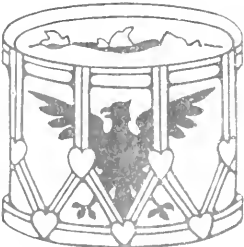

No. 4 96 Point 40c



No. 20 72 Point 25c



No. 21 72 Point 25c

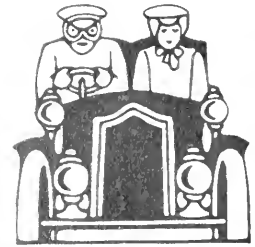

No. 11 96 Point 40c



No. 9 96 Point 40c



No. 1 96 Point 40c



No. 12 72 Point 25c



No. 7 96 Point 40c



No. 10 96 Point 40c

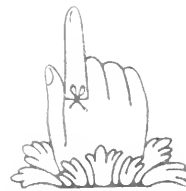

No. 16 72 Point 25c

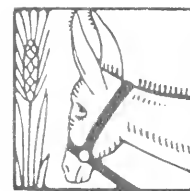

No. 13 72 Point 25c

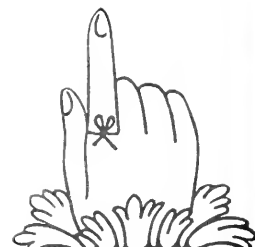

No. 5 96 Point 40c

Holiday Decorators

The Holiday Decorators have been the means of creating a great amount of new business for progressive printers, extraordinary when compared with the prices of the Decorators. Printers who have profited by buying new designs to attract more business inform us that on investments of a few dollars they have secured many additional orders amounting to hundreds of dollars.



No. 209 65c



No. 11 60c

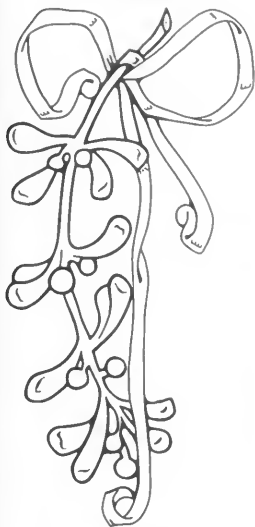

No. 5 80c

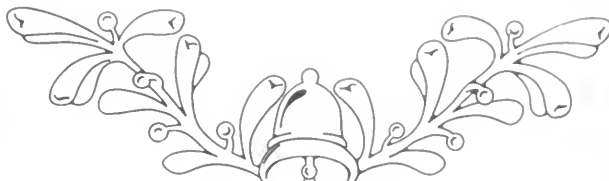

No. 91 80c

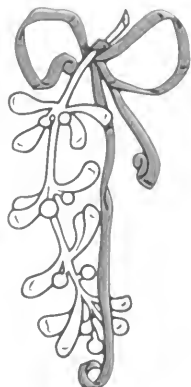

No. 6 50c
No. 120 Color 40c



No. 65 90c



No. 174 45c



No. 12 40c

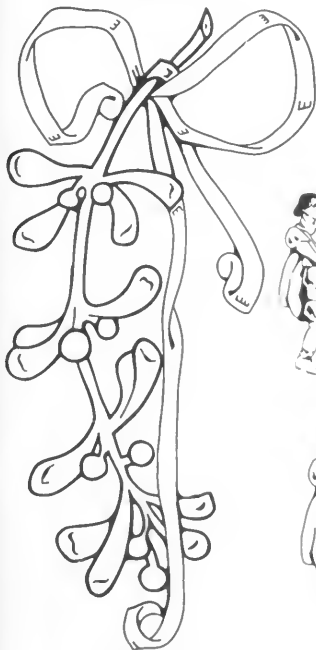

No. 4 \$1.00



No. 99 40c No. 122 Color 25c



No. 67 45c



No. 102 45c

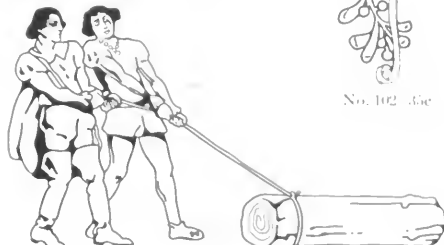

No. 66 70c



No. 10 80c

Holiday Decorators



No. 7 70c

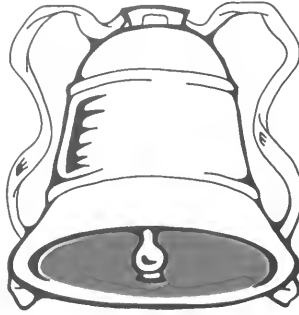

No. 10 60c No. 123 Color 35c

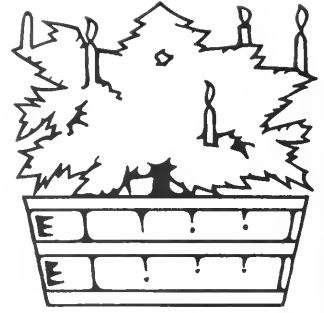

No. 19 60c



No. 8 50c

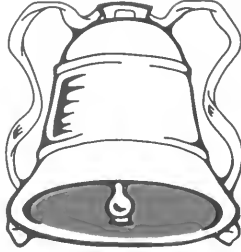

No. 11 45c
No. 121 Color 30c

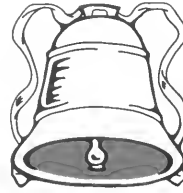

No. 12 35c
No. 125 Color 25c

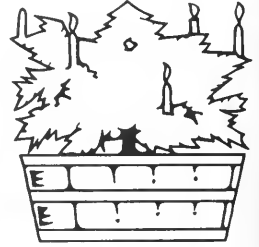

No. 20 45c

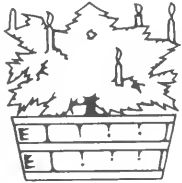

No. 21 35c



No. 90 45c



No. 100 30c



No. 9 40c



No. 108 30c

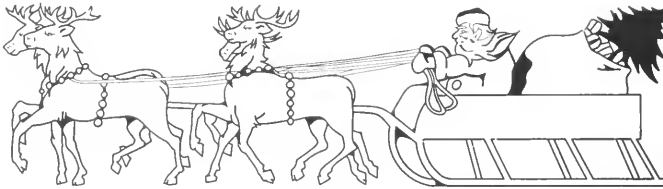

No. 89 85c



No. 104 30c
No. 130 Color 20c



No. 106 20c

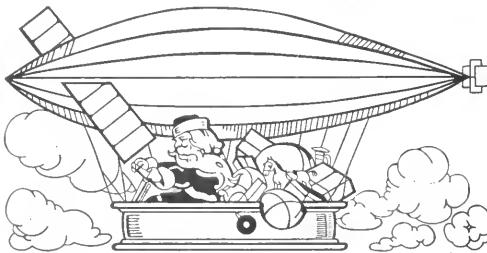

No. 145 80c

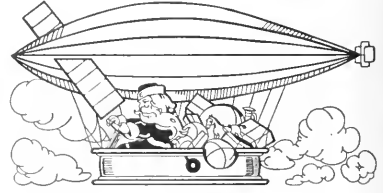

No. 146 60c



No. 105 20c
No. 131 Color 15c

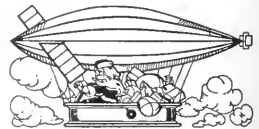

No. 147 35c

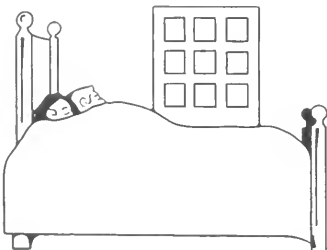

No. 85 50c

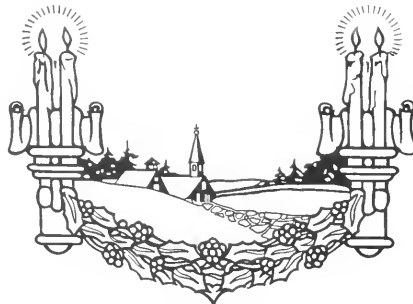

No. 197 70c



No. 196 35c

Holiday Decorators



No. 60 30c



No. 57 30c



No. 165 20c

No. 64 25c



No. 166 30c



No. 167 30c

No. 62 25c



No. 58 30c



No. 61 30c



No. 103 35c



No. 43 40c
No. 114 Color 35c

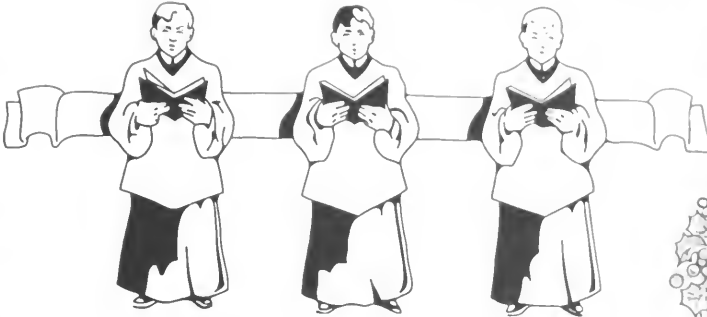

No. 44 \$1.00



No. 113 30c



No. 92 50c

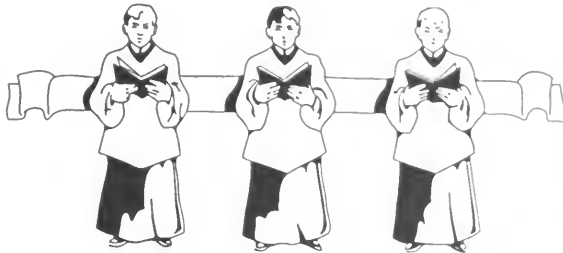

No. 45 75c

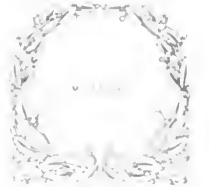

No. 111 35c

No. 93 40c

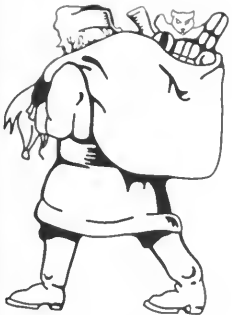

No. 31 45c

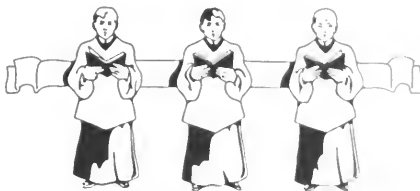

No. 46 60c



No. 33 30c



No. 32 35c



No. 162 25c



No. 163 35c



No. 164 25c



No. 81 40c



No. 82 35c



No. 83 30c



No. 119 25c



No. 111 30c



No. 112 30c

Holiday Decorators

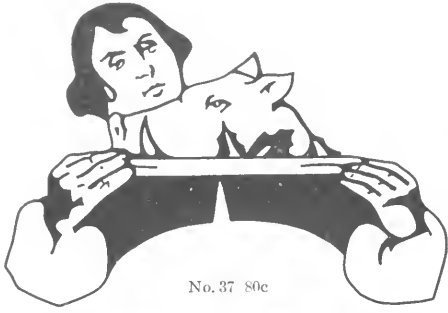

No. 37 80c



No. 183 35c

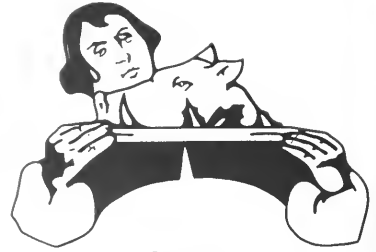

No. 38 60c



No. 80 65c



No. 171 80c



No. 148 90c



No. 204 45c



No. 205 75c



No. 150 60c

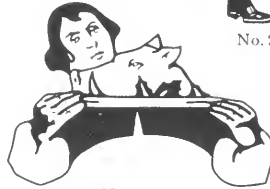

No. 39 40c

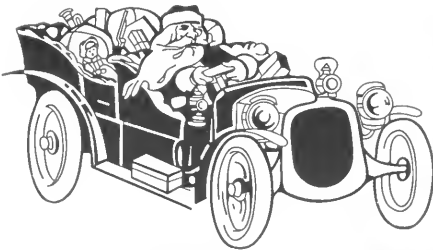

No. 149 80c



No. 191 20c



No. 182 20c

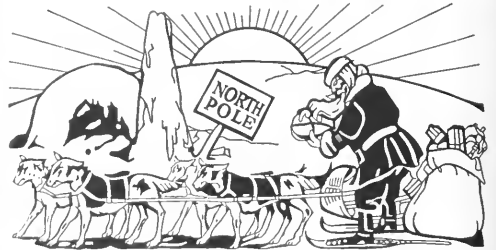

No. 155 80c

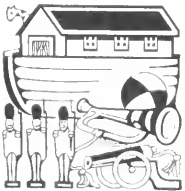

No. 186 35c



No. 185 20c



No. 188 20c

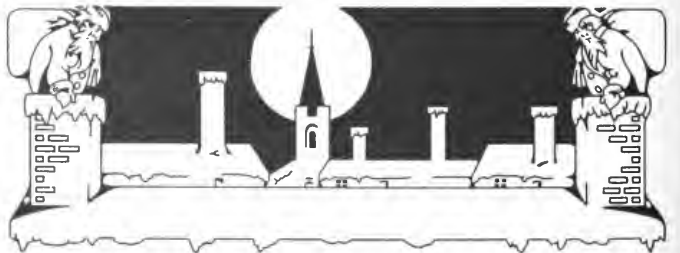

No. 79 95c

Holiday Decorators



No. 25 60c

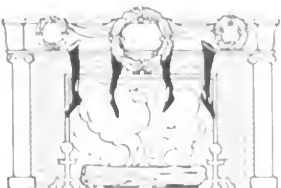

No. 200 10c



No. 28 60c No. 109 Color 50c



No. 96 30c



No. 113 50c



No. 193 50c

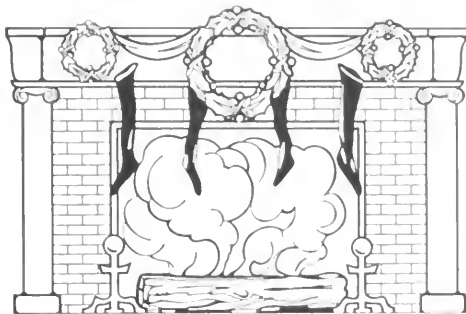

No. 201 75c



No. 26 45c



No. 97 20c



No. 192 35c



No. 71 50c

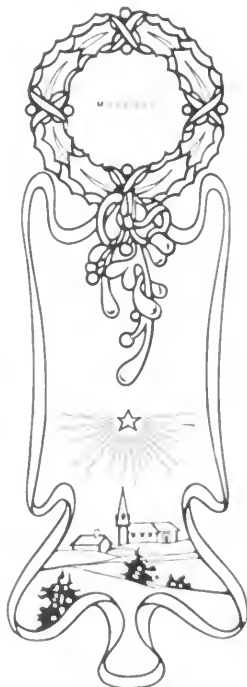

No. 203 \$1.00



No. 87 75c
No. 132 Color 65c



No. 27 35c



No. 110
4 for 15c



No. 112
4 for 10c



No. 111
4 for 10c



No. 139
4 for 25c

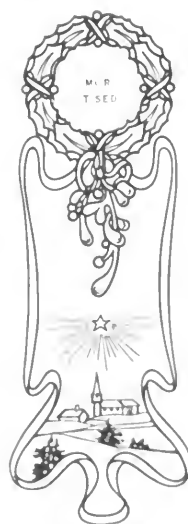

No. 202 75c



No. 101 20c



No. 107 20c



No. 88 40c
No. 133 Color 35c



No. 84 35c



No. 30 35c
No. 126 Color 30c



No. 29 45c
No. 127 Color 40c

Holiday Decorators

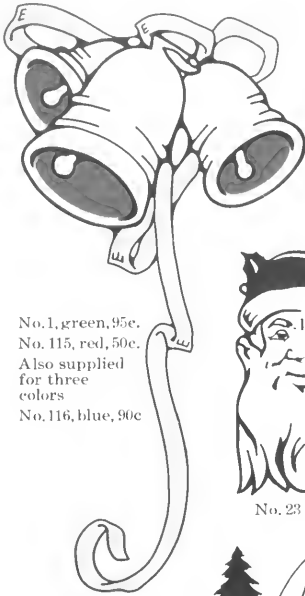

No. 1, green, 95c.
No. 115, red, 50c.
Also supplied
for three
colors
No. 116, blue, 90c



No. 157 80c



No. 23 35c



No. 134 30c
No. 135 Color 20c



No. 2 75c
No. 118 Color 60c



No. 24 30c



No. 54 50c



No. 159 45c



No. 62 50c

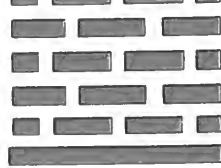

No. 77 95c
No. 128 Color 50c



No. 55 35c



No. 137 25c
No. 138
Color 15c



No. 3 50c
No. 119 Color 40c



No. 56 90c



No. 22 40c



No. 59 75c



No. 53 75c

Holiday Decorators



No. 18 30c

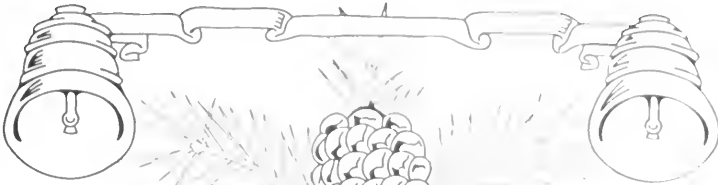

No. 71 \$1.00



No. 36 90c



No. 17 35c



No. 35 10c



No. 16 45c



No. 75 85c



No. 31 50c

No. 76 60c No. 121 Color 10c

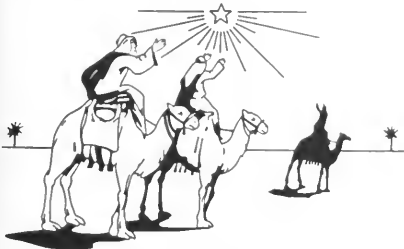

No. 69 65c

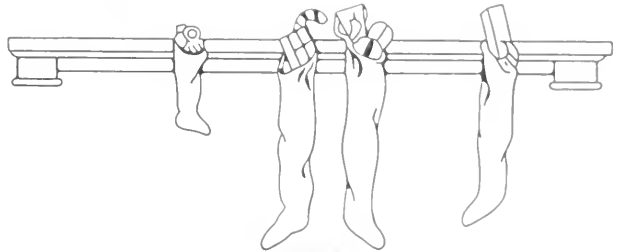

No. 86 90c

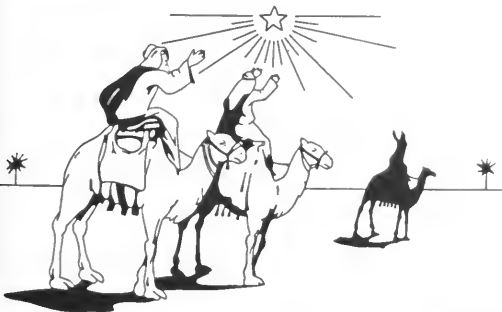

No. 68 85c



No. 199 75c



No. 98 35c

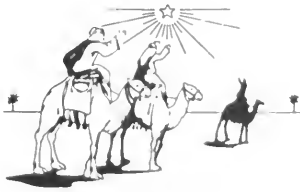

No. 70 45c



No. 198 50c

Holiday Decorators



No. 72 \$1.00 No. 117 Color 90c



No. 52 45c



No. 49 60c

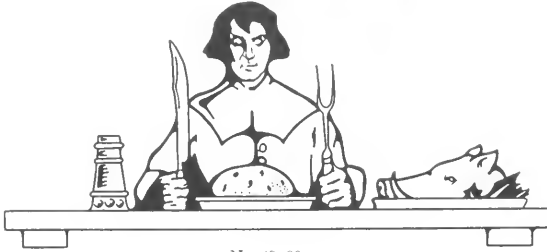

No. 48 80c



No. 73 60c No. 136 Color 40c



No. 50 90c



No. 14 35c



No. 177 45c



No. 94 90c



No. 15 30c

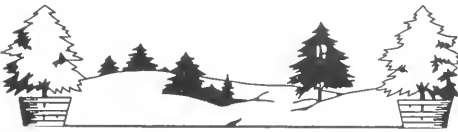

No. 95 45c



No. 51 70c



No. 13 45c



No. 179 30c

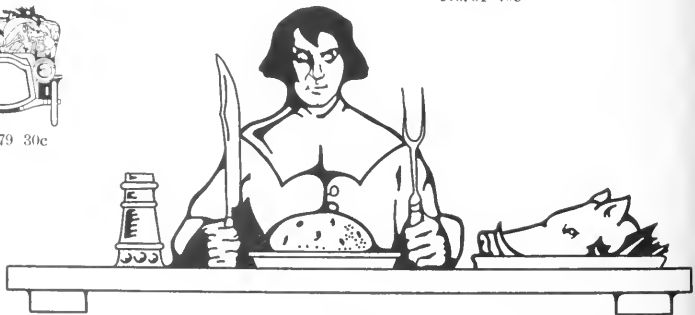

No. 47 \$1.00

20TH CENTURY ORNAMENTS



MADE BY THE
PUBLISHERS AND
THE DESIGNERS
OF THIS BOOK



SERIES No. 1 Price £1.00 \$ 1.00



No. 1



No. 2



No. 3



No. 4



No. 5



No. 6



No. 7



No. 8



No. 9



No. 10



No. 11



No. 12



No. 13

SERIES No. 2 Price £2.75 \$ 2.75



No. 14



No. 15



No. 16



No. 17



No. 18



No. 19



No. 20



No. 21



No. 22



No. 23



No. 24



No. 25



No. 26



No. 27

Twentieth Century Ornaments



No. 18 30c



No. 39 50c



No. 17 30c



No. 69 30c



No. 19 40c



No. 38 40c



No. 71 30c



No. 30 30c



No. 15 50c

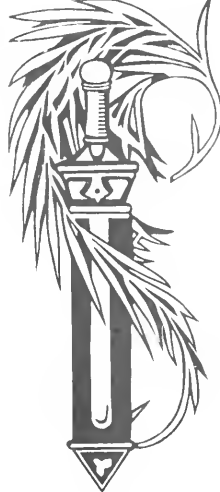

No. 28 50c



No. 43 50c

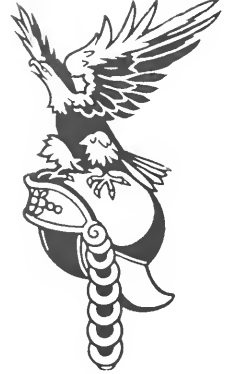

No. 35 50c



No. 31 30c



No. 66 30c



No. 46 30c



No. 40 40c



No. 20 20c

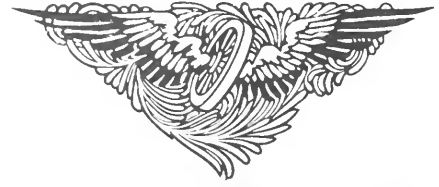

No. 22 40c



No. 17 25c



No. 79 25c



No. 42 40c



No. 78 25c



No. 75 20c



No. 76 20c



No. 33 25c

Twentieth Century Ornaments

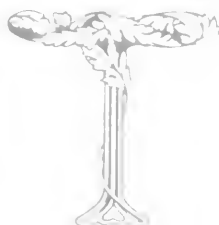
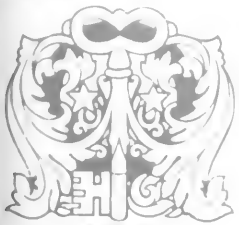
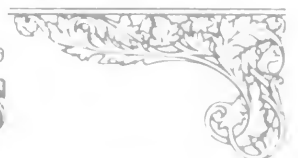
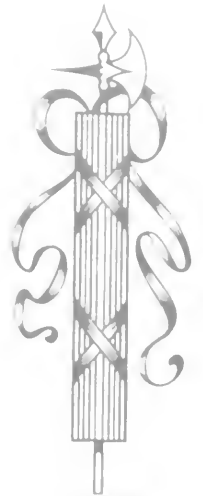

No. 21 De

No. 28 De

No. 33 De

No. 34 De

No. 44 De

Versatile Ornaments

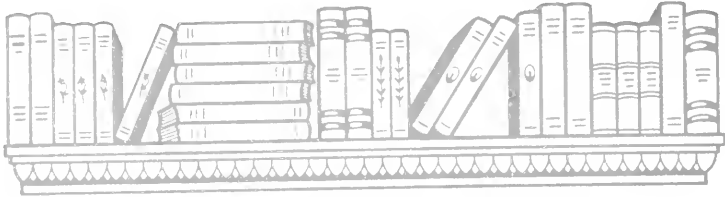

No. 55 85c

No. 15 25c

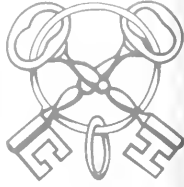

No. 13 25c

No. 74 15c

No. 58 50c

No. 75 15c

No. 35 35c

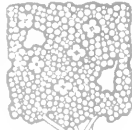

No. 70 15c

No. 12 50c



No. 76 15c



No. 71 20c

No. 73 15c

No. 72 15c



No. 145 20c



No. 31 25c



No. 124 30c



No. 80 20c



No. 39 10c



No. 12 25c



No. 127 25c



No. 67 85c



No. 127 20c



No. 144 25c



No. 33 30c



No. 74 30c



No. 35 30c

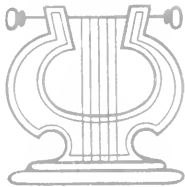

No. 30 35c



No. 128 15c



No. 68 50c



No. 126 20c



No. 32 35c



No. 143 35c



No. 4 50c



No. 14 30c



No. 7 50c

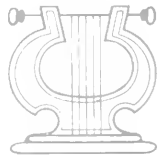

No. 11 30c

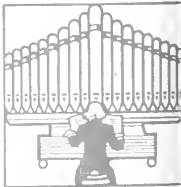

No. 123 35c

Versatile Ornaments



No. 118 20c



No. 122 20c



No. 61 80c



No. 123 20c



No. 124 20c



No. 116 35c



No. 151 15c



No. 62 50c



No. 150 15c



No. 119 50c



No. 117 25c

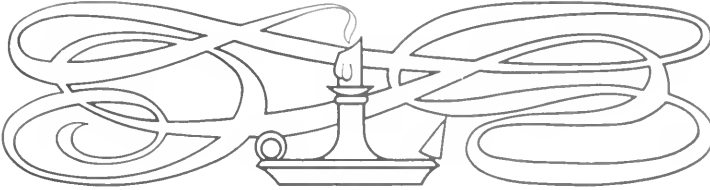

No. 69 85c



No. 120 25c



No. 145 35c



No. 119 15c

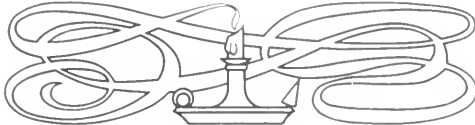

No. 70 45c

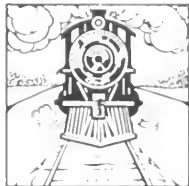

No. 129 35c



No. 120 20c

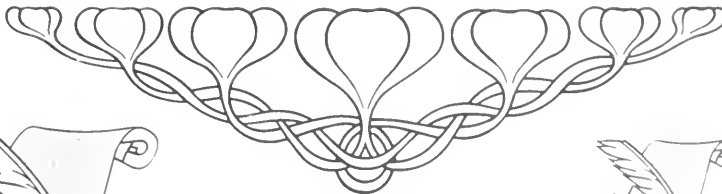

No. 64 85c



No. 118 25c



No. 119 25c

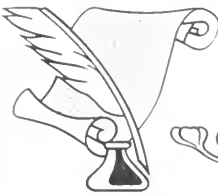

No. 86 35c



No. 87 30c



No. 131 20c



No. 117 25c



No. 110 25c



No. 108 25c



No. 109 25c



No. 113 20c



No. 111 20c



No. 112 20c



No. 132 25c



No. 114 35c



No. 107 35c



No. 105 35c



No. 106 35c



No. 130 35c

Versatile Ornaments

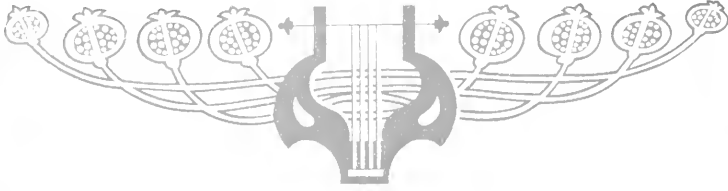

No. 61 20c

No. 84 30c

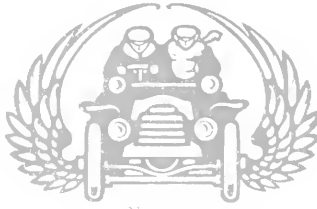

No. 7 20c

No. 9 20c

No. 11 50c



No. 91 50c



No. 77 50c



No. 10 25c



No. 1 25c

No. 15 10c

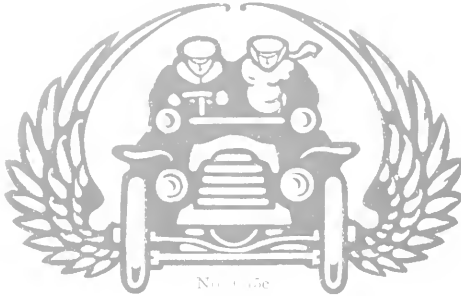

No. 6 50c



No. 11 40c



No. 84 25c

No. 82 25c

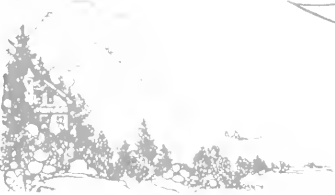

No. 101 50c



No. 56 85c

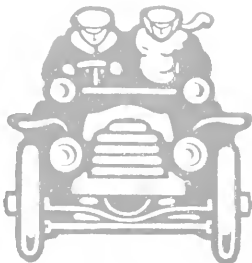

No. 17 60c



No. 71 75c



No. 48 35c



No. 98 20c



No. 104 50c

Versatile Ornaments

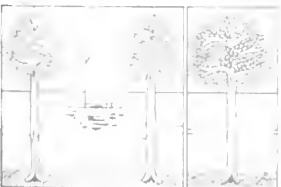
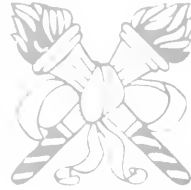
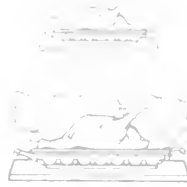
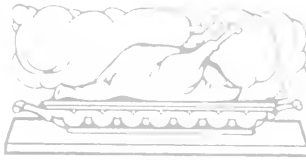

Versatile Ornaments

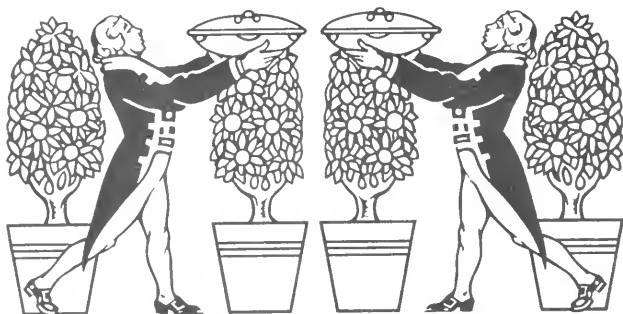

No. 152 60c

No. 153 60c



No. 3 50c



No. 158 25c



No. 159 25c



No. 99 30c



No. 161 50c

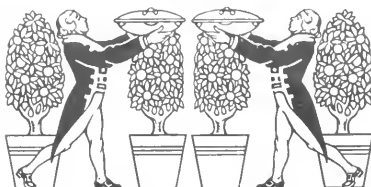

No. 155 35c

No. 156 35c

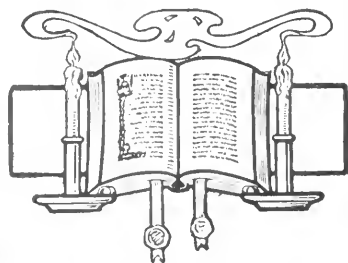

No. 162 50c No. 163 Color 50c
(For color see page 527)

VERSATILE ORNAMENTS IN GROUPS

Group T Complete 75c

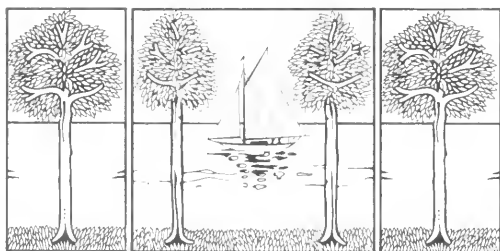

Group S Complete 60c

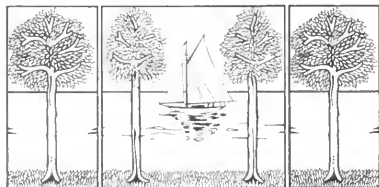

Group Q Complete 40c



Group R Complete 50c

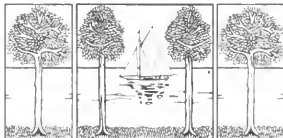

Group K Complete 40c



Group G Complete 75c

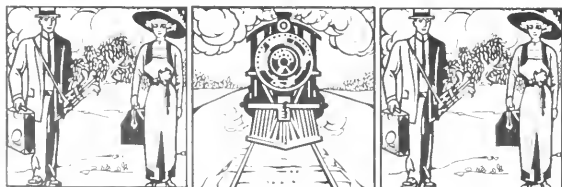

Group F Complete 50c

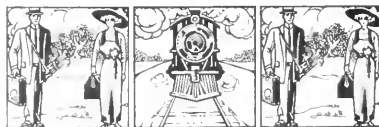

Versatile Ornaments in Groups

Group P Complete \$1.25

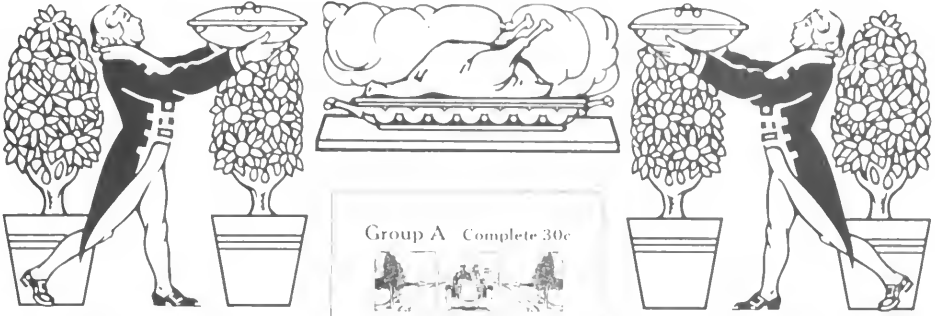

Group A Complete 30c



Group O Complete 75c

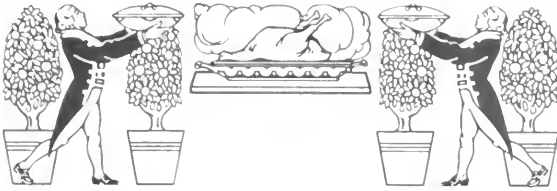

Group N Complete 50c

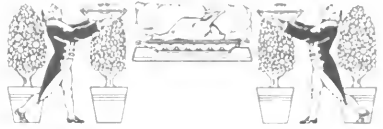

Group C Complete 50c



Group D Complete 75c

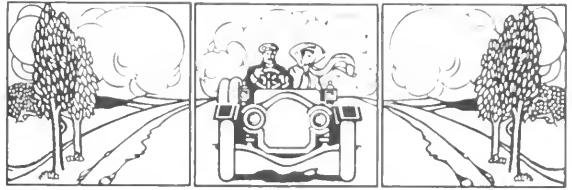

Group J Complete 75c

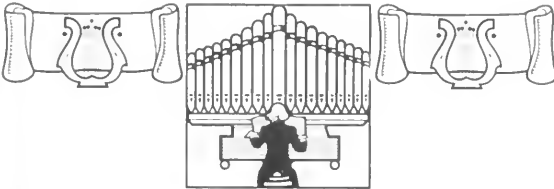

Group I Complete 50c

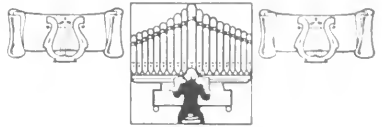

Group L Complete 50c



Group M Complete 75c



Group B Complete 40c



Group H Complete 40c



Group E Complete 40c



Strathmore Ornaments



No. 150 25c



No. 151 80c



No. 152 30c



No. 153 40c



No. 154 70c



No. 155 40c



No. 156 20c



No. 157 20c



No. 158 30c



No. 159 25c



No. 160 20c

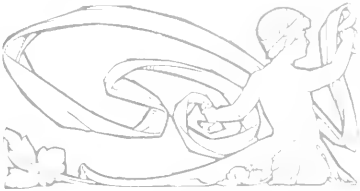

No. 161 40c



No. 162 35c

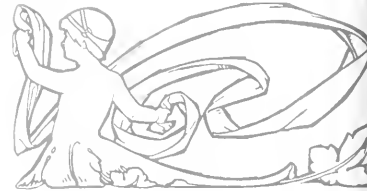

No. 163 40c

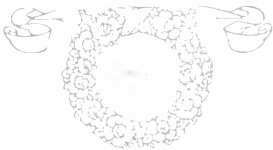

No. 164 30c

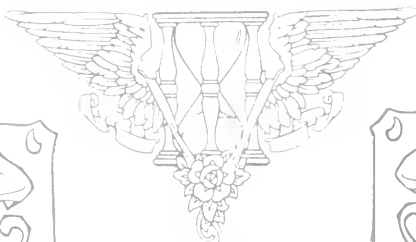

No. 165 60c



No. 166 25c



No. 167 30c



No. 168 30c



No. 169 45c



No. 170 30c



No. 171 30c

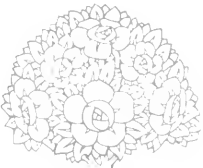

No. 172 45c



No. 173 20c



No. 174 25c



No. 175 20c



No. 176 20c



No. 177 20c



No. 178 40c

Strathmore Ornaments

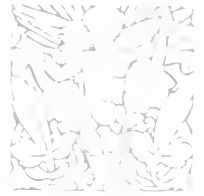
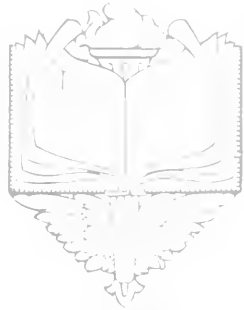
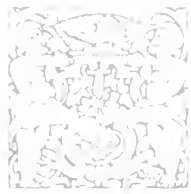

No. 21. 36

No. 25. 36

No. 23. 36

No. 27. 36

No. 25. 36

Strathmore Ornaments



No. 122 50c



No. 27 30c

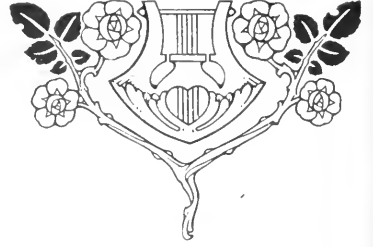

No. 196 50c



No. 160 75c



No. 159 40c

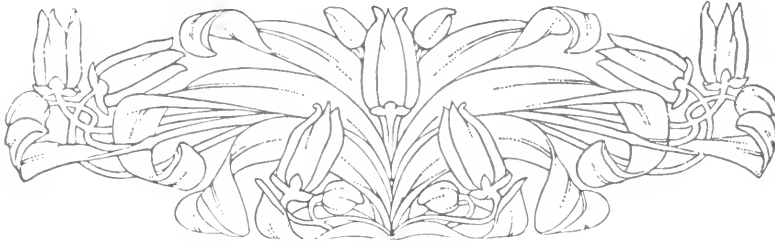

No. 124 \$1.00



No. 195 40c



No. 26 30c

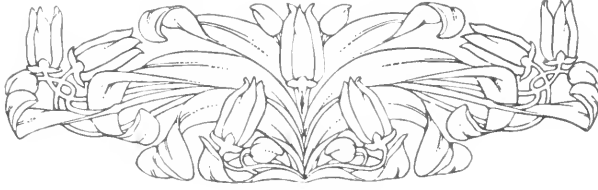

No. 123 75c



No. 46 30c



No. 179 60c



No. 194 25c



No. 180 60c



No. 177 35c



No. 121 30c



No. 178 35c



No. 181 75c



No. 182 75c

Strathmore Ornaments

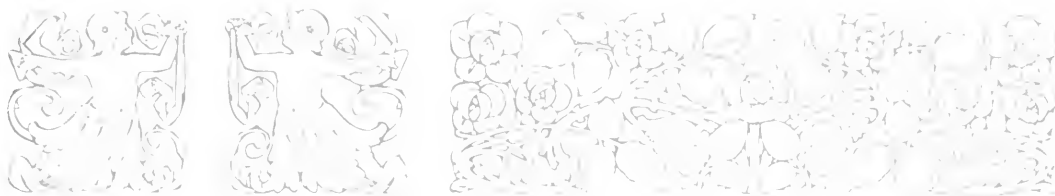

No. 217

No. 218

No. 219

Knickerbocker Ornaments

Series No. 11 Per Font \$3.55

Characters 62 and 63 separately each 20c



No. 62

No. 63

Series No. 12 Per Font \$3.55

Characters 62 and 63 separately each 20c

Characters 62 and 63 separately each 20c



No. 62

No. 63



No. 64

No. 65

No. 66



No. 64

No. 65

No. 66



No. 67

No. 68

No. 69

No. 70



No. 67

No. 68

No. 69

No. 70

Series No. 7 Per Font \$2.70

Characters 47 and 48 separately each 20c

Characters 47 and 48 separately each 20c



No. 47

No. 48

No. 49

No. 50



No. 47

No. 47

No. 48

No. 49



No. 51

No. 52

No. 53

No. 54

No. 55



No. 51

No. 52

No. 53

No. 54

No. 55

Series No. 9 Per Font \$2.70

Characters 43 and 44 separately each 20c



No. 43

No. 45

No. 46

No. 44

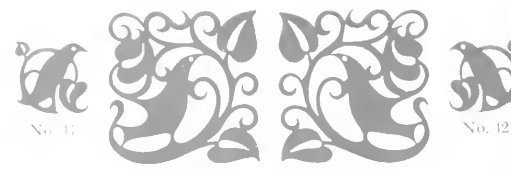

No. 43

No. 43

No. 44

No. 46



No. 56

No. 57

No. 58

No. 59

No. 60



No. 56

No. 58

No. 56

No. 59

No. 60

Knickerbocker Ornaments

Series No. 13 Per Font \$3.00

Series No. 14 Per Font \$3.00

Series No. 15 Per Font \$3.00

Series No. 16 Per Font \$3.00

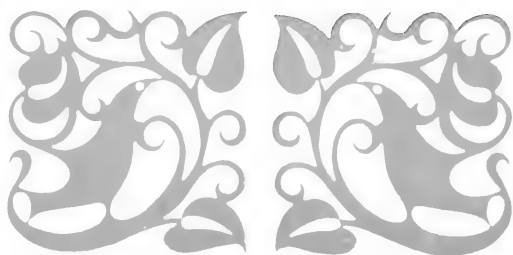
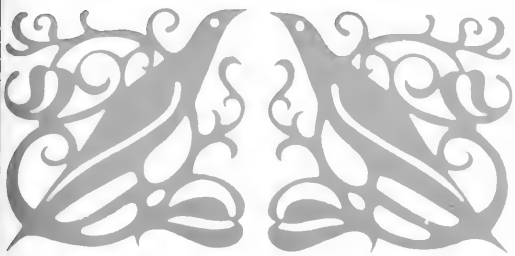

Series No. 3

Series No. 4

Series No. 5

Series No. 6

Per Font \$2.00

Per Font \$2.00

Per Font \$2.00

Per Font \$2.00



Series No. 1 Per Font \$2.00

Series No. 2 Per Font \$3.00



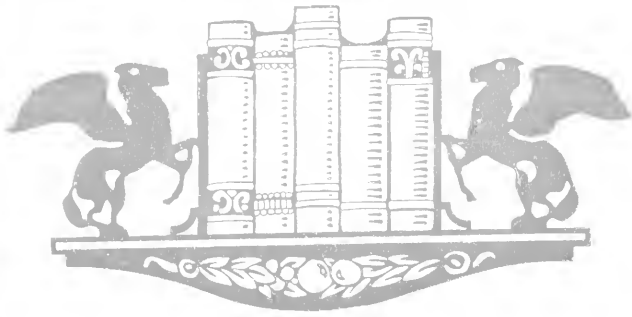

No. 43 80c

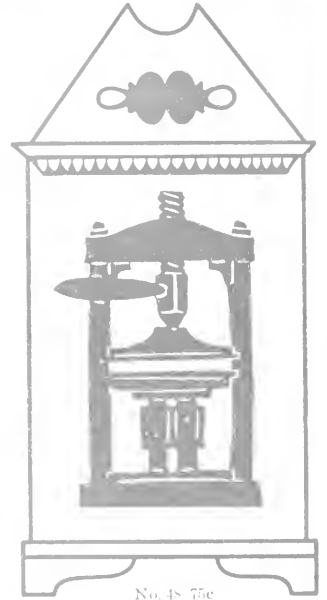

No. 48 75c



No. 46 75c
No. 52 Ornament only 50c
No. 53 Hat only 25c



No. 51 40c No. 56 Shoe only 25c
No. 54 Ornament of B. 40c



No. 62 35c

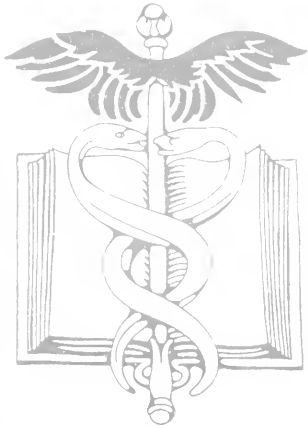

No. 73 60c



No. 61 50c



No. 49 30c

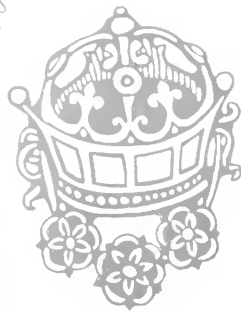

No. 41 35c

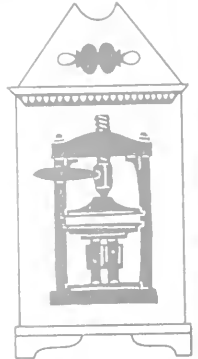

No. 44 35c



No. 40 25c



No. 60 81.00



No. 45 25c



No. 42 45c

Wayside Ornaments

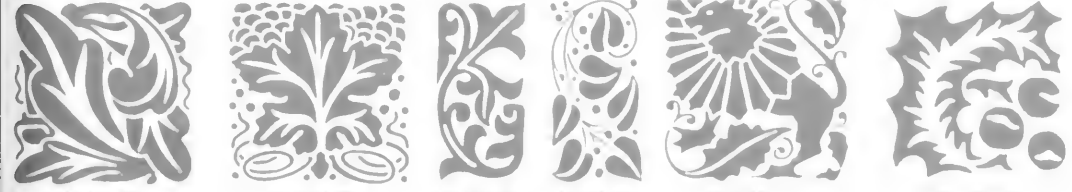
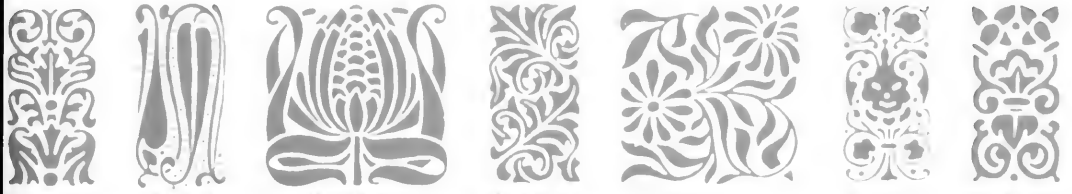
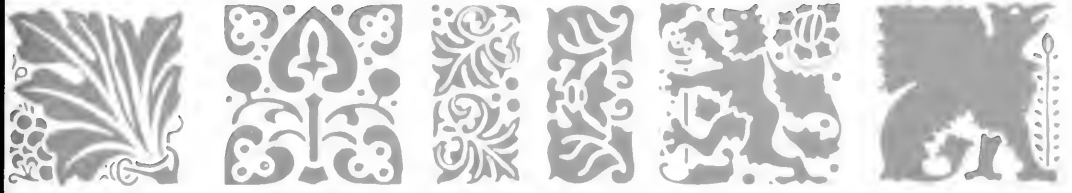

Wayside Ornaments



No. 327 15c No. 328 15c



No. 329 15c No. 331 15c



No. 334 15c No. 335 30c



No. 539 15c No. 540 15c



No. 538 15c No. 537 15c



No. 323 25c



No. 341 25c



No. 366 20c



No. 367 20c



No. 345 25c



No. 324 25c



No. 350 20c



No. 429 20c



No. 470 15c



No. 430 20c



No. 351 20c



No. 340 35c



No. 333 25c



No. 407 15c



No. 347 20c No. 346 20c



No. 341 35c



No. 410 15c



No. 370 20c



No. 338 20c



No. 339 20c



No. 371 20c



No. 392 15c



No. 354 20c



No. 388 20c



No. 353 15c



No. 352 15c



No. 389 20c



No. 355 20c



No. 437 20c



No. 416 20c



No. 358 20c



No. 359 20c



No. 418 15c



No. 434 20c



No. 321 25c



No. 362 25c



No. 320 25c



No. 363 25c



No. 320 25c



No. 494 15c



No. 396 10c



No. 422 10c



No. 478 15c



No. 486 15c



No. 423 10c



No. 397 10c



No. 482 15c



No. 356 15c



No. 357 15c



No. 373 15c



No. 371 15c



No. 414 15c



No. 368 15c



No. 369 15c



No. 364 15c



No. 365 15c

Wayside Ornaments

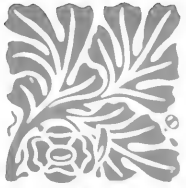

No. 29



No. 30



No. 31



No. 32



No. 33



No. 34



No. 35



No. 322



No. 331



No. 348



No. 350



No. 360



No. 361



No. 362



No. 424



No. 437



No. 471



No. 510



No. 511



No. 512



No. 513



No. 514



No. 481



No. 325

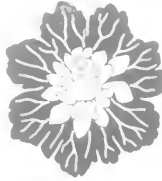

No. 328



No. 331



No. 360



No. 487



No. 491



No. 343



No. 390



No. 371



No. 409



No. 342



No. 468



No. 469



No. 412



No. 402



No. 411



No. 542



No. 541



No. 515



No. 516



No. 472



No. 415



No. 362



No. 361



No. 411



No. 362



No. 425



No. 414



No. 416



No. 360



No. 361



No. 362



No. 363



No. 364



No. 365



No. 366



No. 398



No. 399



No. 375



No. 378



No. 411



No. 412



No. 404



No. 400



No. 515



No. 516

Chap-Book Guidons

14 Point Per Font 60c
 Font contains ten pairs each of Brackets and Parentheses, ten each of Paragraph Marks

30 Point Per Font 65c
 Font contains four pairs each of Brackets and Parentheses; four each of Paragraph Marks

24 Point Per Font 60c
 Font contains six pairs each of Brackets and Parentheses, six each of Paragraph Marks

18 Point Per Font 60c
 Font contains eight pairs each of Brackets and Parentheses, eight each of Paragraph Marks

36 Point Per Font 65c
 Font contains three pairs each of Brackets and Parentheses, three each of Paragraph Marks

42 Point Per Font 65c
 Font contains two pairs each of Brackets and Parentheses, two each of Paragraph Marks

48 Point Per Font 75c
 Font contains two pairs each of Brackets and Parentheses, two each of Paragraph Marks

60 Point Per Font 75c
 Font contains two pairs each of Brackets and Parentheses; two each of Paragraph Marks

72 Point Per Font 80c
 Font contains two pairs each of Brackets and Parentheses; one each of Paragraph Marks

Chap-Book Directors, Swastika Ornaments

CHAP-BOOK DIRECTORS

Are made in four eye-catching styles, comprising nine sizes each, 24, 30, 36, 42, 48, 60, 72, 96 and 120 Point

No. 1901 120 Point Per Pair 75c



No. 201 72 Point Per Pair 60c



No. 3001 96 Point Per Pair 50c



12 Point Per Font of four pairs, eight characters, 50c



24 Point Per Font of eight pairs, sixteen characters, 50c



30 Point Per Font of eight pairs, sixteen characters, 50c



36 Point Per Font of eight pairs, sixteen characters, 60c



18 Point Per Font of four pairs, eight characters, 60c

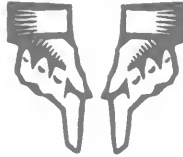

60 Point Per Font of four pairs, eight characters, 75c

SWASTIKA ORNAMENTS Per Font 80c



This shows complete font

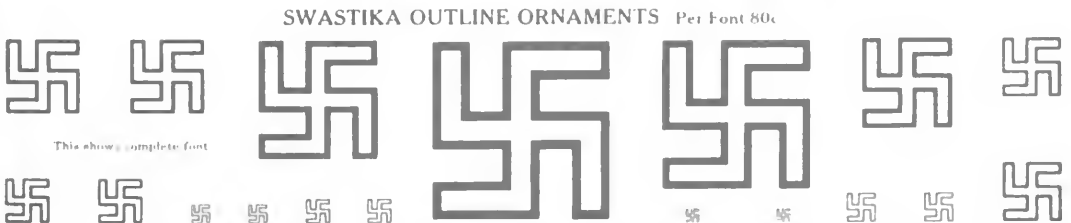

This shows complete font

Chap-Book Cuts



No. 55 35c

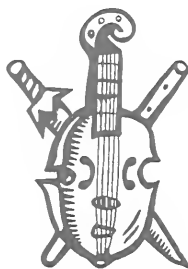

No. 9 25c

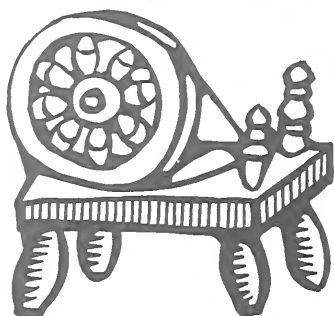

No. 41 40c



No. 6 25c

We have issued a pamphlet showing the complete series of Chap-Book Cuts which will be sent to anyone interested. Besides the Chap-Book Cuts this pamphlet contains a showing of many other attractive and useful ornaments. You should secure a copy



No. 87 25c

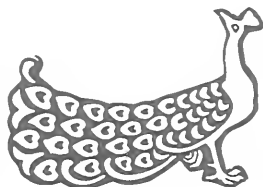

No. 14 25c



No. 59 40c



No. 22 30c



No. 15 25c



No. 80 25c



No. 16 25c



No. 93 35c

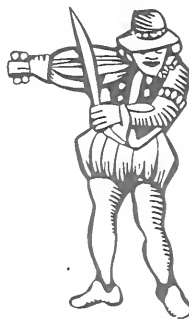

No. 26 30c



No. 76 25c

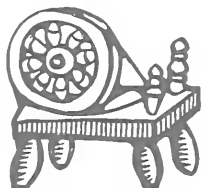

No. 5 25c



No. 83 25c



No. 79 25c



No. 7 25c

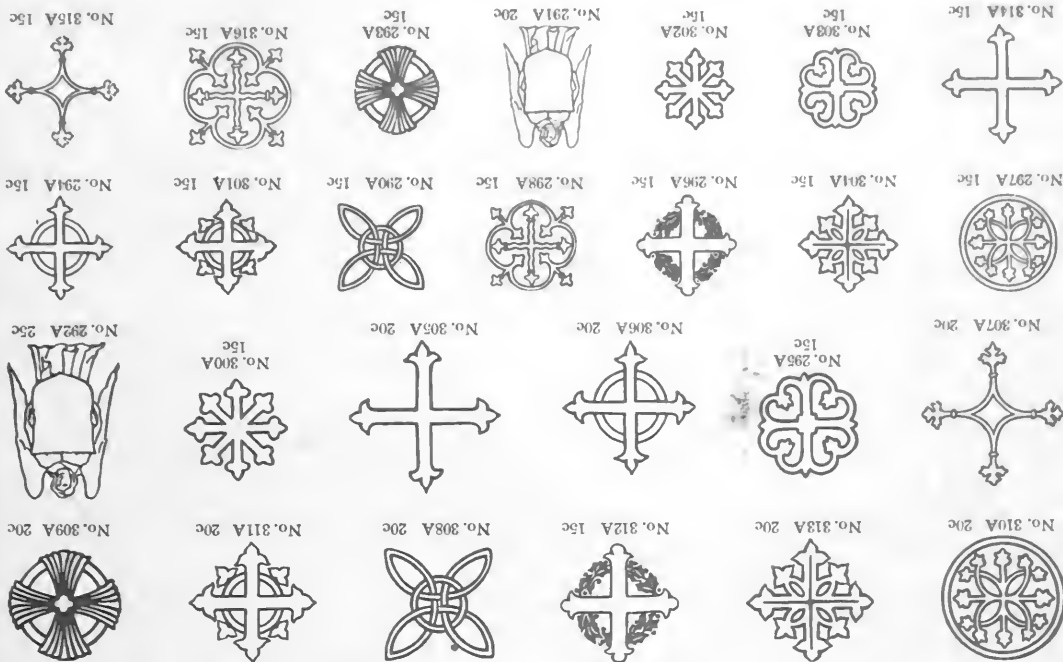

MURAL ORNAMENTS

Laurel ornaments are cast in cored type molds, with as little shoulder as possible inside of the wreaths, so that the lines may be set close up. A great variety of designs may be quickly and easily produced with these inexpensive ornaments. The ornaments may be set separately and with the Laurel Borders shown on page 1029. Wreaths may be enlarged symmetrically by printing the whole piece.

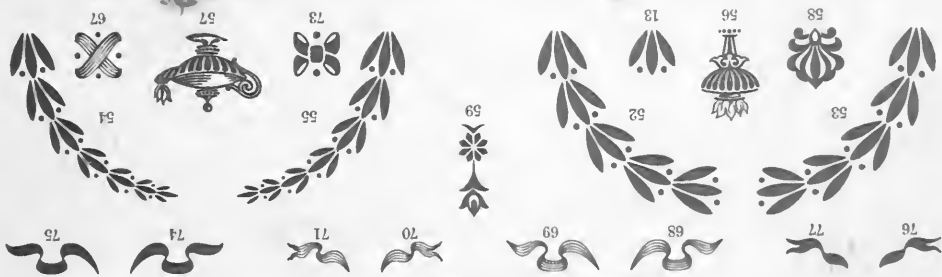

Characters in Complete Font of 18 Point

(The characters of 6 Point and 12 Point are practically the same as these)

Prices
 6 Point \$1.25
 12 Point 1.50
 18 Point 1.50



LAUREL ORNAMENTS

FLORAL BASKET PIECES

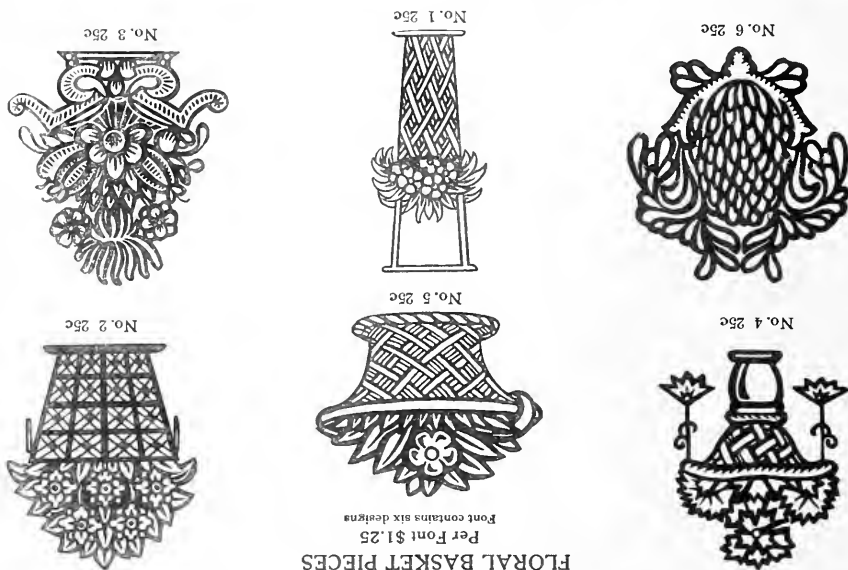

The 48 Point No. 2 and the 72 Point No. 2 are colors for both the No. 1 Series. In ordering state whether for one or two colors

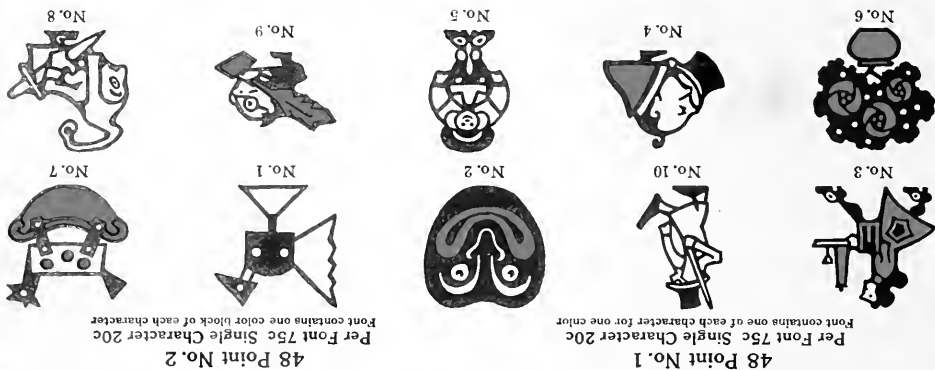

MISSION TOYS



Mission Toys and Floral Basket Pieces

No. 30



No. 31



No. 33



No. 35



No. 37

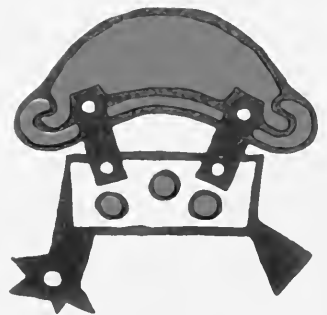

CAST IN TYPE
MOLDS



These cuts are made for printing in either one or two colors. In order to display their possibilities and attractiveness we have printed a few of them in two colors. The prices are shown above. When ordering, kindly designate whether for one or two colors

No. 34



No. 39



Mission Toys

No. 32



No. 36



No. 38



Single character for two colors 75c

120 POINT MISSION TOYS

Single character for one color 40c

Beardsley Ornaments and Beacon Ornaments

BEARDSLEY ORNAMENTS—Series No. 1 Per Font \$2.25

Characters in Complete Font

Font contains four type of character 72025 and five each of other characters



No. 48081 20c No. 60018 20c No. 72025 30c No. 60019 20c No. 48080 20c

BEARDSLEY ORNAMENTS—Series No. 2

Per Font \$2.50

Characters in Complete Font

Font contains three type of each character



No. 72027A 25c No. 96002B 30c No. 96002A 30c No. 96002C 30c No. 72026B 25c

No. 72027B 25c No. 72026A 25c

998

BEACON COMBINATION ORNAMENTS Per Font \$2.50

Characters in Complete Font

Font contains four each of characters 4, 5, 6, 7 and 8; five each 1 and 3; six of 2; sixteen of 9

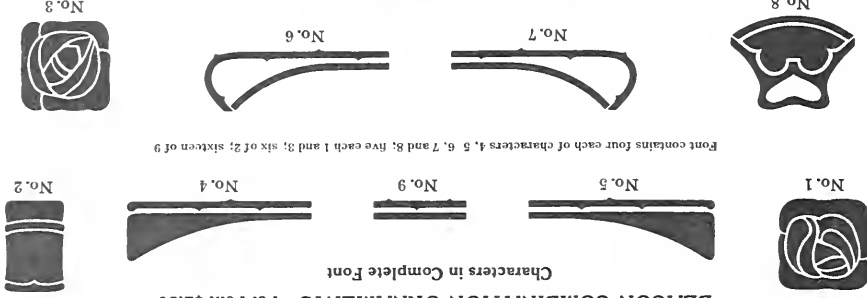

No. 1 No. 2 No. 3 No. 4 No. 5 No. 6 No. 7 No. 8 No. 9

Beardsley Ornaments and Rose Border (see page 1068) worked in combination have a very pleasing effect as shown on Hookman Lullie display page 427

Hylite Borders

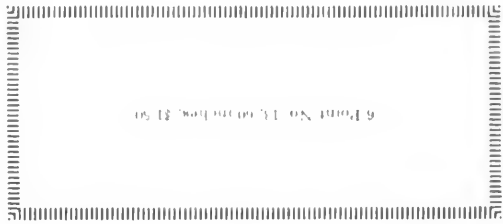
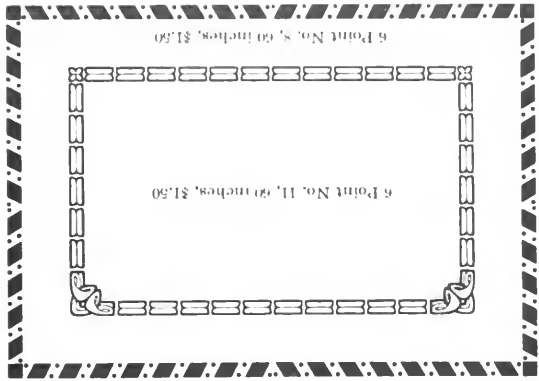
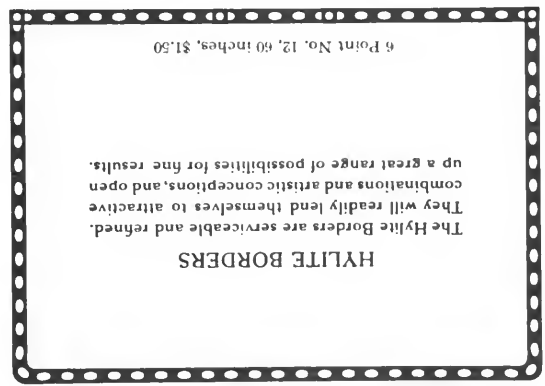
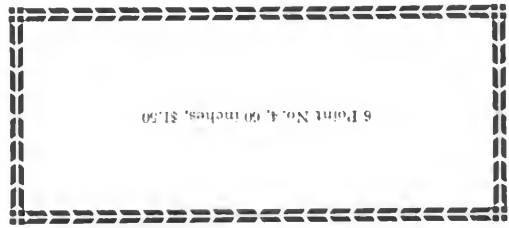
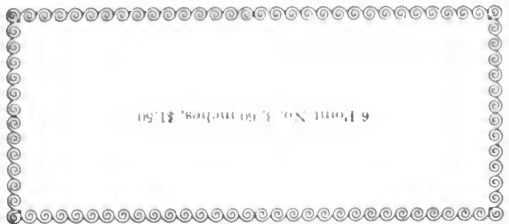
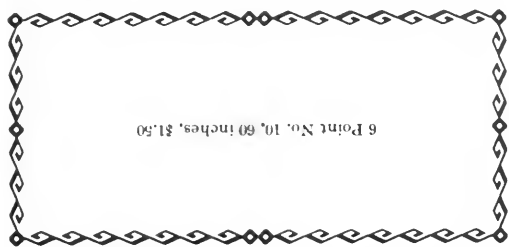
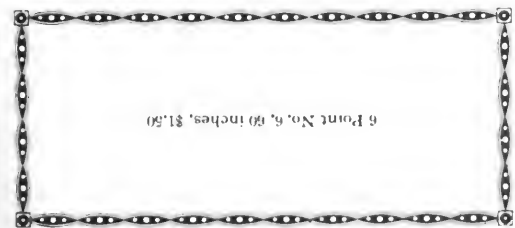

AMERICAN TYPE FOUNDERS COMPANY
ORIGINATOR AND MAKER

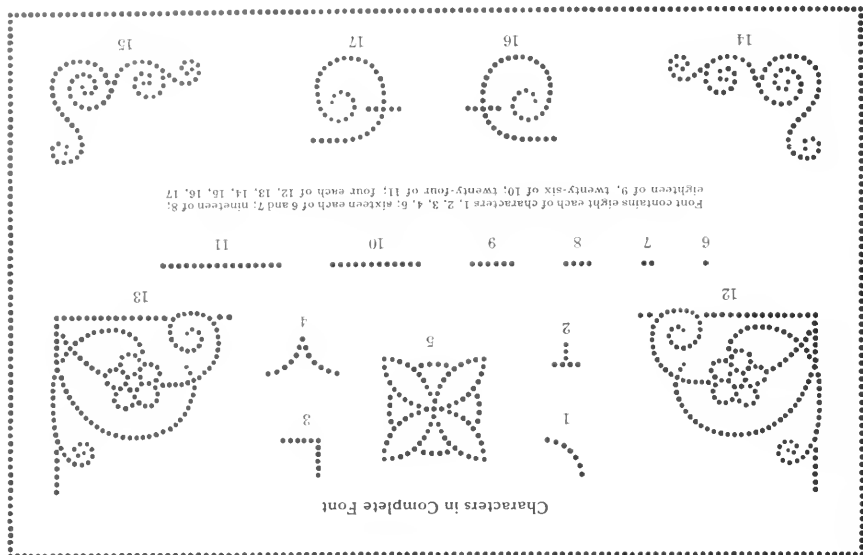

Per Font \$4.00

HIGHLY EFFECTIVE
COMBINATIONS

BORDER BEAUTIES
OBTAINED



THIS IS A BORDER CAPABLE OF BEING SET WITH AN ALMOST INFINITE NUMBER OF COMBINATIONS, ALL EASILY CONSTRUCTED. IT WILL LOOK EXTREMELY WELL IN RED OR ANY OTHER SECONDARY COLOR IN A TYPE COMPOSITION, AND AT THE SAME TIME IS STRONG ENOUGH TO MAKE ATTRACTIVE BORDERS, PANELS, DECORATIONS AND END PIECES IN A ONE COLOR COMPOSITION. A BORDER OF UNLIMITED USEFULNESS

Dainty Border No. 1

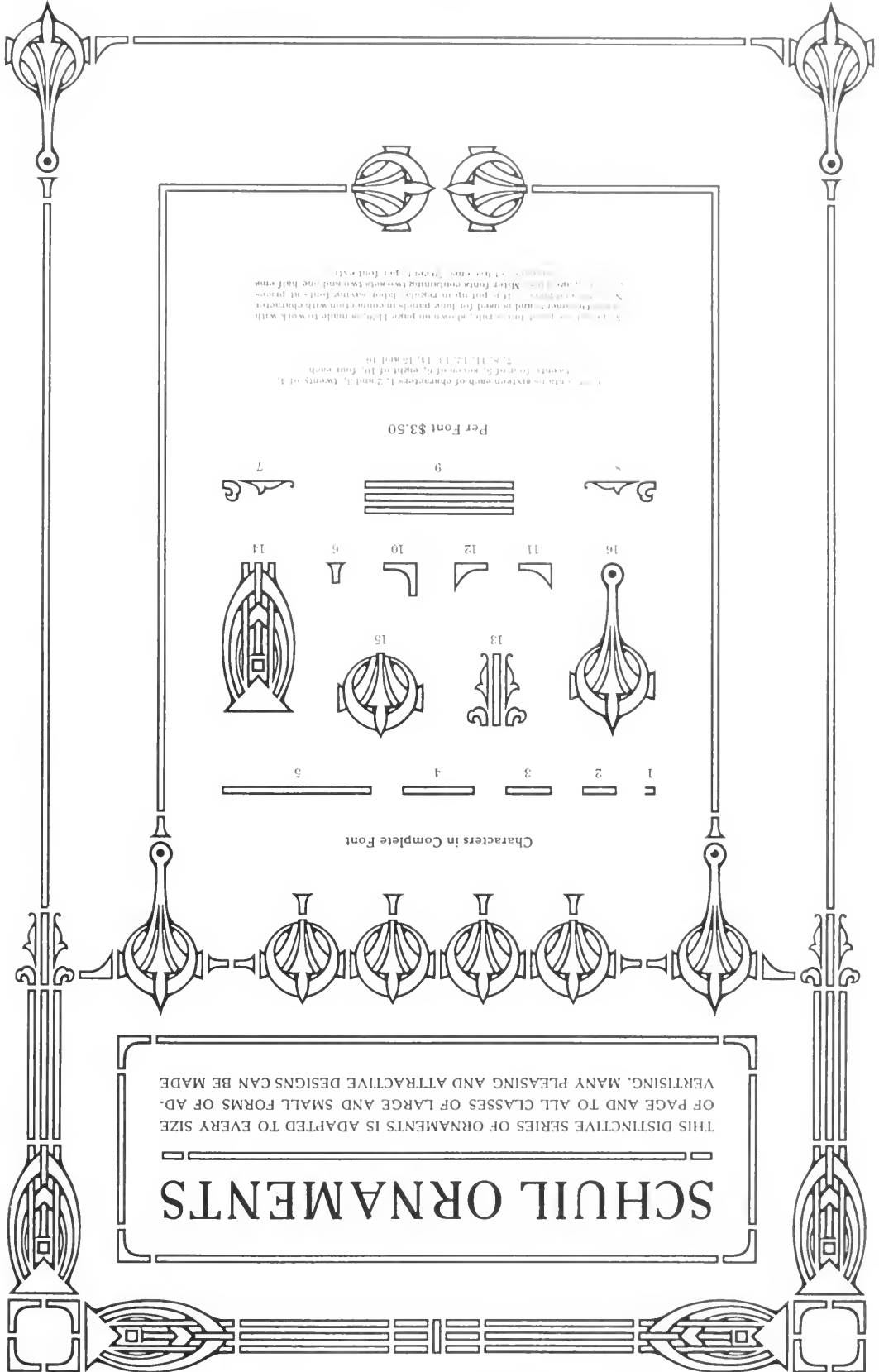

SCHUL ORNAMENTS

THIS DISTINCTIVE SERIES OF ORNAMENTS IS ADAPTED TO EVERY SIZE OF PAGE AND TO ALL CLASSES OF LARGE AND SMALL FORMS OF ADVERTISING. MANY PLEASING AND ATTRACTIVE DESIGNS CAN BE MADE

Characters in Complete Font

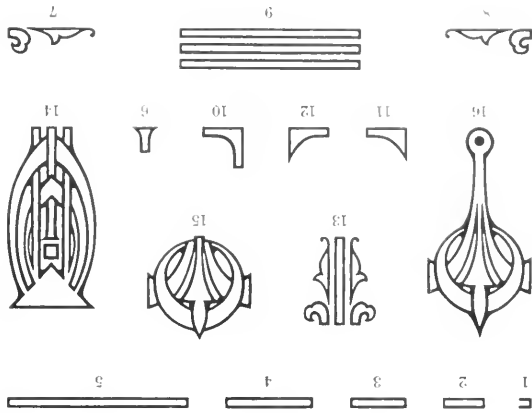

Per Font \$3.50

There are sixteen each of characters 1, 2 and 3; twenty of 4; twenty-four of 5; seven of 6; eight of 7; four each of 8, 9, 11, 12, 13, 14, 15 and 16.

A special one-point type is shown on page 11. It is made to work with a special galleys. It is put up in regular, large, extra and one-half em sizes. After fonts containing two or four characters in a font are made, the characters are set in connection with characters in the same font.

Each font is printed on one page. It is made to work with a special galleys.

36 POINT INDUSTRIAL ORNAMENTS

Per Font, two of each character, \$2.75

No. 7 40c No. 11 20c No. 10 25c

No. 12 20c No. 9 40c No. 8 40c

No. 7 40c

36 POINT COMMERCE ORNAMENTS

Per Font, two of each character, \$2.75

These ornaments may be used as individual ornaments, or the various characters may be combined, making a decorative panel or headpiece

CAST IN TYPE MOLDS

Originator and Maker
AMERICAN TYPE FOUNDERS COMPANY

No. 7 40c No. 11 20c No. 10 25c

No. 12 20c No. 9 40c No. 8 40c

No. 7 40c

Commerce, Industrial and Arrow Ornaments

ARROWS



18 Point Body, 72 Point Set Each, Per Foundry \$2.00



12 Point Body, 60 Point Set Each, Per Foundry \$1.50

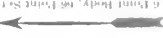

6 Point Body, 48 Point Set Each, Per Foundry \$1.00



6 Point Body, 48 Point Set Each, Per Foundry \$1.00



6 Point Body, 48 Point Set Each, Per Foundry \$1.00



6 Point Body, 48 Point Set Each, Per Foundry \$1.00

AMERICAN TYPE FOUNDERS COMPANY

No. 1 056



No. 1 056



Commerce Ornaments may be used as individual ornaments, or the various characters may be combined, making a decorative panel or heading as shown in some of the display pages in this catalogue.

Per Foundry each, \$1.75

No. 5 056



Commerce Ornaments

No. 2 056



No. 3 056



No. 3 056



No. 2 656



Industrial characters may be used as individual ornaments, or the various characters may be combined, making a decorative panel or heading as shown in some of the display pages in this catalogue.

Per Foundry each, \$1.75

No. 1 056



INDUSTRIAL ORNAMENTS

No. 6 056



No. 1 056



No. 1 056



12 POINT ARROW ORNAMENTS

No. 2

18 characters in Complete Font

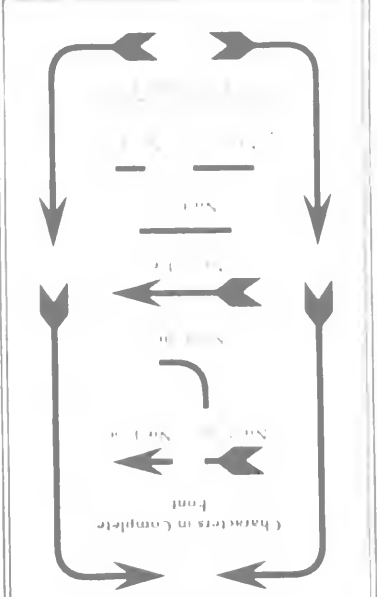

Per Foundry \$1.50

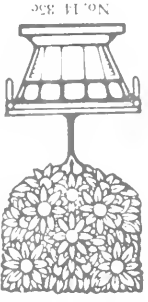

No. 14 35c

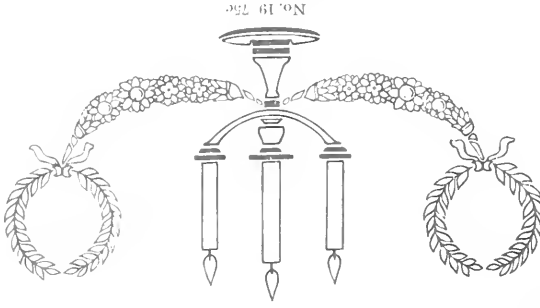

No. 19 75c

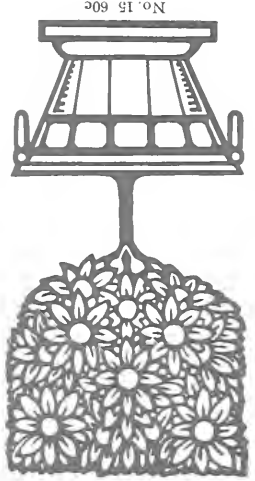

No. 15 60c



No. 3 30c



No. 1 85c

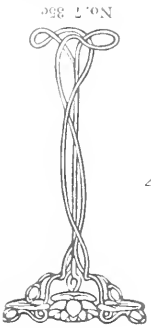

No. 7 35c



No. 10 35c

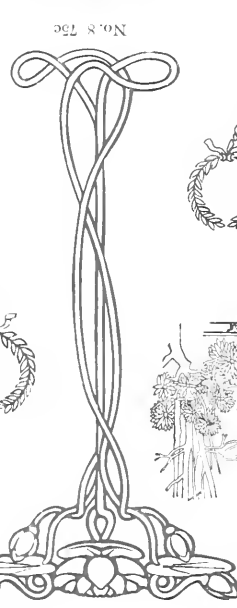

No. 8 75c

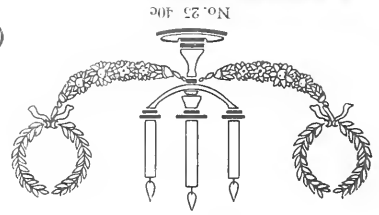

No. 27 40c



No. 18 45c

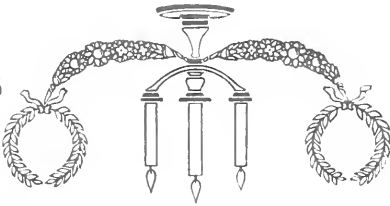

No. 16 40c

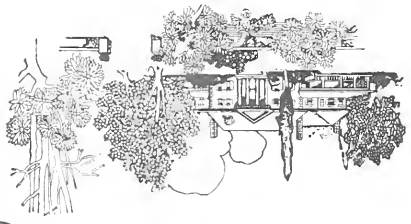
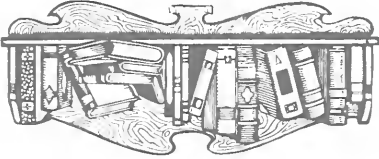

No. 24 50c



No. 30 25c



No. 6 \$1.00



No. 13 25c

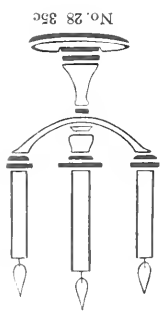

No. 28 35c

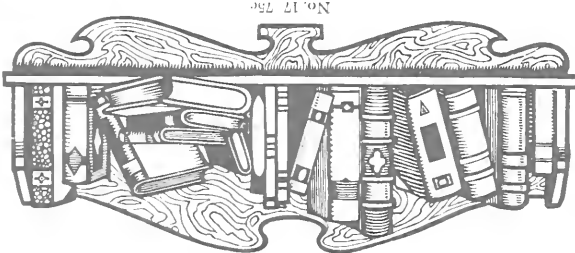

No. 17 75c



No. 12 60c

Tree Ornaments and Combination Ornaments

TREE ORNAMENTS

72 Point

Each Font contains six inches

Per Font 80c



60 Point

Per Font 80c



48 Point

Per Font 70c



36 Point

Per Font 60c



18 Point

Per Font 50c



11 Point

Per Font 65c



30 Point

Per Font 60c



12 Point

Per Font 60c



10 Point

Per Font 60c



24 Point

Per Font 50c



8 Point

Per Font 60c



6 Point

Per Font 60c



COMBINATION ORNAMENTS—Series No. 63 Per Font \$2.25

Characters in Complete Font



9



13



14



10



8



11



12



15



7



5



1



4



3



2



6

Font contains four of each character

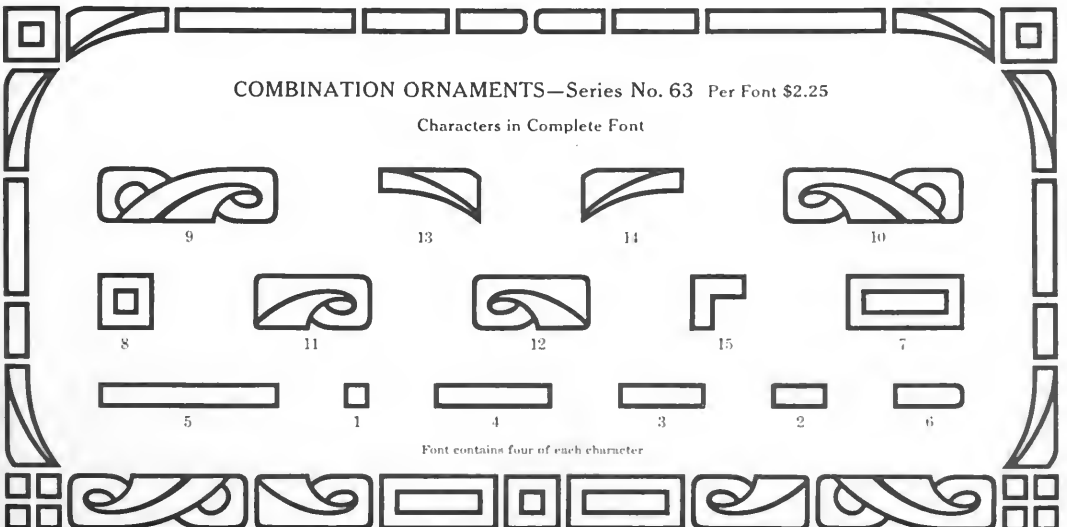

Art Ornaments

Series No. 54 Per Font \$1.00

Font contains one of each character



No. 84002 40c



No. 90001 40c



No. 18059
15c



No. 84003 40c



No. 84001 40c

Series No. 34 Per Font \$1.50

Font contains one of each character



No. 72014 30c



No. 60009 30c



No. 72015 30c



No. 72017 15c



No. 72013 30c



No. 72016
20c



No. 48024 30c



No. 72018
20c

Series No. 60 Per Font \$1.00

Font contains two each of characters 72024 and 48028; six of character 48027

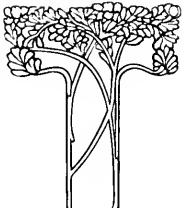

No. 72024 30c

No. 48027 20c

No. 48028 20c

Series No. 57 Per Font 75c

Font contains two each of characters 42005 and 42007; six of character 42006



No. 42005 15c

No. 42006 15c

No. 42007 15c

Series No. 55 Per Font \$1.25

Font contains two each of characters 60010 and 36028; six of 36027



No. 60010 30c

No. 36027 15c

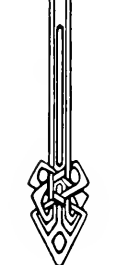

No. 36028 25c

Series No. 53 Per Font 75c

Font contains one of each character



No. 36025 25c



No. 36026 25c



No. 36029 25c



No. 42003 25c

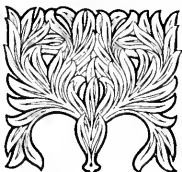

No. 72020 30c



No. 42009 15c
Color 42010 15c



No. 42008 20c



No. 72021 30c

Art Ornaments



No. 120001 40c



No. 120003 40c



No. 120002 40c



No. 84008 40c

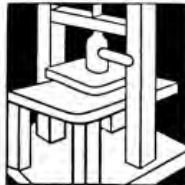

No. 72022 30c



No. 84010 40c



No. 48029 25c

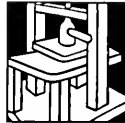

No. 48026 20c



No. 96001 35c



No. 84011 30c

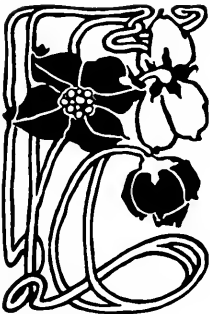

No. 84006 40c



No. 54003 25c



No. 96001 35c



No. 48025 25c



No. 60014 30c



No. 60013 30c

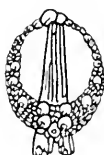

No. 60016 25c



No. 42004 20c

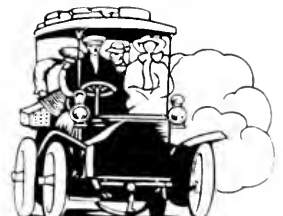

No. 84009 40c

Della Robbia Festoons and Ornaments, Dixon Ornaments

DELLA ROBBI A FESTOONS No. 1

18 Point Per Font, 36 inches, \$1.30



12 Point Per Font, 54 inches, \$1.50



24 Point Per Font, 36 inches, \$1.65



DELLA ROBBI A FESTOONS No. 2

Per Font \$2.00



No. 3



No. 9



No. 1



No. 4



No. 5



No. 2



No. 8



No. 7



No. 6

Font contains two each of characters 1, 2, 4, 5, 6 and 8, six each 7 and 9, ten of 2

DELLA ROBBI A ORNAMENTS

Per Font, two of each Character, \$2.25. Half Font, one of each Character, \$1.25



No. 5 30c



No. 2 30c



No. 7 20c



No. 3 25c



No. 1 25c



No. 8 20c



No. 10 35c



No. 9 25c



No. 6 30c



No. 4 25c

DIXON ORNAMENTS Per Font \$1.75

Font contains twelve of character 1; six of 2; three each 3 and 4; two each 5 and 6



No. 6 40c



No. 1 15c



No. 2 15c



No. 4 15c



No. 3 15c



No. 5 40c

Happy Thoughts and Electric Ornaments

HAPPY THOUGHTS Group K

Each character put up in sets of four 60c per set



No. 74



No. 75



No. 76

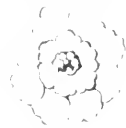

No. 77

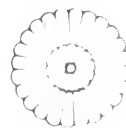

No. 78



No. 79



No. 80



No. 81



No. 82



No. 83



No. 84



No. 85

Group H

Each character put up in sets of four 50c per set



No. 68



No. 69



No. 70



No. 71



No. 72



No. 73

Group G

Each character 25c singly



No. 54



No. 55

Group E

Each character put up in sets of four 50c per set



No. 51



No. 52



No. 53



No. 54

Group F

Each character put up in sets of eight 50c per set



No. 61



No. 62



No. 63



No. 64



No. 65



No. 66



No. 67



No. 68



No. 69



No. 70



No. 71



No. 72

Group L

Each character put up in sets of eight 50c per set



No. 47



No. 48



No. 49



No. 50

ELECTRIC ORNAMENTS

Per Font \$3.50

Font contains twenty each of characters 1 and 2, eight of 3, four each 4, 6, 7, 8, 9, 10, 11, 16, 17, 18, 19, 20, 21, 22, 23, 24, 25, 26, 27, 28, 29, 30, 31, 32, 33, 34, 35, 36, 37, 38, 39, 40, 41, 42, 43, 44, 45, 46, 47, 48, 49, 50, 51, 52, 53, 54, 55, 56, 57, 58, 59, 60, 61, 62, 63, 64, 65, 66, 67, 68, 69, 70, 71, 72, 73, 74, 75, 76, 77, 78, 79, 80, 81, 82, 83, 84, 85, 86, 87, 88, 89, 90, 91, 92, 93, 94, 95, 96, 97, 98, 99, 100.



No. 21



No. 22



No. 23



No. 24



No. 25



No. 26



No. 27



No. 28



No. 16



No. 17



No. 18



No. 19

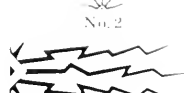

No. 20



No. 21



No. 22



No. 23

Collins Florets, Anti-Tuberculosis Emblems



No. 208 35c



No. 228
Set of four 40c



No. 160 Set of four 40c



No. 189 20c



No. 212 Set of four 50c



No. 144
Set of four 40c



No. 143
Set of four 40c



No. 190 25c



No. 199 35c



No. 215 Set of four 60c



No. 203 25c



No. 211 Set of four 50c



No. 214 Set of four 50c



No. 202 15c



No. 204 15c



No. 194 25c



No. 195 25c



No. 185 15c



No. 186 15c



No. 187 20c



No. 192 20c



No. 201 35c



No. 216 Set of four 50c



No. 206 20c



No. 207 20c



No. 193 35c



No. 205 20c



No. 184 20c



No. 183 15c

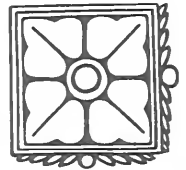

No. 196 35c



No. 210
Set of four 40c



No. 191 30c



No. 200 35c



No. 188 30c



No. 213
Set of four 40c



No. 209
Set of four 40c

+++++

ANTI-TUBERCULOSIS EMBLEMS

Official emblem of the Society for the Prevention and Cure of Tuberculosis
Font contains six inches of one size only

18 Pt. No. 18533 10c
Per Font 50c

36 Pt. No. 36533 15c
Per Font 75c

48 Pt. No. 48533 20c
Per Font \$1.00

24 Pt. No. 24533 10c
Per Font 50c

12 Pt. No. 12533 5c
Per Font 50c

Collins Florets

Group M

Four of one Character 30c Per Font \$2.00

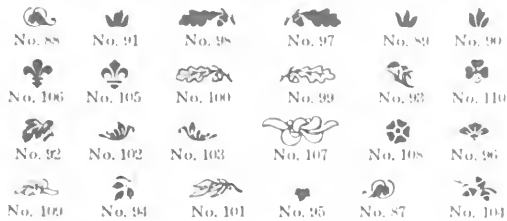

Group N

Four of one Character 40c Per Font \$3.00

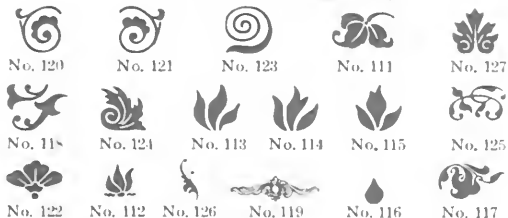

Group O

Four of one Character 40c Per Font \$3.00

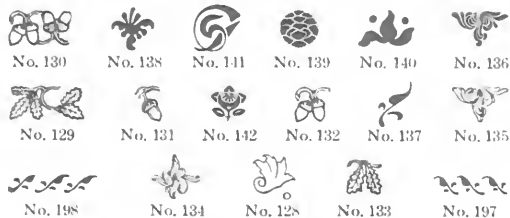

Group W

Four of one Character 40c Per Font \$2.50

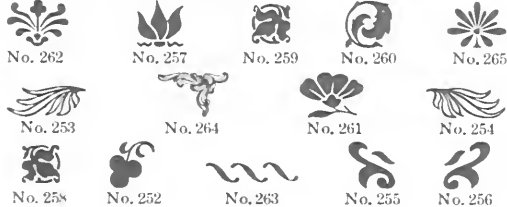

Group Z

Four of one Character 50c Each Character 15c



Group Q

Four of one Character 50c Two of one Character 30c

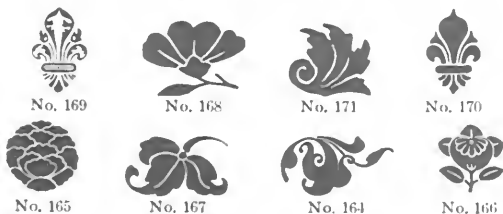

Group P

Four of one Character 40c



Group V

Four of one Character 40c Per Font \$1.50

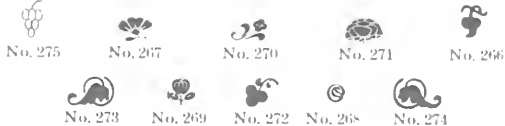

Group X

Four of one Character 40c Per Font \$2.50



Group Y

Four of one Character 40c



Group R

Four of one Character 50c Two of one Character 30c



Florets, Rogers Embellishments and Tail Pieces

ELZEVIR FLORETS

Group C Per Font \$1.65

Font contains four of each character

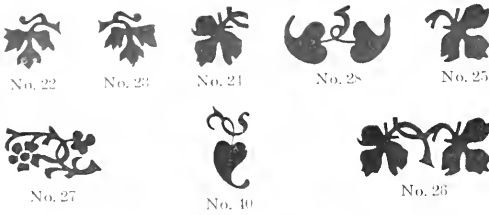

Group B Per Font \$0.90

Font contains four of each character



Group D Per Font \$1.50

Font contains four of each character



Group A Per Font \$0.50

Font contains four of each character



ACANTHINE FLORETS

Per Font \$2.25

Font contains four of each character

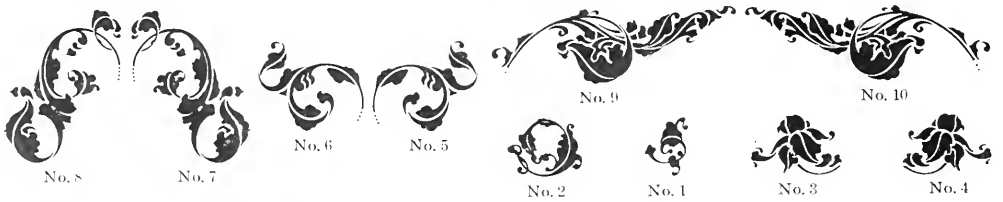

ROGERS EMBELLISHMENTS

Per Font \$1.00

Font contains one of each character

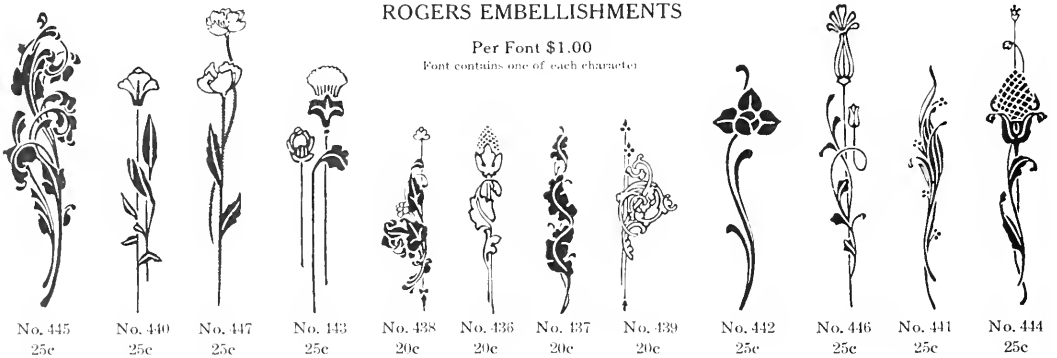

MIDGET TAIL PIECES Per Font \$1.25

Font contains three of each character

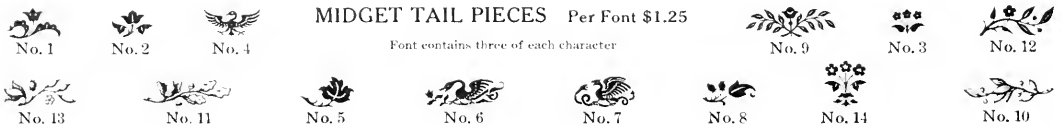

Hapgood Florets and Dewey Ornaments

HAPGOOD FLORETS SHOWN AS BANDS

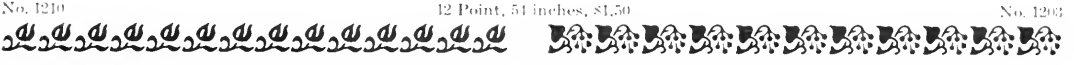
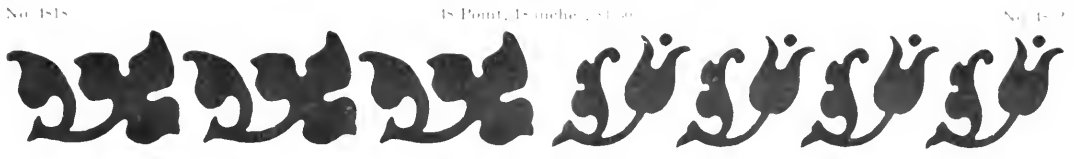

DEWEY ORNAMENTS

Series No. 1 Per Font \$1.50
Font contains one of each character

Series No. 2 Per Font \$2.00
Font contains one of each character

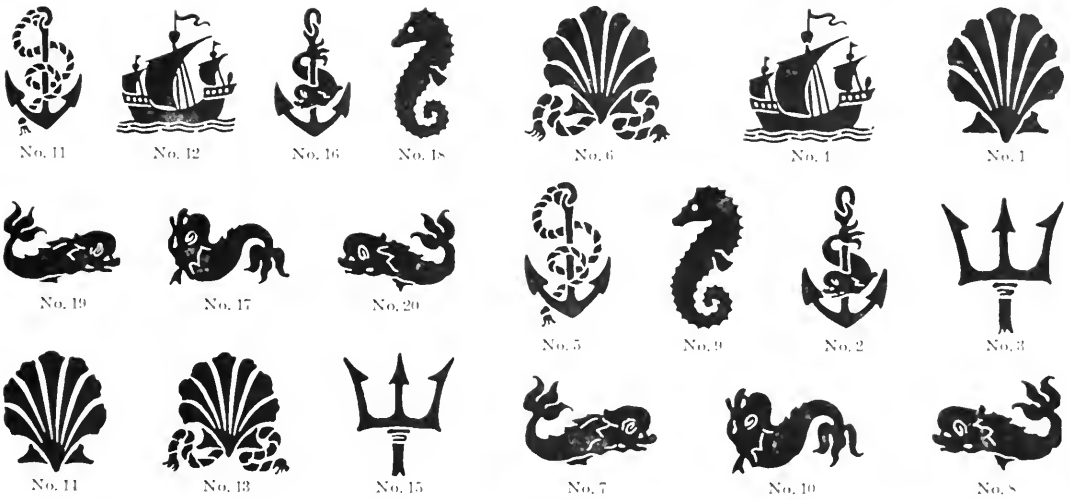

Series No. 3 Per Font \$1.00
Font contains one of each character



Busha Ornaments and Egyptian Ornaments

BUSHA ORNAMENTS

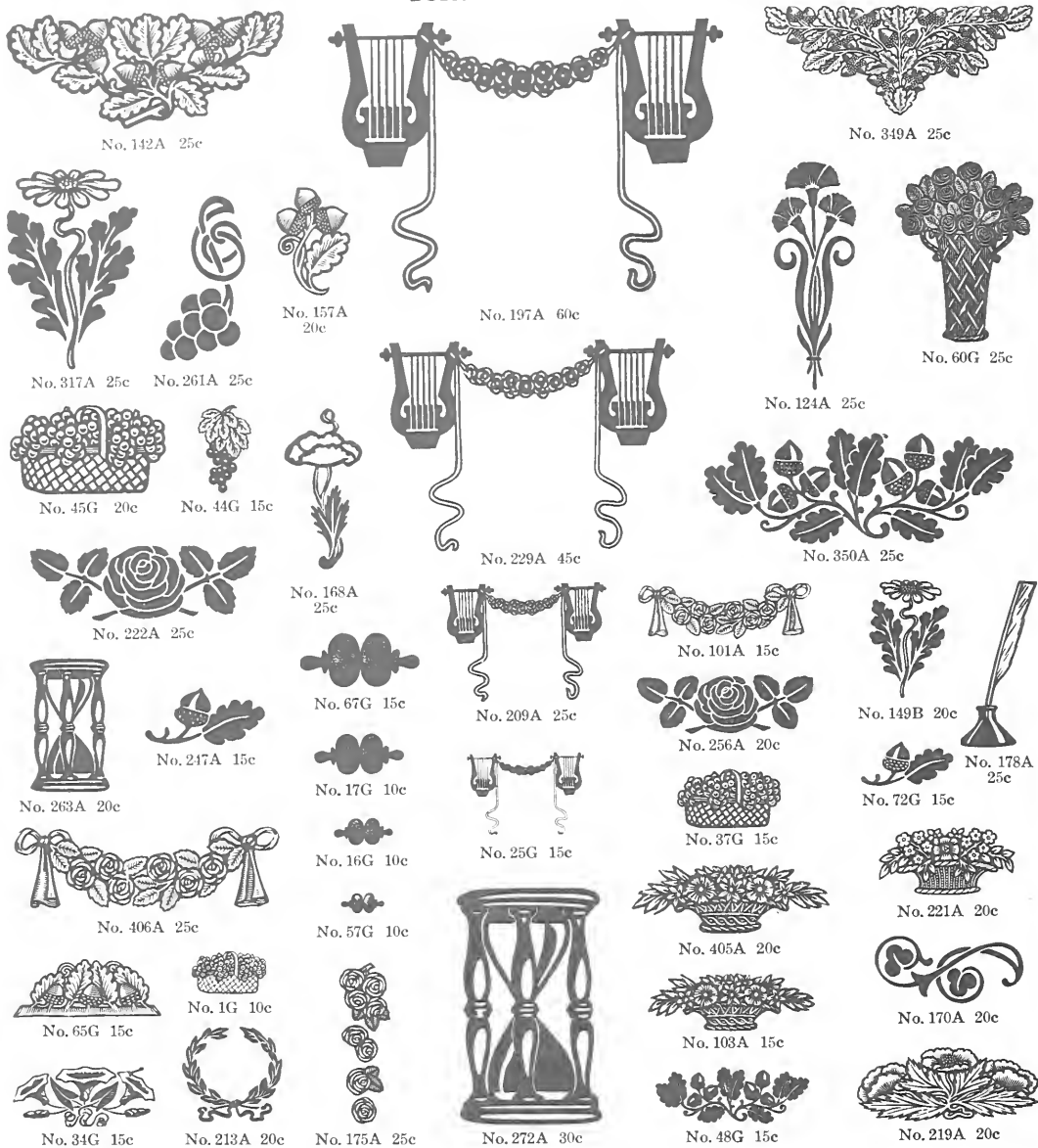

EGYPTIAN ORNAMENTS

Series B

Per Font \$2.50 Half Font \$1.25

Font contains two of character 13; six each 10 and 15; four each 11, 12, 14, 16, 17, 18, 19 and 20

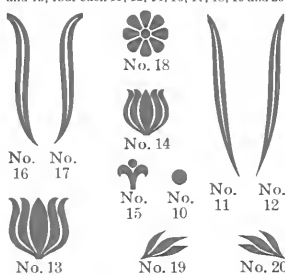

Series A

Per Font \$2.50 Half Font \$1.25

Font contains four of each character

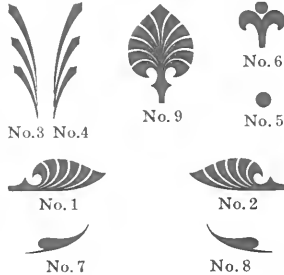

Series C

Per Font \$2.50 Half Font \$1.25

Font contains two of character 22; six each 23, 24, 25 and 27; ten each 21 and 25

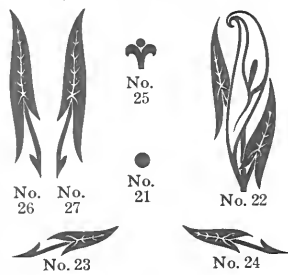

Valentine, Bookman and Page Ornaments, Glad Hands, Pointers

VALENTINE ORNAMENT

Series No. 62
Per Font \$1.00

Copyrighted by
AMERICAN TYPE FOUNDERS COMPANY



No. 60017 25c

No. 24032A 10c



No. 24032 10c

BOOKMAN ORNAMENTS



No. 41A 75c

AMERICAN
TYPE FOUNDERS
COMPANY

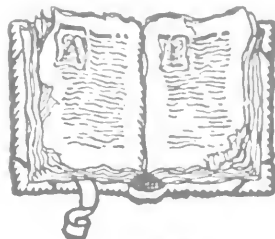

No. 31A 50c

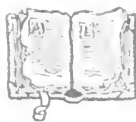

No. 21A 75c

GLAD HANDS



No. 2 40c



No. 1 35c

PAGE ORNAMENTS



No. 8105 40c



No. 5101 25c

POINTERS

Per Font \$1.00

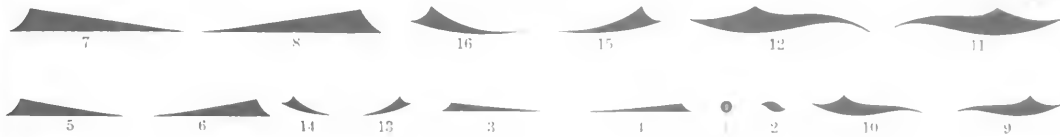

SHADED POINTERS

Per Font \$1.00



CONTOUR POINTERS

Per Font \$1.00



Kate Greenaway Mignonettes



No. 45 30c

No. 52 25c

No. 43 30c

No. 11 30c

No. 29 25c

No. 16 30c



No. 38 25c

No. 12 25c

No. 30 25c

No. 57 25c

No. 48 30c

No. 19 30c

No. 56 25c

No. 10 25c

No. 35 25c

No. 7 25c

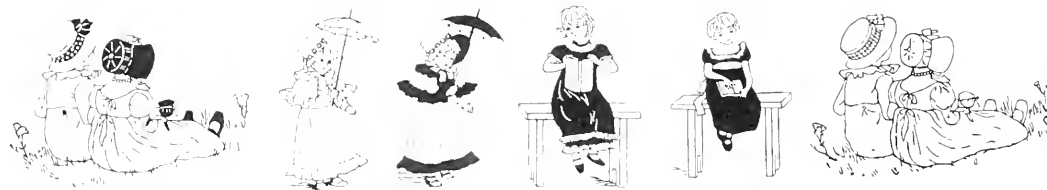

No. 44 30c

No. 1 25c

No. 31 25c

No. 17 25c

No. 49 30c

No. 13 30c



No. 15 30c

No. 29 25c

No. 42 25c

No. 11 25c

No. 1 25c

No. 51 25c

No. 54 25c

No. 46 30c



No. 25 25c

No. 59 25c

No. 53 25c

No. 28 25c

No. 22 25c

No. 58 25c

No. 27 25c

No. 50 25c

No. 21 25c



No. 18 30c

No. 60 25c

No. 24 25c

No. 10 25c

No. 9 25c

No. 55 25c

No. 5 25c

No. 11 25c

No. 23 25c

No. 17 25c



No. 6 25c

No. 36 25c

No. 3 25c

No. 8 25c

No. 33 25c

No. 31 25c

No. 37 25c

No. 2 25c

No. 32 25c

No. 26 25c

No. 39 25c

Lady Speakers, Klondikers, Army and Navy, Hello Cuts

LARGE LADY SPEAKERS

Single Character 25c

Font contains 25 different characters

Per Font \$1.25



No. 21



No. 22



No. 26



No. 23



No. 25



No. 27



No. 24



No. 28



No. 29

SMALL LADY SPEAKERS

Single Character 20c

Per Font 75c



No. 18



No. 16



No. 15



No. 14



No. 13

Font contains 20 different characters



No. 12



No. 11



No. 19



No. 20



No. 17

ARMY AND NAVY No. 1

Single Character 25c

Per Font \$1.25



No. 1



No. 5



No. 2



No. 7



No. 10

Font contains 12 different characters



No. 3



No. 12



No. 4

KLONDIKERS

Single Character 25c

Per Font \$1.25



No. 3



No. 5



No. 1



No. 2



No. 8



No. 9



No. 6

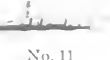

No. 11

For additional Army and Navy see page 957



No. 6



No. 8



No. 9

Font contains 11 different characters



No. 7



No. 10



No. 4

HELLO CUTS

Per Font \$1.00

Font contains 10 different characters



72 Pt. 25c



60 Pt. 20c



21 Pt. 10c



18 Pt. 10c



36 Pt. 15c



48 Pt. 20c



96 Pt. 25c

All cuts shown on this page are cast in type molds

Shoppers, Small Scorchers, Colonials, Large Scorchers

SHOPPERS

Font contains one of each character

Single Character 25c

Per Font \$1.00



No. 10



No. 9



No. 8



No. 5



No. 6



No. 7



No. 4



No. 3



No. 2



No. 1

SMALL SCORCHERS

Font contains one of each character

Single Character 20c

Per Font \$1.00

COLONIALS

Font contains one of each character

Single Character 25c

Per Font 75c



No. 20



No. 18



No. 17



No. 16



No. 5



No. 2



No. 7



No. 1



No. 11



No. 19



No. 14



No. 8



No. 6



No. 4



No. 3



No. 15



No. 13



No. 12



No. 10



No. 9

LARGE SCORCHERS

Single Character 30c

Per Font \$1.75



No. 7



No. 5



No. 3



No. 6



No. 8

Font contains one of each character



No. 9



No. 1



No. 2



No. 10



No. 4

Booklet Ornaments and Margin Ornaments

Single Character 25c

BOOKLET ORNAMENTS No. 2

Font contains one of each character

Per Font \$2.50



No. 11



No. 7



No. 4



No. 9



No. 10



No. 3



No. 5



No. 6



No. 12



No. 8



No. 1



No. 2

Single Character 20c

BOOKLET ORNAMENTS No. 1

Font contains one of each character

Per Font \$1.25



No. 12



No. 11



No. 4



No. 10



No. 5



No. 6



No. 9



No. 3



No. 14



No. 2



No. 1



No. 8



No. 13



No. 7

MARGIN ORNAMENTS

Series No. 1 Per Font \$1.00

Font contains two of character 14; three each 12 and 13

Series No. 2 Per Font \$1.00

Font contains three of each character



No. 12 20c



No. 14 30c



No. 13 20c



No. 15 30c



No. 16 30c

Druggists, Silhouettes, Bowlers, Hoboes, Chefs and Waiters

DRUGGISTS

Font contains one of each character

Single Character 25c

Per Font \$1.00

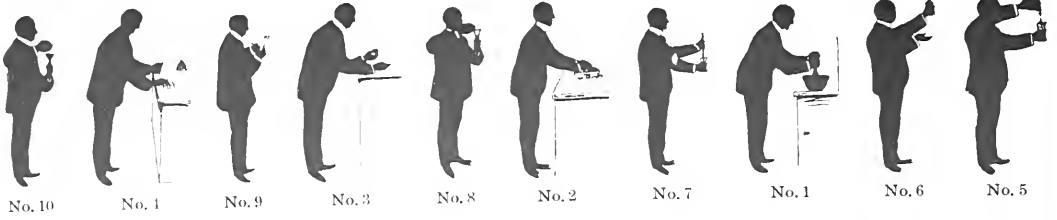

SILHOUETTES

Font contains one of each character

Single Character 25c

Per Font \$1.25

BOWLERS

Font contains one of each character

Single Character 25c

Per Font \$1.25

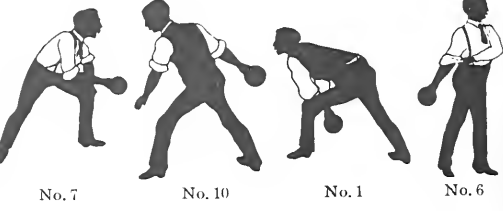
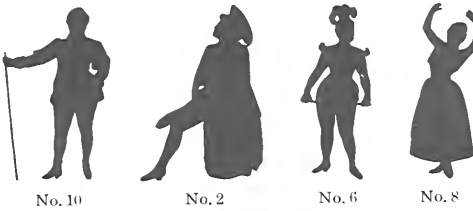
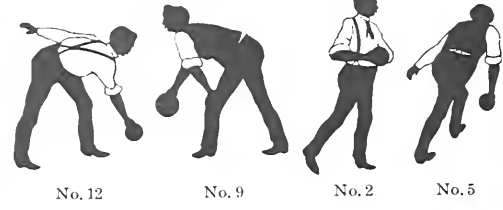
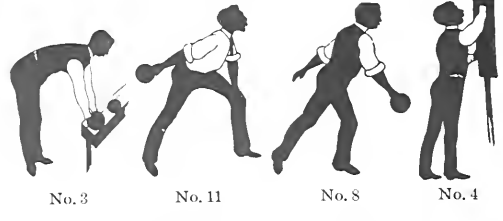
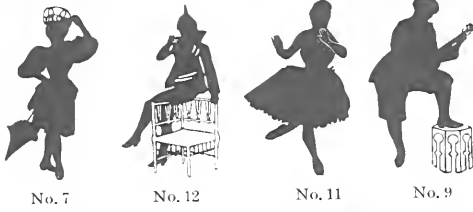

HOBOS

Font contains one of each character

Single Character 25c

Per Font \$1.00

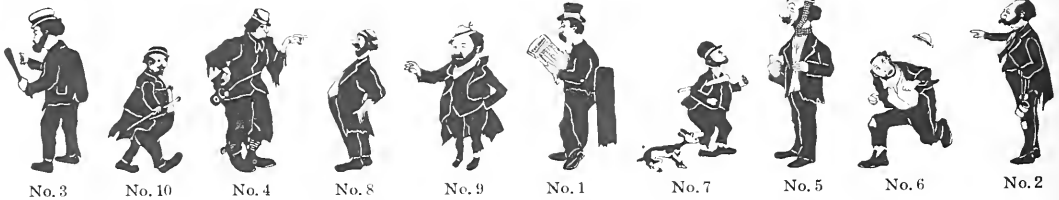

DELMONICO CHEFS AND WAITERS

Font contains one of each character

Single Character 25c

Per Font \$1.00

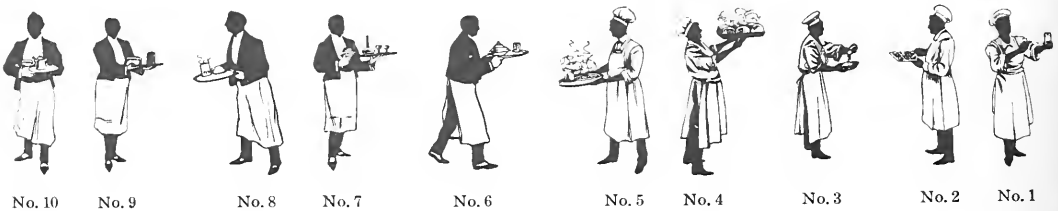

All cuts shown on this page are cast in type molds and are easily justified

Pick-Ups, Campaigners, Speakers, Athletes, Rigs and Traps

PICK-UPS

Single Character 25c

Per Font \$1.25



SPEAKERS

Single Character 20c

Per Font \$1.00



ATHLETES

Single Character 25c

Per Font \$1.25

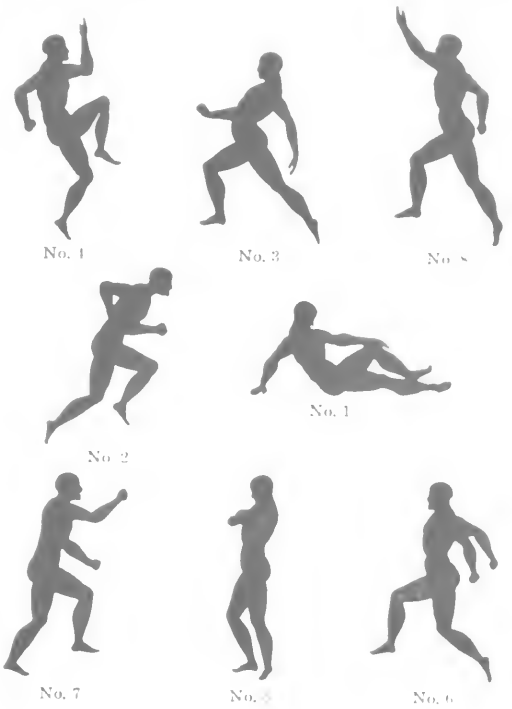

CAMPAIGNERS

Single Character 25c

Per Font \$1.50



RIGS AND TRAPS

Single Character 20c

Per Font \$1.00

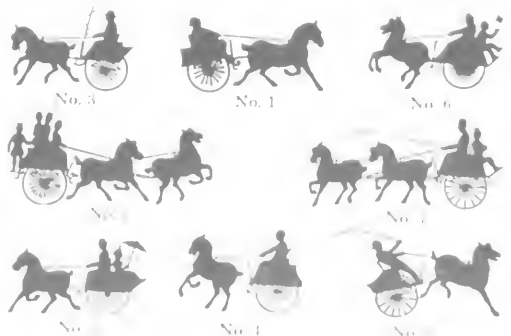

Coppers, Ballet Dancers, American Indians, Rounders

COPPERS

Font contains one of each character

Per Font \$1.25

Single Character 25c



BALLET DANCERS

Font contains one of each character

Per Font \$1.50

Single Character 25c



AMERICAN INDIANS

Per Font \$1.25

Single Character 25c

Font contains one of each character

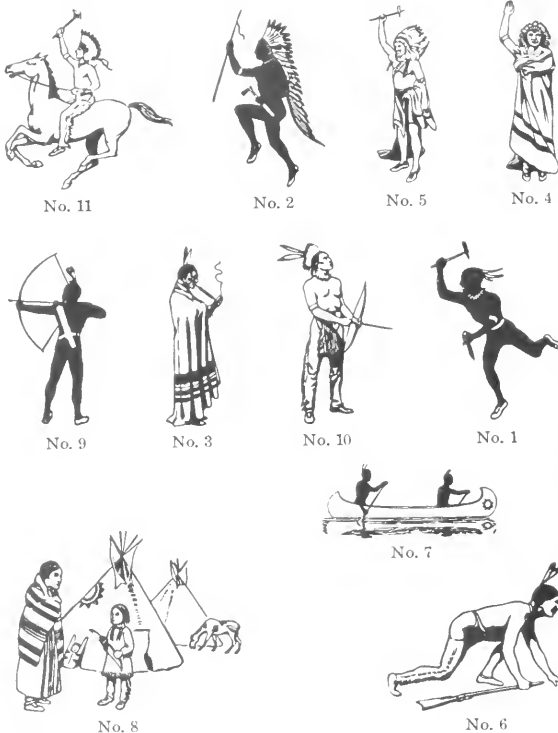

ROUNDERS

Single Characters Nos. 1, 2, 3 and 5, 30c
Nos. 4 and 6, 40c Per Font \$1.25

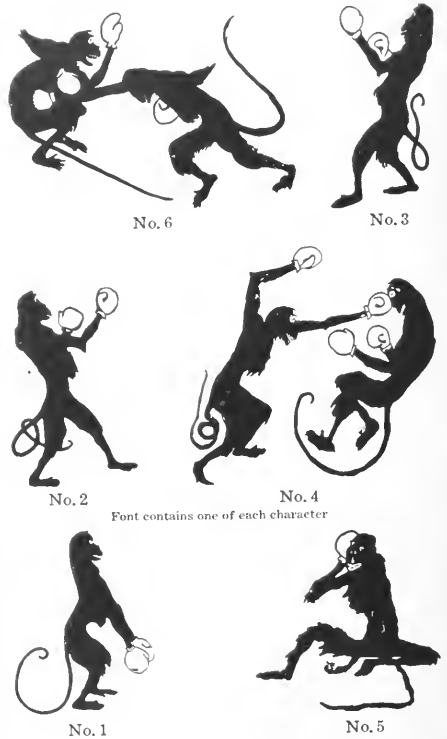

Font contains one of each character

Golfers, Domestics, Listeners and Christmas Ornaments

GOLFERS

Single Character 25c

Per Font \$1.50

Font contains one of each character



No. 1



No. 10



No. 3



No. 9



No. 6



No. 7



No. 5



No. 3



No. 2



No. 4



No. 8



No. 2



No. 1



No. 4



No. 3



No. 8



No. 5



No. 7



No. 10

For our latest Series of Golf Illustrators see pages 958 and 959

LADY GOLFERS

Single Character 25c

Per Font \$1.50

Font contains one of each character

Single Character 25c

DOMESTICS

Font contains one of each character

Per Font \$1.00



No. 10



No. 2



No. 9



No. 1



No. 7



No. 8



No. 6



No. 3



No. 5



No. 4

Single Character 20c

LISTENERS

Font contains one of each character

Per Font \$1.00



No. 6



No. 10



No. 9



No. 4



No. 5



No. 8



No. 3



No. 2



No. 7



No. 1

CHRISTMAS ORNAMENTS



No. 283A 20c



No. 287A 15c



No. 288A 15c



No. 286A 15c



No. 280A 40c



No. 281A 15c



No. 277A 15c



No. 279A 15c



No. 282A 15c



No. 284A 15c



No. 285A 15c



No. 278A 20c



No. 276A 20c

Three Point Borders

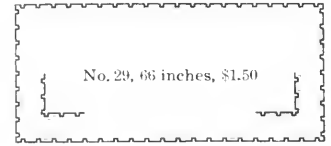
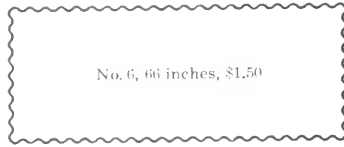
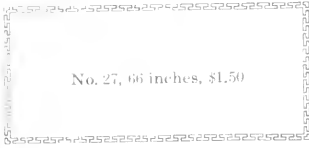
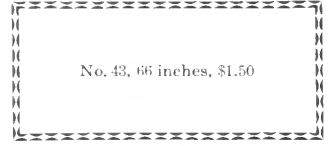
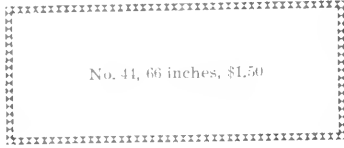
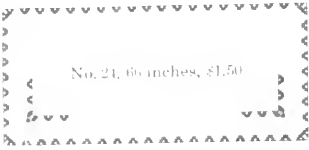

Three Point Borders

The Three Point Borders shown on this page are considered the most popular designs in Running Borders on the market. For neat labels, dainty panel work and similar printing they will be found remarkably effective. The ease with which these Borders can be assembled is at once apparent to the discerning printer and will be found a strong factor in shops where high-grade work in record time is essential, in fact these Borders will make an excellent addition to any composing room

AMERICAN TYPE FOUNDERS CO.

No. 14, 66 inches, \$1.50

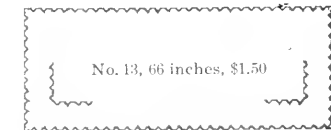
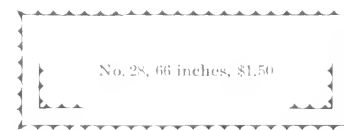
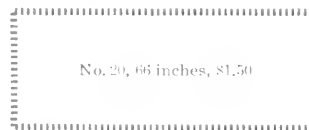
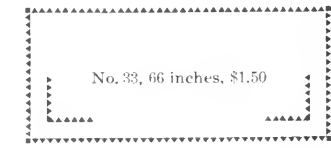
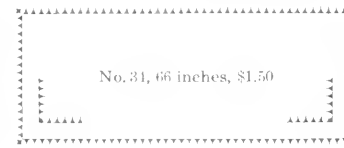
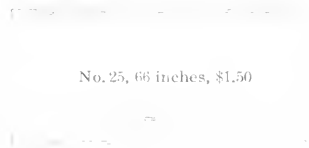
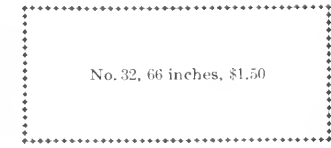
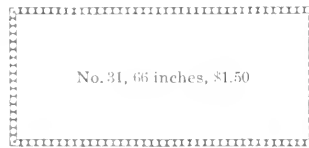
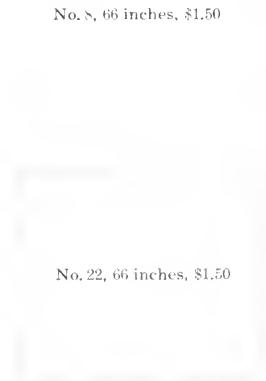

Six Point Borders and Twelve Point Borders

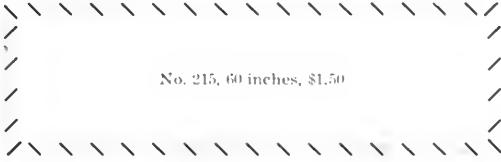
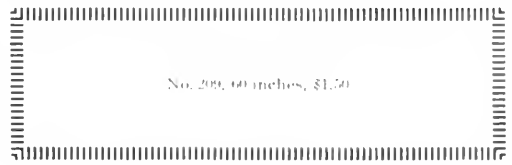
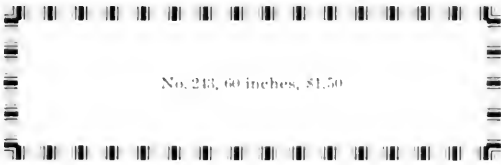

No. 207, 60 inches, \$1.50

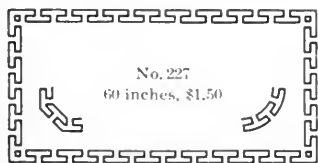
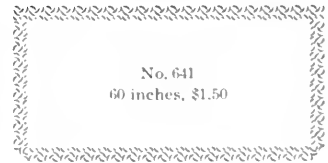
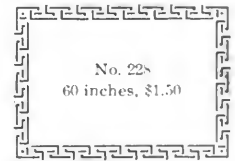
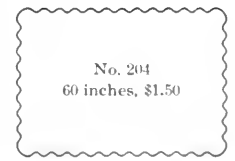
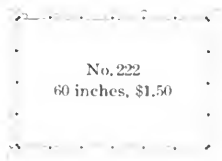
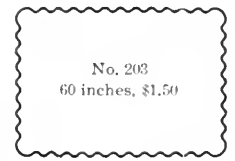

Newspaper Borders

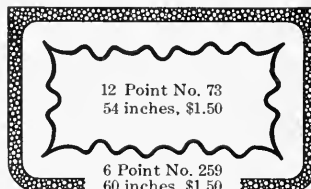
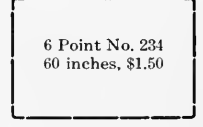
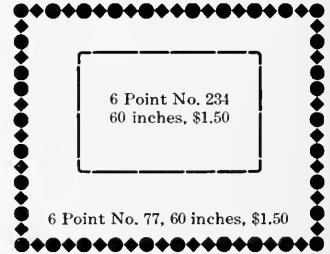
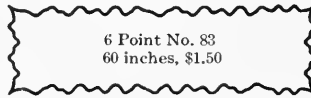
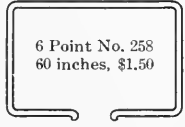
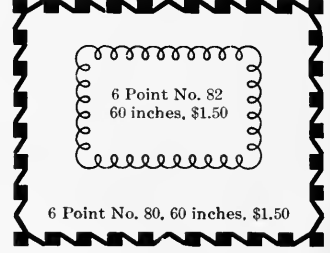
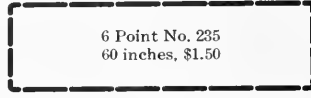
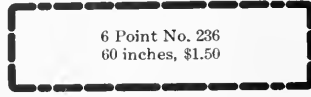
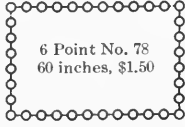
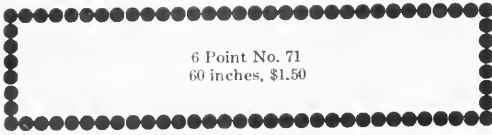

12 Point No. 73
54 inches, \$1.50

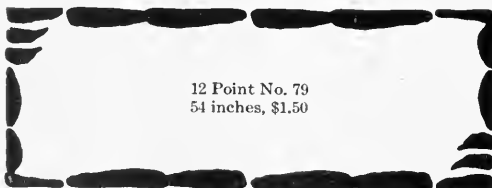

Newspaper Borders



12 Point No. 76
54 inches, \$1.50



12 Point No. 66
54 inches, \$1.50



12 Point No. 85
54 inches, \$1.50



12 Point No. 74
54 inches, \$1.50



12 Point No. 240
54 inches, \$1.50



12 Point No. 75
54 inches, \$1.50



12 Point No. 67
54 inches, \$1.50



12 Point
No. 57
54 inches
\$1.50



12 Point No. 64
54 inches, \$1.50

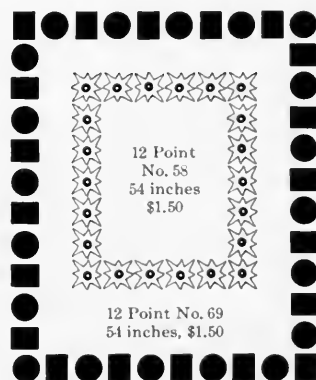

12 Point
No. 58
54 inches
\$1.50

12 Point No. 69
54 inches, \$1.50



12 Point No. 84
54 inches, \$1.50



12 Point No. 233
54 inches, \$1.50



12 Point No. 71
54 inches, \$1.50



12 Point No. 68
54 inches, \$1.50



12 Point No. 72
54 inches, \$1.50



12 Point No. 77
54 inches, \$1.50



12 Point No. 63
54 inches, \$1.50

Newspaper Borders



18 Point No. 18
36 inches, \$1.30



18 Point No. 21
36 inches, \$1.30



18 Point No. 19
36 inches, \$1.30



18 Point No. 7, 36 inches, \$1.30

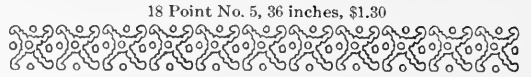

18 Point No. 5, 36 inches, \$1.30



18 Point No. 24
36 inches, \$1.30



18 Point No. 23
36 inches, \$1.30



18 Point No. 22
36 inches, \$1.30



18 Point No. 16, 36 inches, \$1.30



18 Point No. 13
36 inches, \$1.30



18 Point No. 4
36 inches, \$1.30



18 Point No. 20
36 inches, \$1.30

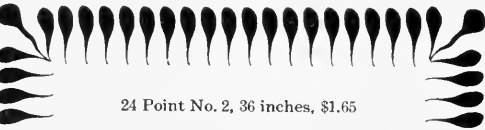

24 Point No. 2, 36 inches, \$1.65



24 Point No. 3, 36 inches, \$1.65



24 Point No. 4, 36 inches, \$1.65

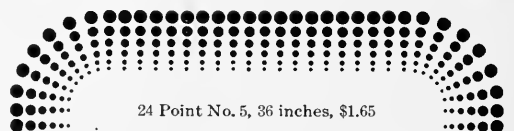

24 Point No. 5, 36 inches, \$1.65



36 Point No. 1, 24 inches, \$1.65

Typotect Borders and Linear Borders

12 Point No. 1, 54 inches, \$1.40

18 Point No. 1, 36 inches, \$1.30

TYPOTECT BORDER No. 1

Characters in Complete Font



Characters in the three sizes of this border are the same in design

6 Point No. 1, 60 inches, \$1.50

18 Point No. 2, 36 inches, \$1.30

12 Point No. 2, 54 inches, \$1.50

LINEAR BORDER No. 2

Characters in Complete Font



Characters in the three sizes of this border are the same in design

6 Point No. 2, 60 inches, \$1.50

Six Point Panel Borders

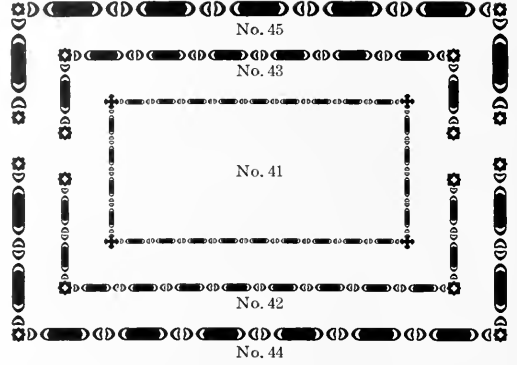
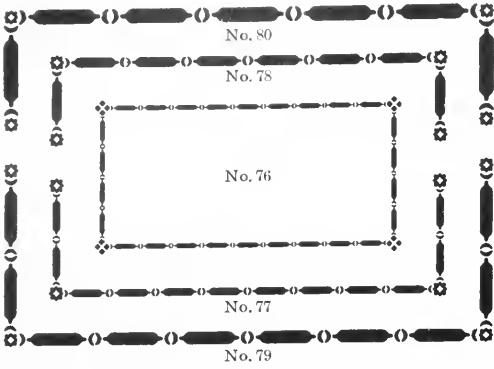

SIX POINT PANEL BORDERS

Per Font, 60 inches, \$1.50

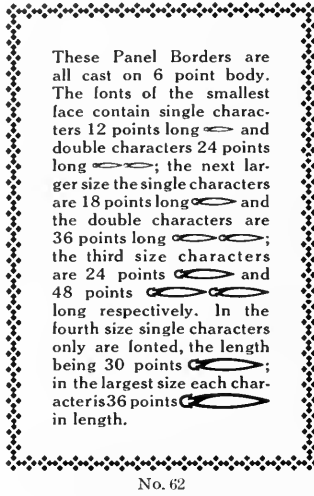
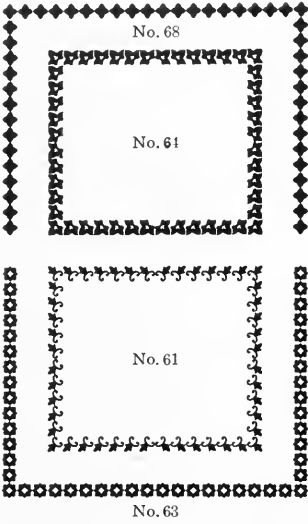

These Panel Borders are all cast on 6 point body. The fonts of the smallest face contain single characters 12 points long and double characters 24 points long; the next larger size the single characters are 18 points long and the double characters are 36 points long; the third size characters are 24 points and 48 points long respectively. In the fourth size single characters only are lanted, the length being 30 points; in the largest size each character is 36 points in length.

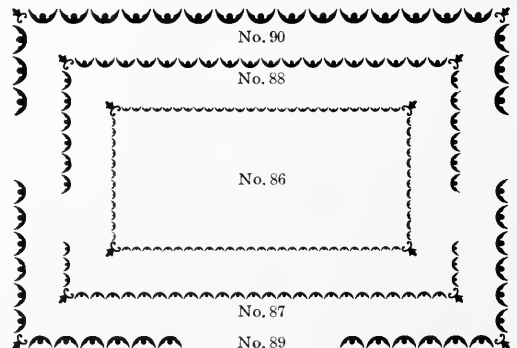
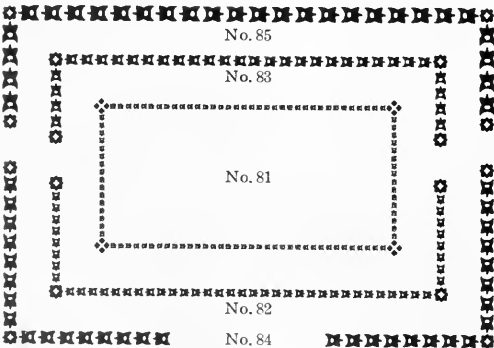
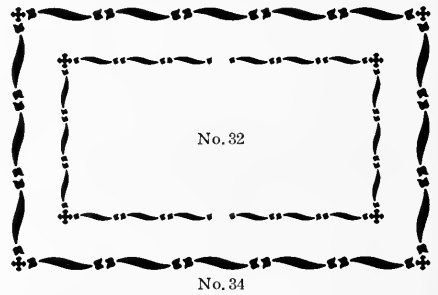
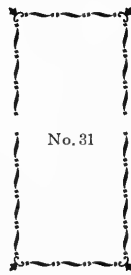
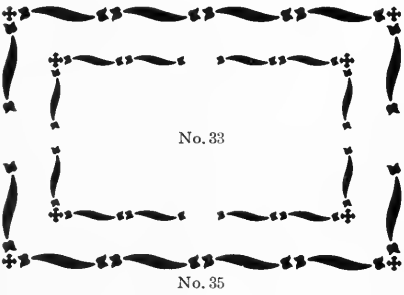
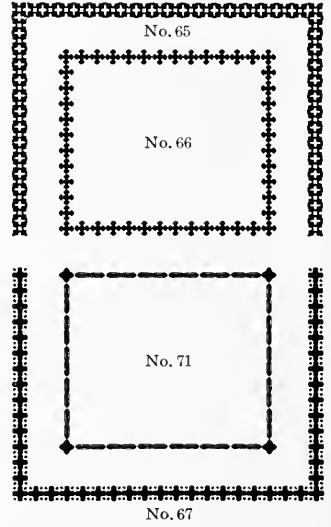

Six Point Panel Borders

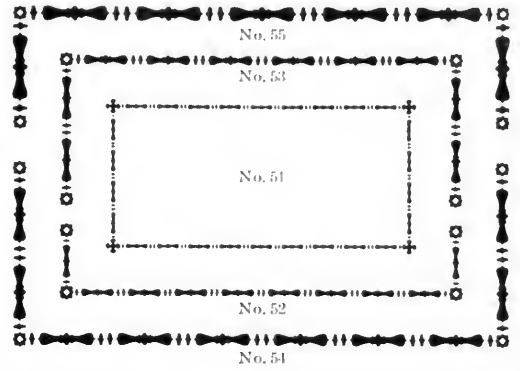
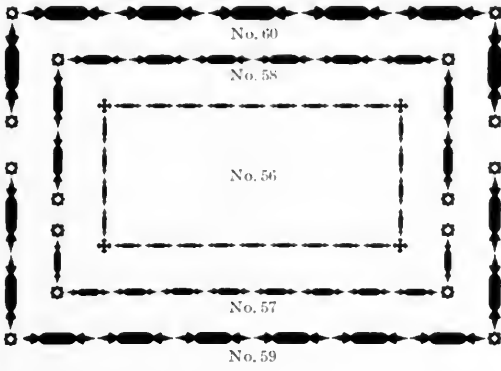

SIX POINT PANEL BORDERS

Per Font, 60 inches, \$1.50

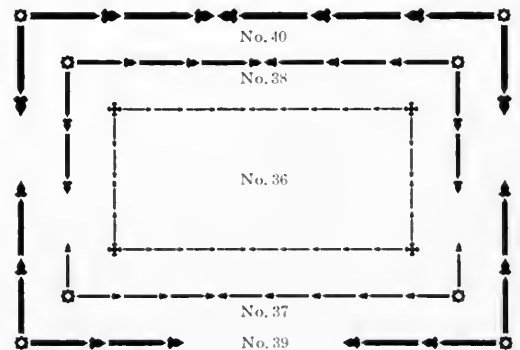
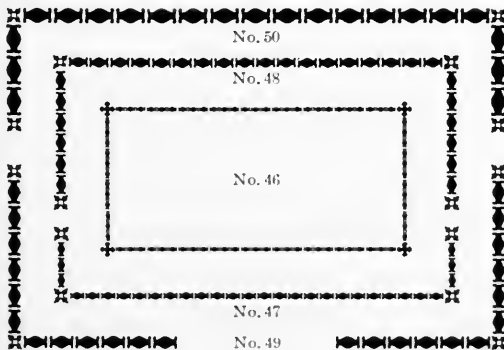
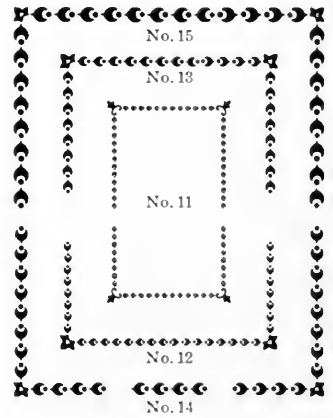
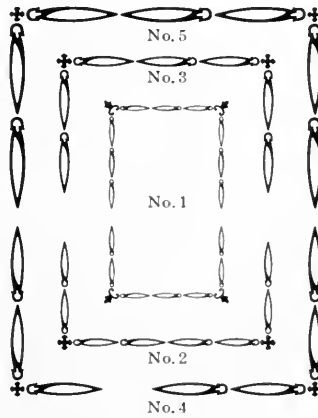
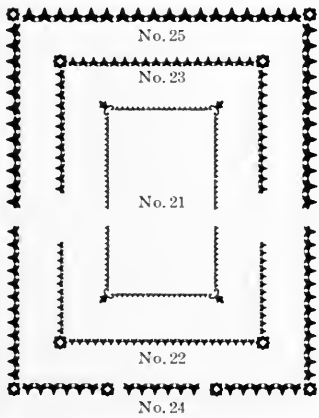
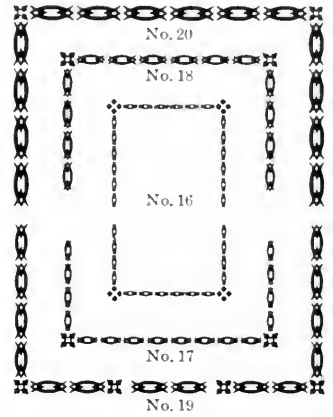
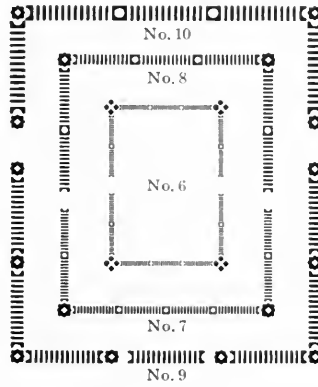
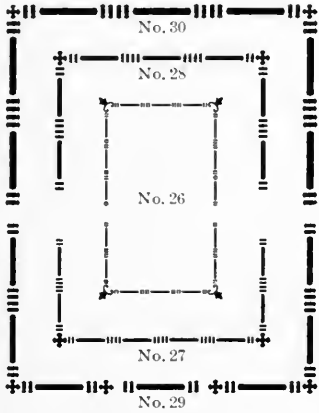

Art Borders



12 Point No. 6, Open
54 inches, \$1.50

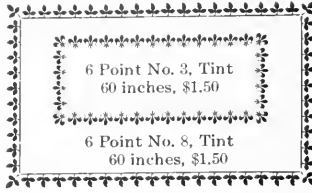

6 Point No. 3, Tint
60 inches, \$1.50
6 Point No. 8, Tint
60 inches, \$1.50



12 Point No. 1
54 inches, \$1.50

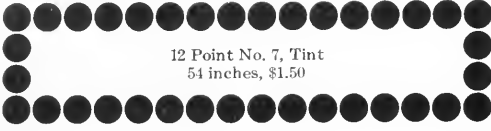

12 Point No. 7, Tint
54 inches, \$1.50

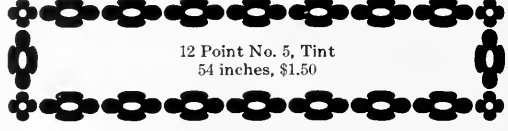

12 Point No. 5, Tint
54 inches, \$1.50



12 Point
No. 8, Open
54 inches
\$1.50

12 Point No. 8, Tint
54 inches, \$1.50

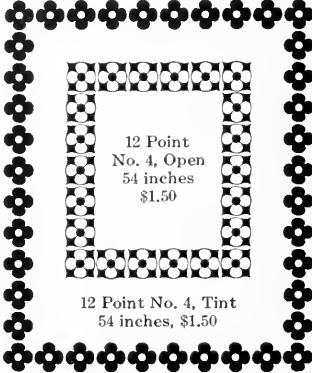

12 Point
No. 4, Open
54 inches
\$1.50

12 Point No. 4, Tint
54 inches, \$1.50



12 Point
No. 3, Open
54 inches
\$1.50

12 Point No. 3, Tint
54 inches, \$1.50

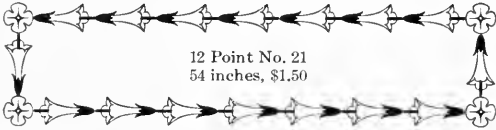

12 Point No. 21
54 inches, \$1.50



12 Point No. 12
54 inches, \$1.50



12 Point No. 11
54 inches, \$1.50



12 Point No. 2
54 inches, \$1.50



12 Point No. 9
54 inches, \$1.50



18 Point No. 3, Open, 36 inches, \$1.30



18 Point No. 3, Tint, 36 inches, \$1.30



18 Point No. 9
36 inches, \$1.30



18 Point No. 11
36 inches, \$1.30

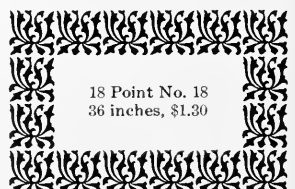

18 Point No. 18
36 inches, \$1.30

Art Borders



18 Point No. 7, Tint
36 inches, \$1.30



18 Point No. 24
36 inches, \$1.30



18 Point No. 17
36 inches, \$1.30



24 Point No. 25, 36 inches, \$1.65

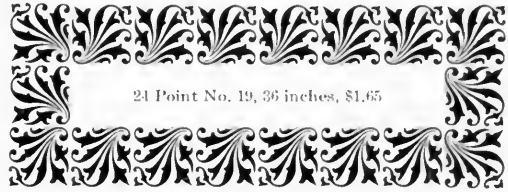

24 Point No. 19, 36 inches, \$1.65



24 Point No. 24, 36 inches \$1.65

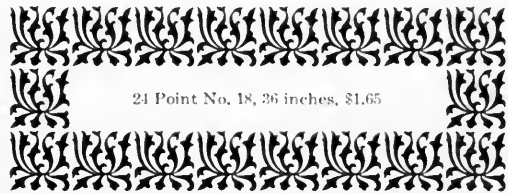

24 Point No. 18, 36 inches, \$1.65

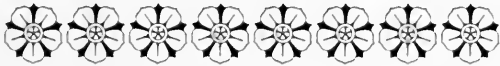

24 Point No. 20, 36 inches, \$1.65



24 Point No. 7 Tint, 36 inches, \$1.65



24 Point No. 3 Tint, 36 inches, \$1.65



24 Point No. 3 Open, 36 inches, \$1.65

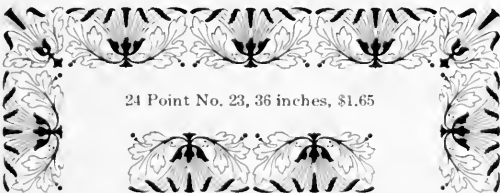

24 Point No. 23, 36 inches, \$1.65



24 Point No. 15, 36 inches, \$1.65



36 Point No. 25, 24 inches \$1.65

Old English Borders



12 Point No. 29
54 inches, \$1.50



12 Point No. 30
54 inches, \$1.50



12 Point
No. 20
54 inches
\$1.50

12 Point No. 8, 54 inches, \$1.50



12 Point No. 28
54 inches, \$1.50



12 Point No. 6
54 inches, \$1.50



10 Point No. 17, 54 inches, \$1.40

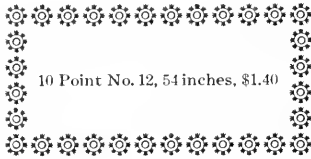

10 Point No. 12, 54 inches, \$1.40



10 Point No. 5, 54 inches, \$1.40

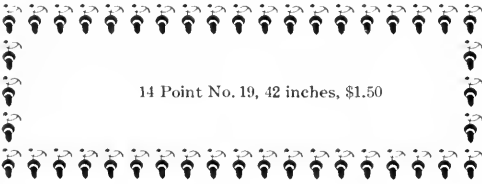

14 Point No. 19, 42 inches, \$1.50

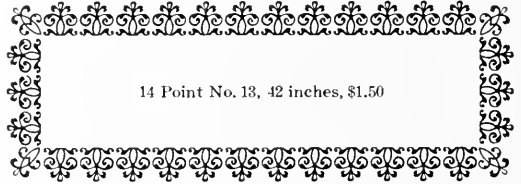

14 Point No. 13, 42 inches, \$1.50

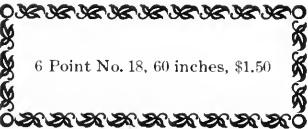

6 Point No. 18, 60 inches, \$1.50

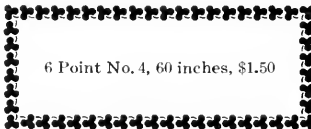

6 Point No. 4, 60 inches, \$1.50

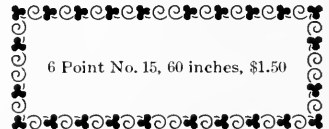

6 Point No. 15, 60 inches, \$1.50

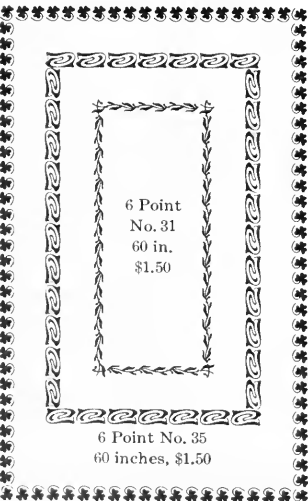

6 Point
No. 31
60 in.
\$1.50

6 Point No. 35
60 inches, \$1.50

6 Point No. 34, 60 inches, \$1.50

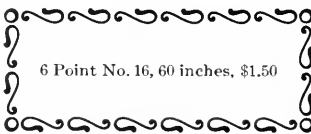

6 Point No. 16, 60 inches, \$1.50

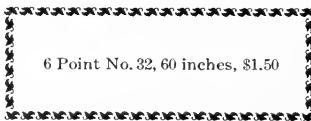

6 Point No. 32, 60 inches, \$1.50

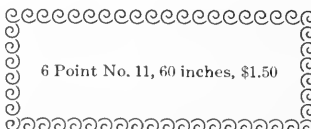

6 Point No. 11, 60 inches, \$1.50

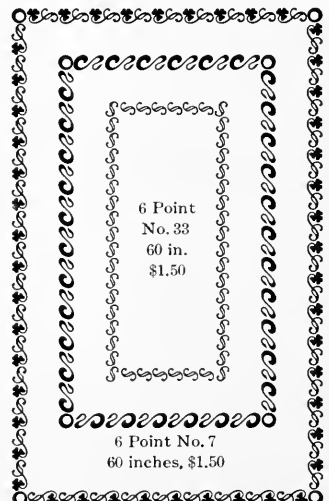

6 Point
No. 33
60 in.
\$1.50

6 Point No. 7
60 inches, \$1.50

6 Point No. 3, 60 inches, \$1.50

Old English Borders



6 Point No. 26, 60 inches, \$1.50

8 Point No. 21, 54 inches, \$1.35

12 Point No. 21, 54 inches, \$1.50



18 Point No. 27, 36 inches, \$1.30

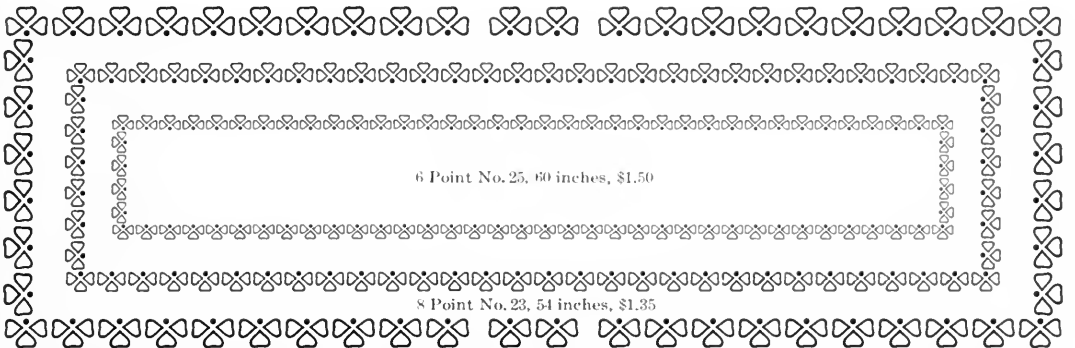

6 Point No. 25, 60 inches, \$1.50

8 Point No. 23, 54 inches, \$1.35

12 Point No. 22, 54 inches, \$1.50

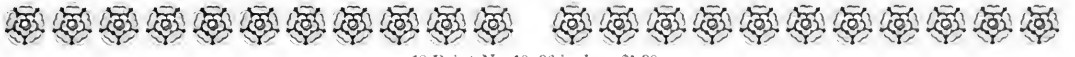

18 Point No. 10, 36 inches, \$1.30

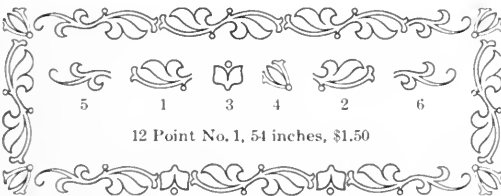

12 Point No. 1, 54 inches, \$1.50

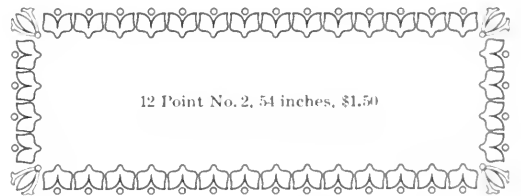

12 Point No. 2, 54 inches, \$1.50

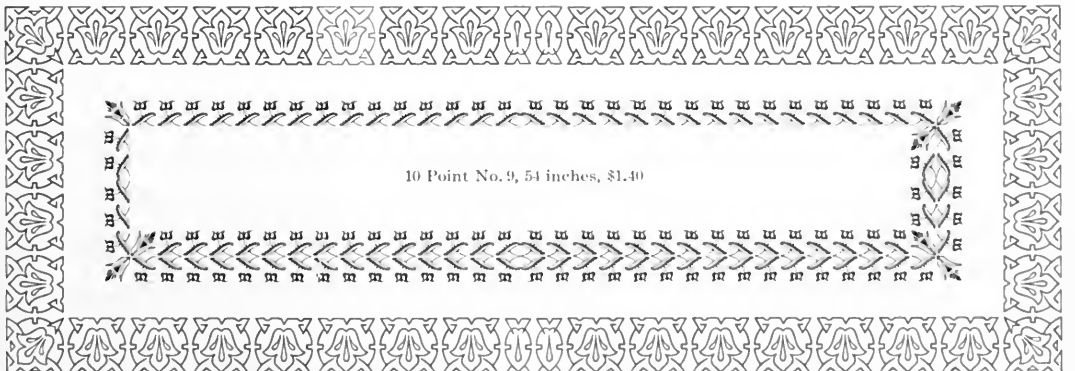

10 Point No. 9, 54 inches, \$1.40

24 Point No. 14, 36 inches, \$1.65

Laurel Borders and Laurel Borders No. 2

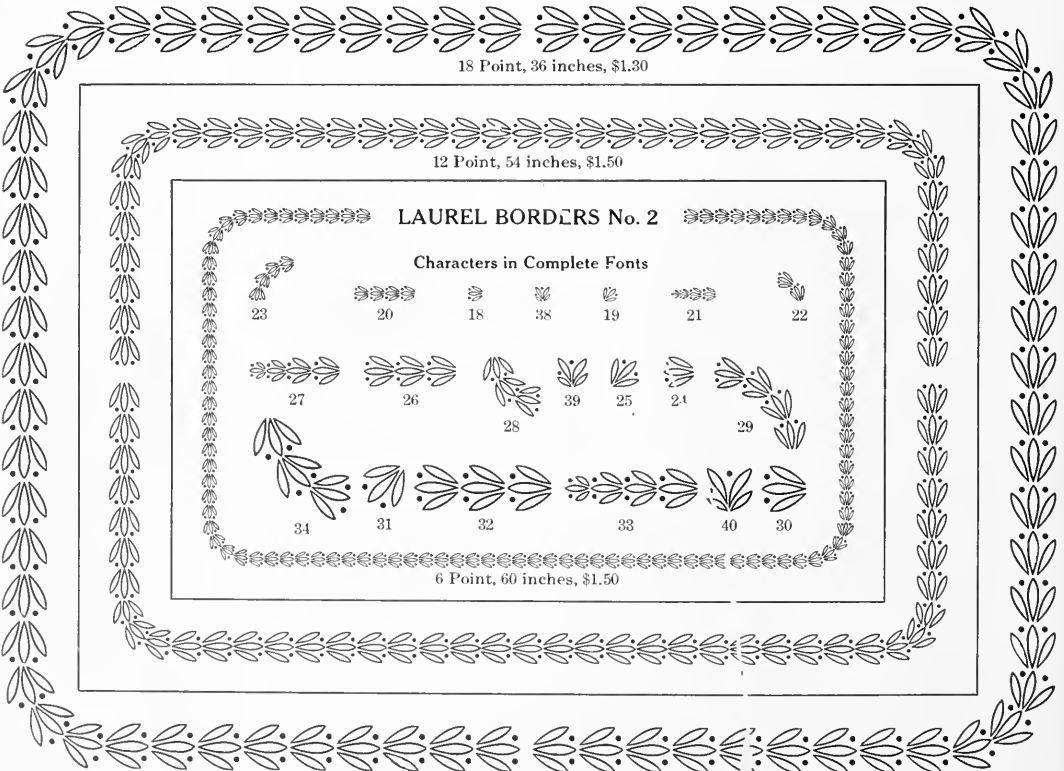
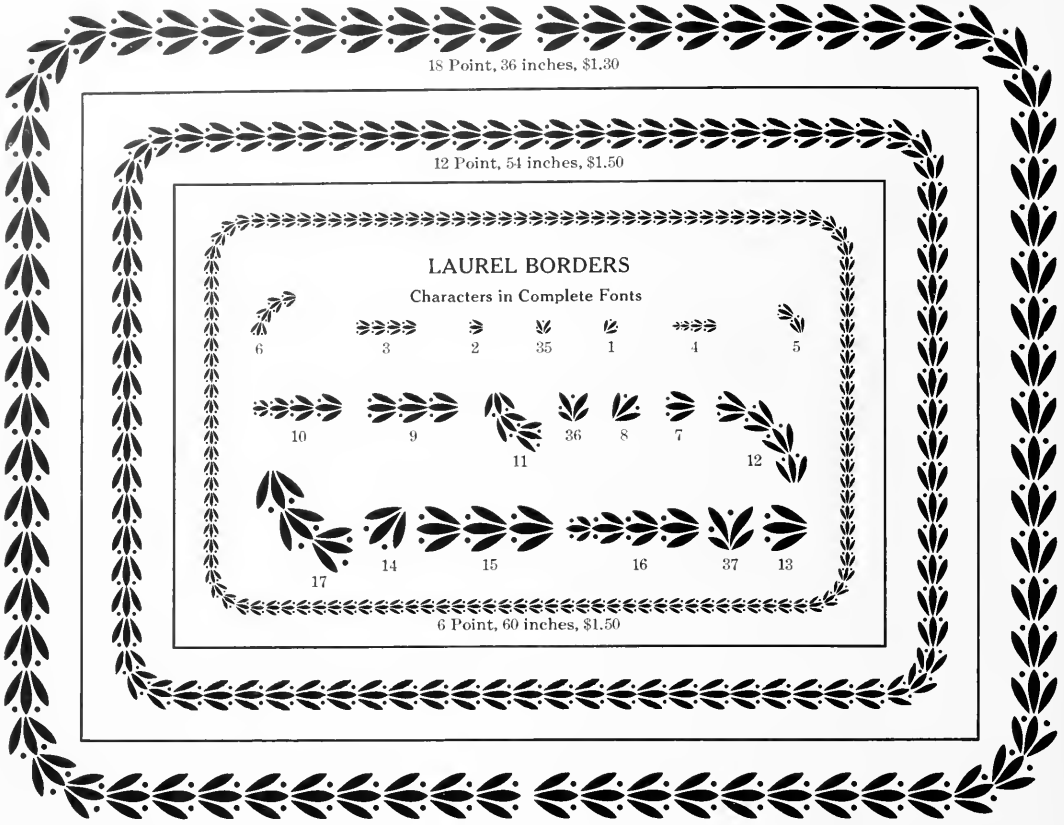

Strathmore Borders



24 Point No. 2401
36 inches, \$1.65



24 Point No. 2406
36 inches, \$1.65

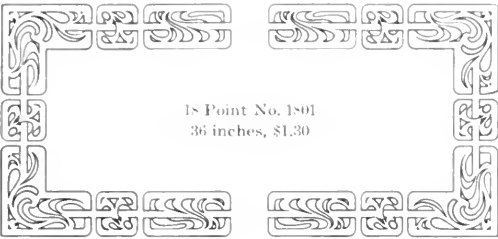

18 Point No. 1801
36 inches, \$1.30



18 Point No. 1806
36 inches, \$1.30

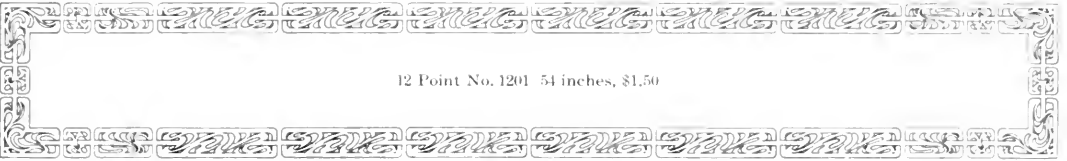

12 Point No. 1201 54 inches, \$1.50

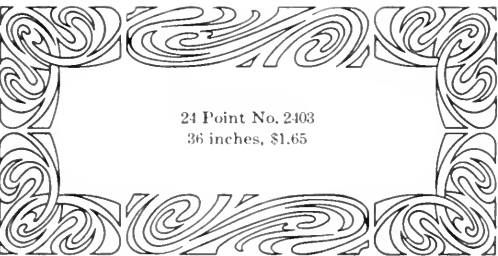

24 Point No. 2403
36 inches, \$1.65



24 Point No. 2402
36 inches, \$1.65

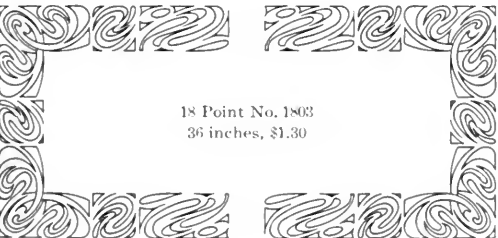

18 Point No. 1803
36 inches, \$1.30

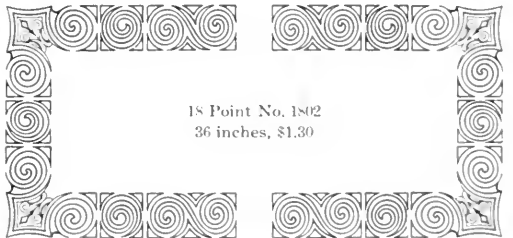

18 Point No. 1802
36 inches, \$1.30



12 Point No. 1203
54 inches, \$1.50



12 Point No. 1202
54 inches, \$1.50

Adtype Borders and Brockton Borders

12 Point No. 1, 54 inches, \$1.50

8 Point No. 1, 54 inches, \$1.35

14 Point No. 1, 42 inches, \$1.50

10 Point No. 2, 54 inches, \$1.40

Characters in Complete Font

18 Point No. 2, 36 inches, \$1.30

ADTYPE BORDERS

Characters in Complete Font

6 Point No. 3, 60 inches, \$1.50

14 Point No. 2, 42 inches, \$1.50

8 Point No. 3, 54 inches, \$1.35

12 Point No. 2, 54 inches, \$1.50

18 Point, 36 inches, \$1.30

12 Point, 54 inches, \$1.50

8 Point, 54 inches, \$1.35

6 Point, 60 inches, \$1.50

BROCKTON BORDERS

Characters in Complete Font

The 8, 10, 12, 14 and 18 point fonts contain characters 1 and 2 only

10 Point, 54 inches, \$1.40

14 Point, 42 inches, \$1.50

Beacon Borders, Klondike Borders and Newspaper Border

THE BEACON

PRODUCES GREAT MATERIALS

BORDER DESIGN

PRINTING

TYPES

BEACON BORDERS
 24 Point, 6A \$2.50
 Font contains Caps, &, and 30 each thick and thin spacing blanks
 Extra blanks, large size, per font of 36 inches, \$1.65

18 Point, 10A \$2.00
 Font contains Caps, &, and 28 thin and 30 thick spacing blanks
 Extra blanks, large size, per font of 36 inches, \$1.30

KLONDIKE BORDERS

18 Point, 36 inches, \$1.30

12 Point, 54 inches, \$1.50

36 Point, 24 inches, \$1.65

1 2 3 4 5

Characters in Complete Font

NEWSPAPER BORDER No. 119

18 Point, 36 inches, \$1.30

Characters in Complete Font

1 3 4 5 2

Navajo Border, Primrose Borders and Monotone Borders

NAVAJO BORDER
Characters in Complete Font

12 Point No. 238, 54 inches, \$1.50

PRIMROSE BORDERS
Characters in Complete Font

18 Point, 36 inches, \$1.30

SIX POINT MONOTONE BORDER No. 1
60 inches \$1.50

Characters in Complete Font

16	12	14	10	15						
9	8	7	11	13	1	2	3	4	5	6

SIX POINT MONOTONE BORDER No. 2
60 inches \$1.50

Characters in Complete Font

16	12	14	10	15						
9	8	7	11	13	1	2	3	4	5	6

For use as tint with No. 1

ORIGINATOR **AMERICAN TYPE FOUNDERS COMPANY** DESIGNER

Tabard Borders

36 Point No. 3607 24 inches \$1.65



30 Point No. 3907 21 inches \$1.35



24 Point No. 2407 36 inches \$1.65



18 Point No. 1807 36 inches \$1.30



12 Point No. 1207 54 inches \$1.50



36 Point No. 3609 24 inches \$1.65



30 Point No. 3009 24 inches \$1.35



24 Point No. 2409 36 inches \$1.65



18 Point No. 1809 36 inches \$1.30



12 Point No. 1209 54 inches \$1.50



36 Point No. 3611 24 inches \$1.65



30 Point No. 3011 24 inches \$1.35



24 Point No. 2411 36 inches \$1.65



18 Point No. 1811 36 inches \$1.30



12 Point No. 1211 54 inches \$1.50



36 Point No. 3608 21 inches \$1.65



30 Point No. 3908 24 inches \$1.35



24 Point No. 2408 36 inches \$1.65



18 Point No. 1808 36 inches \$1.30



12 Point No. 1208 54 inches \$1.50



36 Point No. 3610 24 inches \$1.65



30 Point No. 3010 24 inches \$1.35



24 Point No. 2410 36 inches \$1.65



18 Point No. 1810 36 inches \$1.30



12 Point No. 1210 54 inches \$1.50



36 Point No. 3612 24 inches \$1.65

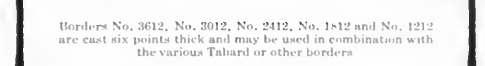

Borders No. 3612, No. 3012, No. 2412, No. 1812 and No. 1212 are cast six points thick and may be used in combination with the various Tabard or other borders.

30 Point No. 3012 24 inches \$1.35



24 Point No. 2412 36 inches \$1.65



18 Point No. 1812 36 inches \$1.30



12 Point No. 1212 54 inches \$1.50



Bewick Borders



Chap-Book Borders

36 Point No. 51D 24 inches \$1.65



30 Point No. 54D 24 inches \$1.35



24 Point No. 54D 36 inches \$1.65



18 Point No. 54D 36 inches \$1.30



12 Point No. 54D 54 inches \$1.50



18 Point No. 10J 36 inches \$1.30



18 Point No. 1J 36 inches \$1.30



18 Point No. 2J 36 inches \$1.30



18 Point No. 3J 36 inches \$1.30



18 Point No. 4J 36 inches \$1.30



18 Point No. 5J 36 inches \$1.30



18 Point No. 6J 36 inches \$1.30



12 Point No. 9J 54 inches \$1.50



12 Point No. 10J 54 inches \$1.50



12 Point No. 6J 54 inches \$1.50



12 Point No. 7J 54 inches \$1.50



36 Point No. 52D 24 inches \$1.65



30 Point No. 52D 24 inches \$1.35



21 Point No. 52D 36 inches \$1.65



18 Point No. 52D 36 inches \$1.30



12 Point No. 52D 54 inches \$1.50



18 Point No. 11J 36 inches \$1.30



18 Point No. 7J 36 inches \$1.30



18 Point No. 8J 36 inches \$1.30



18 Point No. 9J 36 inches \$1.30



18 Point No. 12J 36 inches \$1.30



18 Point No. 13J 36 inches \$1.30



18 Point No. 14J 36 inches \$1.30



12 Point No. 8J 54 inches \$1.50



6 Point No. 1J 60 inches \$1.50



6 Point No. 2J 60 inches \$1.50



6 Point No. 3J 60 inches \$1.50



6 Point No. 4J 60 inches \$1.50



Chaucer Borders

36 Point No. 102 24 inches \$1.65



30 Point No. 102 24 inches \$1.35



24 Point No. 102 36 inches \$1.65



18 Point No. 102 36 inches \$1.30



12 Point No. 102 54 inches \$1.50



36 Point No. 101 24 inches \$1.65



30 Point No. 101 24 inches \$1.35



24 Point No. 101 36 inches \$1.65



18 Point No. 101 36 inches \$1.30



12 Point No. 101 54 inches \$1.50



36 Point No. 106 24 inches \$1.65



30 Point No. 106 24 inches \$1.35



24 Point No. 106 36 inches \$1.65



18 Point No. 106 36 inches \$1.30



12 Point No. 106 54 inches \$1.50



36 Point No. 105 24 inches \$1.65



30 Point No. 105 24 inches \$1.35



24 Point No. 105 36 inches \$1.65



18 Point No. 105 36 inches \$1.30



12 Point No. 105 54 inches \$1.50



36 Point No. 110 24 inches \$1.65



30 Point No. 110 24 inches \$1.35



24 Point No. 110 36 inches \$1.65



18 Point No. 110 36 inches \$1.30



12 Point No. 110 54 inches \$1.50



36 Point No. 103 24 inches \$1.65



30 Point No. 103 24 inches \$1.35



24 Point No. 103 36 inches \$1.65



18 Point No. 103 36 inches \$1.30



12 Point No. 103 54 inches \$1.50



Cheltenham Borders

36 Point No. 3652 24 inches \$1.65



30 Point No. 3052 24 inches \$1.35



24 Point No. 2452 36 inches \$1.65



18 Point No. 1852 36 inches \$1.30



12 Point No. 1252 54 inches \$1.50



36 Point No. 3653 24 inches \$1.65



30 Point No. 3053 24 inches \$1.35



24 Point No. 2453 36 inches \$1.65



18 Point No. 1853 36 inches \$1.30



12 Point No. 1253 54 inches \$1.50



36 Point No. 3651 24 inches \$1.65



30 Point No. 3051 24 inches \$1.35



24 Point No. 2451 36 inches \$1.65



18 Point No. 1851 36 inches \$1.30



12 Point No. 1251 54 inches \$1.50



36 Point No. 3649 24 inches \$1.65



30 Point No. 3049 24 inches \$1.35



24 Point No. 2449 36 inches \$1.65



18 Point No. 1849 36 inches \$1.30



12 Point No. 1249 54 inches \$1.50



36 Point No. 3646 24 inches \$1.65



30 Point No. 3046 24 inches \$1.35



24 Point No. 2446 36 inches \$1.65



18 Point No. 1846 36 inches \$1.30



12 Point No. 1246 54 inches \$1.50



10 Point No. 1046 54 inches \$1.40



8 Point No. 846 54 inches \$1.35



36 Point No. 3650 24 inches \$1.65



30 Point No. 3050 24 inches \$1.35



24 Point No. 2450 36 inches \$1.65



18 Point No. 1850 36 inches \$1.30



12 Point No. 1250 54 inches \$1.50



Cloister Borders



Pabst Borders

36 Point No. 81 24 inches \$1.65



30 Point No. 81 24 inches \$1.35



24 Point No. 81 36 inches \$1.65



18 Point No. 81 36 inches \$1.30



12 Point No. 81 54 inches \$1.50



36 Point No. 94 24 inches \$1.65



30 Point No. 94 24 inches \$1.35



24 Point No. 94 36 inches \$1.65



18 Point No. 94 36 inches \$1.30



12 Point No. 94 54 inches \$1.50



36 Point No. 82 24 inches \$1.65



30 Point No. 82 24 inches \$1.35



24 Point No. 82 36 inches \$1.65



18 Point No. 82 36 inches \$1.30



12 Point No. 82 54 inches \$1.50



36 Point No. 93 24 inches \$1.65



30 Point No. 93 24 inches \$1.35



24 Point No. 93 36 inches \$1.65



18 Point No. 93 36 inches \$1.30



12 Point No. 93 54 inches \$1.50



36 Point No. 91 24 inches \$1.65



30 Point No. 91 24 inches \$1.35



24 Point No. 91 36 inches \$1.65



18 Point No. 91 36 inches \$1.30



12 Point No. 91 54 inches \$1.50



36 Point No. 83 24 inches \$1.65



30 Point No. 83 24 inches \$1.35



24 Point No. 83 36 inches \$1.65



18 Point No. 83 36 inches \$1.30



12 Point No. 83 54 inches \$1.50



Empire Borders and Bridal Borders

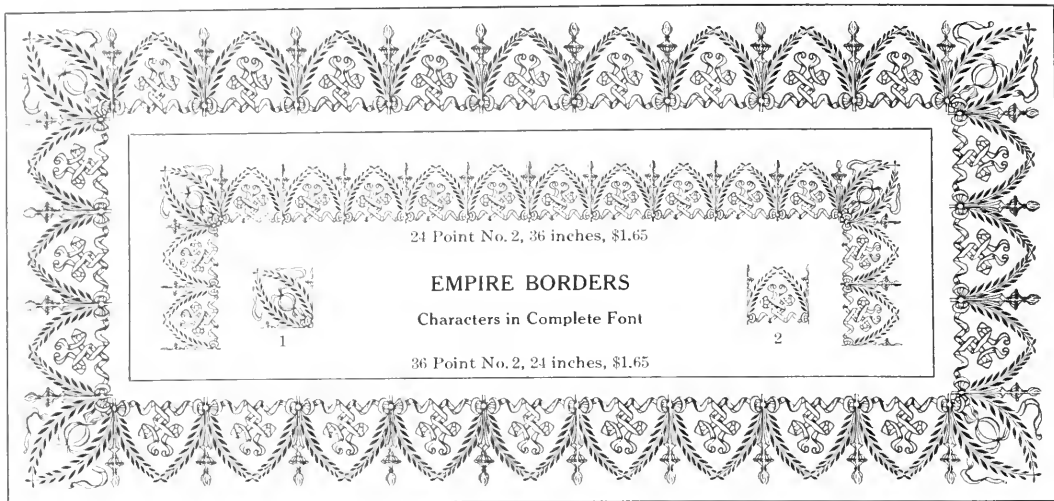

24 Point No. 2, 36 inches, \$1.65

EMPIRE BORDERS
Characters in Complete Font

36 Point No. 2, 24 inches, \$1.65

1 2

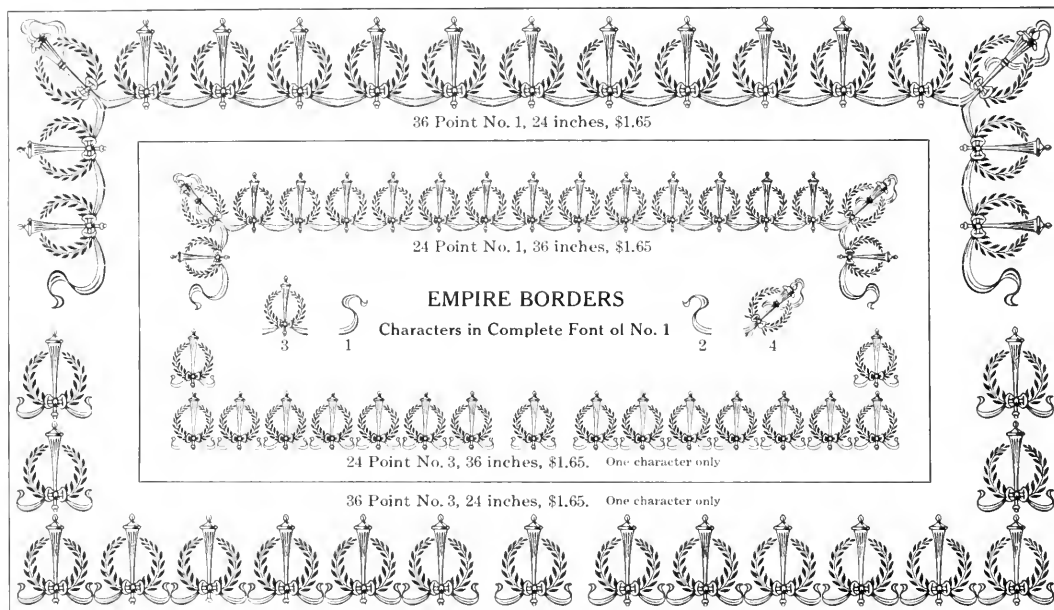

36 Point No. 1, 24 inches, \$1.65

24 Point No. 1, 36 inches, \$1.65

EMPIRE BORDERS
Characters in Complete Font of No. 1

3 1 2 4

24 Point No. 3, 36 inches, \$1.65. One character only

36 Point No. 3, 24 inches, \$1.65. One character only

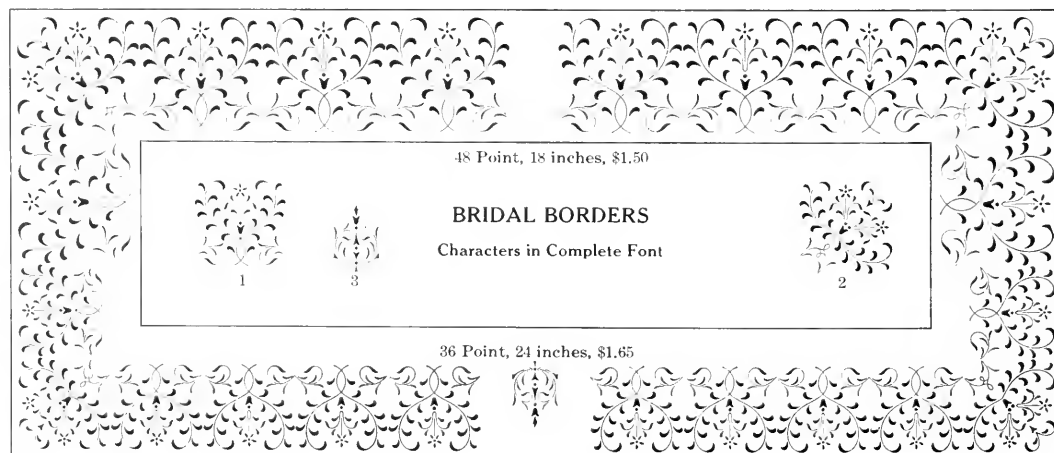

48 Point, 18 inches, \$1.50

BRIDAL BORDERS
Characters in Complete Font

1 2

36 Point, 24 inches, \$1.65

Palm Border, Myrtle Borders and Elite Borders

PALM BORDER
Per Font, 30 inches, \$3.00
Characters in Complete Font

1
 2
 3
 4

Myrtle-
Point
Bodies

18 Point, 36 inches, \$1.30

MYRTLE BORDERS

Characters in Complete Font of 18 Point
 5 4 3 2 1

Characters in Complete Font of 12 Point
 12 11 10 9 8 7 6

Characters in Complete Font of 6 Point
 18 17 16 15 14 13

6 Point, 60 inches, \$1.50

12 Point, 54 inches, \$1.50

48 Point, 18 inches, \$1.50

ELITE BORDERS
Characters in Complete Font

1
 2
 3

36 Point, 24 inches, \$1.65

Flame Borders and Art Borders

24 Point, 36 inches, \$1.65

36 Point, 24 inches, \$1.65

12 Point, 54 inches, \$1.50

18 Point, 36 inches, \$1.30

FLAME BORDERS

Characters in Complete Font



6 Point, 60 inches, \$1.50

18 Point No. 1, 36 inches, \$1.30

ART BORDERS

Characters in Complete Font



18 Point font contains 18 of character 1; 26 each 2 and 3; 6 each 4 and 5
36 Point font contains 8 of character 1, 13 each 2 and 3; 2 each 4 and 5



18 Point No. 2, 36 inches, \$1.30

Bottom panel shows 36 Point No. 1 and 36 Point No. 2 printed in color

Unit Borders and Firecracker Borders

UNIT BORDERS



36 Point, 24 inches, \$1.65



30 Point, 24 inches, \$1.35



24 Point, 36 inches, \$1.65



18 Point, 36 inches, \$1.30



12 Point, 54 inches, \$1.50

12 Point No. 120023, 54 inches, \$1.50

36 Point No. 360023, 24 inches, \$1.65

18 Point No. 180023, 36 inches, \$1.30

FIRECRACKER BORDERS

Characters in Complete Font



24 Point No. 240023, 36 inches, \$1.65

Della Robbia Borders

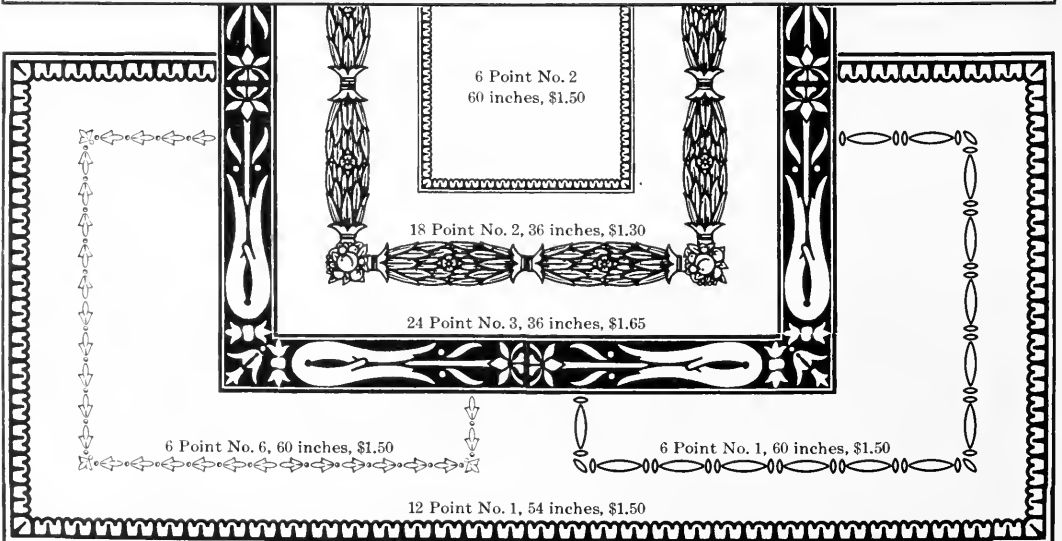
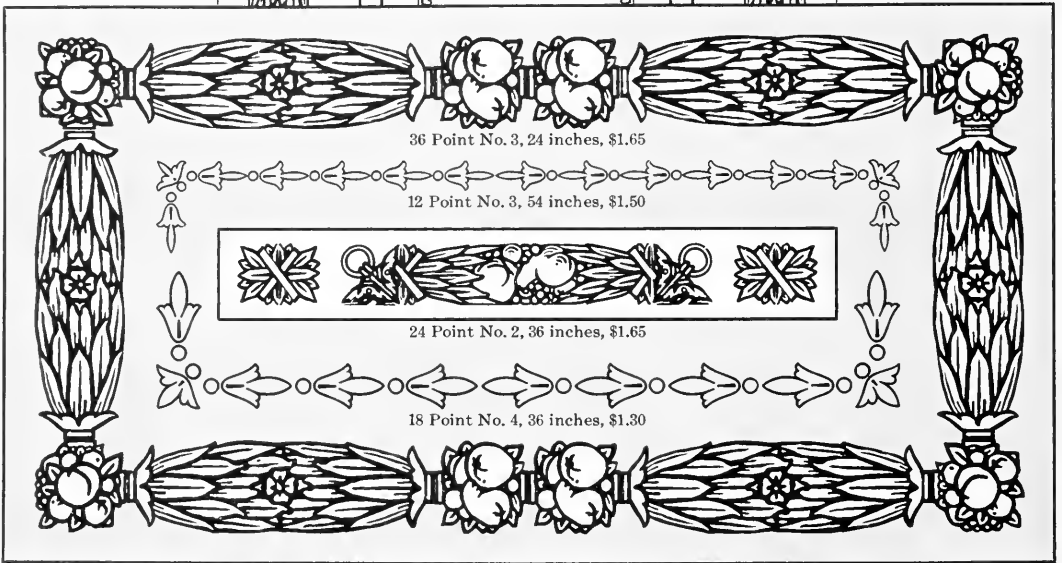
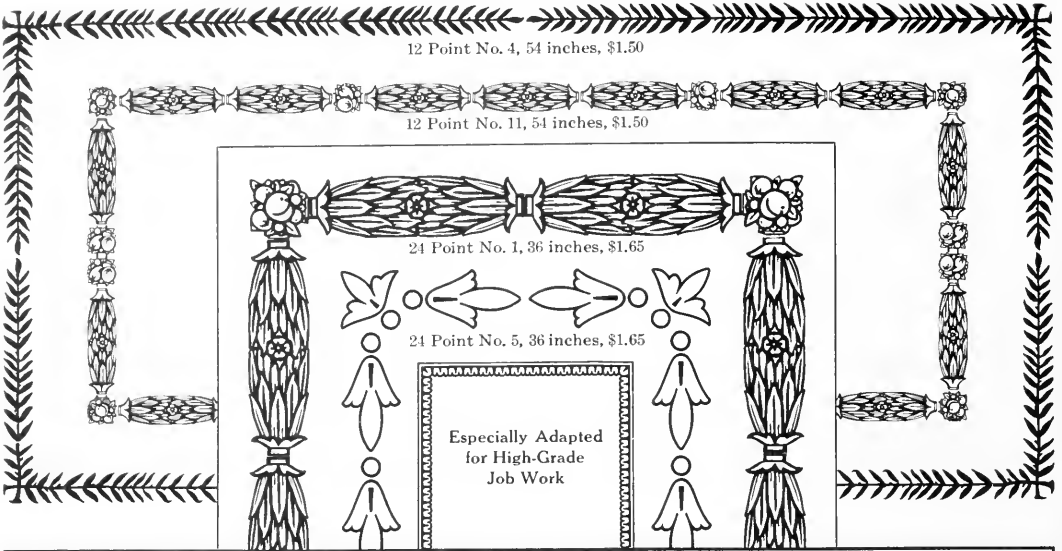

Knickerbocker Borders

12 Point

51 inches \$1.50



18 Point

36 inches \$1.30



24 Point

36 inches \$1.65



30 Point

21 inches \$1.35



36 Point

24 inches \$1.65



48 Point

18 inches \$1.50



60 Point

12 inches \$1.25



72 Point

12 inches \$1.35



96 Point

12 inches \$1.80

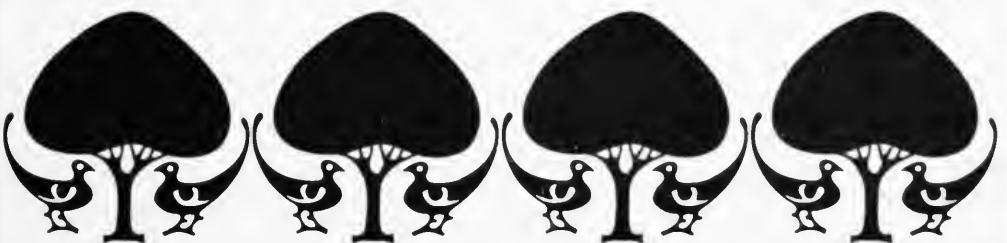

Bulfinch Borders

18 Point

18 inches \$1.50



42 Point

18 inches \$1.35

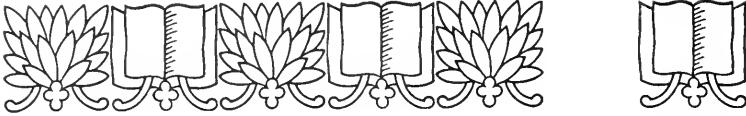

36 Point

24 inches \$1.65



30 Point

24 inches \$1.35



24 Point

36 inches \$1.65



18 Point

36 inches \$1.30



14 Point

42 inches \$1.50



12 Point

54 inches \$1.50



10 Point

54 inches \$1.40



Two characters, each a border in itself

Swastika Borders and Swastika Outline Borders

72 Point No. 720005

Font of 12 inches \$1.35

72 Point No. 720006

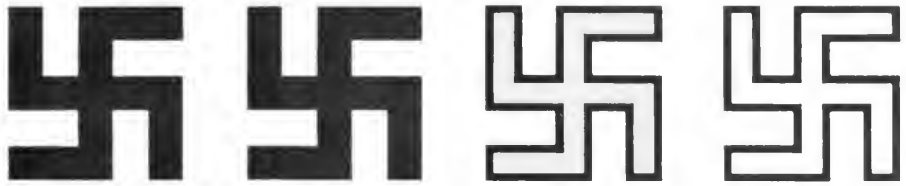

60 Point No. 600005

Font of 12 inches \$1.25

60 Point No. 600006



48 Point No. 480005

Font of 18 inches \$1.50

48 Point No. 480006



36 Point No. 360005

Font of 24 inches \$1.65

36 Point No. 360006



30 Point No. 300005

Font of 21 inches \$1.35

30 Point No. 300006



24 Point No. 240005

Font of 36 inches \$1.65

24 Point No. 240006



18 Point No. 180005

Font of 36 inches \$1.30

18 Point No. 180006



12 Point No. 120005

Font of 54 inches \$1.50

12 Point No. 120006



10 Point No. 100005

Font of 54 inches \$1.40

10 Point No. 100006



8 Point No. 80005

Font of 54 inches \$1.35

8 Point No. 80006



6 Point No. 60005

Font of 60 inches \$1.50

6 Point No. 60006



Swastika and Swastika Outline put up in separate fonts

Century Borders

Century Borders

UNIQUE IN DESIGN



*Many Pleasing Effects Easily
Produced*

Originated and Made by

American Type Founders
Company

Century Borders

12 POINT CENTURY BORDER No. 3

Characters in Complete Font

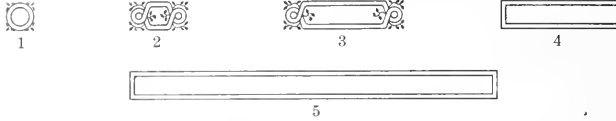

Per Font, 54 inches, \$1.50

18 POINT CENTURY BORDER No. 1

Characters in Complete Font

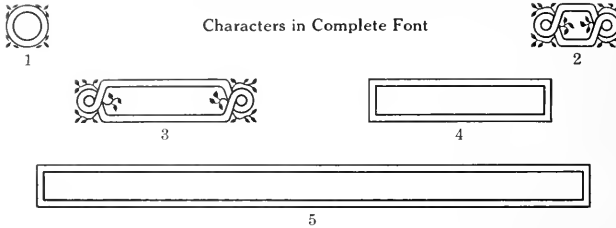

Per Font, 36 inches, \$1.30

12 POINT CENTURY BORDER No. 6

Characters in Complete Font

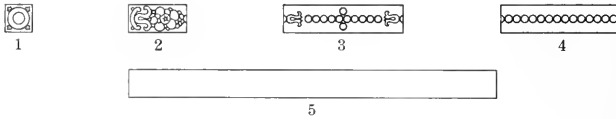

Per Font, 54 inches, \$1.50

18 POINT CENTURY BORDER No. 4

Characters in Complete Font

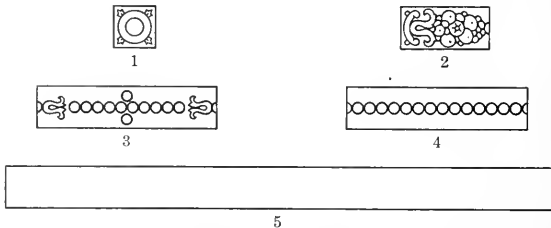

Per Font, 36 inches, \$1.30

Century Borders

12 POINT CENTURY BORDER No. 4

Characters in Complete Font



Per Font, 54 inches, \$1.50

18 POINT CENTURY BORDER No. 2

Characters in Complete Font

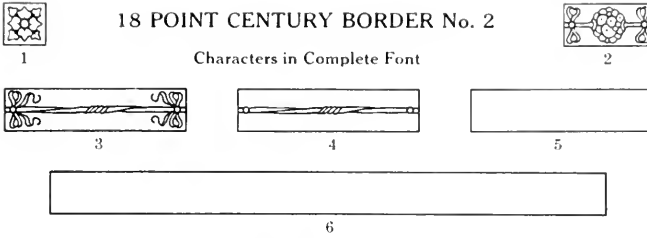

Per Font, 36 inches, \$1.30

12 POINT CENTURY BORDER No. 5

Characters in Complete Font

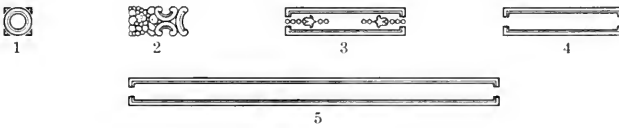

Per Font, 54 inches, \$1.50

18 POINT CENTURY BORDER No. 3

Characters in Complete Font

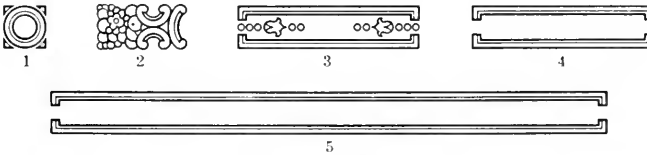

Per Font, 36 inches, \$1.30

Century Borders

12 POINT CENTURY BORDER No. 1

Characters in Complete Font

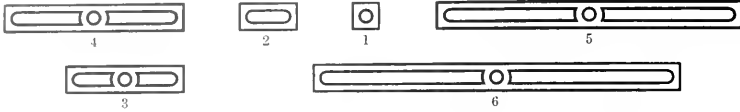

Price per Font, 54 inches, \$1.50

12 POINT CENTURY BORDER No. 11

Designed for use as tint with Century Border No. 1



Price per Font, 54 inches, \$1.50

12 POINT CENTURY BORDER No. 2

Characters in Complete Font

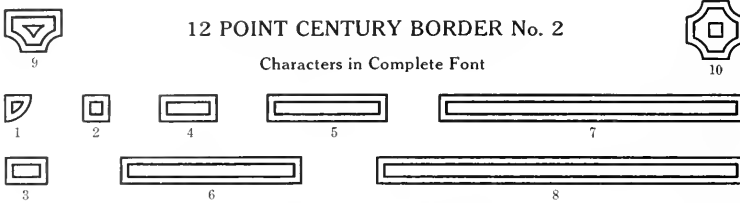

Price per Font, 54 inches, \$1.50

12 POINT CENTURY BORDER No. 12

Designed for use as tint with Century Border No. 2

Characters in Complete Font

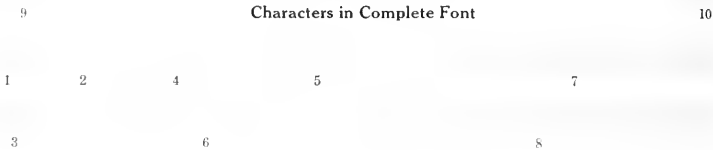

Price per Font, 54 inches, \$1.50

THESE BORDERS ARE DESIGNED FOR ONE OR TWO COLORS

Borders for Holiday Printing

12 Point No. 1, 54 inches, \$1.50

36 Point No. 7, 24 inches, \$1.65 36 Point No. 8, Color for No. 7, 24 inches, \$1.65

18 Point No. 3, 36 inches, \$1.30
 18 Point No. 4, Color for No. 3, 36 inches, \$1.30

HOLIDAY BORDERS
 Characters in Complete Font

2 3
 1 4 5

24 Point No. 5, 36 inches, \$1.65 24 Point No. 6, Color for No. 5, 36 inches, \$1.65

Characters in all the four sizes of these borders are the same in design

The 36, 24 and 18 Point sizes of Holiday Borders are made for two colors, as shown in the 24 Point size only

12 Point No. 9, 54 inches, \$1.50

36 Point No. 15, 24 inches, \$1.65

18 Point No. 11, 36 inches, \$1.30

HOLIDAY BORDERS
 Characters in Complete Font

1 2
 4 6 5 3

24 Point No. 13, 36 inches, \$1.65

Characters in all the four sizes of these borders are the same in design

Made for one color only

Borders for Holiday Printing

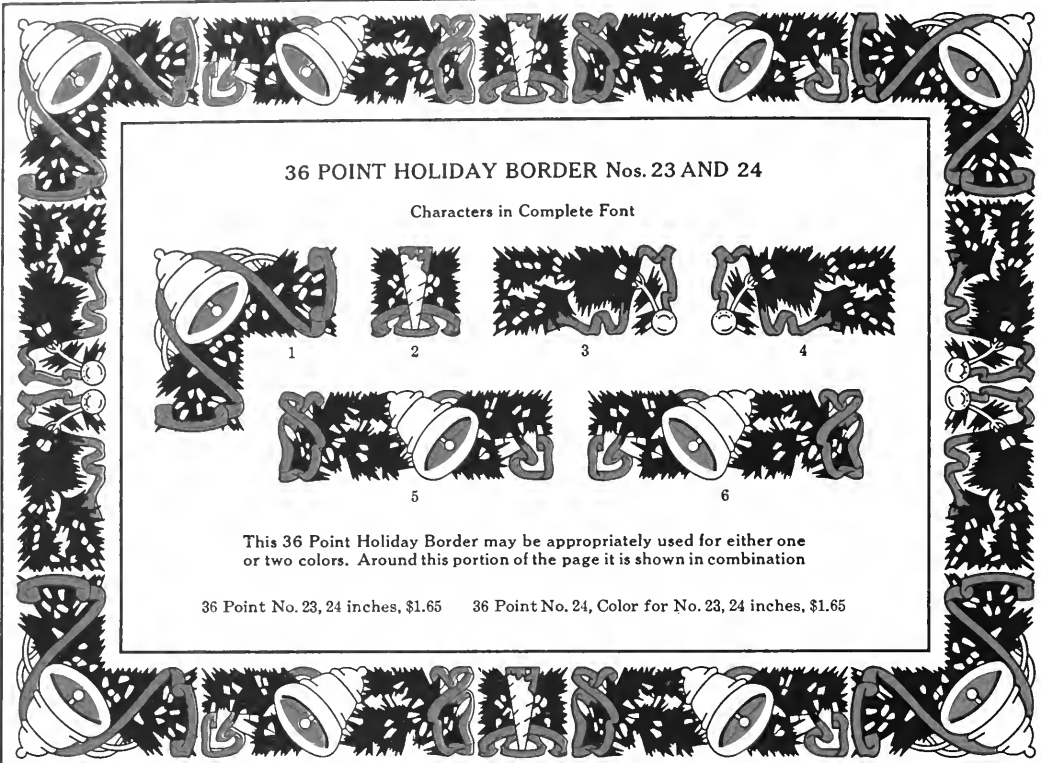

36 POINT HOLIDAY BORDER Nos. 23 AND 24

Characters in Complete Font



1



2



3



4



5



6

This 36 Point Holiday Border may be appropriately used for either one or two colors. Around this portion of the page it is shown in combination

36 Point No. 23, 24 inches, \$1.65 36 Point No. 24, Color for No. 23, 24 inches, \$1.65



12 Point No. 120026, 54 inches, \$1.50

INLAND HOLLY BORDERS

Characters in Complete Font



1



2



3

18 Point No. 180026, 36 inches, \$1.30

24 Point No. 240026, 36 inches, \$1.65

Borders for Holiday Printing

Combination of No. 480007 and No. 480009

48 Point Holly Border, No. 480007 18 inches \$1.50

48 Point Holly Border No. 480008 (Green) 18 inches \$1.50

48 Point Holly Border No. 480009 (Red Berries only) 18 inches \$1.50

Combination of No. 480007, No. 480008 and No. 480009

HOLLY BORDER No. 1 Per Font \$1.65 (For one color only)

HOLLY BORDER Nos. 2 and 3 No. 3 Per Font \$1.65 No. 2 Color Per Font \$1.65

Each Font contains 24 inches

The Border used around the lower half of this page is Holly Border Nos. 2 and 3; the No. 2 constitutes the red dots (or berries) only

Indian Borders

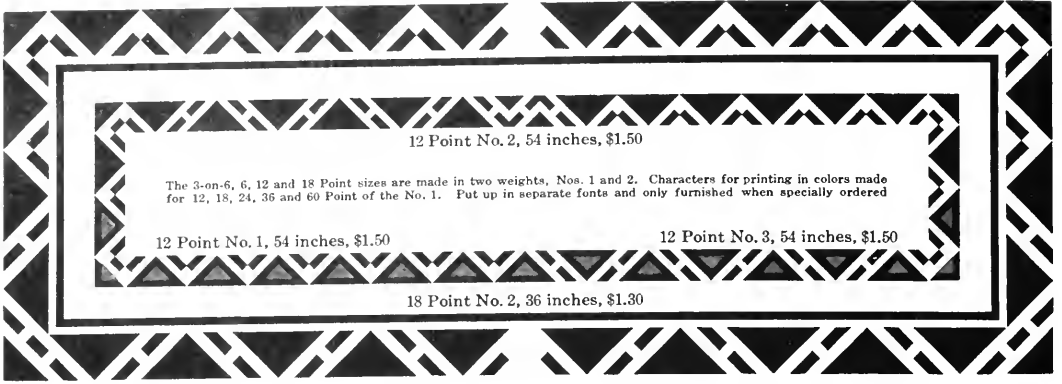

60 Point No. 1, 12 inches, \$1.25

60 Point No. 3, 12 inches, \$1.25



18 Point No. 1, 36 inches, \$1.30

18 Point No. 3, 36 inches, \$1.30



Inland Borders



The borders on this page may be worked together in colors as shown below

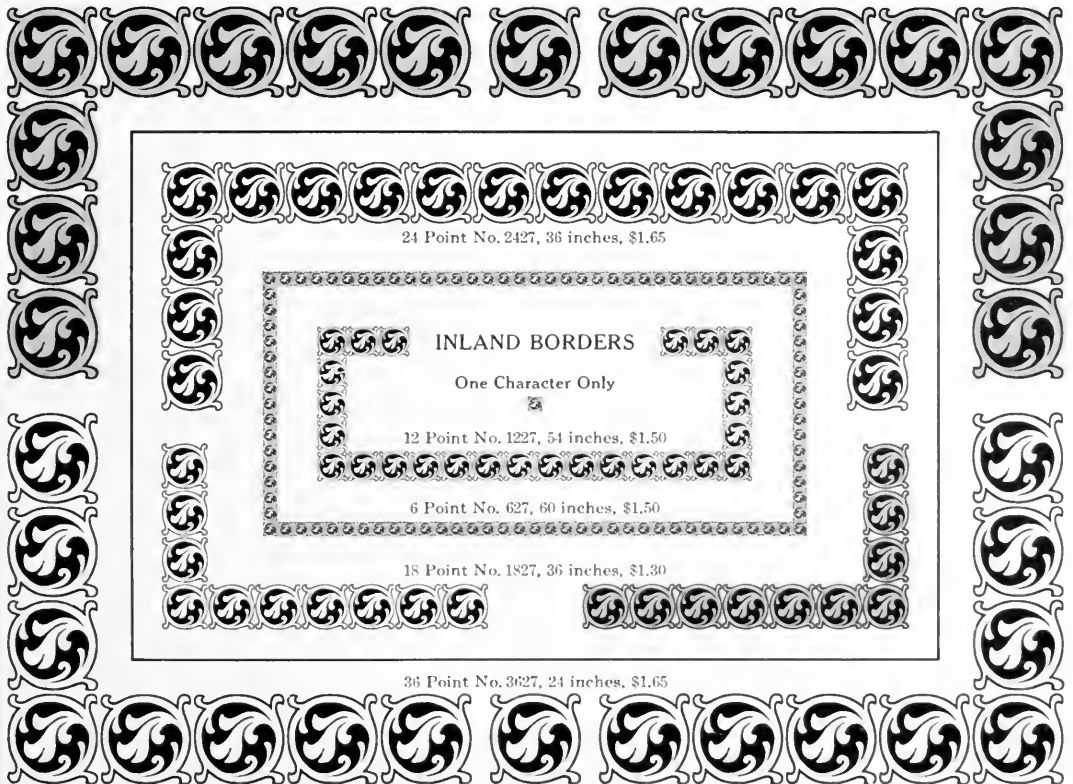

Inland Borders

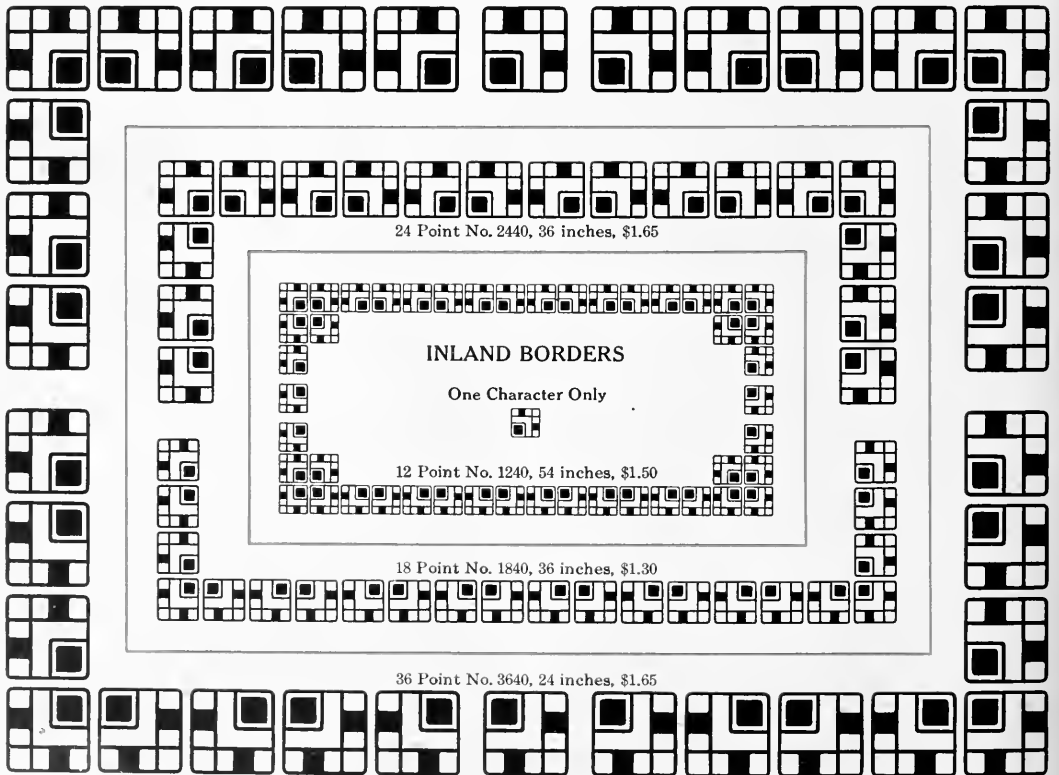
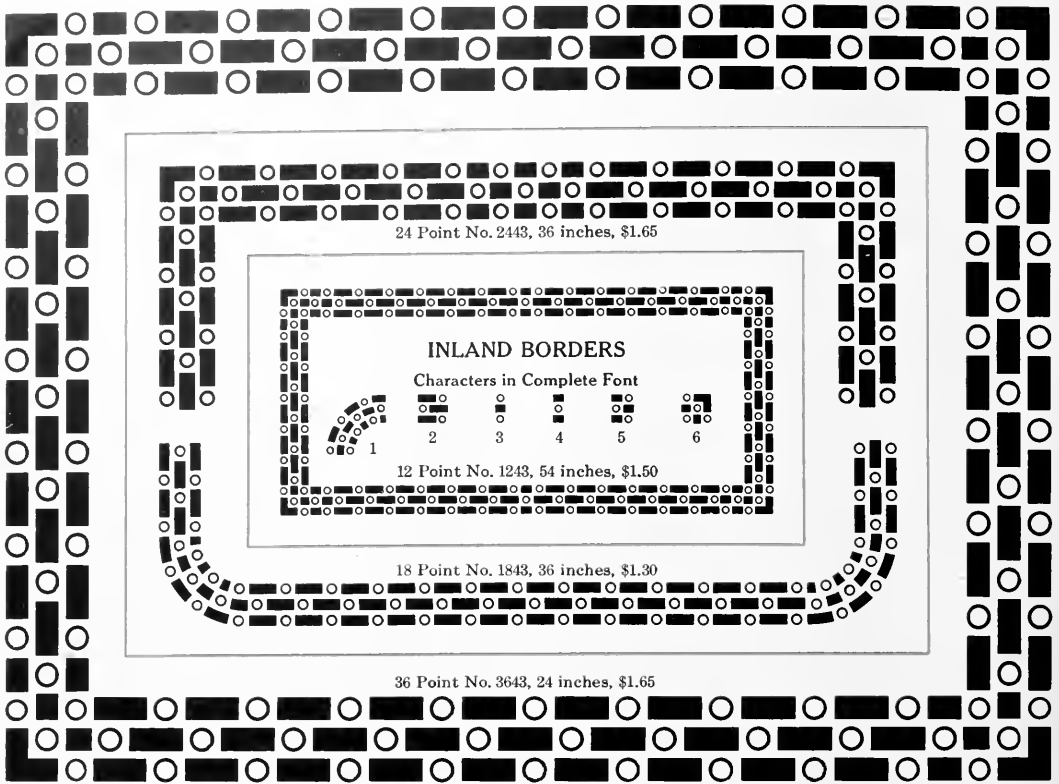

Inland Borders



Inland Borders

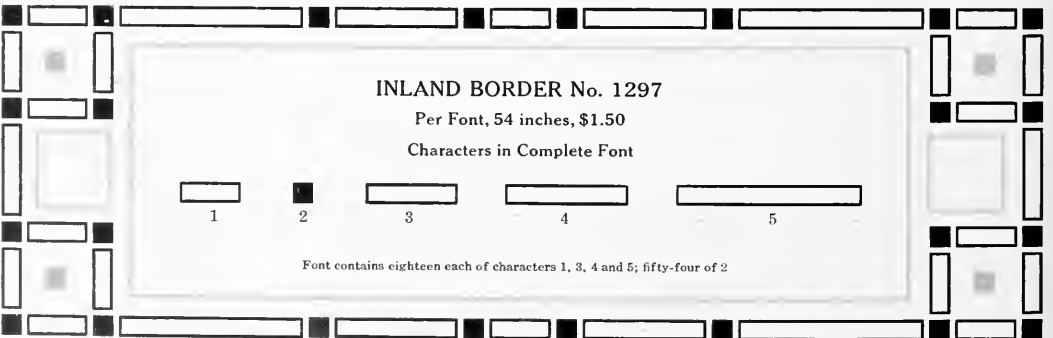
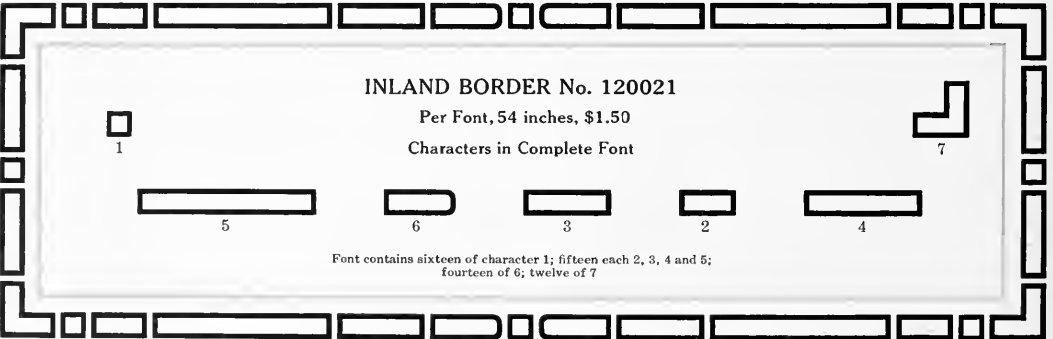
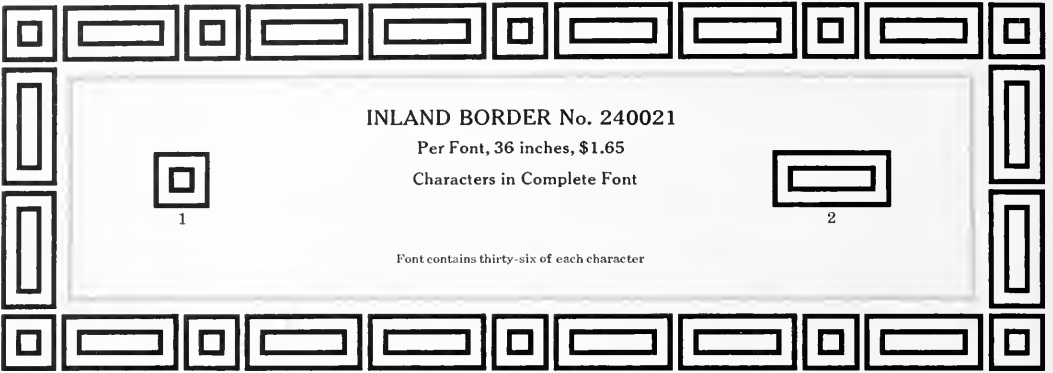
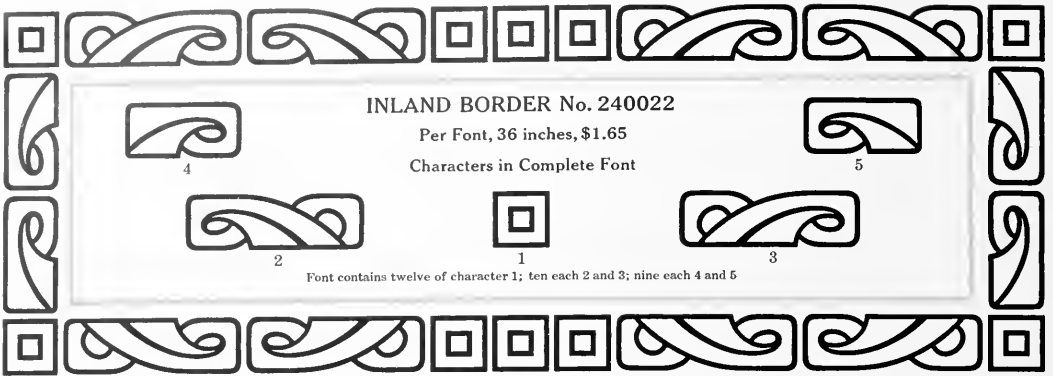

Inland Borders

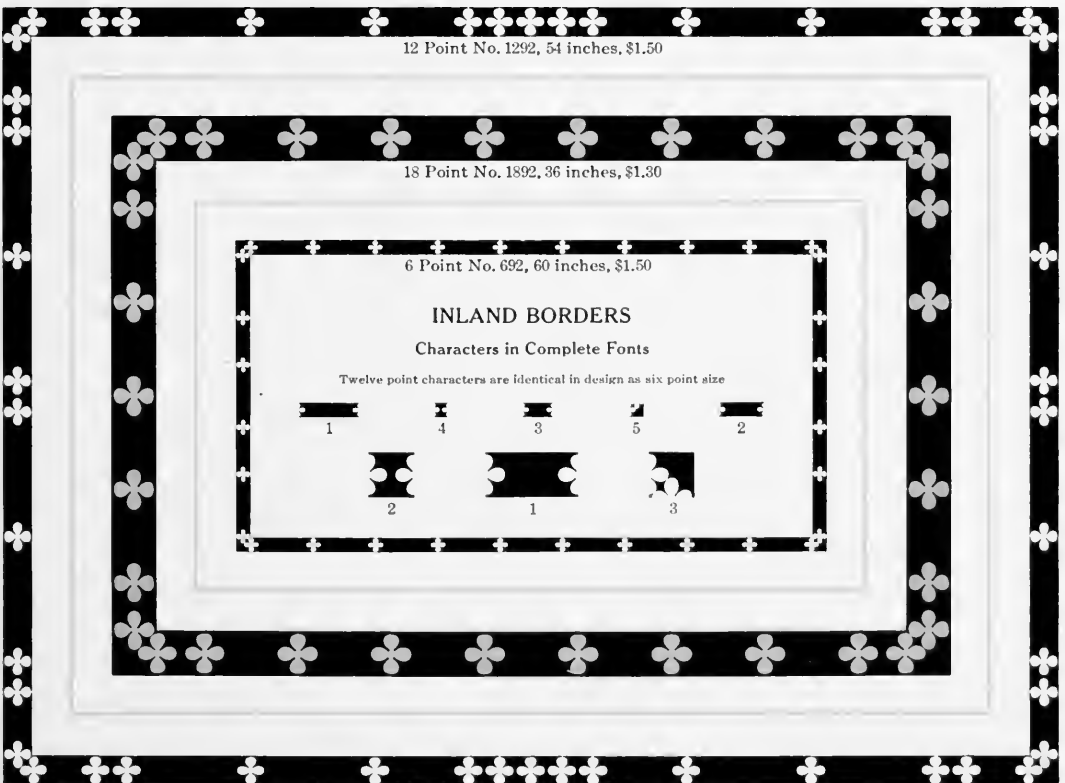
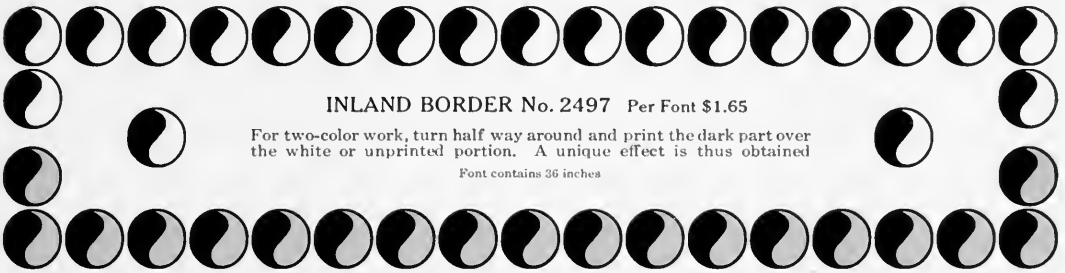

Inland Borders

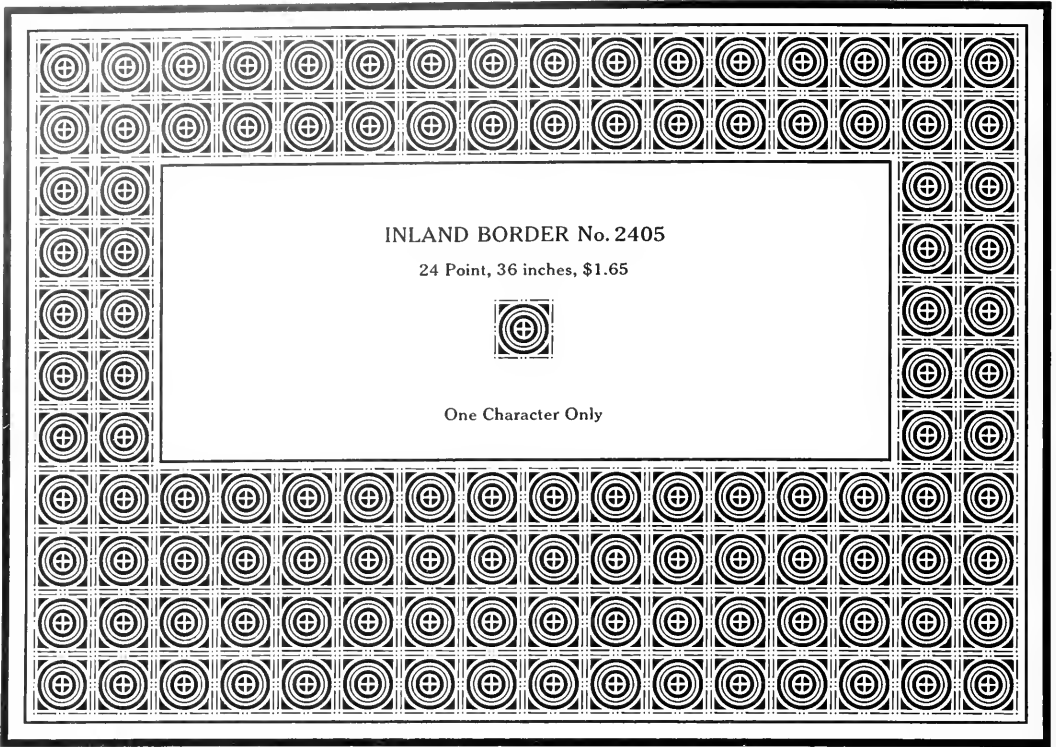



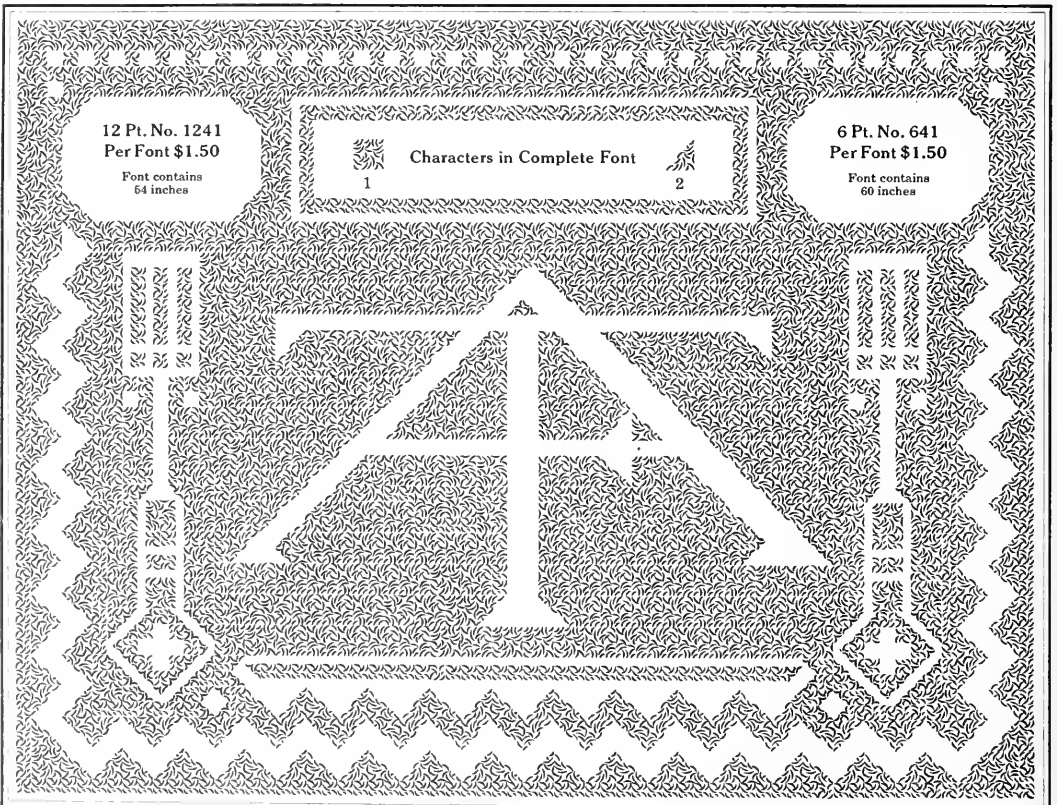

INLAND BORDERS Series No. 41

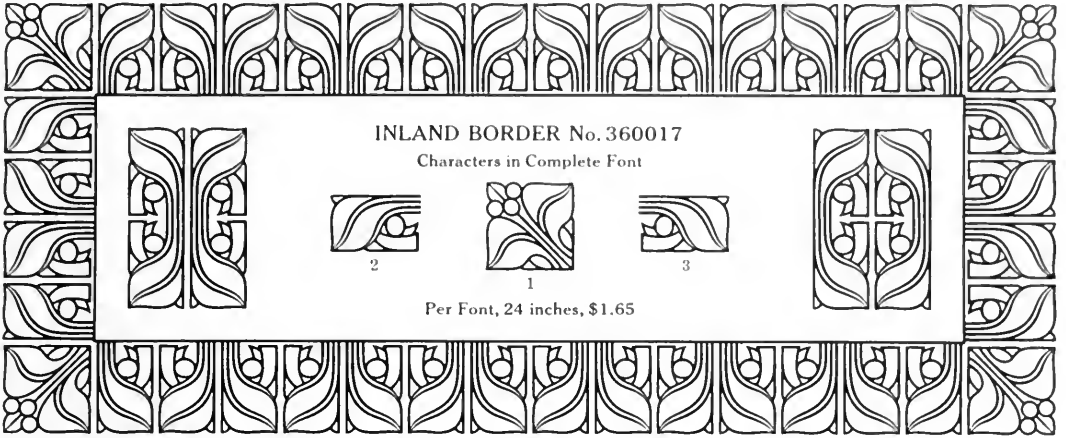





Inland Borders

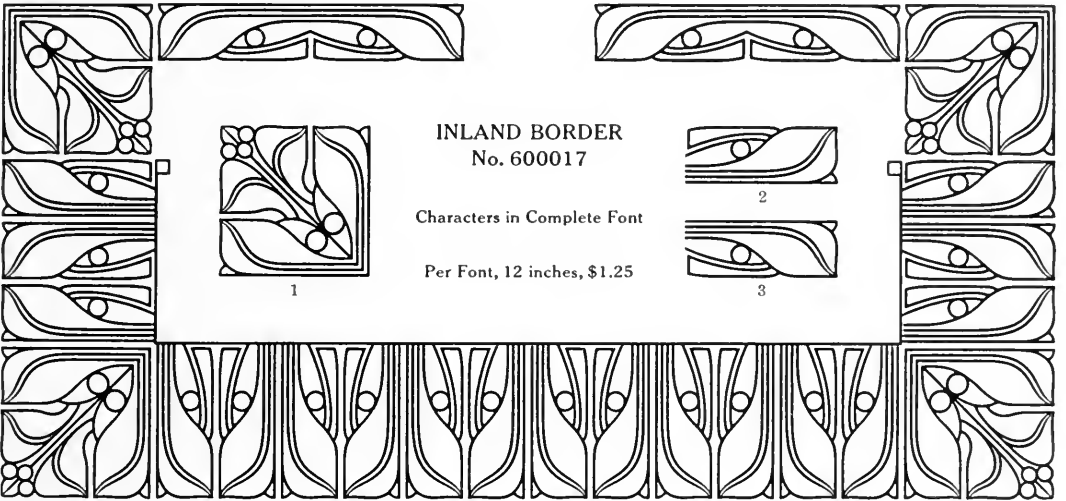

INLAND BORDER No. 360017
 Characters in Complete Font







2 1 3
 Per Font, 24 inches, \$1.65

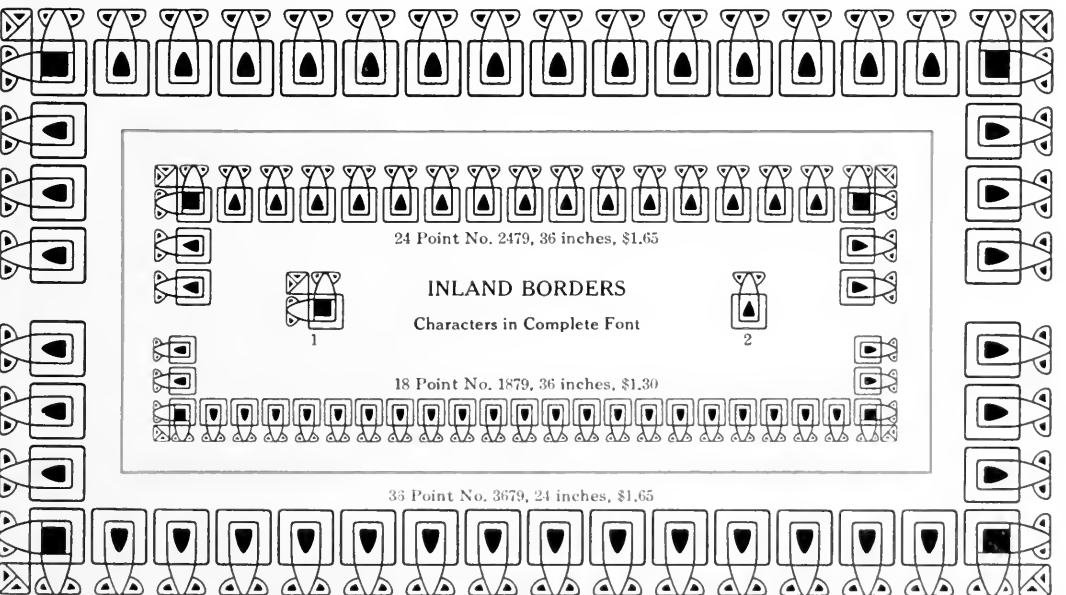

INLAND BORDER No. 600017
 Characters in Complete Font



1 2 3
 Per Font, 12 inches, \$1.25



INLAND BORDERS
 Characters in Complete Font

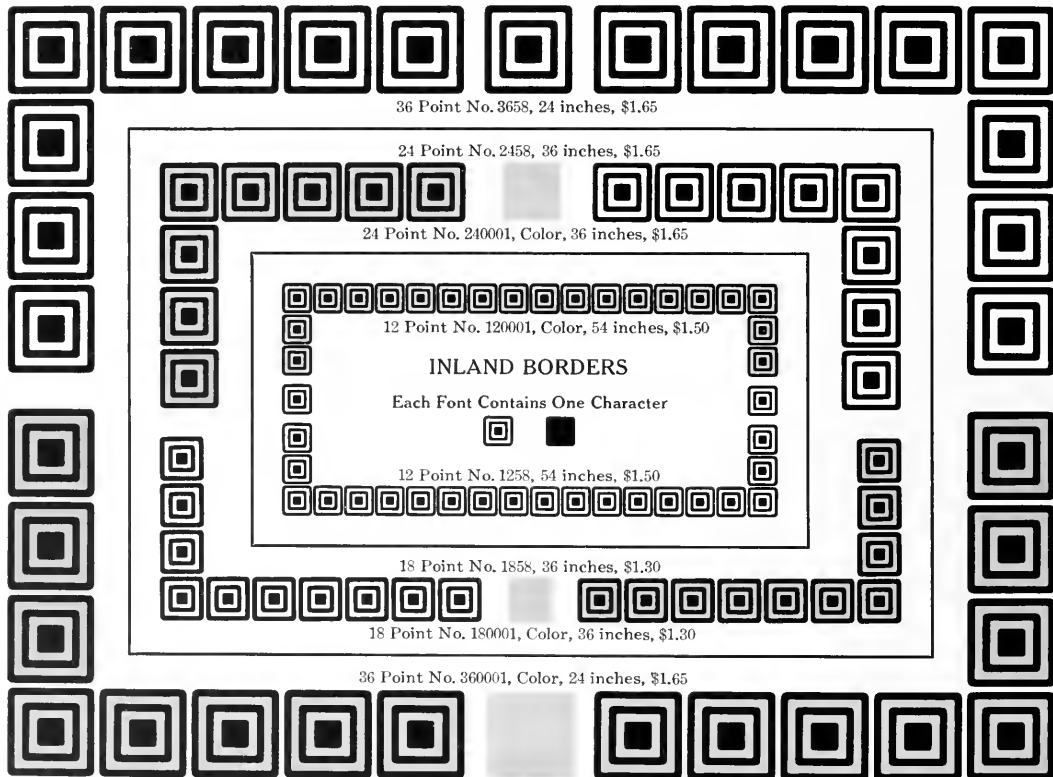
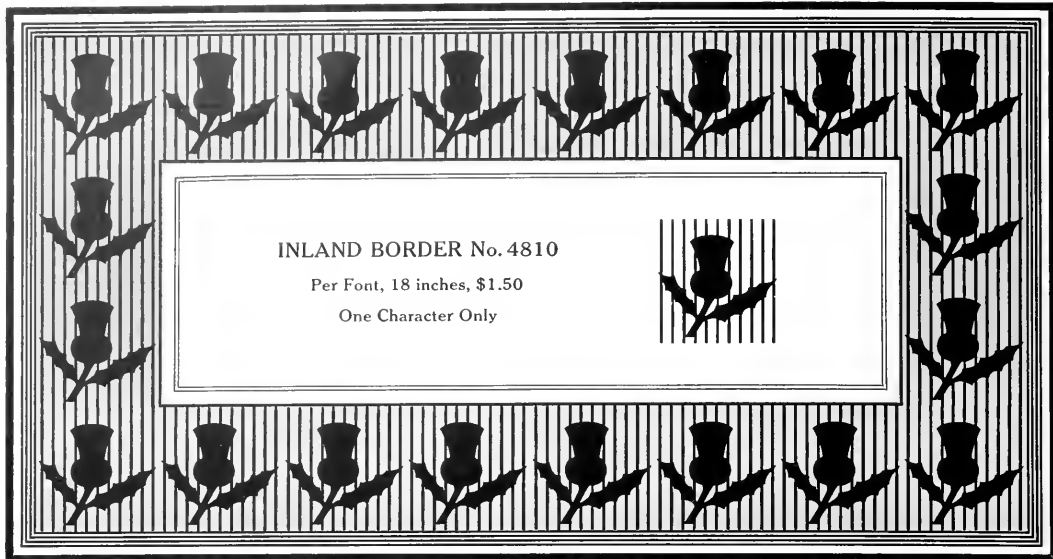

1 2
 24 Point No. 2479, 36 inches, \$1.65
 18 Point No. 1879, 36 inches, \$1.30
 36 Point No. 3679, 24 inches, \$1.65

Inland Borders

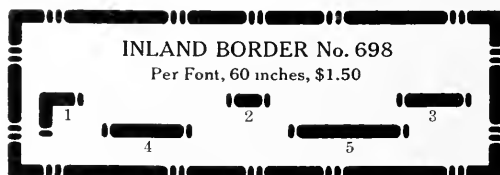
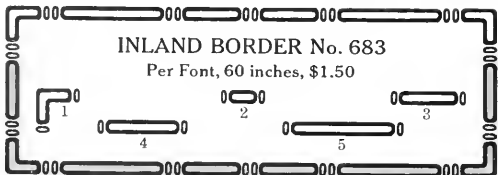

Borders No. 683 and No. 698 register properly for two-color work



Flemish Borders



36 Point No. 13, 24 inches, \$1.65

18 Point No. 5, 36 inches, \$1.30



36 Point No. 11, 24 inches, \$1.65

18 Point No. 5 (for two colors)
27 inches, \$2.00

36 Point No. 13 (for two colors), 18 inches, \$2.50



36 Point No. 14, 24 inches, \$1.65

18 Point No. 4, 36 inches, \$1.30



36 Point No. 11 (for two colors)
18 inches, \$2.50

18 Point No. 4 (for two colors)
27 inches, \$2.00

36 Point No. 14 (for two colors), 18 inches, \$2.50

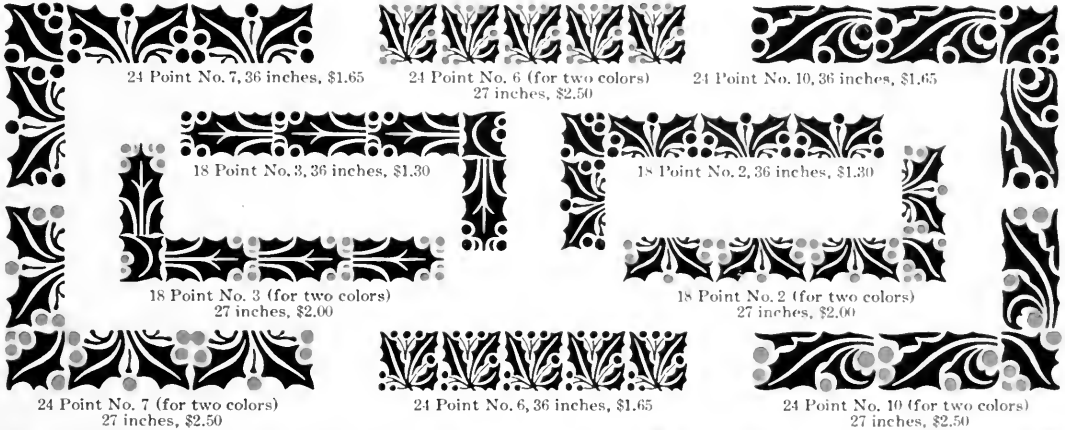

24 Point No. 7, 36 inches, \$1.65

24 Point No. 6 (for two colors)
27 inches, \$2.50

24 Point No. 10, 36 inches, \$1.65

18 Point No. 3, 36 inches, \$1.30

18 Point No. 2, 36 inches, \$1.30

18 Point No. 3 (for two colors)
27 inches, \$2.00

18 Point No. 2 (for two colors)
27 inches, \$2.00

24 Point No. 7 (for two colors)
27 inches, \$2.50

24 Point No. 6, 36 inches, \$1.65

24 Point No. 10 (for two colors)
27 inches, \$2.50



36 Point No. 12, 24 inches, \$1.65

18 Point No. 1 (for two colors), 27 inches, \$2.00

24 Point No. 9, 36 inches, \$1.65

24 Point No. 9 (for two colors)
27 inches, \$2.50

36 Point No. 12 (for two colors), 18 inches, \$2.50



36 Point No. 15, 24 inches, \$1.65

18 Point No. 1, 36 inches, \$1.30

24 Point No. 8, 36 inches, \$1.65

24 Point No. 8 (for two colors)
27 inches, \$2.50

36 Point No. 15 (for two colors), 18 inches, \$2.50

Gray Borders No. 1 and No. 2

GRAY BORDER No. 1 Characters in Complete Font



9



8

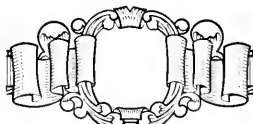

10

Font contains sixteen of character 1; eight each 2, 3, 5, 6, 7 and 8;
twenty-six of 4; two each 9 and 10



4



1



5



7



6



3



2

Per Font \$3.50

AMERICAN TYPE FOUNDERS COMPANY

GRAY BORDER No. 2 Characters in Complete Font



9



8

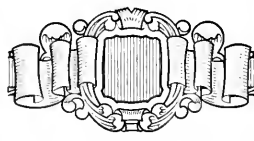

10

Font contains sixteen of character 1; eight each 2, 3, 5, 6, 7 and 8;
twenty-six of 4; two each 9 and 10



1



4



5



7



6



3







2

Per Font \$3.50

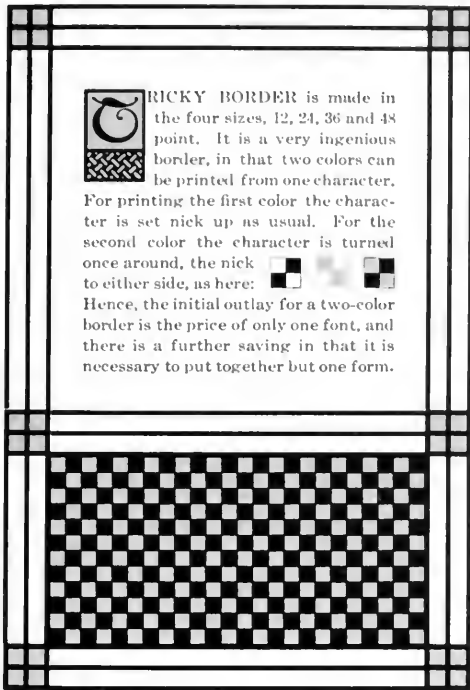
AMERICAN TYPE FOUNDERS COMPANY

Tricky Borders and Quadruple Cast Squares



TRICKY BORDER is made in the four sizes, 12, 24, 36 and 48 point. It is a very ingenious border, in that two colors can be printed from one character. For printing the first color the character is set nick up as usual. For the second color the character is turned once around, the nick  to either side, as here:   Hence, the initial outlay for a two-color border is the price of only one font, and there is a further saving in that it is necessary to put together but one form.

TRICKY BORDERS

12 Point No. 1, 54 inches, \$1.50



24 Point No. 2, 36 inches, \$1.65

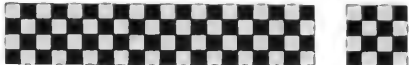

36 Point No. 3, 24 inches, \$1.65

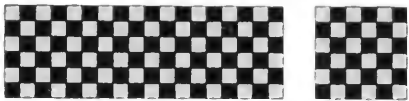

48 Point No. 4, 18 inches, \$1.50

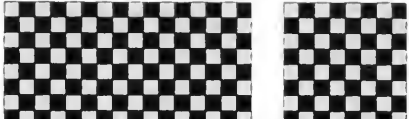























QUADRUPLE CAST SQUARES

MADE in eight sizes: 6, 8, 10, 12, 18, 24, 30, and 36 point, for printing in one or two colors. The brass rule faces with which they are to be used are indicated by the numbers. 24 point No. 1, the lines being 1 point, should be used with 1 point flush with body face rule; No. 2, the lines being 2 point, should be used with a 2 point flush with body face rule; No. 3 with 3 point, and so on. A labor-saving font each of 1, 2, 3, 4 and 6 point will provide brass rule for the complete series. These Quadruple Cast Squares, with a proper supply of our superior, accurately-cut rule, is an equipment that will cost but little, and can be used—a great deal!

PRICES					Set consists of four type
6 Pt. Font contains 30 sets	50c				
8 Pt. Font contains 20 sets	50c				
10 Pt. Fonts contain 16 sets	50c				
12 Pt. Fonts contain 12 sets	50c				
18 Pt. Fonts contain 8 sets	50c				
24 Pt. Fonts contain 5 sets	50c				
30 Pt. Fonts contain 5 sets	75c				
36 Pt. Fonts contain 4 sets	80c				

Color characters in same quantities for the same sizes same prices as the above.

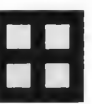
6 Pt. No. 1					
8 Pt. No. 1					
10 Pt. No. 1		10 Pt. No. 2			
12 Pt. No. 1		12 Pt. No. 2			
18 Pt. No. 1		18 Pt. No. 2		18 Pt. No. 3	
24 Pt. No. 1		24 Pt. No. 2		24 Pt. No. 3	
		24 Pt. No. 4		24 Color	
30 Pt. No. 1		30 Pt. No. 2		30 Pt. No. 3	
		30 Pt. No. 4		30 Pt. No. 6	
36 Pt. No. 1		36 Pt. No. 2		36 Pt. No. 3	
		36 Pt. No. 4		36 Pt. No. 6	

Artistic Rose Borders

ROSE BORDER—Section No. 2 Per Font \$4.75
Characters in Complete Font

600007 600008 600009 600010

480019 600013 600014 480018

840001 600016 600015 840002

540001 600012 300007 600011 480020

Font contains twenty-six of character 300007 and two each of the other characters

ROSE BORDER—Section No. 1
Per Font \$1.65

60008 Font contains sixty-six of character 60008; forty-eight of 60007; twenty-four of 120007 60007 120007

The tint shown on this page was routed on a Miller Saw Trimmer

36 POINT ROSE BORDER No. 360021
Per Font \$1.65
Characters in Complete Font

600012 360021 600011

Font contains two each of characters 600011 and 600012; thirty-four of 360021

Art Nouveau Border, Victory Border and Galt Border

ART NOUVEAU BORDER Per Font \$4.50

Characters in Complete Font

Font contains one each of characters 19, 20, 21 and 22; two each 11, 12, 13, 14, 15, 16, 17 and 18, four each 6, 7, 8, 9, 10 and 23; twelve each 1, 2, 3 and 5; twenty-four of 4 (24 inches). (Practically 48 inches of straight pieces.)

VICTORY BORDER Per Font \$2.75

Characters in Complete Font

Font contains four each of characters 1, 2, 5, 6, 7, 8 and 9; eight of 3; twenty-four of 4 (24 inches). Nos. 8 and 9 are cored

GALT BORDER Per Font, 36 inches, \$1.30

Characters in Complete Font

Acme Borders and Dixon Borders

ACME BORDER Section A Per Font \$2.40 Characters in Complete Font

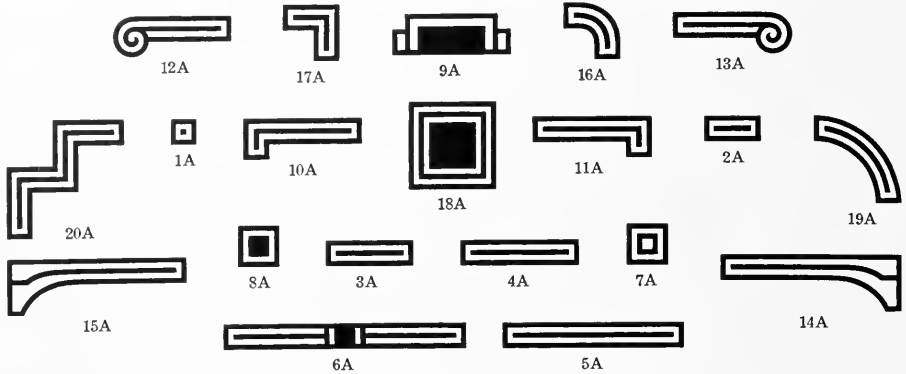

Font contains two each of characters 9A, 10A, 11A, 12A, 13A, 14A, 15A and 18A; four each 6A, 7A, 8A, 16A, 17A, 19A and 20A; ten of 1A; fourteen each 3A, 4A and 5A; fifteen of 2A

ACME BORDER Section B Per Font \$2.00 Characters in Complete Font

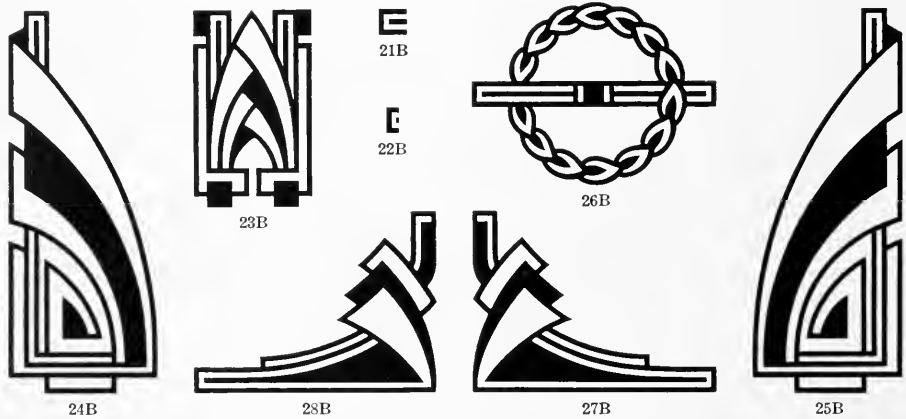

Font contains one each of characters 24B, 25B, 27B and 28B; two each 23B and 26B; forty-two each 21B and 22B

DIXON BORDER No. 1 Per Font, 36 inches, \$1.30

DIXON BORDER No. 2 Per Font, 54 inches, \$1.40

One Character Only

Acme Borders, Bruce Embellishers and Manila Border

ACME BORDER Section C Per Font \$2.50

14C 13C 12C 11C

5C 6C 7C 8C 9C 10C

18C 17C 20C 19C 24C 23C 22C 21C 1C 2C 3C 4C

16C 15C

Font contains four each of characters 11C, 12C, 13C, 14C, 15C, 16C, 20C, 22C, 23C and 24C; six of 8C; eight each 17C, 18C, 19C and 21C; twelve of 1C; sixteen each 2C, 3C, 4C, 6C, 7C, 9C and 10C; twenty of 4C;

ACME BORDER Section D Per Font \$2.00

26D 25D

30D 31D 32D 29D 28D 27D

Font contains forty-eight each of characters 25D and 26D; six of 27D; four each 30D, 31D and 32D; three each 28D and 29D

BRUCE EMBELLISHERS Per Font \$1.50

Font contains four each of characters 1 and 4; twelve of 2; forty-four of 3; six each 5 and 6; one each 7 and 10; eight of 8; eighteen of 9

6 5 8 9

4 1 2 3 10 7

MANILA BORDER Characters in Complete Font

25 35 33 36 13

37 34

Per Font, 30 inches, \$2.00

Magazine Borders and Times Borders

12 POINT MAGAZINE BORDER

Characters in Complete Font

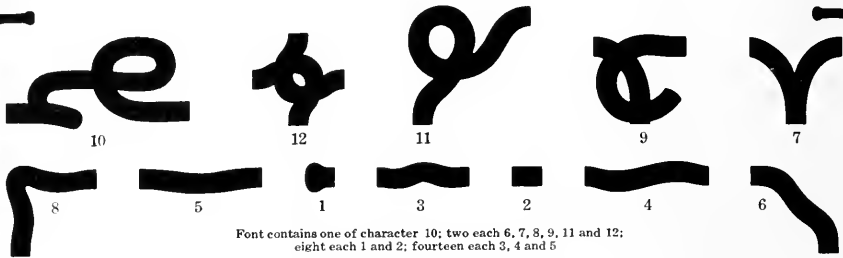

6 POINT MAGAZINE BORDER

Characters in Complete Font

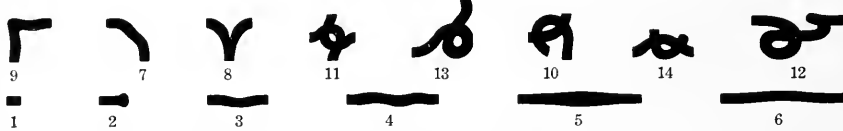

TIMES BORDERS

12 Point, 54 inches, \$1.50

6 Point, 60 inches, \$1.50

Characters in Complete Font

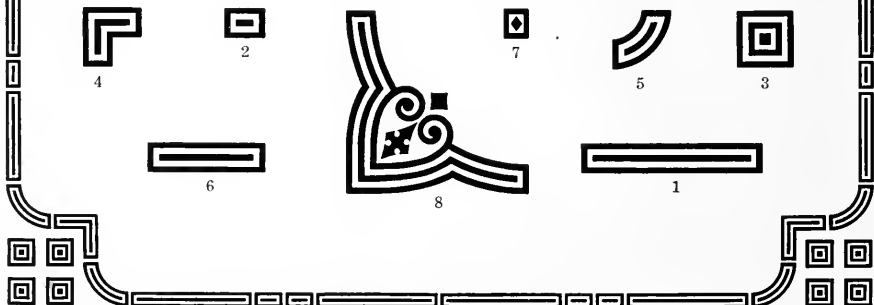

Mercantile Borders

12 POINT MERCANTILE BORDER No. 236

54 inches \$1.50

Characters in Complete Font



Font contains sixteen each of characters 1, 2 and 3; thirty of 4, four each 5, 6, 7 and 8

3-on-6 POINT MERCANTILE BORDER No. 49

60 inches \$1.50

Characters in Complete Font

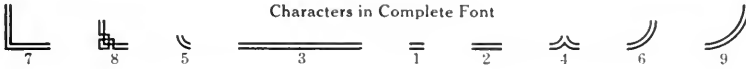

Font contains eighteen of character 1; twenty-nine of 2; sixty-two of 3; six of 4, twelve of 5, eight each 6 and 7; four each 8 and 9

6 POINT MERCANTILE BORDER No. 257

60 inches \$1.50

Characters in Complete Font

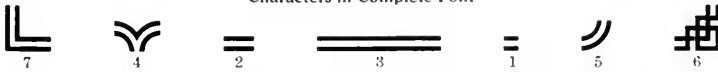

Font contains twenty-four of character 1; forty-two of 2; sixty of 3; four each 4 and 6; eight each 5 and 7

18 POINT MERCANTILE BORDER

36 inches \$1.30

Characters in Complete Font



Font contains eight of character 1, ten of 2; fourteen of 3; four each 4, 6 and 7; two of 5

Newspaper Borders and Triple Line Borders

12 Point No. 231, 54 inches, \$1.50

6 Point No. 254, 60 inches, \$1.50

NEWSPAPER BORDERS

Characters in Complete Fonts

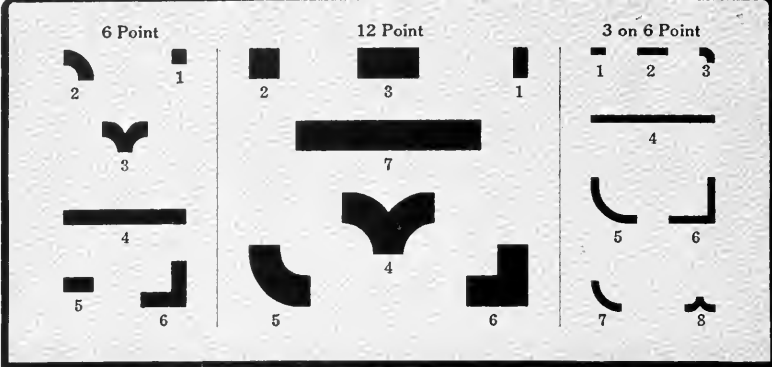

3-on-6 Point No. 48, 60 inches, \$1.50

12 Point No. 1, 54 inches, \$1.50

TRIPLE LINE BORDERS

Characters in Complete Font

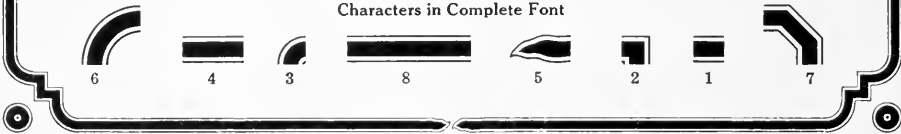

6 Point No. 3, 60 inches, \$1.50

12 Point No. 2, 54 inches, \$1.50

TRIPLE LINE BORDERS

Characters in Complete Font



6 Point No. 4, 60 inches, \$1.50

Adver Borders

ADVER BORDER No. 2
Per Font \$4.75
Characters in Complete Font

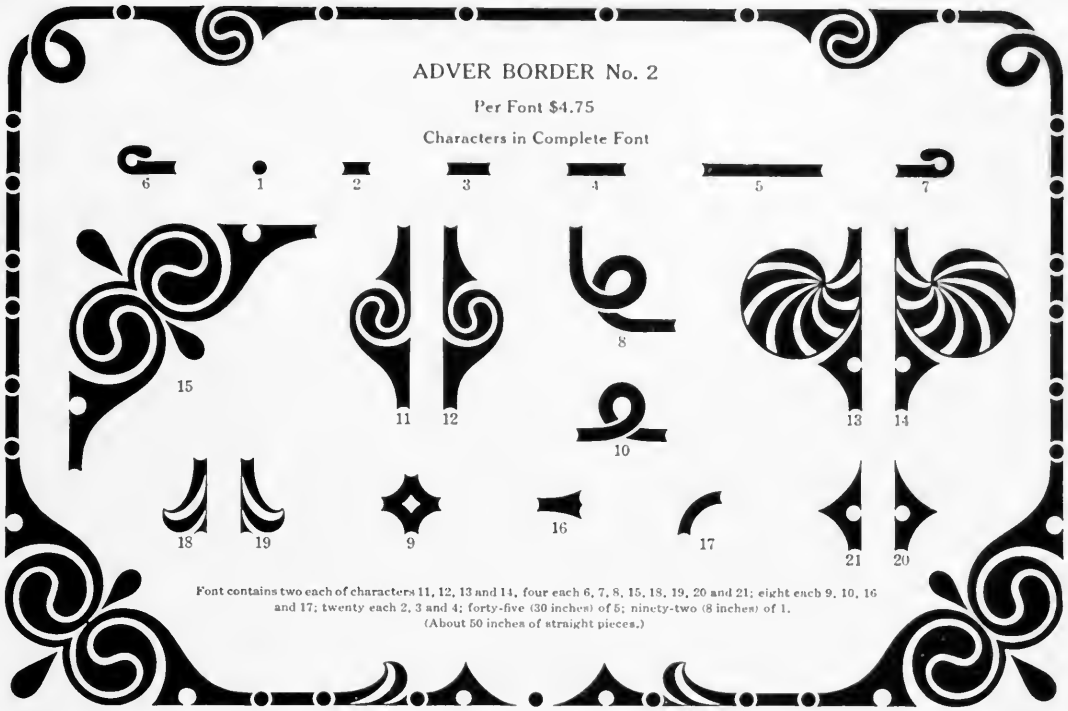

6 1 2 3 4 5 7

15 11 12 8 13 14

18 19 9 16 17 21 20

Font contains two each of characters 11, 12, 13 and 14, four each 6, 7, 8, 15, 18, 19, 20 and 21; eight each 9, 10, 16 and 17; twenty each 2, 3 and 4; forty-five (30 inches) of 5; ninety-two (8 inches) of 1.
(About 50 inches of straight pieces.)

ADVER BORDER No. 1
Per Font \$2.50
Characters in Complete Font



7 2 1 3 4 5 6

8 9 17 16 10

Font contains four each of characters 6, 7 and 8; eight each 9, 10, 16 and 17; twenty each 2, 3 and 4; forty-three of 5; seventy-two of 1. (Practically 72 inches of straight pieces.)

ADVER BORDER No. 239
Per Font \$1.50
Characters in Complete Font

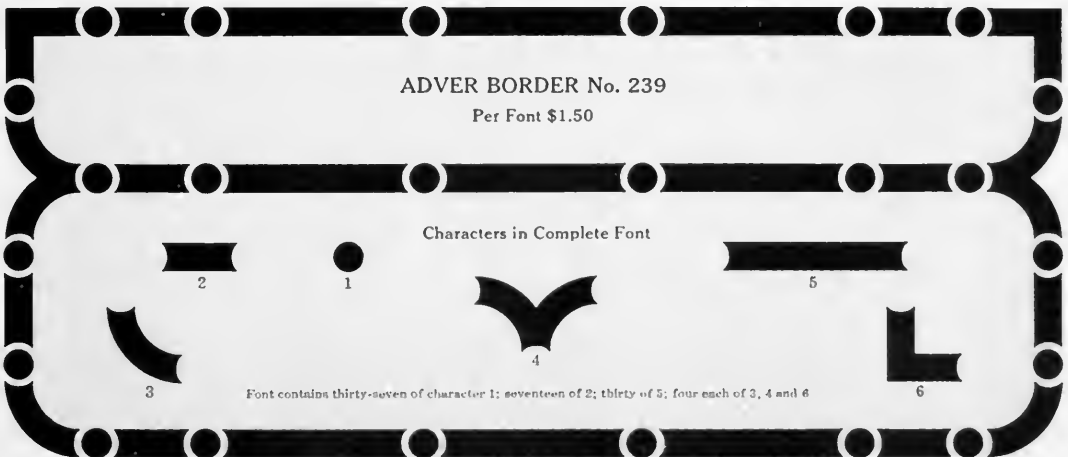

2 1 5

3 4 6

Font contains thirty-seven of character 1; seventeen of 2; thirty of 5; four each of 3, 4 and 6

Stylus Border

THE STYLUS BORDER IS VERY ORNATE AND ATTRACTIVE. IT IS VERY ADAPTABLE FOR USE WITH ALMOST ANY STYLE OF LETTER FACE AND OWING TO ITS MULTIPLICITY OF COMBINATIONS IT WILL PRODUCE THE MOST ARTISTIC ENGRAVED EFFECTS. IT IS ESPECIALLY SUITABLE FOR QUICK HANDLING, THUS ENABLING THE PRINTER TO READILY FORM AN EMBELLISHMENT THAT WILL BE APPROPRIATE FOR THE JOB IN HAND

BORDER BEAUTIES OBTAINED

All characters are cast on point bodies, lining perfectly in any combination by using our six and twelve point quads

HIGHLY EFFECTIVE COMBINATIONS

The possibilities of the Stylus Border for original and artistic effects in the composing room are practically limitless

Per Font \$3.75

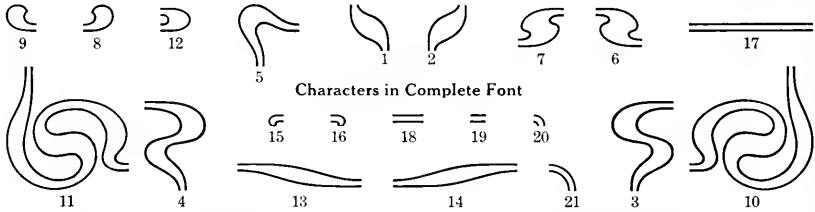

Characters in Complete Font

Font contains two each of characters 3, 4, 10 and 11; four each 1, 2, 6, 7, 8, 9, 12, 15 and 16; eight each 5, 20 and 21; nine each 13 and 14; thirty-six of 18; forty-eight of 19; sixty-six of 17

AMERICAN TYPE FOUNDERS COMPANY

EVERYTHING FOR THE PRINTER

Graphic Border

THE CHARACTERS OF THIS BORDER ARE CAST ON MULTIPLES OF TWELVE POINT. THEY ARE ESPECIALLY ADAPTED TO BE SET IN A GREAT VARIETY OF STYLES, THUS PRODUCING MANY UNIQUE AND ATTRACTIVE DESIGNS OF DISTINCTIVE MERIT

Per Font
\$4.00.

Characters in Complete Font

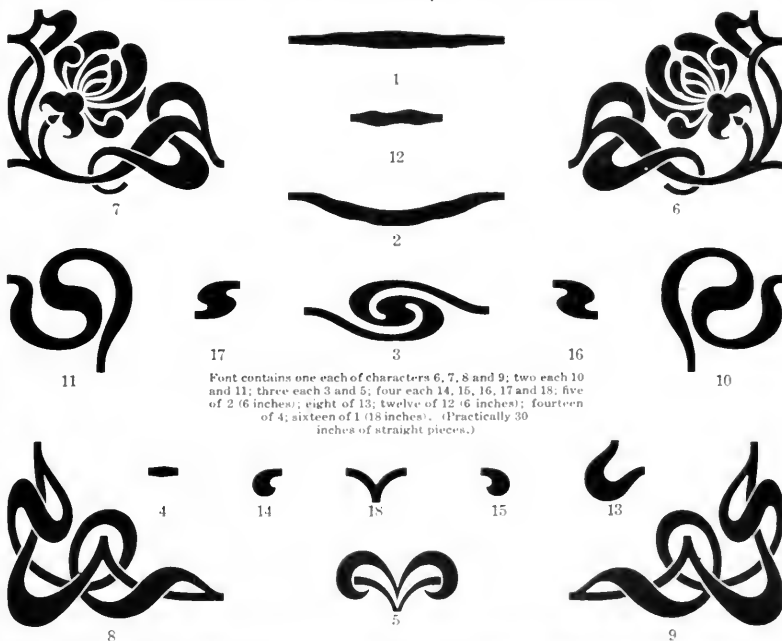

AMERICAN TYPE FOUNDERS COMPANY

Post Borders

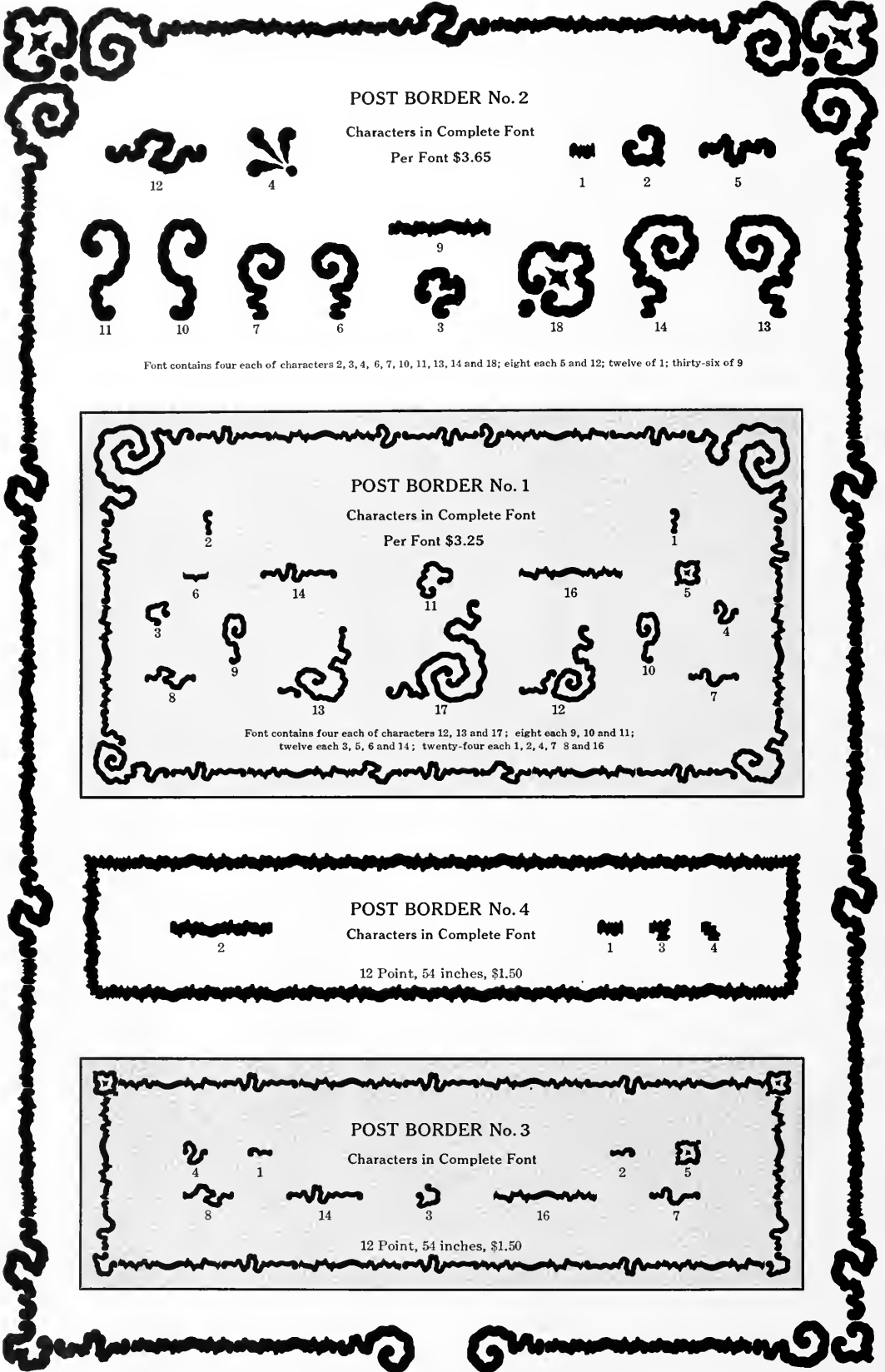

POST BORDER No. 2

Characters in Complete Font
Per Font \$3.65

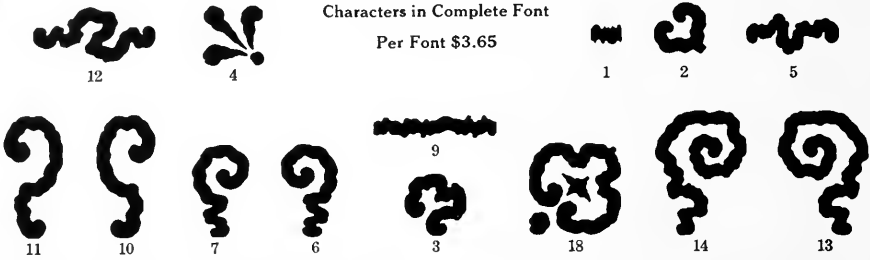

Font contains four each of characters 2, 3, 4, 6, 7, 10, 11, 13, 14 and 18; eight each 5 and 12; twelve of 1; thirty-six of 9

POST BORDER No. 1

Characters in Complete Font
Per Font \$3.25

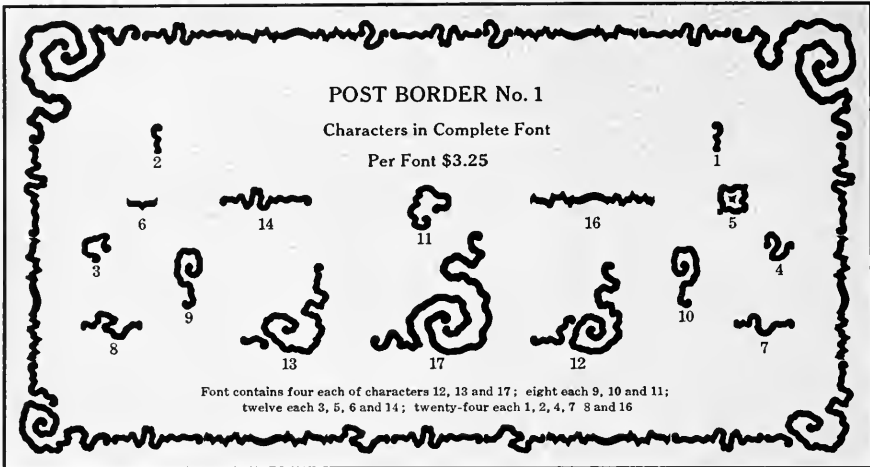

Font contains four each of characters 12, 13 and 17; eight each 9, 10 and 11; twelve each 3, 5, 6 and 14; twenty-four each 1, 2, 4, 7, 8 and 16

POST BORDER No. 4

Characters in Complete Font

12 Point, 54 inches, \$1.50

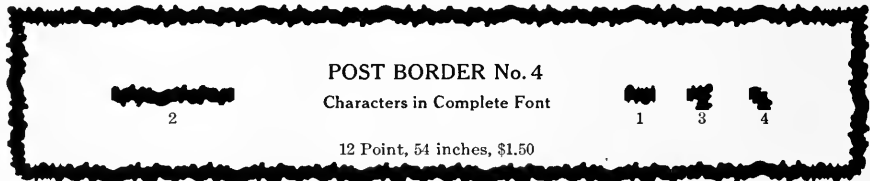

POST BORDER No. 3

Characters in Complete Font

12 Point, 54 inches, \$1.50

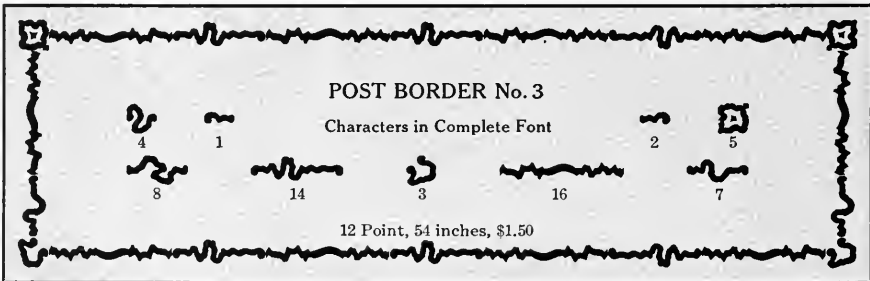

Arlington Borders, Abbot Border and Herald Borders

18 Point, 36 inches, \$1.30

12 Point No. 234, 54 inches, \$1.50

ARLINGTON BORDERS

Characters in Complete Font

3-on-6 Point, 60 inches, \$1.50

6 Point No. 255, 60 inches, \$1.50

ABBOT BORDER

Per Font \$2.00

Characters in Complete Font

Font contains two each of characters 11 and 12, four each 4, 5, 6, 9 and 10; five each 1, 2 and 3; six each 7, 8, 13, 14, 15 and 16. (24 inches of straight pieces.)

12 Point, 54 inches, \$1.50

6 Point, 60 inches, \$1.50

HERALD BORDERS

Characters in Complete Font

Linear Borders

24 POINT LINEAR BORDER

Per Font, 36 inches, \$1.65
Characters in Complete Font



3



1



2

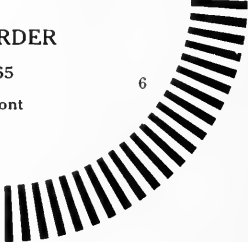

6

Font contains four each of characters 1 and 6; nine of 2; thirteen of 3

6 POINT LINEAR BORDER

Per Font, 60 inches, \$1.50
Characters in Complete Font



6



4



5



3



7



2



1

Font contains sixteen of character 1; fifty-four of 2; thirty-six of 3; four each 4 and 5; eight of 6; forty-two of 7

18 POINT LINEAR BORDER

Per Font, 36 inches, \$1.30
Characters in Complete Font

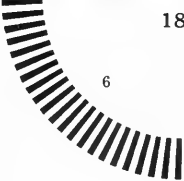

6



3



1



5



2

Font contains four each of characters 1 and 6; ten of 2; eight of 3; four of 5

12 POINT LINEAR BORDER

Per Font, 54 inches, \$1.50
Characters in Complete Font



4



1



6



2



5



3

Font contains eight of character 1; thirty-six of 2; sixteen of 3; four each 4 and 5; eight of 6

Patriotic Borders

48 POINT PATRIOTIC BORDER

Per Font, 36 inches, \$3.00

Characters in Complete Font



13



11



16



12



10



9



11

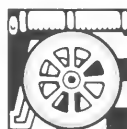

8

Font contains two each of characters 8 and 9; four each of 10, 11, 12, 13 and 14, twelve of 16

24 POINT PATRIOTIC BORDER

Per Font, 36 inches, \$1.65

Characters in Complete Font



14



1



15



1



2



3

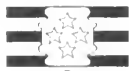

7



4

Font contains twelve each of characters 1, 2, 3, 4 and 15; four of each of 6, ten of 7

Easter Border

AN ENTIRELY NEW IDEA IN A COMBINATION BORDER. IT IS VERY APPROPRIATE FOR EASTER-TIME PRINTING. THE INDIVIDUAL CHARACTERS MAY BE USED IN COMBINATION OR INDIVIDUALLY AS MAY BE DESIRED BY THE PRINTER

EASTER BORDER

Characters in Complete Font

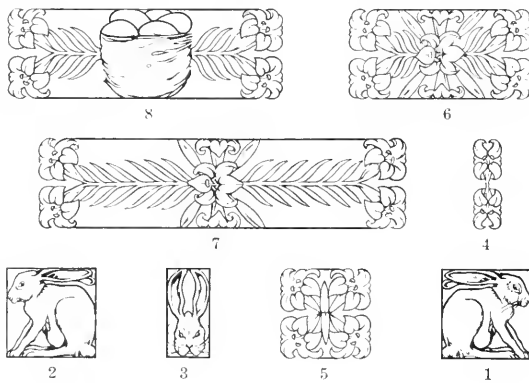

Per Font, 36 inches, \$2.50

Font contains four each of characters 1, 2 and 7; eight of 3, eighteen of 4; twelve of 5; ten of 6; two of 8

Floral Borders and Brier Border

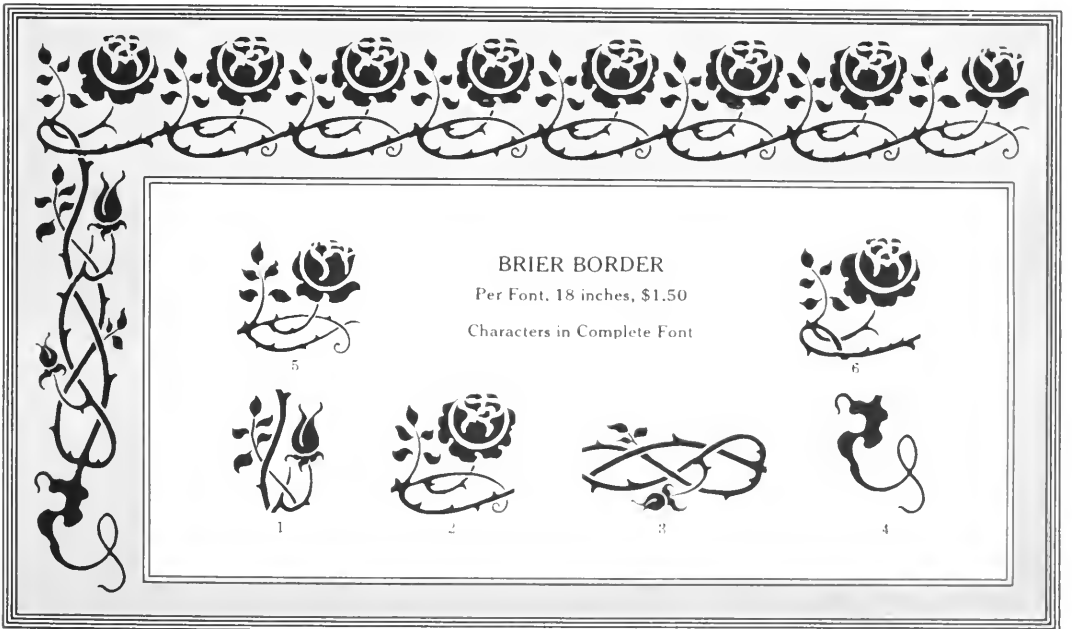
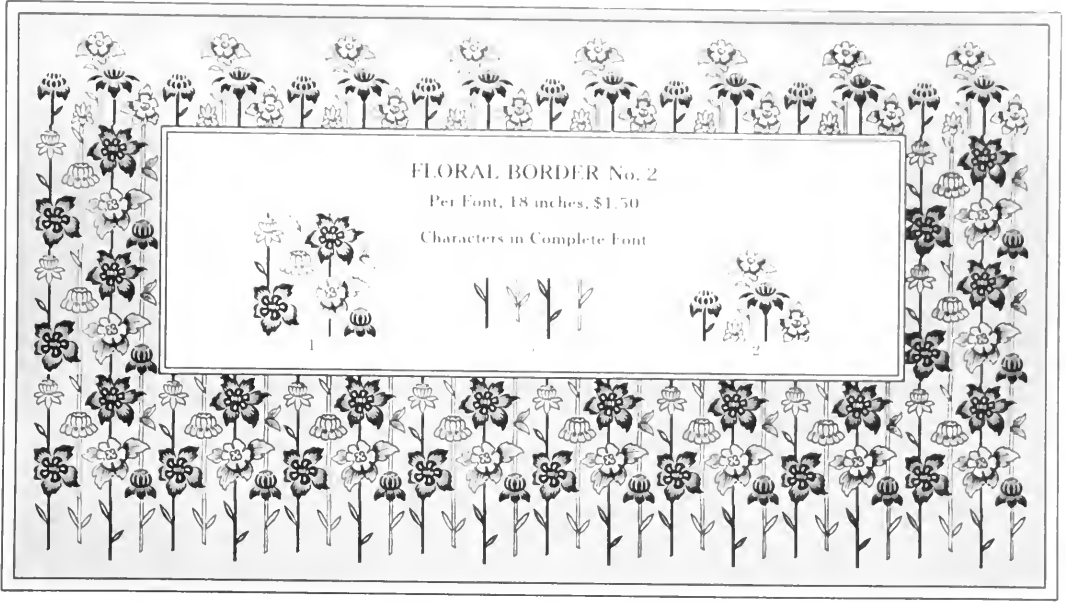

Strand Border, Grille Border and Sansom Border

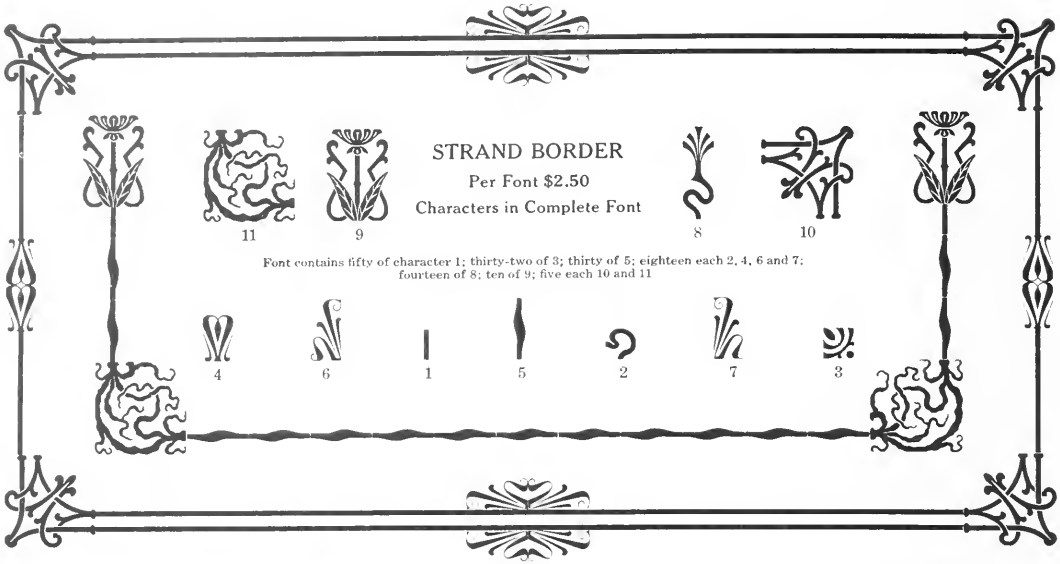

STRAND BORDER
Per Font \$2.50
Characters in Complete Font

Font contains fifty of character 1; thirty-two of 3; thirty of 5; eighteen each 2, 4, 6 and 7; fourteen of 8; ten of 9; five each 10 and 11

11 9 8 10

4 6 1 5 2 7 3

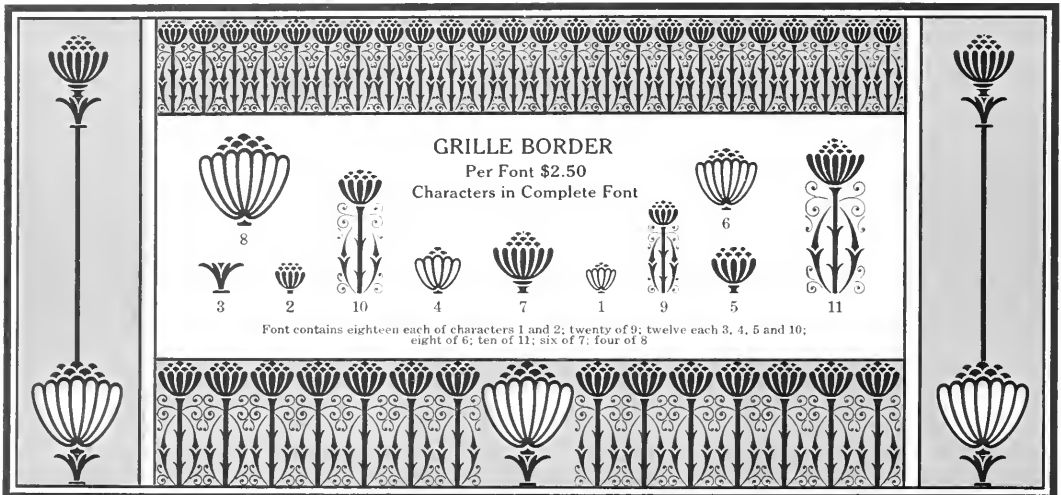

GRILLE BORDER
Per Font \$2.50
Characters in Complete Font

Font contains eighteen each of characters 1 and 2; twenty of 9; twelve each 3, 4, 5 and 10; eight of 6; ten of 11; six of 7; four of 8

8 10 4 7 1 9 6 11

3 2

5

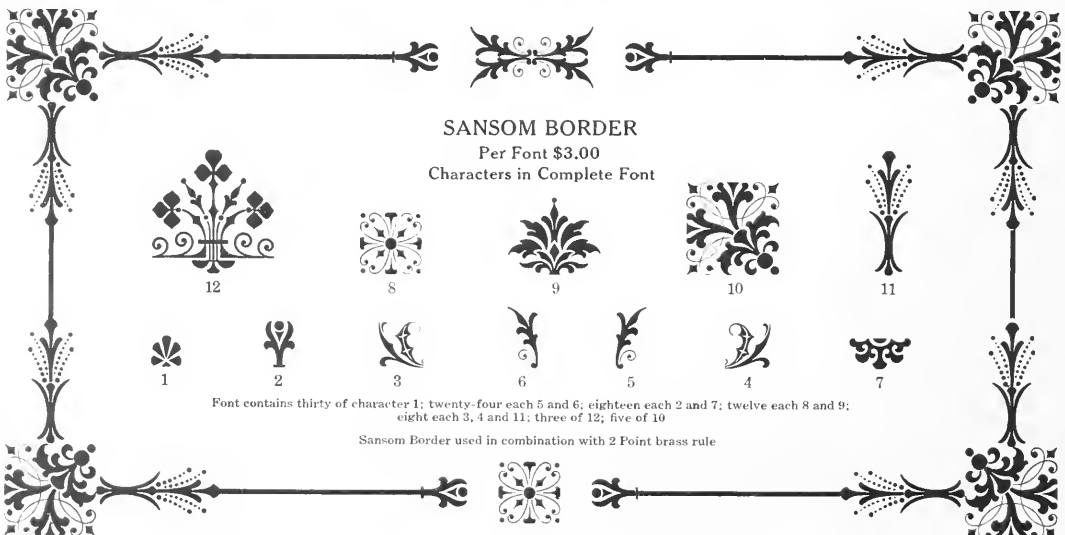

SANSOM BORDER
Per Font \$3.00
Characters in Complete Font

Font contains thirty of character 1; twenty-four each 5 and 6; eighteen each 2 and 7; twelve each 8 and 9; eight each 3, 4 and 11; three of 12; five of 10

Sansom Border used in combination with 2 Point brass rule

12 8 9 10 11

1 2 3 6 5 4 7

Thistle Border, Meadow Border and Teasel Border



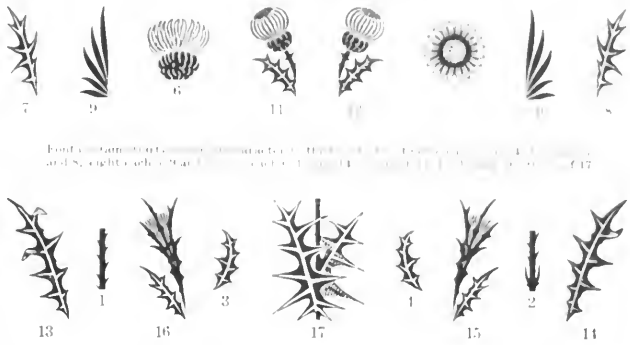

THISTLE BORDER Per Font \$3.00

Characters in Complete Font



Font contains forty-one characters: character 1, thirty-six of 3; six each 4, 5, 6, 9, 19 and 20, four each 7, 8, 10, 11, 12, 13, 15, 16 and 21, ten of 17, three each 14, 22, 24 and 25; two each 18 and 23.





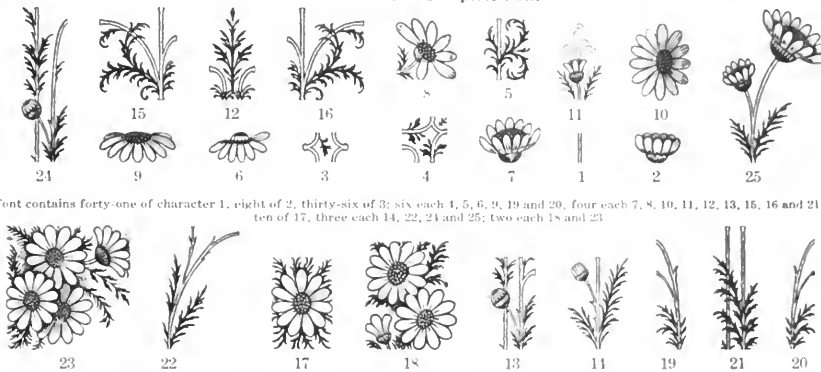

MEADOW BORDER Per Font \$3.50

Characters in Complete Font



Font contains forty-one of character 1, eight of 2, thirty-six of 3; six each 4, 5, 6, 9, 19 and 20, four each 7, 8, 10, 11, 12, 13, 15, 16 and 21, ten of 17, three each 14, 22, 24 and 25; two each 18 and 23.





TEASEL BORDER Per Font \$2.50

Characters in Complete Font

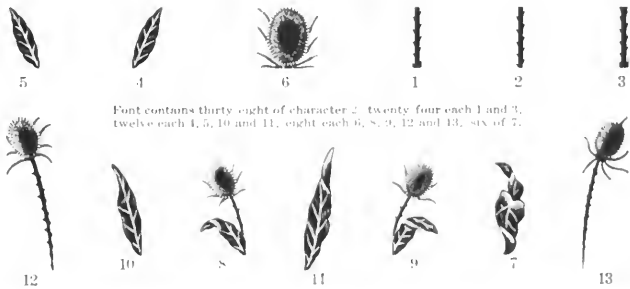

Font contains thirty-eight of character 2, twenty-four each 1 and 3, twelve each 4, 5, 10 and 11, eight each 6, 8, 9, 12 and 13, six of 7.



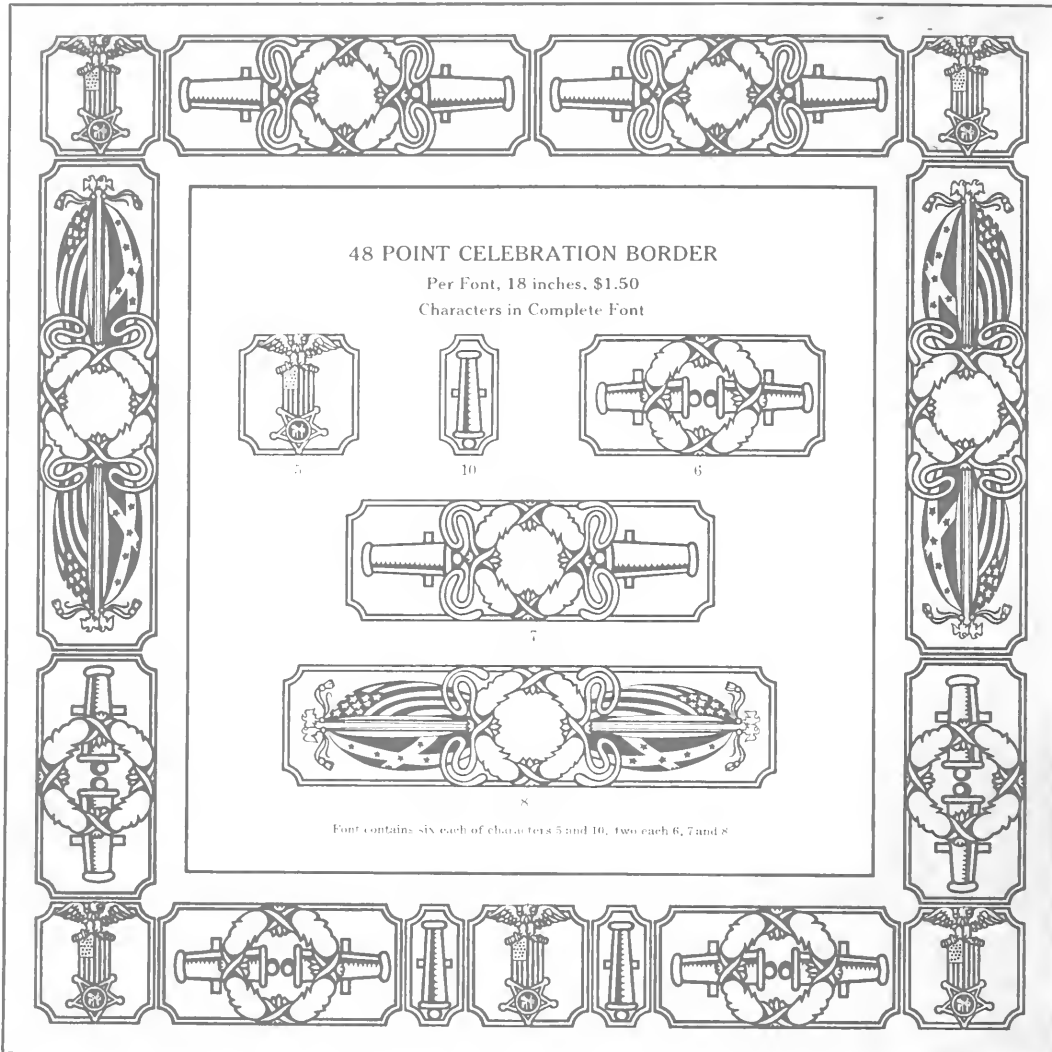

Celebration Borders



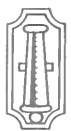

48 POINT CELEBRATION BORDER
Per Font, 18 inches, \$1.50
Characters in Complete Font

5

10

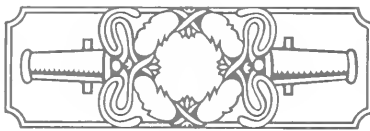
6

7

8

Font contains six each of characters 5 and 10, two each 6, 7 and 8



24 POINT CELEBRATION BORDER
Per Font, 36 inches, \$1.65
Characters in Complete Font

2

1

3





9



4

Font contains eight each of characters 1 and 2, ten of 3, twelve each 4 and 9

Versatile Borders

VERSATILE BORDER No. 2405
Per Foot \$2.00
Characters in Complete Font

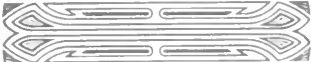



Versatile Border No. 2405 is new and interesting. It is composed of five characters, as shown above. Each character may be used appropriately as an individual ornament, or the several different characters may be combined into an attractive and tasteful border. The high artistic quality of these new designs will undoubtedly be appreciated by all printers.

AMERICAN TYPE FOUNDERS CO.
ORIGINATOR AND MAKER

21 Point No. 1801, 36 inches \$1.65

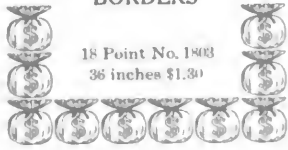

18 Point No. 1801
36 inches \$1.30

**VERSATILE
BORDERS**

18 Point No. 1803
36 inches \$1.30

21 Point No. 2403, 36 inches \$1.65

21 Point No. 1802, 36 inches \$1.65

18 Point No. 1802
36 inches \$1.30

**VERSATILE
BORDERS**

18 Point No. 1802
36 inches \$1.30

21 Point No. 2402, 36 inches \$1.65

Versatile Borders

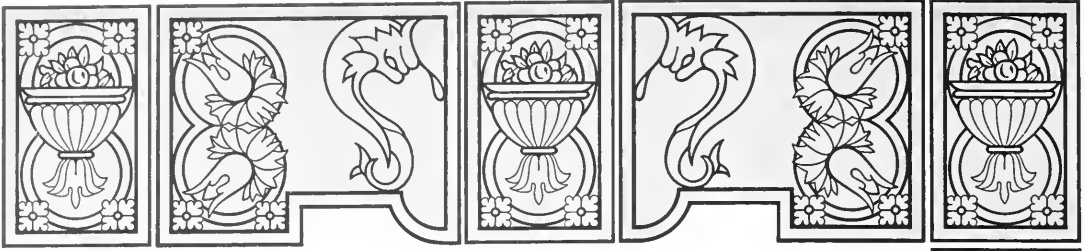

VERSATILE BORDER No. 6002 and No. 6003 (Color)

CAST IN TYPE MOLDS

Per Font, each, \$3.75

Characters in Complete
Font



No. 3; color No. 13



No. 1; color No. 11

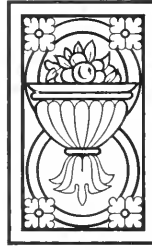

No. 2; color No. 12

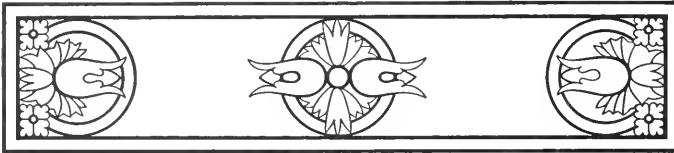
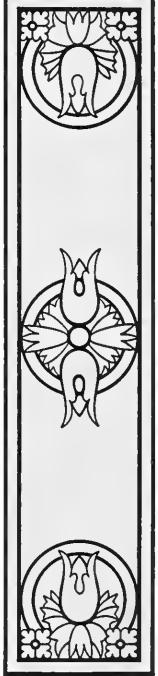

No. 4; color No. 14

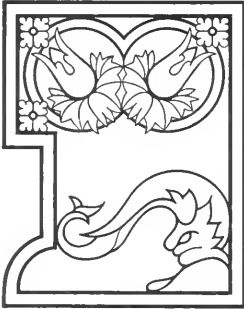

No. 5; color No. 15
Reverse No. 6; color No. 16



No. 7; color No. 17
Reverse No. 8; color No. 18



Font No. 6002 contains one each of characters 5, 6, 7 and 8; two each 2 and 4; four of 3; eight of 1
Font No. 6003 contains one each of characters 15, 16, 17 and 18; two each 12 and 14, four of 13; eight of 11

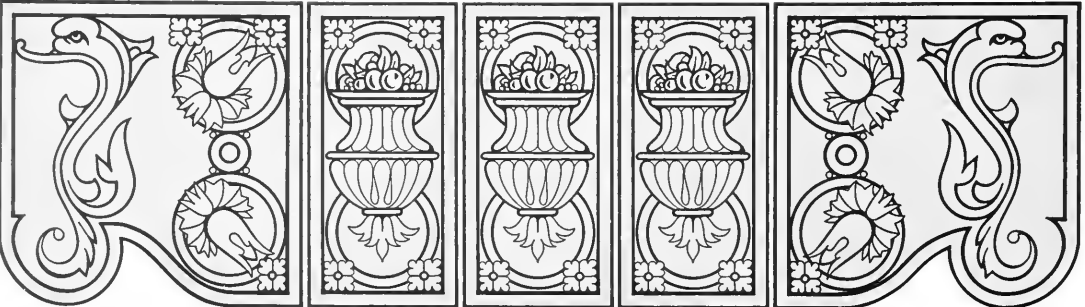

Versatile Electro Ornament

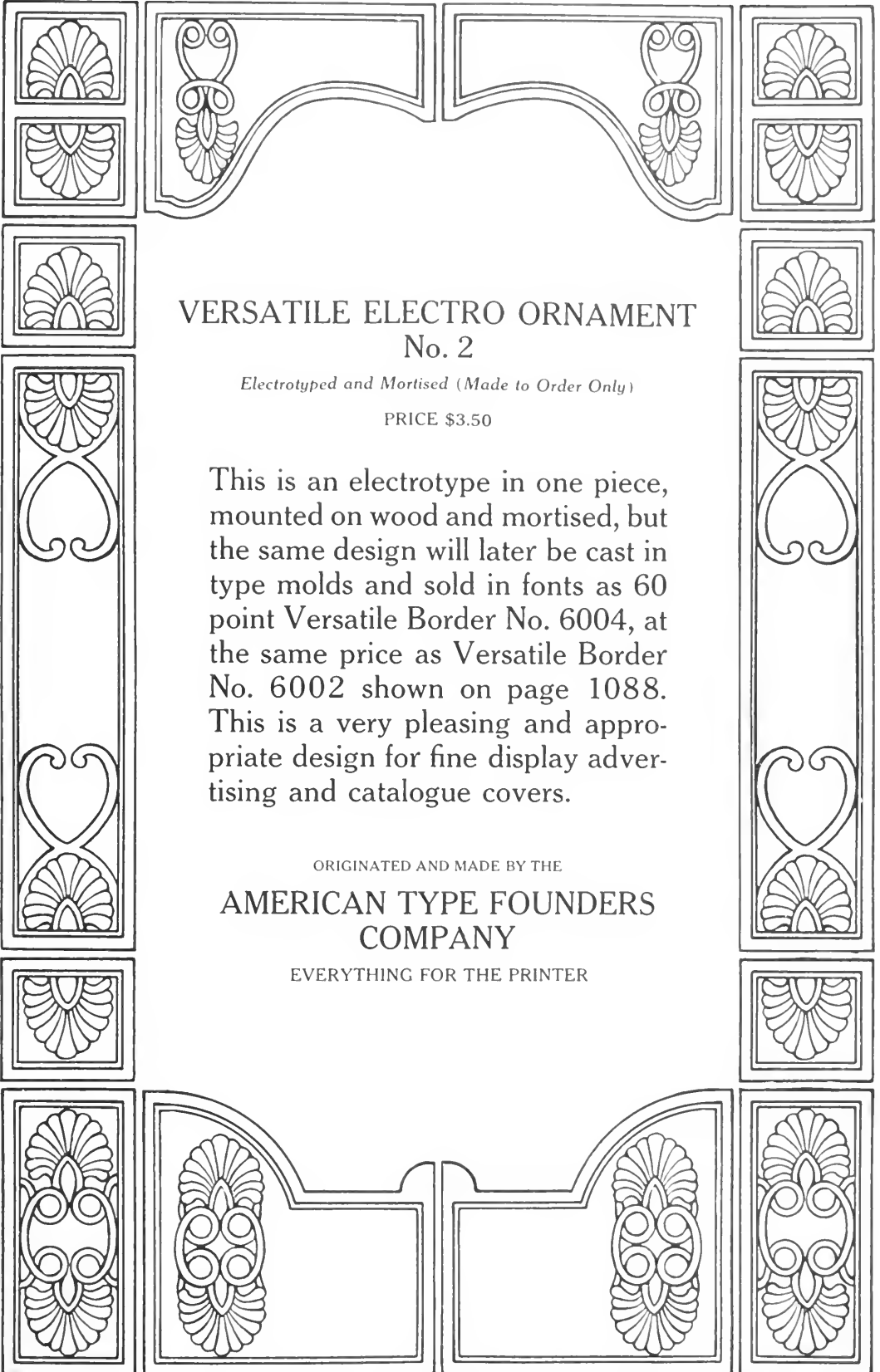

VERSATILE ELECTRO ORNAMENT No. 2

Electrotyped and Mortised (Made to Order Only)

PRICE \$3.50

This is an electrotype in one piece, mounted on wood and mortised, but the same design will later be cast in type molds and sold in fonts as 60 point Versatile Border No. 6004, at the same price as Versatile Border No. 6002 shown on page 1088. This is a very pleasing and appropriate design for fine display advertising and catalogue covers.

ORIGINATED AND MADE BY THE

**AMERICAN TYPE FOUNDERS
COMPANY**

EVERYTHING FOR THE PRINTER

Versatile Electro Ornament

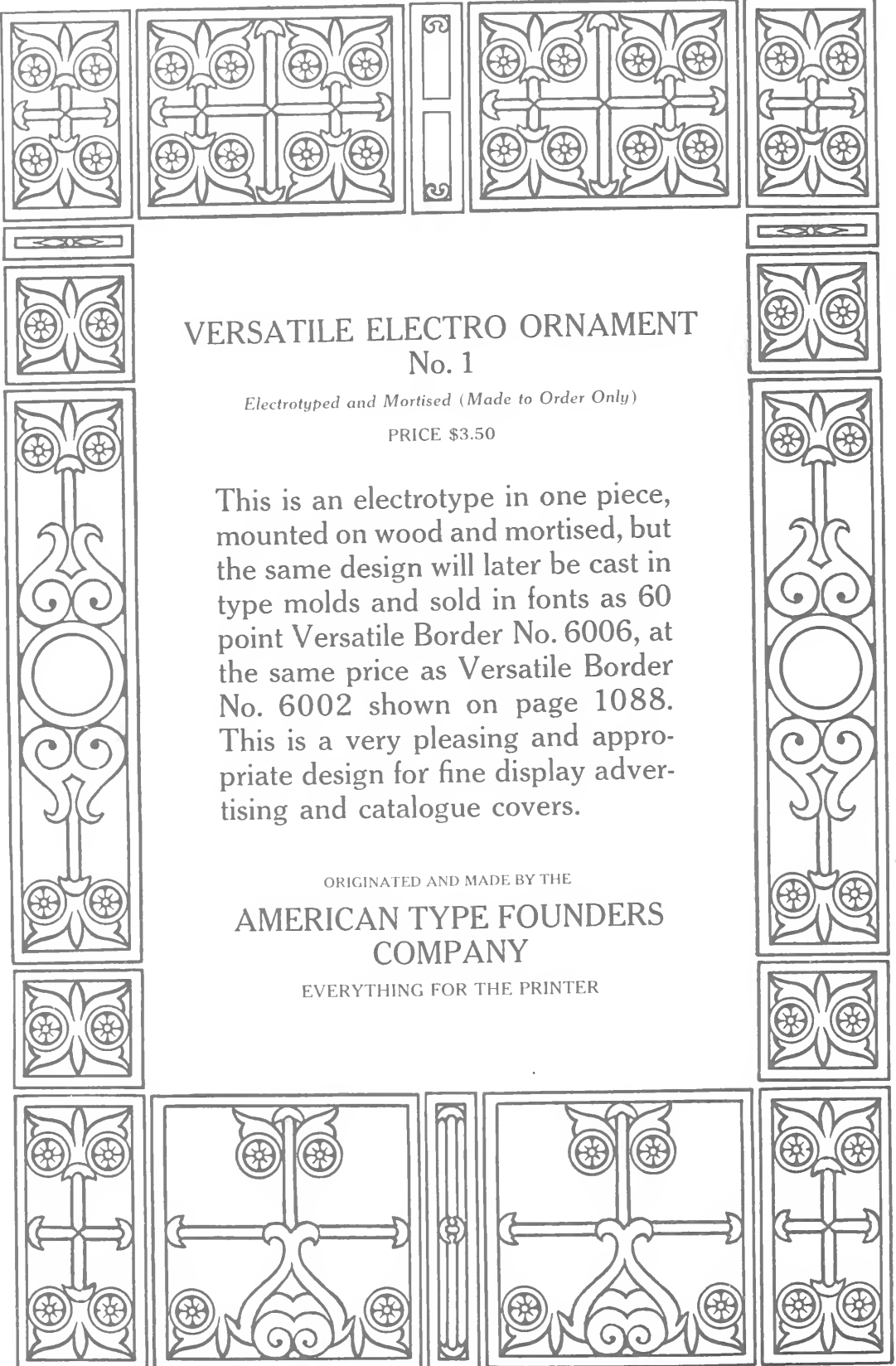

VERSATILE ELECTRO ORNAMENT No. 1

Electrotyped and Mortised (Made to Order Only)

PRICE \$3.50

This is an electrotpe in one piece, mounted on wood and mortised, but the same design will later be cast in type molds and sold in fonts as 60 point Versatile Border No. 6006, at the same price as Versatile Border No. 6002 shown on page 1088. This is a very pleasing and appropriate design for fine display advertising and catalogue covers.

ORIGINATED AND MADE BY THE

**AMERICAN TYPE FOUNDERS
COMPANY**

EVERYTHING FOR THE PRINTER

Versatile Border

60 POINT VERSATILE BORDER No. 6001

Per Foot .36 inches, \$3.75

Characters in Complete Font

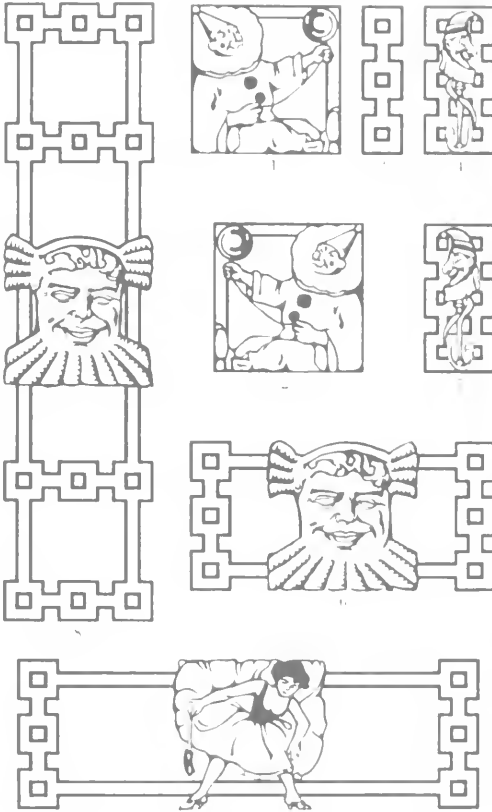

A Snappy and Original Border Design, Suitable for
High-Grade Entertainment Work

American Type Founders
Company

King

The Empire
Hippodrome

Cast Panel Pieces

FOR USE WITH BRASS RULE

CAST PANEL PIECES are made in the two sizes, 12 and 18 Point. In each size there are two patterns: one with which a single rule is used, the other with which two rules are used. All the rules required are standard, commonly used faces. A labor-saving font each of our 1, 2, 3, 4 and 6 point flush-with-body face rules will provide for the entire outfit. These are rule faces that most offices are already provided with. While the Cast Panel Pieces do not dispense with the use of a mitering machine in an office, they do, in actual use, with a proper equipment of our accurately cut brass rule, dispense with mitering. That is their intent; they make possible much better rule designs, without the expense and delay of cutting and mitering. For two-color work the single-line designs, with brass rule, are used in setting form for the second color.

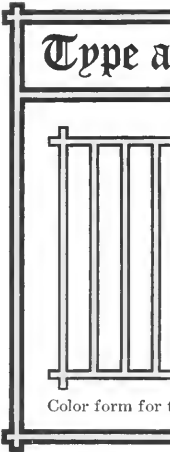
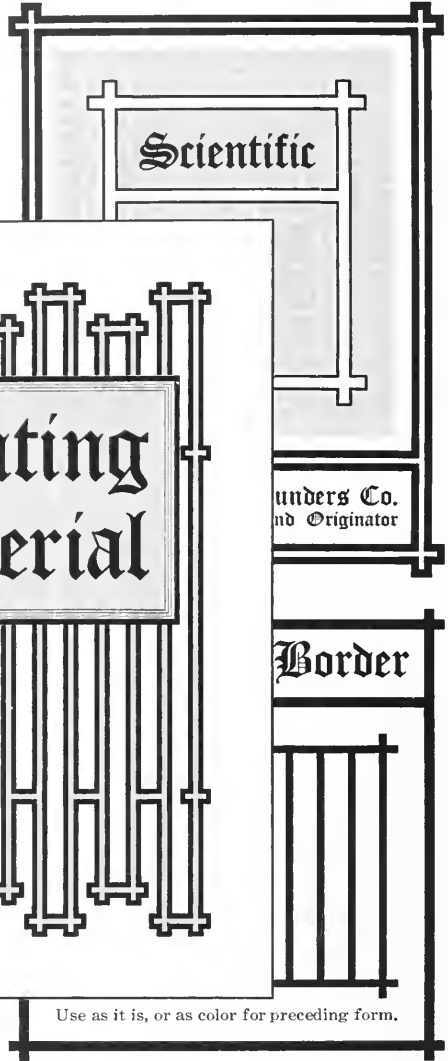

Color form for this design shown annexed.

Use as it is, or as color for preceding form.

12 POINT CAST PANEL PIECES

Group 1
24 of each character, 50c



Group 2
24 of each character, 50c



Group 3
24 of each character, 50c



Group 4
24 of each character, 50c



Group 11
16 of each character, 50c



Group 12
16 of each character, 50c



18 POINT CAST PANEL PIECES

Group 1
16 of each character, 50c



Group 2
16 of each character, 50c



Group 3
16 of each character, 50c



Group 4
16 of each character, 50c



Group 6
16 of each character, 50c



Group 11
12 each H and J, 8 of I, 50c



Group 12
12 each H and J, 8 of I, 50c



Group 13
12 each H and J, 8 of I, 50c



Boston Breton Cast Squares

BOSTON BRETON CAST SQUARES

10 Point No. 1, font contains 16 sets	50c
10 Point No. 2, font contains 8 sets, each	50c
10 Point No. 3, font contains 16 sets	50c
12 Point No. 4, font contains 12 sets	50c
12 Point No. 5, font contains 6 sets, each	50c
12 Point No. 6, font contains 12 sets	50c
18 Point No. 7, font contains 8 sets	50c
18 Point No. 8, font contains 4 sets, each	50c
18 Point No. 9, font contains 8 sets	50c
24 Point No. 10, font contains 5 sets	50c
24 Point No. 11, font contains 3 sets, each	60c
24 Point No. 12, font contains 5 sets	50c
30 Point No. 13, font contains 5 sets	75c
30 Point No. 14, font contains 3 sets, each	90c
30 Point No. 15, font contains 5 sets	75c
36 Point No. 16, font contains 4 sets	80c
36 Point No. 17, font contains 2 sets, each	80c
36 Point No. 18, font contains 4 sets	80c

Nos. 1, 4, 7, 10, 13 and 16 contain only characters of the large Square with the inner Square for one color.

Nos. 2, 5, 8, 11, 14 and 17 contain the hollow Square and the angle for two color work.

Nos. 3, 6, 9, 12, 15 and 18 contain the hollow Square only.

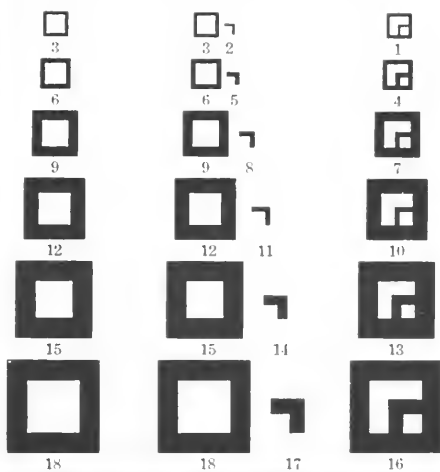

For One and Two Colors

Cast Squares

36 POINT CAST SQUARES Four Sets, any character, 80c



36 Color

Cast Squares are made for printing in either one or two colors



Sq 36-8



Sq 36-6



M 36-4



Sw 36-4



C 36-4



D 36-4



Sq 36-4



M 36-3



Sw 36-3



C 36-3



D 36-3



Sq 36-3



M 36-2



Sw 36-2



C 36-2



D 36-2



Sq 36-2



M 36-1



Sw 36-1



C 36-1



D 36-1



Sq 36-1

18 POINT CAST SQUARES

Eight Sets, any character, 50c



Sq 18-4



C 18-2



D 18-2



Sq 18-3



C 18-1



D 18-1



Sq 18-2



Sw 18-2



M 18-2



Sq 18-1



Sw 18-1



M 18-1



18 Color

6 PT. CAST SQUARES

30 Sets, either character, 50c



Sq 6-1



6 Color

10 POINT CAST SQUARES

Sixteen Sets, any character, 50c



Sq 10-1



Sq 10-2



Sq 10-3



10 Color

30 POINT CAST SQUARES

Five Sets, any character, 75c



30 Color



Sq 30-6



Sq 30-4



M 30-3



Sw 30-3



C 30-3



D 30-3



Sq 30-3



M 30-2



Sw 30-2



C 30-2



D 30-2



Sq 30-2



M 30-1



Sw 30-1



C 30-1



D 30-1



Sq 30-1

8 POINT CAST SQUARES

Twenty Sets, any character, 50c



Sq 8-1



8 Color



Sq 8-2

24 POINT CAST SQUARES Five Sets, any character, 50c



M 24-3



Sw 24-3



C 24-3



D 24-3



Sq 24-3



Sq 24-4



M 24-2



Sw 24-2



C 24-2



D 24-2



Sq 24-2



M 24-1



Sw 24-1



C 24-1



D 24-1



Sq 24-1



24 Color

12 POINT CAST SQUARES

Twelve Sets, any character, 50c



M 12-2



D 12-2



C 12-1



M 12-1



D 12-1



C 12-2



Sw 12-2



Sq 12-2



Sq 12-3



Sw 12-1



Sq 12-1



12 Color

Uniform-Rule Cast Corners

UNIFORM-RULE CAST CORNERS FOR ONE COLOR

 THESE are very desirable because of the big sizes (being made to include 48, 60 and 72 point), and can be used to excellent advantage in lines of bigger work than that which is provided for in other series of similar material. The nine sizes make a useful outfit

10 Point Font contains 8 sets	50c
Use 2 Point Face Rule	
12 Point Font contains 6 sets	50c
Use 2 Point Face Rule	
18 Point Font contains 4 sets	40c
Use 3 Point Face Rule	
24 Point Font contains 3 sets	50c
Use 4 Point Face Rule	
30 Point Font contains 3 sets	75c
Use 6 Point Face Rule	
36 Point Font contains 4 sets	80c
Use 6 Point Face Rule	
48 Point, per set	20c
Use 8 Point Face Rule	
60 Point, per set	25c
Use 10 Point Face Rule	
72 Point, per set	30c
Use 12 Point Face Rule	

Uniform-Rule Cast Corners are so named because all the lines in each size are the same width, requiring but one kind of rule. A "Set" means four corners

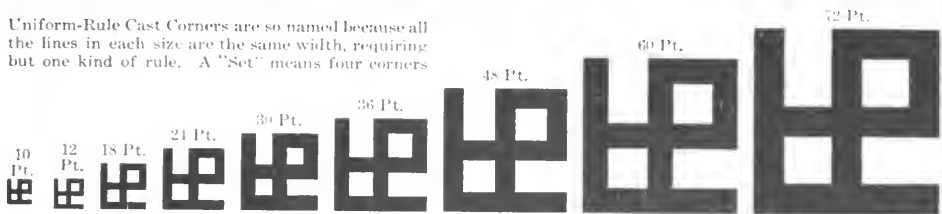

UNIFORM-RULE CAST CORNERS FOR TWO COLORS

10 Point Font contains 8 sets	50c
Use 2 Point Face Rule	
12 Point Font contains 6 sets	50c
Use 2 Point Face Rule	
18 Point Font contains 4 sets	50c
Use 3 Point Face Rule	
24 Point Font contains 3 sets	60c
Use 4 Point Face Rule	
30 Point Font contains 3 sets	90c
Use 6 Point Face Rule	
36 Point Font contains 2 sets	80c
Use 6 Point Face Rule	
48 Point, per set	35c
Use 8 Point Face Rule	
60 Point, per set	40c
Use 10 Point Face Rule	
72 Point, per set	50c
Use 12 Point Face Rule	

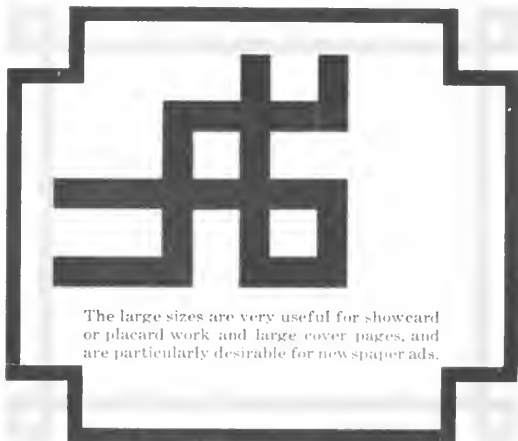





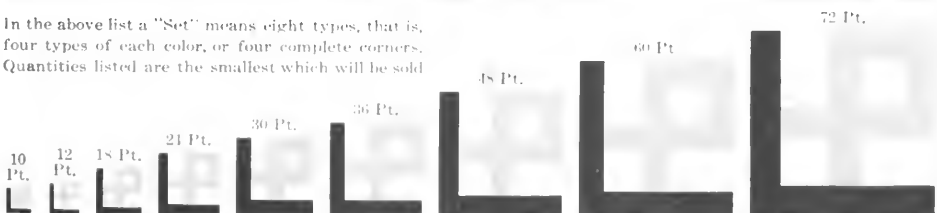

The large sizes are very useful for showcard or placard work and large cover pages, and are particularly desirable for newspaper ads.

In the above list a "Set" means eight types, that is, four types of each color, or four complete corners. Quantities listed are the smallest which will be sold











Art-tiles, Outline Art-tiles and Art-tile Tint Formers

ART-TILES AND OUTLINE ART-TILES

10 Point No. 1001 (Outline) Price per font, 54 inches, \$1.40	
10 Point No. 1002 (Tint) Price per font, 54 inches, \$1.40	
12 Point No. 1201 (Outline) Price per font, 54 inches, \$1.50	
12 Point No. 1202 (Tint) Price per font, 54 inches, \$1.50	
18 Point No. 1801 (Outline) Price per font, 36 inches, \$1.30	
18 Point No. 1802 (Tint) Price per font, 36 inches, \$1.30	

ART-TILE TINT FORMERS

6 Point, 60 inches, \$1.50		
8 Point, 54 inches, \$1.35		24 Point, 36 inches, \$1.65
10 Point, 54 inches, \$1.40		30 Point, 24 inches, \$1.35
12 Point, 54 inches, \$1.50		36 Point, 24 inches, \$1.65
18 Point, 36 inches, \$1.30		  

**Items Made
of Brass
for the
Composing
Room**



By the
**American
Type Founders
Company**





A Corner of the Brass Rule Department of the American Type Foundry Company

NEW SYSTEMATIC POINT-FACE BRASS RULE

Point Faces as well as Point Bodies



NEW Systematic Point-Face Brass Rule means that our Brass Rule faces are graduated by a scientific Point-Face System never before attempted, which adds greatly to their value. All single line rules thicker than hairline are graduated by one-quarter points up to one point, and by one-half points above one point, whether placed in center or on side of the bodies. Double and Parallel Faces are graded to give uniform color and are also made flush on the body. This assists the compositor in making a neat joint when single cross rules are used in a page. The thickness of the lines are indicated by the figures in brackets, so that printers may know the exact thickness of both face and body, and in ordering two or more kinds of Brass Rules to work together, may be sure of harmonious results. This departure from the rule-o'-thumb method of designing brass rule by standardizing the faces is distinctly an improvement and as important as was the substitution of point bodies for the old irregular bodies of types.

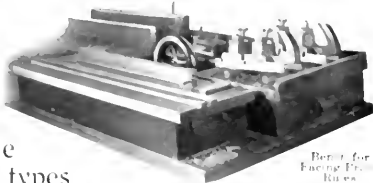

Benet for Engraving Brass Rules

Unexcellable quality is guaranteed to all purchasers of the Brass Materials shown in this section of our catalogue by the use of the very best wearing brass, which is planed, faced or engraved, cut and numbered by special machines of extraordinary precision in charge of skillful operators of long experience. This claim is made in no boastful spirit, for it is simply a matter of good business policy, as the most extensive manufacturers of Brass Materials for printing uses, to lead in quality as well as quantity. Therefore, no effort is spared to maintain our leadership in quality as the surest method of retaining our leadership in output.



Power Machine for Rubbing Edges of Brass Rules After they are Sawed

The faces of Brass Rules and Corners shown in this section need no encomiums, as their merits are displayed in the following specimens, and their variety is such as to meet every requirement of every grade of printing.

Particular attention is given to accuracy of height and accuracy of lengths. The standards and gauges which establish these accuracies are as nearly infallible as anything can be. These accuracies are labor-saving in type composition, facilitating joining of miters, and assist in obtaining equal impression on conjoining pieces of rules or corners, thus saving much time otherwise consumed in make-ready where rules are used which are inaccurately planed or cut. There is nothing in a type form so difficult to underlay and overlay as brass rules; inaccurate brass rules are uneconomical.

Special Faces and Fonts and Matching Faces

Although our assortment of faces and fonts would seem to cover all requirements, we are prepared to match all faces of Brass Rules now in the market on orders of sufficient size, and to make Rules with special thicknesses, widths and line arrangements, and to supply fonts to special schemes.

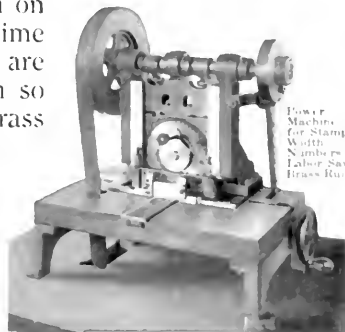

Power Machine for Stamping Widths Numbers on Labor Saving Brass Rules

Brass Rule Shown in Series

Unless otherwise noted, Brass Rules are made in 24-inch strips

Hairline Face in Center			Hairline Face on Side		
NO	BODY	PER FOOT	NO	BODY	PER FOOT
100 ¹ / ₂	¹ / ₂ Point	<u>\$0 05</u>	2001	1 Point	<u>\$0 05</u>
100 ³ / ₅	³ / ₅ Point (20 to pica)	<u>5</u>	2001 ¹ / ₂	1 ¹ / ₂ Point	<u>7¹/₂</u>
100 ⁴ / ₅	⁴ / ₅ Point (15 to pica)	<u>5</u>	2002	2 Point	<u>10</u>
1001	1 Point	<u>5</u>	2003	3 Point	<u>15</u>
1001 ¹ / ₅	1 ¹ / ₅ Point (10 to pica)	<u>6</u>	2004	4 Point	<u>20</u>
1001 ¹ / ₂	1 ¹ / ₂ Point	<u>7¹/₂</u>	2006	6 Point	<u>30</u>
1002	2 Point	<u>10</u>	¼ Point Face in Center		
1003	3 Point	<u>15</u>	1021	1 Point	<u>5</u>
1004	4 Point	<u>20</u>	1021 ¹ / ₂	1 ¹ / ₂ Point	<u>7¹/₂</u>
1005	5 Point	<u>25</u>	1022	2 Point	<u>10</u>
1005 ¹ / ₂	5 ¹ / ₂ Point	<u>27¹/₂</u>	1023	3 Point	<u>15</u>
1006	6 Point	<u>30</u>	1024	4 Point	<u>20</u>
1007	7 Point	<u>35</u>	1026	6 Point	<u>30</u>
1008	8 Point	<u>40</u>	¼ Point Face on Side		
1009	9 Point	<u>45</u>	2021	1 Point	<u>5</u>
10010	10 Point	<u>50</u>	2021 ¹ / ₂	1 ¹ / ₂ Point	<u>7¹/₂</u>
10011	11 Point	<u>55</u>	2022	2 Point	<u>10</u>
10012	12 Point	<u>60</u>	2023	3 Point	<u>15</u>
			2024	4 Point	<u>20</u>
			2026	6 Point	<u>30</u>

Brass Rule Shown in Series

Unless otherwise noted, Brass Rules are made in 24-inch strips

1/2 Point Face in Center

NO	BODY	PER FOOT
1041	1 Point	\$0.05
1041 $\frac{1}{2}$	1 $\frac{1}{2}$ Point	7 $\frac{1}{2}$
1042	2 Point	10
1043	3 Point	15
1044	4 Point	20
1046	6 Point	30

1/2 Point Face on Side

2041	1 Point	5
2041 $\frac{1}{2}$	1 $\frac{1}{2}$ Point	7 $\frac{1}{2}$
2042	2 Point	10
2043	3 Point	15
2044	4 Point	20
2046	6 Point	30

3/4 Point Face in Center

1061 $\frac{1}{2}$	1 $\frac{1}{2}$ Point	7 $\frac{1}{2}$
1062	2 Point	10
1063	3 Point	15
1064	4 Point	20
1066	6 Point	30

3/4 Point Face on Side

2061 $\frac{1}{2}$	1 $\frac{1}{2}$ Point	7 $\frac{1}{2}$
2062	2 Point	10
2063	3 Point	15
2064	4 Point	20
2066	6 Point	30

1 Point Face in Center

NO	BODY	PER FOOT
1081 $\frac{1}{2}$	1 $\frac{1}{2}$ Point	\$0.07 $\frac{1}{2}$
1082	2 Point	10
1083	3 Point	15
1084	4 Point	20
1086	6 Point	30

1 Point Face on Side

2081 $\frac{1}{2}$	1 $\frac{1}{2}$ Point	7 $\frac{1}{2}$
2082	2 Point	10
2083	3 Point	15
2084	4 Point	20
2086	6 Point	30

1 1/2 Point Face on Side

2102	2 Point	10
2103	3 Point	15
2104	4 Point	20
2106	6 Point	30

2 Point Face on Side

2123	3 Point	15
2121	4 Point	20
2126	6 Point	30

2 1/2 Point Face on Side

2143	3 Point	15
2144	4 Point	20
2146	6 Point	30

Brass Rule Shown in Series

Unless otherwise noted, Brass Rules are made in 24-inch strips

Full Face Series No. 115

NO.	BODY	PER FOOT
115 $\frac{1}{2}$	$\frac{1}{2}$ Point	\$0 05
115 $\frac{3}{5}$	$\frac{3}{5}$ Point (20 to pica)	5
115 $\frac{4}{5}$	$\frac{4}{5}$ Point (15 to pica)	5
1151	1 Point	5
1151 $\frac{1}{5}$	1 $\frac{1}{5}$ Point (10 to pica)	6
1151 $\frac{1}{2}$	1 $\frac{1}{2}$ Point	7 $\frac{1}{2}$
1152	2 Point	10
1153	3 Point	15
1154	4 Point	20
1155	5 Point	25
1155 $\frac{1}{2}$	5 $\frac{1}{2}$ Point	27 $\frac{1}{2}$
1156	6 Point	30
1157	7 Point	35
1158	8 Point	40
1159	9 Point	45
11510	10 Point	50
11511	11 Point	55
11512	12 Point	60
11518	18 Point	90

Wave Rules

NO.	BODY	PER FOOT
3082	2 Point	\$0 10
3002	2 Point	10
3012	2 Point	10
3092	2 Point	10
3142	2 Point	10
3152	2 Point	10
3022	2 Point	10
3042	2 Point	10
3043	3 Point	15
3102	2 Point	10
3113	3 Point	15
3123	3 Point	15
3052	2 Point	12
3062	2 Point	12

Rugged Series No. 175

1751	1 Point	5
1751 $\frac{1}{2}$	1 $\frac{1}{2}$ Point	7 $\frac{1}{2}$
1752	2 Point	10
1753	3 Point	15
1754	4 Point	20
1756	6 Point	30
17512	12 Point	60

Brass Rule Shown in Series

Unless otherwise noted, Brass Rules are made in 24-inch strips

Dotted and Hyphen Series

Dotted Rule 1012, 1032 and 1052 will line with and match American Line Brass Leaders Nos. 101, 103 and 105 with the use of leads.

NO	BODY	PER FOOT
1011	1 Point	\$0 05
1031	1 Point	5
1051	1 Point	5
1011½	1½ Point	7½
1031½	1½ Point	7½
1051½	1½ Point	7½
1012	2 Point	10
1032	2 Point	10
1052	2 Point	10
1532	2 Point	10
1072	2 Point	10
1112	2 Point	10
1132	2 Point	10
1401	1 Point	5
1401½	1½ Point	7½
1402	2 Point	10
1403	3 Point	15
1404	4 Point	20
1406	6 Point	30

Uniform Grade Series

In making these Uniform Grade faces it was not always possible to obtain point faces, but in most cases these rules can be used either with face rules Nos. 2022-2042-2062-2082 (respectively 1-1½-2-3 and 4 point faces) or with fullface rules 35, 45, 1, 1½, 2, 3, 4, 5 and 6 point.

NO	BODY	(FACE)	PER FOOT
1452	2 Point	(1½)	\$0 10
1453	3 Point	(1½)	15
1454	4 Point	(1½)	20
1456	6 Point	(1½)	30
1212	2 Point	(1½)	10
1213	3 Point	(1½)	15
1214	4 Point	(1½)	20
1216	6 Point	(1)	30
1232	2 Point	(1½)	10
1223	3 Point	(1½)	15
1224	4 Point	(1)	20
1226	6 Point	(1½)	30
1256	6 Point	(1½)	30
1232	2 Point	(1½)	10
1233	3 Point	(1)	15
1234	4 Point	(1½)	20
1236	6 Point	(2)	30
1238	8 Point	(2½)	40
12310	10 Point	(3½)	50
12312	12 Point	(1)	60
12318	18 Point	(6)	90

All rules on this page (except dotted rules) are flush on body. The figures in parentheses show the face of the rule in points.

Brass Rule Shown in Series

Unless otherwise noted, Brass Rules are made in 24-inch strips

Uniform Grade Series

These three uniform grade series supplant the old rule-of-thumb faces. They are all made flush on body so that a cross rule of 2 point hair line rule No. 1002 will fit snug against the light line of the rule.

Any of the old faces formerly shown can be obtained on short notice but are not usually carried in stock.

NO.	BODY	PER FOOT
1412	2 Point	\$0 10
1413	3 Point	15
1414	4 Point	20
1415	5 Point	25
1416	6 Point	30
1418	8 Point	40
14110	10 Point	50
14112	12 Point	60
1422	2 Point	10
1423	3 Point	15
1424	4 Point	20
1425	5 Point	25
1426	6 Point	30
1428	8 Point	40
14210	10 Point	50
14212	12 Point	60
1432	2 Point	10
1433	3 Point	15
1434	4 Point	20
1435	5 Point	25
1436	6 Point	30
1438	8 Point	40
14310	10 Point	50
14312	12 Point	60

Point Face Series

These rules are made to match regular point face rules, enabling the compositor to use single cross rules to match either the light or heavy line in panel and work of like nature. For instance: 6 point No. 1266 can be made up with 3 point No. 2043 and 3 point Fullface No. 1153. Also 12 point No. 12612 can be made up with 1 and 6 point Fullface rules or with 6 point Fullface and No. 2082 using two point leads between.

NO.	BODY	PER FOOT
1264	4 Point (2-1/2)	\$0 20
1266	6 Point (3-1/2)	30
12612	12 Point (6-1)	60
1274	4 Point (2 1/2-1/2)	20
1276	6 Point (4-1/2)	30
12712	12 Point (8-1)	60
1286	6 Point (4-1)	30
1314	4 Point (2-1)	20
1316	6 Point (3-1)	30
13112	12 Point (6-2)	60
13118	18 Point (9-3)	90
1232	2 Point (3/8)	10
1233	3 Point (1)	15
1244	4 Point (1 1/2)	20
1246	6 Point (2 1/2)	30
1248	8 Point (3)	40
12410	10 Point (4)	50
12412	12 Point (5)	60
12418	18 Point (7)	90

The figures in parentheses show the face of the rule in points

Brass Rule Shown in Series

Unless otherwise noted, Brass Rules are made in 24-inch strips

NO	BODY	PER FOOT
1336	6 Point	30
1338	8 Point	40
13310	10 Point	50
13312	12 Point	60
1343	3 Point	15
1344	4 Point	20
1346	6 Point	30
1348	8 Point	40
13410	10 Point	50
13412	12 Point	60
13418	18 Point	90
1356	6 Point	30
1358	8 Point	40
13510	10 Point	50
13512	12 Point	60
13518	18 Point	90
1396	6 Point	30
1326	6 Point	30
1328	8 Point	40
13210	10 Point	50
13212	12 Point	60

NO	BODY	PER FOOT
1796	6 Point	36
17912	12 Point	72
18212	12 Point	80 72
18218	18 Point	1 08
18112	12 Point	72
18118	18 Point	1 08
18312	12 Point	72
18318	18 Point	1 08
1376	6 Point	30
1378	8 Point	40
13710	10 Point	50
13712	12 Point	60
13718	18 Point	90
1786	6 Point	30
17812	12 Point	60
17818	18 Point	90

Brass Rule Shown in Series

Unless otherwise noted, Brass Rules are made in 24-inch strips

NO.	BODY	PER FOOT
1776	6 Point	\$0 36
17712	12 Point	72
1506	6 Point	30
15012	12 Point	60
15018	18 Point	90
1516	6 Point	30
15112	12 Point	60
15118	18 Point	90
1526	6 Point	30
15212	12 Point	60
15218	18 Point	90
1463	3 Point	15
1464	4 Point	20
1466	6 Point	30
14612	12 Point	60

NO.	BODY	PER FOOT
1766	6 Point	\$0 36
17612	12 Point	72
1482	2 Point	12
1483	3 Point	18
1484	4 Point	24
1486	6 Point	36
1488	8 Point	48
14810	10 Point	60
14812	12 Point	72
1472	2 Point	12
1473	3 Point	18
1474	4 Point	24
1476	6 Point	36
1478	8 Point	48
14710	10 Point	60
14712	12 Point	72

Nos. 1482 to 14812 and 1472 to 14712 are made in 18 inch strips

Brass Rule in Labor-Saving Fonts

Regular Fonts DO NOT contain Miters, Round or Brazed Corners, which are sold separately in Sets, for price of Miters in Fonts and Sets see Tables D and E, page 1108. Charges for Mitering pages are given in Table I. For prices of Labor-Saving Fonts of Rule see page 1105.

2 Point No. 1012

2 Point No. 1052

2 Point No. 1062

This Face Matches

American Line Leader Face

No. 101

This Face Matches

American Line Leader Face

No. 103

This Face Matches

American Line Leader Face

No. 105

See pages 1118 and 1119 for specimens of Brass Round Corners

Hairline Face

1 Point No. 1001
2 Point No. 1002
Face in center

2 Point No. 2002
Face on side

$\frac{1}{4}$ Point Face

2 Point No. 1022
Face in center

2 Point No. 2022
Face on side

$\frac{1}{2}$ Point Face

2 Point
No. 2042

Face on side
of body

See pages 1111 to 1117 for specimens of Brazed Square Corners

$\frac{3}{4}$ Point Face

2 Point No. 2062
3 Point No. 2063
Face on side

2 Point No. 1062
Face in center

1 Point Face

2 Point No. 2082
3 Point No. 2083
Face on side

1 Point No. 1151
Fullface

$1\frac{1}{2}$ Point Face

2 Point
No. 2102

Face on side
of body

Brass Rule in Labor-Saving Fonts

Regular Fonts DO NOT contain Miters, Round or Brazed Corners, which are sold separately in Sets. For prices of Miters in Fonts and Sets see Tables D and E, page 1108. Charges for Mitering pages are given in Table F. For full price list of Labor-Saving Fonts see page 1108.

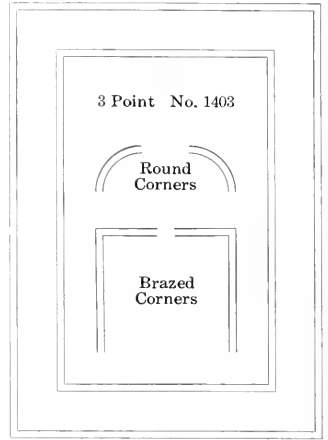
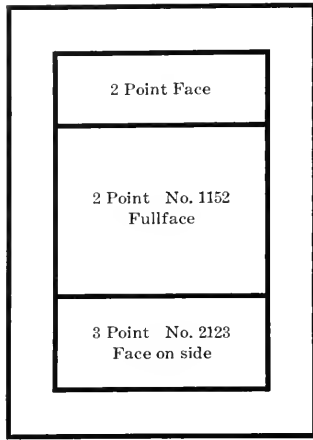
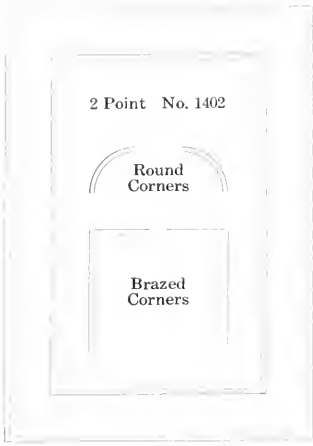

See pages 1118 and 1119 for specimens of Brass Round Corners

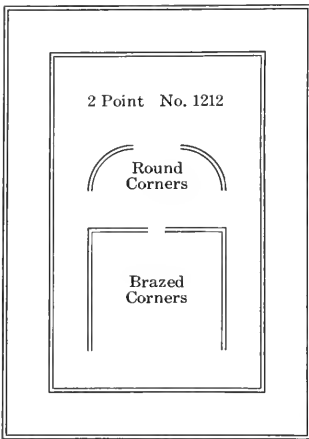

6 Point No. 1216

Prices of Labor-Saving Rule
Fonts DO NOT contain
Miters, Brazed or
Round Corners.

POINT	1 LB FONTS	2 LB FONTS	3 LB FONTS	5 LB FONTS
2	\$1 60	\$3 20	\$4 50	\$7 25
3	1 55	3 00	4 35	6 75
4	1 55	3 00	4 35	6 75
6	1 50	2 90	4 20	6 50

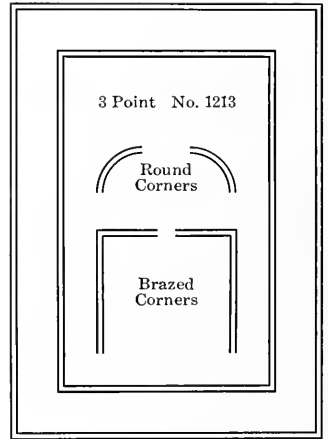

See pages 1114 to 1117 for specimens of Brazed Square Corners

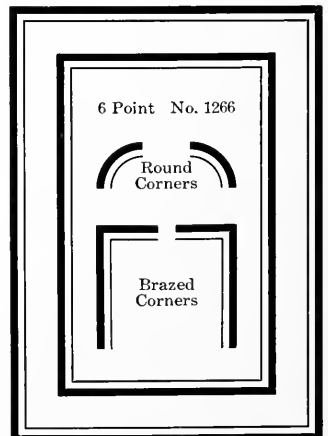
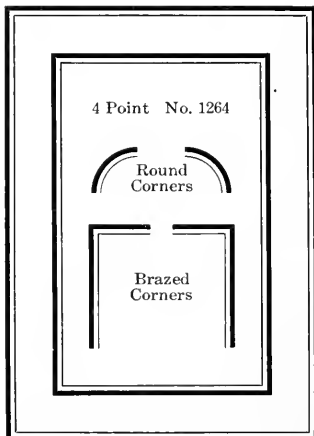
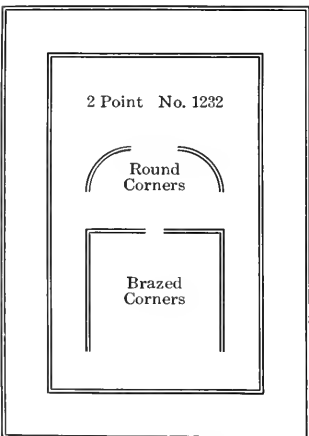

Brass Rule in Labor-Saving Fonts

Regular Fonts DO NOT contain Miters, Round or Brazed Corners, which are sold separately in Sets. For prices of Miters in Fonts and Sets see Tables D and E, page 1108. Charges for Mitering pages are given in Table F. For full price list of Labor-Saving Fonts see page 1108.

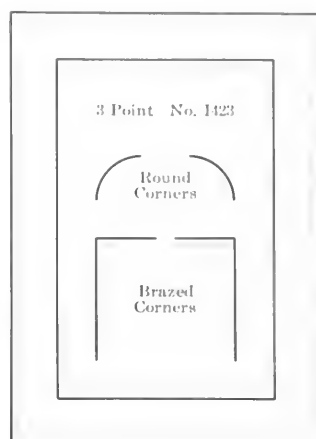
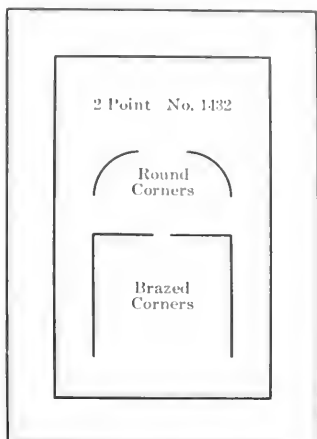
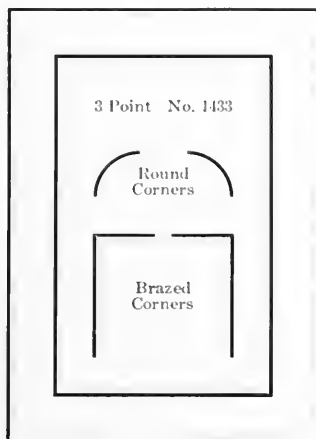

See pages 1118 and 1119 for specimens of Brass Round Corners.

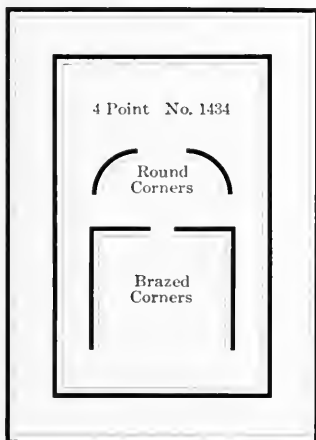

6 Point No. 1226

Prices of Labor-Saving Rule

Fonts DO NOT contain Miters, Brazed or Round Corners.

POINT	1 LB. FONTS	2 LB. FONTS	3 LB. FONTS	5 LB. FONTS
2	\$1 60	\$3 20	\$4 50	\$7 25
3	1 55	3 00	4 35	6 75
4	1 55	3 00	4 35	6 75
6	1 50	2 90	4 20	6 50

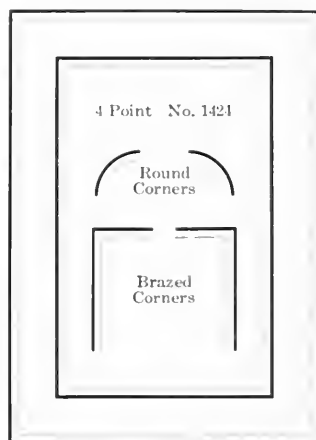

See pages 1114 to 1117 for specimens of Brazed Square Corners.

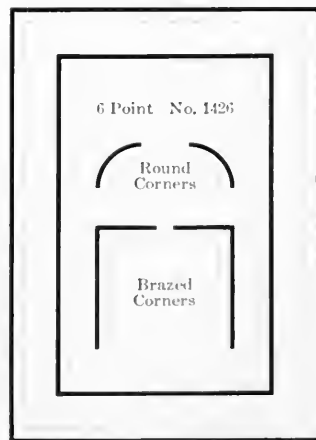
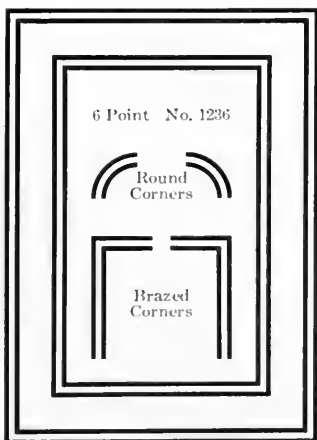
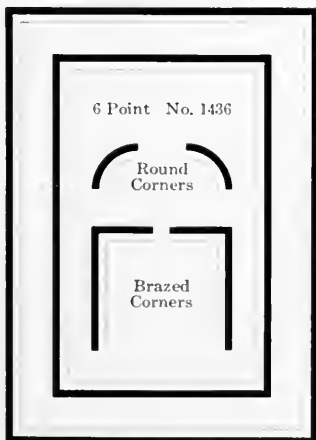

Price List of Brass Rule

STRIP RULE

These list prices are for plain faces only

POINT	1	1 1/2	2	3	4	5	5 1/2	6	7	8	9	10	11	12
1 Foot Price	5c	7½	10	15	20	25	27½	30	35	40	45	50	55	60

Special prices on large quantities. Write for estimates.

LABOR-SAVING FONTS OF BRASS RULE

Regular Fonts DO NOT contain Miters, Round or Brazed Corners, which are sold separately in fonts and sets

These list prices are for plain rule only, and for fonts put up according to our standard schemes. Special scheme fonts differing from our standard schemes, and sorts will be charged according to prices in Tables H and I.

SIZE FONT	1 POINT	1 1/2 POINT	2 POINT	3 POINT	4 POINT	6 POINT	8 POINT	10 POINT	12 POINT
1 Pound	\$2 10	\$1 95	\$1 60	\$1 55	\$1 55	\$1 50	\$1 50	\$1 50	\$1 35
2 Pound	4 00	3 60	3 20	3 00	3 00	2 90	2 90	2 70	2 60
3 Pound	5 70	5 40	4 50	4 35	4 35	4 20	4 20	4 05	3 75
4 Pound	7 40	6 80	6 00	5 60	5 60	5 40	5 40	5 20	5 00
5 Pound	8 75	8 25	7 25	6 75	6 75	6 50	6 50	6 50	6 00

Special prices on large quantities. Write for estimates.

See page 1123 for prices of 18 Point Labor-Saving Rule

TABLE D

Fonts of miters are put up at the following list prices, containing the number of sets as noted: A "set" of miters consists of 4 right and 4 left miters:

POINT	NO. SETS			POINT	NO. SETS		
	2 1/2 EMS	5 EMS	PRICE		2 1/2 EMS	5 EMS	PRICE
1	2	2	\$0 50	6	2	1	\$0 50
1½	2	2	50	7	2	1	50
2	2	2	50	8	2	1	50
3	2	2	50	9	1	1	50
4	2	2	50	10	1	1	50
5	2	1	50	11	1	1	50
5½	2	1	50	12	1	1	50

Larger than 12 point figure "price per piece," according to Tables H and I, on page 1109, plus charges for mitering in Table F, below.

TABLE E

Miters will be sold in single sets from 1 to 6 ems in length at the following list prices per set (4 each right and left):

POINT	PRICE PER SET	POINT	PRICE PER SET	POINT	PRICE PER SET
1	\$0 15	5	\$0 25	9	\$0 40
1½	15	5½	25	10	40
2	15	6	25	11	40
3	15	7	25	12	40
4	15	8	25		

Larger than 12 point figure "price per piece" according to Tables H and I, on page 1109, plus charges for mitering in Table F, below:

TABLE F

Page Miters and Miters Over 6 Ems

Are sold by the "price per piece" as per Tables H and I (page 1109) for length of rule used plus the following list prices per page or set of miters:

PAGES	1 TO 5 1/2 PT. PER PAGE	6 TO 12 PT. PER PAGE	14 TO 18 PT. PER PAGE	OVER 18 PT. PER PAGE
1 to 8	12c	14c	16c	20c
9 to 16	11c	13c	15c	19c
17 to 32	10c	12c	14c	18c
Over 32	9c	11c	13c	17c

TABLE K

Space Rule Fonts

Consisting of all faces and bodies from 1 to 12 Point containing an equal number of each length from 1 em pica to 4 ems pica, inclusive, by ½ em pica. Fonts weigh approximately, 1 pound.

BODY	NUMBER PIECES EACH LENGTH		BODY	NUMBER PIECES EACH LENGTH	
	PER FOOT	PER FOOT		PER FOOT	PER FOOT
1	90	\$4 50	6	15	\$2 10
1½	59	3 40	7	13	2 10
2	45	2 85	8	11	2 00
3	30	2 50	9	10	2 00
4	22	2 30	10	9	1 90
5	18	2 25	11	8	1 80
5½	16	2 15	12	7	1 70

For sorts of space rule see Table H, page 1109

AMERICAN LINE BRASS LEADERS

American Line Leaders are made in three styles. Style 101, a fine dot; style 103, an open dot or short hyphen; style 105, a regular hyphen, which offers a selection varied enough to meet the requirements of all printing offices.

When ordering American Line Leaders give body and style desired.

When ordering leaders to line with any type not on American Line be sure and send sample type H and I, and state style of leaders desired.

For specimens of Brass Leaders see top of page 1105.

LABOR-SAVING FONTS

These list prices are for Regular Scheme Fonts. In the 5-pound fonts the longest piece is 15 ems, and in the 10-pound fonts 20 ems, cut by half ems pica up to 4 ems and even ems pica above 4 ems.

Sorts and special scheme fonts are cut to order and sold at "price per piece" listed in Tables H and I. All bodies other than those listed are cut to order only and sold at "price per piece" listed in Tables H and I, on page 1109.

Fonts of short pieces are listed in Table K.

SIZE FONT	6 POINT	8 POINT	10 POINT	12 POINT
1 Pound	\$1 70	\$1 60	\$1 50	\$1 40
2 Pound	3 40	3 20	3 00	2 80
3 Pound	4 95	4 65	4 50	4 05
4 Pound	6 40	6 00	5 80	5 20
5 Pound	7 75	7 25	7 00	6 50
10 Pound	15 50	14 50	14 00	13 00

Price List of Brass Rule, Brass Leads and Slugs

CUT RULE

Cut Rule include the following which are charged as noted

Sorts of Brass Rule	Tables H and I	Column Rule, Table I, plus the following charges for notehole:
Special Scheme Fonts	Tables H and I	Each notch over to allow for foot, 1/2c extra
Advertising Rules	Table H and I	Each notch under to allow for brass, 1/2c extra
Cross Rules	Table H and I	Each lig for perfecting press, 1/2c extra
Sorts of Space Rule	Table H	Miters over 9 em, and Page Rule, Table H and I, plus charge in Table F.
Head Rules	Table I	
Dash Rules	Tables H and I plus 5 cents	

TABLE H

List Price per 100 pieces. More or less at same rate

EMS PICA	\$0 60	\$0 70	\$0 70	\$0 80	\$1 10	\$1 20	\$1 30	\$1 40	\$1 60	\$1 80	\$1 90	\$2 00	\$2 10	\$2 20	\$ 4 00
1		60	70	80	1 00	1 20	1 40	1 50	1 60	1 90	2 10	2 30	2 40	2 50	2 70
1 1/2		70	80	90	1 10	1 40	1 60	1 70	1 80	2 20	2 40	2 60	2 80	3 00	3 10
2 1/2		70	80	90	1 20	1 50	1 80	1 90	2 00	2 40	2 70	2 90	3 10	3 30	3 40
3		80	90	1 00	1 30	1 70	2 00	2 10	2 20	2 60	2 90	3 20	3 40	3 70	3 80
3 1/2		80	90	1 00	1 40	1 80	2 20	2 30	2 40	2 80	3 20	3 50	3 80	4 10	4 20
4		80	1 00	1 10	1 50	1 90	2 40	2 60	2 70	3 10	3 50	3 80	4 10	4 50	4 60
4 1/2 and 5		90	1 10	1 20	1 70	2 10	2 70	3 00	3 20	3 60	4 00	4 40	4 80	5 20	5 60
5 1/2 and 6		1 00	1 20	1 40	1 90	2 40	3 00	3 30	3 60	4 10	4 60	5 00	5 50	6 00	6 30
6 1/2 and 7		1 00	1 30	1 60	2 10	2 70	3 30	3 70	4 00	4 60	5 20	5 70	6 20	6 60	7 00
7 1/2 and 8		1 10	1 40	1 70	2 30	3 00	3 60	4 10	4 50	5 20	5 80	6 30	6 90	7 30	7 70
8 1/2 and 9		1 20	1 50	1 90	2 50	3 30	4 00	4 40	4 90	5 70	6 40	7 00	7 60	8 10	8 50
9 1/2 and 10		1 20	1 60	2 00	2 70	3 60	4 40	4 90	5 40	6 20	7 00	7 70	8 30	8 70	9 50

TABLE I

List Price per Piece in cents and fractions.

EMS	2	3	4	5	6	7	8	9	10	11	12	13	14	15	16	17
10 1/2 to 12	2	1 1/2	1 1/4	2 1/4	3	4	5	5 1/2	6	7	8	8 1/2	9 1/2	10 1/2	11	12
12 1/2 to 15	2 1/2	1 1/4	2	2 1/4	4	5	6	6 1/2	7 1/2	8 1/2	9 1/2	10 1/2	11 1/2	12 1/2	13 1/2	14 1/2
15 1/2 to 18	3	2	2 1/4	3	4 1/2	5 1/2	7	7 1/2	8 1/2	10	11	12 1/2	13 1/2	15	16	25
18 1/2 to 21	3 1/2	2	3	3 1/2	5	6 1/2	8	9	10	11 1/2	13	14 1/2	16 1/2	17 1/2	18 1/2	29
21 1/2 to 24	4	2 1/4	3	4	5 1/2	7 1/2	9	10	11	13	14 1/2	16 1/2	18	19 1/2	21	33
24 1/2 to 27	4 1/2	2 1/2	3 1/2	4 1/2	6 1/2	8	10	11	12 1/2	14 1/2	16 1/2	18	20	22	23 1/2	36
27 1/2 to 30	5	2 1/2	4	5	7	9	11	12	13 1/2	16	18	20	22	23 1/2	26	40
30 1/2 to 33	5 1/2	2 3/4	4	5 1/2	7 1/2	10	12	13 1/2	15	17 1/2	19 1/2	22	24	26 1/2	28 1/2	44
33 1/2 to 36	6	3	4 1/2	6	8	10 1/2	13	14 1/2	16 1/2	18 1/2	21	23 1/2	26	28 1/2	31	48
36 1/2 to 42	7	4	5	7	10	13	16	17	19	22	25	28	31	31	36	55
42 1/2 to 48	8	4	6	8	11	14	18	19	21	25	28	31	35	38	41	62
48 1/2 to 54	9	5	7	8	12	16	20	22	24	28	31	35	39	43	46	70
54 1/2 to 60	10	5	7	9	13	18	22	24	26	31	35	39	43	47	51	77
60 1/2 to 66	11	6	8	10	15	19	24	26	29	34	38	43	47	52	56	85
66 1/2 to 72	12	6	8	11	16	21	26	28	31	36	41	46	51	56	61	92
72 1/2 to 78	13	6	9	12	17	23	28	31	34	39	45	50	56	61	66	100
78 1/2 to 84	14	7	10	13	18	24	30	33	36	42	48	54	60	66	71	107
84 1/2 to 90	15	7	10	13	20	26	32	36	39	45	51	58	64	70	76	115
90 1/2 to 96	16	8	11	14	21	28	34	38	41	48	55	61	68	75	81	122
96 1/2 to 102	17	8	12	15	22	29	36	41	44	51	58	65	72	79	86	130
102 1/2 to 108	18	8	12	16	23	31	38	43	46	54	61	69	76	84	91	137
108 1/2 to 114	19	9	13	17	25	33	41	46	49	57	65	73	81	89	96	145
114 1/2 to 120	20	9	13	18	26	34	43	48	51	60	68	76	85	93	101	152
120 1/2 to 126	21	10	14	18	27	36	45	50	54	63	71	80	89	98	106	160
126 1/2 to 132	22	10	15	19	28	38	47	52	56	66	75	84	93	102	111	167
132 1/2 to 138	23	10	15	20	30	39	49	54	59	69	78	88	97	107	116	175
138 1/2 to 144	24	11	16	21	31	41	51	56	61	71	81	91	101	111	121	182
2 ft. Strip	24	10	15	20	30	40	50	55	60	70	80	90	100	110	120	180
144 1/2 to 150	25									64	74	85	95	105	116	126
150 1/2 to 156	26									67	77	88	99	110	120	131
156 1/2 to 162	27									69	80	91	102	114	125	136
162 1/2 to 168	28									71	83	94	106	118	129	141

FONTS OF RULE MITERED AT BOTH ENDS

Font No. 1, 4 pieces each length 1 to 25 ems (inside) by ems	\$ 5 10	\$ 6 25	\$ 7 20	\$ 8 40	\$10 25	\$12 90	\$13 90	\$15 80
Font No. 2, 4 pieces each length 1 to 50 ems (inside) by ems	13 55	14 95	20 10	23 25	28 50	35 65	40 45	48 20
Font No. 3, 4 pieces each length 1 to 25 ems (outside) by ems*	5 00	6 00	6 90	7 90	9 60	11 40	12 75	14 40
Font No. 4, 4 pieces each length 1 to 50 ems (outside) by ems*	13 55	16 50	20 00	22 75	27 50	34 20	41 05	47 20

* In Fonts Nos. 3 and 4 the shortest piece in 4, 5 and 6 Point is 2 ems and the shortest piece in 8, 10 and 12 Point is 3 ems. These fonts with miters cut to outside measurements are intended for newspaper use.

Brass Cross Rules and Head Rules

ADVERTISING AND CROSS RULES

Cut any length from any of the faces listed under Head Rules, or any single, double, parallel or triple rule shown in this book.

SIZE	PICA EMS	2 POINT	3 POINT	4 POINT	5 POINT	6 POINT
Single Column	12 ¹ / ₂ to 15	2 ¹ / ₂ c	4c	5c	6c	7 ¹ / ₂ c
Single Column	15 ¹ / ₂ to 18	3	4 ¹ / ₂	5 ¹ / ₂	7	8 ¹ / ₂
Double Column	24 ¹ / ₂ to 27	4 ¹ / ₂	6 ¹ / ₂	8	10	12 ¹ / ₂
Double Column	27 ¹ / ₂ to 30	5	7	9	11	13 ¹ / ₂
Triple Column	36 ¹ / ₂ to 42	7	10	13	16	19
Triple Column	42 ¹ / ₂ to 48	8	11	14	18	21

- No. 1002 _____ 2 Point
- No. 1022 _____ 2 Point
- No. 1042 _____ 2 Point
- No. 1062 _____ 2 Point
- No. 1082 _____ 2 Point
- No. 1402 _____ 2 Point

BRASS HEAD RULES

The following list prices are for any single, double, parallel or triple rule shown in this book. Regular sizes using 13 em column and 6 point column rule. For other bodies and lengths, see Table I on page 1109.

SIZE	PICA EMS	3 POINT	4 POINT	5 POINT	5 1-2 POINT	6 POINT	7 POINT	8 POINT
Four-column	53 ¹ / ₂	\$0 12	\$0 16	\$0 20	\$0 22	\$0 24	\$0 28	\$0 31
Five-column	67	16	21	26	28	31	36	41
Six-column	80 ¹ / ₂	18	24	30	33	36	42	48
Seven-column	94	21	28	34	38	41	48	55
Eight-column	107 ¹ / ₂	23	31	38	43	46	54	61
Nine-column	121	27	36	45	50	54	63	71

- No. 1064 _____ 4 Point
- No. 1403 _____ 3 Point
- No. 1404 _____ 4 Point
- No. 1406 _____ 6 Point
- No. 1454 _____ 4 Point
- No. 1456 _____ 6 Point
- No. 1414 _____ 4 Point
- No. 1415 _____ 5 Point
- No. 1416 _____ 6 Point
- No. 1423 _____ 3 Point
- No. 1424 _____ 4 Point
- No. 1425 _____ 5 Point
- No. 1426 _____ 6 Point
- No. 1434 _____ 4 Point
- No. 1435 _____ 5 Point
- No. 1436 _____ 6 Point

Cutting, Scoring and Perforating Rules

BRASS SCORING RULES

2 Point, per foot	\$0 10	1 Point, per foot	\$0 20
3 Point, per foot	15	6 Point, per foot	30

PRICE LIST OF STEEL CUTTING AND SCORING RULE

Cutting Rules

PRICES PER FOOT	2 POINT	3 POINT	4 POINT	6 POINT
Soft (face in center)	No. 102 10 cents	No. 103 15 cents	No. 101 20 cents	No. 106 25 cents
Soft (face on side)	No. 202 10 cents	No. 203 15 cents	No. 201 20 cents	No. 206 25 cents
Hard, black (face in center)	No. 112 15 cents	No. 113 22 cents	No. 111 30 cents	No. 116 35 cents
Hard, black (face on side)	No. 212 15 cents	No. 213 22 cents	No. 211 30 cents	No. 216 35 cents
Hard, polished (face in center)	No. 122 25 cents	No. 123 35 cents	No. 121 45 cents	No. 126 50 cents
Hard, polished (face on side)	No. 222 25 cents	No. 223 35 cents	No. 221 45 cents	No. 226 50 cents

Scoring or Creasing Rules

PRICES PER FOOT	2 POINT	3 POINT	4 POINT	6 POINT
Soft	No. 132 10 cents	No. 133 15 cents	No. 131 20 cents	No. 136 25 cents
Hard, black	No. 142 15 cents	No. 143 22 cents	No. 141 30 cents	No. 146 35 cents

PRICE LIST OF BRASS LEADS AND SLUGS

POINTS	STRIPS	CUT TO MEASURE	LABOR SAVING
1	\$0 85	\$1 25	\$1 75
1½	80	1 15	1 60
2	75	1 00	1 25
3	75	1 00	1 25
4	75	95	1 20
6	75	95	1 20

Cut to Measure is 10 ems or longer and not less than one pound of a length, otherwise Labor-Saving prices will prevail. A regular Labor-Saving font of 2 point brass leads contains 73 pieces each length 1 to 25 ems inclusive.

PERFORATING RULES

No. 800, brass, 2 point, per foot	\$0 15
No. 801, brass, 3 point, per foot	22½
No. 802, steel, 2 point, per foot	10
No. 803, steel, 3 point, per foot	50
No. 804, steel, 2 point, per foot	10
No. 805, steel, 3 point, per foot	50
No. 806, steel, 2 point, per foot	10
No. 807, steel, 3 point, per foot	50

Steel Perforating Rule also put up in fonts of 4 feet cut to piece ems of assorted lengths. Price per font: 2 point, \$2.00; 3 point, \$2.50.

BRASS RULE FOR ROGERS ATTACHMENT TO THE LINOTYPE

The Rogers Attachment to the Linotype machine casts a slot in the linotype slugs so that this low brass rule (which is one-fifth the height of regular rule) can be inserted in the slug.

2 Point, per foot	\$0 06
2 Point, per pound (56½ feet)	3 00
2 Point, cut labor saving, per pound	4 50
1½ Point, per foot	05
1½ Point, per pound (70 feet)	3 50
1½ Point, cut labor saving, per pound	5 00

STEEL CUTTING RULE



Soft or Hard Black Steel Cutting Rule



Hard and Polished Steel Cutting Rule

PERFORATING RULE



Brass Nos. 800 and 801 Steel Nos. 802 and 803



Steel Nos. 804 and 805



Steel Nos. 806 and 807



2 Point Brass



3 Point Brass

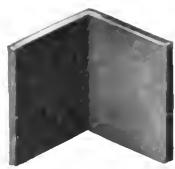

4 Point Brass

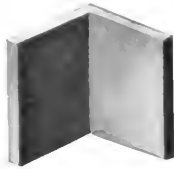

6 Point Brass or Metal

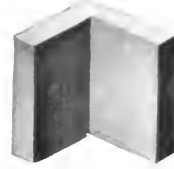

12 Point Brass or Metal

BRASS AND METAL CORNER QUADS



















The use of Corner Quads insures a better junction of mitered corners by preventing them from slipping past each other. They are made in both brass and type metal and sold at the following prices:

Brass Corner Quads, 2, 3 or 4 point body, per set of four	\$0 20
Brass Corner Quads, brazed, 6 point, per set of four	40
Brass Corner Quads, brazed, 12 point, per set of four	75
Metal Corner Quads, 6 or 12 point body, per set of four	15

Brass Dash Rules and Column Rules

BRASS DASH RULES

Cut any length face, from any single, double, parallel or triple rule shown in this book. Prices given below are for dash rules cut 12½ to 15 ems. For other bodies and lengths add 5 cents for each piece to price in Table I on page 1109.

2 Pt. 1002A		7½ cts.	2 Pt. 1002C		7½ cts.
2 Pt. 1002B		7½ cts.	2 Pt. 1002D		7½ cts.
2 Pt. 1082B		7½ cts.	2 Pt. 1082D		7½ cts.
3 Pt. 1403B		9 cts.	3 Pt. 1403D		9 cts.
4 Pt. 1414B		10 cts.	4 Pt. 1414D		10 cts.
2 Pt. 1422B		7½ cts.	2 Pt. 1422D		7½ cts.
3 Pt. 1423B		9 cts.	3 Pt. 1423D		9 cts.
4 Pt. 1424B		10 cts.	4 Pt. 1424D		10 cts.
4 Pt. 1434B		10 cts.	1 Pt. 1434D		10 cts.

BRASS COLUMN RULES

PRICE LIST

Regular sizes using 13 em column
The usual style has a notch over D to allow for Foot Slug

SIZE	IN.	6 FT.	7 FT.	8 FT.	9 FT.	10 FT.
4-column 13¾	\$0 38	\$0 44	\$0 50	\$0 56	\$0 62	
5-column 17¾	48	56	63	71	78	
6-column 19¾	53	62	70	78	87	
7-column 21¾	58	68	77	86	95	
8-column 23¾	63	73	83	93	1 03	
9-column 25¾	69	79	90	1 01	1 12	

Deduct 2 cents from above prices for Column Rules without notch D.

See Table I on page 1109 for prices on other bodies and lengths, to which must be added 2 cents each for notch over D. Notch under for Brass Reglets, 5 cents extra (see Style 12). Lug for perfecting press, 10 cents extra (see Styles 11 to 15). Lug and notch under for perfecting press, 15 cents extra (see Style 12). Prices for all Column Rules are figured on the basis of length over all.

BEVELED LINOTYPE COLUMN RULES

(With notch, as per Style 10)

SIZE	LENGTH	5x6 PT.	6x7 PT.	7x8 PT.
6-column	19¾ in.	\$0 74	\$0 86	\$0 98
7-column	21¾ in.	81	95	1 07
8-column	23¾ in.	88	1 02	1 16

Beveled Column Rules for linotype matter, figure according to Tables H and I for the largest body (5x6 figures as 6 Point). Add 40 per cent for beveling, to which must

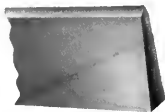

be added 2 cents each for notch over D. Lug for perfecting press, 10 cents extra (see Style 11). Lug and notch under for perfecting press, 15 cents extra (see Style 12). Prices for all Column Rules are figured on the basis of length over all.



Column Rule, Style 10, with Regular Head Rule



Column Rule, Style 11, with Regular Head Rule



Column Rule, Style 12. Head Rule with Brass Slug or Special Grooved Head Rule, Style 4

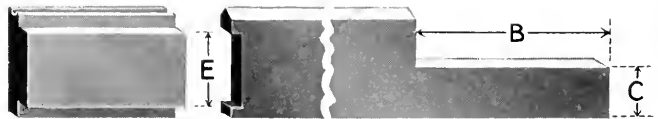

Column Rule, Style 13. Special Grooved Head Rule, Style 5

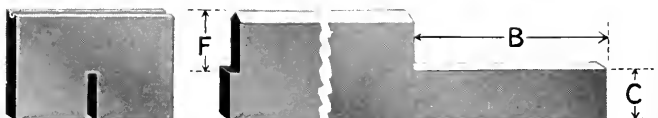

Column Rule, Style 14. Special Notched Head Rule, Style 6

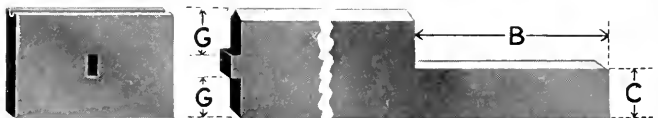

Column Rule, Style 15. Special Notched Head Rule, Style 7

BRASS AND METAL FOOT SLUGS

	Single Column	Double Column		Single Column	Double Column
12 Point, Metal	\$0 04	\$0 06	12 Point, Brass	\$0 15	\$0 25
18 Point, Metal	05	07	18 Point, Brass	20	30
24 Point, Metal	06	08	24 Point, Brass	25	35

Slotted Corners and Mitered Panels

BRASS SQUARE CORNERS

For plain face brass rule. Made like a corner quad and cut from a solid block of brass

The 1 and 1½ Point are brazed with bevel on outside. 1, 1½, 2, 3, 4 and 6 Point, 18 Point Body, per set of four, \$0 35

1 on 3 Pt.
No. 61

1½ on 3 Pt.
No. 11½

2 Point
No. 21

3 Point
No. 31

4 Point
No. 41

8, 10 and 12 Point, 24 Point Body, per set of four

\$0 70

6 Point
No. 61

8 Point
No. 81

10 Point
No. 101

12 Point
No. 121

18 Point
No. 181

12 and 18 Point, 36 Point Body, per set of four \$0 75

12 Point
No. 127

SLOTTED BRASS CORNERS

Per Set of Four: 2 to 6 Point—4-em leg

\$0 35; 6-em leg

\$0 50

2 Point
No. 1152

3 Point
No. 1153

SPECIAL SIZES

4 Point
No. 1154

6 Point
No. 1156

2 Point
No. 1212

3 Point
No. 1213

4 Point
No. 1214

6 Point
No. 1216

Slotted corners can be made to order from any rule. Give total length of leg and length of outside leg. Solid panels like one around this specimen can also be furnished. For price, figure pieces according to prices in Tables H or I and add 30 cents per set or page for slotting. Minimum price, 35 cents per set.

Rule No. 1236. Slotted page this size, 18x34 ems, 79 cents.

See page 1109 for price list of fonts of Panel Rule

PANEL RULE SAVES COMPOSITOR'S TIME—AND THE JOB

MITERED BOTH ENDS

SAMPLE OF PANEL RULE

MITERED BOTH ENDS

One Point Face

2-Pt. RULE 2082

Two Point Body

SHOULDER ON OUTSIDE

Save Time

FOUR PIECES EACH
1 TO 50 EMS

COSTS ONLY
\$13 55 LIST

Save Money

A full size Rule Case holds pieces from 1 to 50 ems. Price \$1 15

Brazed Corners for Brass Rule

BRASS BRAZED CORNERS

The 2, 3 and 4 Point Corners are made 2 by 4 ems pica long

2 Point No. 1002

2 Point No. 1022

2 Point No. 2042

2 Point No. 2062

2 Point No. 2082

2 Point No. 2102

2 Point No. 1402

2 Point No. 1452

2 Point No. 1212

2 Point No. 1232

2 Point No. 1412

2 Point No. 1422

2 Point No. 1432

PRICES

Per Set of Four

2, 3, 4 or 6 Point . . . \$0 50

8, 10 or 12 Point . . . 60

18 Point 75

AMERICAN
TYPE FOUNDERS CO.

3 Point No. 1363

2 Point No. 1362

3 Point No. 1753

2 Point No. 1752

3 Point No. 1213

3 Point No. 1403

3 Point No. 1453

3 Point No. 1223

3 Point No. 1413

3 Point No. 1343

3 Point No. 1233

3 Point No. 1423

3 Point No. 1433

4 Point No. 1214

4 Point No. 1404

4 Point No. 1454

4 Point No. 1224

4 Point No. 1234

4 Point No. 1244

4 Point No. 1274

4 Point No. 1364

4 Point No. 1344

4 Point No. 1754

Brazed Corners for Brass Rule

BRASS BRAZED CORNERS

The 4, 5 and 6 Point Corners are made 2 by 4 ems pica long



4 Point No. 1414



4 Point No. 1424

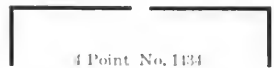

4 Point No. 1434



4 Point No. 1264

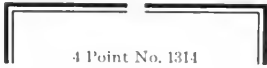

4 Point No. 1314



6 Point No. 1396



5 Point No. 1415

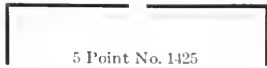

5 Point No. 1425



5 Point No. 1435



6 Point No. 1406



6 Point No. 1456



6 Point No. 1216



6 Point No. 1226

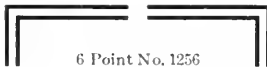

6 Point No. 1256



6 Point No. 1236



6 Point No. 1246



6 Point No. 1286

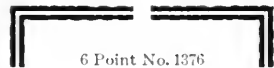

6 Point No. 1376



6 Point No. 1366

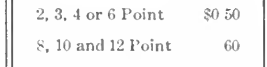

6 Point No. 1796



6 Point No. 1786



6 Point No. 1776



6 Point No. 1766

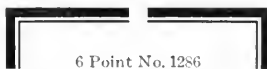

6 Point No. 1526



6 Point No. 1516

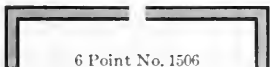

6 Point No. 1506



6 Point No. 1426

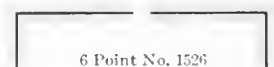

6 Point No. 1436

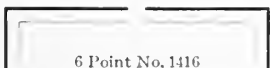

6 Point No. 1416



6 Point No. 1276



6 Point No. 1316



6 Point No. 1266



6 Point No. 1336



6 Point No. 1356

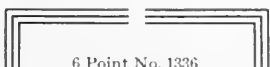

6 Point No. 1336

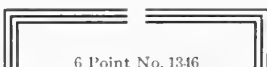

6 Point No. 1346



6 Point No. 1356

PRICES	
Per Set of Four	
2, 3, 4 or 6 Point	\$0 50
8, 10 and 12 Point	60
18 Point	75
AMERICAN TYPE FOUNDERS CO.	

Brazed Corners for Brass Rule

BRASS BRAZED CORNERS

The 8, 10 and 12 Point Corners are made 2 by 4 ems pica long

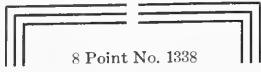

8 Point No. 1338

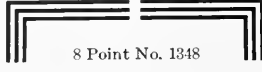

8 Point No. 1348

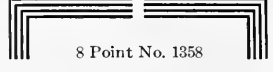

8 Point No. 1358

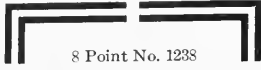

8 Point No. 1238



8 Point No. 1248



8 Point No. 1378



8 Point No. 1418



8 Point No. 1428



8 Point No. 1438

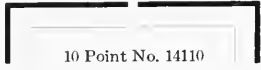

10 Point No. 14110



10 Point No. 14210

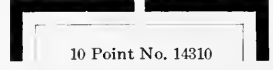

10 Point No. 14310

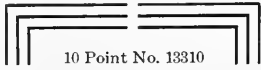

10 Point No. 13310



10 Point No. 13410

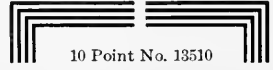

10 Point No. 13510

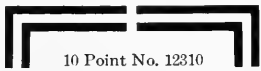

10 Point No. 12310



10 Point No. 12410

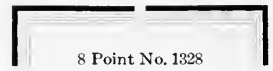

8 Point No. 1328

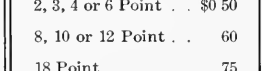

10 Point No. 13210



10 Point No. 13710

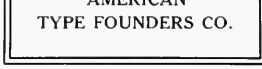

12 Point No. 13212

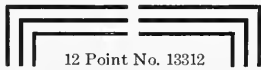

12 Point No. 13312



12 Point No. 13412



12 Point No. 13512

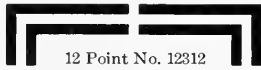

12 Point No. 12312



12 Point No. 12412

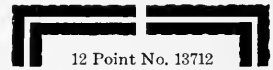

12 Point No. 13712

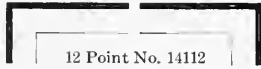

12 Point No. 14112

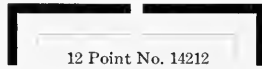

12 Point No. 14212



12 Point No. 14312

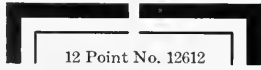

12 Point No. 12612

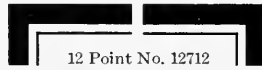

12 Point No. 12712



12 Point No. 13112

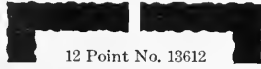

12 Point No. 13612

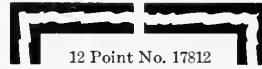

12 Point No. 17812

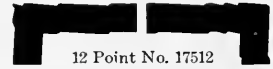

12 Point No. 17512

PRICES	
Per Set of Four	
2, 3, 4 or 6 Point . . .	\$0 50
8, 10 or 12 Point . . .	60
18 Point	75
AMERICAN TYPE FOUNDERS CO.	

Brazed Corners for Brass Rule

BRASS BRAZED CORNERS

12 Point— 2 by 4 ems pica. Per Set of Four, 60c

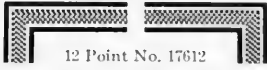

12 Point No. 17612



12 Point No. 17912

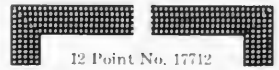

12 Point No. 17712

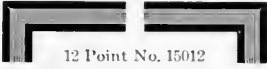

12 Point No. 15012

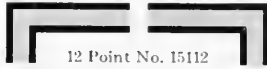

12 Point No. 15112

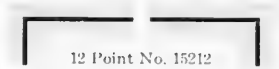

12 Point No. 15212

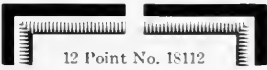

12 Point No. 18112

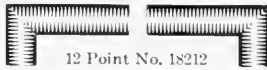

12 Point No. 18212



12 Point No. 18312



18 Point No. 17818

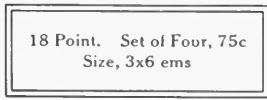

18 Point. Set of Four, 75c
Size, 3x6 ems



18 Point No. 17818



18 Point No. 13418



18 Point No. 13518

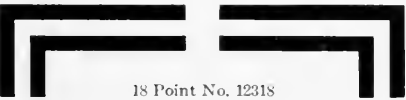

18 Point No. 12318

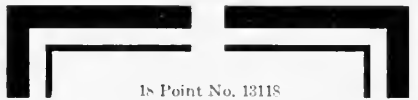

18 Point No. 13118

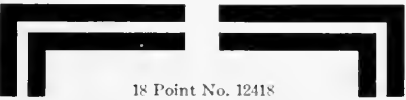

18 Point No. 12418



18 Point No. 13718



18 Point No. 15018



18 Point No. 18118



18 Point No. 15118



18 Point No. 18218

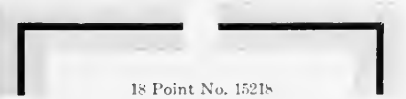

18 Point No. 15218



18 Point No. 18318

Round Corners for Brass Rule

BRASS ROUND CORNERS

Made on 12 Point Solid Body. Per Set of Four, 35 Cents

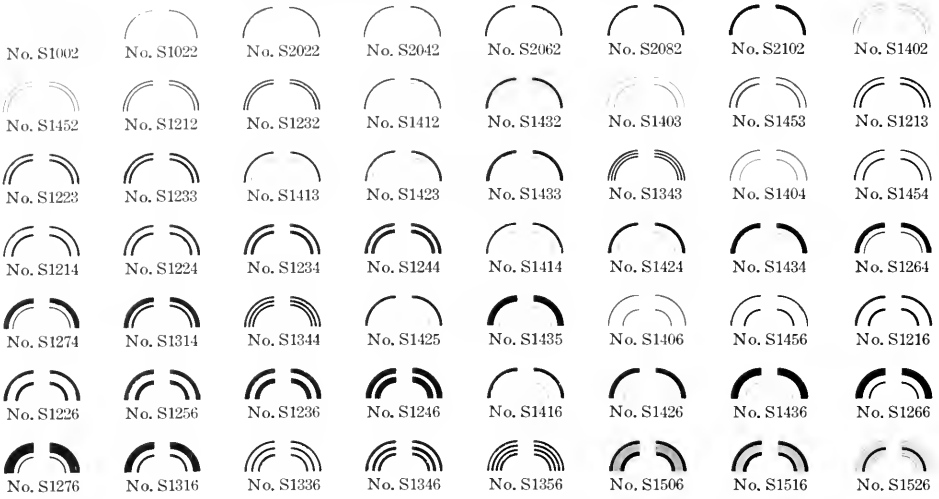

The final figure indicates the body of the rule, viz: Corner S1002 matches 2 Point Brass Rule No. 1002.
Be sure and add the Initial S before the number if Round Corners are desired on 12 Point solid body.

BRASS ROUND CORNERS

18 Point Full Mortised Body. Per Set of Four, 50 Cents

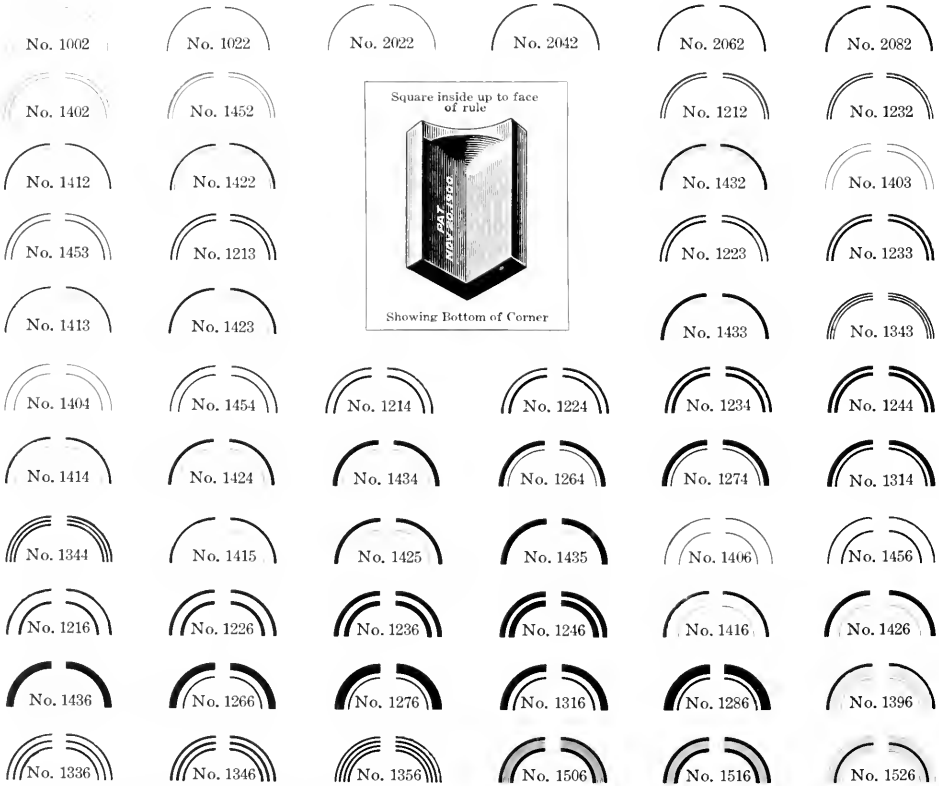

The final figure indicates the body of the rule, viz: Corner No. 1002 matches 2 Point Brass Rule No. 1002.

Round Corners for Brass Rule

BRASS ROUND CORNERS

24 Point Full Mortised Body.

8, 10 and 12 Point. Per set of four \$0 60

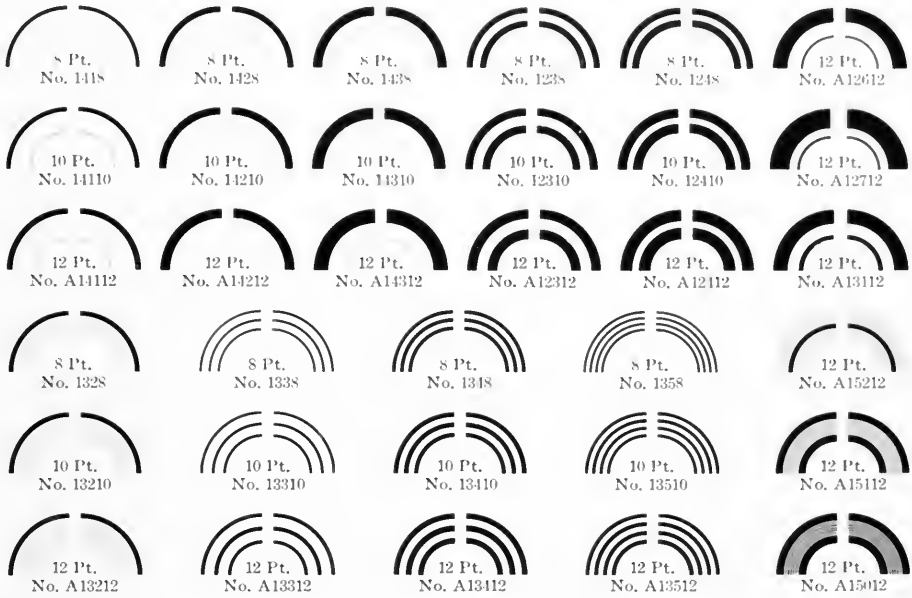

In ordering Round Corners for 12 Point Brass Rule, be sure to add the initial A before the number, if Round Corners are desired on 24 Point body.

36 Point Full Mortised Body.

Per set of four: 12 Point \$0 75; 18 Point \$1 00

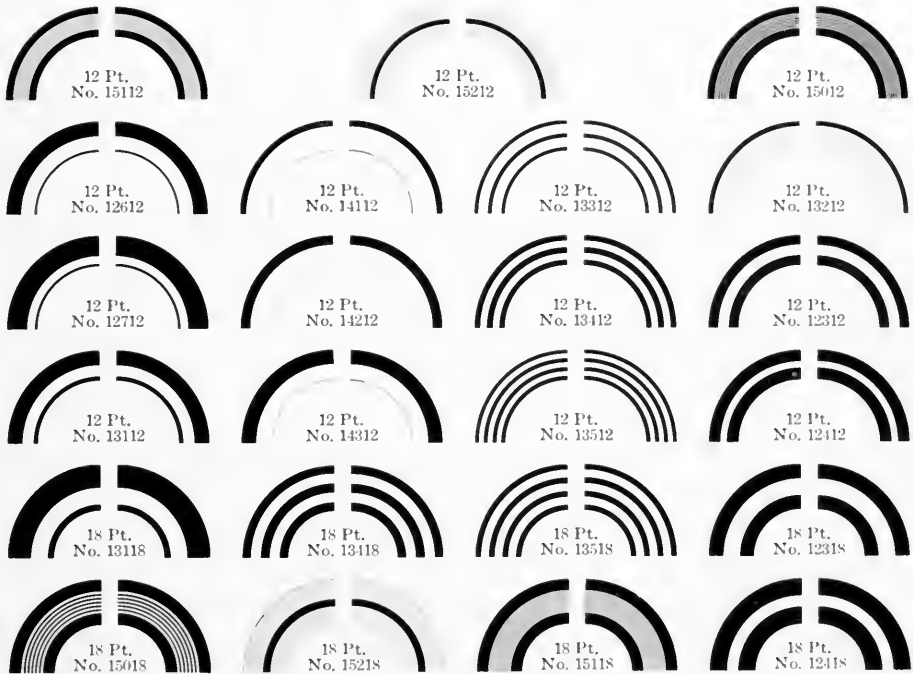

See pages 1122 and 1123 for specimens of Round Corners for Series Nos. 178 and 179

Fullface Brass Round Corners

BRASS ROUND CORNERS

For use with Fullface Brass Rule

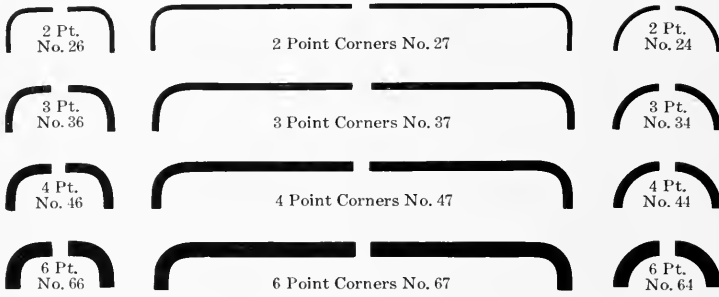
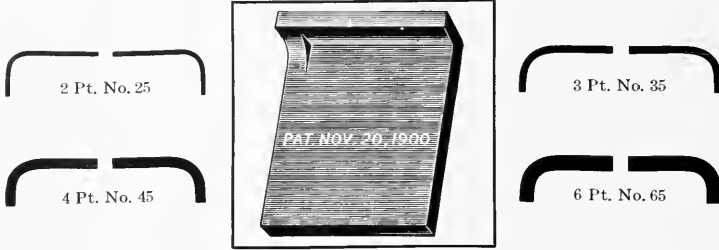

These Corners are $1\frac{1}{2} \times 6\frac{1}{2}$ ems. Two make a single 13-em column.

All of the above Round Corners, per Set of Four, 50 Cents

Round Corners on 12 Point Solid Body



Made on Solid 12 Point Body. Per Set of Four, 35 Cents

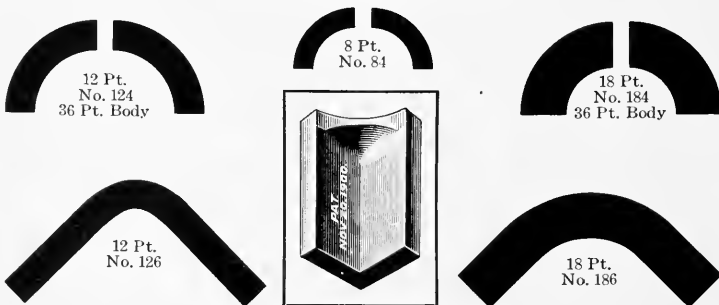
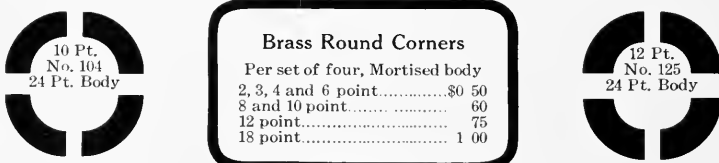

Brass Diagonal Corners and Squares

BRASS DIAGONAL CORNERS
 2, 3, 4 and 6 Point
 Per set of four 35 cents
 12 Point, per set of four 50 cents

2 Pt. No. 22
12 Pt. Body

3 Pt. No. 32
12 Pt. Body

4 Pt. No. 42
12 Pt. Body

6 Pt. No. 62
12 Pt. Body

12 Point No. 122
24 Pt. Body

12 Pt. No. 123
36 Pt. Body

2 Pt. No. 23
18 Pt. Body

3 Pt. No. 33
18 Pt. Body

4 Pt. No. 43
18 Pt. Body

6 Pt. No. 63
18 Pt. Body

BRASS SQUARES

12, 18 and 24 Point, per set of four, 35 cents. 36 Point, 50 cents

OTHER BRASS CORNERS

No. 11
2 point on top
12 point on side
Set of four, 60 cts.

No. 12
2 point on top
6 point on side
Set of four, 60 cts.

No. 13
2 point on top
6 point on side
Set of four, 60 cts.

No. 14
2 point on top
12 point on side
Set of four, 60 cts.

BRASS CENTER PIECES

For use with Plain Face Brass Rule

6 Pt. No. 16
50 cents per pair

6 Pt. No. 17
50 cents per pair

8 Pt. No. 20
50 cents per pair

2 Pt. No. 19
50 cents per pair

4 Pt. No. 18
50 cents per pair

Rugged Brass Rule

6 Point No. 1756

4 Point No. 1754

3 Point No. 1753

2 Point No. 1752

1½ Point No. 1751½

1 Point No. 1751

ROUND CORNERS

1 Point No. 1751

1½ Point No. 1751½

2 Point No. 1752

3 Point No. 1753

4 Point No. 1754

6 Point No. 1756

The 1 and 1½ Point are 1½x6½ ems outside. The body is too thin to allow making the inside square, as in the larger sizes. 1 and 1½ Point corners, per set of four, 50 cents.

The 2, 3, 4 and 6 Point are the regular patented corner, sizes 1½x6½ outside. Price, per set of four, 50 cents. For prices of Labor-Saving Fonts see page 1108.

12 Point
No. 17512
Per set of four
75 cents

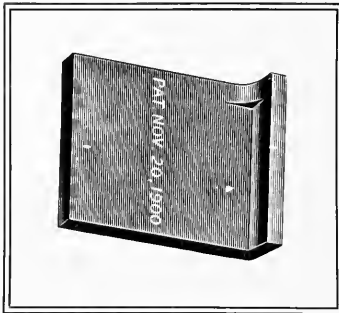

12 Point
No. 13612
Per set of four
75 cents

Labor-Saving Fonts do not contain Miters, Round or Brazed Corners which are sold separately in fonts and sets.

Brazed Corners for these Rugged Rules are made in all bodies, except 1 and 1½ Point. Per set of four, 2, 3, 4 and 6 Point, 50 cents; 12 Point, 60 cents.

Strip Rule is sold at the regular prices per foot as follows: 1 Point, 5 cents; 1½ Point, 7½ cents; 2 Point, 10 cents; 3 Point, 15 cents; 4 Point, 20 cents; 6 Point, 30 cents, and 12 Point, 60 cents.

4 Point No. 1364

6 Point No. 1366

2 Point No. 1362

3 Point No. 1363

1 Point No. 1361

1½ Point No. 1361½

1 Point No. 1361

1½ Point No. 1361½

2 Point No. 1362

3 Point No. 1363

4 Point No. 1364

6 Point No. 1366

Fancy Rule with Round Corners

BRASS ROUND CORNERS

Price, per Set of Four, 6 Point, 50c; 12 Point, 75c; 18 Point, \$1.00

Brass Brazed Corners are made for this rule, and are shown on pages 1114 to 1117. Fonts are put up without Mitters or Round Corners, which are sold separately in sets.

Brass Round Corners for this Series of Rule are on 36 Point mortised body.

For prices of Labor-Saving Fonts of Rule see page 1108

18 POINT RULE

Rule larger than 12 Point is not called for in regular fonts in sufficient quantities to make it advisable to carry regular scheme fonts in stock. It is sold by the piece according to prices in Tables H and I on page 1109.

As a basis for figuring we give below schemes for fonts of 18 Point rule, weighing approximately 3, 5 and 10 pounds.

3 POUND FONT

1 to 4 ems by one-half ems—4 pieces each.
5 to 14 ems by ems—2 pieces each.

The above pieces (see Tables H and I on page 1109), amount to \$4.44.

Mitters (18 Point), 2½ ems pica long inside, would amount to 72 cents per set and 5 em mitters \$1.04 per set, figured from Table H (using outside measure) and the charge for mitering in Table F.

5 POUND FONT

1 to 4 ems by one-half ems—4 pieces each.
5 to 16 ems by ems—3 pieces each.
11 to 18 ems by ems—2 pieces each.

The above pieces (see Tables H and I on page 1109), amount to \$7.05.

10 POUND FONT

1 to 4 ems by one-half ems—4 pieces each.
5 to 18 ems by ems—3 pieces each.
19 to 25 ems by ems—2 pieces each.

The above pieces (see Tables H and I on page 1109), amount to \$13.21.

18 Point No. 17818. Per foot 90 cents

6 Point No. 1786. Per foot 30 cents

12 Point No. 17812. Per foot 60 cents

PRICES OF LABOR-SAVING FONTS

Without Mitters or Round Corners

State whether Mitters or Round Corners are desired, giving number of fonts or sets of Mitters and sets of Round Corners

POINT	6	12	POINT	6	12
1 lb font	\$1 80	\$1 65	Font Mitters	60c	60c
2 lb font	3 50	3 15	Sets of Mitters in Font	3	2
3 lb font	5 05	4 50	Price Single Sets 6 ems and under	30c	45c
5 lb font	7 80	7 20			

6 Point Round Corners, per set of four, 50 cents; 12 Point, 75 cents

6 Point No. 1796. Per foot 36 cents

12 Point No. 17912. Per foot 72 cents

Brass Braces

Complete set, \$5 60

No. 32 30 cts.

No. 31 30 cts.

No. 30 30 cts.

No. 29 30 cts.

No. 28 30 cts.

No. 27 25 cts.

No. 26 25 cts.

No. 25 25 cts.

No. 1 12 cts.

No. 24 25 cts.

No. 2 12 cts.

No. 23 25 cts.

No. 3 12 cts.

No. 22 18 cts.

No. 4 12 cts.

No. 21 18 cts.

No. 5 12 cts.

No. 20 18 cts.

No. 6 12 cts.

No. 19 18 cts.

No. 7 12 cts.

No. 38 12 cts.

No. 18 18 cts.

No. 8 12 cts.

No. 37 12 cts.

No. 17 15 cts.

No. 9 12 cts.

No. 36 12 cts.

No. 16 15 cts.

No. 10 12 cts.

No. 35 12 cts.

No. 15 15 cts.

No. 11 15 cts.

No. 34 12 cts.

No. 14 15 cts.

No. 12 15 cts.

No. 33 12 cts.

No. 13 15 cts.

Sizes of Bodies: Nos. 1 to 15, 6 Point; Nos. 16 to 32, 7 Point; Nos. 33 to 38, 4 Point
Latter made on 6 Point body or heavier, if wanted

Brass Newspaper Dashes

No. 302	.	10 cts.	No. 419	10 cts.
No. 303	.	10 cts.	No. 330	. . .	10 cts.
No. 305	◊	10 cts.	No. 331	◊ ◊	10 cts.
No. 306	●	10 cts.	No. 332	10 cts.
No. 309	.	10 cts.	No. 411	◊	10 cts.
No. 310	●	10 cts.	No. 333	◊ ◊	10 cts.
No. 311	◊	10 cts.	No. 416	◊ ◊	10 cts.
No. 312	◊	10 cts.	No. 334	◊ ◊	10 cts.
No. 409	◊	10 cts.	No. 335	◊	10 cts.
No. 313	◊ ◊	10 cts.	No. 336	◊	10 cts.
No. 314	◊	10 cts.	No. 337	◊ ◊	10 cts.
No. 315	. .	10 cts.	No. 421	◊ ◊	10 cts.
No. 316	. . .	10 cts.	No. 338	◊ ◊	10 cts.
No. 317	◊	10 cts.	No. 339	◊ ◊	10 cts.
No. 319	◊ ◊	10 cts.	No. 340	◊	10 cts.
No. 320	◊ ◊	10 cts.	No. 341	◊ ◊	10 cts.
No. 321	◊ ◊	10 cts.	No. 342	◊ ◊	10 cts.
No. 405	◊ ◊	10 cts.	No. 343	◊ ◊	10 cts.
No. 322	◊ ◊	10 cts.	No. 346	◊ ◊	10 cts.
No. 410	◊	10 cts.	No. 344	◊ ◊	10 cts.
No. 324	◊ ◊	10 cts.	No. 424	◊ ◊	10 cts.
No. 324 ¹ / ₂	◊ ◊	10 cts.	No. 425	◊ ◊	10 cts.
No. 412	◊	10 cts.	No. 426	◊ ◊	10 cts.
No. 411	◊ ◊	10 cts.	No. 348	◊ ◊	10 cts.
No. 328	◊ ◊	10 cts.	No. 355	◊ ◊	10 cts.
No. 329	◊ ◊	10 cts.	No. 357	◊ ◊	10 cts.

All Brass Dashes that are sold for 10 cents each supplied any length for news columns not exceeding 15 ems pica

Brass Circles

BRASS CIRCLES

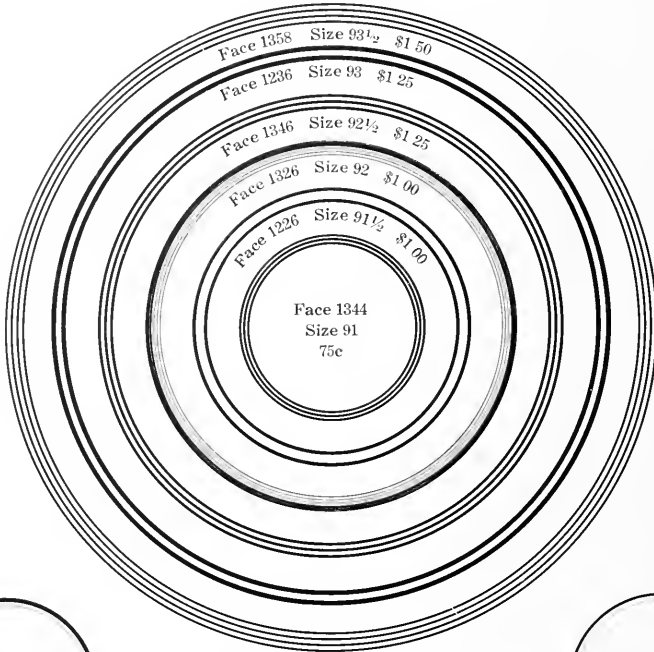

The last figure and fraction in the size number denotes the diameter of the circle in inches.

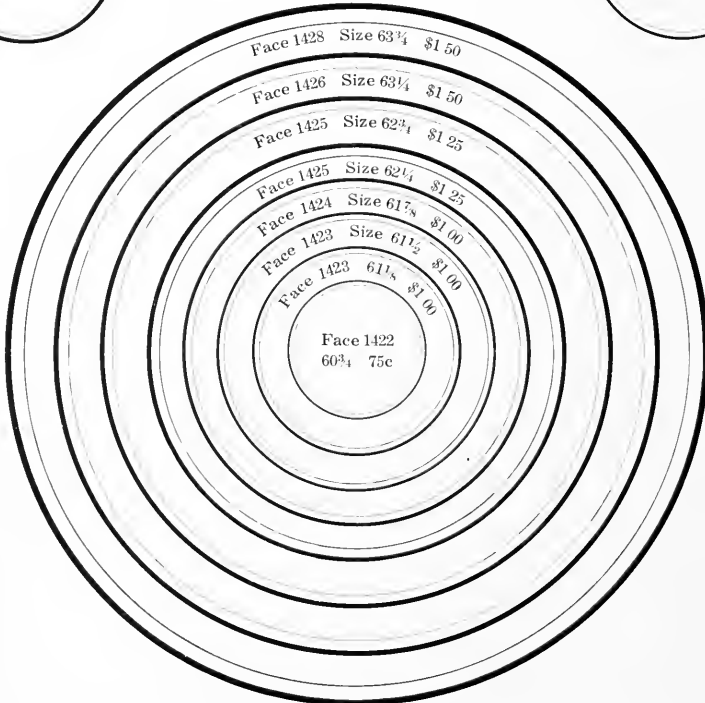

Our Brass Circles are made from seamless brass tubing and can be furnished in one-eighth inch graduations to 2 inches, and in one-quarter inch graduations to 4 $\frac{1}{2}$ inches. Larger or intermediate sizes are brazed. Any face shown in this book can be furnished. Always give face and size when ordering.

Brass Circles and Ovals

BRASS CIRCLES

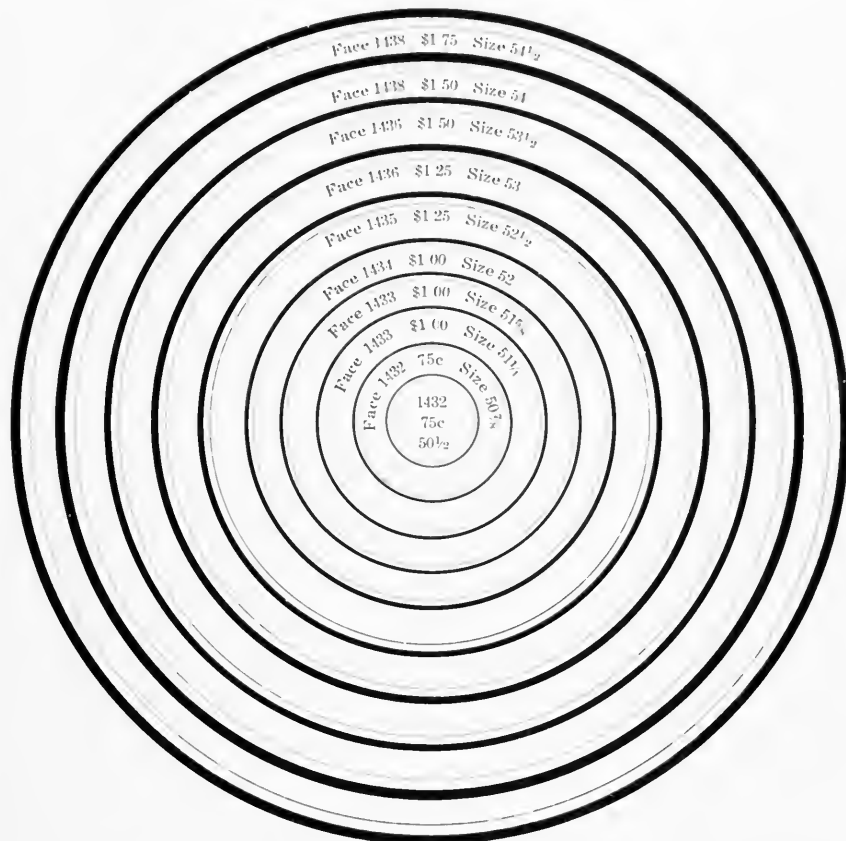

Our Brass Circles are made from seamless brass tubing and can be furnished in one-eighth inch graduations to 2 inches, and in one-quarter inch graduations to 4½ inches. Larger or intermediate sizes are brazed. Any face shown in this book can be furnished to order. Always give *face* and *size* when ordering.

BRASS OVALS

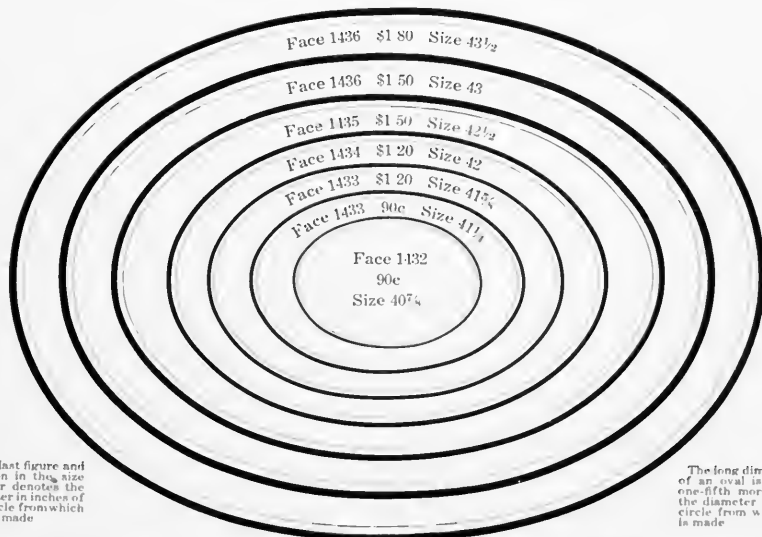

The last figure and fraction in the size number denotes the diameter in inches of the circle from which oval is made.

The long dimension of an oval is about one-fifth more than the diameter of the circle from which it is made.

Brass Circles and Diamonds

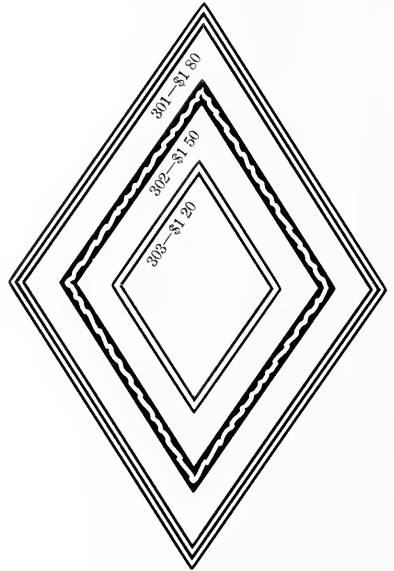
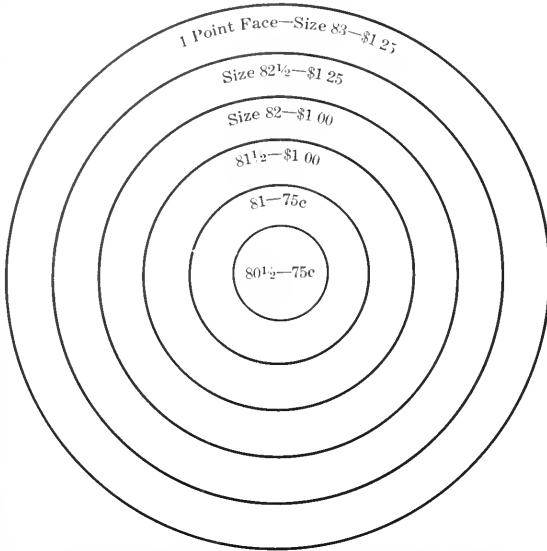

All ovals and diamonds, unless otherwise ordered, will be made in the proportion of 2 by 3, viz: 2 units wide by 3 units long.

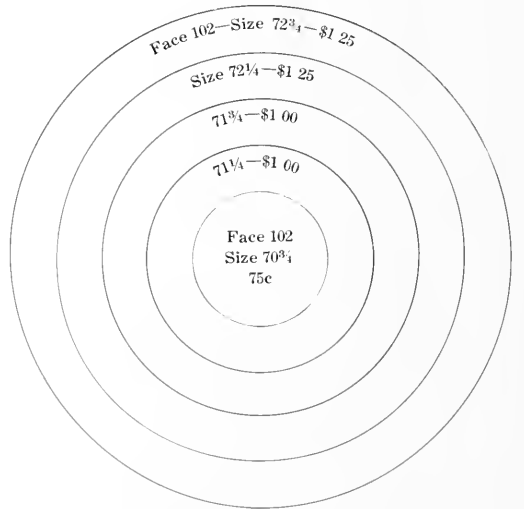
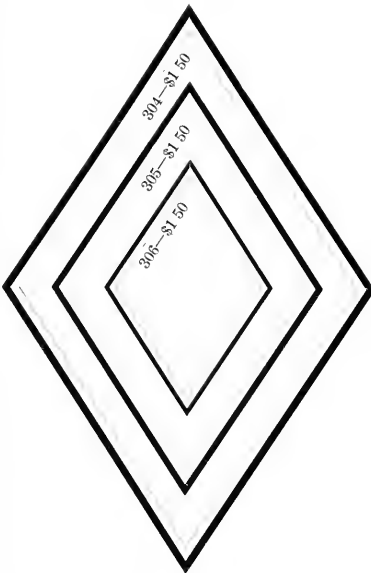

Brass Circles are made from seamless brass tubing and can be furnished in $\frac{1}{8}$ -inch graduations to 2 inches, and in $\frac{1}{4}$ -inch graduations to 4 $\frac{1}{2}$ inches. Larger or intermediate sizes are brazed.

DIAMETER OR LENGTH DIAMETER OF OVALS AND LENGTH OF DIAMONDS IS FIGURED ON THE LONG WAY OF SAME	CIRCLES		OVALS OR DIAMONDS	
	PLAIN RULE	FANCY RULE	PLAIN RULE	FANCY RULE
6 ems and smaller, 1 inch	\$0 75	\$0 90	\$0 90	\$1 00
7 to 12 ems, 2 inches	1 00	1 25	1 20	1 45
13 to 18 ems, 3 inches	1 25	1 60	1 50	1 90
19 to 24 ems, 4 inches	1 50	1 95	1 80	2 35
25 to 30 ems, 5 inches	1 75	2 30	2 10	2 80
31 to 36 ems, 6 inches	2 00	2 55	2 40	3 25
37 to 42 ems, 7 inches	2 25	2 90	2 70	3 70
43 to 48 ems, 8 inches	2 50	3 25	3 00	4 15

Ovals and diamonds, unless otherwise ordered, will be made in the proportion of 2 by 3, viz: 2 units wide by 3 units long.

Special Brass Rule

ADJUSTABLE DOTTED RULE FOR BLANK WORK

For Use With American Line Type

In blank work when large quantities of leaders are necessary it is customary in some offices to use 2 point dotted or hyphen rule justifying with leads. In 8 and 10 point the use of the 2 point rule necessitates the use of a 1 point lead at the bottom for lining the rule with the type. The 2 point side face rule for 8 point type using a 6 point slug to justify and the 4 point center face rule for 10 point type using a 6 point slug to justify saves considerable time. Other examples are also shown. For prices of strip and labor saving rule see page 1108.

Six Point

(Using regular 2 point Dotted Rule No. 1032 with two 2 point leads above rule to justify.)

Eight Point

(Using 4 point Dotted Rule No. 1034 with two 2 point leads to justify, or one 4 point lead.)

Ten Point

(Using Special 3 Point Dotted Rule No. 4033 with two 2 point leads and one 3 point lead to justify.)

Twelve Point

(Using regular 2 Point Dotted Rule No. 1032 with one 2 point lead below rule and one each 2 point lead and 6 point slug above rule.)

Six Point

(Using Special 3 Point Dotted Rule No. 4033 with one 3 point lead to justify.)

Eight Point

(Using Special 2 Point Side Face Dotted Rule No. 2032 with one 6 point slug to justify.)

Ten Point

(Using 4 Point Dotted Rule No. 1034 with one 6 point slug to justify.)

Twelve Point

(Using Special 4 Point Dotted Rule No. 4034 with one 2 point lead below rule and one 6 point slug above rule.)

WE MAKE Brass Rule to fit and work with French Cast Squares, Quadruple Cast Squares, Boston Breton Cast Squares, Cast Panel Pieces, Uniform Rule Cast Corners, etc., as shown in many uses in the display pages of this catalogue. This rule and the various cast corners are great time savers, as the printers having used them will testify.

The American has issued a beautifully printed 32-page booklet entitled "Nuggets" which shows the complete line of Cast Corners, etc., in practical use with Brass Rule.

You may obtain this valuable booklet by writing for it.

INTERLOCKING MITERS FOR BRASS RULE

With regular miters care must be taken to prevent slipping at the corners which can be overcome with use of corner quads when space permits this use. The Interlocking Miter absolutely prevents slipping as the dovetails interlock holding the rules firmly in position. The use of these miters is becoming more general both for special pages and for sets of panel rule.

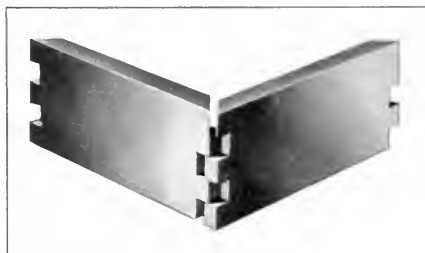

List Prices of Interlocking Miters

These are sold at the price per piece in Tables II and I according to length of rule used plus the following charges for mitering per page or per set of miters.

Pages	1 to 51-2 Ft. Per Page	6 to 12 Point Per Page	14 to 18 Point Per Page	Over 18 Ft. Per Page
1 to 8	\$0 18	\$0 24	\$0 30	\$0 35
9 to 16	17	23	29	31
17 to 32	16	22	28	33
Over 32	15	21	27	32

AMERICAN TYPE FOUNDERS COMPANY

BRASS RULE FOR TYPE BORDERS

Stylus Border	6 Point Rule. Per foot \$0.30
<hr style="border-top: 1px solid black;"/>	
Linear Border No. 2	6 Point Rule. Per foot \$0.45
<hr style="border-top: 1px solid black;"/>	
Linear Border No. 2	12 Point Rule. Per foot \$0.90
<hr style="border-top: 1px solid black;"/>	
Linear Border	6 Point Rule. Per foot \$0.36
<hr style="border-top: 1px solid black;"/>	
Linear Border	12 Point Rule. Per foot \$0.72
<hr style="border-top: 1px solid black;"/>	
Triple Line Border	6 Point Rule. Per foot \$0.30
<hr style="border-top: 1px solid black;"/>	
Triple Line Border	12 Point Rule. Per foot \$0.60
<hr style="border-top: 1px solid black;"/>	
3 Point on 6 Point Mercantile Border No. 49	6 Point Rule. Per foot \$0.30
<hr style="border-top: 1px solid black;"/>	
6 Point Mercantile Border No. 257	6 Point Rule. Per foot \$0.30
<hr style="border-top: 1px solid black;"/>	
12 Point Mercantile Border No. 236	12 Point Rule. Per foot \$0.60
<hr style="border-top: 1px solid black;"/>	
6 Point Monotone Border No. 1	6 Point Rule. Per foot \$0.30
<hr style="border-top: 1px solid black;"/>	
Schuil Border	6 Point Rule. Per foot \$0.30
<hr style="border-top: 1px solid black;"/>	
6 Point Acme Border	6 Point Rule. Per foot \$0.30
<hr style="border-top: 1px solid black;"/>	
12 Point Acme Border	12 Point Rule. Per foot \$0.60
<hr style="border-top: 1px solid black;"/>	
12 Point Panel Border	12 Point Rule. Per foot \$0.60
<hr style="border-top: 1px solid black;"/>	

LABOR SAVING FONTS
 Regular scheme fonts will be furnished at prices on page 1108
 Except Rule for Linear Border

Brass and Copper Thin Spaces

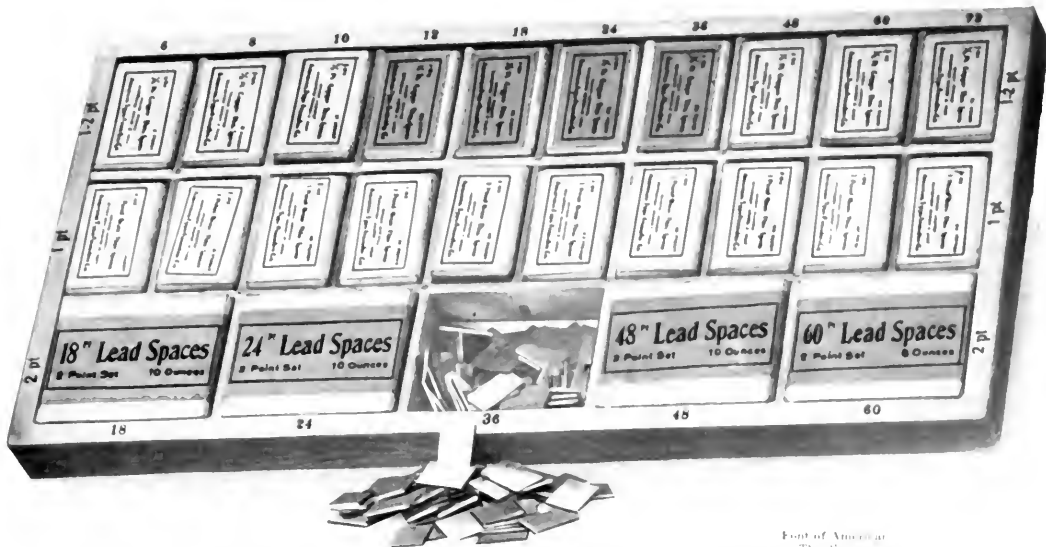

Font of American Thin Spaces

BRASS AND COPPER THIN SPACES

Make justification so easy that no office should be without them

That these 1/2 Point Copper and 1 Point Brass Thin Spaces may be readily distinguished, the 1/2 Point Spaces are made of Copper and the 1 Point Spaces are made of Brass.



Style of Fonts Nos. 1, 2 and 3

Assortment No. 1. 1/2 Point Copper Thin Spaces. This font includes assortment of 6, 8, 10, 12, 14, 16, 18, 20, 21, 30, 36, 42, 48, 60 and 72 Point sizes, put up in wooden case, 16 ounces.

Price, including case \$1 75

Assortment No. 2. 1 Point Brass Thin Spaces. This font includes assortment of 6, 8, 10, 12, 11, 16, 18, 20, 21, 30, 36, 42, 48, 60, and 72 Point sizes, put up in wooden case

Price, including case \$1 75

Assortment No. 3. Assorted 1/2-Point Copper and 1 Point Brass Thin Spaces. This font contains an equal amount of both 1/2 Point Copper and 1 Point Brass Thin Spaces cut to following sizes: 6, 8, 10, 12, 14, 16, 18, 20, 21, 30, 36, 42, 48, 60 and 72 Point, put up in wooden case, 16 ounces.

Price, including case \$1 75

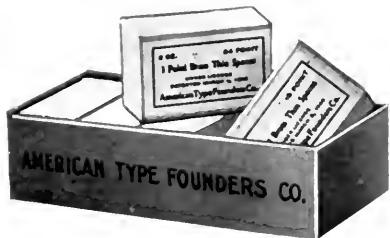

Style of Fonts Nos. 1, 5, 6, 7 and 8

Assortment No. 4. 1/2 Point Copper Thin Spaces. This font includes a two ounce package each 12, 18, 24, 36 and 48 Point, 10 ounces.

Price \$1 00

Assortment No. 5. 1 Point Brass Thin Spaces. This font includes a two ounce package each 12, 18, 24, 36 and 48 Point, 10 ounces.

Price \$1 00

Assortment No. 6. 1/2 Point Copper and 1 Point Brass Thin Spaces. This font includes an assortment of two ounces of each of the following sizes: 12, 18, 24, 36 and 48 Point, 10 ounces.

Price \$1 00

Assortment No. 7. 1/2 Point Copper Thin Spaces. This font includes a two ounce package each 6, 8, 10, 12 and 18 Point, 10 ounces.

Price \$1 25

Assortment No. 8. 1 Point Brass Thin Spaces. This font includes a two ounce package each 6, 8, 10, 12 and 18 Point, 10 ounces.

Price \$1 25



Style of one pound packages

BRASS OR COPPER THIN SPACES

One Pound Packages

5 Point, per pound	\$2 50
5 1/2 Point, per pound	2 25
6 Point, per pound	2 00
7 Point, per pound	1 85
8 Point, per pound	1 75
9 Point, per pound	1 65
10 Point, per pound	1 55
11 Point, per pound	1 45
12, 14 and 16 Points, per pound	1 40
18, 20, 24 and 30 Points, per pound	1 35
36 Point and larger, per pound	1 30

AMERICAN THIN SPACES

Make Justification Easy

The American Thin Spaces include a complete assortment of 1/2 Point Copper and 1 Point Brass Thin Spaces and also of 2 Point Metal Spaces put up in the following proportions.

1/2 Point Copper Thin Spaces. Include two ounces each cut 6, 12, 18, 24, 36 and 48 Point sizes. One ounce each cut 8, 10, 60 and 72 Point sizes. Assortment weighs one pound.

1 Point Brass Thin Spaces. Include two ounces each cut 6, 12, 18, 24, 36 and 48 Point sizes. One ounce each cut 8, 10, 60 and 72 Point sizes. Assortment weighs one pound.

2 Point Metal Spaces. Include ten ounces each 18, 24, 36 and 48 Point sizes. Also eight ounces cut 60 Points. Weighs 3 pounds.

Price complete including Quarter Case \$5 00

Price of case only 65

BRASS TYPE

MANUFACTURED AND FOR SALE BY THE

AMERICAN TYPE FOUNDERS COMPANY



A SPECIMEN Book and Price List of Brass Type, Ornaments and Borders made by the American Type Founders Company will be sent upon application to any one interested. Several of our most popular type faces and ornaments have been reproduced in solid brass and are shown in addition to the many standard faces most used. These faces have proven very popular with bookbinders, box makers and manufacturers of advertising specialties of every description. The advantages of brass type can only be appreciated where special requirements necessitate severe usage. We guarantee our brass type to give the very best satisfaction



American Type Founders

ORIGINATOR OF THE
FAMILY IDEA IN TYPE

Company

EVERYTHING FOR THE
UP-TO-DATE PRINTER

Newspaper Sub-Headings

NEWSPAPER SUB-HEADINGS

Order by Number

Trimmed to 13 ems Pica Electros, Solid Metal Price 75 Cents Each

No. 500
MERITON JOURNAL

No. 501
THE SACONIA NEWS

No. 502
Coshocton Times

No. 503
KIRKER SENTINEL

No. 504
THE BOTANICAL HERALD

No. 505
Steubenville Dispatch

No. 506
ORANGE TRIBUNE

No. 507
The Manchester Enterprise

No. 508
MEREDITH TIMES

No. 509
The Weekly Oregonian

No. 510
SUFFIELD REPORTER

No. 511
New England Republican

No. 512
DAILY TELEGRAM

No. 513
The Stamford Eagle

No. 514
KINGS ADVERTISER

No. 515
MARION TRUTH

No. 516
Northern Transcript

No. 517
SPORTING TRUTH

No. 518
The Evangelical World

No. 519
CONESTON ADVOCATE

No. 520
The Southern Messenger

No. 521
MARLINA COUNTY DEMOCRAT

No. 522
The Religious Intelligencer

No. 523
KEARNY MERIDIAN

No. 524
Windsor Locks Press

No. 525
THE WINNIPESAUKEE PALLADIUM

No. 526
Saturday Evening Bulletin

No. 527
POQUONOCK STATESMAN

No. 528
CENTER HARBOR SIGNAL

No. 529
Minnesota Times-Star

Date Lines and Running Titles for Newspapers

For such lines when made from 10 point Lining Title No. 524 there will be no extra charge for composition. If made from any other type, customer buys the font at regular list price and prevailing discounts, with \$1.00 net added for laying the type, setting the lines and repacking the type, which will then be sent to the customer with the electros, for which the following charges will be made:

Name of paper, four words or less, each	\$0 45
Each day of week	30
Each month of year	30
Each "Vol."	30
Each "No."	30
Each year "1912" or "1911"	30
Each single date, such as "Boston, Mass."	45

Periods, commas or spaces will be cast attached to electros when so ordered without extra charge.

Electrotyped Newspaper Headings

Style No. 400—Six-Line Pica

THE REPORT

Style No. 401—Six-Line Pica

EXCHANGE

Style No. 402—Six-Line Pica

EVENING NEWS

Style No. 403—Six-Line Pica

AMERICAN

Style No. 404—Six-Line Pica

Daily Bugle

Style No. 405—Six-Line Pica

NEWS ECHO

Style No. 406—Six-Line Pica

MICHIGAN BANNER

For additional styles of Newspaper Headings, send for pamphlet containing our complete showing.
It will be mailed gratuitously to anyone requesting it.

Electrotyped Newspaper Headings

Style No. 407—Five-Line Pica

REPORTER

Style No. 408—Six-Line Pica

HOME NEWS

Style No. 409—Six-Line Pica

TELEGRAM

Style No. 410—Six-Line Pica

Oxford Reaper

Style No. 411—Six-Line Pica

EVENING SUN

Style No. 412—Six-Line Pica

TEXAS IDEA

Style No. 413—Six-Line Pica

DAILY ENTERPRISE

For additional styles of Newspaper Headings, send for pamphlet containing our complete showing.
It will be mailed gratuitously to anyone requesting it.

Electrotyped Date Lines

Prices are for any city as per styles below. Length of dotted line about nine picas

Style No. 1 \$1 00		Style No. 2 \$1 00	
<i>Herkert, Pa.,</i>	191	<i>Philadelphia,</i>	191
Style No. 3 \$1 00		Style No. 4 \$1 00	
<i>Concord, Mo.,</i>	191	<i>Simsbury, Ill.,</i>	191
Style No. 6 \$1 00		Style No. 9 \$1 00	
<i>Newark,</i>	191	<i>Chicago,</i>	191
Style No. 7 \$1 00		Style No. 10 \$1 00	
<i>Pittsburgh,</i>	191	<i>Cairo, Ky.,</i>	191
Style No. 8 \$1 00		Style No. 35 \$1 00	
<i>Enfield, Conn.,</i>	191	<i>Brooklyn,</i>	191
Style No. 30 \$1 00		Style No. 36 \$1 00	
<i>Bilexi, Miss.,</i>	191	<i>New Orleans,</i>	191
Style No. 13 \$1 00		Style No. 37 \$1 00	
Buffalo,	191	<i>Trenton,</i>	191
Style No. 14 \$1 00		Style No. 17 \$1 00	
<i>Cleveland, Ohio,</i>	191	<i>Fitchburg, Mass.,</i>	191
Style No. 15 \$1 00		Style No. 16 \$1 00	
<i>Colma, Cal.,</i>	191	<i>Bangor, Me.,</i>	191
Style No. 18 \$1 00		Style No. 21 \$1 00	
Salem, Iowa,	191	Boston,	191
Style No. 19 \$1 00		Style No. 38 \$1 00	
CHICAGO,	191	<i>Keene, N. H.,</i>	191
Style No. 31 \$1 00		Style No. 39 \$1 00	
<i>Pittston, Ky.,</i>	191	<i>Butte, Mont.,</i>	191
Style No. 32 \$1 00		Style No. 40 \$1 00	
Liberty, Mo.,	191	Berlin, Conn.,	191
Style No. 33 \$1 00		Style No. 41 \$1 00	
<i>Utica, Iowa,</i>	191	<i>Bonville, Ind.,</i>	191
Style No. 34 \$1 00		Style No. 42 \$1 00	
<i>Baltimore, Md.,</i>	191	Scranton, Pa.,	191

Electrotyped State Seals

Owing to the great demand for space in this specimen Book and its voluminous size we have been compelled to condense the showing of Electrotyped Cuts. We are printing only a few sample pages here. In order, however, to illustrate and procure whole line, we have issued a separate pamphlet, which contains a complete showing of all the electrotypes made by us, besides several other lines of cuts of interest to printers. We shall be pleased to mail this pamphlet to any customer or to any printer on request.



No. 2775C Indiana 75c



No. 2775C Kentucky 75c



No. 2776C Ohio 75c



No. 4191C Oklahoma 75c



No. 2240C Illinois \$1 00



No. 1 Arizona 75c

We have Seals for all States uniform with the styles shown on this page



No. 2211C Missouri \$1 00



No. 2731C Oregon 75c



Border No. 2751C Center mortised to suit the Seal of any State \$1 50 With Seal of any State \$2 00



No. 2735C Washington 75c



No. 2730C Wyoming 75c



No. 2780C Missouri 75c



No. 2785C California 75c



No. 5000C Texas 75c



No. 3127C Illinois 75c



No. 3137C Kansas 75c

United States Flags

Attention is called to the fact that the United States, and several of the individual States, restrict and prohibit by law, the use of the American Flag, the State Flags and the National and State Coats of Arms for either advertising or business purposes of any nature. All cuts, electrotype or type representations of same, made, sold or offered for sale by the American Type Founders Company are made and sold upon the condition that they are not to be used in any manner prohibited by law.

All Flags supplied for one or two colors In ordering state if cuts are wanted in one or two colors

Old Glory

Embossing Sets

A set includes plates for printing in three colors and an electro embossing die. Flag designs are alike in each set.

- Set A Length (staff) 2 inches; width over all 1 $\frac{3}{4}$ inches . . . \$2 50
- Set B Length (staff) 4 inches; width over all 3 $\frac{3}{4}$ inches . . . 4 50
- Set C Length (staff) 5 $\frac{3}{4}$ inches; width over all 4 $\frac{1}{2}$ inches . . . 6 00



Set A \$2 50
For Embossing

These handsome flags were designed and engraved by the American Type Founders Company. This style is made in three sizes for either one or two colors; the two smallest are shown on this page (No. 5142C, No. 5144C). Dimensions of largest size (No. 5127 $\frac{1}{2}$ C): length of staff 5 inches, width over all 4 inches.



No. 5144C \$1 00

Other Sizes (for dimensions see above)

- No. 5127 $\frac{1}{2}$ C. For one color . . . \$1 50
- No. 5127C. Two colors (size of No. 5127 $\frac{1}{2}$ C) . . . 3 00
- No. 5145C. Two colors (size of No. 5144C) . . . 2 00
- No. 5143C. Two colors (size of No. 5142C) . . . 1 50



No. 5142C 75c



No. 2712C 65c



No. 2709C 40c

A companion flag to No. 2712C is also made, same size and style but with staff to the left. This is No. 2713C.

No. 2712C Right	\$0 65
For two colors	1 25
No. 2713C Left	65
For two colors	1 25



No. 2711C 40c



No. 2969C—Cast in type mould—15c each; Border Font (18 inches) . . . \$1 35
For two colors, 30c per set; Border Font (18 inches) . . . 2 70

Electrotyped United States Emblems

Owing to the great demand for space in this Specimen Book, and to the necessity of showing of Electrotyped Cuts. We are printing only a few sample pages, hereafter, in this line we have issued a separate pamphlet, which contains a complete list of the other lines of cuts of interest to printers. We shall be pleased to read the names of those who desire to purchase any of the cuts here shown.



No. 2213 1/2C 65c



No. 2443C 30c



No. 3453C 75c



No. 3790C 6c

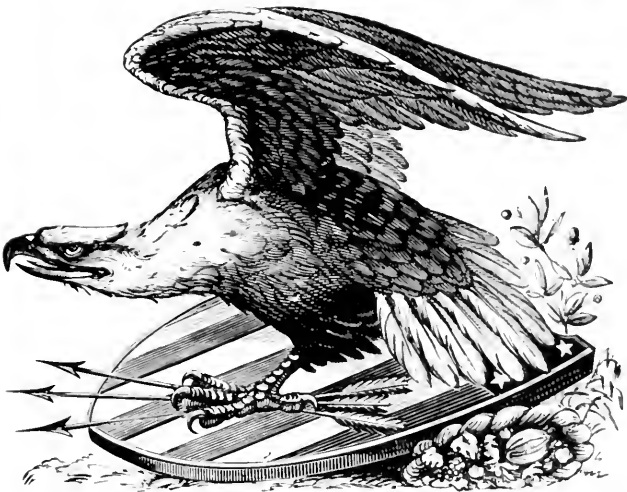

No. 3183C \$1.00

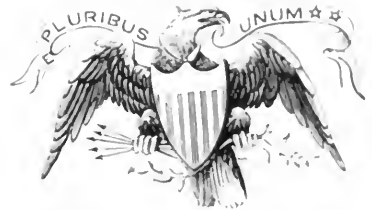

No. 2385C 50c



No. 2471C 40c



No. 857 25c



No. 3460C 25c



No. 3023C 25c

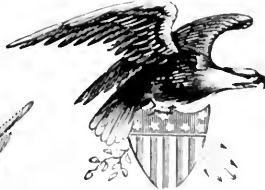

No. 2968C 40c



No. 2441C 40c



No. 2752C 45c



No. 2290 1/2C 60c



No. 2727C 25c

No. 2158C Mortised \$1.25

Electrotyped Society Emblems

Owing to the great demand for space in this Specimen Book and its voluminous size, we have been compelled to condense the showing of Electrotyped Cuts. We are printing only a few sample pages here. In order, however, to illustrate and price our whole line, we have issued a separate pamphlet, which contains a complete showing of all the electrotypes made by us, besides several other lines of cuts of interest to printers. We shall be pleased to mail this pamphlet to any customer or interested printer on request.



No. 3198A 50c

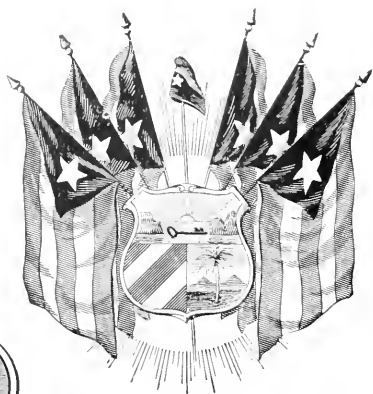

No. 5107C Cuba Libre 75c



No. 1324 50c



No. 3139A 40c



No. 217 30c



No. 3138A 30c



No. 1207 40c



No. 234 50c

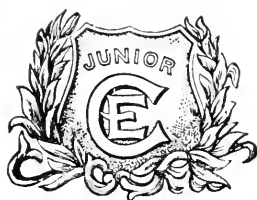

No. 225 40c



No. 3407C 40c



No. 12137C 50c



No. 3658C 30c



No. 3655C 25c

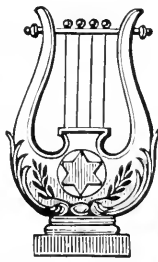

No. 2646C 40c

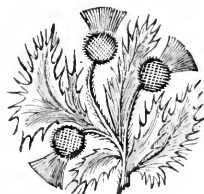

No. 3172A 40c



No. 228 50c

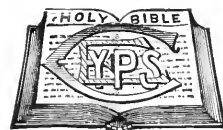

No. 232 40c



No. 2080 25c



No. 3355C 30c



No. 2078 60c



No. 229 35c



No. 3455C 35c



No. 3356C 40c



No. 1225C 30c



No. 3359C 25c



No. 242 35c

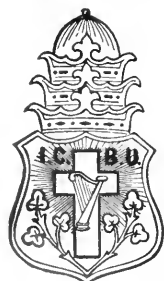

No. 204 40c



No. 224 50c



No. 183 30c



No. 259 50c



No. 203 50c

Electrotyped Society Emblems

Owing to the great demand for space in this Specimen Book, and in order to show the quality of the printing, we are printing only a few sample pages. In the first page of this line, we have issued a separate pamphlet, which contains a complete showing of all the other lines of cuts of interest to printers. We shall be pleased to mail the pamphlet to you on receipt of the price.

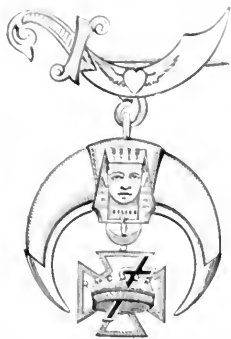

No. 4140C 50c



No. 901 25c



No. 161 30c
For three colors, 30c



No. 916 25c



No. 816 30c



No. 211 30c

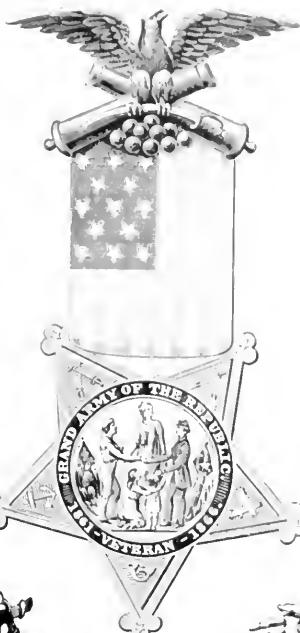

No. 3652C 75c



No. 901 25c



No. 902 30c



No. 179 25c



No. 2943C 25c

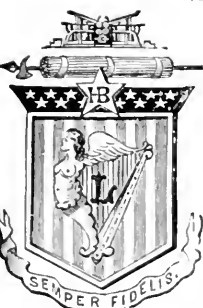

No. 1344 50c



[No. 191] 30c



No. 173 25c



No. 261 35c



No. 217 30c



No. 216 30c



No. 3972C 50c



No. 3659C 30c

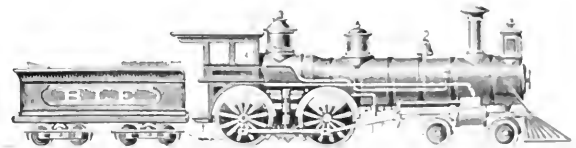

No. 4120C 60c



No. 3092A 30c



No. 3112A 40c



No. 177 25c

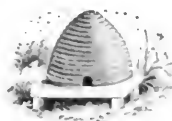

No. 3250C 30c



No. 267 35c



No. 1336 40c

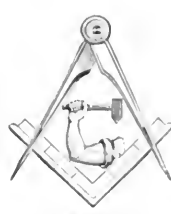

No. 4144C 40c



No. 256 40c



No. 1341 35c

Miscellaneous Electrotyped Cuts

Owing to the great demand for space in this Specimen Book and its voluminous size, we have been compelled to condense the showing of Electrotyped Cuts. We are printing only a few sample pages here. In order, however, to illustrate and price our whole line, we have issued a separate pamphlet, which contains a complete showing of all the electrotypes made by us, besides several other lines of cuts of interest to printers. We shall be pleased to mail this pamphlet to any customer or interested printer on request.



No. 2435C 75c



No. 3928C 75c



No. 2708C 75c

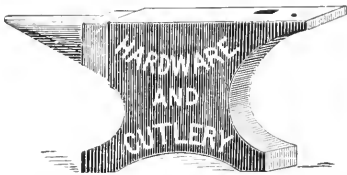

No. 3095C 50c

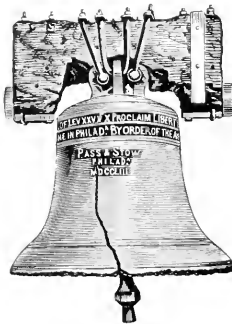

No. 3795C 50c



No. 3410C 60c



No. 3498C Mortised 75c



No. 2425C 30c



No. 2466C 35c

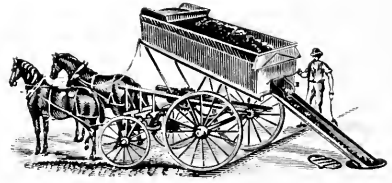

No. 4092C 50c



No. 507 25c



No. 26 25c



No. 868 30c



No. 402C 25c



No. 61C 25c



No. 170 25c



No. 272 35c



No. 2695C 50c

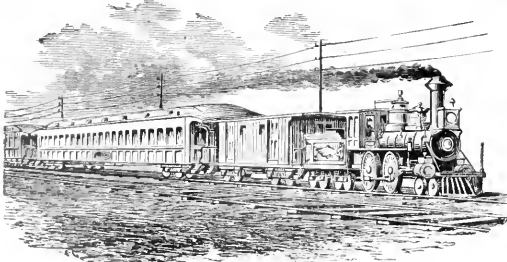

No. 2062 60c

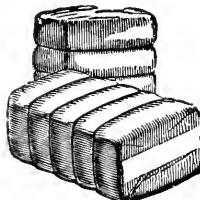

No. 6003C 50c



No. 2356C 40c

Miscellaneous Electrotyped Cuts

Owing to the great demand for space in this Specimen Book and the necessity of showing of Electrotyped Cuts. We are printing on a few sample pages. For a further book, or for cuts at a price per whole line, we have issued a separate pamphlet, which contains a complete list of cuts. The cuts are made by us, but for several other lines of cuts of interest to printers. We shall be pleased to mail this pamphlet to any printer on request.



No. 3944C. 15c each. 75c per dozen

No. 394C. each 30c per dozen. Border four (2 feet) \$1.65

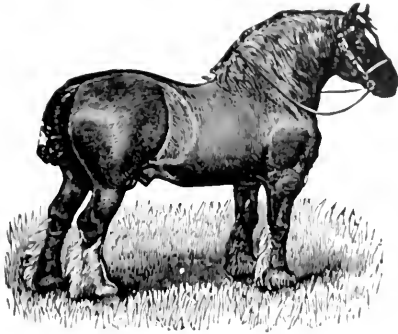

No. 2055 60c



No. 3800C 30c

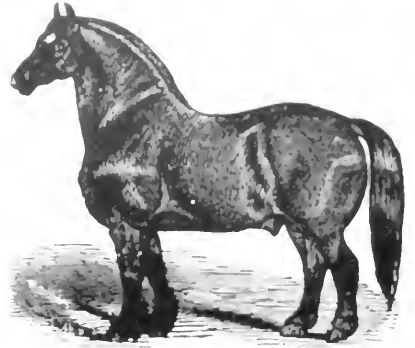

No. 2054 60c



No. 3055C 40c



No. 2929C 60c

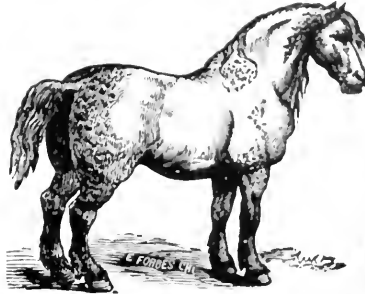

No. 2052 60c



No. 1750A 35c



No. 3054C 75c



No. 4149 40c each
\$4 per dozen



No. 3559 40c



No. 3756C 60c



No. 3037C 40c



No. 3816C 75c



No. 4099 30c each
\$2.50 per dozen

Bill of Fare Cuts

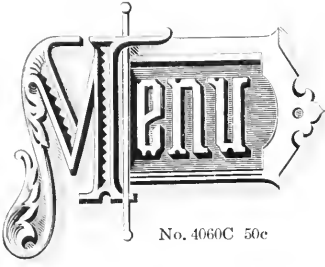

No. 4060C 50c



No. 4070C 50c



No. 4056C 50c

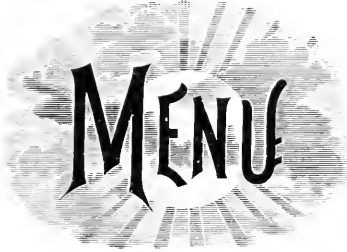

No. 4054C 50c



No. 2997C 60c



4058C 50c



No. 4069C 50c

AMERICAN
TYPE
FOUNDERS
CO.
Complete Printing
Office Outfitter



No. 4065C 60c

TAILPIECES, ETC.



No. 3503C 50c



No. 3872C 40c



No. 3885C 30c



No. 3501C 50c



No. 3866C 40c



No. 3535C 35c



No. 3902C 50c



No. 3867C 40c



No. 3887C 30c



No. 3886C 30c



No. 3881C 50c

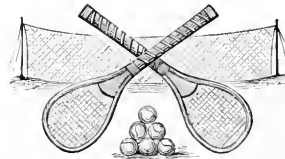

No. 3957C 40c



No. 3146C 40c



No. 3878C 50c

Wood Type and Borders

In addition to the extensive line of Metal Type Faces shown in this catalogue, the American Type Founders Company announces that it can also supply on short notice, any of the designs of type, borders, ornaments, etc., shown in a special Wood Type Catalogue, which will be sent to customers on request. The Wood Type sold by the American Type Founders Company is undoubtedly the best procurable and invariably gives perfect satisfaction whenever used. We show only a few examples here. Any style can be furnished in any size desired, and in the following table we give prices for all sizes up to one hundred lines pica.

SCALE OF FONTS

Showing the Number of Letters in Each Font from 3 A to 5 A

Be sure and state if caps only are wanted, or caps and figures, or caps, lower-case and figures.

3 A	3 a	4 A	4 a	5 A	5 a
CAPS	L. Case	CAPS	L. Case	CAPS	L. Case
75	65	106	90	120	104
Letters Letters Letters Letters Letters Letters					
A -3	a -3	A -4	a -4	A -5	a -5
B -2	b -2	B -3	b -3	B -3	b -3
C -2	c -2	C -3	c -3	C -4	c -4
D -2	d -2	D -3	d -3	D -4	d -4
E -4	e -4	E -5	e -5	E -6	e -6
F -2	f -2	F -3	f -3	F -3	f -3
G -2	g -2	G -3	g -3	G -3	g -3
H -2	h -2	H -3	h -3	H -4	h -4
I -4	i -3	I -4	i -4	I -5	i -5
J -2	j -1	J -3	j -3	J -3	j -2
K -1	k -1	K -2	k -2	K -2	k -2
L -4	l -4	L -5	l -5	L -6	l -6
M -2	m -2	M -3	m -3	M -4	m -4
N -3	n -3	N -4	n -4	N -5	n -5
O -2	o -2	O -3	o -3	O -5	o -5
P -2	p -2	P -3	p -3	P -3	p -3
Q -2	q -1	Q -2	q -2	Q -2	q -2
R -3	r -3	R -4	r -4	R -5	r -5
S -4	s -4	S -5	s -5	S -6	s -6
T -3	t -4	T -4	t -4	T -5	t -5
U -2	u -2	U -3	u -3	U -4	u -4
V -2	v -2	V -3	v -3	V -3	v -3
W -2	w -2	W -3	w -3	W -3	w -3
X -1	x -1	X -2	x -2	X -2	x -2
Y -2	y -2	Y -3	y -3	Y -3	y -3
Z -1	z -1	Z -2	z -2	Z -2	z -2
& -1	fi -1	& -2	fi -1	& -2	fi -1
? -1	fl -1	? -1	fl -1	? -1	fl -1
! -3	ffi -1	! -3	ffi -1	! -3	ffi -1
-3	ffi -1	-4	ffi -1	-4	ffi -1
-1	ffi -1	-2	ffi -1	-2	ffi -1
-1	:	-1	:	-1	:
-2	:	-2	:	-2	:
-1	:	-2	:	-2	:
-3	:	-4	:	-4	:

Figures	1	2	3	4	5	6	7	8	9	0	\$
No. each	3	2	2	2	2	2	2	2	2	5	2
	26 in each Font										

By reference to the Revised Price List and the Scale of Fonts it will be found an easy matter to determine the price of any style of Wood Type in any desired size. First determine the kind of font desired—whether caps only, or caps and figures, or caps, lower case and figures. Then determine the size of font desired, whether 3A's, 4A's or 5A's. When this is determined you will have the total number of characters in the font. See in what class the particular style is listed and find the price per letter. By multiplying the total number of pieces by the price per letter you obtain the list price.

By reference to the Revised Price List and the Scale of Fonts it will be found an easy matter to determine the price of any style of Wood Type in any desired size. First determine the kind of font desired—whether caps only, or caps and figures, or caps, lower case and figures. Then determine the size of font desired, whether 3A's, 4A's or 5A's. When this is determined you will have the total number of characters in the font. See in what class the particular style is listed and find the price per letter. By multiplying the total number of pieces by the price per letter you obtain the list price.

REVISED PRICE LIST PER LETTER

The prices for all sizes of each style of type can be found in this Revised Price List. The left hand column gives size of type or lines pica. The letters L, M, N, etc., at the top of table, give the class to which the letters belong, and the figures in the different columns give the price per letter. The sizes of fonts are given on this page in the Scale of Fonts.

Always state whether CAPS alone are wanted, or CAPS and FIGURES, or CAPS, LOWER-CASE and FIGURES, or CAPS and LOWER-CASE, and how large a font or number of A's.

Wood type is priced by the letter, and sold in various sized fonts, as below. Font orders are subject to a liberal discount; small sort orders are subject to a smaller discount than is allowed on fonts. 3A cap font contains 75 letters; 3a lower-case font contains 65 letters; 4A cap font contains 106 letters; 4a lower-case font contains 90 letters; 5A cap font contains 120 letters; 5a lower-case font contains 104 letters. Figures are put up separately, 26 in each font.

REVISED PRICE LIST PER LETTER

LINES PICA	CLASS L	CLASS M	CLASS N	CLASS O	CLASS P	CLASS Q	CLASS R	CLASS S	CLASS T	CLASS U
	Cents per Letter	Cents per Letter	Cents per Letter	Cents per Letter	Cents per Letter	Cents per Letter	Cents per Letter	Cents per Letter	Cents per Letter	Cents per Letter
2	6	6	6	6	6	6	8	10	13	16
3	6	6	6	6	6	6	8	12	15	18
4	6	6	6	6	6	6	8	12	15	18
5	6	6	6	6	6	8	9	14	17	20
6	6	6	6	6	8	10	11	16	19	22
8	8	8	8	8	10	12	13	18	22	26
10	9	9	10	10	12	15	16	20	25	30
12	10	10	12	12	14	17	18	23	28	32
14	11	12	13	14	16	19	20	26	30	34
15	12	13	14	15	18	21	24	28	32	36
16	12	14	15	16	19	22	25	30	34	38
18	13	15	17	18	21	24	28	33	37	42
20	14	16	18	20	24	28	32	37	40	44
24	17	19	22	24	28	32	36	42	45	48
25	18	20	23	25	30	34	38	45	48	50
30	21	24	27	30	35	40	44	52	55	58
36	28	31	34	36	41	46	50	56	59	62
40	33	36	38	40	45	50	56	60	63	66
45	36	39	42	45	50	58	63	64	67	70
50	45	47	48	50	56	65	70	70	72	74
60	50	53	56	60	66	80	83	86
72	60	62	64	72	78	90	95	100
80	64	66	68	80	86	100	107	114
100	75	78	80	100	106	115	125	135

AMERICAN
TYPE FOUNDERS
COMPANY

Class N

No. 727, 6-Line

6 Cents per Letter

Ramblers 152

Class N

No. 727, 8-Line

8 Cents per Letter

MOUNDS 3

Class N

No. 727, 10-Line

10 Cents per Letter

DRUGS 8

Class N

No. 727, 12-Line

12 Cents per Letter

BUNKS

Lower case and figures made for all sizes. For sizes of fonts and prices of other sizes of wood type see page 1145. For complete showing of other styles and sizes see Specimen Book of Wood Type, which will be sent upon application.

Wood Type

Class O

No. 723, 6-Line

6 Cents per Letter

Homes 32

Class O

No. 723, 8-Line

8 Cents per Letter

BONES

Class O

No. 723, 10-Line

10 Cents per Letter

RUIN

Class O

No. 723, 12-Line

12 Cents per Letter

KOD

Lower case and figures made for all sizes. For sizes of fonts and prices of other sizes of wood type see page 1145. For complete showing of other styles and sizes see Specimen Book of Wood Type, which will be sent upon application.

Class O

No. 728, 6-Line

6 Cents per Letter

Mountains 3

Class O

No. 728, 8-Line

8 Cents per Letter

BINDING

Class O

No. 728, 10-Line

10 Cents per Letter

CRUSH

Class O

No. 728, 12-Line

12 Cents per Letter

DUCK

Lower case and figures made for all sizes. For sizes of fonts and prices of other sizes of wood type see page 1145. For complete showing of other styles and sizes see Specimen Book of Wood Type, which will be sent upon application.

Class O

No. 732, 6-Line

6 Cents per Letter

Diamond 5

Class O

No. 732, 8-Line

8 Cents per Letter

MINES

Class O

No. 732, 10-Line

10 Cents per Letter

ROME

Class O

No. 732, 12-Line

12 Cents per Letter

MEN

Lower case and figures made for all sizes. For sizes of fonts and prices of other sizes of wood type see page 1145. For complete showing of other styles and sizes see Specimen Book of Wood Type, which will be sent upon application.

End-Wood Borders

Put up in fonts of 5 feet, with one set of Corners. For a full-sheet 10 feet of border are required.

21 Point No. 251 Per foot 60c



24 Point No. 259 Per foot 60c

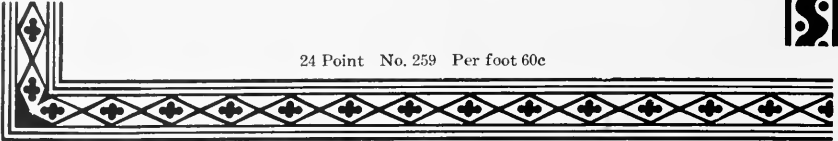

24 Point No. 254 Per foot 60c



24 Point No. 47 Per foot 60c

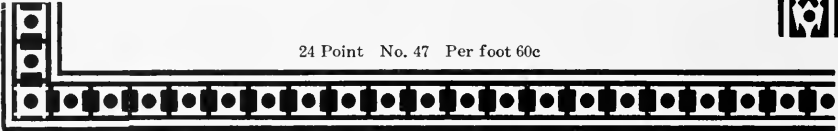

36 Point No. 181 Per foot 70c

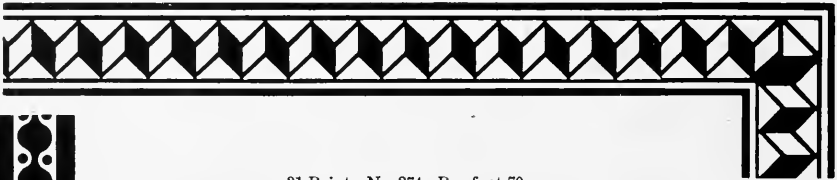

31 Point No. 274 Per foot 70c

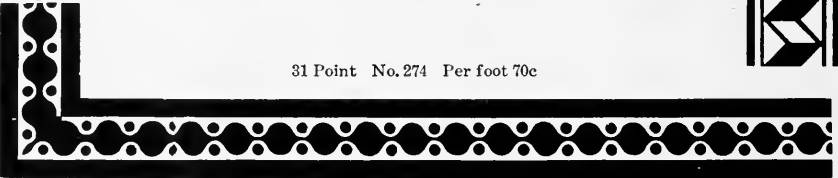

60 Point No. 338 Per foot 90c

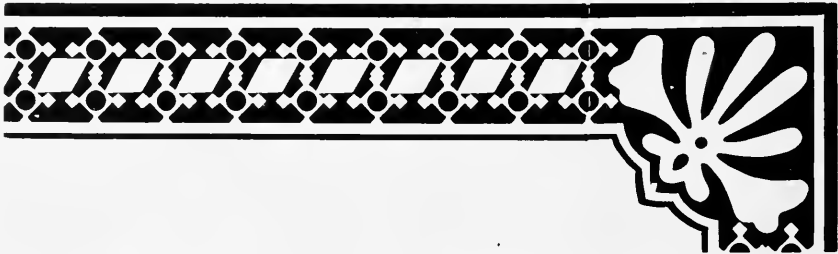

60 Point No. 244 Per foot 90c



For complete line of Wood Borders see Complete Specimen Book of Wood Type. Sent upon application.

End-Wood Borders

END-WOOD BORDERS

Put up in fonts of 5 feet, with one set of corners. For a full-sheet 10 feet of border are required.

No. 251, 60c per foot



No. 130, 60c per foot



No. 188, 80c per foot



No. 56, 80c per foot

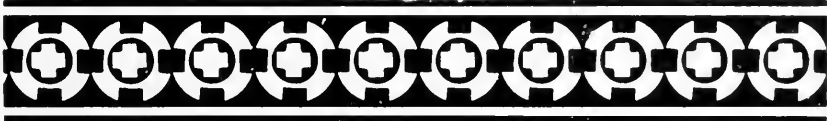

No. 345, 90c per foot

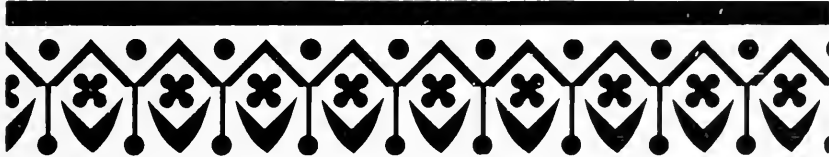

No. 370, \$1.25 per foot

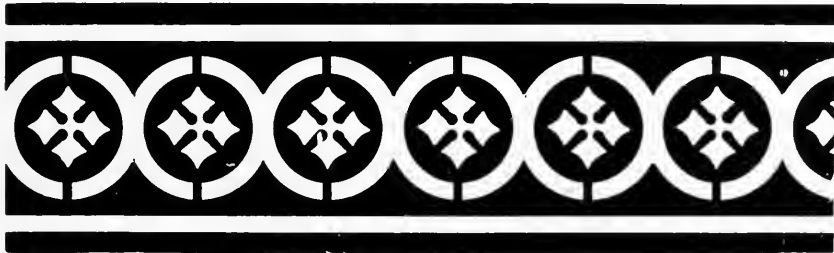

No. 374, \$1.25 per foot

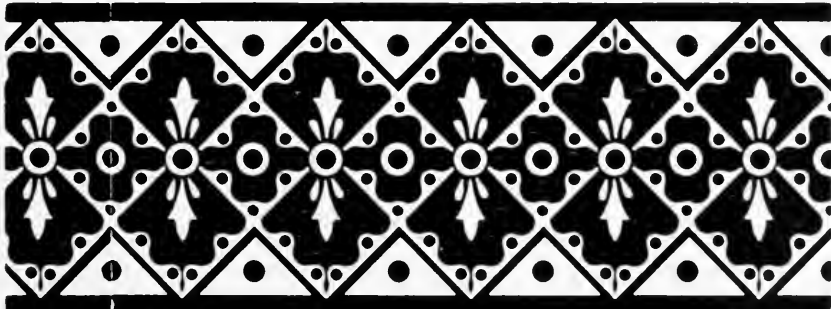

For a complete assortment of Wood Borders see Specimen Book of Wood Type. Sent upon application.

Wood Rule

WOOD RULE

Side-Wood, 12 cents per yard. End-Wood 15 cents per foot—in assorted lengths. End-Wood Rule cannot be supplied in yard lengths. Solid corners to match all sizes, 25 cents per set of four. Wood Rule is sold at a lesser discount than Wood Type.

Style R 12 Point



Style U 18 Point

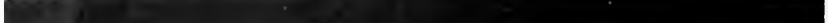

Style W 24 Point



Style Y 36 Point

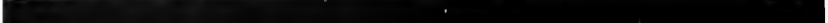

Style H 18 Point



STAR RULE

In fonts of 5 feet with one set of corners, \$1.90. Star Rule cannot be supplied in yard lengths.

No. 20



No. 24



No. 26



No. 30



No. 23



No. 27



No. 31



For other Styles of Wood and Star Rules see complete Specimen Book of Wood Type. Sent on application.

MACHINERY AND SUPPLIES

Discounts

The list prices of Printing Machinery and Supplies are subject in most cases to discounts, which will be quoted on application. The net selling prices are the lowest quoted by the various manufacturers.



This Catalogue is the most extensive and complete ever issued for the use of printers.



All the Machinery and Materials listed herein, which are in regular demand in any section of the United States, are kept in stock, and those in occasional demand can be delivered very promptly, usually from the reserve stocks in the larger Branches.



Due regard for the reputation of its own products and its leadership in the field of Printers' Supplies will not allow the American Type Founders Company to recommend anything that is not of well tested merit



American Type Founders Company

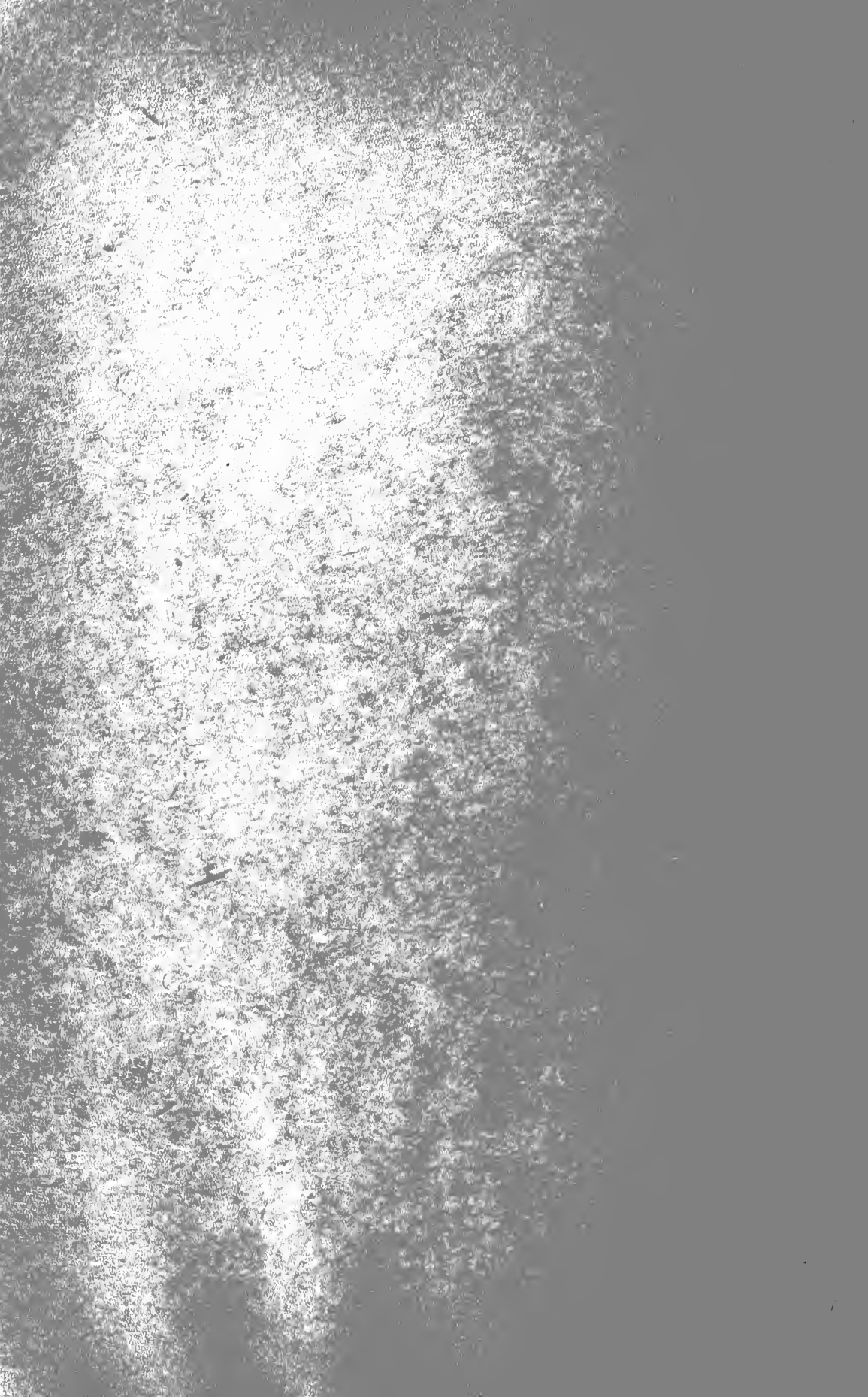

The Premier Two-Revolution Printing Press

The past two decades have seen a great advance in the science and achievement of the printing art, and so urgent have been the consequent demands made on the printing press, that, while all the two-revolution presses now being built may be considered good printing machines, all of them, without exception, have failed to keep pace with the march of printing progress. The reason for this is obvious. Invention is difficult, laborious and time-taking; one cannot turn a spigot and have a novel mechanical idea come forth. Printing-press invention is very much restricted, besides, by the crisscross of claim and description with which inventors have covered their patents already allowed, so that further originality and novelty seem to be almost impossible in any of the basic features of two-revolution presses. Most of the makes of this type of printing press suffer also from the fact that the machines at

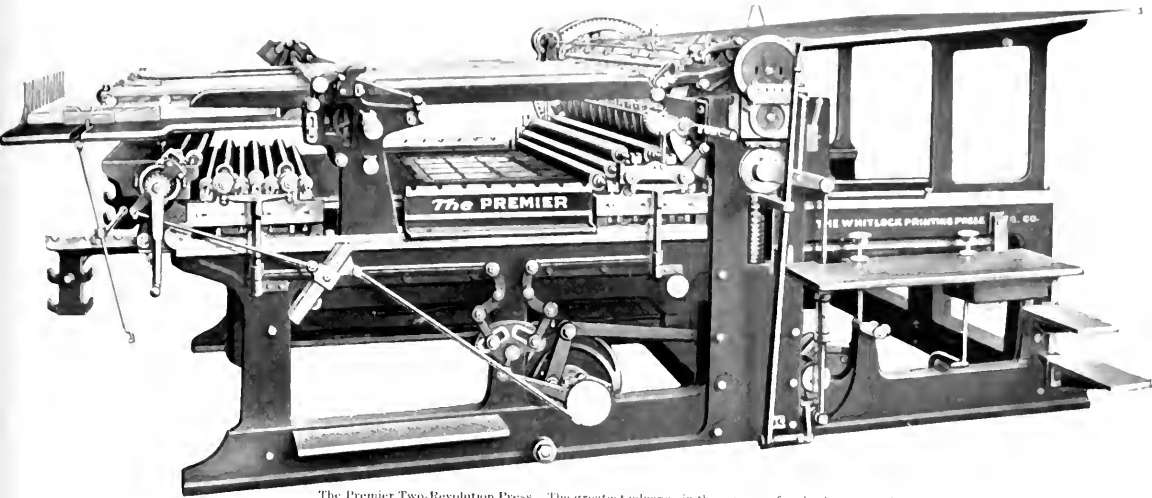

The Premier Two-Revolution Press. The greatest advance in the science of and achievement in the printing art

present built were originally designed from ten to twenty-five years ago, many of the new devices being added from time to time as the manufacturer could invent or design, retaining meanwhile all the weak, inadequate old-fashioned features for the lack of something better. There is but one two-revolution printing press in the market today of entirely new design throughout, fulfilling in every way every demand of the most exacting up-to-date printing, whose every mechanical feature and device has been tried, found successful and standardized, and that is The Premier, of which we are the selling agents.

The builders of The Premier, while studying the situation, noted that, while every other two-revolution press of whatever make—the least liked as well as the most popular—possessed some particular feature of merit and value on which its reputation was based and maintained; noted too, that none of them, not even in the remotest way, filled the requirements of present-day printing conditions. They determined, therefore, to design and build a new series two-revolution, which, while original in some features, would base its greatest claim for preferment in the novel combination into one machine of all the meritorious devices and features found singly in all the other two-revolution presses, these devices when embodied in The Premier being simplified, amplified, strengthened and improved to the very fullest degree. This design has been successfully accomplished and the result, as must be plain to any thinking mind, is a two-revolution press, with the best device or feature for every operating function, all working together to effect a printing production of the highest quality in the greatest quantity with the least waste and at the lowest productive cost.

A terse description of The Premier follows: The side frames are solid. On some two-revolutions the frames look solid but are merely flange frames with the flat surfaces on the outside. The greater strength of the solid frames is obvious. Heavy girders at each end join the frames together, while about midway between them and directly underneath the impression is a girder of tremendous depth and thickness, weighing in the larger sizes from a ton to a ton and a half with a strain resistance unequalled in any other two-revolution press. On these girders four bed tracks are separately bolted—not cast in one piece or spider as is the case in other makes of presses—and these tracks are made wider, thicker and therefore stronger than on other presses. Following the usual practice the tracks are steel shod—high-point carbon steel being used. The bed-track friction rollers also are made of the best steel, are wider than usual and are geared throughout their run. The frame center where the cylinder rests is almost solid throughout, there being but one aperture for the single cylinder lifting spring. This frame structure as a whole is positively unequalled in any other two-revolution press for enduring stability and strain resistance, giving the press mechanism the fullest opportunity to run at its highest speed with the least jar and consequent strain and wear.

The bed motion of The Premier is a direct shaft drive and consists of a lateral segment cast in one piece with the racks, the teeth of the racks

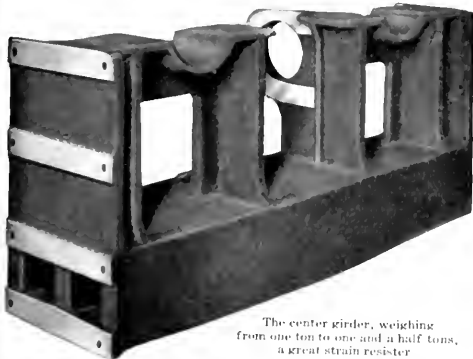

The center girder, weighing from one ton to one and a half tons, a great strain resistor

of an upper and lower bed rack, at each end of which and segments being cut by the gear cutter in the same cut—insuring positive uniformity and accuracy. The bed-driving gear running constantly in one direction engages these racks and segments. This gear is cut away or recessed for a portion of its circumference into which recess is fitted a section of teeth or sector, which alternately recedes from or projects to the gear's circumference to engage or avoid the racks as the bed is moved to and fro by the gear. The bed-gear is not raised or lowered nor slid along the drive shaft before engaging, as on other direct drive two-revolutions, the gear being cast double-width with teeth only on the part of the gear-face which engages the rack—the other part of the gear-face being left blank—excepting where the sector is. Attached to the gear is a Lumen-bronze block with a four or five inch face, sliding in slides or shutters of Jessop steel and assisting to arrest and start the bed movement. The block is obviously better than the roll or rolls generally used—as experiment with any round object will prove. The Premier bed motion is assuredly the best extant. No other is so positive, exact, simple or enduring. It makes for absolute register, high speed, smoothness of operation and a durability and freedom from wear and breaks which no other two-revolution press even approximately equals.

Hundreds of Premier presses have been running for several years now, and never, not even in one single case, has there been the slightest trouble or complaint concerning the bed-drive. We are convinced that this remarkable freedom from the bed-drive troubles so usual to other makes of two-revolution presses will continue for many years to come. The type bed of The Premier is not merely the usual flat surface

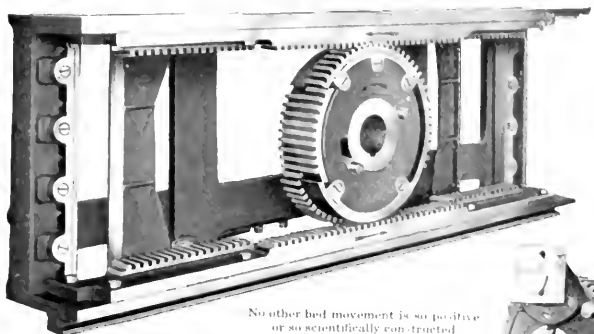

No other bed movement is so positive or so scientifically constructed

The Premier Two-Revolution Printing Press

with ribbing beneath as used on all other presses, but has a bottom as well as a top; it is what is termed a box type bed. The Premier is the only press possessing this valuable feature (being patented). It has more than double the strength of the ordinary type beds. The top surface of all type beds but that of The Premier is only planed and then put into the press. But on The Premier the type bed is scraped absolutely true after it is planed. This, combined with the extreme rigidity of the box type bed, makes a great saving in the time spent in make-ready, as also prolonging the life of type and plates. Runs of hundreds of thousands of impressions from a set of plates are common enough on The Premier to allow us to say they are customary.

The type bed travels on the four bed tracks already mentioned. These tracks are extra wide as stated and are placed so that the two outer ones support the roll of the cylinder on the bed throughout the printing stroke. As register is gotten on all two-revolution presses by the contact of the cylinder bearers with the bed bearers after the impression segments are passed, great pressure of the cylinder on the bed is demanded. The bed tracks on almost all other makes of two-revolution presses are set too much toward the center of the bed to take up the strain of this tremendous pressure correctly, causing the bed to bow considerably, wearing type and plates and causing work-ups in the form. On The Premier the outer tracks are placed directly under the bearers. No further comment is necessary.

The impression mechanism of the two-revolution press particularly because of the two-revolution feature of its construction is undoubtedly the *sine qua non* of the up-to-date printing machine. All other functions are made or marred and the machine as a whole is good as worthless if the impression device is not unyielding. Some presses—even the most popularly sold—have two long rods (sometimes almost four feet long) that pass through the frames (weakening these thereby), which rods are relied on to hold the cylinder rigidly on the bearers. But they fail utterly to do so, as the rods must and do stretch, causing slur, loss of register, wear on plates and type, lost time making ready and renewing or replacing plates. The Premier has an eccentric impression mechanism covered by the span of a man's hand—no rods, no weakening of the frames. A slight turn of the eccentric raises and lowers the cylinder. It is as unyielding as the Rock of Ages. There are four air springs on The Premier—two at each end of the press to assist the bed over centers. On some presses there are but two—one at each end. If there were need to discuss the value of the four over the two air springs we would do so. We think it unnecessary.

The cylinder gear by means of a ring can be moved from one to three teeth forward permitting an increase on the type form printed of two inches or more (the type bed and cylinder impression surface being cast that much larger than the advertised size so as to take the form comfortably and correctly). This important feature is possessed by but a few of the other makes of two-revolution presses. Its value on occasions is incalculable.

There is no outside intermediate pinion between the cylinder gear and the bed driving shaft gear, consequently the very slightest motion of the bed driving shaft is imparted uniformly to both cylinder and bed assuring more exact and enduring register by the elimination of the wear sure to come in the contact points of the intermediate pinion.

The cylinder of The Premier is unquestionably of the strongest construction possible. Almost all other two-revolution presses have printing and idle surfaces well spoked inside the cylinder, but wide gaps in the cylinder surface are left for the shoe-fly gripper and tympan rods. The Premier cylinder surface is closed-cast in that there are no openings for the rods, deep depressions being left in the cylinder surface to allow ample room for the rods and their easy manipulation. As the contact blow between the cylinder and the bed at the point of impression occurs within half an inch of the edge of the impression surface the closed-cast periphery of The Premier cylinder presents an adequate resistance with which the weakness of the open cylinder cannot be compared.

On all two-revolution presses at the commencement of the printing stroke, the cylinder and bed are geared together up to the headline so as to travel at a uniform speed to get register. After the headline is passed, however, the sole reliance for register through the impression is the pressure contact between the bearers on the bed and cylinder. To hold this pressure more certainly and register surer, the bearers on the cylinder and bed of all Premier presses are wider than on all other two-revolution presses, size for size. The gripper mechanism on The Premier is of the most approved type, rotary in its action, strong, taking the sheet without shock and almost noiseless. A safety turn-back device throws the gripper rod back without damage should the press be started while the gripper rod is turned up. There are three tympan rods to draw and hold the make-ready and top sheets at the very highest tension.

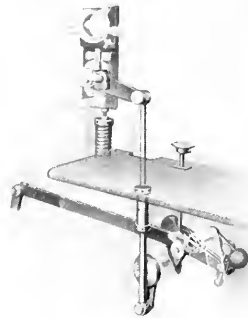

The Wonderful Eccentric Impression Mechanism—the span of a man's hand covers it.

The distribution of The Premier is immeasurably superior to that of any and all other two-revolution presses. All these latter print and have distributions which lay on the ink in more or less satisfactory manner. But none other than The Premier has the sheet and ink saving possibilities of the tipping fountain and the independent vibratory motion. The fountain on every other two-revolution press is fixedly bolted to the press frames, whereas The Premier fountain is arranged to swing at any angle merely by loosening one bolt and tightening it again. The fountain is placed above the ink plate, but to the first table vibrator roller, and as the ink table is then at the other end of the press (when the press is running), the ink is cut up to some extent already when first laid on the plate. Over the table and form rollers there are three vibrators beside two top vibrators over the form roller vibrators. These form and table vibrating rollers are independent one of the other, so that while those over the form rollers may be set to vibrate a great deal, but little, or not at all, those over the table rollers can be set to vibrate as desired, whether much or little. The vibrators over the form rollers can be raised by the mere turning of a lever—the same operation raising the form rollers away from

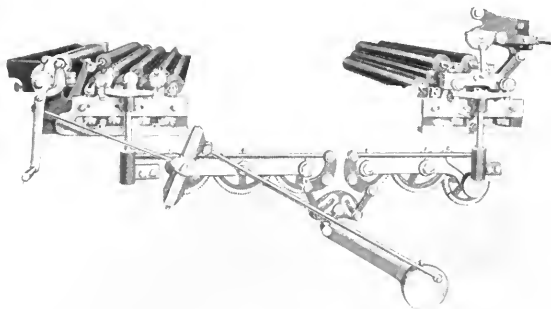

The Unequaled Distribution; note the independent vibratory mechanism

the form. There are two fountain pawls, permitting of a supplemental half nick movement of the fountain ratchet. The form and table rollers are interchangeable and gear-driven.

No modern four roller two-revolution press is complete without a dual delivery. On pony presses where a sheet can be flicked off the press with one hand without stopping, a dual delivery is not alone unnecessary but is oftentimes more or less of a nuisance. But two-revolution presses designed to print color or black work of very high quality or built to run at very high speed must be supplied with a delivery which can deliver the sheet either printed-side-up or to permit of the work being critically examined without either taking a sheet from the pile or stopping the press, or fly the sheet printed-side-down at the fullest speed the press driving mechanism can operate. The printed sheet on all printed-side-up delivery presses is absolutely uncontrolled at the place it is discharged to the pile. The fly delivery, or printed-side-down, controls the sheet very much better; hence the speed of so fast a two-revolution as The Premier and one or two other makes is necessarily cut down to the ability of its delivery to take care of the sheets. If, therefore, a press is supplied with only the printed-side-up delivery it cannot in the very nature of things run as fast on some work as if supplied with the fly, while if supplied with only the fly a pressman cannot examine his sheet or adjust his color thoroughly well without stopping the press—an expensive and time wasting operation. Hence, the really modern two-revolution press must have both deliveries. Having both deliveries on the press is not all there is to it either. There is a certain popular two-revolution press possessing both, whose printed-side-up delivery can handle only good heavy stock because it uses sticks with pushers to get the printed sheet onto the pile. The Premier dual delivery will handle all sheets from tissue to board equally well, because the delivery carries the sheet directly over the pile and then rolls away from under the sheet leaving it to fall on the pile and adjust itself thereto with a fine layer of air between. This latter saves slip-sheeting on all but the very heaviest-inked cut forms. There are besides three just printed sheets exposed to the air for drying throughout the printing operation. The printed-

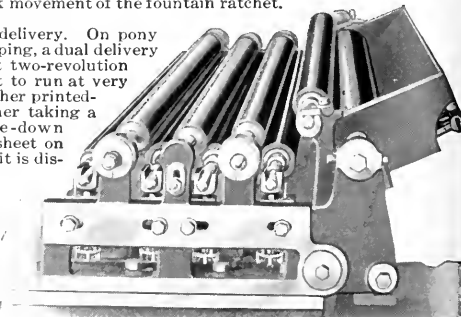

The Premier Fountain is arranged to swing at any angle by loosening one bolt and tightening it again and the fountain is placed above the plate

The Premier Two-Revolution Printing Press

sides-up delivery of The Premier dual delivery has been used for years by the trade in connection with another make of press, our improvement thereon consisting in the invention of a method for applying the fly in connection with it. A further absolute necessity in the use of a dual delivery is that it shall be readily and simply changeable from fly to printed side up and vice versa. The drive of The Premier dual is simplicity itself. It consists of the usual fly cam and lever with rack teeth cut in the latter to mesh with the fly pinion, and a dupl. gate of this mechanism turned back to back for driving the printed-side-up delivery, a circular plate taking the place of the fly cam. The change is made by pushing a handle up or down—this handle throwing out of mesh either the fly gear from its lever or the printed-side-up delivery gear from its lever. The change can be made in from half a minute to two or three minutes and is so simply done that, once shown, a layman can do it correctly forever after. Where a press is running on badly curled sheets or on paper with broken edges and one delivery seems not to handle it as well as it might, the other can be put into use almost instantly. If there is improvement in the production, well and good. If it is not so good, the delivery can be changed over again and less than five minutes only have been lost in the effort. Compare that with the two or three hours the same effort would cost on some of the other two-revolution presses. The Premier dual delivery besides is all self-contained no parts being removed to be hung on the wall or left standing around, and the fly is used as over-guides when the printed-side-up delivery is in operation

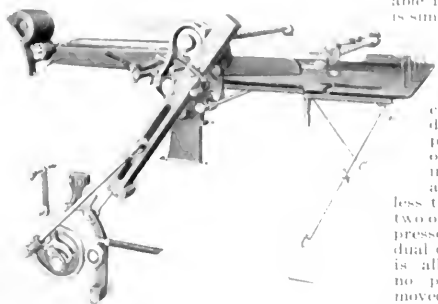

The Premier Printed Side-Up Delivery

and is not suspended in the air. In every feature, whether of utility, and ability, simplicity, effectiveness, ever-readiness for quick change or from any other standpoint whatever, The Premier dual delivery is undoubtedly unapproached in even the remotest way by any other dual delivery or any other two-revolution press in the world. The Premier is supplied with a brush at the bottom of the cylinder to assist the front bands to snug the sheet close so as to expel the air between the sheet and cylinder.

Dimensions of The Premier Two-Revolution Press

Bed Inches	Form Inches	Sheet Inches
28x41	23x37	25x38
33x45	28x41	30x42
36x48	31x44	33x46
41x52	36x48	38x50
43x56	38x52	40x54
47x66	42x62	44x64

There are both trip and back-up motions on The Premier. Some of the other two-revolution presses have the trip and a brake, but no back up. This requires another hand at the fly wheel when putting on make-ready and top sheet. The back-up is therefore a time saver. The trip does not operate, no matter if stepped on, during the printing operation, but will throw-off up to just before the head-line or after the impression-and is reached. We respectfully submit the Premier to the trade with perfect confidence that our claim for its far exceeding any and every other two-revolution press in the market in any and every function of the modern printing press will be fully demonstrated on any user's floor to his perfect satisfaction if afforded the opportunity of doing so. It will make good absolutely.

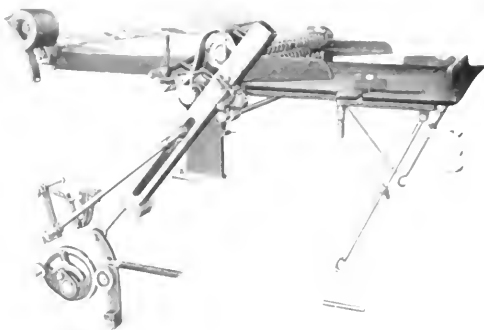

The Premier Fly Delivery

and is not suspended in the air. In every feature, whether of utility, and ability, simplicity, effectiveness, ever-readiness for quick change or from any other standpoint whatever, The Premier dual delivery is undoubtedly unapproached in even the remotest way by any other dual delivery or any other two-revolution press in the world. The Premier is supplied with a brush at the bottom of the cylinder to assist the front bands to snug the sheet close so as to expel the air between the sheet and cylinder.

The Whitlock Two-Revolution Two-Roller Pony Press

No cylinder printing press is so profitable an investment for the printer as the Whitlock Pony. Its reputation is world-wide. In fact, it is the Standard Pony Press of the World. Smooth in its operation, quick to make ready and to get the form on and the work off, with a fine distribution, even and rigid impression, exact register, easy to feed and to operate, simple and durable—all these elements have combined to make it the most popular of all the pony presses. It is as profitable for the large printing office with one hundred cylinder presses as it is for the small printer, whose only cylinder it is. Its range of work comprehends everything from an envelope to a sheet the full size the bed will take, and from the lightest form to one in which half-tones or other plates abound. It displaces the larger jobbers—producing the work more quickly, of finer quality and with less work in the production, and oftentimes relieves the rush of work on large cylinders where the sheet can be split to a size that the bed can take on.



Whitlock Pony Press, with Printed-Side-Up Delivery

user so great as to make impossible the consideration of any of the aforementioned imitations on the part of any intending pony press purchaser. The Whitlock Pony possesses every known device for the production of the maximum of work at a minimum expense. The following is a description of some of its features with a terse comparison of the same features as found in other makes of pony presses:

The bed motion is a simple crank movement where the bed driving gear is constantly engaged with the bed, driving it backward and forward without the tumbling around ends or the jumping up and down or the sliding in and out of the bed gear, as in other pony presses. These latter run smoothly up to a speed of two thousand or twenty-two hundred an hour when new, but at a greater speed or when slightly worn they jar badly over centers causing deviation in register, wear and trouble. The Whitlock Pony is guaranteed to run at three thousand per hour in the smaller size and twenty-six hundred per hour in the larger. It can be speeded, however, from five to ten per cent faster than this—thirty-three hundred per hour being not uncommon for the former and twenty-nine hundred for the latter. And this with exact register and without undue wear or strain. No other pony printing press can approach this wonderful operating capacity.

The type bed of the Whitlock Pony is a box type bed with a bottom as well as sides and top. By this means a strength more than double that possessed by any other pony press type bed is gotten. It is, besides, scraped absolutely true after planing so that type forms (and most pony presses run mainly on type forms) can be made ready in much less time because of this feature.

The cylinder on the Whitlock Pony is closed cast, i. e., there are no openings at the front and tail of the impression for the insertion of the gripper, shoe-fly and tympan rods as in the case of other pony presses. The cylinder of the Whitlock Pony is cast with a deep depression in place of the rod openings, allowing ample room for the comfortable accommodation of the rods. This strengthens the cylinder by over one hundred per cent, assisting to make ready quickly and prolonging the life of type and plates.

The fountain on the Whitlock Pony is the only fountain on any cylinder press not bolted fixedly to the frames of the press. It can be tipped and set at any angle so that ink cannot work away from the fountain roller, thereby permitting color to work light. By means of this tipped position all the ink is used and waste prevented.

The Whitlock Pony has both trip and back-up motions. Some of the other pony presses have either the trip or the back-up,

The Whitlock Two-Revolution Two-Roller Pony Press

but few have both. The value of both these features is inestimable. There is a heavy sole plate supporting the superstructure of the Whitlock Pony while almost all other pony presses stand upon their side frames. The sole plate imparts rigidity and takes up the thrust which other pony presses impart to the floor where they are operating. As a consequence, the Whitlock Pony can be installed and will run correctly on a floor much lighter and will strain resistance than any other pony press built. Concentrating the construction of the Whitlock Pony has made it lower, shorter and narrower than any other pony—its weight being kept well down to the sole plate, avoiding thereby that tendency to top-heaviness so noticeable in other machines and lending itself to the smoothest operation when running at highest speeds.

The Whitlock Pony will make good absolutely no matter what other pony may be put in opposition against it. It is built with front fly as shown in the preceding page or with a printed-side-up (all tapes) as shown in the two illustrations. The presses are equipped with a set of composition rollers, an extra set of stocks, hard packing for cylinder, slitter, counter, jogger, press tools and steam fixtures or motor pulley and bearing.

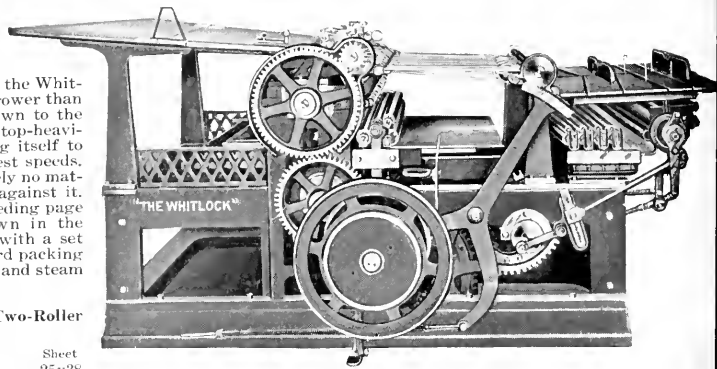

The Whitlock Pony, Front Fly Delivery

Dimensions of The Whitlock Two-Revolution Two-Roller Pony Press

Bed	Type	Sheet	Bed	Type	Sheet
27x31	22x27	24x29	28x40	23x36	25x38

The Whitlock No. 23 Two-Revolution Three-Roller Pony Press

The Whitlock No. 23 Pony is a Three-Roller Pony, an adaption of the No. 00 Four-Roller and the No. 3 Two-Roller Ponies. It is designed to meet the needs of those printers who, not needing the very high speed two-roller can run at, yet find unnecessary the very fine distribution of the four-roller. The bed drive is the well-known elliptical-gear crank motion, which is a modification of the bed driving mechanism employed in almost all stop cylinder and lithograph presses, the simplicity, durability and register-exactness of these machines being retained, and modern speed being imparted by the use of the speed gears.

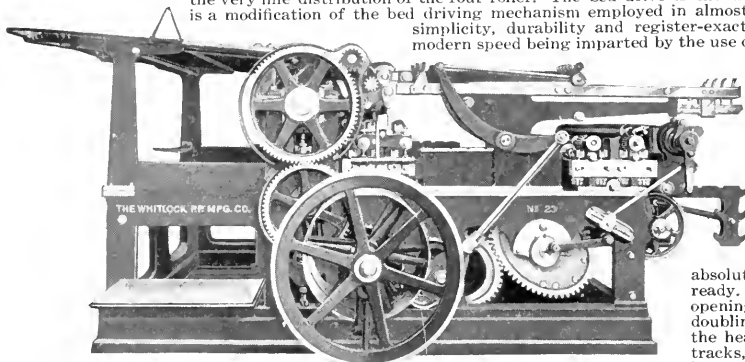

The Whitlock Two-Revolution Three-Roller Pony Press

Four air springs, set in pairs at each end, take up the thrust of the bed. A simple device automatically adjusts them for more or less air, as speed requires. The No. 23 is built with four full length steel-faced tracks in which run more than the usual number of steel friction rollers, whose peculiar shape forms a perfect preventative to any side lash of the bed, and besides which, in their travel, carry the oil so that the tracks are thoroughly lubricated. The box type bed has a bottom surface and not merely the usual cross ribbing. This fully doubles the strength of the type bed. The type bed beside is scraped

absolutely true—a time saver in making type forms ready. The cylinder has its periphery closed-cast (no openings for gripper or blanket-clamp rods) thereby doubling its strength. This, with the heavy sole plate, the heavy double-arched girder, the four full length tracks, and the box type bed, contrive to make an impression capacity unequalled by any other press. The fountain is not bolted fixedly to the frames, but may be tipped to any angle. This forces the ink down

on the fountain roller thereby preventing color from working light. It also saves ink waste. All ink rollers are interchangeable, being of same diameter. Old form rollers can be used as angle rollers, thus saving roller expense. The angle rollers are geared and driven in the same direction with the moving ink plate and at the same speed by a simple rack and gear driving mechanism—avoiding the use of belts and trains of gears. The fountain ductor roller deposits the ink, not on the ink plate, but upon the first angle roller, and makes more than one complete revolution before returning to the fountain roller, thus cutting up the ink most effectively. The hinged roller frame with roller lifting device is so finely balanced that an easy swing of a lever lifts the top riding and vibrating rollers from off the form rollers, the form rollers being lifted away from the form at the same time. The press has both trip and back-up motion. The trip cannot be broken through improper timing. The back-up operates by friction and acts instantly at highest speed without any damage to the press. The printed-side-up delivery, which lays the sheets over the fountain, is an all tape delivery already in use for many years and is exact, simple and most effective in its operation.

Dimensions of The Whitlock No. 23 Two-Revolution Three-Roller Pony Press

Bed	Type	Sheet
28x41	23x37	25x38

The Whitlock Two-Revolution Newspaper Press

This press is specially designed to do not only the finest newspaper work at the highest speed at which a flat bed press may be run, but also to be equally efficient for production of the general work of the modern printing office. Its various patented and modernized features have been in use long enough and tested severely enough on the Whitlock Four-Roller Book Press to warrant the claim that the Whitlock Newspaper Press is the swiftest, smoothest running, simplest, most durable and most efficient of all the two-revolution presses. The Whitlock Newspaper Press is built with a heavy foundation. This, with the extra heavy double-arched girder directly under the impression and the heavy girder at each end of the machine, impart a strength and solidity not possessed by any other two-revolution newspaper press. The new crank bed movement is a modification of the bed driving mechanism employed in almost all stop cylinder and lithographic presses—the simplicity, durability and register exactness of these machines being retained, and modern speed being imparted by use of the speed gears. The speed of this machine depends largely on the place of installation. If on a first-class foundation the usual speed will easily be eighteen hundred to two thousand per hour. This we guarantee. Twenty-two to twenty-three hundred per hour is not infrequent in the offices where these machines are in operation. Four air springs, set in pairs at each end, take up the thrust of the bed. A simple lever quickly adjusts them (in pairs), for more or less air, as speed or form requires. This machine is

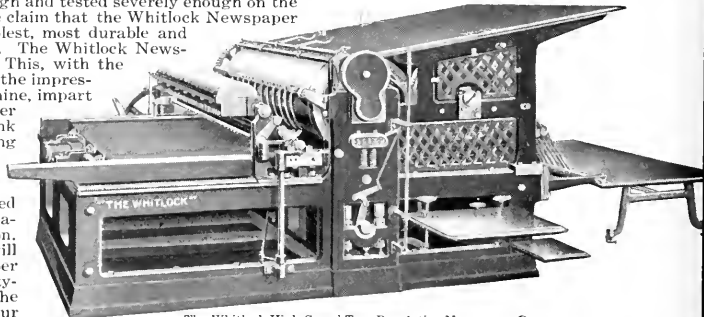

The Whitlock High-Speed Two-Revolution Newspaper Press

steel-faced tracks in which run more than the usual number of steel friction rollers, whose peculiar shape forms a perfect preventative to any side lash of the bed, and besides which, in their travel, carry the oil so that the tracks are thoroughly lubricated. The box type bed has a bottom surface and not merely the usual cross ribbing. This fully doubles the strength of the type bed. It is besides scraped absolutely true—a time saver in making ready. The cylinder is much larger in diameter than is commonly used, thereby lessening considerably the wear on type and plates. Its periphery is closed-cast (no openings for grippers or blanket-clamp rod), thereby doubling its strength. This, with the heavy sole plate, the heavy double-arched girder, the four full-length tracks, and the box type bed, contrive to make an impression capacity unequalled by any other press. Made in one size only, seven-column quarto.

Dimensions of The Whitlock Two-Revolution Newspaper Press

Bed	Type	Sheet
39x52	34x48	36x50

The Brower Drum Cylinder Presses

The Brower Drum Cylinder Press was first placed upon the market in January, 1906. It is, therefore, the most modern of standard drum presses. At the outset only the No. 7 size was manufactured, but the universal popularity of the machine among country publishers ultimately resulted in the bringing out of the No. 9, or six column quarto press. These two presses are of the same type, the only difference in their construction being the result of their differences in size.

Of all standard or one-revolution cylinders on the market, the Brower is the lightest running, the simplest in construction and the most durable. Indeed it is so easily understood and run that a printer, who can put a job on any kind of a press, quickly learns to operate a Brower as successfully as an expert pressman. This is especially true when the book of instructions, which is sent with every press, is kept at hand for reference. This booklet is an invaluable aid and is the first clear and complete exposition of the salient points of erecting, adjusting, making-ready and running a cylinder press ever published by a cylinder press manufacturer.

For the work of an office in which there is only one cylinder press, the Brower is without a peer, for each of the machines is fitted with table distribution and will deliver with perfect rhythm the smallest sheet usually put upon a cylinder up to the largest its capacity will take. Too much stress can not be laid upon the fact that every Brower has table distribution and at no extra cost. Where a poster or some other job requiring a special ink is desired to be run, it is necessary only to disconnect the fountain of a Brower and apply the special ink directly to the plate with knife or brayer. Neither time nor ink is wasted cleaning out the fountain to do such a job. The usual extra charge for table distribution is from fifty to one hundred dollars, but in the case of the Brower it is included in the regular price. This should be borne in mind when other drums which do not have table distribution included in their price are offered in competition with a Brower. Every Brower likewise is fitted with tapeless delivery, receding gripper studs, hinged feed board, detachable fly, adjustable chase head clamp, sheet slitter and every other valuable up-to-date convenience as befits the latest standard drum built.

Furthermore, as will be seen by reference to the cut above, every one of these machines has its fly wheel shaft placed high up, so that should the motor balk, a handle may be inserted and the run finished by hand before time and patience are expended in coaxing the motor to resume operations. No other drum built can be run by hand for they are all too heavy draught and their fly wheel shafts are consequently placed low down. This one feature gives a confidence and degree of independence to the owner of a Brower which, if it could be expressed in figures, would exceed the cost of the machine.

There is no drum built other than the Brower which will give hair line register throughout its life. Perfect register is claimed for many competing drums, but after the newness has been worn off from these machines, they cannot give hair line register, because every one has an intermediate gear between bed and cylinder, and such a gear makes perfect register a mechanical impossibility.

Evenness and rigidity of impression are of the first importance in a cylinder press. Years of experience have shown conclusively that where a bed is more than forty inches wide, it requires more than two tracks to give unflinching rigidity of impression. Therefore the No. 7 Brower, being but thirty-eight inches wide, is provided with two tracks under the bed, while the No. 9 Brower with a bed forty-eight inches wide, is supplied with four tracks. In other words, these two machines are the only drum presses built in compliance with scientific rules evolved by long experience. Competing drums claim to have four tracks, but when these claims are investigated it will be found, in every instance, that they are untrue. Besides two tracks the larger of them have two outside stationary roller bearings, but such roller bearings are mere makeshifts and no competent mechanic will ever claim that they can perform the functions of tracks. However the addition of such roller bearings to old presses is an admission of their defects.

It goes without saying that the fewer the parts in a structure of given dimensions, the stronger and stiffer it is. Therefore in designing the Brower cylinders, wherever two or more parts could be made in one, that plan was followed. For instance, take the tracks and cross stays as shown in the cut and it will be seen that what in other machines is composed of seven different pieces, is in the No. 9 Brower only one piece. It is costly to cast and machine such a piece, but it gives one hundred per cent more stiffness and at the same time makes less weight on which freight has to be paid. In short, this system of construction produces the best machine and that is what the manufacturers of the Brower have aimed at from the start.

A word must be said about base length. The space in an office occupied by a press is really measured by the over all dimensions. Therefore as long base length gives stability, why not have the length of the base equal to that of the machine? The makers of the Brower answer this question by referring to the projecting feet at the end of each side frame as shown in the cut. The result is the Brower stays where it is put and is as free from vibration as any such machine can be.

The No. 9 Brower possesses one feature which deserves very particular attention. It prints thirty inches around the cylinder. No other six column quarto drum press can do this. This extra printing surface enables the machine to handle thirty-two by forty-four inch sheets, the size most desired for large pamphlet work, especially when financial statements have to be shown.

The books say that a bearing should be fifty per cent longer than the diameter of the shaft working in it. Many of the bearings in most of the cylinders on the market fall short of this rule and practically none of them exceed it. But in the Brower the principal bearings are more than double the diameter of the shaft and all the other bearings meet the rule with a margin on the right side. Few publishers look into technical points like this one, but they would be better off if they did. On such features of construction does the life of a machine depend. Please note this: No drum cylinder now on the market has a life equal to that of the Brower. The Browns are made on the interchangeable plan, jigs, templates and special tools being employed at every stage of manufacture.

Prices of the Brower Drum Cylinder Presses f. o. b. Factory

	No. 7	No. 9
Brower Drum Cylinder, with drop rollers fitted for hand or belt power, without springs	\$650 00	\$735 00
Attachment. Air Springs complete	37 50	37 50
Attachment. Screw Vibrator	37 50	37 50
Complete Press	\$725 00	\$810 00

The attachments when purchased subsequent to shipment of press will cost \$50 each for each machine. Each press is packed in boxes, not crates, and furnished with felt blanket, sheet slitter, one set of composition rollers, one extra set of roller stocks, handle, wrenches and screw driver.

Dimensions of the Brower Drum Cylinder Presses

Size	Bed Inches	Form Inches	Floor Space	Over All
No. 7 7 columns folio	26x38	22x31	8 feet 2 inches long, 1 feet 2 inches wide	8 feet 2 inches long, 6 feet 1 inch wide
No. 9 6 columns quarto	31x48	30x12	10 feet 5 inches long, 5 feet 3 inches wide	11 feet 2 inches long, 6 feet 9 inches wide
Approximate Net Weight	Approximate Shipping Weight	Greatest Height	Hand Power No Attachments	Speed Belt Power No Air Springs
No. 7 4500 pounds	6000 pounds	5 feet 3 inches	100 to 500	600 to 700
No. 9 6000 pounds	8000 pounds	5 feet 6 inches	300 to 400	500 to 600
				Belt Power With Air Springs
				1500 to 1600
				1300 to 1500

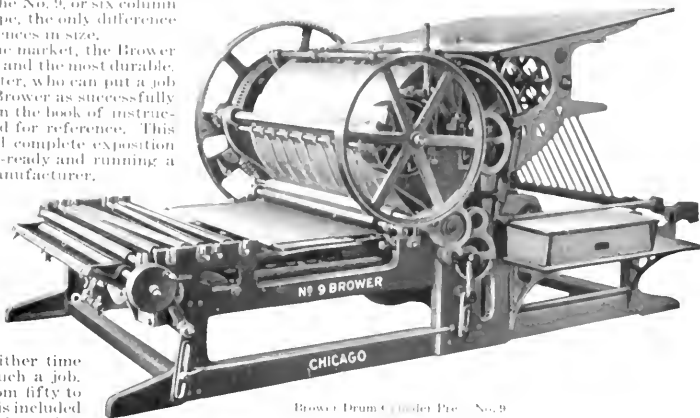

Brower Drum Cylinder Press No. 9

PART B-13

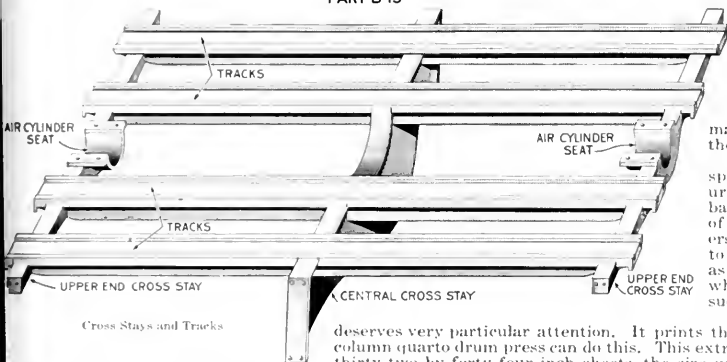

Cross Stays and Tracks

The Cranston Newspaper Press

The castings of the box frame style are solid, not only giving the press a massive appearance, but the required resistance for heavy impressions in cut work, and with full forms. The three sizes are desirable ones for general book and newspaper work, taking a six-column folio, a seven-column folio and six-column quarto without crowding.

The quality of stock used, and the careful construction of the press, render it capable of the highest speed consistent with an economical production of good work. It is the experience of printers using this press that it fully sustains the points for which it is recommended. The press is fitted with air springs, with extra long cylinders and adjustable plungers, tapeless delivery, with wheels adjustable to any size sheet, simplex slider motion—the simplest device known for regulating the motion of the sliders,—brake, rack guard, iron feeder's stand, feed guides that are capable of finest adjustment, large size form rollers, register rack and segment, deep fountain, with cover, which will hold a large supply of ink, a simple adjustment for regulating the fountain roll, and rack and cam distribution. The gripper motion is smooth and noiseless in operation.

The tracks have solid ends with oil reservoirs which prevent any leakage of oil from the ends of the track. The bed has steel runners, is heavily webbed, and on the largest size is additionally supported under the impression by two adjustable truck rollers.

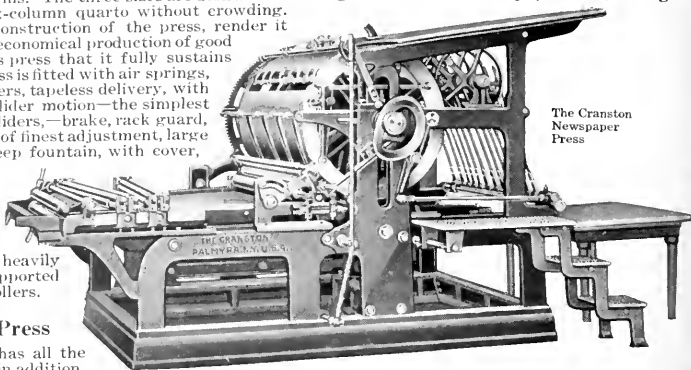

The Cranston Newspaper Press

The Cranston Improved Newspaper Press

The Cranston Improved Newspaper Press has all the features of the Cranston Newspaper Press, and in addition, it has a long register rack and segment and a back-up motion. The back-up motion is so arranged that it can be operated by foot pedal when the belt is on the loose pulley and the machine backed up at quarter speed. The back-up parts are all of iron and steel, and are substantially constructed on correct mechanical principles, and do not get out of repair.

List Prices of Cranston and Cranston Improved Newspaper Presses

Newspaper Press, No. 1A, 24x32½	\$1000 00	Improved Newspaper Press, No. 1A, 24x32½	\$1100 00
Newspaper Press, No. 2A, 26x39	1100 00	Improved Newspaper Press, No. 2A, 26x39	1200 00
Newspaper Press, No. 3½, 33x48	1200 00	Improved Newspaper Press, No. 3½, 33x48	1300 00

Table distribution will be furnished for either press for \$100 extra.

Stonemetz Two-Revolution Press

The Stonemetz is a two-roller, two-revolution job and news press, capable of doing high-class half-tone and color work. A new and excellent bed control reduces the vibration to a minimum and greatly enhances the value of this machine. Two air chambers of ample size are provided to overcome momentum, and the amount of compression in these can be adjusted without stopping the press. The bed is reversed with absolute crank motion. The driving rack is attached to and directly underneath the bed, insuring uniform travel of bed and cylinder. At the end of the stroke this rack is freed from contact with the gear which carries it forward, and while thus relieved of all strain slides over in line with the reverse gear, which then engages it and carries the bed back. At the completion of the stroke it is brought into its original position by a similar motion. The bed is supported by twenty 2½-inch steel rollers running in tracks. These give the utmost rigidity to the bed.

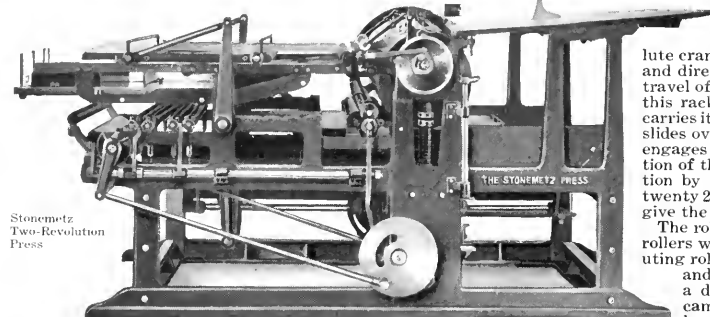

Stonemetz Two-Revolution Press

The roller equipment consists of two 3-inch form rollers which clear the form and four 2-inch distributing rollers set parallel with the edge of the table and oscillated in pairs in opposite directions by a double cam. The feed guides, operated by a cam, hold the sheet firmly until the grippers have engaged it, when the guides move away at a rate of speed uniform with that of the grippers. The trip is very simple and cannot be made to break the press. The fly fingers are metal, presenting a smooth curved surface to the paper. They are adjustable in all directions. Both feed and delivery boards can be adjusted or removed. The cylinder and bed are driven in absolute unison, there being only one bearing between. The cylinder is held to the impression by an eccentric thrown beyond the center, thus insuring a perfectly rigid contact.

The roller equipment consists of two 3-inch form rollers which clear the form and four 2-inch distributing rollers set parallel with the edge of the table and oscillated in pairs in opposite directions by a double cam. The feed guides, operated by a cam, hold the sheet firmly until the grippers have engaged it, when the guides move away at a rate of speed uniform with that of the grippers. The trip is very simple and cannot be made to break the press. The fly fingers are metal, presenting a smooth curved surface to the paper. They are adjustable in all directions. Both feed and delivery boards can be adjusted or removed. The cylinder and bed are driven in absolute unison, there being only one bearing between. The cylinder is held to the impression by an eccentric thrown beyond the center, thus insuring a perfectly rigid contact.

List Prices of Stonemetz Two-Revolution Presses

No. 2, 25x33	\$1250 00	No. 3, 26x38	\$1500 00	No. 4, 29x42	\$1800 00
--------------	-----------	--------------	-----------	--------------	-----------

The Diamond Cylinder Press

The Diamond Cylinder Press is the evolution of many years' experience in press building. It has been designed to meet the requirements of country newspapers for a reliable low price press to run editions up to three thousand copies. In appearance it is handsome and it is a mechanically correct machine.

The frame is substantially built, strong and compact. The machine will print any sheet up to six-column folio.

Ink distribution and impression—two very salient features in any press—are perfected in the Diamond. Ink is furnished to a ductor roller by the Challenge Book Fountain with screws conveniently placed. The ink is carried to a roller and thence to a vibrating roller resting upon the two form rollers. The latter ink the form in both directions as it travels back and forth on the bed of the press beneath the cylinder. It needs no attention after the fountain has been adjusted. The rollers can be removed quickly and easily.

The points of strain in impression are the cylinder, the bed and the bed support. The cylinder is heavy and unyielding under pressure. The journals at both ends run in anti-friction, oil retaining roller bearings. The impression can be adjusted quickly and to a nicety by simple screws and locknuts at the cylinder ends.

The bed is heavy, evenly balanced and finely machine finished. Three anti-friction steel rollers in the line of impression not only insure absolute rigidity, but make the motion free and easy.

To insure easy feeding the large varnished, white pine feed board has the right pitch. Sockets fit over supporting standards and these can be lifted off and replaced in a moment as no adjustment is necessary. The sheets are delivered by tapes of linen twine, so arranged to deliver them to a fly, which in turn delivers them printed side up, on a nicely finished white pine table. The table can be removed when not in use to save space.

Each press is furnished with felt blanket, set of cast rollers, extra set of roller cores, fly table, wrenches, oil can and screw driver. The steam power series in addition to the above, has tight and loose pulleys, shifter and fly wheel. Rubber blanket in place of felt, \$4.00 additional. Felt blanket complete with trimmings, \$20.00. Rubber blanket, complete, with trimmings \$30.00. Steam power attachments (for hand power presses), \$70.00.

List Prices of Diamond Cylinder Presses

Steam Power Series, Six-Column Folio	\$425 00
Hand Power Series, Six-Column Folio	370 00

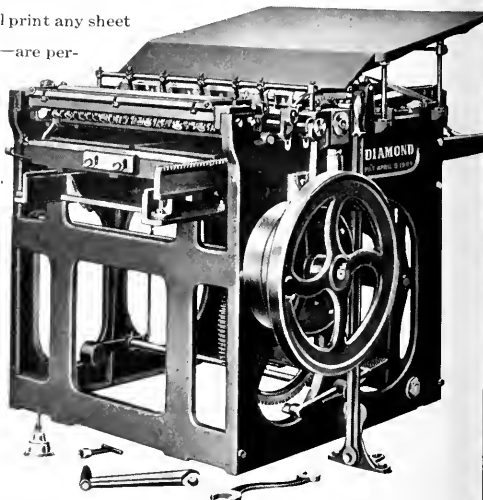

Diamond Cylinder Press

The Chandler & Price New Series Presses

In bringing out this new and improved design of the Chandler & Price Gordon Press, the objective has been to attain an advanced style of construction without changing any of the fundamental principles of the Gordon type of platen press, as patented by George P. Gordon, and perfected by The Chandler & Price Company.

This New Series Press has been developed along approved scientific lines. The frames are box pattern with deep flanges, which, together with the proper distribution of metal, make them exceedingly strong and rigid. The roller, saddle, rod, and springs are enclosed in the roller frames, which are smooth outside and have no projection to catch and hold dirt. The main gear is heavier and has a broader face, insuring a longer life and the ability to stand up under the heaviest strain of high type printing. Inside the gear in the raceway of the cam, where the wear is greatest, a hardened tool segment is inserted, making it practically non-wearable. The gear is covered by a protecting guard, preventing the soiling of paper by accidental contact with the top of the gear. The idler arms are of steel, forged flat and are provided with oil grooves and oil cups. The fly wheel is smaller, has a straight spoke, and a heavy rim, and is properly proportioned to give the best balance. The shafts are large, made of steel, and are ground true, thus reducing friction to a low point and insuring smooth, quiet running. All parts of the New Series Presses are accurately made to standard size and are interchangeable with proper adjustment.

The essentials of a perfect impression are weight and power with correct balance and adjustment. The new gear and crank wheel, steel end pins, forged side arms and massive studs, all combine to produce a powerful, rigid, ever impression with absolute register, yet so truly balanced and so accurately adjusted, is this great weight that the impact does not cause undue wear of type and cuts.

Improved inking is provided by the new metal riding roller which vibrates above the form rollers, adding lateral distribution to the rotary distribution of the disc. This simple device can be placed in position or removed as easily as an ordinary form roller, and is very effective where exceptional distribution is required.

Because of its compact construction, the New Series Press is lower, making the form and rollers more accessible, bringing the platen within easy reach for make-ready and the feed tables to a convenient height for rapid feeding.

This New Series Press is painted a dark steel color, without striping or other ornamentation, giving it a distinctive appearance and making it easy to keep clean.

No effort has been spared to build a compact, rigid, durable, serviceable printing machine, and this New Series Chandler & Price Gordon Press is presented with the confident assurance that it possesses the highest degree of platen press efficiency yet attained.

Other Advantages

The appearance is more modern, and the press is easier to keep clean because there are fewer projections on which dirt, oil or ink can lodge. The metals used have had very particular attention. A variety of metals are used. The design is distinctive and comports in appearance utilized most suited to the various parts with the best materials in every case. The design is distinctive and comports in appearance with the Chandler & Price style. They have an individuality all their own and characteristics of strength and rigidity which make them absolutely distinctive. When a printer buys a new press of more modern design than his old one, he is impressed with the fact that the manufacturers are improving their product and keeping up with the times.

The distribution of metal and the parts are more symmetrical, thus relieving them of undue strains in the cooling of the castings. This is most noticeable in the separator. A further example of this is found in the side frames, which by reason of their better shape and better distribution of metal, are not nearly as liable to breakage from the rough handling incident to export shipment. Also the roller arm lug on the left side frame is better braced, and not as liable to breakage as in the old style press. Gears run smoother and wear longer, because the depth of the raceway is greater than on any other press and the surfaces are finished with the greatest care. Three special machines are used to complete the raceways of gear wheels. The feed tables set level, which avoids the danger of the paper piled thereon being spilled by the continual jar of the press while printing. The bottoms of the feet are milled, which allow the press to stand level, thus avoiding any undue strains incident to the press standing on three legs. It also lessens the vibration, and there is less danger of the press getting out of alignment. The rocker box caps and the crank shaft box are interchangeable, and the crank shaft has a longer bearing in the journals. The fly wheel is smaller and less in the way. The press is lower and easier to feed. Also it is easier to put in and take out the forms. The rocker shaft is larger in diameter, and being made in one piece with the rocker, it cannot get loose. The large gear cam wheel and the small head and lock cam are both thicker, which insures a more rigid impression. Thickening of these parts does away with the wrist pin collars and gives the wrist pin more support. The side arms have oil cups, which insure better lubrication of the wrist pins. The large gear cam wheel is equipped with hardened steel segment. The diameters of the discs of the Chandler & Price New Series Presses are as follows: 8x12 press, thirteen and three-quarter inches; 10x15 press, seventeen and one-quarter inches; 12x18 press, twenty and five-sixteenths inches; 11¹/₂x22 press, twenty-four and one-quarter inches.

The height of the upper and lower tables are: 8x12 press, upper table, thirty-nine and three-quarter inches, lower table, thirty-four inches; 10x15 press, upper table, forty and five-eighths inches, lower table, thirty-five and one-quarter inches; 12x18 press, upper table, forty and one-quarter inches, lower table, thirty-six and one-half inches; 11¹/₂x22 press, upper table, forty-one and one-half inches, lower table, thirty-six inches.

The roller trucks regularly furnished are: with the 8x12 press, one and three-eighths inches in diameter; with the 10x15 press, one and five-eighths inches in diameter, and with the 12x18 and the 11¹/₂x22 presses, one and seven-eighths inches in diameter. Trucks can be furnished for each press, either one-sixteenth inch or one-eighth inch oversize, or one-sixteenth inch or one-eighth inch undersize, as desired. The following are the dimensions of the presses when boxed: 8x12 press, 38x10x51 inches; 10x15 press, 46x49x61 inches; 12x18 press, 42x52x63 inches; 11¹/₂x22 press, 46x56x67 inches. The following extras are recommended: Side Power Fixtures, Buckeye Fountain, C. & P. Fountain and Vibrating Distributor. We can supply Steel Skeleton Chase and Spider Chase, full description of which can be found elsewhere. The prices of these extras are listed under their respective headings in this catalogue.

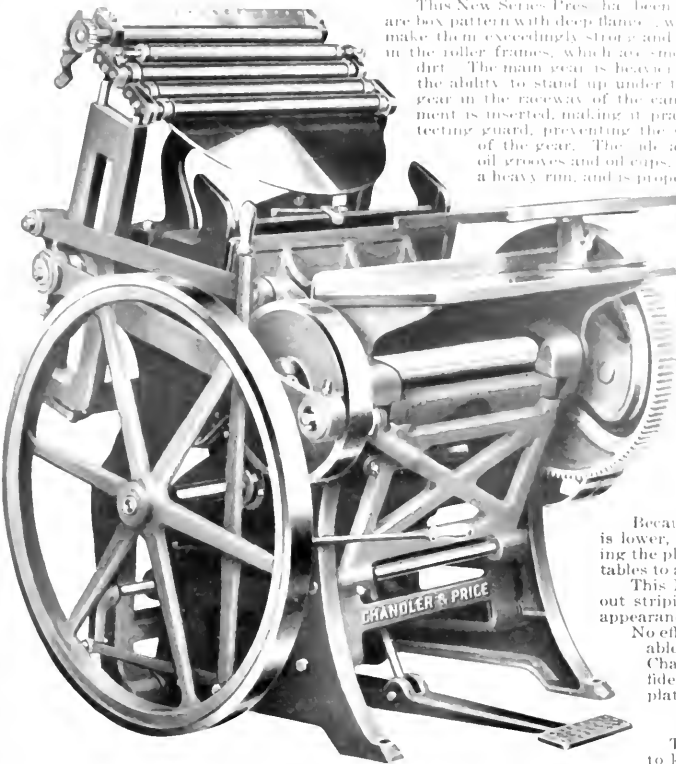

Three Quarter View of 11¹/₂x22 New Series Chandler & Price Press

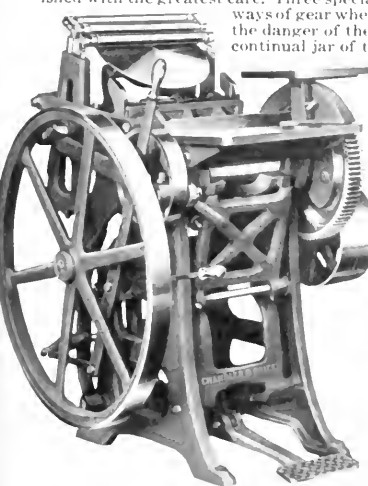

Three Quarter View of an 8x12 New Series Chandler & Price Press

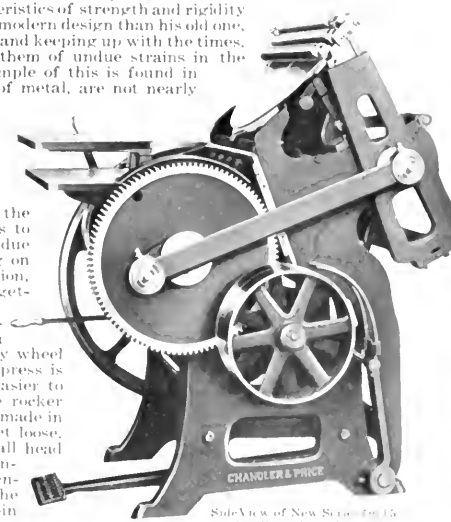

Side View of New Series 10x15 Chandler & Price Press

Chandler & Price Gordon Job Press

The foundations of a majority of the successes made in the printing business, during the past twenty years, were laid with the profits made upon Chandler & Price Gordon Presses. Although the first of these machines were built in 1886, most of them are still in use, as printers do not part with them except to buy new. This is proven by the fact that though nearly forty thousand of these machines are in use, it is an unusual thing to find a second-hand Chandler & Price Press offered for sale, they being so well built they still maintain their supremacy.

The Design and Mechanical Principles

The design and mechanical principles of the Chandler & Price Gordon Press are as nearly "fool proof" as a printing press can be made. It has no complicated parts, and is simplicity itself in all its movements. It requires few repairs and costs little to maintain in perfect condition.

The product to be obtained from a Chandler & Price Gordon Press is a purely personal equation. The press can be run as fast as it can be fed. Every movement of every part is as brief as its duty permits, but the platen is in rest during the time the sheet is being fed, enabling the feeder to place the

sheet more quickly and accurately than is possible on presses on which the bed is constantly in motion or has a very brief "dwell" or rest. On the Chandler & Price Gordon Presses it is easier to feed, as the feeder is not confused or retarded by unnecessary movements of the platen while the form is being inked.

The impression is decisive, unyielding, because of the rigidity of bed and platen, procured by sufficient weight to withstand even extraordinary strains. The impression is even because the bed and the platen are planed on the highest grade machines made in any country, and thus, when the bed and platen of a Chandler & Price Gordon Press are finished, these surfaces are absolutely true, so that there are no inaccuracies for the printer to overcome in his make-ready.

The American Type Founders Company has sold thousands of these presses and all have given the very best satisfaction. We shall be pleased to give you any additional information required regarding these splendid presses. A beautifully printed pamphlet describing and illustrating the Chandler & Price line of machines will be sent upon request.

Prices and Information Regarding Chandler & Price Presses

STYLE OF MACHINE	Inside of Chase Inches	Floor Space Inches	SPACE THROUGH WHICH PRESS WILL PASS			Center of Fly Wheel to Floor Inches	Face and Diameter of Driving Pulley Inches	Width of Belt Inches	Revolutions of Fly Wheel to Each Impression	Impressions per Hour at Highest Speed	Horse-Power Necessary	Weight Boxed Pounds	Price
			Assembled Inches	Partially Stripped Inches	Entirely Stripped Inches								
New Series C. & P. Press	8 x 12	40 1/2 x 48	36	27	18	21 7/16	12 x 2 1/2	2	4	2600	1/4	1250	\$165 00
New Series C. & P. Press	10 x 15	47 x 55	43	31 1/2	21 1/2	21 5/16	13 1/2 x 2 1/2	2	6	2300	1/4	1800	245 00
New Series C. & P. Press	12 x 18	55 1/2 x 60	46	36	25 1/2	21 1/2	13 1/2 x 2 1/2	2	7	1800	1/2	2400	295 00
New Series C. & P. Press	14 1/2 x 22	62 1/2 x 67	51	40	29 1/4	20 5/8	13 1/2 x 2 1/2	2	4	1500	1/2	3100	410 00
C. & P. Regular Model	7 x 11	45 x 37 1/2	33	25	16 1/4	25 3/4	12 x 2 1/2	2	4	2800	1/4	1050	140 00
C. & P. Regular Model	8 x 12	47 x 37	36	27	17 1/4	24 5/16	12 x 2 1/2	2	4	2600	1/4	1250	155 00
C. & P. Regular Model	10 x 15	53 x 43	43	31 1/2	21	23 1/16	13 1/2 x 2 1/2	2	6	2300	1/4	1800	225 00
C. & P. Regular Model	12 x 18	60 x 49 1/4	46	36	25 1/4	22 3/4	13 1/2 x 2 1/2	2	7	1800	1/2	2500	275 00
C. & P. Regular Model	14 x 20	65 x 53 3/8	50	40	28 1/2	23 1/16	13 1/2 x 2 1/2	2	8	1500	1/2	3050	355 00
C. & P. Regular Model	14 1/2 x 22	66 x 52 3/8	51	40	28 1/4	23 3/16	13 1/2 x 2 1/2	2	8	1500	1/2	3100	390 00

Side Power Fixtures, \$15.00 extra. Send for illustrated pamphlet and lowest selling prices.

No allowance can be made for the omission of or return of the regular complement of Chases or Treadles. Neither can it be permitted to return Fountains or Steam Fixtures ordered for any size machine.

The Peerless Job Printing Press

Thousands of Printers are familiar with the mechanical construction of the Peerless Press for its worth has been fully proven, but for those who have not had an opportunity of fully investigating its merits the following details are given.

The Peerless is so constructed that every motion is positive. There are no adjustments, so it is impossible for even the most inexperienced person to put it out of order. All parts are interchangeable. The strain bearing parts are of steel and made heavy, thus insuring great strength. The bed is stationary and strengthened by lateral and transverse webs, which prevent springing. The chase is instantly and securely fastened to the bed by a substantial hook. It is accurately fitted and can be inserted either side up. The impression is given by a toggle, applied behind the platen-yoke. This motion is very simple and powerful. The ink-disc makes five-seventeenths of a complete revolution, thus exposing a fresh surface of ink to the rollers and form at every impression. It ensures a proper ink distribution.

The rollers are three in number and cover a full form. The roller carriage is of original design, by means of which the rollers are securely fastened thus avoiding all chance of accident by the rollers dropping out. The throw-off is an eccentric, operated by a lever, which locks itself in either position. The grippers are of spring steel, and can be instantly lowered or raised for the purpose of setting. All impression screws are in sight and easy to reach. The gear-wheel is placed below the feeding level—a very important advantage. The pinion is protected by a gear-guard.

Each press is furnished with three cast iron chases, two sets (six) roller cores, two sets (twelve) roller bearers, a six inch brayer, with core and wrenches. The following are optional: roller mould or casting, one set of rollers and brayer, or two extra chases.

Prices of Peerless Job Printing Presses

The regular power fixtures consist of a pair of special tight and loose pulleys.	8x12	\$155	12 x 18	\$275
If desired the spider for electric drive may be supplied.	9x13	200	14 x 20	355
The Peerless long or hinged well fountain will be found desirable when larger capacity than that of the pony is required.	10x15	225	14 1/2 x 22	390
	11x17	265		

The Pilot Lever Press

It is one of the best presses of its class in the market and has never failed to give satisfaction. As a time-saver it is all that can be desired. Each press is furnished with one set of rollers, chase and wrench.

List Prices and Dimensions of Pilot Lever Press

6 1/2 x 10 inches, inside chase	\$35 00	With fountain	45 00
---------------------------------	---------	---------------	-------

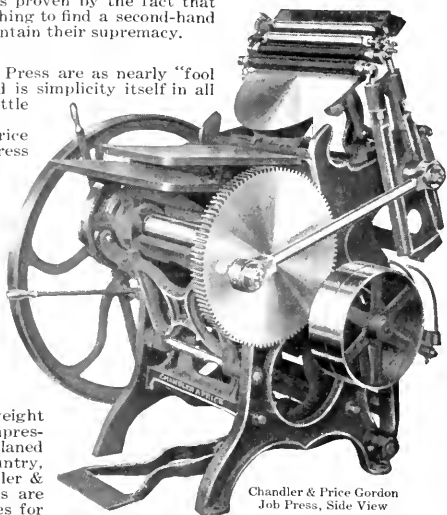

Chandler & Price Gordon Job Press, Side View

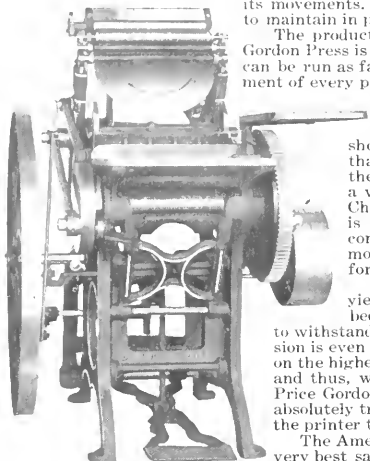

Chandler & Price Gordon Job Press Front View

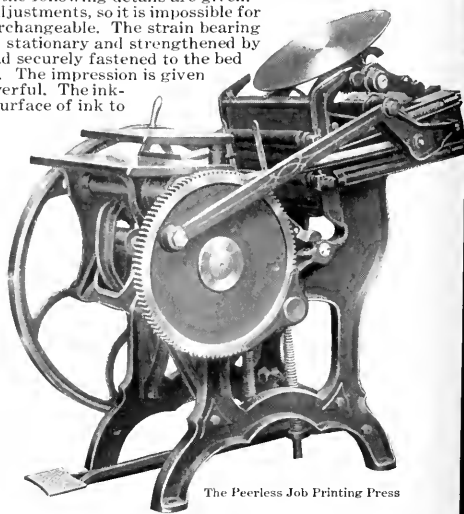

The Peerless Job Printing Press

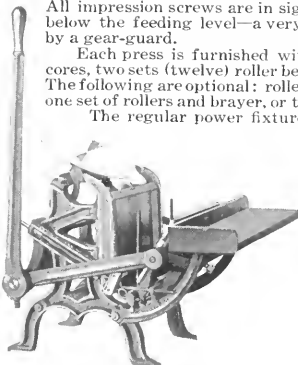

The Pilot Lever Press

The Laureate Platen Printing Presses

The merits of the excellent line of machines manufactured by the John Thom on Press Company are so well known that comment is almost unnecessary. The American Type Foundry Company, however, deems it proper to impress upon its customers, who have never used any machines of this manufacture, that each press described in the pages devoted to this style of machine stands in a class by itself. When an extra heavy printing press is required, there is no other machine manufactured that can so satisfactorily do the work. From those printers whom we have supplied in the past we have received many laudatory words of commendation and praise. The new Laureate Presses described on this page represent the very latest word in platen printing presses of their type, and will prove exceptionally popular with printers who appreciate machinery of the highest merit. Very much more could be said in favor of the Laureate Model, which would be of interest to the printer, but the limited space at our disposal will not permit it. We shall be pleased, however, to send an illustrated catalogue fully describing the same and other presses to any one interested. A copy of this catalogue should be in the hands of every printer having use for a machine of this class.

The Laureate Platen Printing Presses, Models J and T

The Laureate is an entirely new four-roller platen printing press. No expense or effort has been spared to produce a machine of the highest grade attainable by modern appliances and methods. It is built only in the 14x22 size, but in two models.

The Laureate Model T press has a single fly wheel, main gear and pinion. Its inking apparatus is exactly the same as that of Model J, and the dominant object in bringing out the Model T was to reduce its price when the character of work and the conditions are such that it will serve the purchaser satisfactorily.

The Model J is especially intended for work of a character requiring very heavy impressions at speeds of from one thousand to fourteen hundred per hour. While Model T is particularly adapted for work which can be run at a high rate of speed, say from fourteen hundred to eighteen hundred impressions an hour, so far as mere speed is concerned one model may be operated as rapidly as the other.

The particular function of either of the Laureates is for printing halftones, multiple color plates, tint blocks and combinations of cuts, borders and type, and of a size and character generally done on cylinder presses. They can also be used on thick and stiff cardboard signs, or any class of work requiring the very best results.

The rigidity of the bed and platen, and the accuracy with which the platen slides squarely to the form, is such that, with cuts accurately backed to "typo-high," very thin and hard tympan may be used; and, under the conditions named, the make-ready is more or less automatic.

The inking facilities are perfection at a down and up reciprocation of the carriage.

There are three distinct methods of form inking.

First, Four inking rollers pass over the form twice.

Second, The upper and third rollers are substituted by tubular steel changers, these riding, by gravity, upon the second and third form rollers. The changer action proceeds continuously across the form, giving the thinnest, most uniform and perfect deposit of ink imaginable, especially effective in halftone and multiple color work.

Third, By attaching the single-ink lath, either the four form rollers, or the two form rollers and the two riding changers will be forced away from the form at the termination of the down movement and will be so maintained until the lath, when the carriage is nearing the upper termination of its movement, is disconnected. This is peculiarly effective with solid tint blocks requiring special quick-drying inks.

All shafts and pins are of high carbon or special steels, ground to precise gauge dimensions, and all bearings are reamed to definite diameters.

The movement of the platen has been likened to "oil on water." It is faultlessly controlled and permits of rapid feeding. The organization of the novel movements involved in its construction caused great difficulty, but the ultimate result, mechanically, is a system of peculiar effectiveness, because of its simplicity. No expense or effort has been spared to produce a mechanism of the highest grade attainable by modern appliances and methods.

General Observation of the Laureate Platen Printing Presses

Shifts from one color to another can be made very quickly. A mere nominal time is required to recharge the inking system. The distribution, as a system, cannot be equalled on any press. It will print a visiting card as a tint block, because of its four roller combinations. The frame and bed are of solid self-contained type, more massive and rigid than hitherto constructed and the main shaft bearing is solid. The fountain cylinder, the ductor roller and the changer sleeve equal the length of the distributing rollers.

The distributing changer is of the enclosed thread type, whereby a considerable charge of oil is contained within the sleeve. The "crescent" or switch, passes through the oil at each revolution; hence the lubrication is continuous. It is believed, that as a system, the distribution cannot be equalled on any press of any kind, either platen or cylinder.

The following roller combinations are available: One form and one distributing roller. In this combination the lateral distribution afforded by the main ink cylinder is ample for a short run card job. Two form and one or two distributor rollers and the changer. Next, three form and two distributor rollers with or without the changer. And lastly, the full complement, that is four form and four distributor rollers, with or without the changer, and with or without the ductor roller, and with or without the fountain.

The crank pins and platen trunnions are provided with oil reservoirs, the oil being readily introduced from the ends.

Please note that the fly wheels on all Colt's Armory and Laureate presses should always run toward the feeder.

In the construction of these presses an effort has been made to avoid the employment of curlicue lines, sharp intersections between angles, a general appearance of harshness and yet to maintain everything that tends to simplicity in the details and to a harmonious result in the aggregate. Many arbitrary conditions forced the construction of certain members of the Laureate Presses in a somewhat different manner than would have been preferred, but it is hoped that their appearance on the whole will be appreciated.

Finally, the Laureate was designed to make it possible to profitably produce a grade of printing of the highest class.

For list prices and important data see next page.

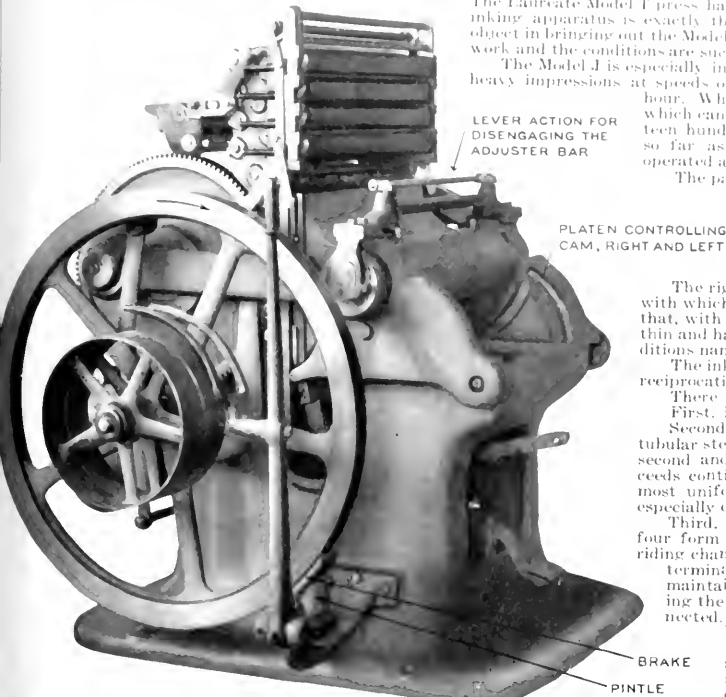

Front three-quarter view of the Laureate Model J, 14x22, showing platen closed

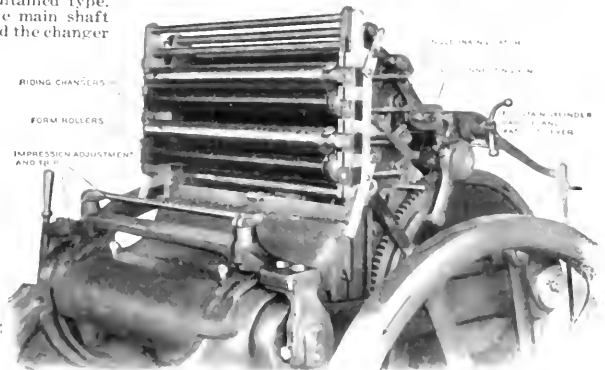

Laureate Models J and T
Detailed view from the front and right-hand side. This shows the carriage when provided with the two riding changers, and also the lath for causing all the form rollers to pass during the up-movement, free of the form. The inking apparatus is the same in both models.

Colt's Armory Press, Style B

The new Style B Colt's Armory Presses (a detailed illustration of the 5-B being shown below) possess many new and distinctive features which are of vital importance to users. Limited space prevents our giving more than passing details. A well-printed catalogue, accurately describing and illustrating these machines, will be cheerfully sent to those interested. The effectiveness of the man behind the gun would be absolutely nullified were it not for the excellence of the mechanism which he uses and directs. This axiom applies with equal force to the printing press.

The Style B, Colt's Armory platen printing machine is similar to the well-known and popular earlier Style A and represents the embodiment of some thirty years of cumulative, progressive and successful experience in this particular line of mechanical engineering. Although the improvements are of fundamental simplicity, their practical effect is such as to considerably increase both the quality and quantity of the product. Especially is this so in regard to modern halftone multiple color and tint block printing.

The improvements relate entirely to the inking apparatus. The ink fountain has been elevated and set back so that the ductor roller deposits its ink directly upon the changer. Hence the fresh ink from the fountain is immediately distributed; is again passed to the two distributing rollers and re-distributed, the finishing touch being imparted by the reciprocating action of the main cylinder.

The vibrator frame is provided with an adjustment for taking up shrinkage of the composition and utilizing either light or heavy contact on the fountain cylinder.

Thus streaky ink can neither reach the cylinder nor be imparted to the form rollers.

When the carriage is latched up, which is done at will, the feed of the fountain automatically ceases. Consequently when the form rollers are again put in action, the delivery of ink to the form is precisely the same as before.

The carriage after it has passed to the lower termination of its movement, is provided with means for latching out all of the form rollers, whereby none of the rollers make contact upon the form as they pass back upwardly. Then when the carriage approaches the latches are automatically relieved and the form roller boxes snap back into their proper position for re-inking.

This feature of single rolling is quite at variance with the views usually entertained; but a close analysis of the matter from the present view-point will show that several previous assumptions were erroneous. The fact remains, however, that the results speak for themselves, and it has been proven that this feature insures even and efficient distribution, free from streaking on large and solid surfaces.

The 2-B's are of the lightest construction, but are very sturdy machines and are amply strong and rigid. The 5-B's are particularly intended for extra hard and heavy halftones multiple color, tint block and mixed form printing. They will stand about fifty per cent more pressure at the platen than the 2-B presses.

We Recommend for Speed of Operation, Style B, as Follows

In the Quarto, twenty-four hundred impressions an hour is frequently realized. In the Half Medium and Half Super Royal, eighteen hundred. As between the 2-B and 5, or 6-B relative merely to the speed no difference need be observed.

All main shafts, pinion shafts, crank pins and cylinders are ground on live centers, thereby producing a faultless surfacing and practically true and uniform dimensions. All steel connections are hardened and ground. Babbitted bearings are hammered and then bored. Bronze bearing sleeves and bushings are bronze, copper and tin. Chases are made from cold drawn semi-mild steel bars, milled to interlock.

The parts included with each Style B Press are as follows: Six form roller stocks; four distributor stocks; two vibrator stocks; four distributor stock boxes; four adjusting clamps; six form-roller wheels, one and fifteen-sixteenths inches in diameter; six form roller wheels, one and seven-eighths inches in diameter; five steel chases, interlocked; two feed tables; two feed-table floor standards; three frisket fingers; one treadle (for Quarto only); three wrenches. With Style 6, one and one-eighth inch steel plate.

List Prices and Important Data Concerning the Laureate and Colt's Armory Machines

STYLE AND SIZE OF PRESS	Floor Space without Feed-tables Inches	Face of Feed-table Inches	Opening through which passes when Assembled Inches	Motor Horse Power Recommended	Width of Belt Inches	Face of Drive Pulley Inches	Diameter of Drive Pulley Inches	Revolutions of Fly-wheel each Impression	Highest Speed Advised	Shipping Weight Pounds	List Price
The Laureate Model J, Half Super Royal (14x22)	53x54	14½x22	53	1	3	3¼	14	8¼	1400	4100	\$900 00
The Laureate Model T, Half Super Royal (14x22)	50x54	14½x22	50	1	3	3¼	14	8¼	1800	3900	825 00
Colt's Armory Style 6-B, Half Super Royal (14x22)	48x51	14½x22	51	1	3	3¼	14	8¼	1600	3405	775 00
Colt's Armory Style 5-B, Half Super Royal (14x22)	48x51	14½x22	51	1	3	3¼	14	8¼	1600	3405	700 00
Colt's Armory Style 2-B, Half Super Royal (14x22)	48x44	14½x22	43	1	2½	3¼	14	8¼	1800	3075	625 00
Colt's Armory Style 6-B, Half Medium (13x19)	48x46	14½x22	46	1	3	3¼	14	8¼	1600	3205	660 00
Colt's Armory Style 5-B, Half Medium (13x19)	48x46	14½x22	46	¾	3	3¼	14	8¼	1600	3205	635 00
Colt's Armory Style 2-B, Half Medium (13x19)	41x48	14½x22	41	¾	2½	3	14	8¼	1800	2875	535 00
Colt's Armory Style 2-B, Quarto Medium (10x15)	45x33½	12x18	33½	½	1¾	2½	12	6	2000	1870	375 00
Colt's Armory Style 6-A, Half Super Royal (14x22)	48x54	14½x22	51	1	3	3¼	14	8¼	1700	3405	725 00
Colt's Armory Style 5-A, Half Super Royal (14x22)	48x51	14½x22	51	1	3	3¼	14	8¼	1700	3405	650 00
Colt's Armory Style 2-A, Half Super Royal (14x22)	48x44	14½x22	43	¾	2½	3¼	14	8¼	1700	3075	625 00
Colt's Armory Style 6-A, Half Medium (13x19)	48x46	14½x22	46	1	3	3¼	14	8¼	1800	3205	625 00
Colt's Armory Style 5-A, Half Medium (13x19)	48x46	14½x22	46	1	3	3¼	14	8¼	1800	3205	600 00
Colt's Armory Style 2-A, Half Medium (13x19)	41x48	14½x22	41	¾	2½	3	14	8¼	1800	2875	500 00
Colt's Armory Style 2, Quarto Medium (10x15)	45x33½	12x18	33½	½	1¾	2½	12	6	2200	1870	350 00
Colt's Armory Cutting and Scoring Press Style 5 (20x30)	54x62½	18x28	54	2	3½	3¾	17¾	5¼	2400	5715	615 00
Colt's Armory Cutting and Scoring Press Style 28x41				3	3½	3¾	17¾	5¼	1800	7675	1000 00
Colt's Armory Eccentric Action Cutting and Scoring Press Style 2 (26x38)	60x56	24½x36½	56	3	4	6½	30	9¼	1500	10320	1500 00

All John Thompson and Colt's Armory Presses are sold f. o. b. the factory.

The above prices are f. o. b. factory, at Long Island City, N. Y., and include ink fountain, pulleys, belt shifter fork, hand lever, brake and supporting bracket; also boxing and delivering to railroad or steamer.

Double inking device for the regular Colt's Armory Printing Press, \$15.00. Steam or gas blank for Style 6-A and Model J Presses, \$100.00 net. Riding form roller changers for Models J and T, \$7.50 each. If the fountain is not wanted, deduct \$20.00 list for the Quarto and \$25.00 for the larger sizes; also for power fixtures deduct \$15.00 in any of the sizes. Gas blank with blower for Styles 6 and Model J, \$100.00. Blower to be used in connection with gas blank for Style 6-A Presses, \$25.00.

Prices on gauges for book cover or wood printing for Style 6-A press will be quoted on request.

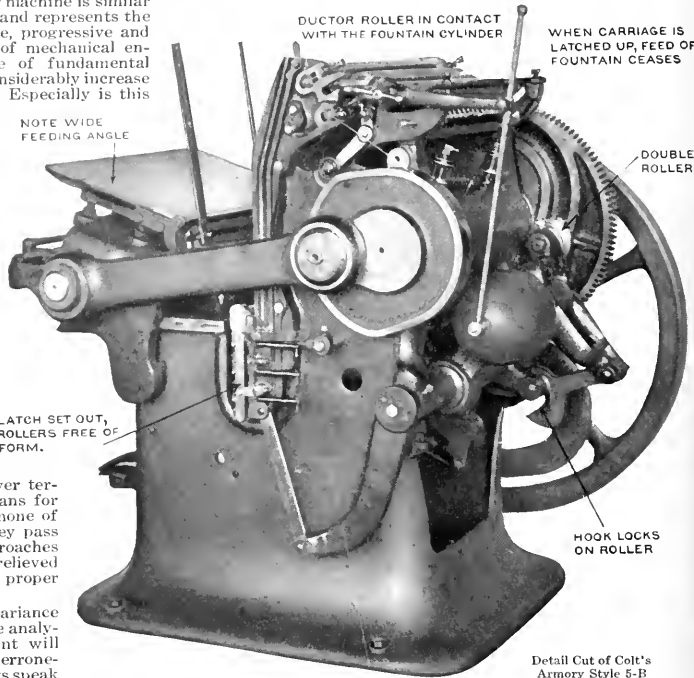

Detail Cut of Colt's Armory Style 5-B

Colt's Armory Printing Presses

The Colt's Armory Half Medium and Half Super Royal in the Style 2-A construction are high speed presses equal to the average requirements of high-class printers for all letter press and half-tone printing.

Colt's Armory Printing Press, Half Medium, Style 2-A

In the 2-A Style the platen may be adjusted forward or backward by means of impression bolts, the head of outside bed bolt at the corners, being first relieved from contact if the platen is to be drawn from the bed. This, however, is rarely necessary. Little need be said about these machines, as thousands of them are in use and giving the greatest satisfaction. The Half Medium Style 2-A has a heavy frame made from new patterns. The size of the chase inside is thirteen by nineteen inches. The following parts are included: Six form-roller stocks, four distributor stocks, two vibrator stocks, one changer, four distributor stock boxes, four adjusting clamps, twelve form-roller wheels, five steel chases, two feed tables, two feed-table floor standards, three frisket fingers and three wrenches. Floor space of table base, thirteen and one-half by thirteen and one-half inches. Distance from center of pinion shaft to floor, nineteen inches.

For list price and dimensions of machine see table on page 115

Half Super Royal, Style 2-A

This press also has heavy frame made from new patterns. Its size is fourteen by twenty-two inches inside of chase. The following parts are included: Six form roller stocks, four distributor stocks, four distributor stock boxes, two vibrator stocks, one changer, four adjusting clamps, twelve form rollers, five steel chases, two feed tables, two feed-table floor standards, three frisket fingers and three wrenches. Floor space of table base, thirteen and one-half by thirteen and one-half inches. Distance from center of pinion shaft to floor, nineteen inches. This is a high-speed press and is equal to the average requirements of high-class printers.

For list price and dimensions of machine see table on page 1162

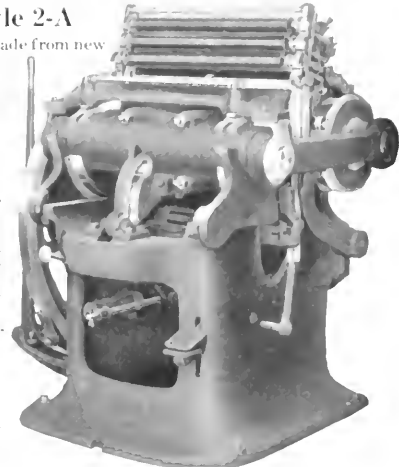

Colt's Armory, Style 6-A, Half Medium, 14x19 inches inside of chase.

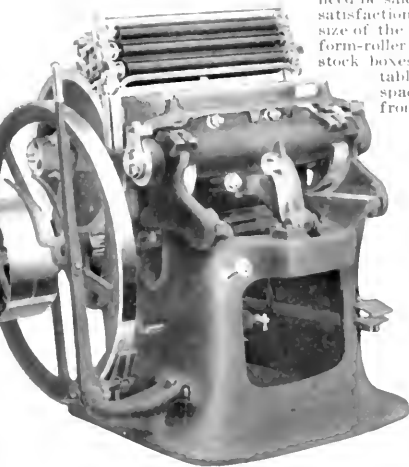

Colt's Armory, Style 2-A. Made in two sizes: Half Medium, 13x19 inches, and Half Super Royal, 14x22 inches (inside chase measurements).

Colt's Armory Printing Press, Style 6-A

The Colt's Armory Half Medium Style 6-A Press is adapted for nearly all kinds of work that can be done on the Styles 2 and 5, and also for certain classes of embossing, book cover stamping, printing on wood, cutting and scoring, and the like, hot or cold. Made in two sizes, Half Medium and Half Super Royal. This press is made with heavy frame from new patterns, size thirteen by nineteen inches inside of chase. Gauges for book cover or wood printing are charged for extra, price depending upon the requirements. The following parts are included: Six form roller stocks, four distributor stocks, two vibrator stocks, one changer, four distributor stock boxes, four adjusting clamps, twelve form-roller wheels, five steel chases, two feed tables, two feed-table floor standards, three frisket fingers, two wrenches and one one-eighth inch steel plate. Floor space of table base, thirteen and one-half by thirteen and one-half inches. Distance from center of pinion shaft to floor, nineteen inches.

For list price and dimensions of above machines see table on page 1163

Gally Universal Embossing Press

The Gally Universal Embossing Press is a combination of strength, power, speed and facility, and the illustration affords a good idea of its massiveness and strain bearing qualities. On this press the impression is obtained by means of a rocking and sliding platen held at the point of impression by lugs, to which is added a steel gibbed lock at the front of the platen and in the line of the face of the embossing dies. This lock holds the platen in position and exact register for the dies and effectually prevents the bridge from raising from its seat and the platen from tilting in either direction. This device is a new patented feature of the Gally Embossing Press, is of great value, and is used exclusively on the Gally presses. This principle permits

of developing for the purpose practically unlimited strength and power. The largest press made can be run at eighteen hundred perfect impressions per hour. The platen is set low, is easy to feed to and is under absolute control by means of the instantaneous impression throw-off and impression adjuster. The presses are guaranteed not to stall on the heaviest work. Steel sections are welded into the wide double gears at the point in the periphery where impression is sustained. The main shaft is made of five and one-quarter inch steel with solid reamed bearing through the bed. The driving shaft, which is of two and one-quarter inch steel, runs in a series of six bearings and there is an end floor support to each extremity of the shaft. The platen bridge shaft is of three and one-eighth inch steel. There are six hundred pounds of iron in the rims of the two fly wheels, which revolve five and one-quarter times to each impression. The driving and loose pulleys are sixteen inches in diameter and are intended to carry a three and three-quarter inch belt. The platens of the press are usually set to the height of type. For cold process work, the dies, if blocked type high, may be locked in chases. For hot process work, a steam blank or a gas blank and a steel die plate are used, and the platen blank is removed to provide space for the dies. One steel plate to hold the dies, with screws and dowel pins, will be supplied with each steam blank, or gas blank, without extra charge.

List Prices of Gally Embossing Presses

No. 1 Gally Embossing Press, 21" x 22 inch bed plate	\$800 00
No. 2 Gally Embossing Press, 24" x 26 inch bed plate	900 00

Gally Cutting and Creasing Presses

The Gally Cutting and Creasing Presses are of great power and strength, and are unequalled for their speed and facility of operation. Although these machines are extremely powerful they are easily handled for cutting and creasing. Each has the improved platen movement, is remarkably simple in operation, and its solidity of construction insures lasting qualities. Write for fuller details and net prices.

List Prices of Gally Cutting and Creasing Presses, Complete with Power Fixtures

No. 1 20" x 30" inches inside chase	\$700 00	No. 3 27" x 40" inches inside chase	\$1,200 00
No. 1 1/2 22" x 30" inches inside chase	800 00	No. 4 30" x 44" inches inside chase	1,150 00
No. 2 23" x 31" inches inside chase	900 00		

Security Roller Cabinets

Economy and efficiency in all departments of a printing establishment are essential in these days of increased expenses and great competition. In the press room, where roller troubles often abound, time and money may frequently be saved by adding to the equipment Security Roller Cabinets. These are made entirely of iron and steel and are dust, fire, water and vermin proof. They greatly assist in prolonging the life of rollers and as they contain a liquid substance "Rollerlife" to preserve winter rollers and "Rollerdry" to keep summer rollers in condition, they will soon save their original cost. The Rollers are held in a vertical position thus preventing the sagging of the composition or the loss of rotundity. Unless the rollers are dirty from paper dust they may be placed in the Cabinet and "Rollerlife" will keep the ink from drying. In hot weather if the rollers sweat they should be placed in the Cabinet and an application of "Rollerdry" will materially assist in restoring them to their proper condition.

Security Roller Cabinets are made for any size cylinder press and will hold eighteen four-inch rollers. In ordering give the extreme length of roller core over all. The Cabinets are made either stationary or revolving and require but twenty-four inches of floor space.

The very old fashioned and wasteful method of placing rollers in any odd corner or out-of-the-way place should no longer exist in the well-managed printing office. The Security Roller Cabinets represent a great improvement in this respect, as they obviate the danger of damage and tend to increased efficiency. Taking into consideration the convenience and economy they effect, they are not high priced. A circular, fully describing the Security Roller Cabinets, will be mailed free upon request.

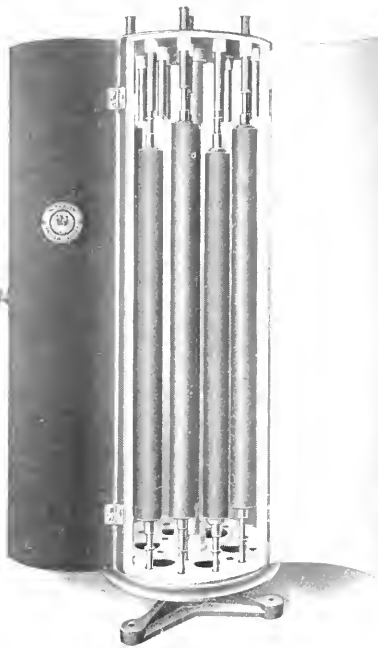

Security Adjustable Tube Cabinet, for Presses having Rollers of varying lengths

Security Job Press Cabinet, Roller and Ink Storage Side

The Security Cylinder Solid Head Roller Cabinet holds 18 rollers, 4 inches in diameter or under. It is made of iron and steel occupying 23 inches of floor space. Has three doors, revolves and can be placed in a corner or near a wall. List price per inch \$1 10
 The Security Cylinder Adjustable-Tube Roller Cabinet holds 18 rollers, 4 inches in diameter. It provides for presses having varying length of form, angle and fountain rollers. It is made of iron and steel occupying 23 inches of floor space. It has three doors, revolves and can be placed in corner or near wall. List price per inch \$1 20

Prices of Security Roller Cabinets

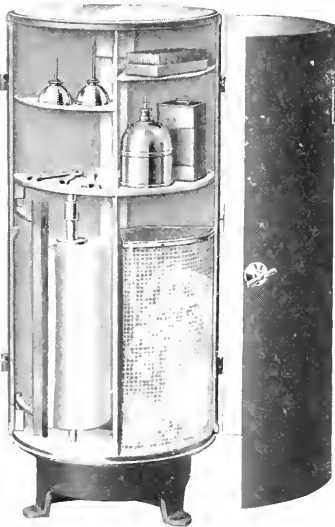

Security Job Press Cabinet, Tympan Paper, Cleaning Rag Basket, Oil and Benzine Cans, Brush and Tool Side

Security Job Press Roller Cabinet

This is a very attractive piece of iron and steel furniture constructed to hold every job press requisite including composition rollers, tympan paper, waste, ink, benzine can, gauge pins, wrenches, etc. Has plate glass top for ink mixing. Occupies a floor space of seventeen inches, and holds fourteen rollers of uniform length of cores. It is adjustable for any length of rollers. Has two doors, revolves and can be placed in corner or near wall. Built to last a life time. Weight, 175 pounds. Price \$45 00

The Justrite Oily Waste or Rag Can

This Can has received the highest commendation of engineers allied with insurance interests and each Can bears the official label of the National Board of Fire Underwriters, thus insuring protection against other inferior oily waste cans.

It is the only automatic waste can made. The patented foot lever is novel and appeals to all users. A slight pressure of the foot raises the cover and both hands are free to insert the rags. This obviates all desire to block the cover open and greatly increases the efficiency of the Justrite Can over all others. On the removal of the foot from the handle the cover closes automatically. It is easy to carry, absolutely safe, convenient, clean and durable.

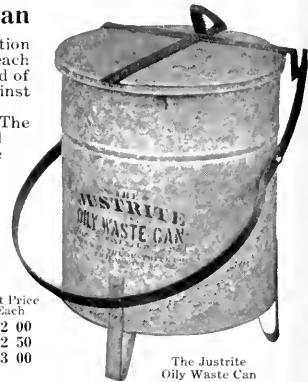

The Justrite Oily Waste Can

Prices of Justrite Waste Cans

Size Exclusive of Legs	List Price Each
No. 1, 11 ³ / ₄ x 13 inches	\$2 00
No. 2, 12 ¹ / ₂ x 14 inches	2 50
No. 3, 13 ¹ / ₂ x 15 inches	3 00

The Burch Perforator

This little device perforates successfully while printing, without inking the stock or cutting the rollers. Although a printer may already have a complete perforating equipment, the Burch Perforator will save the second handling of the sheets. The base of the device is of solid metal, consequently no matter how much pressure is exerted by the quoins, it cannot affect the perfect working of the blade. The head can project into the furniture and needs no support, so no time is wasted on the stone. One simply locks the perforator in the form and the press does the rest. No quad or other makeshift is necessary to paste on the tympan.

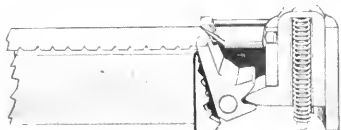

The Burch Perforator—Open



The Burch Perforator—Closed

Measurements are taken over all; a ten-inch device just fills a ten-inch chase, but perforates only eight and seven-eighths inches; the head in every case takes up one and one-eighth inches.

Sizes and Net Prices of the Burch Perforator

6 inches . . . \$5 00	7 inches . . . \$5 50	8 inches . . . \$6 00	9 inches . . . \$6 50	10 inches . . . \$7 00	12 inches . . . \$8 00
Scoring blades, any length, extra 1 50					

Oswego Automatic Clamp Power Paper Cutters

Economy of operation is the first point to consider in purchasing a cutting machine. In the Oswego Automatic Cutters nothing has been spared to produce the most efficient cutting machines that can be built. Uniform accuracy and reliability are always embodied in these cutting machines. They give the greatest cutting output at lowest cost, quality considered. In adopting them for our special line of power cutters, there is full confidence that we are offering printers, binders, box-makers, and other tradesmen, the best cutting machines now made. Ninety sizes and styles of Oswego and Brown & Carver Cutting Machines are made in the only exclusive cutting machine factory in the world. We sell all of them and can provide for the cutting needs of all, whether the requirements be simple or complicated. Write our nearest House for illustrated catalogue and net prices. Each cutter is supplied with one knife, oiler and wrenches. No overhead fixtures or pulleys of any kind are included.

These machines pack, clamp, and cut a pile automatically. The steel indicator band registers position of back gauge. The clamp may be brought down by treadle to see exactly where the knife is going to cut. These machines cut as accurately as the Brown & Carver Hand Clamp Cutters. The automatic clamp is independent of the knife and is powerful and reliable. The stroke is fast and clean. The mechanism is the simplest and there are few moving and wearing parts.

The table is grooved (plain, if desired); front scored one inch lines with brass rule graduated to sixteenths of an inch, back graduated to sixteenths of an inch. Interlocking clamp and back gauge cut work up to three-quarters of an inch. Removable flat plate for clamp prevents clamp fingers indenting fine work. Back gauge is in three parts. Cable gauge movement. Clamp rises six inches.

The line of Oswego and Brown & Carver Paper Cutters, illustrated and described on this and other pages, is unquestionably the very best that human ingenuity and experience can construct. The American Type Founders Company unhesitatingly recommends these machines to printers requiring the very highest grade of paper cutters. Thousands of them are in daily use and in every case they give the greatest satisfaction. If you are contemplating the purchase of an up-to-date paper cutter, permit us to give you additional information and quote you our net prices.

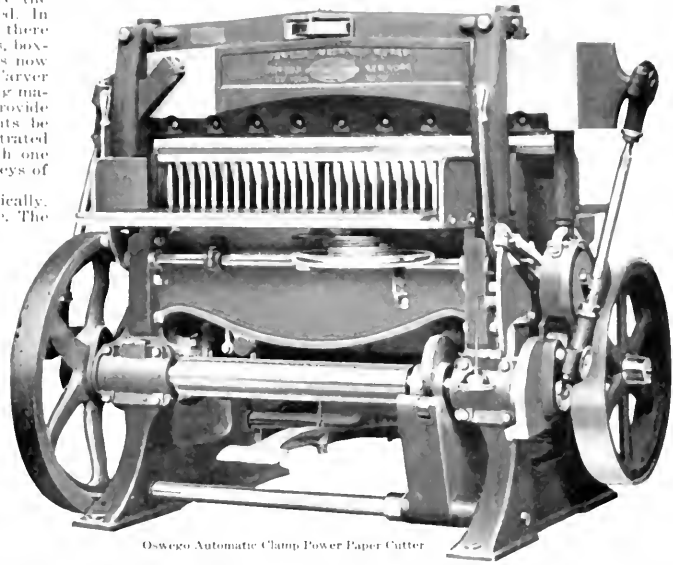

Oswego Automatic Clamp Power Paper Cutter

List Prices of Oswego Automatic Clamp and Foot Treadle Power Cutters

Size	Shipping Weight	List Price	Size	Shipping Weight	List Price	Size	Shipping Weight	List Price
34-inch	5200 lbs.	\$ 750 00	54-inch	9300 lbs.	\$1410 00	68-inch	11750 lbs.	\$2150 00
38-inch	5900 lbs.	875 00	57-inch	9800 lbs.	1550 00	74-inch	12200 lbs.	2600 00
44-inch	6600 lbs.	1075 00	63-inch	11000 lbs.	1850 00	84-inch	13250 lbs.	3000 00
50-inch	7500 lbs.	1300 00	65-inch	11250 lbs.	1970 00			

Oswego Automatic Power Cutters

Automatic Clamp, Foot Treadle and Hand Clamp

We do not show an illustration of the Oswego Automatic Clamp, Foot Treadle and Hand Clamp Power Cutters as these machines are the same in every particular as the regular Oswego Automatic Clamp Power Paper Cutter as illustrated and described above, except that they have the hand clamp parts in addition.

List Prices of Oswego Automatic Clamp, Foot Treadle and Hand Clamp Power Cutters

Size	Shipping Weight	List Price	Size	Shipping Weight	List Price	Size	Shipping Weight	List Price
34-inch	5350 lbs.	\$ 800 00	54-inch	9350 lbs.	\$1490 00	68-inch	11800 lbs.	\$2200 00
38-inch	5950 lbs.	925 00	57-inch	9850 lbs.	1600 00	74-inch	12250 lbs.	2650 00
44-inch	6750 lbs.	1125 00	63-inch	11050 lbs.	1900 00	84-inch	13300 lbs.	3050 00
50-inch	7650 lbs.	1350 00	65-inch	11300 lbs.	2020 00			

There is no other line of paper cutters so extensive as that manufactured by Oswego Machine Works. For years it has made a study and specialty of cutting machines. Its list ranges from the diminutive sixteen inch bench cutter to the mammoth eighty-four inch automatic clamp. This specializing on paper cutters is undoubtedly the reason why the Oswego and Brown & Carver lines have proven so successful. In the Oswego factory every facility is provided for the economical manufacture of these machines, and, consequently, the prices are as low as is consistent with the high quality of the machinery. The American Type Founders Company has used these machines and can vouch that they are as represented.

Oswego Paper Mill Automatic Power Cutters

These machines are the same in every particular as the regular Oswego Auto described above except the clamp and back gauge are plain (not finicked), cutting work up to three and one-half inches; the table is plain (not grooved), and the back gauge is in two parts.

List Prices of Oswego Paper Mill Automatic Power Cutters

Size	Shipping Weight	List Price	Size	Shipping Weight	List Price
34-inch	5150 lbs.	\$ 660 00	63-inch	10850 lbs.	\$1750 00
38-inch	5850 lbs.	785 00	65-inch	11100 lbs.	1870 00
44-inch	6550 lbs.	985 00	68-inch	11600 lbs.	2050 00
50-inch	7450 lbs.	1210 00	74-inch	12050 lbs.	2500 00
54-inch	9150 lbs.	1340 00	84-inch	13100 lbs.	2900 00
57-inch	9650 lbs.	1450 00			

Oswego Semi-Automatic Power Cutters

With Foot Treadle and Hand Clamp

The clamp on these machines may be operated as on the regular Hand Clamp Cutters, or it may be brought down to the work quickly by treadle and will lock automatically on the work or return to the top, as desired. A partial turn of the hand-clamp wheel will give full clamping pressure, and a partial turn, in reverse, while foot is held on treadle, will release the clamp so it will rise automatically to the top. These machines are furnished regularly with cable gauge movement (screw movement, if desired) and pilot hand-clamping wheel (round rim clamping wheel, if desired). Other equipment is the same as regular Hand Clamp Cutters.

List Prices of Oswego Semi-Automatic Foot Treadle and Hand Clamp Power Cutters

Size	Shipping Weight	List Price	Size	Shipping Weight	List Price
34-inch	4600 lbs.	\$665 00	44-inch	6100 lbs.	\$ 990 00
38-inch	5300 lbs.	790 00	50-inch	6900 lbs.	1190 00

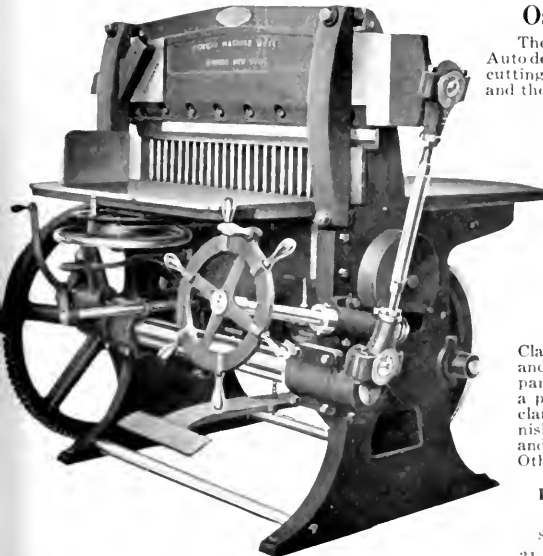

Oswego Semi-Automatic Power Cutter

Oswego Hand Clamp Power Paper Cutters

The high-speed Oswego Power Cutters make twenty-seven cuts a minute. The clamp rises four and three-eighths inches. The clamp and back gauge interlock, allowing work to be cut up to three-quarters of an inch. The back gauge is in two parts on twenty-six inch, thirty inch and thirty-two inch sizes; in three parts on thirty-six inch size. Screw movement for back gauge is furnished regularly; cable movement furnished to order. The hand wheel is graduated to measure the movement of back gauge. The table is plain (not grooved); front scored in one-half inch squares with brass rule graduated to sixteenths of an inch; back graduated to sixteenths of an inch. Round rim clamping wheel (pilot clamping wheel furnished, if desired).

List Prices of Oswego Hand Clamp Power Cutters

Size	Shipping Weight	List Price Power	List Price Hand and Power
26-inch	2300 pounds	\$330 00	\$350 00
30-inch	2500 pounds	355 00	380 00
32-inch	2600 pounds	415 00	445 00
36-inch	2800 pounds	530 00	555 00

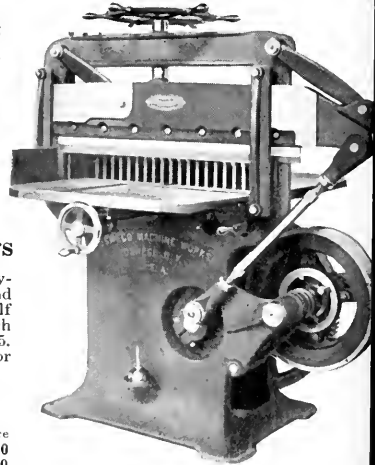

Oswego Hand Clamp Power Cutter

Oswego Semi-Automatic Power Cutters

The high-speed Oswego Semi-Automatic makes twenty-seven cuts a minute. Hand clamp with treadle and with cable gauge. Clamp rises four and one-half inches. Operation the same as the 34 and 38 inch Oswego Semi-Automatic described on page 1165. These Cutters are especially recommended for the moderate-sized plant.

List Prices of Oswego Semi-Automatic Power Cutters

Size	Shipping Weight	List Price
32-inch	2900 pounds	\$490 00
36-inch	3100 pounds	600 00
Furnished for hand and power drive, extra		1 00

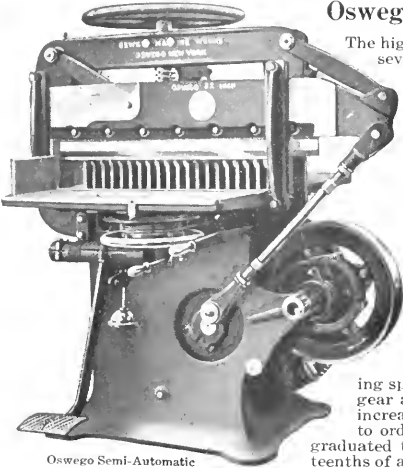

Oswego Semi-Automatic Power Cutter

hand wheel. Round rim clamping wheel (pilot clamping wheel furnished, if desired). Screw movement for back gauge is furnished regularly (cable movement, to order). The hand wheel is graduated to measure the movement of back gauge.

List Price of Oswego Thirty-Three-Inch Combination Hand and Power Drive Cutter

Shipping Weight	List Price
2700 pounds	\$510 00

Oswego Thirty-Three Inch Combination Hand and Power Drive Cutter

Two Speeds

This machine has a mechanical device for changing speed and power. For hand power drive, by shifting gear at right, the speed can be decreased and power increased. Grooved table furnished regularly (plain table to order); front scored one inch lines with brass rule graduated to sixteenths of an inch; back graduated to sixteenths of an inch. Clamp rises four and three-eighths inches. The clamp and back gauge interlock, allowing work to be cut up to one-half inch. Double clamp screws are operated by

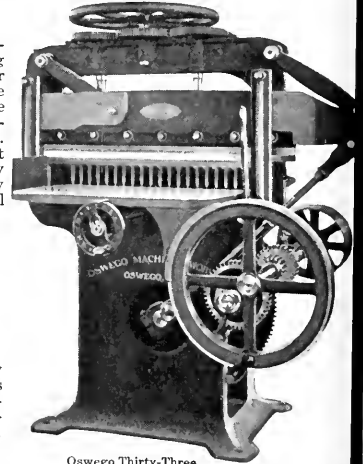

Oswego Thirty-Three Inch Combination Hand and Power Drive Cutter

up to one-half inch. The clamp rises three and one-half inches. Back gauge is in two parts, the split part is flush on one side, forming another side gauge near the middle of machine. This allows the knife to be worn equally. Round rim clamping wheel (pilot clamping wheel furnished, if desired). Gauge screw movement. The hand wheel is graduated to measure the movements of back gauge.

Oswego Hand Wheel Drive Cutters

The driving mechanism of these machines is powerful, and geared so the machine is easily driven by hand power. The table is plain (not grooved), front scored in one-half inch squares with brass rule graduated to sixteenths of an inch; back graduated to sixteenths of an inch. Extra long back side gauge. Detachable front side gauge can be adjusted in and out. The clamp and back gauge interlock, allowing work to be cut up to one-half inch. The clamp rises three and one-half inches. Back gauge is in two parts, the split part is

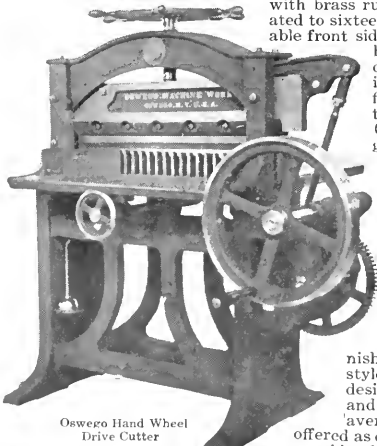

Oswego Hand Wheel Drive Cutter

List Prices of Oswego Hand Wheel Drive Cutters

Size	Shipping Weight	List Price
30-inch	1400 pounds	\$240 00
32-inch	1500 pounds	275 00

Oswego Die-Cutting Presses

Oswego Die-Cutting Presses are furnished in nine different sizes and three styles. The extra heavy pattern is designed for the heaviest work, and the heavy pattern for the average run of work. They are offered as carefully designed well-built machines capable of long and satisfactory service.

List Prices of Oswego Die-Cutting Presses

HEAVY PATTERN			
Size	Shipping Weight	List Price	
30x12 inches	3500 pounds	\$420 00	
30x18 inches	3600 pounds	440 00	
36x18 inches	3800 pounds	480 00	
EXTRA HEAVY PATTERN			
Size	Shp. Weight	List Price	Size
36x18 inches	4200 lbs.	\$540 00	44x24 inches
36x22 inches	4400 lbs.	560 00	44x30 inches
44x20 inches	5000 lbs.	625 00	60x30 inches
			5200 lbs.
			5600 lbs.
			7400 lbs.

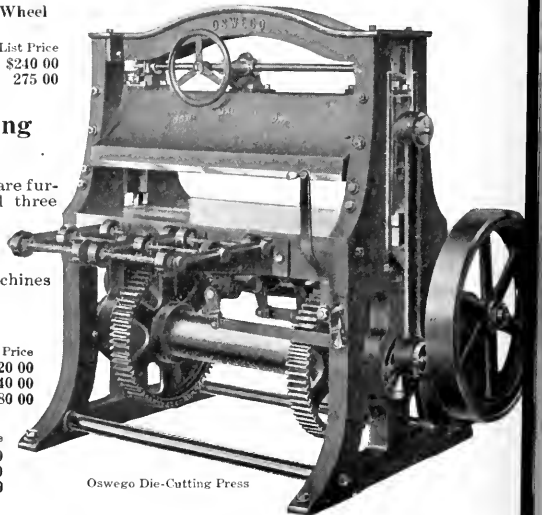

Oswego Die-Cutting Press

Write for Descriptive Pamphlet

Brown & Carver Hand Clamp Power Paper Cutters

Will cut work up to three-quarters of an inch wide, and the knife rises six and one-half inches. Table is grooved to prevent sheets wedging under gauge, or the table is plain, if desired. The table is convenient height, and is arranged for putting on two side extensions in front for handling work before and after cut. The back gauge is in three parts regularly 60 in two parts, or one part, if desired, and, when split, the section forms a side gauge so that work can be cut near the center of knife as well as at the side of the machine. The back gauge is close to the side gauge for small work.

The knife is bolted solidly to the bar, and is instantly adjusted for level or wear by a turn of the connecting rods. The direct crank motion to the knife-bar never allows knife to fall short or to cut into the stick.

The clamp is balanced to run the entire distance, up or down, with one spin of the wheel. The clamp is provided with a flat, removable plate to prevent clamp fingers from indenting fine work.

Solid clamp and back gauge, cutting up to three and one-half inches, are furnished to order.

Pulleys furnished regularly on side shown in cut, but can be furnished on opposite side to order.

The fast screw movement for back gauge, with wheel divided to sixteenths, is furnished regularly on cutters thirty-four inch to eighty-four inch.

Quick cable movement, with indicator reading to sixteenths, will be furnished instead of screw movement, if desired, without extra charge, to order.

The fifty-four inch to eighty-four inch machines can be started from either side by the bar across the front.

The power movement shown in Brown & Carver catalogue on fifty-four-inch to eighty-four-inch machines, for operating back gauge, is furnished to special order only (extra). This labor-saving device moves the back gauge backward or forward by power, a lever swung to the right or left controlling both the direction and the speed. Its indicator wheel reads the position of the back gauge to sixteenths, and, if desired, a micrometer pointer can be attached to read to less than thousandths.

Friction clutch, cut gears, steel shafts, brass rule, case-hardened steel bolts, iron of a durable quality.

All machines subjected to a running test before leaving the works. Illustrated catalogue free.

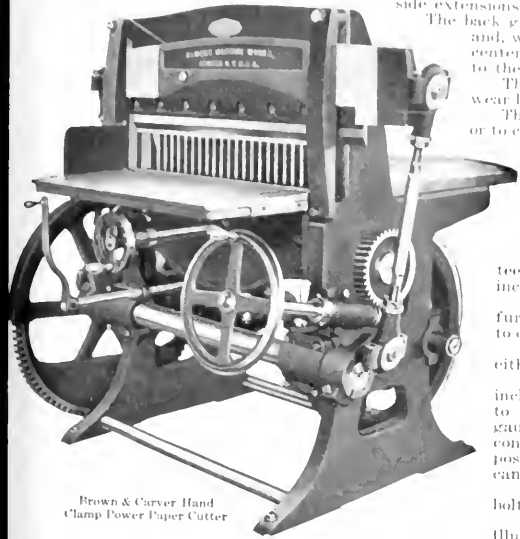

Brown & Carver Hand Clamp Power Paper Cutter

List Prices of Brown & Carver Hand Clamp Power Paper Cutters

Size	Shipping Weight	List Price	Size	Shipping Weight	List Price	Size	Shipping Weight	List Price
34-inch	4500 lbs.	\$ 625 00	54-inch	7800 lbs.	\$1290 00	68-inch	12300 lbs.	\$2000 00
38-inch	5200 lbs.	750 00	57-inch	8200 lbs.	1400 00	74-inch	14500 lbs.	2400 00
44-inch	6000 lbs.	950 00	63-inch	10500 lbs.	1700 00	84-inch	16000 lbs.	2800 00
50-inch	6800 lbs.	1150 00	65-inch	11700 lbs.	1820 00			

Ontario Power Cutters

With Hand Drive Attachment

These machines have points of excellence resulting from thirty-seven years' specializing cutters. The advantage of this specialization is realized by the users of Oswego-made cutters. The Ontario Power Cutters, with hand drive attachment, are adapted for all classes of work. They are fast, powerful, convenient and accurate. The high speed of cut is obtained with low speed of driving wheel, which indicates the easy action and the small power required to drive. Each cutter is one-half inch wider between frames than the listed size.

List Prices of Ontario Power Cutters with Hand Drive Attachment

Size	Shipping Weight	List Price
30-inch	1900 pounds	\$325 00
32-inch	2000 pounds	360 00

32-Inch Oswego Automatic Clamp Cutter

Also furnished with wheel on top for clamping by hand. Clamp rises six inches. The knife makes twenty-seven cuts a minute; production, therefore, is limited only by the ability of the operator to keep pace with the machine.

REGULAR EQUIPMENT. Grooved table; front scored in inch lines with brass rule graduated to sixteenths; back table graduated to sixteenths. Cable gauge movement. Back gauge in three parts; each part may be offset seven inches and cuts work up to three-quarters of an inch. Starting lever on left-hand side.

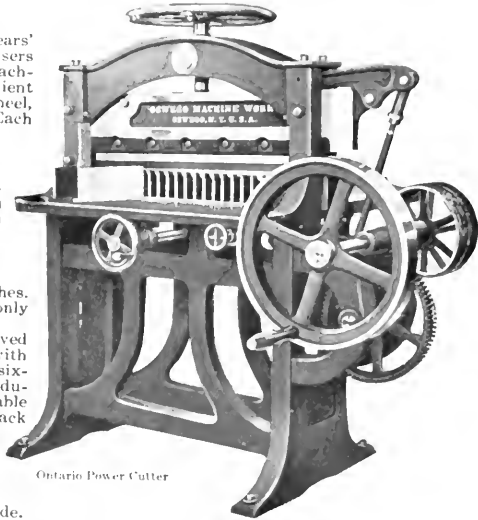

Ontario Power Cutter

List Price of 32-inch Oswego Automatic Clamp Cutter with Foot Treadle and Cable Gauge

Size	Shipping Weight	List Price
32-inch	4500 lbs.	\$570 00

List Price of 32-Inch Oswego Automatic Clamp Cutter with Foot Treadle, Cable Gauge and Hand Clamp Attachment

Size	Shipping Weight	List Price
32-inch	4700 lbs.	\$635 00

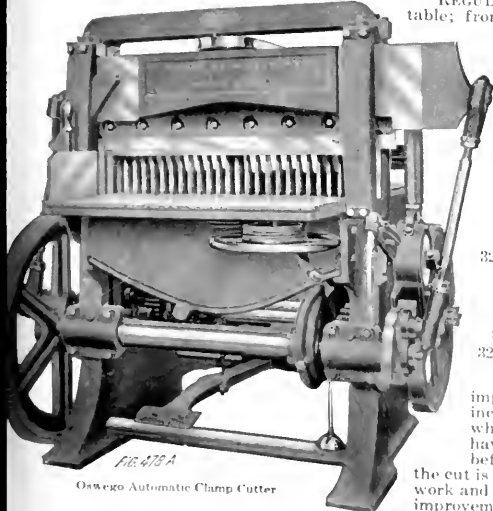

FIG. 473 A

Oswego Automatic Clamp Cutter

The thirty-two inch Oswego Automatic Clamp Cutters have been greatly improved by building them on the same general lines as the regular thirty-four inch, thirty-eight inch and larger Oswego Power Automatic Clamp Cutters, which greatly increase their worth. All the Oswego Automatic Clamp Cutters have this advantage: The heavy pressure of the automatic clamp is applied before the instant of cutting and does not consume power during the cut or after the cut is made. The new Oswego Automatic cuts the maximum quantity of accurate work and saves its purchase price in a few years for this one point alone. Other improvements have been made in the other automatic machines shown in the Oswego list, all tending to increase their efficiency, improve their action and minimize the power required to drive the machines. As a matter of fact, it has been the policy of the manufacturers to sacrifice everything, such as patterns, tools, drawings, stock and effort in order to consummate an improvement and keep the Oswego machines up to that high standard of merit which they have enjoyed for so many years. The makers have gone ever forward with the idea that improvement is the most precious thing in the world and must be incorporated in their machines. This policy has been an expensive one, but it is the best and only one in the long run.

Oswego Hand Lever Paper Cutters

The new toggled lever on the Oswego Lever Cutters, and the double shear, make the cut easier as the knife goes down. Simple and quick adjustment to knife; no long row of bolts to loosen (the knife has a solid backing in the bar instead of abutting against the points of screws). The lever motion is self-contained, the upper and lower turning points being both in the solid, right-hand frame casting.

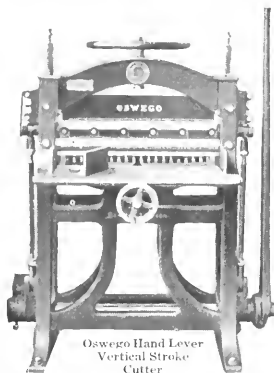

Oswego Hand Lever Vertical Stroke Cutter

List Prices of Oswego Hand Lever Cutters

Size	Shipping Weight	List Price
23-inch	1200 pounds	\$110 00
26-inch	1400 pounds	130 00
30-inch	1650 pounds	175 00
32-inch	1800 pounds	200 00

Oswego Hand Lever Cutters

Vertical Stroke

For textile mills, manufacturing tailors, printers, book makers, novelty manufacturers, who wish to cut serrated or special-shaped edges, or tab cards, or to pink cloth samples. The Oswego Automatic, the Oswego Semi-Automatic, and the Brown & Carver Hand Clamp Cutting Machines, thirty-four inch to eighty-four inch, and the Oswego Bench and Lever Cutters, sizes sixteen to thirty-two inches, are built to order with vertical stroke, and are also built to order with vertical, changeable to shear, stroke.

The vertical stroke permits the cutting of piles of paper, cardboard, cloth, etc., with any special-shaped knives within the capacity of the machine. In pinking

cloth samples on the Oswego Cutters there is no waste of material, as the serrated edge is obtained both front and back of the knife at one stroke where the pile is cut.

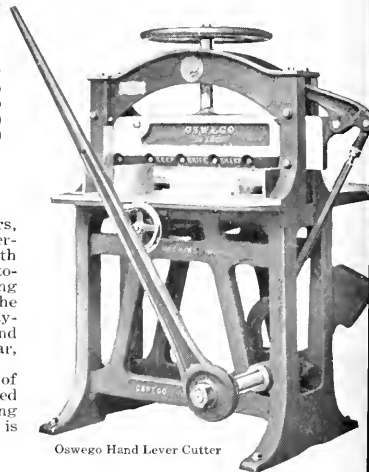

Oswego Hand Lever Cutter

Diamond Lever and Combination Lever and Power Paper Cutters

The Diamond Cutter is a radical improvement in design over any other paper cutter. It involves new features and new principles of construction which are invaluable. The handsome box frame, the symmetrical arch, and the general compactness, simplicity and solidity which characterize it are noteworthy. The box frame, which includes the cross braces supporting the center of the bed, is cast in one piece. The arch is also cast in one piece. Excepting the working parts, the Diamond consists principally of three pieces—the frame, the arch and the bed. This means a vast gain in simplicity and solidity. The Diamond Cutter is arranged for either hand or power. Lever machines are shipped out with holes ready for receiving the bolts which fasten on the power fixtures. These fixtures can be purchased and applied at any time. With each power machine a lever is furnished. By simply unscrewing and changing one stud the power machine is ready to be used by hand. The natural tendency of a cutting machine bed is to sag in the center under the constant strain of heavy cuts. The Diamond Cutter bed rests on two massive adjustable center supports. The result is that it cuts through the last sheet as well as the first. The exact position of the back gauge is shown by the steel back gauge tape, so arranged as to be on a level with the operator's eyes. It is simple, effective and reliable—graduated to sixteenths of an inch. There is a figured scale in the bed, both front and back of the knife, also graduated to sixteenths of an inch. By an ingenious mechanism the speed of the back gauge screw is materially increased. The Diamond screw requires for its operation only one-fourth the average time required by others, yet is under perfect control.

A thumbscrew conveniently placed holds the back gauge securely at any point. The machine is operated by a worm gear, the most powerful drive known. This gear, which is made of semi-steel, runs in oil and is practically everlasting.

The new friction clutch grips the drive wheel instantly and powerfully. At the same time it prevents sudden strain and consequent breakage. It drives the knife at a speed of twenty-four cuts per minute. The same lever which operates the automatic throw-off brings into play an automatic brake which promptly stops the shaft or driving wheel without noise, shock or wear. The back gauge is of the well known "Easily Squared" design. It can be placed parallel with the knife in a moment, no tool but a wrench being required. When sold as a lever cutter, a one-piece back gauge is furnished. *With the Combination Lever and Power Cutter there is furnished a triple split-back gauge which allows the trimming of three lengths of stock at one time. Side gauges are accurately placed. The minimum width of cut is three-quarters of an inch. The maximum is one-half an inch more than advertised width of cutter. The knife adjusting screws, operated by a pin wrench, are in full view of the operator as he stands in front of the machine. The quick-acting clamp interlocks with the back gauge. The clamp rises three and seven-eighths inches from the bed. The clamp raises or lowers one inch every time the wheel makes two revolutions. Each Diamond Cutter is supplied with our counterbalanced curved lever. This is out of the way when up, and waist high at the end of the stroke. It materially lessens the labor of cutting by hand. The bed is grooved for half-inch cutting sticks. They have eight cutting surfaces same as large ones, and cost only one-third as much.

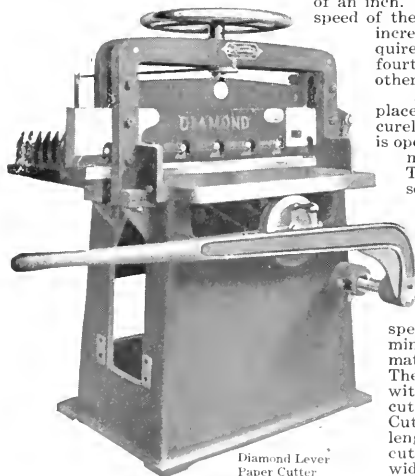

Diamond Lever Paper Cutter



Diamond Combination Lever and Power Paper Cutter

with the back gauge. An extra large, well finished hand wheel is provided. The clamp rises three and seven-eighths inches from the bed. The clamp raises or lowers one inch every time the wheel makes two revolutions. Each Diamond Cutter is supplied with our counterbalanced curved lever. This is out of the way when up, and waist high at the end of the stroke. It materially lessens the labor of cutting by hand. The bed is grooved for half-inch cutting sticks. They have eight cutting surfaces same as large ones, and cost only one-third as much.

Prices and Special Data of Diamond Paper Cutters

DIAMOND LEVER PAPER CUTTERS

Size	Will Cut Paper	Easily Squares Full Width of Machine	Gauges Down to 1/2 inch on Special Order	Net Weight	Price on Skids	Price for Extra Knife
30-inch	30 1/2 inches	30 inches	3/4 inch	1385 pounds	\$150 00	\$14 00
32-inch	32 1/2 inches	32 inches	3/4 inch	1485 pounds	165 00	16 00

DIAMOND COMBINATION LEVER AND POWER PAPER CUTTERS

30-inch	30 1/2 inches	30 inches	3/4 inch	1685 pounds	\$280 00	\$14 00
32-inch	32 1/2 inches	32 inches	3/4 inch	1785 pounds	290 00	16 00

*With each set of power fixtures sold separately, we include a triple-split back gauge to take the place of the one-piece back gauge regularly furnished with the lever cutters.

Write for further particulars regarding the merits of these machines.

Chandler & Price Power Paper Cutter

This Power Paper Cutter is very simple in construction, having no extra parts and all parts interchangeable whenever possible. A deep throat and ample table are salient features. Provision for safety is obtained by the controller knob which must be pulled forward and then given a quarter turn before the clutch engages with gear and the knife descends. It never repeats so the knife cannot fall. The present accident. The speed is twenty cuts per minute, each cut a straight edge. The power mechanism consists of the worm and gear drive, the most powerful. Power may be furnished by either belt or motor. Worm is keyed to worm half, which ends in belt wheel. The worm drives the gear wheel, so that a great power is always had of the knife. Worm wheel runs in oil, thus making the cutter noiseless, easy running and well lubricated. The knife is made of fine steel and is readily adjustable. The knife bar is fitted to housings, which are three inches deep. This avoids deflection from wear. It is easy to clamp because of the extra large hand wheel. The clamp fingers have a broad surface to avoid creasing of stock. The clamping may be as narrow as three-quarters of an inch. All gauges are accurately squared with the knife. Back gauge extends within one inch of side gauge, so small stock can slide by. The table is amply large for all purposes. The legs, braces, table and knife bar will not spring under strain as they are of very heavy pattern. The construction of this Cutter is the strongest possible, and each Cutter is guaranteed.

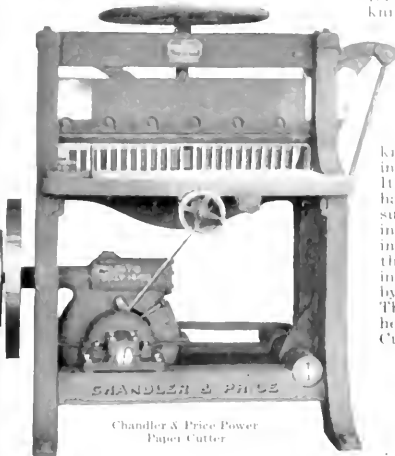

Chandler & Price Power Paper Cutter

from two hundred to three hundred pounds heavier than other makes of the same size, this extra metal is so distributed as to withstand strains.

List Prices and Dimensions

Size Inches	Shipping Weight Pounds	Last Price
23	950	\$110 00
25	1100	130 00
30	1600	175 00

Split back gauges furnished if desired

The legs, braces, table and knife bar will not spring under strain as they are of very heavy pattern. The construction of this Cutter is the strongest possible, and each Cutter is guaranteed.

Last Prices and Dimensions

Size	Shipping Weight Pounds	Last Price
30	2000	\$310 00
32	2100	320 00
34	2200	345 00

Two horse power required for each size

Chandler & Price Lever Paper Cutter

Few parts and utmost simplicity of mechanism is characteristic of this Cutter. While the Cutter is heavier than other makes of the same size, this extra metal is so distributed as to withstand strains. The legs, braces, table and knife bar are of very heavy pattern. Housings two and five-eighths to three inches deep obviate deflection of the knife bar by wear. A deep throat and ample table permit the handling of paper in quantity. Each cutter works quickly and with a minimum of effort being perfectly counter balanced. The weight and lever are adjustable. Clamping is made easy by an extra large hand wheel. To avoid creasing the stock the fingers of the clamp have a broad surface. The back gauge and clamp interlock, clamping as narrow as five-eighths of an inch. The back gauge extends to within one inch of the side gauge. Each gauge is accurately squared with the knife. All parts are strictly interchangeable.

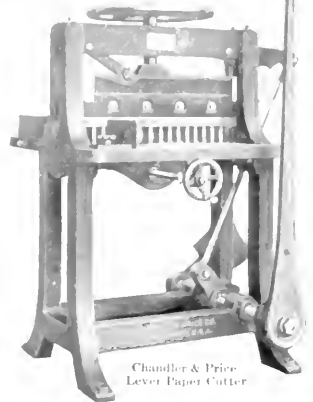

Chandler & Price Lever Paper Cutter

Advance Lever Paper Cutters

The Advance Lever Cutter is mechanically correct, perfectly constructed and combines in the highest degree simplicity, strength and efficiency. Its serviceableness is increased by various helpful devices, the outcome of many years successful cutter-building experience. The frame is so constructed as to afford the broadest possible base and at the same time concentrate the resistance where most needed. A massive brace securely bolted to the side frames near the bottom supports the bed directly under the center, insuring perfect rigidity under pressure of clamp and knife. The bed is finely machine finished and seraped to insure easy action of working parts.

The ingeniously constructed curved lever combines powerful leverage with convenient shape. With the cut completed it is only a short distance below the bed and about waist high to the operator, thus allowing the application of greatest power when most needed.

When the knife is raised the lever is entirely out of the way and does not interfere with the proper handling of stock. The curved shape also permits reinforcing the lever with a heavy rib at the point of greatest strain. Being perfectly counter-balanced there is no danger of the knife falling unexpectedly. The knife is controlled by a link motion, which secures a smooth, easy shear cut with least power.

Gibs and set screws in the frame take up the wear in knife bar, adding materially to the durability of the machine. Side gauges on both sides, front and back of the knife, are a valuable feature, enabling stock to be squared on either side of the cutter, a great convenience and saving of time, while equalizing the wear on the knife. The extra long back gauge is equipped with our "easily squared" device by means of which it may be accurately adjusted to the knife in a moment's time. It interlocks with the clamp and permits the squaring of cuts only three-fourths inch wide. Half-inch cutting sticks are provided, having eight cutting surfaces same as large ones at one-third the cost. A figured scale is cut in the bed, back and front. The back gauge screw is supported at both ends, preventing wear on back gauge nut. Strength, power, durability, and accuracy are thus fully provided for in the construction of the Advance Lever Paper Cutter.

List Prices and Dimensions of Advance Lever Paper Cutters

Size	Net Weight	Price	Price for Extra Knife
23 1/2-inch	660 pounds	\$105 00	\$ 9 00
25 1/2-inch	735 pounds	120 00	10 00
30 -inch	1130 pounds	165 00	14 00
33 -inch	1100 pounds	185 00	16 50

Advance Lever Paper Cutter

Advance Pony Lever Paper Cutters

The Advance Pony Lever Cutters are unequalled for cutting and trimming small work. They combine great strength and durability with ease of operation. Accuracy is assured by side gauge back and front on left side, which also forms our Challenge side frame protector, and our "easily squared" back gauge which comes within one inch of the side gauge. The interlocking back gauge and clamp allows stock to be gauged within one-half inch of knife. Half-inch cutting sticks, eight cutting edges, are an economical feature. Cutters square fully sixteen and nineteen inches respectively, cutting bed being one-fourth inch wider. No springs, gears or cams to get out of order. These machines may be furnished either as bench cutters or with the iron stand shown in the illustration.

List Prices and Dimensions of Advance Pony Lever Paper Cutters

Size	Shipping Weight	Price	Price for Extra Knife
16-inch With Iron Stand as shown in cut	120 pounds	\$71 00	\$6 00
16-inch Without Iron Stand	280 pounds	55 00	6 00
19-inch With Iron Stand as shown in cut	505 pounds	88 00	7 50
19-inch Without Iron Stand	365 pounds	72 00	7 50



Advance Pony Lever Paper Cutter

The Peerless Gem Paper Cutter

The Peerless Gem Paper Cutter is of the well-known "Gem" style and is not an experiment. For thirteen years it has been before the public and has stood the test of practical experience. While some minor changes have recently been made—changes which have constituted improvements of no mean merit—the machine is built on practically the same lines and from the same patterns as the original machine. The leverage is as nearly perfect as anything can be. The frame and bed are well braced. The counterbalance is hung inside the frame out of the way. The knife bar is heavy and accurately finished and the knife is deeper and thicker than usual. The knife bar stop is an important feature as it prevents the breakage of the bell crank, when the lever is thrown up after the cut. The knife bar gibs are important, as any possible wear in the ways may be easily taken up and the Cutter thus made to last for years. The tables are accurately lined in half-inch spaces at right angles to the knife, and the two larger sizes are cross-lined in the same manner on the front part of the table. A metal measuring rule graduated to eighths of an inch, is mortised into the table in view of the operator. The intersecting back gauges are furnished with all sizes, permitting the cutting of very narrow stock. These gauges are adjustable, although they are originally set parallel to the knife when the machines are tested before shipment. The two larger sizes have split-back gauges.

All sizes are furnished with suitable side gauges, both front and back of the knife.

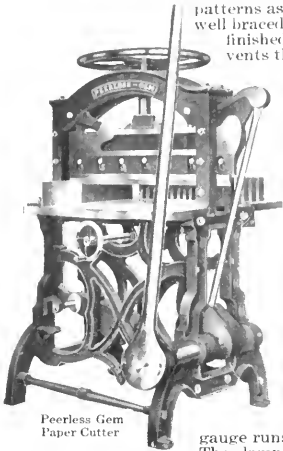

Peerless Gem Paper Cutter

Prices and Dimensions of Peerless Gem Paper Cutters

Size	Actual Width	Weight Pounds	Knife Bar	Knife	Diameter Lever Shaft	Price
23-inch	23 1/4	750	1 3/4	4 1/2 x 3/8	1 3/4 inches	\$115 00
25-inch	25 1/4	850	1 3/4	4 1/2 x 3/8	1 7/8 inches	135 00
30-inch	30 1/4	1400	1 3/4	5 x 1/2	2 inches	185 00
32-inch	32 1/2	1450	1 3/4	5 x 1/2	2 inches	205 00

Oswego Improved Bench Lever Cutters

The cutting lever is balanced so that it is easily raised and lowered. The back gauge has a locking device to hold it in any position. The gauge runs back full size of the machine and cuts as narrow as one-half inch. The clamp rises two and one-half inches. The table is ruled to one-sixteenth of an inch both front and back of knife.

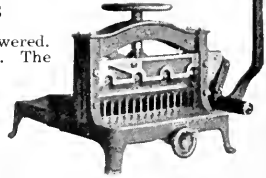

Oswego Improved Bench Lever Cutter

Prices and Weights of Oswego Improved Bench Lever Cutters

Size	Ship. Weight	Price	Size	Ship. Weight	Price	Size	Ship. Weight	Price
16-inch	340	\$60 00	19-inch	375	\$75 00	19-inch on iron stand	575	\$85 00

Paper Cutter Knives

We can furnish, on short notice, Paper Cutter Knives for any of the standard makes of paper cutters. As the prices and sizes for the different makes vary considerably, we do not list them, but we will promptly quote you on any make and size you may require. Do not fail to write us when you are in the market.

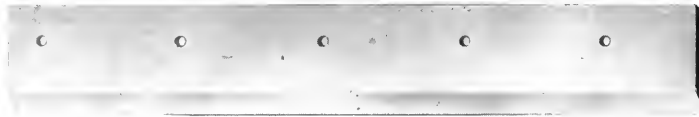

Paper Cutter Knives.



Carborundum Knife Stone

Carborundum Knife Stone

The Carborundum Knife Stone is something entirely new. The manufacturers have made a convenient size and shape to be used on paper cutter knives. After a knife has cut considerable stock and begins to show signs of dullness, the stockman rubs the Carborundum Knife Stone over the paper cutter knife a few times, first using the coarse surface and finishing the sharp edge with the fine side. The stone is four inches in diameter and one and one-half inches in thickness, made with one side coarse grit for rough work, to cut away metal, or take out nicks, etc., and one side fine grit for putting a keen sharp edge on the knife. Price, per stone \$1 50

American Roughing Machine

The demand for a roughing (or pebbling) machine is constantly increasing. Heretofore roughing a job of nicely printed halftones has been considered more or less of a luxury, besides necessitating a great deal of trouble on account of the limited number of machines in operation, when such work was done for the trade. In some of the larger cities plants have been established making a specialty of this work, but the annoyance in shipping the printed stock back and forth, has limited the use of the Roughing Machine. There is no doubt that running the printed stock of any finely printed job through the machines, adds greatly to its appearance. Buyers of printing are generally anxious and willing to pay the extra charge for this work. The process is a simple one, and anyone can do it with the aid of the American Roughing Machine. It is just a matter of the proper amount of "squeeze" and feeding the stock through the machine, as is done on a folding or ruling machine.

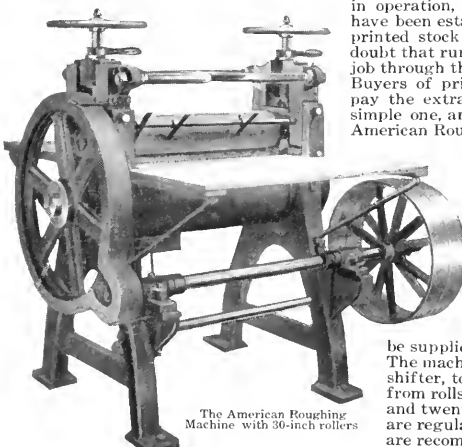

The American Roughing Machine with 30-inch rollers

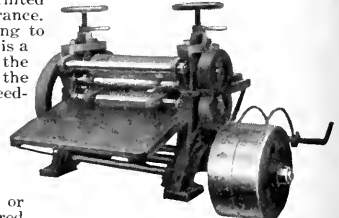

American Bench Roughing Machine with 15-inch rollers

The American Roughing Machine will emboss or rough any kind of paper. The steel roller can be engraved to represent the coarse, fine or medium "eggshell" finish. If desired it can be engraved with the "skytogen" finish, which gives the dotted leather effect. Each machine, as shipped from the factory is equipped to do but one style of roughing. Other rollers can be supplied, engraved to order, at an additional expense, as listed in the table below. The machine is shipped complete for operation, with tight and loose pulleys and belt shifter, together with feed and delivery tables and sets of clips for stripping sheets from rolls. The American Roughing Machine is made in four sizes. The fifteen inch and twenty inch sizes are bench machines. The twenty-four inch and thirty inch sizes are regular high frame or floor machines, as shown in the cut. While the large machines are recommended, the smaller machines will do the work equally as well.

Prices and Details of The American Roughing Machines

Size of Machines	Dimensions Outside	Shipping Weight	Horse Power Recommended	Extra Steel and Paper Rollers	Extra Gears	Prices
15	2 x 2 1/2 inches	450 pounds	1 1/4	\$ 75 00	\$13 00	\$160 00
20	2 1/2 x 3 1/2 inches	625 pounds	2	125 00	16 00	240 00
24	4 x 4 1/2 inches	1800 pounds	2	225 00	30 00	450 00
30	6 x 6 inches	3200 pounds	3 1/2	275 00	36 00	650 00

American Roughing Machines are sold f. o. b. factory

The Boston Wire Stitchers

Durability

Rapidity



Once Used—Always Used
They are Demonstrably
the Very Best

Neatness

Simplicity

The above cut shows twenty-one Boston Stitchers installed one after another in the plant of the McCaskey Register Company, Alliance, Ohio

The Self-Regulating Stitcher

As merchants in machinery for printing plants, we are always on the lookout for the Easy Sellers—machines of such unequalled merit that the sale of one insures orders for additional machines as they may be required. The Boston Self-Regulating Wire Stitchers are in this satisfying class and once used are always used

American Type Founders Company

GENERAL SELLING AGENT

The Boston Wire Stitchers

On certain occasions machines cause almost a complete revolution in the method of manufacture. Previous to the advent of the Boston Wire Stitchers, makers of similar lines were under the impression that the highest perfection in wire stitching had been reached and there was no room for further improvement. The inventor of the Boston Wire Stitcher, however, was not satisfied with the mechanical properties of existing stitchers. He believed that a machine of this class should be, to a very great extent, automatic in its action. He was not satisfied with a machine that required the almost constant supervision of an expert mechanic. He knew that the acme of mechanical perfection was comprised in the word "simplicity" and he worked with this idea solely in view. Every detail of the invention was carefully thought out and proved to the minutest particular before it was adopted. The result has been the production of a machine with wonderfully few parts and with mechanism of the simplest. The Boston Wire Stitcher is the acme of simplicity, combined with the utmost perfection of detail in its work. It is, today, the favorite machine with operators wherever used. That this is so may readily be substantiated by investigating the kind of stitchers used in any large bindery. It will be found that the Boston has been adopted in preference to any other make of stitching machine. These are facts which should be given careful consideration by intending purchasers before additional wire stitching machines are bought. The quick adjustment and rapid manner in which a change may be made from flat stitching to saddle stitching are matters which count for much with operators. The Boston Wire Stitchers, in addition to being exceedingly simple in construction are built strongly for working under every possible condition and present a handsome appearance.

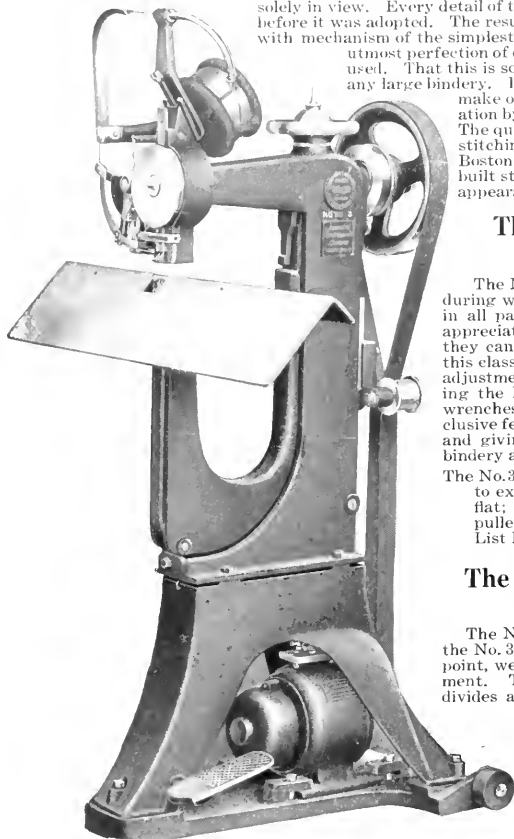

No. 3. Showing Combined Flat and Saddle Table and Electric Motor Equipment

The No. 3 Boston Self-Regulating Wire Stitching Machine

The No. 3 and No. 4 Boston Wire Stitchers have been on the market nine years, during which time more than 2,000 have been sold and are in satisfactory operation in all parts of the United States, Canada and abroad. All users of these machines appreciate their labor-saving features, simplicity of construction and the fact that they can be handled entirely by the operators, something heretofore impossible in this class of machinery. The most prominent feature of Boston Stitchers is the single adjustment for all parts; that is, the operator gauges the thickness of work by turning the hand-wheel, when all other parts are automatically adjusted. No tools or wrenches of any kind are necessary. This self-regulation is important and an exclusive feature in the "Boston," placing it within the complete control of the operator and giving that exquisite sense of wire stitcher satisfaction—a revelation in the bindery and printing office.

The No. 3 Boston Self-Regulating Wire Stitching Machine. Capacity, two sheets to exceeding three-eighths inch. Wire used, 30, 28, 27, 26, 25 round; 21x25 flat; shipping weight, 230 pounds; floor space, 26x26 inches; diameter of pulley, 10 inches; speed, 120 to 140 revolutions a minute; belt, 1½ inches. List Price \$210 00

The No. 4 Boston Self-Regulating Wire Stitching Machine

The No. 4 Boston Wire Stitcher differs from the No. 3 in frame, space back of the stitching point, weight and table arrangement. The saddle and flat table divides at the center, as shown in the "working part" illustration. The flat table is the most efficient ever placed on a wire stitcher and permits gauging back ten inches, something very valuable in calendar and other work requiring long back space. These tables are placed in position and displaced

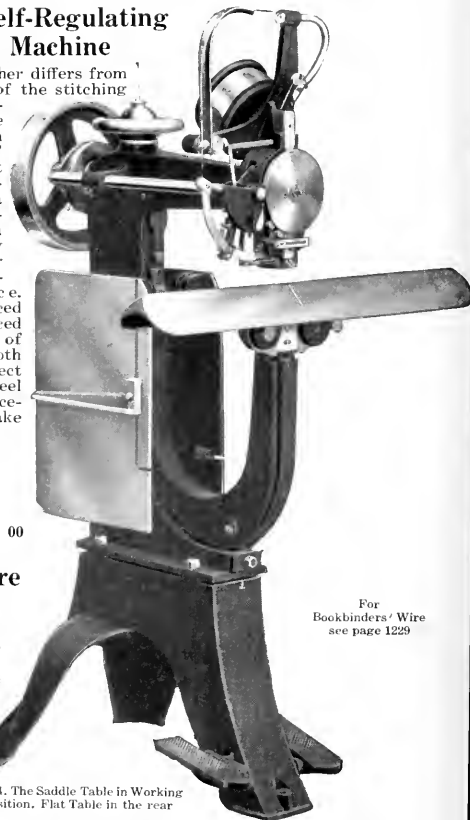

For Bookbinders' Wire see page 1229

No. 4. The Saddle Table in Working Position, Flat Table in the rear

by merely pulling the thumb-lock pins, without the use of tools. Many parts of the No. 3 and No. 4 "Bostons" are interchangeable with each other, and in both sizes worn parts may be instantly replaced, with positive assurance of correct fitting, as each part is made in a jig or tool and in the instances of tempered steel parts, ground to gauge after hardening. No difficulty can be had with replacements, many thousands of dollars having been invested at the factory to make this possible.

The No. 4 Boston Self-Regulating Wire Stitching Machine. Capacity, two sheets to one-half inch. Wire used, 30, 28, 27, 26, 25 round; 21x25 flat; shipping weight, 335 pounds; floor space 26x28 inches; diameter of pulley, 10 inches; speed, 120 to 140 revolutions a minute; belt 1½ inches. The No. 4 is especially valuable for calendar stitching, having ten inches of back space for gauging. List Price \$260 00

The Boston Self-Regulating Wire Stitching Machine

The "working parts," illustration herewith, show all the principal parts of the "Boston"—the wire tension, feed grip, wire straightener, wire cutter and clinchers. These are in full view of the operator; in fact, the wire may be observed from the time it leaves the spool until it is driven into the work—something possible in no other stitcher.

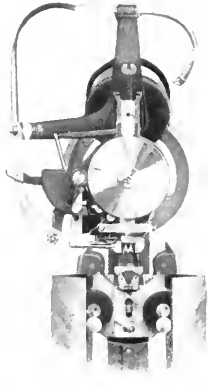

No. 4. The Feed Sector, Wire Cutter, Clinchers and Working Parts

Something New

We here illustrate a new feature in wire stitching machines, and possible only in the "Boston," owing to its wonderful simplicity.

Figure 1 shows the actual size of the half-inch width of stitch for which the Nos. 3 and 4 machines are regularly fitted. If desired, special extra parts can be furnished at small cost (\$18.00) for making a three-eighths inch width of stitch, with a consequent large saving in wire. Figure 2 illustrates this stitch—actual size. The change in the machine can be made in three minutes, and consists of replacing the driving bar, cutter plunger and supporter and slightly shifting the feed sector—work which can be done by the operator. The three-eighths inch stitch is excellent for small booklet and other thin work where wire from No. 30 to No. 25 round is used. We cannot give too much importance to the fact that the tremendous advantage in the Boston Wire Stitcher is its simplicity in construction. The operator can easily take apart and assemble the working parts of the Boston Wire Stitcher.

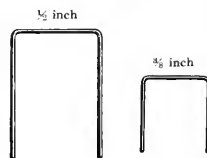

Fig. 1

Fig. 2

construction. The operator can easily take apart and assemble the working parts of the Boston Wire Stitcher.

The No. 7 New Model Boston Wire Stitcher

The No. 7 Boston Wire Stitcher differs from the No. 3 and No. 4 in nearly all features, excepting the single adjustment for all parts. A great many of these machines are in successful operation in every part of the country, and the machine is confidently offered the trade as the most powerful heavy stitcher of its capacity. The work-table is convertible from flat to saddle, or vice versa, by merely pulling the thumb-lock pin, and has special front extension for wide work.

The perfected wire straighteners positively straighten the wire for accurate feeding and driving.

Driver is a simple piece of thick steel, quickly replaced when worn. Clinchers are instantly lifted out of the clincher plate at the top, for changes from flat to round wire if desired. Fixed and movable feeding grips and wire cutters are single pieces, readily replaced when necessary. The cutters are interchangeable, each having four cutting surfaces, and are made of finely tempered steel.

The capacity is from thin pamphlets to books seven-eighths inch in thickness of any regular papers.

The No. 7 New Model Boston Wire Stitcher is specially intended for thick work of various kinds and it does its work well. Extensive experience in the manufacture of these machines has taught the manufacturer the requirements of a heavy stitching machine, and these requirements have been fully met.

There has always been a demand for a stitching machine that would do heavy work in a satisfactory manner, and the No. 7 New Model Boston will fill the bill. The American Type Founders Company will be pleased to give intending purchasers any additional information required.

The No. 7 New Model Boston Wire Stitcher. Capacity, thin stitching to seven-eighths inch. Wire used, 28, 27, 26, 25, 24 round; 21x25, 20x25 or 20x21 flat, the last for heavy work; shipping weight, 400 pounds; floor space, 26x27 inches; diameter of pulley, 12 inches; speed, 100 to 115 revolutions a minute; belt, 1½ inches. List price

\$325 00

Work Table Extension

For attachment to the No. 3 and No. 7 Boston Wire Stitchers (not interchangeable) making available for gauging the space back of the regular table. Nickel plated and attachable by bolts; no fitting necessary. Permits the gauging of work eight and one-half inches back on the No. 3 and seven and one-half inches on the No. 7. The regular work guides and thumb screws operate on these extensions. With this extension it is possible to do the utmost yet required in wire stitching. The outfit is not complete without it. With the Boston Wire Stitcher, equipped with this extension, you can do any job which comes your way.

List price, complete, \$11 25

New Model No. F 14 Boston Wire Stitcher

For Foot Power Only

The only practical foot power wire stitcher on the market. Capacity from two sheets to one-half inch. Has flat and saddle tables similar to the No. 3 and No. 7, and may be operated seated on a stool or standing. Uses wire from No. 30 to 25 round and 21 to 25 flat, the latter for thick work. Built on the lines of the No. 7, with single adjustment for all parts, and has the many exclusive features of the regular power machines. The foot power Boston stitcher was made to meet the demand of the country job offices, where power is not always available or bindery work constant. Its stitching is fully up to the high standard of the power machines, and it is recommended as a thoroughly efficient stitcher in every respect.

New Model No. F 41 Boston Wire Stitcher. For foot power only. Capacity, two sheets to one-half inch. Wire 30, 28, 27, 26, 25 round; 21x25 flat. Weight, 180 pounds; floor space, 21x26 inches. List price, \$155 00

Boston Bindery Tables

Adjustable to any angle, also to height of any Wire Stitcher

These strong and convenient tables (patented) are made by the Boston Wire Stitcher Company to use with the Boston Wire Stitchers, but they are equally desirable for all Wire Stitchers. Each table will operate as a magazine, a saddle or a flat table, and he found valuable in binderies where heretofore a carpenter has had to rig up a stationary affair, admitting of no change. The change in position is accomplished by manipulating the clamps shown in the saddle illustration, the work of a few seconds. Tables are adjustable to any angle; also up and down to conform to the height of the iron table on stitching machine. Base is of iron and heavy enough to counter-balance any work placed on the tops. These tables fill a long-felt need in binderies and are the only equipment on the market for this work. List price, each

\$10 00 Flat

Saddle

Magazine

Boston Bindery Tables may be used with every make of wire stitching machine

Electric Equipment

On the preceding page is shown a No. 3 "Boston" equipped with individual motor. This equipment, suitable for all sizes, takes up no extra space, and consists of foundation bed with rolls for moving; motor, belt, belt tightener; also clamps and bolts for motor. Motors can be furnished for any current—direct or alternating—

130 or 220 volts—direct current	\$65 00
500 volts—direct current	75 00
104 to 110 volts—alternating current, sixty cycles, single phase	70 00
208 volts—alternating current, sixty cycles, single phase	70 00

No. F 14 Boston Wire Stitcher for foot power only

These motors will operate in single, two or three phase circuits, and the first three styles are usually in stock for prompt shipment. Alternating current motors of 125 cycles and voltages not listed above, furnished to order. All, excepting for 500 volt, are obtained from any electrician. 500-volt motors require a starting box.

The Boston Staple Binder

The Boston Staple Binder, like the Boston Wire Stitcher, is built on distinctly new lines, with many valuable features never before used in a stapling machine. It is the nearest approach to a regular stitcher yet devised, and its work is neater and better than that of any stitcher other than the Boston. It is difficult to distinguish its stapling from the best wire stitching. Staples are strung on metal cores (no shrinking or swelling of wood) with paper covers, and placed in the machine at the right-hand side, just as received, without removal from covers. The cores may be lifted out of the stapler and replaced as often as necessary without loss of staples, saving from twenty-five to fifty per cent in staples over all the other machines. The Boston Stapler employs a supporter to prevent buckling staples, this being an exclusive feature and one found only in the regular wire stitching machines. The supporter also permits the use of finer wire than heretofore possible. The result is cleaner work and less cost. Clinchers are the same as in the regular Boston Wire Stitching Machines, operating effectively for even, flat clinching. They will not clog if the stitch be missed, and, being in plain sight and easily detached, will retain their efficiency indefinitely. The driver is a single piece of hardened steel, reversible, and can be instantly replaced when worn without the aid of a wrench. Iron tables are provided at each side of the stitching head with pockets underneath to hold four boxes of staples. These tables are of a height to allow the operator to stand or work from a high stool as may be desired. The Stitcher Work Table tips forward or back for flat and saddle, and is held in the flat position by the back gauge. An extension table is also provided at small cost, making it possible to staple four and one-half inches back.

One of the most important features of the Boston Stapler is the method of using staples. (See core on page 1229.) Wire No. 26, round, is used, the same being slightly flattened in the process of staple making. The staples are strung on metal cores of three hundred and thirty-four each, by automatic machinery. A paper covering protects the staples from moisture, permits of changes from one size to another without waste, and keeps the staples in line for sure feeding.

This is an entirely original idea and will be appreciated by all having a knowledge of loss through old methods.

The feed is positive, the hardened steel pusher being operated by a steel spiral spring which also engages to a locking device at the end of the tin core to hold the same in position. This lock is pulled backward to release the core when sizes of staples are changed. Screw driver and tools are unnecessary after the stapler is assembled, as all changes in staples are made without them. The illustration shows method of driving and how the supporter operates to enable fine wire to be driven to the maximum capacity of the machines. The reversible driver and staple are also shown, the supporter retiring as the stitch is forced through the work. Staples will never buckle when so supported, and the Boston Stapler is the only machine so provided. This feature is of great value and makes the quality of stapling the best.

The foot power Boston Stapler is made in two styles. Style A has a pedestal, and Style B must be screwed to a bench or table, the treadle attaching to the floor. The capacity of both styles slightly exceeds three-sixteenths of an inch, flat or saddle work.

Buyers of the Style B Stapler should note how the same is attached to a bench and that a floor block of wood must be provided.

Staples are put up in packages of five thousand, there being two sizes: one-quarter inch for thin work and three-eighths of an inch for thick work. Shipping weight of Style A, one hundred and ten pounds; Style B, fifty pounds. Floor space, fourteen by twenty-four inches.

Prices of the Boston Staple Binders

Style A, Pedestal	\$35 00
Style B, Bench	25 00

Boston Staple Binder Work Table Extension

For Use on Style A and Style B Boston Staplers

A convenient extension table when it is desired to gauge flat work back of the stapling point. Suitable for calendars, pads, novelties, etc., the distance being four and one-half inches. Made of cast iron, nickel-plated and is bolted to the back of the regular work table. A neatly printed circular describing the Boston Staple Binder will be mailed to you upon request. It will pay you to become fully advised as to the merits of the Boston Staple Binder.

Price, each, net

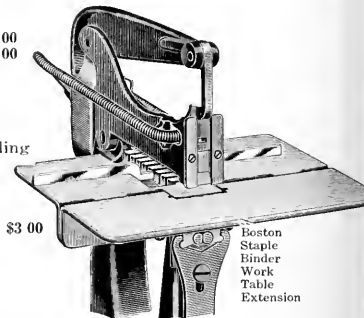

Boston Staple Binder Work Table Extension

\$3 00

Yarger Staple Binder No. 6

(Hercules)

For Flat Work Only—Hand or Treadle Power

A heavy, strong machine, operated by a treadle. It binds from two sheets up to seventy sheets of ordinary book or pamphlet paper. Staples can be inserted three inches from the margin. Country printers will save its cost on one or two jobs, which they usually dispatch to the city, besides avoiding annoying delays. Yarger Staple Binder No. 6 has quick action; binds neatly and securely.

Price of Yarger Staple Binder No. 6

No. 6 Yarger Staple Binder (Hercules) . . . \$10 00

The No. 6 Yarger Staple Binder uses the following Staples: F, ³/₁₆-inch; G, ¹/₄-inch; H, ⁵/₁₆-inch;—put up in boxes of

5,000 of any one size . . . \$0 90

Yarger Staple Binder No. 8

Binds through the fold twelve inches from margin. Provided with a saddle and flat table. It binds pamphlets, calendars, etc., from two pages up to the thickness of one hundred pages through the fold of ordinary book paper. Staples are delivered, driven through the paper and clinched automatically. No adjustments.

Price of Yarger Staple Binder No. 8

Yarger Staple Binder No. 8 . . . \$25 00

Staple used on No. 8 Staple Binder: No. 1, ³/₁₆-inch; in boxes of 5,000 . . . 90

For Prices and Information regarding Binders' Wire and Wire Staples, see page 1229.

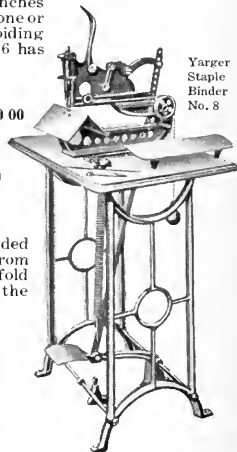

Yarger Staple Binder No. 8

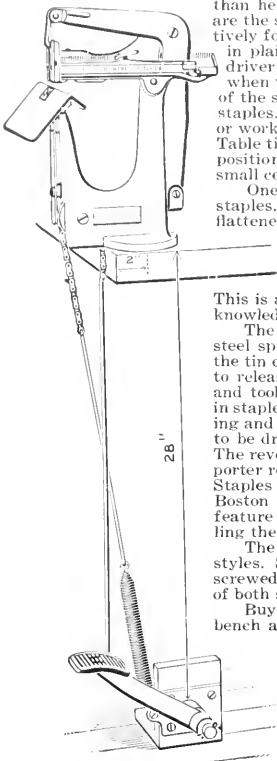

Style B, Bench

28"

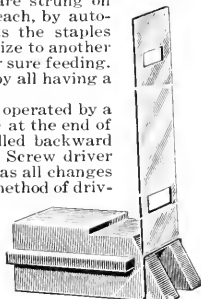

Showing Driver, Staple and Supporter

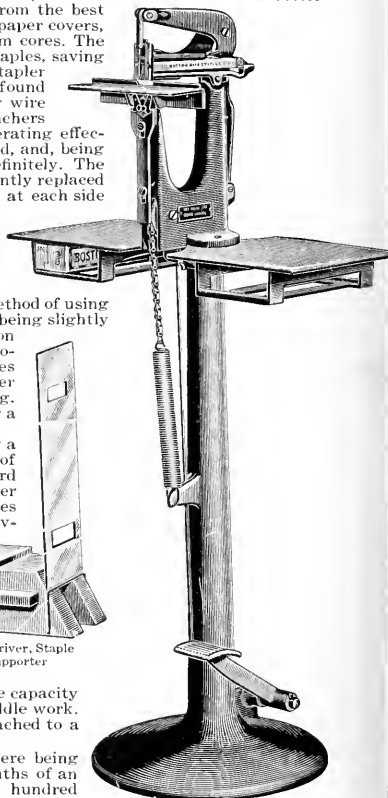

Style A, Pedestal

Yarger Staple Binder No. 6

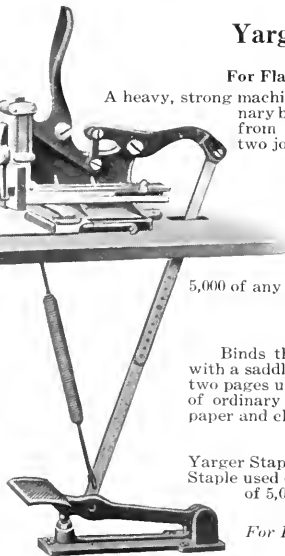

Yarger Staple Binder No. 2

This improved No. 2 Lightning Binder (for flat work only) is a combination of the original No. 1 and No. 2 Binders— one machine now doing the work which formerly required two. Holds two hundred staples at a charge. Staples are delivered and driven through the paper and clinched and can be inserted six inches from margin. There is only one adjustment. By means of a hand screw, which elevates or depresses the clincher. All wearing parts are made of malleable steel to prevent breakage. The action is quick and simple, the work neat and tight. The capacity of this machine is from two sheets up to one hundred and twenty-five sheets of ordinary book or pamphlet paper, using six different sizes of staples from three-sixteenths of an inch to one-half of an inch.

Price of Yarger Staple Binder No. 2

Yarger Staple Binder No. 2 \$25 00
 Staples used on No. 2 Staple Binder: No. 7, $\frac{3}{16}$ -inch; No. 8, $\frac{1}{4}$ -inch; No. 9, $\frac{5}{16}$ -inch; No. 10, $\frac{3}{8}$ -inch; No. 11, $\frac{1}{2}$ -inch; No. 12, $\frac{5}{8}$ -inch, in boxes of 5,000.

Yarger Staple Binder No. 10

The Yarger Staple Binder No. 10 will use six different sizes of staples both round and flat wire. It will stitch through the fold and through the back from two sheets up to seventy sheets (flat staples) and from two sheets up to thirty sheets (round staples) of ordinary book or pamphlet paper, and eleven inches from margin. The wearing parts are all made of malleable steel and not liable to break or get out of order.

Price of Yarger Staple Binder No. 10

Yarger Staple Binder No. 10 with flat and saddle table \$25 00
 Flat Wire Staples used in No. 10 Staple Binder: No. 1, $\frac{3}{16}$ -inch; No. 5, $\frac{1}{4}$ -inch; No. 6, $\frac{5}{16}$ -inch; No. 6 $\frac{1}{2}$, $\frac{3}{8}$ -inch—per box of 5,000 of one size 90
 Round Wire Staples used only in No. 10 Staple Binder: No. 14, $\frac{3}{16}$ -inch; No. 15, $\frac{1}{4}$ -inch—per box of 5,000 of one size 90

Yarger Staple Binder No. 4

Binds one to fifty sheets of ordinary paper. Holds one hundred and twenty-five staples at a charge. Does not clog because one staple must be driven before another can enter. Requires no adjustment. Feeds automatically. Machine is japanned. Knob and ring nickel plated.

Price of Yarger Staple Binder No. 4

Staples used on No. 4 Staple Binder: No. L, $\frac{3}{16}$ -inch; No. M, $\frac{1}{4}$ -inch and No. N, $\frac{5}{16}$ -inch—per box of 1,000 of any one size \$3 00 25
 Also No. 4, $\frac{3}{16}$ inch; No. 5, $\frac{1}{4}$ inch; No. 6, $\frac{5}{16}$ inch, per box of 5,000, one size 90

Acme Sure-Shot Binder

The Acme Sure-Shot Binder is one of the strongest binders ever made for office use. It holds one hundred staples at a charge. It binds to one-quarter inch book paper and cannot clog.

Price of Sure-Shot Staple Binder

Staples used on Sure-Shot Staple Binder—No. X, $\frac{1}{4}$ -inch flat wire; No. XX, $\frac{5}{16}$ -inch flat wire. Per box of 5,000 of one size \$3 00 90

Acme Staple Binder No. 4

This machine is the simplest foot-power binder on the market. It uses fine wire staples only. Has both flat and saddle-back tables. Binds up to one-fourth inch book paper. No adjusting. Can not clog. Shipped ready for work.

Price of Acme Staple Binder No. 4

Staples used in No. 4 Acme Staple Binder: No. 21, $\frac{1}{4}$ -inch fine wire; No. 22, $\frac{5}{16}$ -inch fine wire—per box of 5,000 of one size \$21 00 90

Acme Staple Binder No. 6

The Acme Staple Binder No. 6 is the most complete staple binder sold. Uses both fine and coarse wire staples. Binds to one-fourth of an inch all kinds paper. Has automatic clinching device. Cannot clog. Has both flat and saddle-back tables. No adjustment required at all. Shipped ready for work.

Price of Acme Staple Binder No. 6

Acme Staple Binder No. 6 \$27 00
 Staples used in No. 6 Acme Staple Binder: No. 21, $\frac{1}{4}$ -inch fine wire; No. 22, $\frac{5}{16}$ -inch fine wire; No. 23, $\frac{1}{4}$ -inch coarse flat wire; No. 24, $\frac{5}{16}$ -inch coarse flat wire—per box of 5,000 of one size 90

Acme Staple Binder No. 1

The Acme Binder No. 1 is one of the strongest small binders made. The frame swings on a pivot and lifts high enough to give ample room for putting in and taking out the work. It holds one hundred staples and will not clog. It uses coarse wire staples and binds to one-quarter inch. It is just what is wanted in the small printing office.

Price of Acme Staple Binder No. 1

Staples used; No. X, $\frac{1}{4}$ -inch coarse flat wire; No. XX, $\frac{5}{16}$ -inch coarse flat wire. Per box of 5,000 \$6 00 \$0 90

Breech Loader Staple Binder

The Breech Loader Staple Binder is a very useful machine for large or small offices, as it has a great variety of uses. It will bind paper or pamphlets from one to fifty sheets with wire staples. Holds one hundred staples at a charge.

Price of Breech Loader Staple Binder

Staples used in Breech Loader Binder No. 5; C, $\frac{3}{16}$ -inch, D, $\frac{1}{4}$ -inch, E, $\frac{5}{16}$ -inch. Per box of 1,000 \$3 00 25

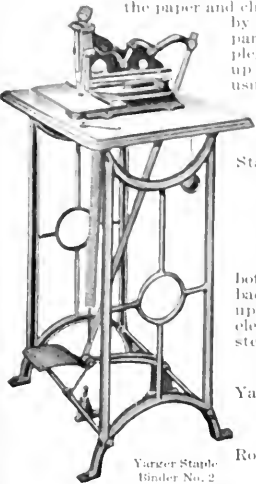

Yarger Staple Binder No. 2

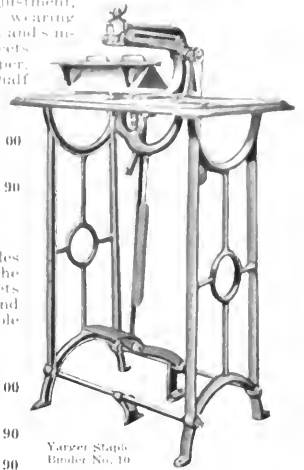

Yarger Staple Binder No. 10

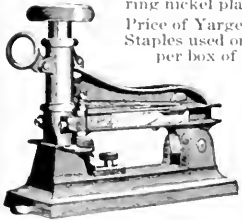

Yarger Staple Binder No. 4



Acme Sure-Shot Binder



Acme Staple Binder No. 6

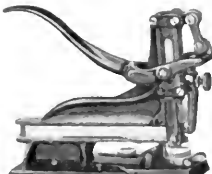

Breech Loader Staple Binder



Acme Staple Binder No. 1

For Prices and Information regarding Binders' Wire and Wire Staples see page 1229

Portland Multiple Punching Machines

During the past few years there has been a tremendous increase in the demand for loose leaf and card index records of all kinds. These new systems have so many advantages over the old methods that they are being universally adopted by banking, mercantile, transportation and manufacturing concerns. Multiple punching machines were invented nearly fifty years ago, being originally designed for punching button holes in paper collars, but the new systems for records and accounting created a demand for a machine which would enable printers, lithographers, bookbinders, manufacturing stationers and specialty houses to take advantage of the opportunities offered in this new field.

The manufacturers of the Portland Multiple Punching Machines, which are illustrated on this page, have realized that modern methods call for modern equipment, consequently they have designed a machine which will enable the printing and kindred trades to do every conceivable kind of punching in the most economical and satisfactory manner possible. A great many thousand dollars have been spent in the equipment of a plant for the manufacture of the Portland Multiple Punching Machines in large quantities. A painstaking exactness is exercised every hour by every branch of a highly skillful organization. Nothing but the best material is used in the construction of the Portland. Every part is made on the interchangeable plan, which means that any one of the thousands of Portlands will be interchangeable in its parts with any other Portland of the same type. By making the parts on the interchangeable plan, perfect alignment is obtained and friction is reduced to a minimum. No other punching machine can begin to give what the Portland gives for the money. When you invest in a Portland you not only get the best punching machine on the market at a price which is without parallel in the history of labor-saving machines, but you get something in addition which is quite out of the ordinary.

You will receive with the machine a guarantee from the manufacturers in which they warrant the machine for one year to be absolutely free from defects in material or workmanship, and they will replace, free of charge, any part of a machine which proves defective in any such respect. This is a guarantee which means something. We have absolute confidence in the manufacturers of the Portland—confidence born of years of satisfactory dealings with them.

These machines are remarkable for a great many reasons. In the first place they are the most convenient and accurate punching machines made. They are designed for punching all kinds of round holes, open holes and irregular shapes for hundreds of different purposes. They are extensively used by specialty houses and novelty manufacturers because an endless variety of punching can be done with absolute accuracy and great rapidity. One of the most remarkable features of these machines is the perfect system of gauges. It consists of two gauge heads which can be placed in any desired position in the machine for the convenient handling of any size sheet, and a side gauge which allows the use of the full length of the thirty-inch table. The back gauges, which are movable in the gauge heads by means of the thumb screws, can be set in any desired position and adjusted to the hundredth part of an inch without removing the gauge heads from the machine. The illustration near the bottom of this page shows the details of the gauge head one-quarter actual size. The side gauge is also capable of the finest possible adjustment, and it is provided with a special swivel feature which is of great assistance when punching stock not perfectly square. A graduated rule, thirty inches long, is inlaid in the table close to the front of the punch heads, thus enabling the operator to

correctly locate the punch heads in the desired position. Any number of holes can be punched at each operation up to the full capacity of the machine. In other words it is possible to punch a row of holes twenty-four inches long in a sheet of stock thirty inches in length, or holes may be punched any distance apart up to the maximum distance of twenty-four inches from center to center. It is safe to say that the system of gauges provided with the Portland will enable the operator to make ready for a job of punching, either simple or difficult, in a fraction of the time usually required by other punching machines. There is a drawer under the punches running the entire length of the machine, into which the paper punchings drop, preventing litter around the machine.

Round hole punch heads and open hole punch heads are shown on the two following pages. The gauge heads are included in the price of the machine, but punch heads are not included, as no two users are likely to require exactly the same equipment. The foot power and power machines are identical with the exception of the method of applying power. The foot power machine is easy to operate because the power is multiplied sixteen times. By this we mean that if the operator should exert a pressure of 100 pounds on the treadle, it would equal 1600 pounds on the punches. The power machine is a marvel of mechanical perfection. A slight pressure on the treadle is all that is required to operate the noiseless power clutch which is another original feature of this remarkable machine. The pulley is fifteen inches in diameter with a three-inch face. One-half horse power will operate the machine to its full capacity. Speed from 125 to 135 revolutions per minute.

The power machines can be supplied with motor direct connected. The motor is attached to the base of the pedestal and power transmitted by means of a noiseless pinion which engages directly with teeth cut in the rim of the fly wheel which takes the place of the pulley. Full information and prices on application.

Not only is the first cost of the Portland very much less than other multiple punching machines, but the price for punch heads is also a great deal lower. The punch heads are shown on the next two pages. You could not purchase a better multiple punching machine than the Portland, although you might pay twice as much for it.

These machines are in use by the United States Government, also by the largest corporations in the country, such as the Standard Oil Company, United States Steel Corporation and General Electric Company, but our records show that the great majority of the first thousand Portlands were sold to printers and bookbinders. Some of these concerns are quite small, but they are enterprising and have found the Portland to be a great money-earner.

Portland Multiple Punching Machine, foot power, shipping weight 480 pounds. Price \$60 00
 Portland Multiple Punching Machine, power, shipping weight 600 pounds. Price 90 00

Portland Multiple Punching Machine, foot power, shipping weight 480 pounds. Price \$60 00
 Portland Multiple Punching Machine, power, shipping weight 600 pounds. Price 90 00

Send for pamphlet giving complete information regarding the Portland Multiple Punching Machines.

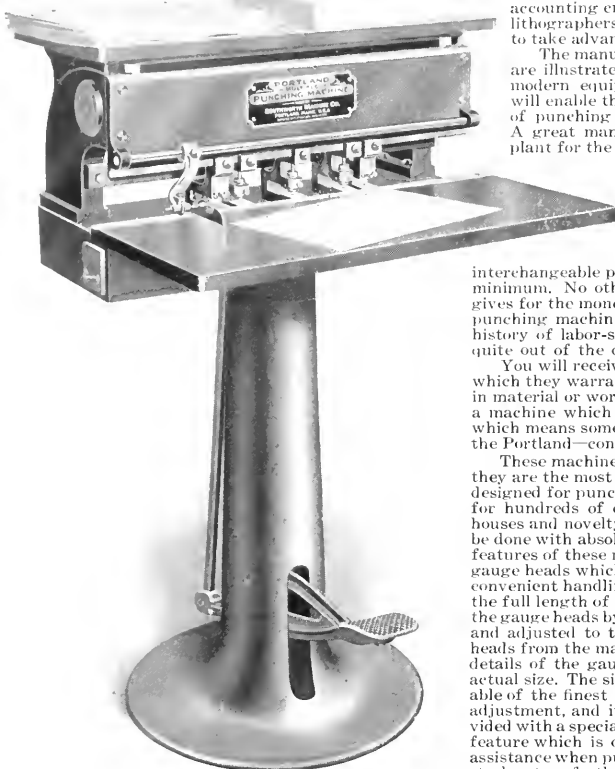

This illustration shows foot power machine equipped with three round hole punch heads with Punching Sets No. 375. The Punch heads are not included in price of machine, as no two users are likely to require exactly the same equipment.

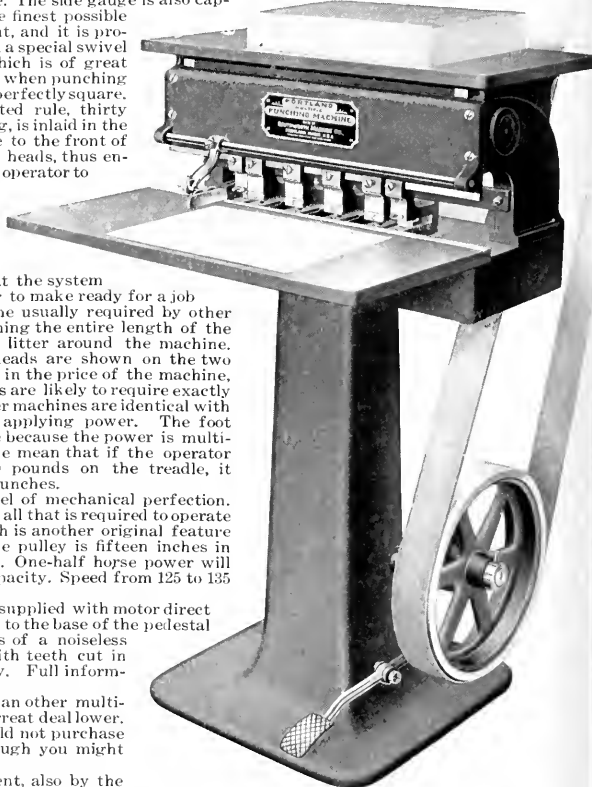

This illustration shows power machine equipped with four open hole Punch Heads Style M1. Punch heads are not included in the price of machine, as no two users are likely to require exactly the same equipment.

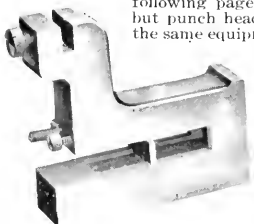

Illustration showing details of gauge head, one-quarter actual size

the rim of the fly wheel which takes the place of the pulley. Full information and prices on application.

Not only is the first cost of the Portland very much less than other multiple punching machines, but the price for punch heads is also a great deal lower. The punch heads are shown on the next two pages. You could not purchase a better multiple punching machine than the Portland, although you might pay twice as much for it.

These machines are in use by the United States Government, also by the largest corporations in the country, such as the Standard Oil Company, United States Steel Corporation and General Electric Company, but our records show that the great majority of the first thousand Portlands were sold to printers and bookbinders. Some of these concerns are quite small, but they are enterprising and have found the Portland to be a great money-earner.

Portland Multiple Punching Machine, foot power, shipping weight 480 pounds. Price \$60 00
 Portland Multiple Punching Machine, power, shipping weight 600 pounds. Price 90 00

Round Hole Punch Heads and Punching Sets for the Portland

This illustration shows a round hole punch head with punching set. The illustration is one half actual size. Holes may be punched any distance from the margin up to two and one-quarter inches, and any distance apart from one and one-eighth inches up to twenty-four inches. When holes must be punched closer together than one and one-eighth inches it is necessary to use the double round hole punch heads which are generally made for punching holes seven-eighths inch from center to center.

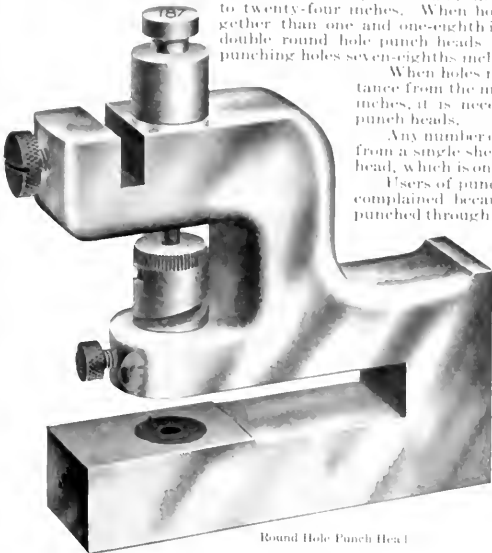

Round Hole Punch Head

When holes must be punched a greater distance from the margin than two and one-quarter inches, it is necessary to use the deep throat punch heads.

Any number of sheets of stock can be punched from a single sheet up to the full capacity of the head, which is one-half inch of stock.

Users of punching machines have sometimes complained because smooth holes could not be punched through a thick pile of stock. Attention is called to the fact that holes with smooth edges are not possible when a large amount of stock is punched at a single operation, for the reason that the punch does not cut each individual sheet, consequently the round discs of paper, which are of a yielding nature, will be forced down through the pile of stock ahead of the punch into the die, leaving a ragged hole. The sheets at the top and bottom of a thick pile will have smooth holes, but those in the middle of the pile will necessarily have rough holes.

The round hole punch heads are made with a half-inch capacity to enable the punching of telephone directories and similar bound books, which are to be hung up; but when punching sheets of paper which are afterwards to be used singly, it is always best to limit the quantity to the number of sheets which can be punched satisfactorily.

The illustrations on the right hand side of this page show a No. 250 punch with die and stripper for same. (Actual size). These three parts constitute a punching set. The set complete is packed in a polished wooden box. Price, \$2.00 for any of the fourteen sizes. Postage, eleven cents.

A punching set can be removed from the punch head and replaced with another size in less than one minute.

These punches, dies and strippers are marvels of mechanical perfection. The stripper, through which the punch passes, insures absolute alignment of the punch and prevents the die and punch from wearing. The stripper, which is made with a spiral groove, is raised or lowered by revolving in order to accommodate the different amounts of stock to be punched.

These Punching Sets are made in the most perfect manner possible by means of specially designed equipment. The finest steel is used and each part carefully hardened by experts and then ground with diamond dust and the finest corundum. There are twenty-seven operations required for the completion of a punching set. Before shipment every punch, die and stripper is carefully tested by means of micrometer gauges, and then assembled in a special testing head to prove accuracy of alignment. If a variation of as much as a thousandth of an inch is detected the part is discarded.

All of these painstaking methods result in the production of punching sets which are as accurate and wear-resisting as human ingenuity can devise.

A complete stock of all sizes of punching sets is always kept on hand ready for immediate shipment. All punching sets and punch heads, shown on this page, are made for interchangeable use. Punching sets are never included in the price of the punch head.

Prices for Round Hole Punch Heads

Round Hole Punch Head, without punching set.	Price	\$1 00
Double Round Punch Head, without punching sets.	Price	8 00
Deep Throat Punch Head, five and a half inches, without punching set	Price,	7 00
These heads are also made with nine inch throat.	Price, with-	10 00
	out punching set	

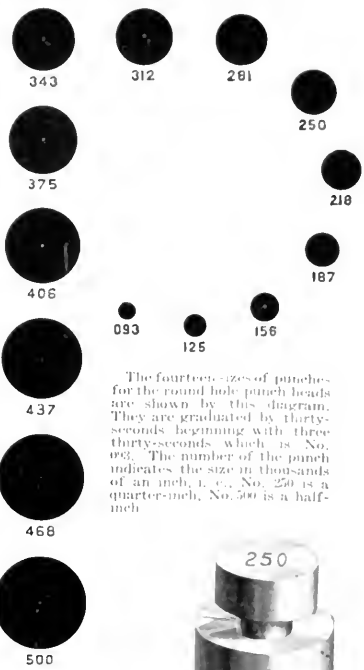

The fourteen sizes of punches for the round hole punch heads are shown by this diagram. They are graduated by thirty-seconds beginning with three thirty-seconds which is No. 93. The number of the punch indicates the size in thousandths of an inch, i. e., No. 250 is a quarter-inch, No. 500 is a half-inch.

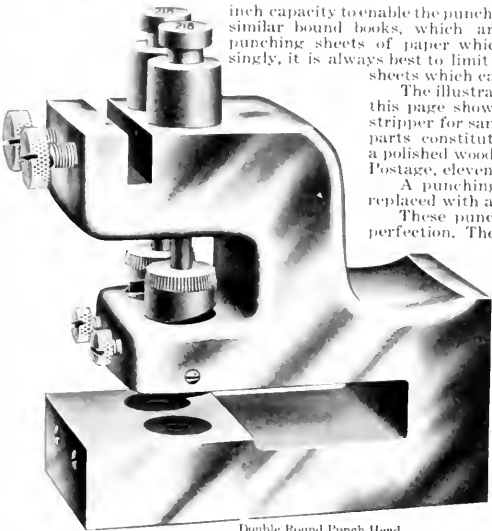

Double Round Punch Head



Punch

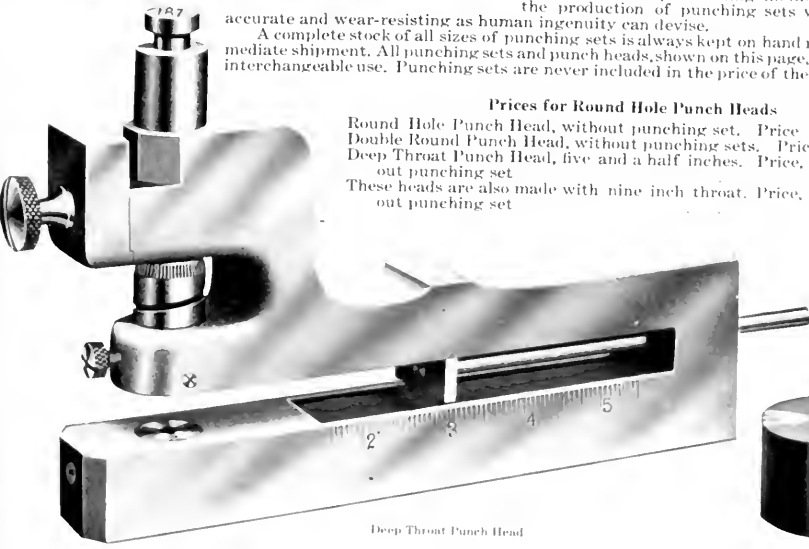

Deep Throat Punch Head

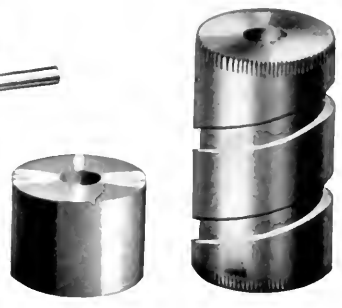

Die

Stripper

Open Hole Punch Heads for the Portland

Open Hole Punch Heads are used for an endless variety of loose leaf and card index punching. Punches and dies for this class of work cannot be made for interchangeable use, and for this reason the punch head with the required shape or style of punch and die is always furnished complete, as shown in the illustration at the left, at a uniform price of \$10.00 for any of the five styles shown on this page.

The diagrams on the right illustrate three of the most popular styles for loose leaf work, while the diagrams on the left illustrate the styles most generally used for card index work. From time to time the manufacturers of the Portland will standardize additional styles for loose leaf and card index work, as well as for baggage checks, etc. Whenever a style becomes popular or uniform it will be standardized and carried in stock.

All punch heads for the Portland are made in the finest possible manner and can be depended upon to give perfect results.

Special Open Hole Punch Heads and other shapes not standardized by the manufacturers of the Portland can be made to order promptly. Prices will be quoted on application.

Regular Open Hole Punch Heads can be spaced any distance apart from one and nine-sixteenths inches to twenty-four inches.

Open Hole Punch Heads are usually made with one-quarter inch capacity, to enable the operator to insert the sheets of stock readily, but it is not possible to punch holes with smooth edges when a large number of sheets are punched at a single operation, as the punch does not cut each individual sheet, consequently the paper or cardboard punchings, which are of a yielding nature, will be forced down through the pile of stock ahead of the punch into the die, leaving a ragged hole.

The best loose leaf and card index manufacturers always limit the quantity of stock punched at each operation to the number of sheets which can be punched satisfactorily.

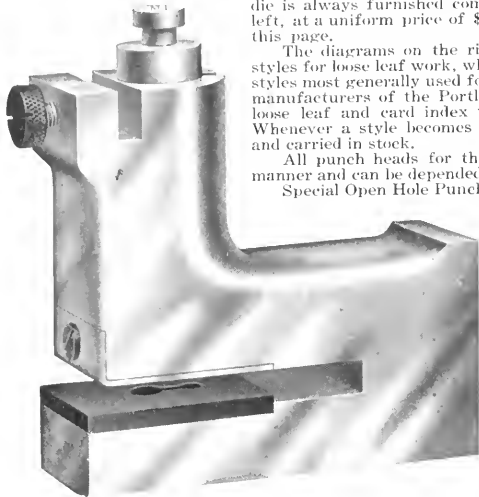

This illustration shows an Open Hole Punch Head, style M-1, one-half actual size.

Price \$10.00

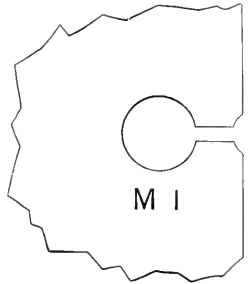

M 1

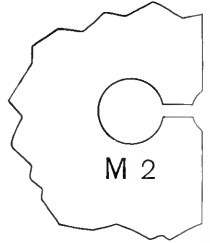

M 2

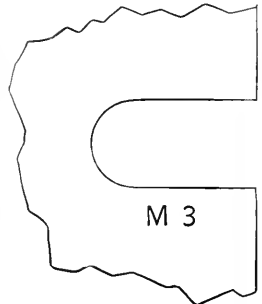

M 3

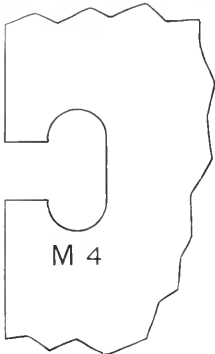

M 4

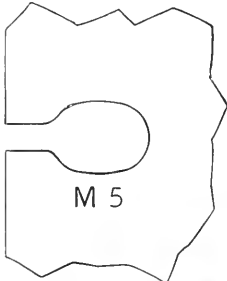

M 5

Tab Cutting Attachment

The rapidly increasing use of sub-division cards, etc., has created a demand for a tab cutting attachment for the Portland.

This tab cutting attachment will fill a long felt want for a reliable equipment for the production of tab-cards and similar work. Hundreds of different styles of sub-division cards and folders for vertical filing systems, etc., can be handled with great economy and satisfaction. Full information with samples and prices will be furnished on application.

Special Punch Heads

The manufacturers of the Portland are prepared to furnish special punch heads for almost every conceivable purpose.

Some manufacturers of loose leaf goods find that it is of considerable advantage to have gang heads instead of single heads, thus preventing the liability of variation in distance between the holes.

The illustration at the bottom of this page shows a three-gang special head.

Special gang heads are frequently furnished for punching a large number of holes at fixed distances.

A Portland Multiple Punching Machine in the plant of an enterprising concern is sure to be a money-earner, because business which is new and profitable will come to those who are ready for it.

Thin sheet metal can be successfully punched with the Portland, as well as celluloid, fibre and other material.

New fields of usefulness for the Portland are being constantly developed. Special punch heads for punching cards on which cuff links, chains, pins, etc., are mounted can be made to order promptly. Such cards are extensively used by manufacturers of jewelry.

Paper box manufacturers use special heads for cutting odd shaped corners of stock.

Very effective household reminders can be manufactured economically by the use of heads designed for these purposes.

Novelty manufacturers, particularly those houses making goods for the department store trade, have found that the Portland equipped with special punch heads enables them to produce a great variety of attractive articles in the paper and cardboard line.

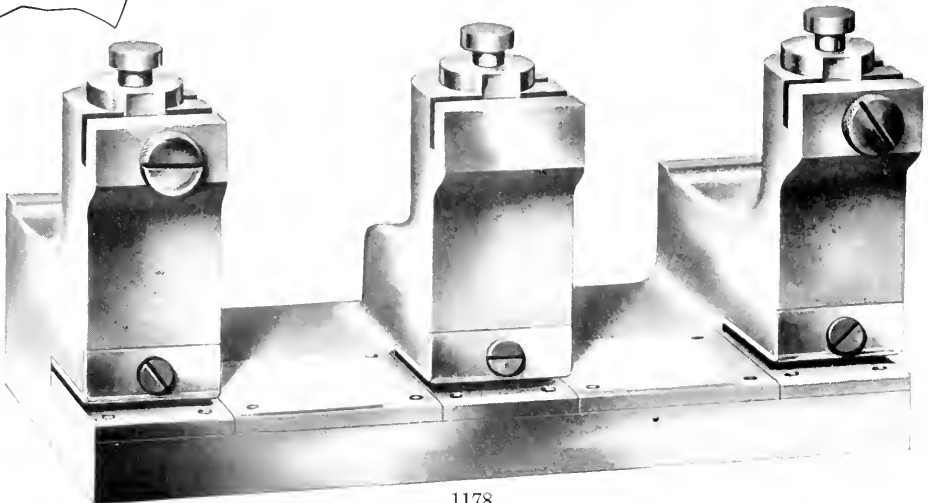

Southworth Punching Machines

These machines are for punching paper, cardboard, celluloid, thin sheet metal and other materials. They are designed for round hole punching only. Irregular shapes, such as open holes for loose leaf sheets, card indexes, etc., cannot be punched with them.

They are the best machines for the money which have ever been put on the market. They are powerful, strong and rapid, and contain exclusive features which merely have to be seen to be appreciated. The method of changing the punching set is only one of the many reasons for the great popularity of these machines.

The change can be made from one size to another in less than one minute without the use of any tools. The gauges are exceedingly convenient and accurate. Adjustments can be made to a hundredth part of an inch, and holes can be punched at any distance from margin up to four inches. There is a drawer in

the base of the machine under table into which the paper punchings drop, preventing litter around machine. A graduated rule eighteen inches long is inlaid in the table. This rule also illustrates the fourteen sizes of punching sets. Any number of sheets of stock can be punched from a single sheet of paper up to the full capacity of the machine which is one-half inch of stock.

Users of punching machines have sometimes complained because smooth holes could not be punched through a thick pile of stock. Attention is called to the fact that holes with smooth edges are not possible when a large amount of stock is punched at a single operation, for the reason that the punch does not cut each individual sheet, consequently the round discs of paper, which are of a yielding nature, will be forced down through the pile of stock ahead of the punch into the die, leaving a ragged hole. The sheets at the top and bottom of a thick pile will necessarily have rough holes. The Southworth Punching Machines are made with a half-inch capacity to enable the punching of telephone directories to be used singly, it is always best to limit the quantity to the number of sheets which can be punched satisfactorily. There are no better machines made, regardless of price, for single round hole punching than the Southworth Punching Machines. They are in successful use everywhere.

The illustrations show the hand power and foot power machines, which are identical, with the exception of method of applying power. The hand power machine is designed for bench use. The foot power machine can be easily moved around the workshop and allows the operator the use of both hands for guiding the stock.

Purchasers of hand power machines sometimes ask if it will be possible for them to convert their machine into a foot power machine. As the method of applying power is not the same in the two machines, it is not possible to change a hand power machine into a foot power machine by the addition of the foot power features. The price of either style of machine includes one punching set. (See next page for full description.) The three-sixteenths inch size, which is No. 6, is

always sent with the machine unless otherwise directed. Additional sizes of punching sets are \$2.00 each.

The Southworth Punching Machines have proven their superiority in manufacturing establishments in all parts of the country. Paper and cardboard mills and selling agents everywhere find the machine indispensable for punching holes in samples of all kinds.

A large number of calendar manufacturers and art publishers use the Southworth for round hole punching; in fact, no printing office, bookbindery or similar concern can any more afford to be without the services of one of these machines than it can afford to be without the telephone or typewriter.

Every printing office and bookbindery is sure to have work which requires the use of a punching machine, and it is therefore necessary that even the smallest plants should be equipped with a machine which will produce the greatest income on the smallest investment. The average country printer has found that the Southworth Punching Machine can be used to great advantage.

The machines are also used extensively for punching library index cards of the styles requiring the round hole only.

Newspaper publishers in every state in the Union have found that it is profitable to have a Southworth Punching Machine in their equipment.

Schools and colleges are also finding these machines to be very convenient and satisfactory.

The transportation companies use the foot power machines quite extensively for punching holes in large quantities of stock which must be fastened together.

Purchasers of Southworth Punching Machines located at some distance from well equipped book binderies have found that they have saved the entire cost of their machine by the elimination of transportation charges on work which would ordinarily have been sent out of town to be punched. The saving in time is also a factor of a great deal of importance.

In establishments depending on girls to operate the machine the foot power machine is always recommended on account of the ease of operation. If the operator exerts a pressure of fifty pounds on the treadle, it would equal eight hundred pounds on the punch, because the power is multiplied sixteen times.

As the foot power machine costs only twelve dollars more than the hand power machine it is generally preferred because a larger amount of work can be punched with greater ease than with the hand machine.

The demand for Southworth Punching Machines from foreign countries has been surprising. When the machines were shown for the first time to the supply houses in England they ordered more than one hundred of them during the first week and more orders are constantly being received.

Southworth Punching Machine, Hand Power, shipping weight 75 pounds. Price \$18 00
Southworth Punching Machine, Foot Power, shipping weight 175 pounds. Price 30 00



Southworth Punching Machine Hand Power



Southworth Punching Machine Foot Power

Any size punching set can be supplied from three thirty-seconds to one-half inch in diameter. Note the diagram of sizes below.

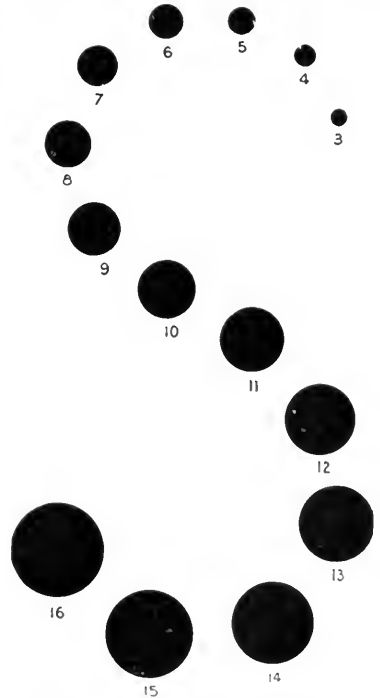

The fourteen sizes of punching sets are shown by above diagram. They are graduated by thirty-seconds beginning with three-thirty-seconds which is No. 3. The number of the punching set indicates the size, i. e., No. 5 is five-thirty-seconds; No. 16, sixteen thirty-seconds or one-half inch.

Punching Sets for the Southworth Punching Machines

The illustrations on the left hand side of this page show a No. 8 Punch with die and stripper for same. (Actual size.) These three parts constitute a punching set. The set complete is packed in a polished wooden box. Price \$2.00 for any of the fourteen sizes. Postage eleven cents. (See diagram of sizes on preceding page.) These punches, dies and strippers are marvels of mechanical perfection. The stripper, through which the punch passes, insures absolute alignment of the punch and prevents the punch and die from wearing. The stripper, which is made with a spiral groove, is raised or lowered by revolving, in order to accommodate the different amounts of stock to be punched.

These punching sets are made in the most perfect manner possible by means of specially designed equipment. The finest steel is used and each part carefully hardened by experts and then ground with diamond dust and the finest corundum. There are thirty operations required for the completion of a punching set. Before shipment, every punch, die and stripper is carefully tested by means of micrometer gauges, and then assembled in a special testing machine to prove accuracy of alignment. If a variation of as much as a thousandth of an inch is detected the part is discarded.

All of these painstaking methods result in the production of punching sets which are as accurate and wear-resisting as human ingenuity can devise. A complete stock of all sizes of punching sets is always kept on hand ready for immediate shipment.

Brass Eyelets for the Southworth Punching Machines

This illustration shows a Y4 Brass Eyelet. Price twenty-five cents per thousand. Packed only in boxes containing five thousand. The hole for this size eyelet must be punched with a No. 4 Punching Set, as shown under the eyelet. The eyelets must be clinched with a P4 Eyeletting Set.

This illustration shows a Y6 Brass Eyelet. Price twenty-five cents per thousand. Packed only in boxes containing five thousand. The hole for this size eyelet must be punched with a No. 6 Punching Set, as shown under the eyelet. The eyelets must be clinched with a P6 Eyeletting Set.

This illustration shows a Y8 Brass Eyelet. Price forty-five cents per thousand. Packed only in boxes containing five thousand. The hole for this size eyelet must be punched with a No. 8 Punching Set, as shown under the eyelet. The eyelets must be clinched with a P8 Eyeletting Set.

This illustration shows a Y10 Brass Eyelet. Price fifty cents per thousand. Packed only in boxes containing five thousand. The hole for this size eyelet must be punched with a No. 10 Punching Set, as shown under the eyelet. The eyelets must be clinched with a P10 Eyeletting Set.

This illustration shows a Y12 Brass Eyelet. Price fifty-five cents per thousand. Packed only in boxes containing five thousand. The hole for this size eyelet must be punched with a No. 12 Punching Set, as shown under the eyelet. The eyelets must be clinched with a P12 Eyeletting Set.

Eyeletting Sets for the Southworth Punching Machines

Almost every owner of a Southworth Punching Machine has an occasional job of eyeletting to be done. It is needless to purchase an expensive self-feeding eyeletting machine unless you have considerable of this class of work, because eyeletting can be done with the Southworth Punching Machines in a satisfactory and economical manner.

The process is very simple. First the stock is punched with the required size of punching set and the eyelets are then clinched with the corresponding size of eyeletting set. The punch, die and stripper can be taken out of machine and the eyeletting set put in its place in less than one minute.

The illustrations on the right hand side of this page show a No. P6 Clincher with anvil and stripper for same. (Actual size.) These three parts constitute an eyeletting set. The set complete is packed in a polished wooden box. Price \$2.00 for any of the five sizes. Postage eleven cents.

The sizes are as follows: P4, P6, P8, P10, P12.

The eyeletting sets are made in the best possible manner. The stripper or guide supports the clincher insuring absolute alignment with the anvil. The description, together with the illustration of the brass eyelets shown above, clearly explains the proper size of eyeletting set for clinching the corresponding styles of eyelets.

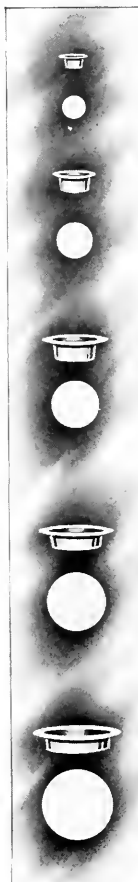

Tatum Paper Drill

The Tatum Paper Drill, with adjustable table, is a great time saver. The table is readily adjustable, and by the use of automatic stops in front and with convenient gauges, the work is easily controlled, so that any desired distance between centers, from one-half inch to twelve inches, is quickly secured. The projecting handle of the sliding table is provided with a spring catch which engages these adjustable stops wherever they are placed. The gauges on the table also provide easy adjustments from edges to sheets. A very important feature is the clamping device which is operated by the foot, thus leaving both hands free to control the work.

The drills are hollow, a feature which avoids "choking," as the clearance inside allows a ready passage for the refuse. The holes produced are clean all the way through, and the work is very rapidly and very accurately done.

The holes may be the depth of one sheet or two inches in thickness if desired, depending for maximum thickness upon the size of the holes.

The gauge at the top of the spindle regulates very precisely the depth of the drilling. The wooden backing strip in the table is adjustable, and receives the cutting edge of drill after it passes through the paper.

The Tatum Paper Drill, with adjustable table, is undoubtedly the best machine of its kind on the market. For excessively thick work beyond the capacity of an ordinary punching operation, or for holes far from edge of sheet, the Tatum Paper Drill will be found invaluable and will do work not heretofore done satisfactorily. It is especially adapted for railroad tariffs, telephone directories, order blanks, calendar cards and work on which the holes are punched or drilled in large quantities.

Send for circular completely describing the machine and its capacity.

Prices of Tatum Paper Drills

No. 43 B. Paper Drilling Machine, belt drive, with universal chuck and one one-quarter inch hollow drill	\$150 00
No. 43 M. Paper Drilling Machine, with direct current motor 110 or 120 volts, one-quarter H. P. and supporting bracket, attached as shown in illustration	180 00
No. 43 N. Paper Drilling Machine, with alternating current motor, 110 or 120 volts, 60 cycles, single phase	200 00

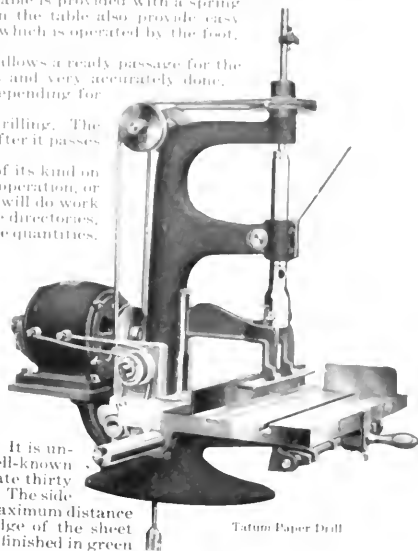

Tatum Paper Drill

The "Marvel" Punch

The "Marvel" Punch is the most effective low priced paper punch on the market. It is unusually simple in construction and may be truly called "a Marvel." It operates on the well-known Arbor rack and pinion principle and will easily perforate thirty sheets of ordinary sixteen-pound folio paper at a time. The side gauge is adjustable to any desired margin, while the maximum distance from the center of the holes to the binding edge of the sheet is one-half inch. The machine is handsomely finished in green with nickel-plated trimmings.



The "Marvel" Punch

Prices of The "Marvel" Punch

No. 60 "Marvel" Punch, punches two holes $\frac{1}{4}$ -inch in diameter (for three-sixteenths inch posts) $2\frac{1}{4}$ inches center to center, each	\$1 25
No. 63 "Marvel" Punch, punches two holes $\frac{1}{2}$ -inch in diameter (for three-sixteenths inch posts) $3\frac{1}{4}$ inches center to center, each	2 00

Special prices will be quoted on heads other than standard. Send for circular giving other sizes and complete details.

Standard Punching Machines

The No. 1 Standard Punch will punch holes any distance apart from one-half inch to ten and one-fourth inches on any size sheet. Maximum distance from center of hole to edge of sheet is five-eighths inch. Punches are easily removed, and sharpened with a round file. Weight of machine with two heads, eight pounds.

The No. 2 Standard Punch is similar in construction to the No. 1, but it is larger, heavier and stronger; it is capable of punching holes any distance apart up to $11\frac{3}{4}$ inches in any length of sheet; Takes the same Punch Heads as No. 1. Weight, twenty pounds.

We have sold a great many of them, and they invariably give satisfaction. The Standard is a handy machine for small jobs of punching and it soon pays for itself. We shall be pleased to supply you with any additional information regarding this line of punches.

Prices and Dimensions of Standard Punching Machines Nos. 1 and 2 and Punch Heads

Standard Punch No. 1 (without punches)	\$ 6 00
Standard Punch No. 2 (without punches)	11 00
Style U Punch Heads, for punching single round holes. Made in $\frac{1}{8}$ inch, $\frac{3}{16}$ inch, $\frac{1}{2}$ inch, $\frac{5}{8}$ inch, $\frac{3}{4}$ inch, $\frac{7}{8}$ inch, $1\frac{1}{8}$ inch, $1\frac{1}{4}$ inch, $1\frac{3}{8}$ inch, $1\frac{1}{2}$ inch, $1\frac{3}{4}$ inch, $1\frac{7}{8}$ inch, 2 inch, $2\frac{1}{8}$ inch, $2\frac{1}{4}$ inch, $2\frac{3}{8}$ inch, $2\frac{1}{2}$ inch, $2\frac{7}{8}$ inch, 3 inch, $3\frac{1}{8}$ inch, $3\frac{1}{4}$ inch, $3\frac{3}{8}$ inch, $3\frac{1}{2}$ inch, $3\frac{7}{8}$ inch, 4 inch, $4\frac{1}{8}$ inch, $4\frac{1}{4}$ inch, $4\frac{3}{8}$ inch, $4\frac{1}{2}$ inch, $4\frac{7}{8}$ inch, 5 inch, $5\frac{1}{8}$ inch, $5\frac{1}{4}$ inch, $5\frac{3}{8}$ inch, $5\frac{1}{2}$ inch, $5\frac{7}{8}$ inch, 6 inch, $6\frac{1}{8}$ inch, $6\frac{1}{4}$ inch, $6\frac{3}{8}$ inch, $6\frac{1}{2}$ inch, $6\frac{7}{8}$ inch, 7 inch, $7\frac{1}{8}$ inch, $7\frac{1}{4}$ inch, $7\frac{3}{8}$ inch, $7\frac{1}{2}$ inch, $7\frac{7}{8}$ inch, 8 inch, $8\frac{1}{8}$ inch, $8\frac{1}{4}$ inch, $8\frac{3}{8}$ inch, $8\frac{1}{2}$ inch, $8\frac{7}{8}$ inch, 9 inch, $9\frac{1}{8}$ inch, $9\frac{1}{4}$ inch, $9\frac{3}{8}$ inch, $9\frac{1}{2}$ inch, $9\frac{7}{8}$ inch, 10 inch, $10\frac{1}{8}$ inch, $10\frac{1}{4}$ inch, $10\frac{3}{8}$ inch, $10\frac{1}{2}$ inch, $10\frac{7}{8}$ inch, 11 inch, $11\frac{1}{8}$ inch, $11\frac{1}{4}$ inch, $11\frac{3}{8}$ inch, $11\frac{1}{2}$ inch, $11\frac{7}{8}$ inch, 12 inch, $12\frac{1}{8}$ inch, $12\frac{1}{4}$ inch, $12\frac{3}{8}$ inch, $12\frac{1}{2}$ inch, $12\frac{7}{8}$ inch, 13 inch, $13\frac{1}{8}$ inch, $13\frac{1}{4}$ inch, $13\frac{3}{8}$ inch, $13\frac{1}{2}$ inch, $13\frac{7}{8}$ inch, 14 inch, $14\frac{1}{8}$ inch, $14\frac{1}{4}$ inch, $14\frac{3}{8}$ inch, $14\frac{1}{2}$ inch, $14\frac{7}{8}$ inch, 15 inch, $15\frac{1}{8}$ inch, $15\frac{1}{4}$ inch, $15\frac{3}{8}$ inch, $15\frac{1}{2}$ inch, $15\frac{7}{8}$ inch, 16 inch, $16\frac{1}{8}$ inch, $16\frac{1}{4}$ inch, $16\frac{3}{8}$ inch, $16\frac{1}{2}$ inch, $16\frac{7}{8}$ inch, 17 inch, $17\frac{1}{8}$ inch, $17\frac{1}{4}$ inch, $17\frac{3}{8}$ inch, $17\frac{1}{2}$ inch, $17\frac{7}{8}$ inch, 18 inch, $18\frac{1}{8}$ inch, $18\frac{1}{4}$ inch, $18\frac{3}{8}$ inch, $18\frac{1}{2}$ inch, $18\frac{7}{8}$ inch, 19 inch, $19\frac{1}{8}$ inch, $19\frac{1}{4}$ inch, $19\frac{3}{8}$ inch, $19\frac{1}{2}$ inch, $19\frac{7}{8}$ inch, 20 inch, $20\frac{1}{8}$ inch, $20\frac{1}{4}$ inch, $20\frac{3}{8}$ inch, $20\frac{1}{2}$ inch, $20\frac{7}{8}$ inch, 21 inch, $21\frac{1}{8}$ inch, $21\frac{1}{4}$ inch, $21\frac{3}{8}$ inch, $21\frac{1}{2}$ inch, $21\frac{7}{8}$ inch, 22 inch, $22\frac{1}{8}$ inch, $22\frac{1}{4}$ inch, $22\frac{3}{8}$ inch, $22\frac{1}{2}$ inch, $22\frac{7}{8}$ inch, 23 inch, $23\frac{1}{8}$ inch, $23\frac{1}{4}$ inch, $23\frac{3}{8}$ inch, $23\frac{1}{2}$ inch, $23\frac{7}{8}$ inch, 24 inch, $24\frac{1}{8}$ inch, $24\frac{1}{4}$ inch, $24\frac{3}{8}$ inch, $24\frac{1}{2}$ inch, $24\frac{7}{8}$ inch, 25 inch, $25\frac{1}{8}$ inch, $25\frac{1}{4}$ inch, $25\frac{3}{8}$ inch, $25\frac{1}{2}$ inch, $25\frac{7}{8}$ inch, 26 inch, $26\frac{1}{8}$ inch, $26\frac{1}{4}$ inch, $26\frac{3}{8}$ inch, $26\frac{1}{2}$ inch, $26\frac{7}{8}$ inch, 27 inch, $27\frac{1}{8}$ inch, $27\frac{1}{4}$ inch, $27\frac{3}{8}$ inch, $27\frac{1}{2}$ inch, $27\frac{7}{8}$ inch, 28 inch, $28\frac{1}{8}$ inch, $28\frac{1}{4}$ inch, $28\frac{3}{8}$ inch, $28\frac{1}{2}$ inch, $28\frac{7}{8}$ inch, 29 inch, $29\frac{1}{8}$ inch, $29\frac{1}{4}$ inch, $29\frac{3}{8}$ inch, $29\frac{1}{2}$ inch, $29\frac{7}{8}$ inch, 30 inch, $30\frac{1}{8}$ inch, $30\frac{1}{4}$ inch, $30\frac{3}{8}$ inch, $30\frac{1}{2}$ inch, $30\frac{7}{8}$ inch, 31 inch, $31\frac{1}{8}$ inch, $31\frac{1}{4}$ inch, $31\frac{3}{8}$ inch, $31\frac{1}{2}$ inch, $31\frac{7}{8}$ inch, 32 inch, $32\frac{1}{8}$ inch, $32\frac{1}{4}$ inch, $32\frac{3}{8}$ inch, $32\frac{1}{2}$ inch, $32\frac{7}{8}$ inch, 33 inch, $33\frac{1}{8}$ inch, $33\frac{1}{4}$ inch, $33\frac{3}{8}$ inch, $33\frac{1}{2}$ inch, $33\frac{7}{8}$ inch, 34 inch, $34\frac{1}{8}$ inch, $34\frac{1}{4}$ inch, $34\frac{3}{8}$ inch, $34\frac{1}{2}$ inch, $34\frac{7}{8}$ inch, 35 inch, $35\frac{1}{8}$ inch, $35\frac{1}{4}$ inch, $35\frac{3}{8}$ inch, $35\frac{1}{2}$ inch, $35\frac{7}{8}$ inch, 36 inch, $36\frac{1}{8}$ inch, $36\frac{1}{4}$ inch, $36\frac{3}{8}$ inch, $36\frac{1}{2}$ inch, $36\frac{7}{8}$ inch, 37 inch, $37\frac{1}{8}$ inch, $37\frac{1}{4}$ inch, $37\frac{3}{8}$ inch, $37\frac{1}{2}$ inch, $37\frac{7}{8}$ inch, 38 inch, $38\frac{1}{8}$ inch, $38\frac{1}{4}$ inch, $38\frac{3}{8}$ inch, $38\frac{1}{2}$ inch, $38\frac{7}{8}$ inch, 39 inch, $39\frac{1}{8}$ inch, $39\frac{1}{4}$ inch, $39\frac{3}{8}$ inch, $39\frac{1}{2}$ inch, $39\frac{7}{8}$ inch, 40 inch, $40\frac{1}{8}$ inch, $40\frac{1}{4}$ inch, $40\frac{3}{8}$ inch, $40\frac{1}{2}$ inch, $40\frac{7}{8}$ inch, 41 inch, $41\frac{1}{8}$ inch, $41\frac{1}{4}$ inch, $41\frac{3}{8}$ inch, $41\frac{1}{2}$ inch, $41\frac{7}{8}$ inch, 42 inch, $42\frac{1}{8}$ inch, $42\frac{1}{4}$ inch, $42\frac{3}{8}$ inch, $42\frac{1}{2}$ inch, $42\frac{7}{8}$ inch, 43 inch, $43\frac{1}{8}$ inch, $43\frac{1}{4}$ inch, $43\frac{3}{8}$ inch, $43\frac{1}{2}$ inch, $43\frac{7}{8}$ inch, 44 inch, $44\frac{1}{8}$ inch, $44\frac{1}{4}$ inch, $44\frac{3}{8}$ inch, $44\frac{1}{2}$ inch, $44\frac{7}{8}$ inch, 45 inch, $45\frac{1}{8}$ inch, $45\frac{1}{4}$ inch, $45\frac{3}{8}$ inch, $45\frac{1}{2}$ inch, $45\frac{7}{8}$ inch, 46 inch, $46\frac{1}{8}$ inch, $46\frac{1}{4}$ inch, $46\frac{3}{8}$ inch, $46\frac{1}{2}$ inch, $46\frac{7}{8}$ inch, 47 inch, $47\frac{1}{8}$ inch, $47\frac{1}{4}$ inch, $47\frac{3}{8}$ inch, $47\frac{1}{2}$ inch, $47\frac{7}{8}$ inch, 48 inch, $48\frac{1}{8}$ inch, $48\frac{1}{4}$ inch, $48\frac{3}{8}$ inch, $48\frac{1}{2}$ inch, $48\frac{7}{8}$ inch, 49 inch, $49\frac{1}{8}$ inch, $49\frac{1}{4}$ inch, $49\frac{3}{8}$ inch, $49\frac{1}{2}$ inch, $49\frac{7}{8}$ inch, 50 inch, $50\frac{1}{8}$ inch, $50\frac{1}{4}$ inch, $50\frac{3}{8}$ inch, $50\frac{1}{2}$ inch, $50\frac{7}{8}$ inch, 51 inch, $51\frac{1}{8}$ inch, $51\frac{1}{4}$ inch, $51\frac{3}{8}$ inch, $51\frac{1}{2}$ inch, $51\frac{7}{8}$ inch, 52 inch, $52\frac{1}{8}$ inch, $52\frac{1}{4}$ inch, $52\frac{3}{8}$ inch, $52\frac{1}{2}$ inch, $52\frac{7}{8}$ inch, 53 inch, $53\frac{1}{8}$ inch, $53\frac{1}{4}$ inch, $53\frac{3}{8}$ inch, $53\frac{1}{2}$ inch, $53\frac{7}{8}$ inch, 54 inch, $54\frac{1}{8}$ inch, $54\frac{1}{4}$ inch, $54\frac{3}{8}$ inch, $54\frac{1}{2}$ inch, $54\frac{7}{8}$ inch, 55 inch, $55\frac{1}{8}$ inch, $55\frac{1}{4}$ inch, $55\frac{3}{8}$ inch, $55\frac{1}{2}$ inch, $55\frac{7}{8}$ inch, 56 inch, $56\frac{1}{8}$ inch, $56\frac{1}{4}$ inch, $56\frac{3}{8}$ inch, $56\frac{1}{2}$ inch, $56\frac{7}{8}$ inch, 57 inch, $57\frac{1}{8}$ inch, $57\frac{1}{4}$ inch, $57\frac{3}{8}$ inch, $57\frac{1}{2}$ inch, $57\frac{7}{8}$ inch, 58 inch, $58\frac{1}{8}$ inch, $58\frac{1}{4}$ inch, $58\frac{3}{8}$ inch, $58\frac{1}{2}$ inch, $58\frac{7}{8}$ inch, 59 inch, $59\frac{1}{8}$ inch, $59\frac{1}{4}$ inch, $59\frac{3}{8}$ inch, $59\frac{1}{2}$ inch, $59\frac{7}{8}$ inch, 60 inch, $60\frac{1}{8}$ inch, $60\frac{1}{4}$ inch, $60\frac{3}{8}$ inch, $60\frac{1}{2}$ inch, $60\frac{7}{8}$ inch, 61 inch, $61\frac{1}{8}$ inch, $61\frac{1}{4}$ inch, $61\frac{3}{8}$ inch, $61\frac{1}{2}$ inch, $61\frac{7}{8}$ inch, 62 inch, $62\frac{1}{8}$ inch, $62\frac{1}{4}$ inch, $62\frac{3}{8}$ inch, $62\frac{1}{2}$ inch, $62\frac{7}{8}$ inch, 63 inch, $63\frac{1}{8}$ inch, $63\frac{1}{4}$ inch, $63\frac{3}{8}$ inch, $63\frac{1}{2}$ inch, $63\frac{7}{8}$ inch, 64 inch, $64\frac{1}{8}$ inch, $64\frac{1}{4}$ inch, $64\frac{3}{8}$ inch, $64\frac{1}{2}$ inch, $64\frac{7}{8}$ inch, 65 inch, $65\frac{1}{8}$ inch, $65\frac{1}{4}$ inch, $65\frac{3}{8}$ inch, $65\frac{1}{2}$ inch, $65\frac{7}{8}$ inch, 66 inch, $66\frac{1}{8}$ inch, $66\frac{1}{4}$ inch, $66\frac{3}{8}$ inch, $66\frac{1}{2}$ inch, $66\frac{7}{8}$ inch, 67 inch, $67\frac{1}{8}$ inch, $67\frac{1}{4}$ inch, $67\frac{3}{8}$ inch, $67\frac{1}{2}$ inch, $67\frac{7}{8}$ inch, 68 inch, $68\frac{1}{8}$ inch, $68\frac{1}{4}$ inch, $68\frac{3}{8}$ inch, $68\frac{1}{2}$ inch, $68\frac{7}{8}$ inch, 69 inch, $69\frac{1}{8}$ inch, $69\frac{1}{4}$ inch, $69\frac{3}{8}$ inch, $69\frac{1}{2}$ inch, $69\frac{7}{8}$ inch, 70 inch, $70\frac{1}{8}$ inch, $70\frac{1}{4}$ inch, $70\frac{3}{8}$ inch, $70\frac{1}{2}$ inch, $70\frac{7}{8}$ inch, 71 inch, $71\frac{1}{8}$ inch, $71\frac{1}{4}$ inch, $71\frac{3}{8}$ inch, $71\frac{1}{2}$ inch, $71\frac{7}{8}$ inch, 72 inch, $72\frac{1}{8}$ inch, $72\frac{1}{4}$ inch, $72\frac{3}{8}$ inch, $72\frac{1}{2}$ inch, $72\frac{7}{8}$ inch, 73 inch, $73\frac{1}{8}$ inch, $73\frac{1}{4}$ inch, $73\frac{3}{8}$ inch, $73\frac{1}{2}$ inch, $73\frac{7}{8}$ inch, 74 inch, $74\frac{1}{8}$ inch, $74\frac{1}{4}$ inch, $74\frac{3}{8}$ inch, $74\frac{1}{2}$ inch, $74\frac{7}{8}$ inch, 75 inch, $75\frac{1}{8}$ inch, $75\frac{1}{4}$ inch, $75\frac{3}{8}$ inch, $75\frac{1}{2}$ inch, $75\frac{7}{8}$ inch, 76 inch, $76\frac{1}{8}$ inch, $76\frac{1}{4}$ inch, $76\frac{3}{8}$ inch, $76\frac{1}{2}$ inch, $76\frac{7}{8}$ inch, 77 inch, $77\frac{1}{8}$ inch, $77\frac{1}{4}$ inch, $77\frac{3}{8}$ inch, $77\frac{1}{2}$ inch, $77\frac{7}{8}$ inch, 78 inch, $78\frac{1}{8}$ inch, $78\frac{1}{4}$ inch, $78\frac{3}{8}$ inch, $78\frac{1}{2}$ inch, $78\frac{7}{8}$ inch, 79 inch, $79\frac{1}{8}$ inch, $79\frac{1}{4}$ inch, $79\frac{3}{8}$ inch, $79\frac{1}{2}$ inch, $79\frac{7}{8}$ inch, 80 inch, $80\frac{1}{8}$ inch, $80\frac{1}{4}$ inch, $80\frac{3}{8}$ inch, $80\frac{1}{2}$ inch, $80\frac{7}{8}$ inch, 81 inch, $81\frac{1}{8}$ inch, $81\frac{1}{4}$ inch, $81\frac{3}{8}$ inch, $81\frac{1}{2}$ inch, $81\frac{7}{8}$ inch, 82 inch, $82\frac{1}{8}$ inch, $82\frac{1}{4}$ inch, $82\frac{3}{8}$ inch, $82\frac{1}{2}$ inch, $82\frac{7}{8}$ inch, 83 inch, $83\frac{1}{8}$ inch, $83\frac{1}{4}$ inch, $83\frac{3}{8}$ inch, $83\frac{1}{2}$ inch, $83\frac{7}{8}$ inch, 84 inch, $84\frac{1}{8}$ inch, $84\frac{1}{4}$ inch, $84\frac{3}{8}$ inch, $84\frac{1}{2}$ inch, $84\frac{7}{8}$ inch, 85 inch, $85\frac{1}{8}$ inch, $85\frac{1}{4}$ inch, $85\frac{3}{8}$ inch, $85\frac{1}{2}$ inch, $85\frac{7}{8}$ inch, 86 inch, $86\frac{1}{8}$ inch, $86\frac{1}{4}$ inch, $86\frac{3}{8}$ inch, $86\frac{1}{2}$ inch, $86\frac{7}{8}$ inch, 87 inch, $87\frac{1}{8}$ inch, $87\frac{1}{4}$ inch, $87\frac{3}{8}$ inch, $87\frac{1}{2}$ inch, $87\frac{7}{8}$ inch, 88 inch, $88\frac{1}{8}$ inch, $88\frac{1}{4}$ inch, $88\frac{3}{8}$ inch, $88\frac{1}{2}$ inch, $88\frac{7}{8}$ inch, 89 inch, $89\frac{1}{8}$ inch, $89\frac{1}{4}$ inch, $89\frac{3}{8}$ inch, $89\frac{1}{2}$ inch, $89\frac{7}{8}$ inch, 90 inch, $90\frac{1}{8}$ inch, $90\frac{1}{4}$ inch, $90\frac{3}{8}$ inch, $90\frac{1}{2}$ inch, $90\frac{7}{8}$ inch, 91 inch, $91\frac{1}{8}$ inch, $91\frac{1}{4}$ inch, $91\frac{3}{8}$ inch, $91\frac{1}{2}$ inch, $91\frac{7}{8}$ inch, 92 inch, $92\frac{1}{8}$ inch, $92\frac{1}{4}$ inch, $92\frac{3}{8}$ inch, $92\frac{1}{2}$ inch, $92\frac{7}{8}$ inch, 93 inch, $93\frac{1}{8}$ inch, $93\frac{1}{4}$ inch, $93\frac{3}{8}$ inch, $93\frac{1}{2}$ inch, $93\frac{7}{8}$ inch, 94 inch, $94\frac{1}{8}$ inch, $94\frac{1}{4}$ inch, $94\frac{3}{8}$ inch, $94\frac{1}{2}$ inch, $94\frac{7}{8}$ inch, 95 inch, $95\frac{1}{8}$ inch, $95\frac{1}{4}$ inch, $95\frac{3}{8}$ inch, $95\frac{1}{2}$ inch, $95\frac{7}{8}$ inch, 96 inch, $96\frac{1}{8}$ inch, $96\frac{1}{4}$ inch, $96\frac{3}{8}$ inch, $96\frac{1}{2}$ inch, $96\frac{7}{8}$ inch, 97 inch, $97\frac{1}{8}$ inch, $97\frac{1}{4}$ inch, $97\frac{3}{8}$ inch, $97\frac{1}{2}$ inch, $97\frac{7}{8}$ inch, 98 inch, $98\frac{1}{8}$ inch, $98\frac{1}{4}$ inch, $98\frac{3}{8}$ inch, $98\frac{1}{2}$ inch, $98\frac{7}{8}$ inch, 99 inch, $99\frac{1}{8}$ inch, $99\frac{1}{4}$ inch, $99\frac{3}{8}$ inch, $99\frac{1}{2}$ inch, $99\frac{7}{8}$ inch, 100 inch, $100\frac{1}{8}$ inch, $100\frac{1}{4}$ inch, $100\frac{3}{8}$ inch, $100\frac{1}{2}$ inch, $100\frac{7}{8}$ inch, 101 inch, $101\frac{1}{8}$ inch, $101\frac{1}{4}$ inch, $101\frac{3}{8}$ inch, $101\frac{1}{2}$ inch, $101\frac{7}{8}$ inch, 102 inch, $102\frac{1}{8}$ inch, $102\frac{1}{4}$ inch, $102\frac{3}{8}$ inch, $102\frac{1}{2}$ inch, $102\frac{7}{8}$ inch, 103 inch, $103\frac{1}{8}$ inch, $103\frac{1}{4}$ inch, $103\frac{3}{8}$ inch, $103\frac{1}{2}$ inch, $103\frac{7}{8}$ inch, 104 inch, $104\frac{1}{8}$ inch, $104\frac{1}{4}$ inch, $104\frac{3}{8}$ inch, $104\frac{1}{2}$ inch, $104\frac{7}{8}$ inch, 105 inch, $105\frac{1}{8}$ inch, $105\frac{1}{4}$ inch, $105\frac{3}{8}$ inch, $105\frac{1}{2}$ inch, $105\frac{7}{8}$ inch, 106 inch, $106\frac{1}{8}$ inch, $106\frac{1}{4}$ inch, $106\frac{3}{8}$ inch, $106\frac{1}{2}$ inch, $106\frac{7}{8}$ inch, 107 inch, $107\frac{1}{8}$ inch, $107\frac{1}{4}$ inch, $107\frac{3}{8}$ inch, $107\frac{1}{2}$ inch, $107\frac{7}{8}$ inch, 108 inch, $108\frac{1}{8}$ inch, $108\frac{1}{4}$ inch, $108\frac{3}{8}$ inch, $108\frac{1}{2}$ inch, $108\frac{7}{8}$ inch, 109 inch, $109\frac{1}{8}$ inch, $109\frac{1}{4}$ inch, $109\frac{3}{8}$ inch, $109\frac{1}{2}$ inch, $109\frac{7}{8}$ inch, 110 inch, $110\frac{1}{8}$ inch, $110\frac{1}{4}$ inch, $110\frac{3}{8}$ inch, $110\frac{1}{2}$ inch, $110\frac{7}{8}$ inch, 111 inch, $111\frac{1}{8}$ inch, $111\frac{1}{4}$ inch, $111\frac{3}{8}$ inch, $111\frac{1}{2}$ inch, $111\frac{7}{8}$ inch, 112 inch, $112\frac{1}{8}$ inch, $112\frac{1}{4}$ inch, $112\frac{3}{8}$ inch, $112\frac{1}{2}$ inch, $112\frac{7}{8}$ inch, 113 inch, $113\frac{1}{8}$ inch, $113\frac{1}{4}$ inch, $113\frac{3}{8}$ inch, $113\frac{1}{2}$ inch, $113\frac{7}{8}$ inch, 114 inch, $114\frac{1}{8}$ inch, 114	

Sterling Round Cornering Machines

These machines are for round cornering booklets, catalogues, cards of all kinds, labels, folders, calendar backs and an endless variety of other work. The Sterling is the most popular round cornering machine ever devised. Over eight thousand of these machines have already been sold to printers, bookbinders and kindred trades in every civilized country in the world. The machine is self-clamping and very rapid. Every part is made with the utmost care, and nothing but the very best material is used in its construction. The operation of the Sterling is so simple and the price so low, that no enterprising concern can afford to get along without one of these wonderful machines. Round corners add to the appearance of a great many different kinds of work, and in many instances they are absolute necessities. The actual cost of round cornering is only a trifle. The capacity of the machine is a little over one inch of stock. Any number of sheets can be cornered with the greatest ease, from a single sheet up to the full capacity of the machine. The knife cuts onto a block of end grain hardwood, which is held in position by means of a spring. Four cutting blocks are included with each machine. Extra cutting blocks are 35 cents per dozen. These blocks are always packed in boxes containing one dozen, which can be sent by mail at a cost of ten cents for postage. The price of the machine includes one No. 1 knife, which is the size generally used. The diagram illustrates five styles of knives, price \$1.25 each. Postage five cents each. The illustrations show the hand power and foot power machines which are identical with the exception of the method of operating. The hand power machine is specially designed for bench use. The foot power machine allows the operator the use of both hands for guiding the stock.

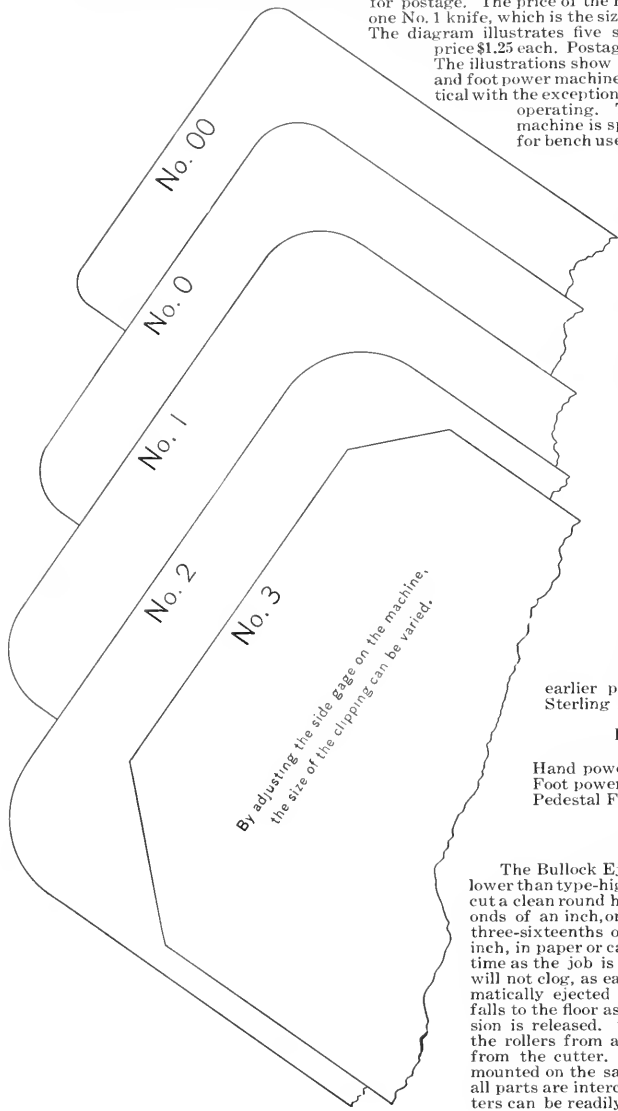

Sterling Round Cornering Machine
Hand Power

Sterling Round Cornering Machine
Foot Power

The fact that the foot power machine can be easily moved around the workshop is a valuable feature in many plants. As the Sterling machines are built on the interchangeable plan, the hand power machine may be converted into a foot power machine in a few minutes' time by the addition of the pedestal foot power attachment. Several thousand pedestal foot power attachments have already been sold to the earlier purchasers of hand power Sterling Round Cornering Machines.

Prices of Sterling Round Cornering Machines

	Shipping Weight	List Price
Hand power	35 pounds	\$15 00
Foot power	160 pounds	30 00
Pedestal Foot Power Attachment	136 pounds	15 00

Bullock Ejector Press Punch

The Bullock Ejector Press Punch is a useful device, which is made two points lower than type-high. One or more of them can be locked up in a type form and will cut a clean round hole three-thirty-seconds of an inch, one-eighth of an inch, three-sixteenths or one-quarter of an inch, in paper or card stock at the same time as the job is printed. The Punch will not clog, as each piece cut is automatically ejected by the plunger and falls to the floor as soon as the impression is released. The ejector protects the rollers from any danger of injury from the cutter. The cutters are all mounted on the same size body and as all parts are interchangeable, new cutters can be readily fitted. The spring for controlling the ejector can be strengthened by turning the screw at the bottom.



Bullock Ejector Press Punch

Prices of Bullock Ejector Press Punches

Punch for $\frac{3}{32}$, $\frac{1}{8}$, $\frac{3}{16}$ or $\frac{1}{4}$ -inch on bases $\frac{7}{16}$ -inch square, each	\$0 75
Punch for $\frac{5}{16}$ or $\frac{3}{8}$ -inch, on bases $\frac{9}{16}$ -inch square, each	1 25
Extra Cutters, small	\$0 35 large \$0 60
Extra Screw, small	10
Extra Square Base, small	20; large 40
Extra Plungers, small	\$0 10 large 20
Extra Cutting Plate, dozen, small	10 large 10
Extra Springs, small	05 large 05

The Dillingham Punch

The Dillingham Press Punch is secured to the tympan of Platen presses in practically the same manner as a feed guide. The slightly curved spring as shown in the illustration is placed under the upper tympan sheet and the sheet to be punched is fed over this curved spring and under the punch with no more trouble than in feeding to gauge pins. The punch is secured to the tympan with paste or glue. If so desired several punches can be used on a sheet and the printing and punching done at the same time. It is made to punch holes five-thirty-seconds, three-sixteenths and one-quarter inch. State size of hole wanted when ordering. This is an extremely useful device for any printer, and is thoroughly effective in operation. Price, each, \$1.25.



The Dillingham Punch

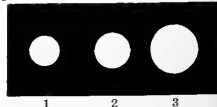

The National Rotary Perforator

The National Rotary Perforator is designed to fulfill all the requirements of an up-to-date perforating machine. It has no tapes or rubber bands. It does not punch holes in the paper, but makes a clean cut, leaving no burr. It perforates, cuts or trims and scores paper all in one operation. If desired, the paper can be perforated first and the printing readily completed afterwards. The speed is limited only by the experience of the operator. It is supplied with the combination attachment for stub (or strike) and straight perforation at one operation, also with crimping-scoring-slitting-trimming-attachment. The stub and straight attachment enables a straight line of perforation to be made the entire length of the sheet and at the same time striking as desired on stock not over thirty-six inches long. Two styles of crimping may be obtained, as ordered, one eight crimps to the inch, in width from one-eighth to one and three-quarter inches, or twenty-five crimps to the inch, the spoofs being one and one-half inches wide. Only one set of spoofs is furnished with the regular equipment. The scoring spoofs can be adjusted for 8-rod scoring or for hinged cover work from one-eighth of an inch up to any width desired within the limits of the machine. The National Rotary Perforator, thus equipped, will take care of a large variety of work, and will effect an economy in floor space. The crimping attachment can be furnished as an independent machine. The following prices are for machines fitted with combination and crimping attachment.

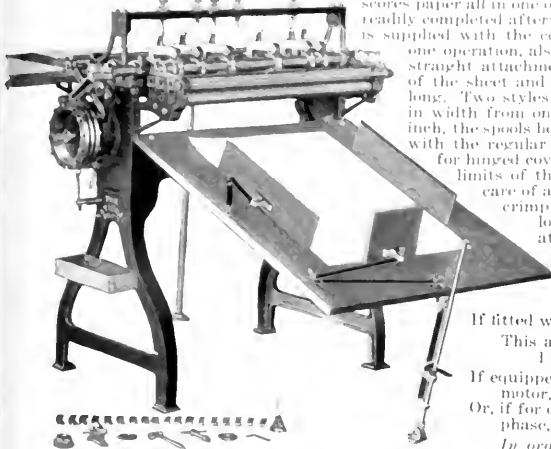

National Rotary Perforator

Prices of the National Rotary Perforators

National Perforator, with 21-inch standard equipment	\$315 00
National Perforator, with 28-inch standard equipment	405 00
National Perforator, with 30-inch standard equipment	460 00
If fitted with special Micrometer adjustment, extra	30 00
This adjustment permits the setting of crimper spoofs to a reading of 1/1000 inch and assures a perfect crimp on any weight stock.	
If equipped for self-contained individual motor drive with direct current motor, 110-220 volts, single phase, add	30 00
Or, if for one-quarter H. P., alternating current motor, 110-220 volts, single phase, add	65 00
<i>In ordering motors, give voltage. Prices will be quoted on motors of other H. P., voltage and phase.</i>	

National Rotary Perforator, without Combination and Crimping Attachment

20-inch National Rotary Perforator, fitted with 3 Heads	\$290 00	28-inch National Rotary Perforator, fitted with 5 Heads	\$300 00
21-inch National Rotary Perforator, fitted with 4 Heads	250 00	30-inch National Rotary Perforator, fitted with 6 Heads	350 00

Tatum Perforators for Round Holes

In the design of the Tatum Perforators, especial attention has been given to the proper distribution of the metal. This is notably the case with our arch or top member, which is very much heavier than usually made. This unusual stiffness of the arch or top member, with other features named, makes perfect perforating and unusual durability. Our total weights of various styles are from forty to sixty per cent. heavier than those of other manufacturers. This fact, in connection with the design and the high character of our workmanship and material, is bringing us orders from the most discriminating buyers. Perfect alignment is necessary for really good work in any perforator. The studs upon which our heads slide are long, of large diameter and in direct line with the needles. These guiding studs have double the bearing surface of other makes and being without any strain of supporting the top feed table, a perfectly true and even action of the needles is thus ensured.

Two of the weak points of perforators are the tempered needles and die plate. Realizing this, the manufacturers have put in special machines and furnaces to handle and temper these important parts, to secure even and uniform results. This, combined with careful and experienced workmanship, enables them to make perforators which will not wear out in a short time, but will continue to make good, clean, round perforations for years. Both needles and die plate are hardened, and a special hard temper is given the die plate, as then the needles are more easily replaced.

The Tatum Perforators have been in use more than eight years, and the manufacturers have never replaced a single die plate. The strippers on our perforators are made of steel and are so supported that they cannot "give" in the center.

Being rigid their entire length, the work is always stripped in a perfect manner, no oval or ragged holes appearing in the center of the sheets, as in other makes where the strippers are not properly constructed or secured. The sectional adjustment length of perforations is amply provided for. The backing pieces which give action to the needles are cut into convenient divisions, which are easily adjusted. The removal of needles is quickly accomplished. One needle or one hundred can be readily removed or replaced without disturbing the others. A waste box to catch perforations is provided; is easily emptied and replaced. The Tatum Perforators are finished beautifully in smooth black ornamented in gold. Tables are of golden oak, "built up," and will not warp. A broad guarantee covers the Tatum Perforators. Write for descriptive circular of full line of Tatum Perforators.

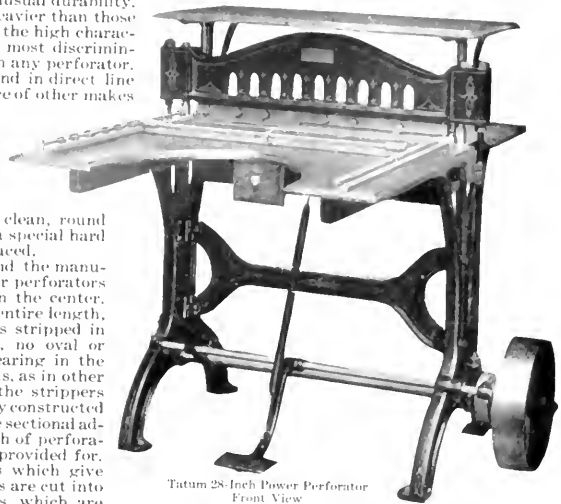

Tatum 28-Inch Power Perforator
Front View

The backing pieces which give action to the needles are cut into convenient divisions, which are easily adjusted. The removal of needles is quickly accomplished. One needle or one hundred can be readily removed or replaced without disturbing the others. A waste box to catch perforations is provided; is easily emptied and replaced. The Tatum Perforators are finished beautifully in smooth black ornamented in gold. Tables are of golden oak, "built up," and will not warp. A broad guarantee covers the Tatum Perforators. Write for descriptive circular of full line of Tatum Perforators.

Prices of Tatum Perforators for Round Holes

28-Inch Foot Power Tatum Perforator	\$180 00
28-Inch Belt Power Tatum Perforator	220 00
28-Inch Power Perforator, motor driven, half horse power, direct current, 110 or 220 volts, including starting box, switch and cut-out, cut gear, rawhide pinion, bracket, gear guards	300 00
Delivery Roll in rear, inclinable delivery box	45 00
Automatic Feed Gauge and special table	30 00
Top Feed Table	10 00

Perforators fitted with needles of 65 gauge, 15 holes to the inch. Needles 18 holes to inch furnished to order.

The Perforating Machines shown on this page are sold f. o. b. factory.

Hand Perforator

This is a first-class Hand Perforator, intended for small work. Printers requiring a machine for doing little jobs which would otherwise have to go to the bindery will find these Hand Perforators entirely satisfactory and very economical. These machines make fifteen round hole perforations to the inch and when needles are bent or broken they can readily be taken out and replaced. If your work does not call for more than a machine of this capacity you will make no mistake in adding one to your equipment. Correspondence invited regarding Perforating Machines.

Price

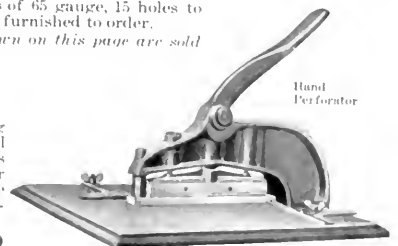

Hand Perforator

\$35 00

The Potter Proof Presses

The complete line of Potter Proof Presses shows an innovation in proof press construction. In the busy printing office some one of these machines is essential. The Potter line offers a machine for nearly every purpose. Beginning with the No. 0 machine, intended for the smaller offices and selling at a much less price, the same careful consideration in regard to details of construction and manufacture has been accorded to it as to the large No. 3 and intermediate models.

The Potter Proof Press simplifies the whole proofing problem and enables anyone, whether trained or not in proof taking, to obtain the very best results in the briefest time. The Potter Proof Presses are built on the lines of cylinder presses. The cylinders on Nos. 1, 2 and 3 are fitted with grippers, have steel rods to hold the draw sheets and are provided with trips for use when it is desired to throw the cylinder off the impression. These are features which will be found exceptionally advantageous when register proofs are being taken. The bed, which travels back and forth under the cylinder on all models, has a continuous register rack, which is engaged by the cylinder gear. The Potter Proof Presses are constructed

solidly and substantially throughout so that repair parts need not be considered by users. The design of each is not only pleasing, but is of the most practical nature, enabling the printer to take a proof of a single line of type equally as well and with the same even impression as a full form, doing this work in the quickest possible time and in a manner that it would be difficult to excel. The important features of the Potter Proof Presses are briefly stated as follows:

The cylinder is equipped with automatic grippers which take the sheet over the impression and release automatically at the end of same. The combination of these grippers with the adjustable feed guides make it possible to take the most accurate color proofs which would ordinarily require the use of a cylinder or platen press.

The trip which lifts the cylinder off the impression and is easily operated by a foot treadle, makes possible the return of the cylinder to the original position without inking the draw sheet of the cylinder.

The cylinder is of heavy construction, giving a solid, unyielding impression and is fitted with reel rods, which make it possible to pack the cylinder in the same manner as the most modern two-revolution press.

The reel rods in the cylinder are of very simple mechanism, easily operated in a minimum amount of time.

The continuous register rack runs the full length of the bed and is engaged by the large gear on the cylinder. This insures absolute register, and overcomes any possibility of slurring or wear on the type.

Quick clean proofs with cuts well brought out and every error in composition or damaged type shown clearly are being turned out daily by users of the Potter Proof Press. Machines are equipped complete with inkplate, trip, cast brayer and galley plate for use when proofs are taken of matter not in the galley, such as individual cuts, etc. The machine will also be supplied without trip for plants where straight work is done, such as linotype offices, etc.

Each Machine regularly furnished is supplied with rubber blanket and heavy press board, for bringing the rubber blanket directly next to cylinder and wrenches. If you want good proofs at the minimum of expense the Potter Proof Press is the machine for you to buy.

The Potter Proof Press is built in four sizes to suit the various requirements of all printers. The latest No. 0 machine has no grippers or impression trip, but otherwise is the same as the regular Potter Proof Press. It is a splendid machine for the smaller sized shops and for large printers who need more than one press for one color proofing. It is very easy to operate, being designed primarily for speed and convenience. It can take equally as good proofs as the regular machine, excepting that it has none of the attachments for taking register proofs.

The No. 1 Potter Proof Press is equipped complete with grippers and impression trip for printers who do not have large forms to prove.

The No. 2 Potter Proof Press is the same as the No. 1, but has wider bed. It has grippers and trip, and is known as the standard machine, as it will handle the work of almost any printing office, large or small.

The new model No. 3 Potter Proof Press is equipped with grippers, trip and feed table and also has an inking attachment. It is easily operated as it has eight anti-friction bed rollers under the impression and four on the tracks. It is massive and substantially constructed throughout and weighs about eighteen hundred pounds. This machine is designed for large commercial plants and newspaper offices where full page forms are proved at one time. It will also be useful to country newspapers as it will print two pages of a six column paper.

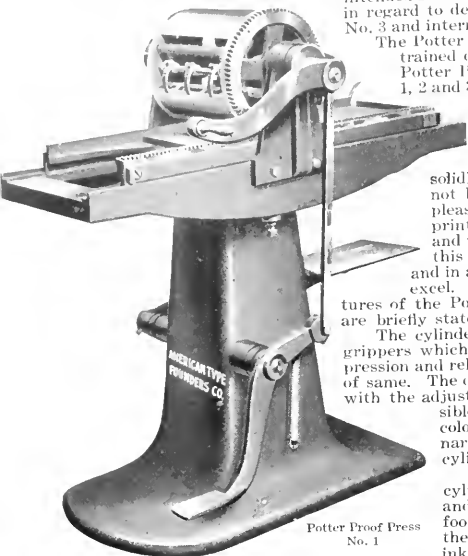

Potter Proof Press No. 1

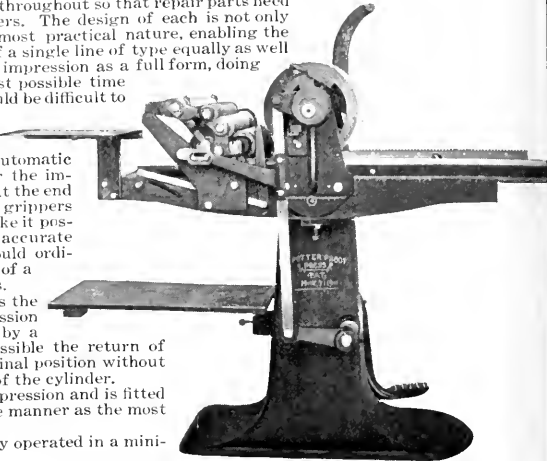

Potter Proof Press No. 2 with inking attachment



Potter Proof Press No. 3



Potter Proof Press No. 0

Prices of the Potter Proof Presses

No. 0 Potter Proof Press, bed 11x24 inches	\$110 00
No. 1 Potter Proof Press, bed 10x25 inches	150 00
No. 2 Potter Proof Press, bed 16 1/2 x 25 inches, without inking device	200 00
No. 3 Potter Proof Press, bed 25x32 inches, complete with inker and feed board	400 00
Inking device for No. 2 press, complete with cast rollers	85 00

Wesel Patent Electric Self-Inking Proof Press

The Wesel Electric Proof Press is a self-inking proof press, which is designed to be operated by an electric motor. It can also be operated by hand. The entire press is thoroughly well made and finished and will do fast and accurate work. Twenty-five proofs per minute can be easily taken. It gives a sharp, clear impression over the whole form. The quality and amount of its output makes the Electric Proof Press a far more economical press than any other. The press stands on a strong pedestal, strongly supported by braces. A pedal operates the friction clutch. The impression cylinder is of steel covered with seamless rubber tubing.

Sizes and Prices of Wesel Patent Electric Self-Inking Proof Presses

Wesel Electric Self-Inking Proof Press, bed 10x29 inches, with motor complete	\$210 00
Wesel Electric Self-Inking Proof Press, bed 12x29 inches, with motor complete	265 00

In ordering, state voltage of current by which motor is to be driven. With each press a set of cast rollers is furnished.



Wesel Patent Electric Self-Inking Proof Press

Vandercook Composing Room Automatic Cylinder Proof Press

The Vandercook Composing Room Cylinder is virtually a perfected printing press without the disadvantages of lock-up and making-ready. Forms are placed on the stationary bed, inked automatically, sheet is laid on or fed to gripper, and the proof is taken instantly with just the right impression. No matter how large or small the form may be, uniform, excellent proofs are the result.

The bed and form remain stationary. The method of holding down the cylinder to the best advantage is a new and valuable idea in printing press construction. The method of distributing the ink is also a decided departure and advance over other methods. It is perfect. The gripper, arranged on the cylinder that it is impossible for them to strike a form, even if it is a half-line beyond the printing lines. They insure a constant diameter of plates and forms by careless workmen. The register is so perfect that a halftone can be proved two or more times and show absolute register. A simple lever at the side of the press causes the cylinder to pass high over the type, clear from the form. This feature enables the operator to run the press backwards and forwards should he so desire without soiling the type. In proving book pages they may be laid out on the bed so that they will fold in book form. Large sheets may be fed to the grippers easier than they can be laid on the form. By removing the brass bedplate proofs can be taken direct from the galleys. This is very useful in proving large mailing lists. There are many of these proof presses in use in the best newspaper and job printing offices and are giving the very best results. Send for descriptive circular.

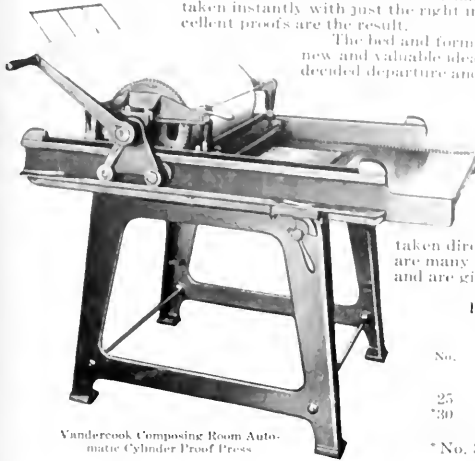

Vandercook Composing Room Automatic Cylinder Proof Press

Prices and Dimensions of the Vandercook Composing Room Cylinders

No.	Actual Printing Surface	Floor Space Over All	Approximate Shipping Weight	Price
25	25x25½ in.	48x60 in.	1150 lbs.	\$385 00
30	25x25½ in.	48x60 in.	1150 lbs.	187 00

* No. 30 is plain, without automatic inking attachment, grippers or trip action.

Vandercook Roller Series Proof Press

This Roller Press was designed for linotype, monotype and general galley and mailing list work, but may be used for regular job work. The inking rollers are passed over the form to a position under the cylinder, which is then brought over the form to the opposite end of the press. The operation is then reversed, a proof being taken at each travel of the cylinder. The action is so precise that no lock-up or even tie-up is necessary. The matter is inked with special hand operated roller device, with vibrator, giving perfect distribution.

This Roller Press is also furnished without inking attachments in two sizes, No. 15, the regular galley size, for use with hand brayer, and No. 30, also hand inked, but large enough for full newspaper page. It will give the best of satisfaction. Send for descriptive circular.



Vandercook Proof Press - Roller Series Especially for Galley Work

Prices and Dimensions of the Vandercook Proof Presses

No.	Actual Printing Surface	Floor Space Over All	Approximate Shipping Weight	Price
15	Plain 11¾x25 in.	22x48 in.	500 lbs.	\$125 00
20	Ink Att. 10x25 in.	22x48 in.	550 lbs.	185 00
30	Plain 25x25 in.	42x54 in.	1150 lbs.	187 00

Vandercook High Side Arm Proof Press

This Proof Press was designed for a general run of work and is largely used in job and publishing plants. It is easy to handle and the quality of its work and speed of operation are remarkable. The impression is made on the forward movement, the trip action raising the platen so that it clears the form on the return movement. The entire impression strain is carried on two solid wheels on trunnion, one on each side of the curved platen, thus giving a perfectly uniform impression. Heavy cuts and fine line work may be proved at one impression with equally good results, without make-ready. The matter is inked by hand brayer.

The Nos. 5 and 10 High Side Arm Presses are suitable for galley work.

List Prices and Dimensions of the Vandercook High Side Arm Proof Presses

No.	Actual Printing Surface	Floor Space Over All	Approximate Shipping Weight	Price
1	12x18 in.	38x42 in.	700 lbs.	\$165 00
5	11x25 in.	38x48 in.	850 lbs.	187 00
10	17x25 in.	44x48 in.	950 lbs.	220 00

Chandler & Price Galley Proof Press

The Chandler & Price Galley Proof Press is almost too well known to need a lengthy description here. We might say, however, that hundreds of these presses are in daily use and giving entire satisfaction. They are built in the same factory and under the same careful supervision as the well-known line of Chandler & Price Gordon Presses and Paper Cutters, which should be a sufficient guarantee that they are built right. The Chandler & Price Galley Proof Presses are thoroughly braced and possess an accurate bed and cylinder, the latter being much heavier than the average galley proof presses and consequently should give a better impression.

The American Type Founders Company's line of printers' proof presses is very extensive. This company constantly lives to its motto, "Everything for the Printer." We are always pleased to give expert advice in the matter of equipment.

Prices of Chandler & Price Galley Proof Presses

No.	Size Inside	List Price With Stand	No.	Size Inside	List Price Without Stand
1	10x31	\$30 00	1A	10x31	\$22 50
2	16x31	40 00	2A	16x31	30 00



Chandler & Price Galley Proof Press

Each C. & P. Proof Press furnished with blanket, brayer frame and stock. Write for discounts.

Washington Hand Proof Press

Many radical improvements have been made in the Washington Hand Press, which cannot fail to still further increase its great popularity. It is constructed entirely from new patterns and all parts are now interchangeable. The platen has been strengthened by transverse ribs, and in order to resist the force of the impression, and to make it uniform at all points, the bed has been made heavier. A brace extending upwards against the frame strengthens the lever support. The bed trucks have been made stronger and the studs, steps and points are all of hardened steel.

Prices of Washington Hand Proof Presses

No.	Bed Inches	Regular Style	Extra Heavy
No. 1	17x21	\$150 00	\$175 00
No. 2	20x25	175 00	200 00
No. 3	24x29	200 00	225 00
No. 4	26x34	225 00	250 00
No. 4 ¹ / ₂	27x39	250 00	275 00
No. 5	29x42	250 00
No. 6	32x47	275 00

Prices quoted on Washington Hand Proof Presses are f. o. b. factory.

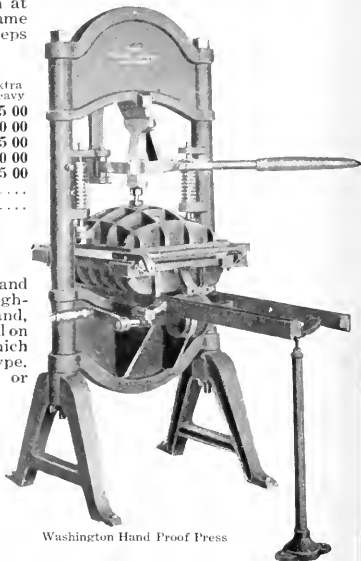

Washington Hand Proof Press

Challenge Proof Presses

These proof presses are built to give the best possible service, and are supplied with and without stands. The bed of each is true and even. The roller is extra heavy, on the No. 1 weighing eighty-five pounds. Its circumference equals the length of the bed and, consequently, it takes only one revolution from end to end. The felt used on the roller is of the finest quality. These proof presses are machines which will give clear and distinct impressions with no injury to delicate type.

Nos. 00, 01, 02 and 06 are made to fasten on a stand or table. Nos. 0, 1, 2, 3, 4, 5 and 6 have a substantial iron frame. Directly beneath the bed is a convenient spring door cabinet used for ink, etc.



Proof Press with stand



Proof Press without Stand

Sizes and Prices of Challenge Proof Presses

Size	Size of Bed	Shipping Weight	List Price
No. 00	9 x 27-inch bed without stand	135 pounds	\$17 50
No. 01	10 ¹ / ₄ x 32-inch bed without stand	200 pounds	20 00
No. 02	16 ¹ / ₂ x 35-inch bed without stand	345 pounds	30 00
No. 06	9 x 40-inch bed without stand	160 pounds	22 00
No. 0	9 x 27-inch iron stand, cabinet	219 pounds	25 00
No. 1	10 ¹ / ₄ x 32-inch iron stand, cabinet	275 pounds	30 00
No. 2	16 ¹ / ₂ x 35-inch iron stand, cabinet	430 pounds	40 00
No. 3	20 x 38-inch iron stand, cabinet	830 pounds	60 00
No. 4	24 x 42-inch iron stand, cabinet	900 pounds	75 00
No. 5	27 x 44-inch iron stand, cabinet	1300 pounds	125 00
No. 6	29 x 46-inch iron stand, cabinet	230 pounds	30 00

We shall be pleased to give additional information regarding any line of Proof Presses.

New Century Ink Fountain

The New Century Ink Fountain is used on Chandler & Price and Gordon Presses. It makes possible an evenly inked form and an ink supply to meet the form requirement. It will increase the press output many hundred impressions per day and will not mark the form or print. It will minimize offset dangers and make the dreaded wash-up a quick and easy task. Its quick, one-screw ink regulation and one-screw contact adjustment, not only save time, but insure that beautiful, even, uniform color so prized by printers who do high quality, distinctive work.



New Century Ink Fountain

Always specify size and make of press if the New Century Ink Fountain is desired for use with other than the Chandler & Price and New Series, or the Challenge Gordon Presses, as special attachments are required.

The New Century Ink Fountain fits all sizes New Series and regular Chandler & Price Presses; also Challenge Gordon from 8x12 to 14x28.

Price, complete \$10 00

The C. & P. Long Fountain

This Fountain is used for the better grades of printing, halftone, and work where fine, even distribution is essential. Thousands of these fountains are in constant use and invariably give the greatest satisfaction. It is simple in construction and effective in operation. Flow is readily adjusted and the fountain can be quickly removed and another substituted for colors if desired.

Price \$20 00

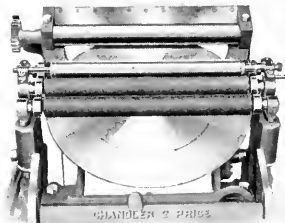

C. & P. Long Fountain with vibrating roller

This fountain is an economical device and is found to be entirely satisfactory on medium classes of work. It is readily attached, well constructed and its action is all that can be desired. The roller can be quickly removed for cleaning and the ink supply adjusted with expedition.

Price, Buckeye Fountain \$10 00

The C. & P. Buckeye Fountain

This illustration shows the position of the Buckeye Fountain, which is generally used on smaller sizes of the Chandler & Price and other presses. This fountain is an economical device and is found to be entirely satisfactory on medium classes of work. It is readily attached, well constructed and its action is all that can be desired. The roller can be quickly removed for cleaning and the ink supply adjusted with expedition.

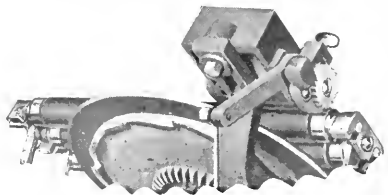

Buckeye Fountain

Vibrating Roller for C. & P. Presses

This is an extra, which should be used on halftone or solid work which requires exceptional distribution. Its action produces the same result as double rolling the form and it absolutely prevents streaking.

Price, Vibrating Riding Roller \$10 00

The capabilities of this catalogue are large, but they are not ample enough to allow space for all the appliances which are used in the art of printing. If you do not find just what you want in this list, do not rest under the impression that we cannot get it for you. Our aim is to please our customers and fill their requirements, so write us at once and we will promptly execute your wishes.

The Miller Universal Saw-Trimmer

The Miller Universal Saw-Trimmer is unique in many important features and has so many advantages of real merit that it should be an indispensable portion of the equipment of every modern composing room.

It is the only machine that saws and trims in one operation, guaranteeing absolutely to American Point System; that saws zinc blocks of any size without leaving the printing surfaces; that rabbets zinc tint blocks with the circular saw, the complete operation of sawing and rabbeting being finished in less than five minutes per block; that drills six, eight, ten, twelve and eighteen-point to American Point System; that planes, tucks and "dips" in the center; that mechanically routs or jigs a perfect curve.

It combines a saw blade and trimmer head in one so that they act simultaneously. In these lie the basic principle of the entire machine. The saw and trimmer are on the same mandrel with the trimmer knives projecting through the saw blade. The knives, when changed for sharpening, can be readjusted in a few moments with the utmost accuracy.

By simply turning the knurled worm the lateral micrometer gauge is adjustable to points and fractions of points. If it is desired to change the adjustment quickly, the gauge may be lifted free from the rack and moved backward and forward rapidly as in the ordinary quick-acting vise. It is locked automatically by simply dropping it back into place. The gauge is absolutely accurate to within one thousandth of an inch. The capacity length is sixty pieces. Where lengths more than sixty pieces are to be handled an extra gauge can be obtained which will give the machine a capacity up to one hundred and sixty pieces. The table slides freely and every provision is made for wear. By raising and lowering of the table by means of the crank and dial at front of the table, the projection of the saw blade is regulated to point accuracy. This really constitutes a vertical micrometer gauge, so that in making tucking or register hook bevels, mortising or undercutting, the depth of the cut is readily determined.

All the ordinary operations arising in the composing room are quickly taken care of by the standard equipment, such as sawing and trimming linotype slugs, and similar metals to the accuracy of a yard; squaring, mortising and undercutting cuts accurately to piece and point measurement; making furniture, register, and tint blocks; notching initial letters, etc.

The tools furnished with the standard equipment limit its use to wood, linotype slugs, electrotypes, stereotypes and the softer metals. If conditions require work of a still greater scope, convenient attachments for handling same can be provided with the machine or at any subsequent time. No mechanical change is necessary for their application. The attachments usually furnished are the brass saw for cutting brass rule, brass embossing plates, zinc and copper; the rabbeting head for tacks; the beveler head for register hooks and the router and jig-saw attachment.

Equipment of Miller Universal Saw-Trimmer

The equipment furnished with the Miller Universal Saw-Trimmer consists of the following: One column complete with table, elevating mechanism, saw arbor and single pulley idler; two six-inch standard saws and heads with trimmers; one sixty-piece swivel gauge with locking bolt, nut and locating-pin; one sixty-piece point end gauge; one five-point line holder; one locking screw; one miter vise; one batter with locking screw and washer; one saw hood with bolt one screw-driver; one brush; one machine oil can.

Miller Universal Saw-Trimmer with Router and Jig-saw Attachment in working position and motor attached



Miller Universal Saw-Trimmer

Price, Universal Saw-Trimmer with standard equipment only \$300 00

The Router and Jig-saw Attachment

This attachment is invaluable for routing, drilling, jig-sawing and type-high planing. To swing it into working position, it is only necessary to remove the circular saw and elevate the table. No change of speed or shift of belt is required. The complete change from Universal Saw-Trimmer to Router and Jig-saw and vice versa can be made in thirty seconds.

The speed of the saw arbor is thirty-six hundred revolutions per minute; of the router and drill, fourteen thousand per minute; and of the jig-saw, thirteen hundred and fifty strokes per minute.

Equipment

The equipment furnished with the Router and Jig-saw attachment consists of the following: One router and jig-saw head with locking bolt; one driving pinion; one foot treadle and chain; six router belts; one type-high gauge; one work plate with four locking levers; three narrow jig-saw blades; three wide jig-saw blades; one broach; six router bits—one-sixteenth, one-eighth, three-sixteenths, one-fourth, one-half and three-fourths of an inch; seven drills—two six-point, two eight-point, one ten-point, one twelve-point, one eighteen-point; one countersink for screws; one eight-point pin for circles; one sperm oil can; one stand for attachment.

Practically all of the tint blocks used in the display pages of this catalogue were made on the Router Attachment of the Miller Universal Saw-Trimmer by means of an off-set impression on maple engraving block and then placing the block on the bed of the Saw-Trimmer and following the lines desired to be routed. After a little experience very close work is possible.

Price, Router and Jig-saw Attachment with tools \$200 00

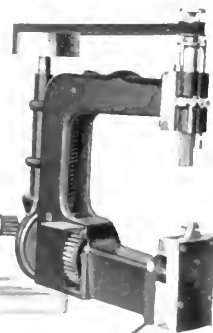

Miller Universal Saw-Trimmer with Router and Jig-saw Attachment

Special Attachments

The following attachments will fit any Universal Type Saw-Trimmer, but are not included in the standard equipment:			
160-piece point end gauge, complete	\$25 00	Angle Cutter Vise, complete	\$10 00
4-point, 5-inch brass saw and head, complete	20 00	Angle Cutter Grinding Attachment	15 00
Brass Saw Grinding Attachment and dish emery wheel	10 00	Line holders, per set, complete (any size)	5 00
Beveling head, complete	10 00	Right-hand Miter Vise, complete	10 00
Rabbeting head, complete	10 00	Glass Guard, complete	7 50
Register Gauge, complete	15 00	Double Pulley Idler, complete	5 00
12-point attachment for workholding vise	10 00	12-point, 5-inch special brass saw, with head complete	20 00
120-degree Angle Cutter with head, complete	25 00	6-point, 5-inch special brass saw, with head complete	18 00
90-degree Angle Cutter with head, complete	22 50	3-point, 5-inch special brass saw, with head complete	18 00
60-degree Angle Cutter with head, complete	20 00	2-point, 5-inch special brass saw, with head complete	18 00
45-degree Angle Cutter with head, complete	17 50		

Special Motors for the Universal Saw-Trimmers

The motors listed are of ample power and fully guaranteed by the manufacturers.

Direct current motor, with starting box, 110 or 220 volts	\$50 00	Alternating current motor, 2 phase, 60 cycle, 110 or 220 volts	\$60 00
Direct current motor, with starting box, 500 volts	60 00	Alternating current motor, single phase, 60 cycle, 110 or 220 volts	75 00
Alternating current motor, 3 phase, 60 cycle, 110 or 220 volts	60 00		

Above prices cover motors mounted on special iron sub-bases attached to column and complete with pulley and belt to saw arbor. Countershaft (attached to column with bolt to saw arbor), complete \$25 00

Weight (Crated for domestic shipment)

Universal Saw-Trimmer, without motor or countershaft (approximately)	325 lbs.	With Motor (approximately)	400 lbs.
With Countershaft (approximately)	350 lbs.	Router and Jig-saw Equipment, boxed (approximately)	125 lbs.

New Mercantile Addressing Machine

The Mercantile is a simple machine built wholly of iron and steel, with polished steel working parts and can be supplied either with or without power. A substantial pedestal supports a long flat bed grooved to receive a galley in which is held the addresses.

The best method of setting these addresses is to use American Type Foundry Company's Time-Saving Mail-List Type, but linotype slugs or other cheap material may be used. This groove is covered with a nickel plated steel cover which has an opening in the center sufficiently large to accommodate the size of address used. The printing arm, a "V" shaped piece, the upper half of which is shown in the cut herewith, is actuated by a rod fastened directly to the treadle below. This arm is fitted with a rubber printing head. By means of a steel hook which engages the last line of type in the cover, the address is pulled forward exactly under the opening in the steel cover. The wrapper, envelope or other matter to be addressed is fed into contact with the inked type and the rubber tipped arm descending brings the paper into contact with the inked type and secures an address as perfect as if printed on a printing press. When the treadle is released, a strong spring raises the printing arm and the next address is automatically pulled into position. One downward motion of the treadle and its release suffices for the whole operation. The machine can be operated just as fast as the treadle can be depressed and released and as the speed of this operation is far in excess of the number of sheets which can be fed into position, the output is limited only by the dexterity of the operator. A good average speed is from two thousand to three thousand per hour, but it is possible to double this.

The work of the Mercantile is excellent. One of the great advantages which it possesses is that of printing of imitation typewritten addresses, either direct or through silk. These addresses may be made to match perfectly letters printed at high speed on regular printing presses, multigraph or other suitable devices. This is almost invaluable in circularizing. The favorable impression which a neatly printed envelope creates upon the mind of the recipient is of great value to the advertiser. After your mailing list is once prepared there is practically no chance for error. Every name and address is neat

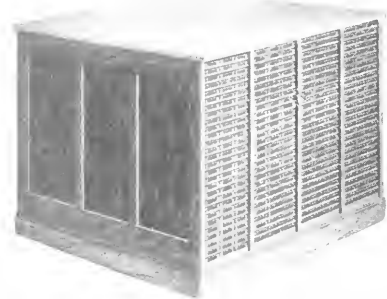

Mercantile Addressing Machine Cabinet

and legible. There are no pasted labels to rub off the back part of the envelope, wrapper or invoice. There is no handling of the individual addresses. A galley containing from fifty to one hundred and ten addresses is shoved into the groove under the nicked plate until it engages the propelling hook. The galley then requires no more attention until the bell rings to indicate the last address and it is pulled out and another substituted. A cabinet containing fifty thousand addresses occupies a floor space of only forty-three by thirty-four inches and is an ornament to any office. Every name in a list of this size would be within the reach of the operator and if properly indexed could be instantly located.



Mercantile Addressing Machine Galley

Galleys are thirty inches long, constructed of the best double compressed sheet zinc. The addresses are held firmly in place by a thumbscrew at the end of the galley. Addresses varying only one line in width may be used promiscuously when a ten point lead, slug or wood reglet is used after each address. One of the greatest advantages of this equipment is the convenience with which changes or corrections can be made. The system lends itself readily to classification, alphabetically or otherwise, and any name on a list is readily accessible. When our Time-Saving Mail-List Type is used, the cost of making changes in the list is simply the cost of distribution and composition of the type. This work may be readily done by any intelligent boy. Machines are made regularly in three sizes, ten, fourteen and sixteen ems in width. Special widths can be made to order.

- Prices of Mercantile Addressing Machines and Cabinets**
- No. 1 Mercantile Addressing Machine, for 10 em names, \$40 00
 - No. 2 Mercantile Addressing Machine, for 14 em names, 50 00
 - No. 3 Mercantile Addressing Machine, for 16 em names, 60 00
 - No. 4 Mercantile Addressing Machine, for 16 em names, with Duplicating Attachment, 90 00
 - Power Attachment fitted to any size Mercantile Addressing Machine, 30 00

	Width	Height	Depth	Price
Style A	—12 $\frac{3}{4}$ inches	14 $\frac{1}{2}$ inches	34 inches	\$13 50
Style B	—22 $\frac{3}{4}$ inches	14 $\frac{1}{2}$ inches	34 inches	19 00
Style C	—22 $\frac{3}{4}$ inches	24 $\frac{1}{4}$ inches	34 inches	26 75
Style D	—22 $\frac{3}{4}$ inches	43 $\frac{3}{4}$ inches	34 inches	42 75
Style E	—42 $\frac{1}{2}$ inches	43 $\frac{3}{4}$ inches	34 inches	56 00

For prices and information regarding Mercantile Addressing Machine Galleys refer to the galley section of this catalogue. Send for circular giving complete details and illustrations of these machines.

The New Wing-Horton Mailers

The large number of Wing-Horton Mailers in use well demonstrate their superiority. The machine is particularly adapted to the use of publishers, societies and business houses that mail a large number of envelopes or circulars to members and customers. It is guaranteed to do better, easier and faster work than any other mailer, and is easy to learn to operate. It is held naturally, does not cramp the muscles of the hand or arm and can be operated equally well with either hand. It perfectly guides and thoroughly pastes the slip, removes all surplus paste and the papers or wrappers are not stuck together. The knives are reversible. The rollers which feed the paper are pressed together by a spring and accommodate different thicknesses or inequalities in the paper. The Wing-Horton Mailer is manufactured in six sizes, to carry any list from 1 $\frac{1}{2}$ inches up to 3 $\frac{3}{4}$ inches.

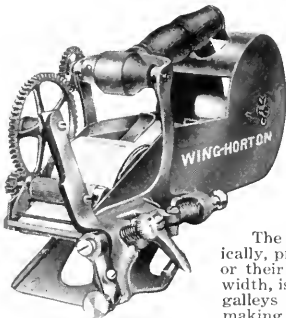

Wing-Horton Mailer

Prices and Dimensions of Wing-Horton Mailers

No. 1.—Size 1 $\frac{1}{2}$ inch	20 00	No. 4.—Size 3 inches	35 00
No. 2.—Size 2 $\frac{1}{4}$ inches	25 00	No. 5.—Size 3 $\frac{1}{2}$ inches	40 00
No. 3.—Size 2 $\frac{3}{8}$ inches	30 00	No. 6.—Size 3 $\frac{3}{4}$ inches	45 00

The Mustang Mailers

The Mustang Mailer prints directly on the paper or envelope. The platen and its frame move automatically, printing one address only at a time. It will print addresses making three lines of eight point type, or their equivalent. It occupies a space of thirty-seven inches in length and four and one-half inches in width, is made wholly of iron, without springs or complications of any kind. The mail list is made up in galleys ten ems pica wide on the inside. Each galley holds seventy-five addresses, is easily accessible for making corrections, and is convenient to handle. The machine weighs about fifteen pounds and the galleys one pound each. The mailer is capable of printing addresses at the rate of fifteen hundred to twenty-five hundred per hour, according to the expertness of the operator in passing the paper to and from the mailer.

List Prices and Dimensions of the Mustang Mailers

Mustang Mailer, 10 ems	\$10 00	Mustang Mailer, 13 ems	\$14 00	Galleys each	\$0 50
------------------------	---------	------------------------	---------	--------------	--------

The Acme Mailing Machine

The Acme Mailing Machine has been greatly improved, simplified and strengthened. It is light and convenient and may be readily handled by anyone who has learned to use a mailing machine. It will do a large amount of work in the shortest space of time and with least labor to the operator.

Price of the Acme Mailing Machine

Acme Mailer, complete	\$15 00
-----------------------	---------

Ideal Form Trucks

The Ideal Form Trucks are very substantially built and embody the latest designs in improved construction. The body of each truck is of unusual strength, and carries the form close to the floor, making it almost impossible to upset the truck, at the same time facilitating the handling of the form. They are made in two styles. No. 1 has solid iron wheels. No. 2 is provided with rubber tires, which prevent slipping and are easier to propel on any floor. Boxed individually.



Ideal Form Truck

List Prices of Ideal Form Trucks

No. 1 Ideal Form Truck, with iron tires	\$1 00
No. 2 Ideal Form Truck, with rubber tires	50

Success Safety Three Wheel Form Truck

The Success Safety Form Truck has the great advantage of supporting a form safely, no matter how heavy it may be. The form is supported by a stout rod, to which it is held by an adjustable clamp. This obviates the necessity of supporting the form by hand. The front wheel has swivel bearings, so that the load is guided with more ease and sureness than is possible by the use of an ordinary truck. The construction is extraordinarily strong, and of first class quality.

Prices of Success Safety Form Trucks

Success Safety 3 Wheel Form Truck	\$10 00
4 Wheel Form Truck	6 00
2 Wheel Form Truck, cast iron (15 lbs.)	3 00
2 Wheel Form Truck, malleable iron (11 lbs.)	3 00
Rubber Tires, extra, per wheel	1 00

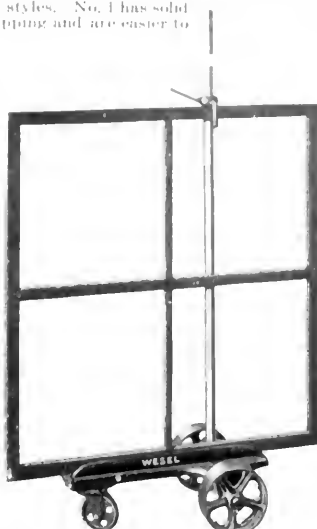

Success Safety Three Wheel Form Truck

Sectional Chase and Form Rack

The Sectional Chase and Form Rack is a new article for pressroom and composing room requirements, and provides a suitable holder for chases and locked forms at a very moderate price. In the pressroom the Sectional Chase and Form Rack can be put in position convenient to the presses, and forms when received from the composing room, ready for the press, can be temporarily placed in this rack until required for printing. In the composing room the use of the Sectional Chase and Form Rack will clear up the office, allow more stone room and minimize the danger of pied forms. This Rack is made in two sections and sold in sets consisting of two sections "A" and one section "B." One each of section "A" and six chases or forms. If provision for more chases or forms is required, other sets can be added, as the sections are designed to work in multiples. Made of cast iron, strongly reinforced to withstand any amount of hard usage. The Sectional Chase and Form Rack represents the newest device for economically placing chases and forms.

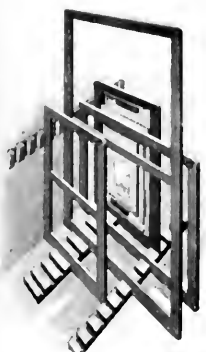

Sectional Chase and Form Rack



Section A

Section B

Set consisting of two of Section "A" and one of Section "B".

Set consisting of two of Section "A" and one of Section "B".	\$3 75
Single Section "A," each	1 25
Single Section "B," each	2 50

Prices quoted on this page are subject to prevailing discounts which will be quoted on application.

Form Racks

The new Form Racks as represented by Nos. 0, 1 and 2 (see left hand illustration), are strong and substantially built. They take up a surprisingly small amount of floor space considering the number of forms accommodated. The bottom boards where the forms rest are covered with sheet iron turned at the edges and firmly fastened. This prevents wear and tear which would otherwise occur when heavy forms are pushed into the compartments. The use of these Racks will clear up the office, allow more stone room and minimize the danger of pied forms.

Prices and Dimensions of Form Racks

No. 0. Height, 6 feet 9 inches; width at base, 22 inches; length, 2 feet 8 inches. Shelves for 10 chases in each tier, 30 shelves in all. Weight, 350 pounds.	\$21 00
No. 1. Height, 6 feet 9 inches; width at base, 22 inches; length, 3 feet 9 1/2 inches. Shelves for 16 chases in each tier, 48 shelves in all. Weight, 475 pounds.	36 00
No. 2. Height, 6 feet 9 inches; width at base, 22 inches; length, 5 feet 1 1/2 inches. Shelves for 24 chases in each tier, 72 shelves in all. Weight, 600 pounds.	52 00

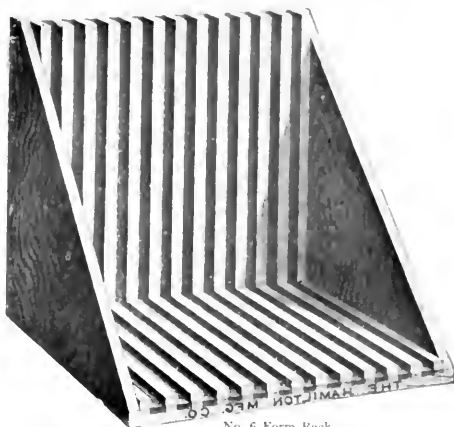

No. 6 Form Rack

No. 2 Form Rack

The Form Racks represented by No. 5 and No. 6 (see right hand illustration) are new articles especially designed for pressroom requirements, and provide suitable holders for locked forms at a very moderate price. Racks can be placed near presses and forms when received from the composing room ready for the press can be temporarily placed in these Racks until required for printing.

Price and Dimensions of No. 5 Form Rack

No. 5 Form Rack provides accommodation for 18 large chases. The height at the back is 31 1/4 inches; the depth from front to rear is 25 inches; the width across the front is 37 inches. The bottoms of chase grooves are lined with iron, turned at the edges and fastened with screws at the front, to prevent damage to woodwork. Weight, crated, ready for shipment, 200 pounds.

\$22 00

Price and Dimensions of No. 6 Form Rack

No. 6 Form Rack provides accommodation for 12 medium size chases. The height at the back is 25 1/4 inches; the depth from front to rear is 19 inches; the width across the front is 25 1/4 inches. The bottoms of chase grooves are lined with iron, turned at the edges and fastened with screws at the front, to prevent damage to woodwork. Weight, crated, ready for shipment, 100 pounds.

Price

\$11 00

The Miller Incline Truck

The Miller Incline Truck, Platform and Skids end all truck troubles of the printer. No trucks are tied up for every platform is a truck. By this plan the pile of sheets does not rest on the floor, but on a platform, which in turn rests on skids. The truck—lowered—is shoved under the platform, between the skids. Then the crank is given a few turns and as the top part of the truck is elevated by an incline plane device, it raises the sheets and platform clear of the skids. It will do this even if the sheets weigh five thousand pounds, which is the small truck's guaranteed capacity. No exertion is necessary on the part of the workman. The sheets remain in perfect order and all the man has to do is walk away with the load. The truck is equipped with either round axles, or roller bearings, so it is easily pulled. When the destination is reached another pair of skids stand ready. A twist of the crank to the left and the sheets and platform are then deposited safely. Such a change as this can be made very quickly. The truck is now ready for other work. This truck may truly be said to take the place of fifty trucks, as it is only a question of having enough skids and platforms to meet your needs and these, which may be readily constructed and are cheap, may be placed at convenient positions all over your plant.

The Miller Incline Truck is applicable to every business, where much moving of wares is done.

There is a fifth wheel plate in front, except on the No. 1, which has a large size castor. If preferred a truck may be equipped with all castors and swivel castors. Prices will remain the same.

That the Miller Incline Truck is an investment which readily pays for itself is confirmed by some very strong testimonials which have been received.

The Knapp Company writes that it is using about three hundred platforms operated by two trucks at its plant, located at Bush Terminal, Brooklyn. The Stone Printing and Manufacturing Co., of Roanoke, Va., states that it has found them very satisfactory. The H. Bridgman Smith Co., of Brooklyn, is using a truck with entire satisfaction. The Richmond and Backus Co., of Detroit, admits that there is nothing that it has added to its equipment in the way of a money-saver that has produced such an excellent result as this Truck. The R. R. Donnelley & Sons Co., of Chicago, states that it has found the Truck to be perfectly satisfactory, both as a time and money saver.

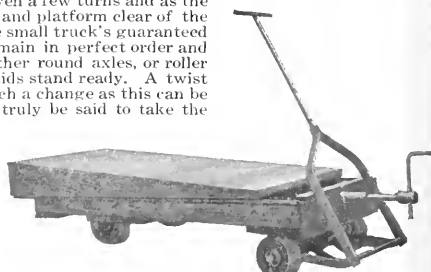

Miller Incline Truck

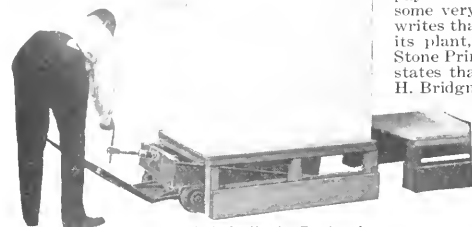

Method of Adjusting Truck under Loaded Platform

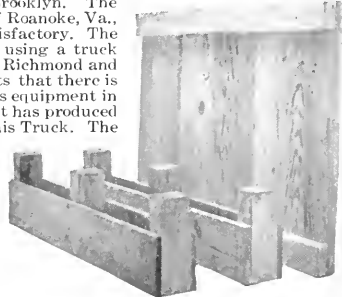

Platform and Two Skids

List Prices and Dimensions of the Miller Incline Trucks and Platforms

Truck No.	Size	Price
Truck No. 1	—22x30 (usually takes a platform 32x36)	\$100 00
Truck No. 2	—22x40 (usually takes a platform 32x44)	125 00
Truck No. 3	—28x40 (usually takes a platform 40x48)	125 00
Truck No. 4	—28x48 (usually takes a platform 40x54)	137 50
Truck No. 5	—28x60 (usually takes a platform 44x64)	150 00

One Platform, size 32x36, and two Skids for No. 1 Truck, price \$1.50; one Platform, size 32x44, and two Skids for No. 2 Truck, price \$2.25; one Platform, size 40x48, and two Skids for No. 3 Truck, price \$2.50; one Platform, size 40x54, and two Skids for No. 4 Truck, price \$3.00; one Platform, size 44x64, and Skids for No. 5 Truck, price \$3.50.

Wisconsin Printers' Trucks

These strong, easy running Trucks are made especially for the use of Koerner Interlocking Drying Racks and can be easily moved in a limited space. The Truck will turn in its own length, the two end wheels bearing on swivels. The handle is detachable and hooks on at either end—this feature saving much time in turning a truck laden with drying racks, paper or a form. These Trucks are designed to hold an unlimited number of Patent Interlocking Racks and may be depended upon to bear immense weight and give lasting service. They are unquestionably the easiest running printer's trucks on the market.

List Prices of Wisconsin Printers' Trucks

Truck No.	Size of Top	Weight, Crated	Price
No. 1	24x36 inches over all	160 pounds	\$16 00
No. 2	33x45 inches over all	180 pounds	18 00
No. 3	38x52 inches over all	200 pounds	20 00

Other sizes made to order at proportionate prices

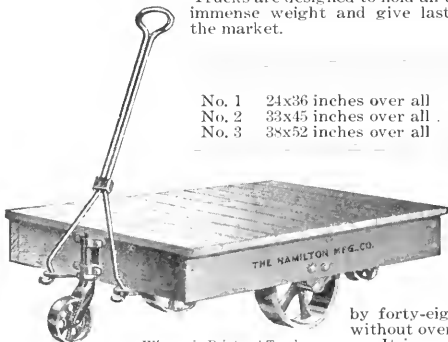

Wisconsin Printers' Truck

Hamilton Form Truck

A most convenient article to have around a printing office. It can be used to advantage trucking forms back and forth between the composing room and the pressroom, without danger of accident. It will take two forms, one on each side, up to thirty-four

by forty-eight inches, or several small forms, without overlapping the edges of form beds.

It is made of hardwood throughout, reinforced by cleats underneath, and mounted on four double-wheeled swivel castors. Diameter of wheels is three and five-eighths inches. This insures easy motion. The Truck can be turned around and reversed within the floor space it occupies. The handle is detachable, and of malleable iron. The bottoms of the grooves where the chases rest on the Truck are lined with iron, so that the woodwork will not be damaged.

Length, forty-eight inches; extreme height from the floor, thirty-nine and one-half inches; extreme width, forty-two inches; size of the sloping form beds, thirty-four inches high, forty-eight inches long. Weight, crated, ready for shipment, three hundred pounds.

List price \$48 00

Other sizes of this Truck made to order at proportionate prices.

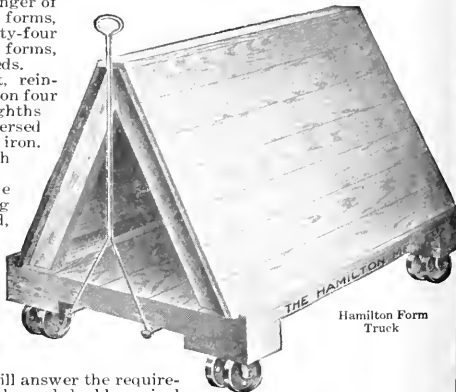

Hamilton Form Truck

Truck for Paper Rolls

In every large printing office using paper from the roll there is always a demand for a suitable truck for conveying the heavy rolls to the stock room when received, and from the stock room to the pressroom. This new Truck will answer the requirements fully. Made substantially of hardwood, with cast iron center wheels, and double swivel castors on the ends. If interested we shall be pleased to send you an illustration.

Length, twenty-eight inches; width, twenty-four inches; extreme height, fourteen and three-eighths inches; center height, eleven inches. Weight, crated, one hundred and fifty pounds.

List price \$24 00

All prices quoted on this page are subject to prevailing discounts.

Rouse Mitering Machine

This machine has so many excellent qualities that it is claimed to be the most perfect mitering machine made. It is equipped with a positive point gauge that sets instantly and locks automatically to point. This enables the operator to miter joints to nonpareils or points, inside as well as outside corners. The construction and operation of this gauge is shown in the X-Ray View.

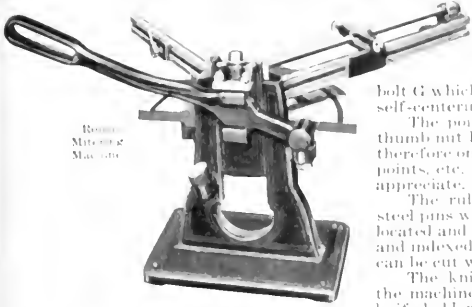

Rouse Mitering Machine

Here the gauge rod A on which the gauge head B slides is graduated to picas. It also has flaring notches milled on one side six points apart. These notches are engaged by four teeth of corresponding taper on the end of the beam bolt G which is held firmly in position by a stiff spring. These teeth are self-centering, take up all play or lost motion and compensate for wear.

The point adjustment shown in the front view is secured by the thumb nut H, one revolution of which moves the entire gauge six points, therefore one notch towards you adds one point, two notches two points, etc. This is an advantage which printers will be quick to appreciate.

The rule holder or guide is provided with two hardened steel pins which engage in the circular slot in the table, and is located and locked at the exact angle wanted. The table is drilled and indexed for 2, 3, 4, 5, 6, 8, 10 and 12 sided figures. Square sets can be cut without any change whatever.

The knife holder travels in two slots milled in the body of the machine. These slots, being wider than the guides on the knife holder, permit the knife to be fed up to the work with each

downward movement. The inner face of the slots form a positive stop, beyond which the knife holder cannot go. The knives of the best tool steel, hardened and set in the knife holder at the right angle to obtain best results. It is provided with adjusting screws by means of which it is held firmly and adjusted quickly. The edge of the knife can be easily maintained by means of a jointer. Price Rouse Mitering Machine, complete, with chip cup and jointer . . . \$20 00

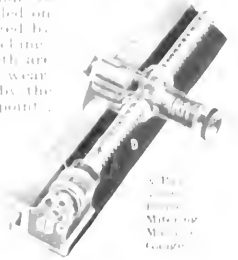

X-Ray View of Rouse Mitering Machine Gauge

Hansen Mitering Machine

As the rule holder in the Hansen Mitering Machine has an angle of ninety degrees, when it is placed in a central position, it is possible to miter square sets without changing its position. By means of a pin it is easily set to any desired angle and as there are no lines to guess at the operator is enabled to obtain the required angle, absolutely accurately at all times. It is graduated by twelve point ems and has two gauges. The left hand gauge has a supporter which enters any one of the holes of even ems and by turning the supporter a quarter turn, it lengthens or shortens the measure to a six point em. The inside measure is obtained by placing 2, 3 or 1 points between the supporter and the gauge. The knife is held firmly by two screws and is regulated by two adjusting screws. A jointer for sharpening the knife to the proper angle is furnished with each machine. This enables the operator to have the same bevel at all times, which is very essential in order to obtain a clean cut. The bed has an index, 2, 3, 4, 5, 6, 8, 10 and 12 respectively, representing the different angles for a 2, 3, 4, 5, 6, 8, 10 and 12 sided figure, therefore dispensing with lines to be guessed at. The handle strikes a rubber tube, thus obviating all noise and jar.

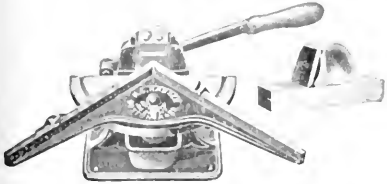

Hansen Mitering Machine

Price Hansen Mitering Machine, complete, with or without chip cups . . . \$18 50

American Lead and Rule Cutter No. 30

The well known American Lead and Rule Cutters were first made in 1899, and since that time they have been constantly improved in design, construction and finish. Without a doubt today they are recognized as possessing unexcelled merit, and are conceded to be the best cutters made. Cutter No. 30 is the latest development

and has the following advantages: the gauges can be set instantly; they are self locking and cannot slip, as there are no screws. They are guaranteed for accuracy. The mechanism of the Cutter is such that the gauges can be set in a fraction of the usual time required. The front gauge slides on a stationary rod, graduated to picas and acts as a truss to the gauge-cutting rod proper, thus forming a rigid construction. It is convenient for cutting short lengths, as the gauge can be set to nonpareil

as readily as any other measure. The point gauge comes with the No. 30 Cutter only and can be set quickly from six point to forty-five picas, by points. Capacity, 105 ems; by points 15 ems. List price American Lead and Rule Cutter No. 30 . . . \$12 00

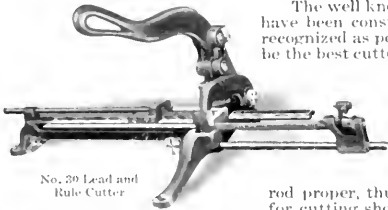

No. 30 Lead and Rule Cutter

Utility Lead Cutter

The strongest cheap lead cutter made and a reliable and handy tool.



Price Utility Lead Cutter, \$2 00

American Lead and Rule Cutter No. 20

This No. 20 Cutter is identical with the No. 30, except that it does not have the point gauge. The cutters are graduated to picas and numbered every five ems up to 105 picas. The measure is indicated by the bed gauge when reversed and extended beyond the bed. Sag in material is avoided by the support on the right. The extra foot at the left hand of the bed steadies the machine, even when placed on an uneven surface. Capacity, 105 ems.

List price American Lead and Rule Cutter No. 20 . . . \$10 00

The No. 1 Cutter is a good serviceable machine, and is adapted for small offices, paper box makers and for cutting odd lengths. It has a reversible bed gauge which is clamped and secured quickly by a compression thumbscrew. The gauge is numbered every five ems but is not graduated. There are two rows of figures on the bed gauge, one showing the measures in normal position and the other indicating the measures when the gauge is reversed and extended. The grooved bed, a feature of this machine, prevents slipping of thin material. The material

and workmanship of this cutter are the best obtainable. Capacity, fourteen inches. List price American Lead and Rule Cutter No. 1 . . . \$6 00

We also handle other sizes and will be pleased to quote prices and particulars

Rouse Lino-Slug Cutter

This Lino-Slug Cutter has been designed for cutting single linotype slugs. Besides being strong and compact, it possesses many valuable time-saving and accuracy insuring features. The gauge can be set instantly to any measure up to thirty-one picas, either by nonpareils or points. The gauge locks automatically and cannot possibly slip or be forced back when once locked. It is accurate and remains so. The knives are made of the best steel finely tempered. The upper knife is shaped so as to secure a shear cut. It will cut the thickest slugs clean and

square and of uniform length. It is the only slug cutter with a permanently accurate gauge on which it can be set instantly. It is the only slug cutter on which the gauge cannot slip and on which the last slug cut must be the same length as the first one.

Price Rouse Lino-Slug Cutter . . . \$12 00



Rouse Lino-Slug Cutter Front View

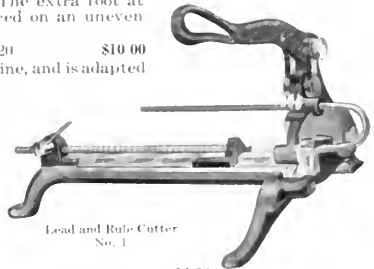

Lead and Rule Cutter No. 1

\$6 00



Rouse Lino-Slug Cutter Rear View

Hoerner's Combination Shute Board and Type-High Machine

Every printer knows what a source of annoyance it is to have cuts or plates, which are uneven or too high, sent to the press. The pressman resorts to all sorts of expedients to overcome the difficulty. He tries to scrape the cut down with a knife or sand-paper, and even with the greatest care and much lost time, is unable to make it satisfactory. Here is a machine at a very nominal price that will do the work quickly and cheaply. The Hoerner Combination Shute Board and Type-High Machine will reduce cuts to type-high and make them true and even, besides doing many other things that may be asked of it. Any printing office doing a considerable amount of cut work really cannot afford to be without one. If you desire to get your costs of production down, here is one way to begin. The Hoerner Combination Shute Board and Type-High Machine is simple, solid and accurately made. All parts, except the plane handles, are of iron or steel. Interchangeable planes, one carrying a knife blade and the other a file, work upon the carriage or guide frame. A block the full width of the machine can be shaved at one blocking as the carriage can be moved from side to side of the bed while operating. It will hold a block up to ten inches in width and of any length. The block is held down to the bed by a novel vise-lock, instantly adjusted by one turn of a small lever. The sliding cross bar, with miter point, can be set at any angle for mitering. The bed can be fastened to table or bench, thus leaving the operator free hands. This position has the added advantage of being convenient as a bench vise for holding blocks, while attaching or removing plates. Machine complete with file plane and one knife plane.

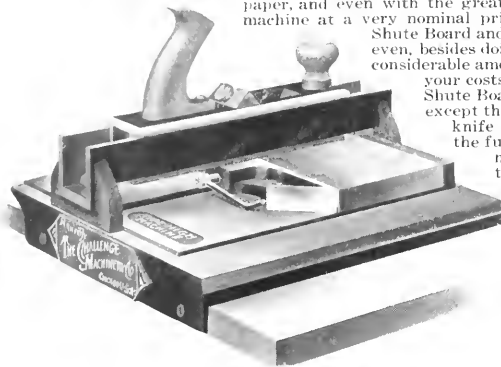

Hoerner's Combination Shute Board and Type-High Machine

the Hoerner is not absolutely required. It will do its work rapidly and the machine before the form is sent to press saves a great deal of time in Simply passing all cuts or plates mounted on wood through this machine entirely satisfactorily, and anyone can operate it successfully. To operate the Challenge Type-High machine the cut is placed face downward on the galley which is furnished with the machine and sheets of paper are placed under the cut as may be required to bring the cut to the desired height. When blocks are warped it is best to take the plate off and run the block through the machine, both top and bottom; this operation will make it smooth; then replace plate, adding sufficient cardboard or paper between the plate and block to make it a paper more than type-high; then run the plane over the block again and you have the desired height.

Price of Challenge Type-High Machine \$15 00

The Practical Height Gauge

While a great many printing offices and pressrooms already possess a Practical Height Gauge, there are still thousands of offices that would find use for one of them almost every day in the year. The Practical Height Gauge is one of the most useful money saving devices that one could desire. As soon as cuts are received from the engraver they can be tested for height. If too high they should be shaved down. If too low, the gauge will show the discrepancy and the cuts can then be built up to a proper height. The money saved by turning of cuts of proper size and height over to the compositor is too evident to need further argument.



The Practical Height Gauge

part is type high and ready for the press. Another great advantage in the Challenge Type High Gauge will be found in the fact that one end forms a gauge by which the cylinders and bearers of a press can be adjusted accurately.

List price Challenge Type High Gauge \$1 50

Mills Three-Heights Gauge

Gauges accurately standard heights of type (.918-inch), electrotypes (11-points) and zinc (16-gauge). The Mills Three-Heights Gauge can be carried conveniently in the pocket or attached to a chain, thereby constantly having it at your command when required. Newspapers using iron bases require advertisers to furnish unmounted electrotypes and process engravings, which must be of standard height. This Gauge detects inaccuracies which usually cause inferior results in printing.

Price, each

Challenge Type-High Gauges

This Type High Gauge covers the needs of every printer using mounted electrotpe plates, halftones, woodcuts, ornaments, initials, etc. It is absolutely accurate, being micro ground to .918 of an inch. It shows instantly whether every



Mills Three-Heights Gauge



Challenge Type-High Gauge

Price of Practical Height Gauge, each \$10 00

\$1 50

American Press Seats

One of the best evidences that the American Press Seat is a good thing is that some of the largest firms in the country buy it. It fits any press, entails no trouble to attach, and when in place is strong and secure. It fastens to the floor and to the feeder's platform. It can be adjusted in any direction, swings out of the way or may be taken off entirely. When in place it looks like a part of the press. By its use the workmen are more contented, work more steadily and produce more and better work.

Prices of American Press Seats

Fitted for attachment to the feeder and stand on large cylinder presses . . \$6 00
For small pony cylinder presses has a heavy standard that attaches to the floor (as these presses do not have feeders' stands) 7 00

The Matych Plate Cutter

The Matych Stereotype Plate Cutter is a machine devised for cutting stereotype plates. It will cut a plate as easily and as quickly as leads are cut on a lead cutter. It will cut between agate lines without injury to type on either side. Single line pieces cut with this machine can be used as well as agate pieces. Any make of plate can be cut by simply changing the under knife—an operation which takes but a moment. The cutter needs no adjustment whatever, and cannot get out of order.

Price of the Matych Plate Cutter

Matych Plate Cutter, complete with knives for the American Press Plate \$10 00
Knives for other plates, extra, each 25

When ordering, send small sample of plates used other than those of the American Press.

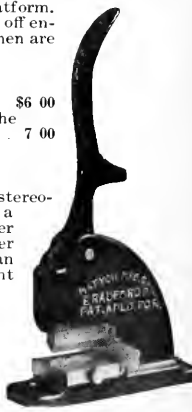

The Matych Plate Cutter



American Press Seat

The Counting Machine in the Campaign for Efficiency

The Counting Machine is an absolute necessity as a part of the equipment of every job and cylinder press in the office. It insures the delivery of a full count to the customer which every office intends and desires to give. It is possible by its use to keep a record of the output of each press per day or week, which record contains data of prime importance in figuring your costs per hour or per thousand on the press in question. It helps to keep track of the amount of waste, an important item of expense, the reduction of which makes for efficiency and profits.

American Counting Machine

This Counter is especially adapted for platen presses. It registers only when the impression is on. There is no strain on the counter or attachment and the movement is positive and easy. When once set the Counter needs no attention. Any number wheel can be set forward or backward without disturbing the others. No screws are used in the entire construction and the parts are so assembled that they cannot get out of order or become disarranged when in use.

When ordering give size and make of press.

List Prices American Counting Machines

American Counting Machine for Gordon job press, five wheel	\$12 00
American Counting Machine for Gordon Press, with lock cover (including padlock with two keys)	13 00
American Counting Machine for cylinder press, five wheel	10 00
American Counting Machine, with lock cover, with two keys	11 00
Job Press Attachment only	2 00

American Counting Machine for Colt's Armory Presses

Use the Counter without attachments by fastening counter to feed board and connecting operating lever of counter with a leather thong to the throw-off bar of the press. The Redington Counter can be attached to a Colt's Armory Press in the same manner.

The Redington Counting Machines

The Redington Counting Machine, Model A, is especially designed for cylinder presses, embossing machines, stamping machines, punch presses, or any automatic machine where a correct count is required; the arrangement of the flanges permits attaching the Counter to wall or stand. It is simple in design, made of heavy material and has large wearing surfaces, thus ensuring ease of operating life. Counts from 1 to 100,000.

The Model D Redington Counter is for Chandler & Price Gordon Presses *only*. It counts only when the impression is taken. It is easily and quickly attached to the presses named of all sizes. No drilling or removing of parts is necessary. Is secure after attaching and in plain view of operator. Guaranteed accurate at high or low speeds. Counts from 1 to 100,000. Will not jump or repeat. Easily and quickly turned back to zero, or set at any number. No key necessary. The figures are large and can be readily seen at a distance.

Dimensions and Net Prices of Redington Counting Machines

Model A—Size, 3 1/2 x 2 1/2 x 2 1/4 inches	\$5 00
Model D—Packed in a substantial box, complete	5 00

The Sheppard Counters

The Sheppard Counter is constructed to run for years. As a test of its reliability it may be noted that among its users are included many of the largest manufacturers. The Model A has two rows of wheels in a box with lock, so that it cannot be tampered with. The top row of dial wheels can be set by the pressman after each run. The lower dials are sealed and record the grand total for any period of time—day, week, month or year—and can only be opened by a key used by the person authorized to take the tally. The lower dial has seven wheels allowing a maximum permanent record, ten million impressions. This counter counts the actual impressions and can be attached to any press without drilling. It is particularly adapted for use on cylinders, to show the exact product for any period of time. The Model B Sheppard Counter has only one set of dials, is suited for job presses or cylinders and is just as durable as model A. It has a lock and key, so cannot be tampered with. Fixtures are available for adapting model B to job presses.

Prices of Sheppard Counters

Sheppard Counter, Model A, double dial	\$25 00	Sheppard Counter, Model B, in lots of twelve, each	\$9 50
Sheppard Counter, Model A, in lots of six, each	24 00	Sheppard Counter Attachments for models A and B, for Gordon, Colt's Armory or Universal Presses	1 75
Sheppard Counter, Model A, in lots of twelve, each	23 00	<i>In ordering give size of press, as attachment is different for each size.</i>	
Sheppard Counter, Model B, single dial	10 00		
Sheppard Counter, Model B, in lots of six, each	9 75		

Durant Counting Machines

The Durant Counting Machines are especially adapted for use on printing presses. They are reliable, strong, durable and attractive. They are so well and strongly made that they invariably give perfect satisfaction. They are made entirely of steel,

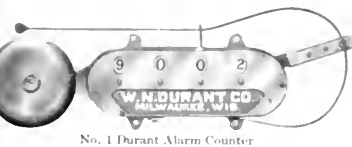

No. 1 Durant Alarm Counter



Durant Counting Machine Model B



Durant Counting Machine Model A

iron and brass, and the workmanship is of the very finest. All parts are interchangeable. The dials are of enamel and have large black figures that can readily be read at a distance. Can be quickly re-set to zero or any number. They are nicely finished, the cover, lever dials, spring, etc., being nickel plated. With each machine a bracket is furnished for convenience in securing it to the feed board of the press.

The Model B Durant Counter is intended especially for job press work. Every part that carries a strain is made of hardened steel and will permit of a constant speed of over 400 strokes per minute, without the slightest inaccuracy, breakage or appreciable wear.

List Prices of Durant Counting Machines

Durant A No. 1—4-dial, counts 10,000, each	\$ 8 50	Durant Model B Counter, each	\$10 00
Durant A No. 2—5-dial, counts 100,000, each	10 00	Durant Model B Counter, with instantaneous reset	14 00
Durant A No. 3—6-dial, counts 1,000,000, each	12 00	Durant Model B Counter, with attachment for Gordon Press	11 00
Durant No. 1 Alarm Counter, with 4-inch gong to give alarm at each 100	13 00	Durant Model B Counter, with Colt's Armory or Universal Press Attachment	13 00
Durant No. 2 Alarm Counter, with 4-inch gong to give alarm at each 100	15 00		

Boston Model Wetter Numering Machine

This Model is made of steel throughout; parts liable to wear are hardened; wheels are equipped with ciphers of improved construction and are guaranteed not to get low. Has "roughed" side plates, hold-down-screw, removable "No." slides, and can be depended on for wearing qualities and accurate work. Made in two sizes only; as regularly made all Models number forward, but can be constructed to number backward on special order, without extra charge.

No. 12356
FACSIMILE IMPRESSION

Boston Model No. 1, Five Wheels . . . \$6 00 Boston Model No. 2, Six Wheels . . . \$7 50

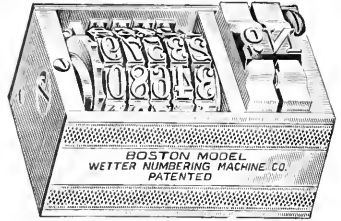

Wetter Baggage Check Numbering Machine

23-68-50

Model No. 40

This new Model was designed for numbering baggage checks and other work requiring a bold, easily read, figure. These are constructed along

68-09-23

Model No. 41

the general lines of all Wetter machines, except that dashes

38-26-50

Model No. 42

operated by a blank plunger preceding the figures. Model 40 is one and a half inches high, which necessitates cutting away the bed of the press in order to bring the face of the figures down to type-high. Models 41 and 42 are type-high. These Models are made to order only, and can be furnished with any style figure desired, or with any number of wheels; can also be made to number backward.

Prices and Models of Wetter Baggage Check Numbering Machine

Model No. 40, Six Wheels . . .	\$65 00	Without Dashes	\$50 00
Model No. 41, Six Wheels . . .	40 00	Without Dashes	30 00
Model No. 42, Six Wheels . . .	25 00	Without Dashes	18 00

One-Inch-Wide Wetter

A new machine, just one inch wide, type-high, and particularly adapted for use on flat-bed web presses that are designed for rapidly printing and numbering tickets, sales slips, coupons and other work that will not admit of using the regular form of numbering machine. Can also be used on the ordinary Gordon press.

In addition, they can be operated at a higher speed than others, are more durable, and have drop-ciphers that *will not get low*. Old users will appreciate the value of this detail of construction.

Models 232 and 233 can be operated on the ordinary job press, printing figures only, if a "frisket" is used for the plunger to print on; or the same result can be obtained when working on a cylinder press by cutting the inking rollers so the plunger will not be inked.

Model 232 Model 233
389569 **35890**
6-Wheel, \$20 00 5-Wheel, \$19 00

Or a better plan is to use a sectional form inking roller, which we recommend when working any style of numbering machine on a cylinder press. (We will furnish detail information in regard to this feature on request.) These models can be worked in rows of twelve or fourteen on a 10x15 press — for numbering tickets one inch wide — and if the run is large two rows can be used, by having the machines arranged to skip "2" so that when the work is finished the numbers will run consecutively. Or three rows can be used if the machines are arranged to skip "3." The same rule applies to four rows or to any number of rows up to ten.



This cut shows twelve machines in a row to print twelve tickets one inch wide. The special steel-locking pieces can be made any length to fit any chase, so that machines cannot fall out and do not have to be locked up sideways.

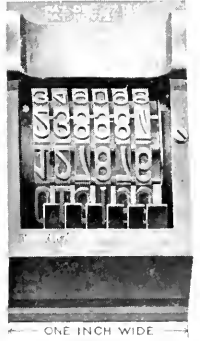

ONE INCH WIDE

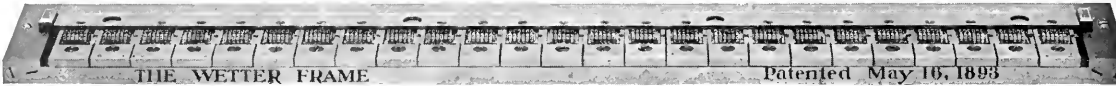

Another form of frame (twenty-nine inches long) containing twenty-five machines for special work used on a flat-bed web press

When ordering parts for Wetter machines it is necessary to give the serial number of the machine (stamped on end of frame of machine), for all machines numbered higher than thirty thousand. For machines numbered under thirty thousand, it is necessary to send sample of the broken part wanted, as it cannot be furnished from a sketch, or simply stating the serial number of the machine.

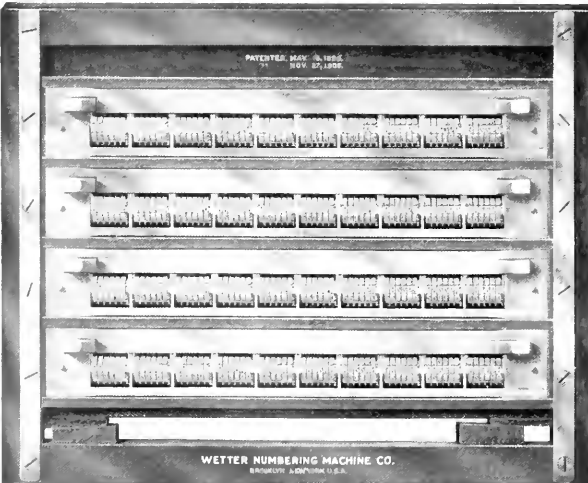

This illustration shows four Wetter frames containing forty machines (to skip "4") locked in a 10x15 chase, ready for printing.

Wetter Special Numbering Machine Frames

The Wetter frames are made on special order only. They are suitable for almost any character of numbering and for use on any flat-bed printing press. They are specially designed for using one or more numbering machines at one time, to be operated by plungers at each end of each frame.

Frames can be made of almost any length, and to properly operate almost any number of machines desired.

The frames can be adjusted to any position in the chase, and each numbering machine can be adjusted to any position in the frame that holds it. This permits of printing figures only.

If it is desired to have a character to precede or follow the figures, they can be constructed to accomplish this.

The plungers that operate the mechanism strike on the tympan *outside* of the sheet of paper being numbered. Or, if the rollers are cut, it will prevent inking the plungers, which, under certain conditions, permits of using frames, accomplishing results that otherwise would have to be attained by a double operation.

Frames can be made with a "lug" on each end, so that the "lug" could extend under the chase, providing the chase is cut out to receive it. Or, the frames can be made with "lugs" with holes in them, so that they can be screwed to the bed of the press without the use of a chase. The price depends on the quantity ordered at one time.

The American Type Founders Company is in a position to hustle your orders for Numbering Machines both intelligently and promptly at prices which are right. It invites correspondence on this subject as well as on all other printing trade matter.

Mammoth Wetter

These machines are used for all purposes where large type—one-quarter inch high and over—are required for numbering baggage checks, bicycle checks, or other work that requires larger figures than can be furnished with a type-high machine. These machines are made with a "blank" plunger at sale, unless otherwise ordered.

These models are all more than type-high. Bed of press must be cut out or platen adjusted, so that machine can be lowered to bring the face of figures to height of type. The plunger is of special shape, and so adapted that the machine can be worked in any position in the form.

Order by Model Number		Style of Figure	Price
210	1	1 1/2	\$53.00
196	5	1 1/2	55.00
181	6	1 1/2	60.00
211	7	1 1/2	65.00

2345

345

201	3	1 1/2	51.00
191	4	1 1/2	55.00
143	5	1 1/2	56.00
205	6	1 1/2	60.00

a small machine with figures large enough for ordinary commercial uses, and which can be depended upon for accurate work.

The Midget has an attachment for printing any one number, any number of times, without taking it from the form.

The "No." slide preceding figures can be removed without taking machine from the form.

Model 115	Model 116
32356	123687
5 Wheel, \$18.00	6 Wheel, \$20.00

The Midget Wetter

Is made entirely of steel, and is the smallest type-high numbering machine made by any manufacturer in the world for immediate delivery. Designed to meet the demand for



The Midget Wetter
Size 11-16 1/2 inches

Special Model Wetter

Designed for special work requiring spelling above or below the figures; made only with large figures, 5-16 inch high, or larger. The height of the machine is determined by the style of figures selected—necessarily higher than type, necessitating cutting out the bed of the press in order to bring the faces of the figures to type-high.

Can be made with the ciphers to depress so that one or more figures print as desired; thus (1) or (99999), each number printed being enclosed within sliding parentheses.

Or, they can be constructed without depressible ciphers, so that five figures would always print; the parentheses being rigidly fixed at each end of the line of figures, thus when printing 1 it would appear (00001), or, when three figures are being printed the impression would appear (000999); or, when five figures are printed, thus (99999); the parentheses always remaining in one position.

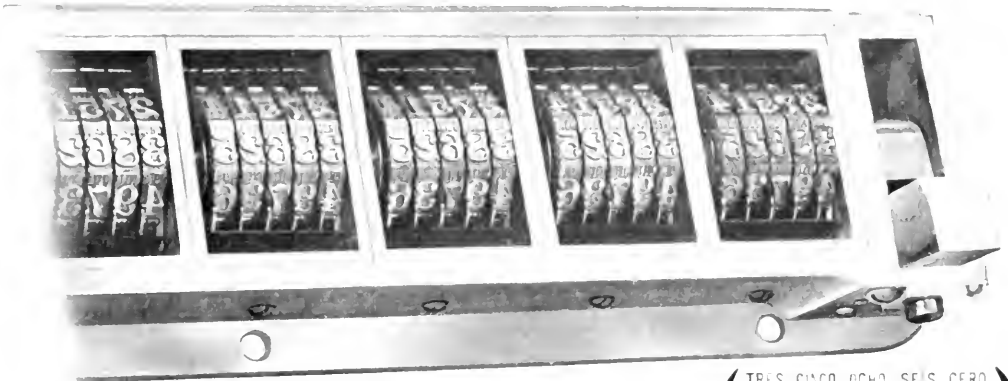

This illustration shows a section of a frame containing ten 5-wheel machines, which was designed to work on a 14x20 inch Gordon Press, and shows model 57 figures, with Spanish spelling above each figure.

This model can be made in gangs—say ten machines in one frame, operated by plungers at each end of the frame—for use on the regular platen or flat bed perfecting presses; or, can be made for special designed fast running rotary web presses. Can be made to number either forward or backward; but a machine constructed to number forward will not number backward. Can be made with or without parentheses to enclose the figures. Parentheses can be either rigidly fixed at each end of the line of figures, or made so that they slide, enclosing either one, two, three, four or five figures thus: (1), (11), (111), (1111), (11111).

The machines can be made to skip numbers, to print one number fifty times or one hundred times, and many other combinations. State your needs, and a machine can be made to meet your requirements.

The nature of the work for which these machines are used oftentimes requires five (5) of these figures to be printed in a small space, and in very many instances they are printed in a row of ten, each set of figures close together. In order to accomplish this the machines must be made in a frame to hold the ten machines, and with the operating plungers (one at each end of the frame) that print on the "tympans" outside of the sheet of paper being printed.

As the conditions and the style of press on which the machines are worked are so varied, it is necessary when making inquiries in regard to this special machine to give particulars; that is, the style of press on which the machine is to be worked; the size of the bed of the press; the exact size of the full size sheet of paper, and a pencil diagram showing the different sections on which the numbers are to be placed; and the exact location of each number on each of these spaces.

Also the way in which the rollers cross the form, whether parallel with the line of figures or at right angles to the line of figures; and also state the "gripper" edge of the sheet.

If worked on a platen press, state whether the top of the figures are to be worked to the "guides" or to the top of the chase.

This model is also made for use on special designed fast running curved bed rotary presses.

The machines are operated by shaft connecting all (no plunger being necessary) and the lever and cam roll can be made to suit the press mechanism.

If the proper specifications accompany the inquiry, information can be furnished promptly. As the style of figures vary, we show herewith some of the regular styles that can be furnished promptly.

(35860)
THREE FIVE EIGHT SIX CIPHER
Model 25 Figures.

(TRES CINCO OCHO SEIS CERO)
(35860)

Model 57 Figures

(THREE FIVE EIGHT SIX CIPHER)
(35860)

Model 58 Figures

Wetter Type-High Numbering Machines

The Standard Model

Can be locked in the form, the same as type, by itself, or surrounded by type to number and print at one impression, as all the figures can be properly inked; and is the only machine that can be successfully used on either a cylinder or job press.

Each impression of the press automatically changes the numbers. The Wetter is operated by plunger containing the word "No." to precede the figure. This "No." slide is removable without taking the form from the press, and any other character, such as "A," "B," asterisk, or a small black star ★, etc., can be inserted in its place in a moment.

With each machine we furnish a "blank" slide to use in place of the word "No." when working the machine on a job press, and when it is more desirable to have only the figures print by using a "fris- ket."

Some of the Standard Models. Order by Model Number

Model	Number of Wheels	Style of Figures	Price
237	3	No 12356	\$ 8 00
186	4		9 00
125	5		10 00
126	6		12 00
127	7		16 00
188	3	No 12345	8 00
182	4		9 00
130	5		10 00
131	6		12 00
132	7		16 00
242	3	No 12356	10 00
187	4		12 00
147	5		14 00
148	6		16 00
149	7		18 00
239	4	12345	22 50
138	5		25 00
139	6		28 00
140	7		32 00
191	3	12345	24 00
144	4		25 50
145	5		27 00
146	6		30 00
241	7	33 00	
82	3	183974	16 00
83	4		16 00
84	5		19 00
85	6		19 00
86	3	12369	27 00
244	4		27 00
156	5		30 00
157	6	30 00	
73	3	123683	27 00
74	4		27 00
75	5		30 00
76	6		30 00
171	2	1 to 50 and repeat	10 00
172	2	50 to 1 and repeat	10 00
		No 23	
173	3	1 to 100 and repeat	13 00
174	3	100 to 1 and repeat	13 00
263	2	1 to 00 and repeat	12 00
264	2	00 to 1 and repeat	12 00

All models listed above are type-high.

Skipping Wheels (to skip any one number only from two to nine), each	2 00
Letter Slides to take place of the "No." Slide (one letter), each	50
Letter Wheels, each	1 50

The Better Wetter (Plungerless)

For use with or without type on printing presses. It is the only typographic numberer that prints nothing but the figures, without "No." a period, or any other prefix or suffix intended to act as a plunger or to prevent the printed sheet from being smeared by the revolving figures.

The pressure of the platen or cylinder on the figures operates the mechanism, which changes the numbers, and also brings into action ingenious bearers which rise automatically and hold the printed sheet off the figures while they are changing. These bearers do not print on or indent the paper.

The Better Wetter is made of the best materials throughout, and all parts are hardened where necessary, insuring great durability, perfect accuracy, and long life.

Order by Model Number

Model	Number of Wheels	Style of Figures	Length Inches	Price	Model	Number of Wheels	Style of Figures	Length Inches	Price
386	4	123568	1 3/4	\$19 00	387	4	35890	1 3/4	\$19 50
325	5		1 3/4	20 00	347	5		1 3/4	21 00
326	6		1 3/4	23 00	348	6		1 3/4	24 00
327	7		2 1/4	26 00	349	7		2 1/4	27 00
382	4	67890	1 3/4	19 00	446	3	12345	1 3/4	19 00
330	5		1 3/4	20 00	447	4		1 3/4	20 00
331	6		2 1/4	23 00	365	5		2 1/4	22 00
332	7		2 3/4	26 00	366	6		2 3/4	25 00

All machines on this list are type-high and are one and one thirty-second inches wide, the length varying according to style of figure selected.



Wetter Model 125 Actual size 1 1/2 x 1 1/2 inches; consecutively numbers from 1 up to 99999. Prints figures like this impression

No 12356
FACSIMILE IMPRESSION

Model 125-5 Wheel, List price \$10 00

THE SIDE-PLATES, ARE

"roughed" or "knurled" in place of being smooth, highly polished or "damaskened," which prevents the machine from "hiding-up" or falling out of the form. Doesn't have to be "locked up" so tightly.

The DROP-CIPHER is of new construction, and is the only one that can be guaranteed not to get low, even under very hard usage—the life of a machine depends on this detail of construction.

A DISTINCT ADVANTAGE. Each machine is equipped with a "hold-down" screw for rigidly holding the plunger inoperative, so that any number may be printed a definite number of times.

THE PLUNGER is lower than others, permitting work on any cylinder press, and it is not necessary to remove the plunger at any time. Plunger is so arranged that the "No." slide can be removed without taking the machine from the form, and a letter or character of any kind inserted to precede the figures.

THE SHAFT can be easily removed when making changes from consecutive to skipping. Not necessary to remove plunger to do this.

ENGRAVING. The wheels are made of hard steel; the faces of all figures are perfectly flat, and the figures are cut deep, insuring a clear impression. THE WETTER is constructed of the best materials; parts are hardened where necessary; workmanship is the best possible to produce.

THE CIPHERS on all models can be depressed so that the first impression would appear thus: No. 1, the figures and ciphers coming to the plane of print automatically when required. Or, if it is desired to print ciphers to precede the number being printed, do not depress the ciphers, and the first impression will appear thus: No. 00001.

All models have a drop-cipher on wheel next to plunger—the only machine having this feature.

As regularly made, all models number forward, advancing consecutively from one (1) up. The five-wheel machines are entirely automatic. The six-wheel machines are automatic for five wheels only, and the sixth wheel must be turned by hand as required.

Machines that number backward do not automatically depress the drop-cipher; they must be depressed by hand.

Any model can be made, on special order, at an extra charge, to duplicate, triplicate, quadruplicate, sextuplicate, etc.

Machines can also be made to print each number a certain number of times, that is, print each number ten times, twenty times, thirty times, etc., and then advance to the next higher number.

The combinations that can be made with special designed machines are so varied that it is oftentimes possible to combine twenty or thirty combinations in one machine by simply changing ratchets that are furnished with each machine.

If your wants are fully stated a machine can be furnished to meet your requirements. For numbering checks with stubs, any number to a page, "skipping" unit wheels are necessary; these are interchangeable with the consecutive unit wheels furnished with each machine, and can be adjusted to machine by any printer. We will send a little pamphlet telling all about them on request. Any Model Wetter Numbering Machine can be made on special order to number backward at same list price as regular models that number forward.

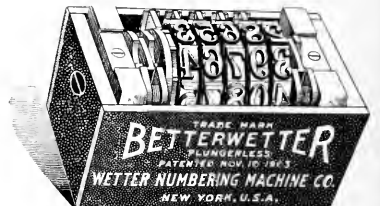

The Better Wetter (Plungerless)

Special Numbering Machines

Designed for fast-running presses with curved bed, for rapidly numbering tickets, sales slip, coupons and other work that will not admit of using the regular form of numbering machine. One or more are operated by one shaft connecting all, are made to order with or without drop-ciphers, and to number either forward or backward. These Special Machines can be constructed to make any combinations desired; to duplicate, triplicate or skip numbers, print each number any number of times; to print up to almost any given number and repeat, etc.

When writing explain fully what you are called upon to produce, give combination of numbering, size of full size sheet; the size of each section of sheet to be numbered, and the exact position where numbers are to be printed on each section; also give name of press on which they are to be used, and if for special designed presses, we should have a blue print or sketch, with dimensions, showing where the numbering head can be placed and what connection to operate them.

American Numbering Machines

The American Numbering Machine No. 30 is a new model, designed to be locked in a form, the same as type, either with or without type matter. Machines of this character are used with entire success on both cylinder and platen presses. The printing face of the figures is exactly type-high and as the impact of the press takes place the plunger is depressed and the succeeding number is brought into printing position, ready for inking. It is made entirely of steel, including the cases. The plungers are made of bar steel and constructed in one piece. All machines are fitted with steel wheels and are engraved with figures as shown in illustration.

Drop-ciphers are constructed of tool steel and are guaranteed. All parts are quickly released and machines are easily re-assembled in one-half minute. Skipping unit wheels are furnished, skipping automatically any number desired from one to ten, interchangeable with regular consecutive unit wheels. Model No. 30 is 1 1/2 inch in length by 7/8 inch in width and numbers forward. Price, American Model No. 30, five wheels, \$5.00. American Model No. 31, six wheels, \$6.00.



Model 60

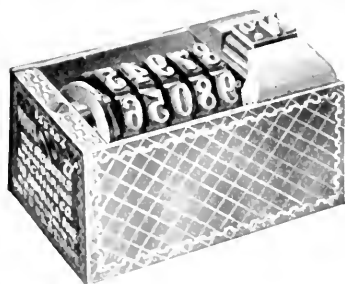

Roberts Numbering Machine Model 27 A

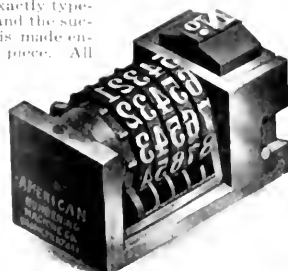

American Numbering Machine

Roberts Numbering Machines

The Roberts New Model No. 27A Numbering Machine is generally used by printers for ordinary job work. It is constructed to be used with any press made to print from type, and meets the requirements of any ordinary printing establishment perfectly. It is type-high and is locked in the chase with the form like a small cut. It can be used separately or wholly surrounded with type matter. As an impression is made, the impact of the platen of the press acts in consecutive order from 1 to 99,999. Machines are

No. 12345
Impression of Figures

actuates the prefix-slide "No." and a figure disc is advanced automatically in consecutive order from 1 to 99,999. Machines are also furnished which number backwards, so as to avoid turning the sheets. For numbering checks, orders, strip tickets, etc., "skipping" wheels are necessary. These skip automatically any number from 1 to 10 and are interchangeable with regular consecutive unit wheels. The No. 27A Numbering Machine is operated by a steel spring of great power and unusual elasticity, insuring correct numbering without the necessity of constantly watching the sheets. The machine may be taken apart in an instant for cleansing and is as quickly re-assembled. Price, Roberts Numbering machine No. 27A, \$10.00. Model No. 28A, six wheels, \$12.00.

Bates Hand Numbering Machines

The Bates Hand Numbering Machines represent the result of many years' experience in the manufacture of numbering machines. They will number consecutively, will duplicate each number before passing to the next, or will repeat the same number as often as may be desired. These three different movements are attained by simply moving the pointer on the dial. This operation takes but a moment, and does not soil the hands. Any color of ink may be used and the pad recharged or a new one substituted very quickly. When the machine is not in use the figures rest on the ink pad, and are therefore always ready to make a perfect impression at once. The machine automatically inks itself after each impression.

All the printing is done from solid steel type. The impressions are as true as those from a die. As there are no ratchet wheels between the figure dies, there is no lost or irregular spacing between the figures. The symmetrical printing of the Bates stamp with the perfect alignment are salient features.

The Bates seven movement machine has the same frame and style as the three movement, except for the dial and the additional movement necessary in a seven movement machine. It numbers consecutive, duplicate, triplicate, quadruplicate, sextuplicate, twelve times and repeats.



Bates Hand Numbering Machine



Atlas Hand Numbering Machine

Prices of Bates Hand Numbering Machines

4 wheels, numbering to 9,999	\$12 00	Seven movement, 4 wheels	\$12 00
5 wheels, numbering to 99,999	14 00	Seven movement, 5 wheels	14 00
6 wheels, numbering to 999,999	16 00	Seven movement, 6 wheels	16 00
7 wheels, numbering to 9,999,999	18 00	Seven movement, 7 wheels	18 00

Prices and information on other makes will be given on application.

Price List of Numbering Machine Inks and Pads

Bates Ink, No. 0, 1/4 ounce	\$0 20	Bates Ink, No. 1, 1/2 ounce	\$0 25
Bates Ink, No. 2, 1 ounce	40	Bates Ink in 1/2-ounce cans, any color	1 60
Bates Pads, each			10

Atlas Hand Numbering Machine

The Atlas Hand Numbering Machine is made in one style only. It is self inking, automatic in its action, and the dial changes to consecutive, duplicate and repeating. All the working parts are of steel with bronze wheels. Price, Atlas Hand Numbering Machine, with 6 wheels, \$3 50.



Roberts Hand Numbering Machine, Model 49A

Roberts Hand Numbering Machines

The "regular" Model 49A is a six wheel machine with style H figures, and is usually sent, unless otherwise ordered. Each machine is mechanically perfect before it leaves the factory, and is as accurate in all its working parts as a watch. A smaller figure, style A, can be furnished in six wheels, or a larger figure, style G, in five wheels.

Prices of Roberts Hand Numbering Machines

Model 49A, Style H, with 6 wheels	\$5 00
The machine with Style H figures can be furnished to order to number consecutive, triplicate and repeat, or consecutive, quadruplicate and repeat. Price	6 00
Model 49A, Style G, with 5 wheels	5 00
Model 49A, Style A, with 6 wheels	5 00

Numbering Machine Ink

The American Type Founders' Company handles a complete line of the best Numbering Machine Ink on the market. Our extended experience in selling inks for numbering machines has given us an advantage in being able to recommend the right inks. Write for prices on larger quantities than quoted below.



Color, Size and Price of Numbering Machine Inks

Blue, Red and Black Ink, 1/4 oz. bottle	\$0 20
Blue, Red and Black Ink, 1/2 oz. bottle	25
Blue, Red and Black Ink, 1 oz. bottle	40
Blue, Red and Black Ink, 8 oz. cans	1 60
Felt Pads (without boxes) for above	10

Rouse Universal Block System

The Rouse Universal Block System is a very simple and quick scheme for mounting plates. The blocks have many advantages, the principal one being the great speed which is made possible in make-up; various sizes of pages have been actually assembled

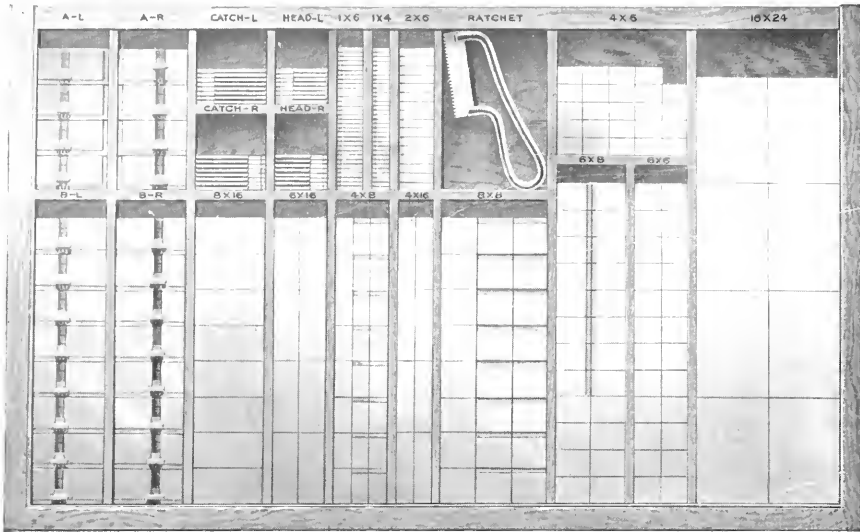

Universal Block in Case With Sliding Cover Removed.

ready to lock up in from fifteen to fifty seconds, or at the rate of sixteen pages in from five to twenty minutes. The Universal Block permits the work to be done on the stone, or on the press in running. One can clamp or release plates by this system at least three times as fast as on a grooved bed. It is adapted for fine register or ordinary black work. The hooks and catches can be placed where desired, as they are in separate units. Each set or font is complete in itself, so there is no occasion for sorting up.

The Universal Hooks are extremely rapid, yet capable of fine adjustment for register work. They are simple and very strong in construction. The jaw is operated by a ratchet for clamping or releasing plates. The catches are of brass and cannot possibly work up on the press. A margin is

allowed of three-eighths of an inch between plates. The bases are of iron. Point system. With a single set or font, eight pages can be made up into one hundred and sixty different sizes, ranging from seventeen by twenty-five up to and including thirty-five by

fifty-one ems pica and a less number of larger pages into an endless variety of shapes and sizes, all with a variation of two picas in width or length, or in both width and length.

The up-to-date printer should always be familiar with all the latest ideas in patent blocks.



Universal Hook AL

The American Type Foundry Company handles the very best and most extensive lines on the market, and at all times is prepared to demonstrate their value. The printer who desires to economize time and money and to place his business on a well



Universal Hook AR

paying basis, should from the very outset acquire the proper facilities for conducting his business on the most economical basis. The Rouse Universal Block System is one of the very best schemes known for mounting plates, in fact it goes a great way towards solving the block system. The method embraces a wide range of sizes, sufficient to meet all eventualities and always effects a great saving in making ready.

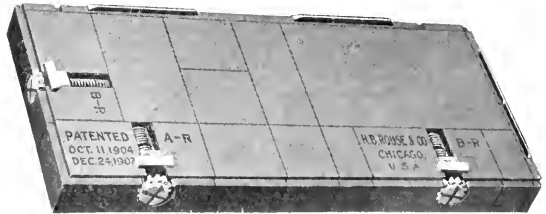

Universal Block, 25x55 ems. 35 seconds from case to page

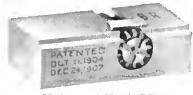

Universal Hook BR

Prices of Rouse Universal Block System

Price per set including steel ratchet and dust-proof case . . . \$55 00 Universal Register Hook, 8x16 ems \$1 00

Climax Register Hooks

A perfect plate mounting and registering system must possess certain essential features, such as an unyielding and perfectly even base; absolute control of the plates; speed in clamping and releasing plates; rapidity and exactness in make-up; narrow margins; rigid support for the entire plate; strength and durability without unnecessary weight and ability to make up forms on the stone or press. To secure the perfectly even base, cast iron has been used, as it is stronger and more rigid than any known alloy. A perfect register is best secured by absolute and individual control of the plate. To do this there is only one way, by means of register hooks. Speed is essential. By means of the register hooks and bases great rapidity has been attained. Narrow margins effect a saving in paper.



Climax Register Hooks arranged for Minimum Margin



Climax Hook No. 1

The Climax Register Hooks permit much narrower margins than any other way. The iron bases provide a rigid plate at all points. For strength and durability the hollow iron bases form an almost ideal base, being light and indestructible. The system of mounting plate greatly reduces the waiting time of the presses, as with register hooks and bases one can make up forms on the stone or on the press.

Rouse Bases are made of the best gray iron, accurately machined to the point system. They are light, yet strong and rigid. They are comprised in a unit system composed of eight by eight em units, each unit being occupied by either a unit base or a hook and its

justifiers. A unit may be lifted and

The body of the Climax Register Hook is made of hard drawn brass and a threaded steel bushing which can be replaced in case of wear is inserted in the rear wall. This permits a finer thread and thus a finer adjustment is insured. The jaw is made of steel the full width of the body. This prevents the jaw destroying the register. The head of the screw is let into the back of the wall and forms an effectual shield to prevent scratching or burring. The recess in the back of the jaw permits the narrow margin of eight points. The screw is of hardened steel and is keyed to the jaw, thus forming a two-piece hook, the very essence of strength and simplicity and the easiest possible hook to clean. The jaw has a movement of about sixteen points.



Climax Hook No. 2

The Climax Register Hooks are made in two sizes: No. 1, four by six ems, is especially adapted for very small plates with extremely narrow margins, such as post cards. No. 2, six by six ems, has been designed for all narrow margins.

Prices of the Climax Register Hooks

No. 1, 4x6 ems \$0 85 No. 2, 6x6 ems \$0 90

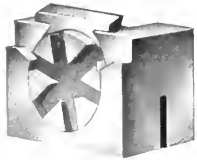

Rouse Register Hook

The Rouse Register Hooks

The Rouse Register Hook is operated with a pin only. The jaw has a movement of nearly four picas, which in addition to its unequalled speed makes this hook unexcelled for register work for which it is principally intended. Made in two sizes. Minimum margin sixteen points.

Prices of the Rouse Register Hooks

No. 0, Rouse Register Hook, 4x4 ems \$0 70 No. 1, Rouse Register Hook, 6x4 ems \$0 70

Suddard Block System.

There are certain essentials which should be embodied in every patent block, namely, ease of make-up, unlimited range of possibilities in the size and shape of plates which the block will handle, absolute accuracy and strength which mean a perfect unyielding impression, and a lock-up which can be accomplished without resorting to the use of "Dutchman" or slip of paper between the block. In order to get the form tight, the hooks should be of the right size and construction to insure ease of handling and at the same time permit them to be placed at any point of the page desired. This latter feature is found especially desirable where soldered plates are used, as the block can then be placed to hold the plate at the soldering line, thus, even though the plate cracks in the run, it will still be held down in position and will print just as well as though the plate were in one solid piece as when originally put on the press. Any practical printer will agree that the points mentioned above are important ones, and will want them incorporated in the block he desires to buy. A description of the Suddard Block System follows:

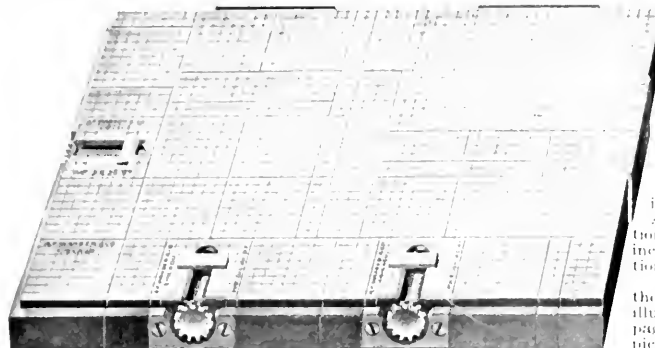

Cut No. 1. Shows page 39x56 picas outside. Three hooks and three brass catches to page. For book or catalogue work.

have been so selected that it is possible with this system to handle any size page from seven by eleven picas up to the full size of a single page of the block, or larger, by the addition of more sections. Around two sides of the block the sections are made with a shoulder which permits the use of a ratchet to operate when ratchet hooks are used. The shoulder which is made on these blocks will be found to save considerable time in the making up of book pages. The hooks used with the Suddard Block System are made either with a steel ratchet wheel or with a slotted wheel which is actuated by a pin wrench, a more accurate and positive method of moving the clutch—especially desirable on register work. The hooks are made eight by nine ems in size. The top surface of the hook is eight by eight ems. The one em additional is for the gutter.

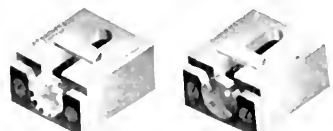

Cut No. 4. Hooks are made of iron and steel. Illustration shows one for hook work with ratchet for quick changing of plates.



Cut No. 5. This is the hook for register work, with accurate pin-actuating clutch.

With standard sets of blocks the ratchet hook is furnished. On order, however, the register hook will be supplied instead of same, without extra cost; or where both styles of hooks are needed, the extra part will be furnished so the hook can be used on either class of work at the price of twenty-five cents each. The construction of the hook is cast iron. The hooks are durable and accurate and it will be found that they will lock better in the form as they are of cast iron, same as the other sections. The principal advantages of the Suddard Block System are briefly given as follows: Make up to any size of page. Narrow margins where necessary, down to three-eighths inch. Wide bearing on clutches and hooks to prevent digging into plates. Point system, and

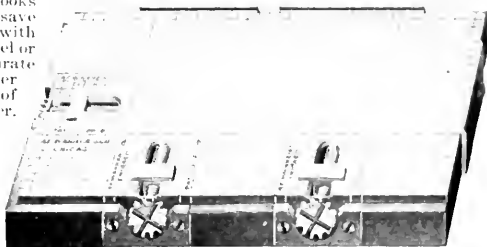

Cut No. 2. Page 25x41 picas. Made up with only nine simple pieces.

so type may be used in form. Absolutely accurate, rigid and unyielding; reduce make-ready time and hold up under heaviest forms. Quick change of plates on book work. Hair-line register on color work. Quick make-up, because of simplicity and few pieces. Hook and catches can be placed absolutely any place desired on page, a big advantage where soldered plates are used. Our patented hooks (same as we use on our other styles of blocks) cannot work loose. They stay where they are put. No grooves to injure underlays. Indestructible—because made of iron and steel. On illustrated work especially, it is admittedly advisable to mount plates on a solid, unyielding surface. No shrinking or warping occurs and thus accidents are less liable to happen than when wooden blocks are used. Sometimes in the past, where sectional blocks were used on book work, it was the custom to fill in the space with low slugs. This entailed the loss of considerable time and was unsatisfactory at best. Very often these low slugs would work up during the run, causing offsets. Occasionally they got out into the forms, smashing plates and doing considerable damage. As a time and labor saver the Suddard Block System not only avoids all these contingencies, but cuts down the time on the make-ready from one-quarter to one-half, and reduces the number of overlays and underlays necessary.

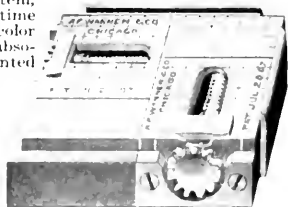

Cut No. 3. This is a real, practical, small page. Size outside, 13x17 picas.

Price List of Suddard Blocks

Equipped with patent narrow margin hooks, travels five picas, standard block height. All on the point system.

Price per set of 8 pages	\$ 55 00	Price per set of 32 pages	\$215 00
Price per set of 16 pages	109 00	Dust-proof cases to hold 8 pages, each	1 00

Each page is made up of all the parts as listed below, consisting of thirty-nine pieces to make up one Suddard Block. Blocks take plates within two ems of their size and also seven picas smaller and reduce regularly by two ems.

Each Page Contains	Price Each Piece	Each Page Contains	Price Each Piece
Three 8x9 Narrow Margin Hooks, cast iron, with gutters	\$0 90	Three 8x8 Cast Iron Sections	\$0 10 1/2
One 9x9 Cast Iron Corner Section, with gutter	13	Four 1x8 Cast Iron Sections	05 1/3
Five 8x9 Cast Iron Sections, with gutters	12	Three 2x8 Steel Sections	05
Two 4x9 Cast Iron Sections, with gutters	12	One 4x6 Cast Iron Section	08
Two 2x9 Steel Sections, with gutters	06	One 2x6 Steel Section	05
One 16x21 Cast Iron Section	50	One 1x8 Side Slug Steel	02 1/2
Three 8x16 Cast Iron Sections	20	Three 1x12 Brass Catches	15
Two 4x16 Cast Iron Sections	10	Two 2x1 Steel Sections	01 1/4
Two 2x16 Steel Sections	09		

Individual parts may be ordered extra at the above prices.

One ratchet supplied with each set, of either eight, sixteen or thirty-two pages. Three hooks and three brass catches figured to each page. All nine-em pieces are grooved with gutter for ratchet. The ratchet wheel may be changed to pin-actuated wheel for register work without extra charge, when desired, or sold extra at twenty-five cents each. Largest block thirty-nine by fifty-five picas outside, largest plate thirty-seven by fifty-two picas outside. Smallest block thirteen by seventeen picas outside, smallest plate seven by eleven picas outside. Thirty-nine by fifty-five picas is the largest block of which eight, sixteen or thirty-two pages may be made with regular sets. Any size of page may be made by additional pieces, or a smaller number of large pages can be made. For example, with a set of thirty-two blocks, sixteen pages can be made up to fifty-five by seventy-eight picas.

For further information regarding Patent Blocks write for Catalogue.

Steel Keys for Register Hooks

These Register Hook Keys are highly polished, each four inches long, one end to actuate Register Hooks the other for lifting sections.

Register Hook Keys, each, \$0 20 Two-inch single end flat keys, each \$0 05



Steel Key for Register Hook

Wilson Adjustable Patent Blocks

In the Wilson Adjustable Patent Block an effort has been made to meet the varied requirements of the printer, that is, to supply a block to take practically every size page, and all classes of work, and to do all this quicker and better than with existing appliances. The Wilson block is made up of pieces, some of which are complete blocks in themselves, others are extensions used in the making up of complete blocks in the various standard or odd sizes desired. The pieces are arranged in sets or fonts, suggested by extensive experience. These sets are in two styles, "A" and "B." These two styles combined are generally used. Standard sets are made up in four, eight, sixteen or thirty-two of such pages, and are placed in special cabinets made to hold and protect them from loss or damage. The range of sizes possible with the Wilson Adjustable Patent Block is very large, running from two and one-half by three and one-eighth to thirteen and three-eighths by sixteen inches. With set "A" forty different sizes may be obtained, and with sets "A" and "B" combined eighty-two. All pieces are made with a view to having the least possible weight; they weigh one-third that of type, and from twenty-five per cent to fifty per cent less than the average solid block, thus insuring light forms, and at the same time good rigid impressions. The hooks are patented, narrow margin ones, very quick to operate, and made from steel. They will not break under severe strain, cannot work up in the form, and give the smallest possible margin. All parts of the Wilson Blocks are finished to micrometer measurements, the standard used being the point system, so type may be used in the same form if desired. All parts are interchangeable, and absolutely the same in height. These are the only blocks made with interchangeable ends and side catches, so that they will fit on the key-block or extensions as required. The arrangement of the blocks is so simple that the make-up in the composing room is reduced to a minimum. Any job office will find these blocks of exceptional value, as they are adapted for all kinds of job work where electrotype plates are used. They save the cost of mounting, as well as in many other ways, and cost less per inch than any iron or steel blocks on the market.

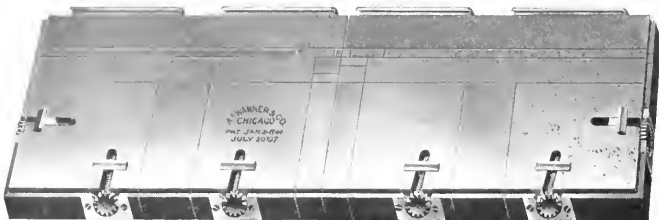

Showing a long narrow page made with Wilson Blocks

solid block, thus insuring light forms, and at the same time good rigid impressions. The hooks are patented, narrow margin ones, very quick to operate, and made from steel. They will not break under severe strain, cannot work up in the form, and give the smallest possible margin. All parts of the Wilson Blocks are finished to micrometer measurements, the standard used being the point system, so type may be used in the same form if desired. All parts are interchangeable, and absolutely the same in height. These are the only blocks made with interchangeable ends and side catches, so that they will fit on the key-block or extensions as required. The arrangement of the blocks is so simple that the make-up in the composing room is reduced to a minimum. Any job office will find these blocks of exceptional value, as they are adapted for all kinds of job work where electrotype plates are used. They save the cost of mounting, as well as in many other ways, and cost less per inch than any iron or steel blocks on the market.

The Wilson Patent Solid Iron Blocks

The Wilson Patent Solid Iron Blocks are made to take the standard book sizes without the use of extensions. They are supplied with patented narrow margin steel hooks, have extension brass catches, and are made as light as is consistent with strength. Extensions may be used with them when desired, making it possible to obtain practically any size page desired. Iron blocks are furnished with two side and one end hooks, except the three large sizes. These are supplied with three side and two end hooks. All the hooks have patented narrow margin steel clutches. The price is no more than that of the old style stereotype blocks, while the possibilities and value of the new style far exceeds the old.

Prices of Wilson Patent and Iron Blocks

Owing to the great diversity in sizes and parts of the Wilson Patent Adjustable and Iron Blocks we are unable to give the price list in full. If however you will kindly state your requirements, we shall be pleased to send you full details with prices. There is nothing required of blocks of this nature which cannot be covered by the Wilson Patent Adjustable Blocks in some one of the various combinations of which they are capable.



Wilson Solid Block with Adjustable Brass Catches

Rouse Unit System Bases

In the Unit system the entire form is made up of 8x8 em units, each unit of space being occupied by a unit base or a hook with its justifiers. The Rouse Unit System Bases are made of cast iron and are accurately machined to the point system. They are as light as is consistent with the work desired of them and are practically indestructible. In presenting an even, unbroken and unyielding surface to the plate, they greatly reduce the time required for make-ready as well as increase the life of the plates. Rouse Unit Base, 8x8 ems.

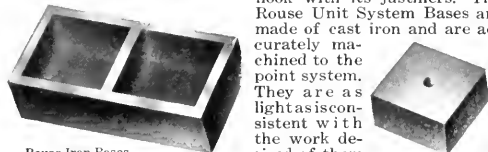

Rouse Iron Bases

and are practically indestructible. In presenting an even, unbroken and unyielding surface to the plate, they greatly reduce the time required for make-ready as well as increase the life of the plates. Rouse Unit Base, 8x8 ems.

List price \$0 20

Challenge Cast Iron Sectional Blocks

These Blocks are made in a greater variety of sizes than the steel ones. They are as light as consistent with strength and are thoroughly braced and ribbed. Being finished on the point system, and to micrometer measurements, they will work perfectly on the same form with steel and metal sections.

24x32 ems, each	\$1 50	6x16 ems, each	\$0 30
16x32 ems, each	1 00	6x 8 ems, each	18
16x24 ems, each	85	6x 6 ems, each	15
16x16 ems, each	60	4x24 ems, each	40
8x32 ems, each	80	4x16 ems, each	25
8x24 ems, each	60	4x 8 ems, each	15
8x16 ems, each	35	4x 6 ems, each	10
8x 8 ems, each	20	4x 4 ems, each	10
6x24 ems, each	40		

Prices quoted on Sectional Blocks are subject to liberal discounts.

Challenge Metal Sectional Blocks

Metal Sectional Blocks are made from extra hard metal, cored on their under side to lighten them. They are sufficiently heavy for the finest impressions of halftone or heavy tint plate. Being made on the point system, they are accurate and reliable at a low price. They hold the plates securely, save considerable time in the make-ready and are as easy to make as metal furniture. With proper care they will last indefinitely.

Sizes 16x16, 8x16, 8x8, 4x8, 2x8, 2x6, 2x4, 1x8, 1x6 and 1x4 ems. Per pound \$0 25
Mahogany sections, 8 ems square, each 10

Challenge Steel Sectional Blocks

Steel blocks combine in the highest degree accuracy, rigidity, strength, durability, lightness and convenience. They are micro-ground, without grooves, and thus form a faultless base. Their value in ease of assembling, their general adaptability and the saving of time effected by their use in make-ready, cause them to be indispensable in the modern printing office. They are constructed on the point system, and they are in every way qualified to fill any of the requirements of the printing office where blocks of such a nature are necessary.

8x8 ems, each, \$0 18 2x8 ems, each, \$0 09 2x6 ems, each, \$0 08

Wesol Brass Sectional Blocks

On Small Plates

For very fine adjustments these Brass Blocks are used. They are made of solid brass, micro-ground.

1x16 ems, each	\$0 09	1x6 ems, each	\$0 05
1/2x16 ems, each	07	1/2x6 ems, each	04
1x 8 ems, each	07	1x4 ems, each	03
1/2x 8 ems, each	05	1/2x4 ems, each	02

Rabbeted Bases

For Use with Combination Register Hooks

Seven em Rabbeted Bases are to be used in connection with Combination Register Hooks. Their use makes it unnecessary to use low slugs or reglets, the rabbet forming a channel or gutter for the ratchet to run in. These bases also do away with justifiers and greatly facilitate the rapid making-up of pages with the Combination Hook.

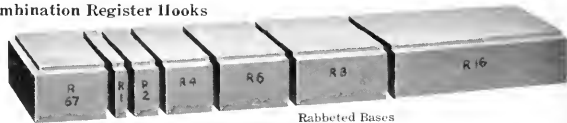

Rabbeted Bases

No.	Size	Rabbeted	Price
No. R 1	1x7 ems	1 end	\$0 05
No. R 2	2x7 ems	1 end	06
No. R 4	4x7 ems	1 end	09
No. R 6	6x7 ems	1 end	10
No. R 67	6x7 ems	1 end and 1 side	11
No. R 8	8x7 ems	1 side	11
No. R 16	16x7 ems	1 side	22

Mills Two-Heights Iron Newspaper Bases

(Patent pending)

The Two-in-One Base—These bases have the extraordinary merit of holding either sixteen-gauge zinc or eleven-point electros or type set type height in one position they accommodate sixteen-gauge zinc but when reversed accommodate eleven-point electros. In using all other kinds of newspaper bases two fonts are required to do the work of one font of the Mills Two-Heights Bases. An investment of only \$18.00 in two-heights bases is almost equal in service to an investment of \$3.00 in ordinary iron bases. Mills Two-Heights Bases are sold at the same list prices as the ordinary one-height newspaper bases, although almost one hundred per cent better value.

We say "almost" one hundred per cent better value, because the twelve-point and six-point justifiers are not reversible, and a small separate supply of these for each height (sixteen-gauge zinc and eleven-point electros) are included in each font. Catch Bases, which are not included in fonts, and are not reversible, are sold per piece. These cases are solid iron and superior to cored bases, because a matrix is dried quicker on solid bases for reasons obvious to every expert stereotypist.

The economy of using labor-saving iron bases in preference to cast-to-order



Two-Height Base—Actual Size—Type Case

MILLS' TWO-HEIGHTS IRON NEWSPAPER BASES

ADJUSTED FOR BOTH 16-GAUGE ZINC AND 11-POINT ELECTROTYPES

Two-Heights Bases, with Justifiers and Catch Bases, made up to hold a cut of irregular shape

stereotype bases is indisputable. In addition, the convenience and avoidance of errors, and the greater accuracy and fewer number of sizes in fonts, are qualities in themselves decisively in favor of the Mills Two-Heights Bases. Mills Two-Heights Bases can be made to order to accommodate other thicknesses of zinc and electros or stereotypes, at special prices.

Fonts G, H, K, L, M and N are assorted for those who require one height only.

List Prices of Mills Two-Heights Iron Bases

Fonts do not include catch bases or half column bases, which are sold by the piece. Single column is any width not exceeding fourteen pica ems; half column is any width not exceeding seven pica ems. In ordering, it is necessary to state widths of columns and column rules.

The smallest font fills one column of the standard size eight-column newspaper, and this length of column is the unit in larger fonts, enabling the purchaser to ascertain exactly which font or how many fonts will meet his requirements.

Unit Fonts for Two Heights

These fonts are assorted for columns of the standard eight-column newspaper, twenty-four inches by thirteen picas. All unit fonts for two heights contain twenty-eight pieces of two-heights bases (Fig. A), and twelve each six and twelve point justifiers for sixteen-gauge zinc height and twelve each six and twelve point justifiers for eleven-point electros height—seventy-six pieces in all. The areas given are based on zinc height.

UNIT ONE-COLUMN FONT A—76 1-col. pieces, assorted (as above), covering 52 square inches \$12 00

UNIT TWO-COLUMN FONT B—76 2-col. pieces, assorted (as above), covering 106 square inches 20 00

UNIT THREE-COLUMN FONT C—76 3-col. pieces, assorted (as above), covering 160 square inches \$29 20

UNIT FOUR-COLUMN FONT D—76 4-col. pieces, assorted (as above), covering 214 square inches 37 20

Combination Two-Heights Fonts

COMBINATION FONT E—438 pieces, covering 432 square inches or the area of one page of standard size 8-column newspaper \$88 60

Contains the following two-heights bases (Fig. A): 1 column, 112; 2-column, 28; 3-column, 18; and the following six and twelve point justifiers: 1-column, 96 each; 2-column,

24 each; 3-column, 20 each (half for zinc and half for electros).

COMBINATION FONT F—219 pieces, covering 216 square inches or the area of a half-page of standard size 8-column newspaper \$41 30

Contains half the number of pieces in Font E.

Unit Fonts for One Height

In ordering, it is necessary to state whether these fonts are required for sixteen-gauge zinc or eleven-point electros. The bases are two heights, and these fonts differ from two-heights fonts in having justifiers for one height only. By adding justifiers for another height these fonts may at any time be made completely available for holding both sixteen-gauge zinc or eleven-point electros.

All unit fonts for one height contain twenty-eight pieces of two-heights bases (Fig. A), and twelve each six and twelve point justifiers for either sixteen-gauge zinc or eleven-point electros, as ordered. The areas are based on zinc height.

UNIT ONE-COLUMN FONT G—52 1-col. pieces, assorted (as above), covering 32 square inches \$10 20

UNIT TWO-COLUMN FONT H—52 2-col. pieces, assorted (as above), covering 64 square inches 17 00

UNIT THREE-COLUMN FONT K—52 3-col. pieces, assorted (as above), covering 96 square inches \$21 40

UNIT FOUR-COLUMN FONT L—52 4-col. pieces, assorted (as above), covering 128 square inches 31 20

Combination One-Height Fonts

In ordering it is necessary to state whether these fonts are required for sixteen-gauge zinc or eleven-point electros. COMBINATION FONT M—298 pieces, covering 432 square inches or the area of one page of standard size 8-column newspaper \$74 40

Contains the following two-heights bases (Fig. A): 1-column, 112; 2-column, 28; 3-column, 18; and the following

six and twelve point justifiers: 1-column, 48 each; 2-column, 12 each; 3-column, 10 each.

COMBINATION FONT N—119 pieces, covering 216 square inches or the area of a half-page of standard size 8-column newspaper (half of font M) \$37 20

Prices of Two-Heights Bases, per Piece

Each (Fig. A)—1/2-column, 15 cents; 1-column, 30 cents; 2-column, 50 cents; 3-column, 70 cents; 4-column, 90 cents.

Prices of Catch Bases

As illustrated in Figures B and C. In ordering, state whether for sixteen-gauge zinc or eleven-point electros. Each (Figs. B or C)—1/2-column, 25 cents; 1-column, 50 cents; 2-column, 90 cents; 3-column, \$1.25; 4-column, \$1.50.

Justifiers

In ordering, state whether for sixteen-gauge zinc or eleven-point electros. Six Point, each—1/2-column, 3 cents; 1-column, 5 cents; 2-column, 10 cents; 3-column, 15 cents; 4-column, 20 cents. Twelve Point, each—1/2-column, 5 cents; 1-column, 10 cents; 2-column, 15 cents; 3-column, 25 cents; 4-column, 30 cents.

Cast Iron Furniture

Cast Iron Furniture is especially designed to take the place of wood or metal furniture. It is made exceptionally light in weight, but is so well braced that it will stand the greatest lock-up strain without being affected in any way. One of the latest improvements

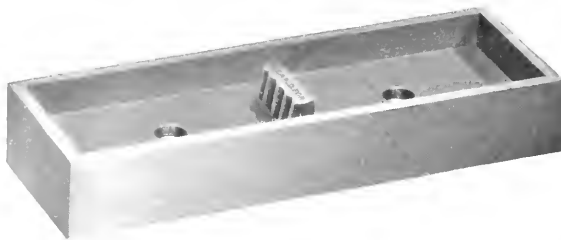

To Cast Iron Furniture is the addition of a corrugated projection in the center of each piece. This projection practically performs all the purposes of a handle, as it is cast as a part of each piece, three by ten ems or larger, and is easily grasped by the thumb and forefinger. It assists materially in the manipulation of the furniture and adds just that perfection of detail which this style of furniture demanded. It dispenses entirely with the necessity of using a knife blade or bodkin between the pieces to raise them and avoids the danger of more or less damaging ad-projection enables one to readily lift a



jacent pieces when one of them is used as a fulcrum. The corrugated piece from a form, thus avoiding damage and saving time and money by the operation.

This Cast Iron Furniture is guaranteed to be on the point system both ways. It possesses point system exactness. The corrugated projection facilitates handling, saves the furniture and economizes time. It is forty per cent lighter than regular furniture and many times stronger. Being harder than type metal it will hold its accuracy longer and is therefore more economical in use. With ordinary care in handling it will last indefinitely. It is not easily dented or affected by heat. It makes lighter forms. It is in accordance with the line of modern improvement, which calls for iron imposing surfaces, iron stereo tables, iron composing stands and fire resisting qualities. The corrugated projection entails no additional expense.

List Prices of Cast Iron Furniture and Dimensions and Number of Pieces in each Font

Font A, 392 pieces. List price	\$32 00	Font D2, 508 pieces. List price	\$38 00
Font A contains twelve pieces each of 3x5, 4x5, 5x5, 3x6, 4x6, 5x6, 6x6, 3x8, 4x8, 5x8, 6x8, 8x8, 3x10, 4x10, 5x10, 6x10, 8x10, 10x10, 3x15, 4x15, 5x15, 6x15, 8x15, 10x15, 3x20, 4x20; eight each of 5x20, 6x20, 8x20, 10x20, 3x25, 4x25, 5x25, 6x25, 8x25 10x25 ems.		Font D3, 254 pieces. List price	19 00
Font A1, 1,016 pieces. List price	\$74 00	Font D4, 127 pieces. List price	9 50
Font A1 contains thirty-two pieces each of 2x4, 3x4, 4x4; twenty-four each of 2x5, 3x5, 4x5, 5x5, 2x6, 3x6, 4x6, 5x6, 6x6, 2x8, 3x8, 4x8, 5x8, 6x8, 8x8, 2x10, 3x10, 4x10, 5x10, 6x10, 8x10, 10x10, 2x15, 3x15, 4x15, 5x15, 6x15, 8x15, 10x15; sixteen each of 2x20, 3x20, 4x20, 5x20, 6x20, 8x20, 10x20, 2x25, 3x25, 4x25, 5x25, 6x25, 8x25 and 10x25 ems.		Font E, 588 pieces. List price	\$31 00
Font A2, 508 pieces. List price	\$37 00	Font E contains thirty-six pieces each of 2x4, 3x4, 4x4, 2x5, 3x5, 4x5, 2x6, 3x6, 4x6; twenty-eight each of 2x8, 3x8, 4x8, 2x12, 3x12, 4x12; sixteen each of 2x16, 3x16, 4x16, 2x20, 3x20, 4x20 ems.	
Font A3, 254 pieces. List price	18 50	Font E1, 1,272 pieces. List price	\$72 00
Font A4, 127 pieces. List price	9 25	Font E1 contains seventy-two pieces each of 2x4, 3x4, 4x4, 2x5, 3x5, 4x5, 2x6, 3x6, 4x6; fifty-six each of 2x8, 3x8, 4x8, 2x12, 3x12, 4x12; thirty-two each of 2x16, 3x16, 4x16, 2x20, 3x20, 4x20, 2x24, 3x24 and 4x24 ems.	
Font B, 488 pieces. List price	\$37 00	Font E2, 636 pieces. List price	\$36 00
Font B contains twelve pieces each of 2x4, 2x5, 3x5, 4x5, 5x5, 2x6, 3x6, 4x6, 5x6, 6x6, 2x8, 3x8, 4x8, 5x8, 6x8, 8x8, 2x10, 3x10, 4x10, 5x10, 6x10, 8x10, 10x10, 2x15, 3x15, 4x15, 5x15, 6x15, 8x15, 10x15, 2x20, 3x20, 4x20, 2x25; eight each of 5x20, 6x20, 8x20, 10x20, 3x25, 4x25, 5x25, 6x25, 8x25 and 10x25 ems.		Font E3, 318 pieces. List price	18 00
Font B1 (drops the 2-em widths of A1) 832 pieces. Price	\$64 00	Font E4, 159 pieces. List price	9 00
Font B2, 416 pieces. List price	32 00		
Font B3, 208 pieces. List price	16 00		
Font B4, 104 pieces. List price	8 00		
Font C, 288 pieces. List price	\$32 00		
Font C contains sixteen pieces each of 3x15, 4x15, 5x15, 6x15, 8x15, 10x15, 3x20, 4x20, 5x20, 6x20, 8x20, 10x20, 3x25, 4x25, 5x25, 6x25, 8x25 and 10x25 ems.			
Font C1, 1,380 pieces. List price	\$68 00		
Font C1 contains eighty-four pieces each of 2x4, 3x4, 4x4, seventy-two each of 2x5, 3x5, 4x5, sixty each of 2x6, 3x6, 4x6, 5x6, 6x6; forty-eight each of 2x8, 3x8, 4x8, 5x8, 6x8, 8x8; thirty-six each of 2x10, 3x10, 4x10, 5x10, 6x10, 8x10 10x10 ems.			
Font C2, 690 pieces. List price	\$34 00		
Font C3, 345 pieces. List price	17 00		
Font C4, 172 pieces. List price	8 50		
Font D, 336 pieces. List price	\$36 00		
Font D contains sixteen pieces each of 2x15, 3x15, 4x15, 5x15, 6x15, 8x15, 10x15, 2x20, 3x20, 4x20, 5x20, 6x20, 8x20, 10x20, 2x25, 3x25, 4x25, 5x25, 6x25, 8x25 and 10x25 ems.			
Font D1, 1,016 pieces, quotation sizes. List price	\$76 00		
Font D1 contains thirty-two pieces each of 2x4, 3x4, 4x4; twenty-four each of 2x5, 3x5, 4x5, 5x5, 2x6, 3x6, 4x6, 5x6, 6x6, 2x8, 3x8, 4x8, 5x8, 6x8, 8x8, 2x12, 3x12, 4x12, 5x12, 6x12, 8x12, 10x12, 2x16, 3x16, 4x16, 5x16, 6x16, 8x16, 10x16; sixteen each of 2x20, 3x20, 4x20, 5x20, 6x20, 8x20, 10x20, 2x24, 3x24, 4x24, 5x24, 6x24, 8x24 and 10x24 ems.			

The two-line furniture in all fonts is made of drawn steel. For additional information regarding fonts and prices write for circular.

Sort Prices per 100 Pieces. Smaller Quantities at Same Rate

Size	Price	Size	Price	Size	Price	Size	Price
2x4	\$ 3 00	3x20	\$16 00	5x12	\$ 8 00	8x8	\$ 6 25
2x5	3 50	3x25	19 00	5x15	9 00	8x10	8 00
2x6	4 00	3x40	21 00	5x16	9 50	8x12	8 50
2x8	4 75	3x45	24 00	5x20	11 00	8x15	10 00
2x10	5 00	3x50	26 50	5x24	13 50	8x16	10 50
2x12	6 00	3x60	31 50	5x25	13 50	8x20	12 50
2x15	7 00	3x70	36 50	5x30	17 50	8x24	14 75
2x16	7 00	4x4	4 00	5x35	20 00	8x25	14 75
2x20	9 00	4x5	4 25	5x40	22 50	8x30	19 00
2x24	10 00	4x6	4 75	5x45	25 00	8x35	21 50
2x25	10 00	4x8	5 00	5x50	27 50	8x40	24 00
2x30	14 00	4x10	6 00	5x60	32 50	8x45	26 50
2x35	16 00	4x12	7 00	5x70	37 50	8x50	29 00
2x40	18 00	4x15	8 00	6x6	5 50	8x60	34 00
2x45	20 50	4x16	9 00	6x8	6 00	8x70	39 00
2x50	23 00	4x20	10 75	6x10	7 00	10x10	9 00
2x60	28 00	4x24	13 00	6x12	8 00	10x12	10 00
2x70	35 00	4x25	13 00	6x15	9 00	10x15	11 25
3x4	3 00	4x30	17 00	6x16	10 00	10x16	12 00
3x5	4 00	4x35	19 50	6x20	11 50	10x20	13 50
3x6	4 25	4x40	22 00	6x24	13 75	10x24	15 75
3x8	5 00	4x45	24 50	6x25	13 75	10x25	15 75
3x10	6 00	4x50	27 00	6x30	18 00	10x30	20 00
3x12	7 00	4x60	32 00	6x35	20 50	10x35	22 00
3x15	7 00	4x70	37 00	6x40	23 00	10x40	25 00
3x16	8 00	5x5	4 50	6x45	25 50	10x45	27 50
3x20	10 00	5x6	5 00	6x50	28 00	10x50	30 00
3x24	12 00	5x8	6 00	6x60	33 00	10x60	35 00
3x25	12 00	5x10	6 75	6x70	38 00	10x70	40 00

Special sizes for heads and gutters made to order.

Challenge Mammoth Iron Furniture



Challenge Mammoth Iron Furniture

Challenge Mammoth Iron Furniture is made on point system in seventeen mammoth sizes, ranging from twenty-five by fifty to fifty by one hundred ems pica. Special sizes made to order. This furniture is a great convenience in dressing out a large chase when locking up a small or open form, or in locking a small chase on the press bed. In addition, the cutting down of the number of pieces used in locking provides an efficient remedy for "work-up." Mammoth Iron Furniture is sold in fonts or by the piece as may best suit the customer. The prices for labor-saving fonts will be promptly furnished upon request.

List Prices of Mammoth Iron Furniture Sorts

Size	Price	Size	Price	Size	Price
25x50	each \$0 75	30x80	each \$1 10	40x90	each \$1 30
25x60	each 85	40x50	each 90	50x60	each 1 10
25x70	each 95	40x60	each 1 00	50x70	each 1 20
30x50	each 80	40x70	each 1 10	50x80	each 1 30
30x60	each 90	40x80	each 1 20	50x90	each 1 40
30x70	each 1 00			50x100	each 1 50

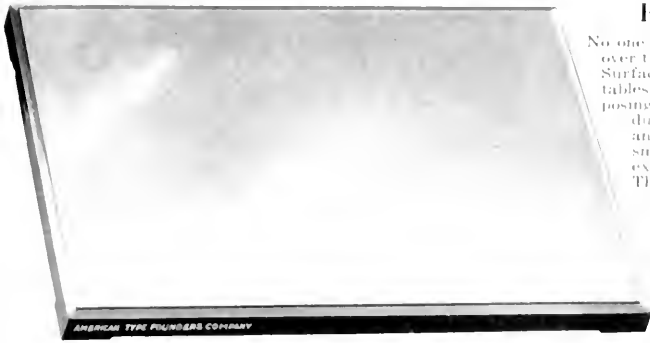

Top side of Radio-Iron Imposing Surface, showing wide beveled rabbet

Radio-Iron Imposing Surfaces

No one questions the superiority of iron imposing tops over the marble slabs, and in the Radio-Iron Imposing Surfaces printers are offered the very best working tables yet produced. The materials in Radio-Iron Imposing Surfaces are of special compound, which produces a hard, tough casting which will never chip, and when finished leaves the surface perfectly smooth. Radio-Iron Imposing Surfaces are made extra heavy, averaging forty pounds a square foot. The top side of Radio-Iron Imposing Surfaces is as accurate as the bed of a cylinder press. A three-quarter inch rabbet is cut around the outer edge of the surface to give the galley a firm hold. The rabbet is cut extra deep, which allows for spring in old galleys, and a slight bevel downward assists in handling forms quickly.

The bottom side of Radio-Iron Imposing Surfaces has more than the usual number of ribs, which are made extra heavy. These ribs, and the large solid corners and rests on cross-stays, insure a permanently level surface.

Radio-Iron Imposing Surfaces are practically indestructible and are a permanent investment. The saving of time in composing or press-room, over ordinary marble stones, more than pays for the surfaces in a short time.

When iron surfaces are ordered to replace marble slabs, or to fit imposing stone frames originally made for marble slabs the new iron surfaces must be made approximately three inches larger each way, (over all measure), to cover the space formerly occupied by the collar holding the marble slab.

Extra heavy square-leg tables are made for Radio-Iron Imposing Surfaces. Unless otherwise specified these tables are furnished for the standard size surfaces listed herewith.

When special size iron tops are required a practical estimate of the cost may be derived by figuring the entire surface at three cents per square inch. Radio-Iron surfaces weigh, when crated, about forty pounds to the square foot. Printers contemplating substituting iron top imposing surfaces in place of the marble tops are solicited to correspond with the American Type Founders Company regarding special sizes, prices, etc. We are in a position to supply you with all necessary information and no doubt will be able to offer some economical suggestion regarding Iron Imposing Surfaces, as well as regarding other matters pertaining to the craft in which you may be interested.



Bottom side of Radio-Iron Imposing Surface, showing extra heavy ribs and large corner rests

List Prices and Dimensions of Radio-Iron Surfaces

No.	Surface Capacity	Size of Iron Surface	Weight of Frame Pounds	Prices of Iron Surface	Prices of Frames	
					K. D. Unfinished	Set up and Finished
60 ¹ / ₂	2 pages, 6 column	24x36	130	\$ 25 92	\$10 50	\$12 00
61 ¹ / ₂	2 pages, 7 column	26x44	110	31 32	11 00	12 50
62 ¹ / ₂	2 pages, 8 column	28x50	160	42 00	11 50	13 00
63 ¹ / ₂	For Job work	36x48	190	51 84	12 00	13 50
64 ¹ / ₂	2 pages, 9 column	32x60	200	57 60	13 50	15 25
65 ¹ / ₂	4 pages, 7 column	26x76	200	59 28	15 50	17 25
66 ¹ / ₂	4 pages, 8 column	28x80	270	67 20	17 50	19 25
67 ¹ / ₂	4 pages, 9 column	30x90	290	81 00	18 75	20 50
68 ¹ / ₂	4 pages, 6 col. qo.	36x60	200	64 80	15 00	16 75
69 ¹ / ₂	1 page, 7 col. qo.	48x60	225	86 40	19 50	21 50
70 ¹ / ₂	For misc. work.	48x72	250	103 68	21 00	26 50

These Tables are smaller than regular Imposing Stone Tables for marble stones.

Radio-Iron Surfaces in any size can be figured on basis of three cents a square inch. Figure weight of Radio-Iron Surface at forty pounds a square foot, crated.

*Varnished and with an antique finish, similar to regular printing-office furniture.

Slauson Cylinder Press Locks

The Slauson Cylinder Press Locks are used for locking chases to the bed of the cylinder presses. These locks are much quicker and safer than wood furniture as they are adjustable and can be made to fit any required size within a very few seconds. They are manufactured from flat drawn steel tubes, which telescope one into another. They are then locked by an ordinary Hempel key. The quoin, which is in the form of a coil (or snail) has an extension of two picas and is absolutely safe. The parts are drop steel forgings. The locks are very quick in action and hold a form solid to the bed, taking out the spring of a chase and preventing the material from working up inside. The locks are used with the press clamps first closed; small or quoin end being always placed against the chase whether outside or inside. They are then pulled out until they fill the space, which they will do within one-eighth of an inch. They are made in five sizes.

Prices and Dimensions of Slauson Cylinder Press Locks

Slauson Cylinder Press Lock, 3 inches opening to 5 inches, per pair	\$4 50
Slauson Cylinder Press Lock, 5 inches opening to 8 inches, per pair	4 50
Slauson Cylinder Press Lock, 8 inches opening to 15 inches, per pair	5 50
Slauson Cylinder Press Lock, 14 inches opening to 26 inches, per pair	\$6 50
Slauson Cylinder Press Lock, 22 inches opening to 36 inches, per pair	8 00
Case for Set	50

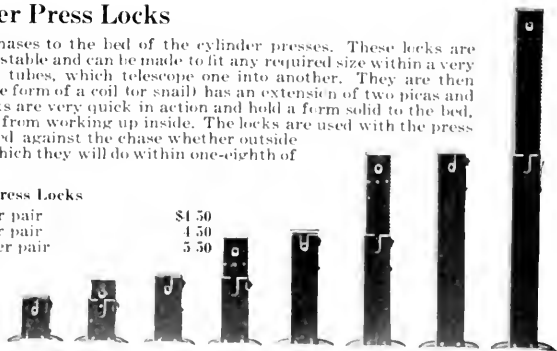

Hercules Steel Rule Cutter

The Hercules Steel Rule Cutter is an extra heavy, powerful machine, designed for use on steel cutting, engraving and scoring rule. It will cut six point tempered steel rule and heavy brass rule and slugs with great ease and leave no burr edges. It is especially adapted for the use of paper box makers, label printers, paper novelty manufacturers and all who cut tempered steel rule or heavy brass rule and slugs. The knives are made of the best grade of steel, hardened by a special process, and seldom require sharpening. They are set into a slot which exactly fits them, so that no adjustment is necessary. They can be taken off and replaced quickly. The front gauge will allow a cut of six and a half inches and the back gauge, which is twenty-five inches in length, is graduated to picas and half-picas. The entire machine is so constructed as to give the highest satisfaction and the longest possible service.

Price, Hercules Steel Rule Cutter, complete

\$18 00

All-Brass Galleys

Extra heavy rims, bottom of standard thickness and absolutely flat. The American Type Founders Company's All-Brass Galleys are the strongest and most serviceable manufactured. The rim of each galley is made of extra heavy brass with an extra lip at the top and bottom. This not only acts as a reinforcement, but enables the printer to get a more secure grip on the galley as he lifts it from the case or stone. The corners are exceptionally strong and true as they are securely interlocked. This method of interlocking the corners increases the life of the galley to over double that of any other galley. In an All-Brass Galley the corner construction is the most important point to investigate, as it is there that most of the lock-up strain comes. The bottoms are subjected to a special straightening process, which insures the nearest approach to a perfect flatness. The rivets which

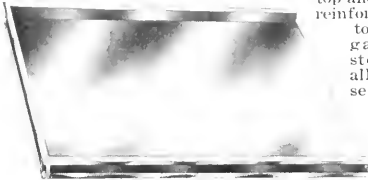

All-Brass Job Galley

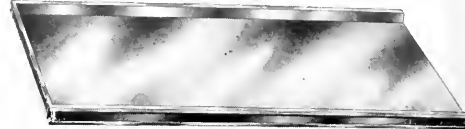

Double Column All-Brass Galley

hold the sides and ends securely to the bottom are of extra hard brass, extend clear through the sides and bottom of the galley, the holes are deeply countersunk and the rivets headed over top and bottom. Our method of interlocking the corners and strongly riveting the sides and bottoms has brought our All-Brass Galley to a point of perfection where it is acknowledged to be the standard of quality and construction.

Printers will be quick to see the advantages of these All-Brass Galleys, and to appreciate the fact the American Type Founders Company carries a complete line of them. These galleys are conscientiously recommended as giving the greatest value for the prices paid and as being of the highest class.

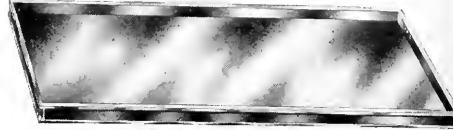

All-Brass Mailing Galley

List Prices and Dimensions of All-Brass Galleys

Size Galley							Size Galley						
Inside	Columns	10 or less	11 to 49	50 to 99	100 to 199	200 and over	Inside	Columns	10 or less	11 to 49	50 to 99	100 to 199	200 and over
3 ³ / ₄ x 23 ³ / ₄	Single	\$2 50	\$2 40	\$2 30	\$2 20	\$2 10	19 ¹ / ₂ x 23 ³ / ₄	Eight	\$7 00	\$6 90	\$6 80	\$6 70	\$6 60
3 ³ / ₄ x 15 ³ / ₄	Single	2 00	1 90	1 80	1 70	1 60	6 x 10	Job Size	2 00	1 90	1 80	1 70	1 60
3 ³ / ₄ x 11 ³ / ₄	Single	1 75	1 65	1 55	1 45	1 35	8 ³ / ₄ x 13	Job Size	2 50	2 40	2 30	2 20	2 10
5 x 23 ³ / ₄	Medium	2 75	2 65	2 55	2 45	2 35	9 x 14	Job Size	2 75	2 65	2 55	2 45	2 35
6 ¹ / ₄ x 23 ³ / ₄	Double	3 00	2 90	2 80	2 70	2 60	10 x 16	Job Size	3 25	3 15	3 05	2 95	2 85
6 ¹ / ₄ x 15 ³ / ₄	Double	2 50	2 40	2 30	2 20	2 10	12 x 18	Job Size	4 00	3 90	3 80	3 70	3 60
6 ¹ / ₄ x 11 ³ / ₄	Double	2 25	2 15	2 05	1 95	1 85	14 x 21	Job Size	4 75	4 65	4 55	4 45	4 35
8 ¹ / ₂ x 23 ³ / ₄	Triple	3 50	3 40	3 30	3 20	3 10	15 x 22	Job Size	5 25	5 15	5 05	4 95	4 85
10 ¹ / ₂ x 23 ³ / ₄	Four	4 25	4 15	4 05	3 95	3 85	18 x 25	Job Size	7 00	6 90	6 80	6 70	6 60
12 ³ / ₄ x 23 ³ / ₄	Five	5 00	4 90	4 80	4 70	4 60	Size Inside						
13 x 23 ³ / ₄	Extra	5 00	4 90	4 80	4 70	4 60	1 ¹ / ₂ x 30	Mailing	3 00	2 90	2 80	2 70	2 60
15 x 23 ³ / ₄	Six	5 50	5 40	5 30	5 20	5 10	6 ¹ / ₄ x 23 ¹ / ₂	Mailing	3 50	3 40	3 30	3 20	3 10
17 x 23 ³ / ₄	Extra	6 25	6 15	6 05	5 95	5 85	7 ¹ / ₄ x 23 ¹ / ₂	Mailing, Bruce	3 75	3 65	3 55	3 45	3 35
17 ¹ / ₄ x 23 ³ / ₄	Seven	6 25	6 15	6 05	5 95	5 85	7 ¹ / ₄ x 23 ¹ / ₂	Mailing, Wesel	3 75	3 65	3 55	3 45	3 35
19 x 23 ³ / ₄	Extra	7 00	6 90	6 80	6 70	6 60	10 x 23 ¹ / ₂	Mailing	4 75	4 65	4 55	4 45	4 35

Special sizes made to order at proportionate prices.

American Patented (One-Piece Rim) All-Brass Galleys

This All-Brass Galley has a rim of only one piece; a continuous strip of heavy flanged brass, formed to perfectly square corners inside, and secured to the bottom by more rivets than are used by any other manufacturer, making it practically indestructible. This patented galley is made by very prominent manufacturers, and is sold under a strict guarantee that it is better and stronger than any other galley. With proper use, it will practically last forever; of rough use, such as galleys invariably get in large offices, it will stand more than any other and still retain its usefulness. Heretofore there has never been a galley which would hold fast at the corners when used around machines or for handling large, heavy pages; but this one-piece rim galley will hold fast all around under the roughest usage. The rim is flanged so that the galley with its load can be readily and safely grasped; no type load will cause yielding, and nothing short of inexcusable abuse will affect the accuracy and durability of this galley while in constant use.

All-Brass Graduated Galleys

This is claimed to be the best "graduated to picas" galley ever made. It is constructed of the best materials. The corners are secured with a steel anchor. The walls are fastened to the bottom with short, stout rivets, placed as closely to the inner face of the wall as possible. The result is the finest possible construction. The galleys are graduated to twelve points on the end and one side—a convenience which will be appreciated. If preferred, plain galleys can be supplied.

List Prices and Dimensions of All-Brass Graduated Galleys



All-Brass Graduated Galley

ALL-BRASS GALLEYS—JOB SIZES					
Size Inside		Price	Size Inside		Price
6 x 10 inches		\$2 00	12x18 inches		\$4 00
8 ³ / ₄ x 13 inches		2 50	14x21 inches		4 75
9 x 14 inches		2 75	15x22 inches		5 25
10 x 16 inches		3 25	18x25 inches		7 00
NEWSPAPER SIZES					
Columns	Size Inside	Price	Columns	Size Inside	Price
Single	3 ³ / ₄ x 23 ³ / ₄ inches	\$2 50	Triple	8 ¹ / ₄ x 23 ³ / ₄ inches	\$3 50
Single	3 ³ / ₄ x 15 ³ / ₄ inches	2 00	Four	10 ¹ / ₂ x 23 ³ / ₄ inches	4 25
Single	3 ³ / ₄ x 11 ³ / ₄ inches	1 75	Five	13 x 23 ³ / ₄ inches	5 00
Medium	5 x 23 ³ / ₄ inches	2 75	Six	15 x 23 ³ / ₄ inches	5 50
Double	6 ¹ / ₄ x 23 ³ / ₄ inches	3 00	Seven	17 x 23 ³ / ₄ inches	6 25
Double	6 ¹ / ₄ x 15 ³ / ₄ inches	2 50	Eight	19 x 23 ³ / ₄ inches	7 00
Double	6 ¹ / ₄ x 11 ³ / ₄ inches	2 25			

Mailing Galleys, Closed Ends (Double Column) 6¹/₄ x 23¹/₂ \$3 50

All-Brass Monotype Galley

This Monotype Galley is made entirely of brass. The sides are angle shaped and riveted to the bottom. The rivets have heavy heads and are countersunk into the bottom. Much thought by practical men has been devoted to the construction of this galley, with the result that it is simple, thoroughly practical and will save time and pi in any office where the Monotype is used. The end piece is made removable and the sides are milled out at both ends, so that the end piece can be set at either end, as desired. By this means the operator on the Monotype is able to shift the end of the galley, after it comes from the machine, thus avoiding the necessity of transferring the matter from one galley to another when making up. This will be appreciated by those who know the trouble caused where solid end galleys are used.

Prices of All-Brass Monotype Galleys

Single Column, 3 ³ / ₄ x 23 ³ / ₄ inches inside, each	\$2 50	Triple Column, 8 ¹ / ₄ x 23 ³ / ₄ inches inside, each	\$3 50
Single Column, 3 ³ / ₄ x 11 ³ / ₄ inches inside, each	1 75	Job Size, 6 ¹ / ₄ x 11 ¹ / ₄ inches inside, each	2 25
Double Column, 6 ¹ / ₄ x 23 ³ / ₄ inches inside, each	3 00	Job Size, 9x14 inches inside, each	2 75

Linotype Patent All-Brass Galley

The Linotype Patent All-Brass Galley is made expressly to furnish an efficient and quick method of handling Linotype slugs. It is made in two styles: Style A, where slugs are used exclusively, and Style B, where type is used in connection with the slugs.

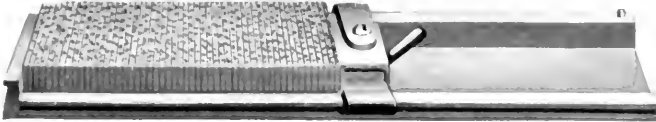

Linotype Patent All-Brass Galley

In Style A one side of the galley rims is made considerably lower than the other and the inside of the rims is tapered at the top, which allows of very rapid correction, as the slugs can be tipped endways and lifted out of the galley without interference from the sides. Style B is made with both sides of equal height and finished straight inside, thus effectually keeping the type on its feet. Both styles are locked at the bottom by a foot clamp, which slides over the rims and is tightened by pushing the lever to the left. Pins are set into the ends of the rims to keep the clamp from sliding off and being mislaid. Practically no lock-up is needed. It is strong and exceedingly compact, the complete galley being only one-half inch wider than the measure it is designed to hold. It is made of the best materials with standard bottoms. Give width of column when ordering and send sample slug and mention whether Style A or B is wanted.

Prices of Linotype Patent All-Brass Galleys

Linotype Galley, 12 inches, 15 ems or under, Style A or B, each	\$1 50
Linotype Galley, 16 inches, 15 ems or under, Style A or B, each	1 75
Linotype Galley, 24 inches, 15 ems or under, Style A or B, each	2 00
For each em in width exceeding 15 ems, add to list price	05
Extra Foot Clamp, each	75

The above prices include foot clamp.

Milholland Linotype All-Brass Galley

The Milholland Linotype Galley has a lock-up device, which is simple, strong and cannot easily be removed. The Galley is strong and well made. In ordering give exact measure of columns.

Prices of Milholland Linotype All-Brass Galleys

8 inches long, any width not exceeding 15 ems	\$2 00
12 inches long, any width not exceeding 15 ems	2 00
16 inches long, any width not exceeding 15 ems	2 50
24 inches long, any width not exceeding 15 ems	3 00
24 inches long by 25 ems wide	3 50
For each em in width, exceeding 15 ems, add to list price	05

Special sizes made to order at proportionate prices.



Milholland Linotype All-Brass Galley

Brass Lined, Half Lined and Unlined Column Galleys

Inches Inside	Columns	Brass Lined	Half Lined	Brass Bottom	Inches Inside	Columns	Brass Lined	Half Lined	Brass Bottom
3 ³ / ₄ x 23 ¹ / ₄	Single	\$2 00	\$1 75	\$1 50	10 x 16	Job Size	\$3 00	\$2 75	\$2 50
5 x 23 ³ / ₄	Medium	2 25	2 00	1 75	12 x 18	Job Size	3 75	3 50	3 00
6 ¹ / ₄ x 23 ³ / ₄	Double	2 50	2 25	2 00	14 x 21	Job Size	4 50	4 00	3 50
8 ¹ / ₂ x 23 ³ / ₄	Triple	3 25	3 00	2 75	15 x 22	Job Size	5 00	4 50	4 00
7 ¹ / ₂ x 23 ³ / ₄	Extra Double	2 75	2 50	2 25	18 x 25	Job Size	6 00	5 50	5 00
6 x 10	Job Size	1 50	1 40	1 25	1 ¹ / ₂ x 30	Mailing	1 50	1 00	75
8 ³ / ₄ x 13	Job Size	2 00	1 90	1 75	6 ¹ / ₂ x 22 ¹ / ₄	Mailing	3 00	2 75	2 50
9 x 14	Job Size	2 50	2 25	2 00	7 ¹ / ₂ x 22 ¹ / ₄	Mailing	3 25	3 00	2 75

Lincoln Patent All-Brass Galley

The Lincoln Patent All-Brass Galley is generally recognized as the standard among type-holding, self-locking galleys. It has the advantage of insuring a rapid and safe handling of movable type. It has a strongly riveted bottom of standard thickness, and the stationary side and head are strongly riveted together at the corner. The depressible rim is made of extra heavy five-sixteenths inch stock and works on pivots set into the head rim, foot and at regular intervals along the bottom. While the matter is being dumped, this depressible rim is dropped, allowing free access to the galley. When the galley is ready to prove the rim is brought up against the side of the type and fastened by a spring bolt which slips into a corresponding socket in the head rim and is held tight. All this is done very quickly. Corrections are made easily. The galley is only three-quarters of an inch wider than the inside measurement and takes up very little room. The Lincoln All-Brass Galley is made to order only.



Lincoln Patent All-Brass Galley

The foot clamp is then slipped on over both rims, pushed up against the type and tightened. The galley is only three-quarters of an inch wider than the inside measurement and takes up very little room. The Lincoln All-Brass Galley is made to order only.

Prices of Lincoln Patent All-Brass Galleys

12 inches long, any width, not exceeding 15 ems pica	\$2 00
16 inches long, any width, not exceeding 15 ems pica	2 50
24 inches long, any width, not exceeding 15 ems pica	3 00
24 inches long, by 25 ems pica wide	3 50
Extra Foot Clamps, each	50
For each additional pica em in width exceeding 15 ems, add to the list price	05

The above prices include Foot Clamp. In ordering it is necessary to give exact width of type matter for which galleys are required.

Adzit Galley Lock

This is a simple, serviceable device for locking linotype slugs or type in Plate Zinc, Steel Galleys, or galleys of similar construction. No side lock is necessary for linotype slugs; the lock holds the matter firmly on the side of the galley and is released on a simple pressure. It is well finished and made of steel.

Price for Single Column, each	\$0 15; per dozen	\$1 50
Price for Double Column, each	20; per dozen	2 00



Adzit Galley Lock

The Hill & Webb Galley Lock

The Hill & Webb Galley Lock is one of the most efficient and yet the simplest galley locks made. It is constructed of flexible steel, and owing to its unique shape, it automatically adjusts itself to widths varying from three-eighths to two inches, and in every case gives a firm and safe lock-up. Its adaptability enables it to be used with either straight or beveled side sticks.

Price of Hill & Webb Galley Lock, per dozen

\$2 00



Hill & Webb Galley Lock

Pressed Brass, Bright Steel and Galvanized Steel Galleys

The Pressed Brass Galley is made from one piece of heavy brass of standard gauge, pressed into shape with an extended rim which gives great rigidity and strength. An absolutely durable and dependable galley at a remarkably low price. It is sold at prices averaging one-third less than the regular all-brass galley. The Bright Steel and Galvanized Steel Galleys are sold at prices averaging one-third less than the regular galleys. They are made of heavy standard gauge steel, just as strong as possible. The galvanized steel galley is not smoothly finished as the steel, as the surface is galvanized to prevent rusting. It also is pressed into shape with extended rims which gives great rigidity and strength. They are durable and dependable galleys at a very low price.

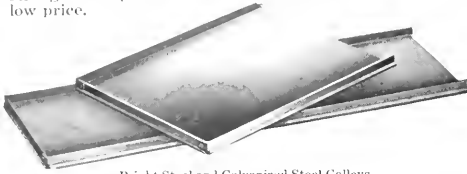

Bright Steel and Galvanized Steel Galleys

List Prices of Pressed Brass Galleys

Size Galley	Less than 100	100 or over	250 or over	500 or over
2 ³ / ₄ x 23 ³ / ₄ inches	\$1 35	\$1 25	\$1 15	\$1 05
3 ¹ / ₂ x 23 ³ / ₄ inches	1 50	1 40	1 30	1 20
6 ¹ / ₄ x 23 ³ / ₄ inches	2 00	1 90	1 80	1 70
8 ¹ / ₂ x 23 ³ / ₄ inches	2 60	2 50	2 40	2 30
6 x 10 inches	1 60	1 50	1 40	1 30
8 ³ / ₄ x 13 inches	1 90	1 80	1 70	1 60
10 x 16 inches	2 60	2 50	2 40	2 30
12 x 18 inches	3 00	2 90	2 80	2 70
MAILING				
3 ¹ / ₂ x 23 ³ / ₄ inches	1 90	1 80	1 70	1 60
6 ¹ / ₄ x 23 ³ / ₄ inches	2 40	2 30	2 20	2 10

List Prices of Pressed Steel and Galvanized Steel Galleys

Size Galley	Less than 100	100 or over	250 or over	500 or over
2 ³ / ₄ x 23 ³ / ₄ inches	\$0 40	\$0 38	\$0 36	\$0 34
3 ¹ / ₂ x 23 ³ / ₄ inches	46	44	42	40
6 ¹ / ₄ x 23 ³ / ₄ inches	48	46	44	42
8 ¹ / ₂ x 23 ³ / ₄ inches	70	68	66	64
6 x 10 inches	40	38	36	34
8 ³ / ₄ x 13 inches	46	44	42	40
10 x 16 inches	66	64	62	60
12 x 18 inches	72	70	68	66
MAILING				
2 ³ / ₄ x 23 ³ / ₄ inches	45	44	42	40
3 ¹ / ₂ x 23 ³ / ₄ inches	48	46	44	42
6 ¹ / ₄ x 23 ³ / ₄ inches	50	48	46	44
8 ¹ / ₂ x 23 ³ / ₄ inches	72	70	68	66



Steel Galleys

Automatic Galley Lock

The above are equipped with Automatic Galley Locks, absolutely positive and reliable, at a price of 10 cents each extra. Galley Locks furnished only when specified in order.

Plate Zinc Galleys

A low price galley of very superior construction is offered in the Plate Zinc Galley. Specially prepared material and the construction of machinery capable of giving the best results have overcome great difficulties. Compressed double-rolled plate zinc is used, the sides are as nearly square and true as possible. The projections on the sides are bent by machinery and soldered to the ends; this gives strength, accuracy and rigidity. The finish is equal to the higher priced galleys, the surface being smooth, even and free from defects. For storage galleys and for all purposes where a large quantity of matter is kept standing, this Plate Zinc Galley will meet all requirements.

List Prices and Dimensions of Plate Zinc Galleys

NEWSPAPER GALLEYS	Less than 100	100 to 250	250 to 500	500 or over
Single Column—3 ¹ / ₂ x 23 ³ / ₄	\$0 75	\$0 70	\$0 65	\$0 60
Single Column— ¹ / ₂ length—3 ¹ / ₂ x 11 ¹ / ₄	60	55	50	45
Double Column—6 ¹ / ₄ x 23 ³ / ₄	1 00	95	90	85
Triple Column—8 ¹ / ₂ x 23 ³ / ₄	1 30	1 25	1 20	1 15
JOB GALLEYS				
6x10 inches, inside	80	75	70	65
8 ³ / ₄ x 13 inches, inside	95	90	85	80
10x16 inches, inside	1 30	1 25	1 20	1 15
Mailing, closed ends, single col., 3 ¹ / ₂ x 22 ¹ / ₂	95	90	85	80
Mailing, closed ends, double col., 6 ¹ / ₄ x 22 ¹ / ₂	1 20	1 15	1 10	1 05

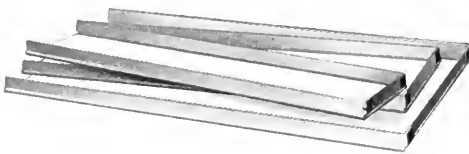

Plate Zinc Galleys

Riveted Zinc Galleys

These Zinc Galleys are designed for general use where it is wished to keep forms in galleys while taking proofs and making corrections. Double compressed plate zinc, hard and smooth, free from scales and other defects is used, thus presenting the even surface essential to proof taking. The sides and end are attached to the bottom in a manner insuring an absolutely stiff and rigid, the sides are channel shaped. These afford a substantial hold for the fingers in lifting. The galley is made in all sizes.

List Prices and Dimensions of Riveted Zinc Galleys

GALLEYS	Size	Riveted Zinc	Riveted Brass
Single Column, each	3 ¹ / ₂ x 23 ³ / ₄	\$1 10	\$2 20
Single Column, half length, each	3 ¹ / ₂ x 11 ¹ / ₄	90	1 80
Double Column, each	6 ¹ / ₄ x 23 ³ / ₄	1 40	2 80
Triple Column, each	8 ¹ / ₂ x 23 ³ / ₄	1 70	3 30
Job, each	6x10	1 10	2 10
Job, each	8 ³ / ₄ x 13	1 30	2 45
Job, each	10x16	1 60	3 25
Double Col. Mailing (with closed ends) each	6 ¹ / ₄ x 22 ¹ / ₂	1 60	3 30

Special Sizes Furnished at Proportionate Prices. Write for Liberal Discount on Quantity Orders.



Mailing Galley



Riveted Zinc Galley

Mailing Galleys

	10 Ems	13 Ems	14 Ems
McFatrieh Mailing Galley, all zinc, 30 inches long	\$0 80	66	\$1 00
Mercantile Mailing Galley, all zinc, 30 inches long	66	50	80
Mustang Mailing Galley, zinc	50		
Mustang Mailing Galley, brass bottom			\$0 75

Mercantile Addressing Machine Galleys

Mercantile Galleys are made to work with the Mercantile Addressing Machine, as shown on page 1188 of this catalogue. These Galleys are well constructed and will give excellent satisfaction. They are made by the manufacturers of the Mercantile Addressing Machine, which in itself ought to be a sufficient recommendation. The Mercantile Quoin is also intended to be used with these Galleys. The Mercantile Galley is furnished with Screw Locks unless otherwise specified. If you prefer the Quoin Lock kindly so mention in your order.



Prices of Mercantile Addressing Machine Galleys

Mercantile Addressing Galley, 10 ems, each	\$0 66	Mercantile Addressing Galley, 18 ems, each	\$0 95
Mercantile Addressing Galley, 14 ems, each	80	Mercantile Addressing Galley, 20 ems, each	1 08
Mercantile Addressing Galley, 16 ems, each	88	Mercantile Addressing Galley, 30 ems, each	1 40
Mercantile Steel Bell Slugs, per dozen: 10 ems \$0 30	14 ems \$0 40	16 ems \$0 50	18 ems \$0 55
Mercantile Quoins, per dozen	\$0 50	20 ems \$0 60	30 ems \$0 70
		Mercantile Quoin Keys, each	50

The Orro Embosser

The printer who does job work ought certainly to do embossing. If he does not his presses are not giving him full service and he is missing the profits of one of the easiest and most attractive lines of work ever brought within his reach.

It is a very simple matter to emboss on any job press, large or small, regardless of make, with the aid of the Orro Embosser. No make-ready required and no extra impression. This handy device fastens to the tympan paper and holds the die and counter die (or "force") in a sort of hinge, into which the paper or card passes naturally when the press is fed in the usual way. The device can be put on in a moment and anyone who can operate a press can do expert work with it.

In embossing with the Orro the make-ready or "force" is prepared on a powerful screw press in the factory at the time the die is made. The material of which it is composed, slightly softened by heat, is put under tremendous pressure and forced into every depression of the die. When the "force" is in use the stock to be embossed is pressed into every part of the die with equal pressure (even at the deepest points) before the flat surfaces of the die and force meet. This is the reason why perfect embossing is produced with the Orro without risk of injury to the smallest press made. Dies are interchangeable. Complete change of design can be made in one minute.

Dies of any design can be made for the Orro, not exceeding two and one-quarter inches long by one inch wide, and a special designing department is maintained to work out customers' ideas and to make drawings from their sketches, or to originate new designs as needed. This department is continually preparing designs of various subjects suitable for all-around use in general job printing, from which dies are made and carried in stock in what is known as the "Library of Orro Dies." These dies are always ready for immediate shipment and are furnished at very low prices. Complete sets of samples of the designs are at the disposal of owners of the Orro Embosser.

The Orro Embosser means more in the printing world than simply another article to be sold at a little profit; it brings in a new element which makes for quality and better work and tends to uplift printing standards.

It has hundreds of uses, among which are: Covers for booklets, catalogues and price lists, folders, announcements, circulars, notices, letter and note paper, envelopes, bill-heads, blotters, show cards, calendars, photograph-mounts, business cards, bank statements, certificates, invitations, programmes, score cards, private mailing cards, souvenirs, holiday greetings, menu cards, wine lists, ball tickets, orders of dancing, society and club printing, imitation steel die stamping and for embellishing anything made of paper or card with an embossed crest, monogram, trade mark or any sort of design. Anything can be embossed within two inches of the edge.

The embossing may be done in one color or several, with or without printing on top of color or gold. The use of the Orro Embosser means more profit on each job; getting new trade and holding your own; more new trade and greater profits.

The Orro die is two and one-quarter inches long by one inch wide.



A Complete Orro Embossing Unit

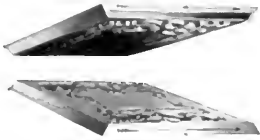

Dies fit perfectly when their arrows point in the same direction

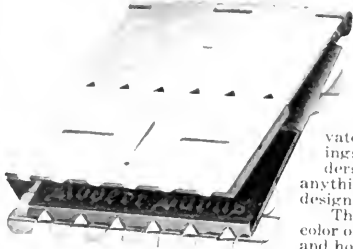

The Orro Embosser

Prices of Orro Embossers and Dies

Price, including one die and force, printing plate, template and two iron blocks, the extra block for use in a "standing" form	\$20 00
Dies, including the "force" or make-ready and a registering printing plate, each	3 50
Dies, from your own design cost according to the nature of copy submitted. Minimum	5 00
Stock Dies may be exchanged at any time upon payment of the exchange fee of	2 50

Card Cutters

For the particular printer, who desires to cut his own cards, our line of card cutters will certainly be of interest. It is the best line manufactured. The tables are made of well seasoned kiln dried cherry, stained and varnished. Some of the tables are divided into half-inch squares by lines cut into the wood, and filled with enamel. The joint prevents buckling or dragging of the paper. The rule is adjustable. The blades are made of tempered steel. These Card Cutters are essential in every printing office. Should those listed not fully meet requirements, details of others will be furnished.

THE PREMIUM—For the rapid cutting of cards and sheets the Premium is especially adapted. A sheet of any length can be cut and slipped along without leaving the guide rule.
12-inch blade. Price \$10 00

THE POPULAR—The ruled table is a leading feature of the Popular. It provides a cutting guide at any point on the board. This trimmer is large enough for all ordinary studio work.

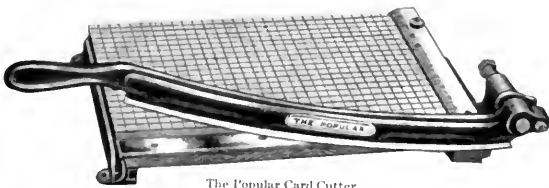

The Popular Card Cutter

15-inch blade. Price \$7 25

THE STUDIO—This is as perfect a little machine as the most improved methods can produce, and is adapted for the use of the amateur and semi-professional photographer.



The Studio Card Cutter

10-inch blade. Price \$3 00

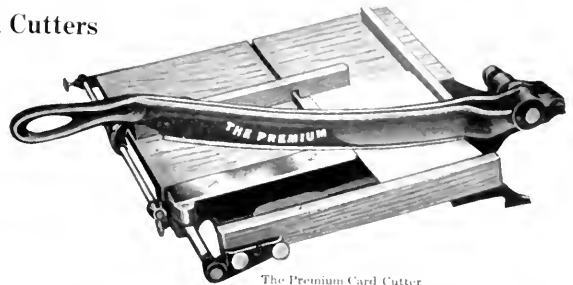

The Premium Card Cutter

THE MANUFACTURER'S—The highest attainment in cutters for heavy work in print shops or studios. Has adjustable gauge and automatic binder, which holds the work in place.

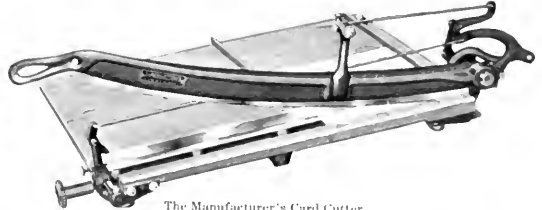

The Manufacturer's Card Cutter

21-inch blade. Price \$30 00

THE NATIONAL—This is the latest product in the line of Trimmers and has an eighteen-inch blade thus meeting every requirement of the professional studio. It has adjustable joint and the table is ruled in half-inch squares.



The National Card Cutter

18-inch blade. Price \$10 00

Improved Hempel Quoins

The Hempel Quoins have been tested by time and approved by those who use them. The latest improved design fulfils every requirement.

List Prices of Improved Hempel Quoins

No. 1, small, per dozen	\$2 50
No. 2, large, per dozen	3 00
Keys for either size, each	50

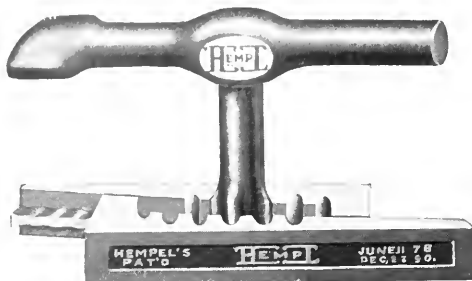

Improved Hempel Quoin

The Monarch Quoins

The New Monarch Quoin retains all the desirable features of other quoins with the added advantage of a self-locking device, consisting of a small spring inserted through the thick end. The purpose of this spring is, when the quoin is in position to force the center rib of one part against the teeth in the end of the other half and thus securely lock the quoin and prevent its slipping. It is simple, but effective, ensuring permanent lockup when it is essential.



The Monarch Quoin

List Prices of Monarch Quoins

No. 1, small, per dozen	\$2 50	No. 2, large, per dozen	\$3 00
-------------------------	--------	-------------------------	--------

Challenge Hempel Quoins

These have rounded ends, so do not scratch or injure the imposing stone or press bed. The beveled heels and points enable one to place two quoins wherever one will go. The Challenge Hempel Quoin Keys are made of the best cast steel, accurately cut, durable and satisfactory.



Challenge Hempel Quoins

Prices of Challenge Hempel Quoins

No. 1, small, per dozen	\$ 1 00
No. 1, small, per gross	10 00
No. 2, large, per dozen	1 50
No. 2, large, per gross	15 00
Keys for either size, plain (Style C) each	50
Keys for either size, nickel plated (Style C) each	75

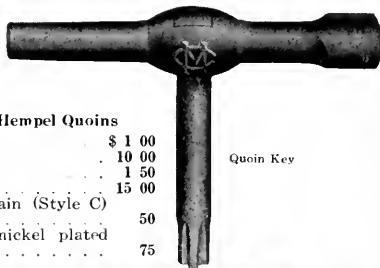

Quoin Key

Favorite Quoins

The Favorite Quoins have been very popular for many years. They have always been regarded as the best on the market and deservedly so.

Prices of Favorite Quoins

No. 1 size, per dozen	\$ 1 00
No. 1 size, per gross	10 00
No. 2 size, per dozen	1 50
No. 2 size, per gross	15 00



Favorite Quoin

Register Quoins

Where perfect register is desired these Register Quoins are intended for use in forms of mounted plates. The quoins are placed on all four sides of each page, as illustrated, so that any page may be moved independently in any desired direction without interfering with the other pages. The quoins permit of very narrow margins. They are made in two sizes: In No. 1 margins can be regulated from sixteen to twenty-four points. In No. 2 the margin adjustment is from thirty-six to forty-eight points.

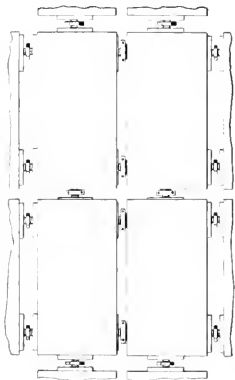

Register Quoins in Use.

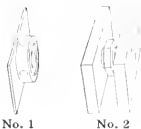

No. 1

No. 2

No. 1, per dozen	\$2 00
No. 2, per dozen	2 00
Key for either style	20

Wickersham Quoins

The Wickersham Quoin is a very handy device for locking up forms with cramped margins, or where there is not sufficient room for quoins of the Hempel pattern. The Wickersham has a direct spread and will not slip or slide and "squeeze" pages. It is especially excellent for locking up patent blocks or electrotyped pages, whether made up in small or large forms. In printing this catalogue there have been many occasions when it would have been next to impossible to "lock-up" some of the forms, especially those requiring a very close register, without the Wickersham Quoins. The No. 1 is five-eighths inch wide; the No. 2 is three-quarters inch wide; expanding fourteen points.



Wickersham Quoin and Key

Wickersham Quoins, Nos. 1 or 2, per dozen	\$2 50
Wickersham Regular Key, each	50

The Wickersham Key fits all Wickersham Quoins, all Morton Lock-ups and all Stephens Expansion Locks.

New Star Adjustable Lock-Up

This device registers mounted plates with precision and the greatest accuracy in a few minutes without disturbing other matter in the form. In color or book printing, where absolute certainty and exactness of register is of the utmost importance, the use of this appliance assures accuracy without the possibility of failure. It consists of a rigid and accurately machined metallic corner piece, in which are mounted two adjusting screws, one at each side of the angle. These are designed to perform the same function for mounted plates that is accomplished by the well-known register hooks in use with "patent" blocks. Four corners comprise one set, and it requires one set to register a color plate.

Price, per set of four corner hooks, complete \$4 00

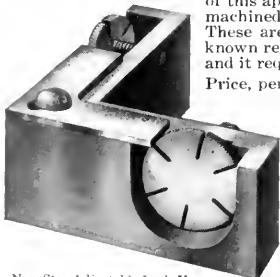

New Star Adjustable Lock-Up

Midget Safety Quoins

The Midget Safety Quoin is quickly locked by a tap of the mallet. It occupies no more space in length when locked than when open. It can be used in a space 18 points wide by 120 points long, either inside or outside of form. It is absolutely safe, as when locked it rests against its corresponding flat surface, and the harder the surface it bears against the better.

Price, Midget Safety Quoin, per doz., with key	\$2 00
Extra Keys for Midget Quoins, each	25



Midget Safety Quoin

Right Angle Pressman's Quoin Key

The Right Angle Pressman's Quoin Keys fit Hempel Quoins of any make. They are made of tool steel, each tooth being cut and not drop forged. They are especially constructed for locking or unlocking a form under the cylinder without taking the chase from the bed of the press. The lever is long, giving ample power and a long reach.



Right Angle Pressman's Quoin Key

Prices of Right Angle Pressman's Quoin Keys

Right Angle Pressman's Quoin Key, plain, No. 1 and No. 2, each, \$0.75
Right Angle Pressman's Quoin Key, nicked, No. 1 and No. 2, each, .90

Pressman's Combination Quoin Key

The Pressman's Combination Quoin Key is made of tool steel, seven and one-half inches long. One end is accurately cut to fit a No. 1 Hempel Quoin and the other is drop forged to fit a No. 2 Quoin. One inch of each end of the key is bent towards the same side of the stem at an angle of 107 degrees, raising the disengaged end one and one-half inches from the form. The pressman is thus enabled to reach under the cylinder and tighten or loosen quoins without in any way endangering the matter in the form, or bruising or soiling his knuckles. The shape of the end gives a firm, convenient hold on the key, while the length gives ample power. This key will be found to be very convenient and useful in the pressroom.

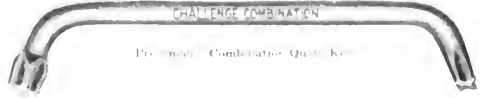

Pressman's Combination Quoin Key

Prices of Pressman's Combination Quoin Key

Pressman's Combination Quoin Key, polished tool steel, each
Pressman's Combination Quoin Key, nicked tool steel, each

\$1.00
1.15

Wickersham Pressman's Quoin Key

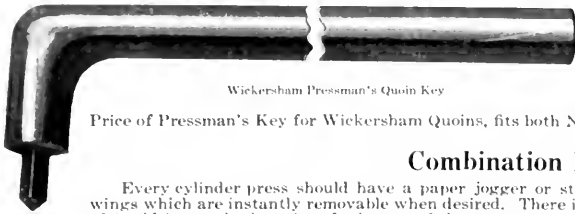

Wickersham Pressman's Quoin Key

Price of Pressman's Key for Wickersham Quoins, fits both Nos. 1 and 2, plain each

\$0.60

The Wickersham Pressman's Quoin Key, as its name implies, is also intended for use in locking and unlocking forms while on the press. It is decidedly a strong and well-made key and ought to last a long time. It fits both the No. 1 and No. 2 Wickersham Quoins and in offices where these quoins are used this key is just as essential as the Combination or Right Angle Keys for Hempel pattern quoins.

Combination Paper Jogger

Every cylinder press should have a paper jogger or straightener. The Combination Paper Jogger is made with wings which are instantly removable when desired. There is no projecting rod on the front side to tear clothes. This of itself is worth the price of a jogger. It has patent attachable wings for small joggers, by which letterheads etc., can be evened up. These are made to go on inside of others, and are hung with wire over the main wing, or evening bar. When specified in the order these are included free with small joggers. For sizes larger than twenty-four by thirty-six an extra price of fifty cents is charged.

Prices of Combination Paper Jogger

Hart Combination Jogger, 24x36

\$15.00

Hart Combination Jogger, 36x48

\$18.00

Hart Combination Jogger, larger

\$20.00

Press Points and Wrench

These points are screwed in as far as the cross bar with the wrench furnished, when they will stand the right height. If a larger hole in the paper is desired, screw the point out. This plan is far superior to the old method of driving a nail or wire into the wood furniture so as to make holes in the sheet.

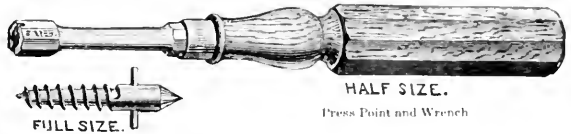

HALF SIZE.

Press Point and Wrench

Prices of Press Points and Wrenches

Points, per dozen

\$0.75

Wrench

\$0.75

FULL SIZE.

Adjustable Ball and Socket Drop Hangers

These hangers may be obtained either single or double braced. They all have machine-finished bases and bearings, machine-reamed and faced.

Prices on application

Shafting

All shafting is cold rolled and turned, straightened and polished. The diameters run from fifteen-sixteenths of an inch to one and fifteenth-sixteenths inches, and the weight per foot varies from 2.35 lbs. to 10.03 lbs. It is sold by the pound or by the foot, and detailed prices will be gladly furnished on application.

Iron Pulleys

Iron pulleys are sold either solid or split and the diameters range from six inches to thirty-six inches, with widths of faces from three inches to six inches. We shall be happy to furnish list prices when desired.

Wood-Split Pulleys

Wood-split Pulleys are furnished in diameters ranging from four inches to twenty-eight inches, and with widths of face from three inches to twelve inches. Orders can be filled promptly. Quotations will be gladly furnished for any size pulley on receipt of inquiry giving dimensions required.

Overhead Fixtures

Include two hangers, two collars and set-screws, countershaft, two cone pulleys and driving pulley. In ordering Overhead Fixtures always give diameter and speed of line-shaft. Widths of belts given for the presses are those we recommend. It is possible to run ten by fifteen on a one and one-half inch belt or fourteen by twenty-two on a two inch belt. We strongly recommend fixtures Nos. 19 and 23 for heavy Universal Presses.

List Prices, Dimensions and Style of Overhead Fixtures

STYLE	Speeds	Diameter of Cones	Width of Belt	Diameter of Driving Pulley	FOR PRESS	Shipping Weight Pounds	List Price With Solid Cone	List Price With Splt Cone
No. 11 Light	3	6 to 9	1 1/2	8	8x12	135	\$15.00	\$16.50
No. 13 Light	4	7 to 10	1 1/2	8	8x12	140	18.00	19.80
No. 15 Heavy	3	8 to 10	2	8	10x15-12x18	160	20.00	22.00
No. 19 Heavy	3	9 to 12	2 1/2	12	14 x22	200	22.50	24.75
No. 22 Heavy	4	10 to 13	2 1/2	12	14 1/2 x22	250	30.00	33.00
No. 23 Ex. Heavy	3	12 to 15	3 1/2	16	Cylinder	400	10.00	11.00

Couplings and Collars

Ribbed Compression Couplings
Collars, safety set screw
Collars, plain set screw

1 3/16 inch	1 5/16 inch	1 7/16 inch	1 11/16 inch	1 15/16 inch
\$3.05	\$3.65	\$4.20	\$6.30	\$7.40
.80	.90	1.00	1.20	1.30
.55	.55	.60	.70	.80

Composing Sticks, Etc.

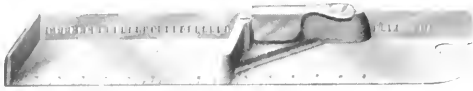

Rouse Job Stick

Depth	6-Inch	8-Inch	10-Inch	12-Inch	15-Inch	20-Inch
2 -inch	\$1 75	\$2 00	\$2 25	\$2 50	\$3 00	\$3 75
2 1/2 -inch	1 85	2 10	2 35	2 60	3 10	3 85
2 3/4 -inch	1 95	2 20	2 45	2 70		

Rouse Pica Stick

The only difference between this and the Rouse Stick is that this is without the six-point adjustment.

Depth	6-Inch	8-Inch	10-Inch	12-Inch	15-Inch	20-Inch
2 -inch	\$1 25	\$1 50	\$1 75	\$2 00	\$2 50	\$3 25
2 1/2 -inch	1 35	1 60	1 85	2 10	2 60	3 35
2 3/4 -inch	1 45	1 70	1 95	2 20	not made	
Plating	25	30	35	40	50	50



Rouse Job Stick French Pattern

6-inch	\$1 65	Plating, extra	\$0 25
8-inch	1 90	Plating, extra	30
10-inch	2 15	Plating, extra	35

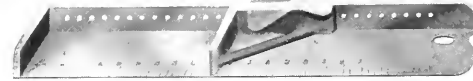

Improved Standard Job Stick

Depth	6-Inch	8-Inch	10-Inch	12-Inch	15-Inch	20-Inch
2 -inch	\$1 75	\$2 00	\$2 25	\$2 50	\$3 00	\$3 75
2 1/2 -inch	1 85	2 10	2 35	2 60	3 10	3 85
2 3/4 -inch	1 95	2 20	2 45	2 70		

Rouse, only . . . 15x2 1/4, \$3 10 20x2, \$3 75 20x2 1/4, \$3 85

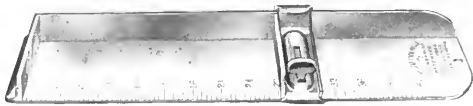

Star Composing Stick
Steel, Nickel Plated.

Depth	6-Inch	8-Inch	10-Inch	12-Inch	15-Inch	18-Inch
2 -inch	\$2 00	\$2 25	\$2 75	\$3 25	\$3 75	\$4 25
2 1/2 -inch	2 25	2 50	3 00	3 50	4 00	4 50

Brass.

Depth	6-Inch	8-Inch	10-Inch	12-Inch
2 -inch	\$2 50	\$2 75	\$3 25	\$3 75
2 1/2 -inch	2 75	3 00	3 50	4 00

This stick is made in four lengths and two depths. Nickel plated or brass—the choice is left to the purchaser.

Length	2 inches deep	2 1/2 inches deep
6-inch	Steel, \$2 00; Brass, \$2 50	Steel, \$2 25; Brass, \$2 75
8-inch	Steel, 2 25; Brass, 2 75	Steel, 2 50; Brass, 3 00
10-inch	Steel, 2 75; Brass, 3 25	Steel, 3 00; Brass, 3 50
12-inch	Steel, 3 25; Brass, 3 75	Steel, 3 50; Brass, 4 00

The Grover Stick



6x2 1/4 in.	\$0 90
8x2 1/4 in.	1 00
10x2 1/4 in.	1 25
10 1/2 x2 1/2 in.	1 25
12 x2 1/4 in.	1 40
16 x2 1/4 in.	1 80

Extra clasps, 10 cents each; extra knees, 40 cents each.



Common Screw Stick

Screw	6-Inch	8-Inch	10-Inch	12-Inch	14-Inch	16-Inch	18-Inch	20-Inch
	\$0 75	\$0 80	\$1 00	\$1 15	\$1 30	\$1 45	\$1 60	\$1 75

The Buckeye Stick



6x2 1/4 in.	\$0 90
8x2 1/4 in.	1 00
10x2 1/4 in.	1 25
10 1/2 x2 1/2 in.	1 25
12 x2 1/4 in.	1 40
16 x2 1/4 in.	1 80

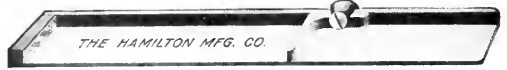

Wood Poster Stick

These have brass lined ends, iron knee and screw clamp; width inside two and one half inches. Made of cherry and fitted with japanned clamp, polished knurl headed screw and japanned knee.

16-inch, \$1 00; weight . 13 oz.	30-inch, \$1 35; weight . 18 oz.
20-inch, 1 10; weight . 15 oz.	36-inch, 1 50; weight . 20 oz.
24-inch, 1 20; weight . 16 oz.	42-inch, 1 80; weight . 24 oz.



Yankee Job Stick

Depth	6-Inch	8-Inch	10-Inch	12-Inch	14-Inch	16-Inch	18-Inch	20-Inch
2 -inch	\$0 70	\$0 80	\$0 95	\$1 10	\$1 30	\$1 45	\$1 50	\$1 75
2 1/2 -inch	0 75	0 80	1 00	1 15	1 30	1 45	1 60	1 75
2 3/4 -inch	0 75	0 80	1 00	1 15	1 30	1 45	1 60	1 75

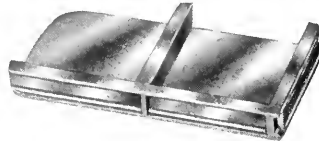

All Brass News Stick

Made of all brass and permanently set to 13 ems measure therefore not adjustable. Better appearance and more easily kept clean than iron or steel.

2 1/4 -inches deep, net	\$0 80
2 1/2 -inches deep, net	90



Perfect News Stick No. 1

To make allowance for the inevitable compression in the lines of type in locking up the form the measure of this composing stick is made to a standard slightly larger than the point system.

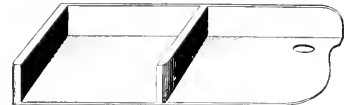

Perfect News Stick No. 2

No. 1. Malleable iron, milled for 13 or 13 1/2 ems pica measure, each . . . \$0 75
No. 2. Steel Riveted, for 13 or 13 1/2 ems pica measure, each . . . 80

New Star Line Measure

This is a most efficient, complete and handy tool, graduated to ems by halves. Its great merit is most convincingly shown by its practical use. A form being composed on the galley is easily measured on both edges, while the line gauge is in the same position for each edge. The right and left hand hook enables the user to compress the measure against the head of the galley with equal pressure as a test for a square, or for column lengths at either edge of the form. It will be found very useful for testing pages in locking up on the stone. These advantages are particularly noticeable in connection with forms set up of machine set matter, either alone or combined with type set matter. On the reverse side is the Pica Rule with standard inches, graduated to sixteenths.

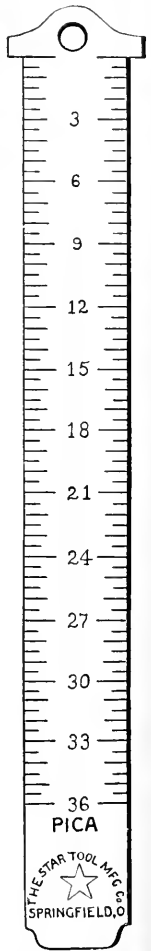

New Star Line Measure
Greatly Reduced

Description and Prices

	6-Inch	8 1/2 -Inch	12-Inch
Steel N. P.—Pica and Nonpareil	\$0 25	\$0 35	\$0 45
Steel N. P.—Pica, Nonpareil and Agate	30	40	50
Aluminum—Pica and Nonpareil	30	40	60
Aluminum—Pica, Nonpareil and Agate	35	45	65
Brass—Pica and Nonpareil	40	50	65
Brass—Pica, Nonpareil and Agate	50	60	75
German Silver—Pica and Nonpareil	60	70	90
German Silver—Pica, Nonp. and Agate	70	80	1 00

Prices of Pica and Sixteenths same as Pica and Agate.

Boxwood Triangular Type Measure

The Boxwood Triangular Type Measures are very accurately and sharply cut, and made of the best grade of thoroughly seasoned boxwood. The graduations are guaranteed accurate. Each side of the triangle is flat, thus enabling the rule to be easily and steadily handled. Will measure all sizes from 1/2 to 3 points, and all multiples of 1/2 point.

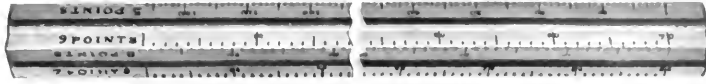

Boxwood Triangular Type Measure

List Price of Boxwood Triangular Type Measure, 9 inches long \$1 50
List Price of Boxwood Triangular Type Measure, 18 inches long 3 00

The Lincoln Type Measure

The Lincoln Type Measure is a steel tape, twenty-four inches scale, agate to pica measure, in a German silver case. May be easily carried in the vest pocket.

List Price of Lincoln Type Measure, each

\$2 00



Lincoln Type Measure

American Square Boxwood Type Measures

The American Square Boxwood Type Measures are made of hard wood, three-quarters of an inch square, twelve inches long, with brass edges. They are graduated in inches, and to 5/2, 6, 7, 8, 9, 10, 11 and 12 points. They also have the advertising agate scale of fourteen lines to the inch.

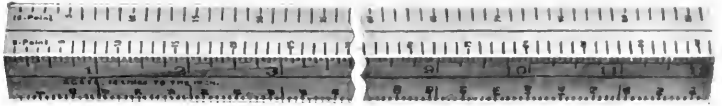

American Square Boxwood Type Measure

List Price of American Square Boxwood Type Measure, each

\$3 30

Steel Composing Rules

The Perfection Set contains forty spring tempered steel composing rules, numbered 4 to 45 picas, including half-em measures below 10 picas, are fitted in a handsome case strongly made of polished oak, plush lined and nicely finished. List price

\$3 50

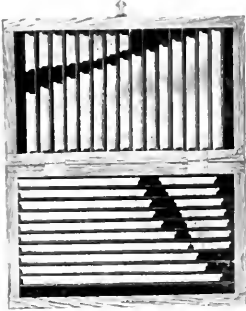

Perfection Rule Set.



Steel Make-up Rule

in the vest pocket. It has patent clasp and contains twelve steel composing rules. Sizes, 10, 12, 13, 14, 15, 16, 18, 21, 24, 26 1/2, 28 and 30 ems pica. List price

\$1 50

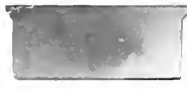

Steel Composing Rule

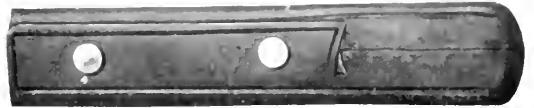

Leather Pocket Rule Case

The Leather Pocket Rule Case is well made of strong brown leather, and compositors will find it very convenient for carrying twelve steel composing rules. Sizes, 10, 12, 13, 14, 15, 16, 18, 21, 24, 26 1/2, 28 and 30 ems pica. List price

\$1 50

These Steel Composing and Make-up Rules are made from the finest quality tempered steel, highly finished. Sizes and prices:

4 to 15 ems	\$0 15	31 to 35 ems	\$0 35	51 to 55 ems	\$0 35
16 to 20 ems	20	36 to 40 ems	40	56 to 60 ems	60
21 to 25 ems	25	41 to 45 ems	45		
26 to 30 ems	30	46 to 50 ems	50		

15

Extra thin Composing Rule (10-to-pica) 13 ems

Ink Spade

A very useful little accessory for the pressroom is the ink spade. It is made of steel, heavily nickel plated and may be used for a variety of purposes—cleaning out ink keg, ink can or fountain, mixing ink, or scraping an ink disc or plate. In mixing inks it will not discolor the daintiest tint. One side is cut on a slant and slightly rounded, so the inside of the keg can be scraped without soiling the fingers. Steel handle, with spring steel blade. No better ink spade can be found.

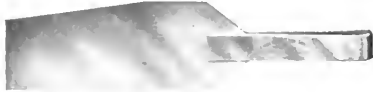

Ink Spade

Price, each \$0 60
When sent by mail 72

Ink Knives



Ink Knife

Style B, 6-inch \$0 60
Style B, 10-inch \$1 00
Style B, 8-inch \$1 00
Style B, 12-inch \$1 60

Square End Pallet



Square End Pallet

Pallet, Style B, 6-inch \$0 60
Pallet, Style B, 8-inch 1 00
Pallet, Style B, 10-inch 1 60
Pallet, Style B, 12-inch 2 00

Round or Square End Spatulas

Spatula, Style A, 6-inch \$0 50
Spatula, Style A, 8-inch 70
Spatula, Style A, 10-inch 1 00
Spatula, Style A, 12-inch 1 65

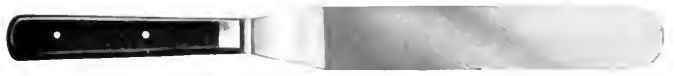

Round End Spatula

Pressman's Knife



Pressman's Knife

The Ideal Pressman's Knife is covered with a wood handle, which can be cut away as the knife becomes worn.
Pressman's Knife, each \$0 50

Overlay Knife

These Overlay Knives are finely tempered and polished. Each is ground sharp.



Overlay Knife

Overlay Knife, in leather case \$0 60

Hook Gauge Pin

This Pin is adjustable. The hook point should be inserted one-half inch below the feed line and drawn forward. The gauge point must be dropped at the feed line and lifted to get register.



Price, per dozen \$0 25

Single Prong Gauge Pin

This Pin supports itself in an upright position. The point should be inserted at the feed line and the prong run under the tympan to the shoulder or gauge.

Price, per dozen \$0 25



Two Prong Gauge Pin

This Pin has a double point support with span between. Both points should be inserted on the feed line and the prongs run clear in.



Price, per dozen \$0 25

Golden Steel Gauge Pins

In order to obtain the greatest advantage in the adjustability of these Gauge Pins the prong should be inserted one-quarter of an inch below the line of feed. The prong, when in the paper with the point brought up through, acts as a sliding bar by which the Gauge Pin is moved backward and forward. Not exact position for feeding are the teeth forced in. All that is needed to stick the prong through is a single sheet of good strong paper. For the general run of job work and in order for the teeth to get a full hold, a tympan, padded with a half dozen hard sheets and a hard cardboard is very suitable.

Price, either size, not assorted, per dozen \$0 40



Original Steel Gauge Pin

This Pin was, as its name implies, the first of adjustable gauge pins. Its advantage lies in the gauge head being double thick and its construction such as to provide a broad, flat, even feeding surface. The Gauge corners are also rounded. It is simplicity itself in conception and good tight tympan should

Original Steel Gauge Pin



No. 2

is a great favorite with many. A be used, but it is not necessary to stick the prong through more than the top sheet. When the point is run in about half an inch the point should be brought up through by pressing the finger over it and easing the teeth while moving along.

Price, in four sizes, either one size or assorted, per dozen . . . \$0 60

Spring Tongue Gauge Pin

This Pin is liked exceedingly well for all kinds of work because it has a tongue which may be bent up high, so as to receive the sheets more readily in feeding and being elastic will not break under pressure of blocks, leads, or quads in the form. The tongue

is also of assistance in preventing sheets or small cards from sticking to the form. In fact the tongue improves the register. The Pin is treated the same as other styles having teeth adjustment, but its securing power is enhanced by the back supports. Any degree of margin, or none at all, is met by setting the Tongue, which may also be run between lines or in blank spaces.

Price, per set of three, with an extra long tongue with each pin \$0 40
Per dozen 1 20



Spring Tongue Gauge Pin



Short Tongue

Screw Adjusting Gauge Pin

The base of this Gauge Pin is fastened to the tympan by a stout prong and the Gauge is adjustable backward and forward on the base. It may be finely adjusted by simply turning the little knurled nut seen at the rear of the base. Its maximum

adjustment is half an inch. Glue or wax may be applied to the open base if necessary. In attaching, the prong should be inserted a quarter of an inch below the feed line and pushed chock home, the Gauge being squared before bringing the prong up through. There are no teeth. Flat tongues are used, which are held in the head of the Gauge.

Price, set of three, including one dozen flat tongues . . . \$1 00



Perfect Register Gauge

To obtain perfect register, especially in fine color work, is probably among the most trying and exacting of all the requirements of the printing press. The Perfect Register Gauge is especially designed for making very fine and quick adjustments, not only in starting, but in making changes in its position while running off the job. Some pressmen claim that adjustments can be made without stopping the press. The Gauge is fastened to the tympan by applying glue to the base. To obtain adjustment a slight turn of the disk, which moves the sliding part

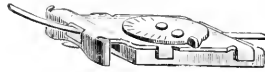

Perfect Register Gauge

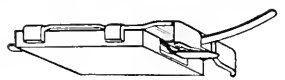

Bottom View of Gauge

or gauge-head backward or forward a much slighter degree, is all that is necessary. The full extent of adjustment is one-eighth of an inch. To hold the base on

while drying and to prevent sheets slipping under in feeding, a steel point, seen in the bottom view of Gauge, is inserted in the tympan. It is only necessary to secure the top sheet. In removing the Gauge it is best to tear it off from the rear.

Price of Gauge, per set of three, including one dozen flat tongues \$1 25
Flat tongues, long and short, per packet 25



Long Flat Tongue

Brass Gauge Pin

This is a tough Gauge Pin for tough work. May be used on any tympan. Both points are stuck in at the feed line and brought up through.



Sizes made 1, 2, 3, 6.
Price, per dozen . . . \$0 40

Flexible Side Gauge Pin

This is a Gauge Pin, which enables one to apply both grippers without consideration of the position or safety of the side gauge. It can be used as a bottom gauge as well as a side gauge and is non-smashable. It has teeth and is adjusted in the usual manner. It will be found to possess lasting qualities.

Price, per dozen, with or without lips \$0 60

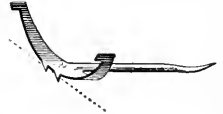

Extension Feed Guides

When it is desired to print on a sheet so large that it nearly covers the platen, the tympan gauges cannot be used. In such a case the Extension Feed Guides are fastened in the bale and by the use

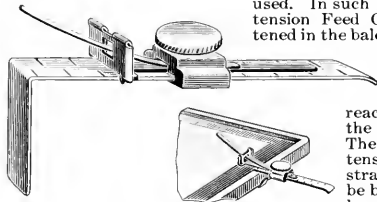

of the long and short guides, any point is reached between the two positions. The leg of the extension is furnished straight and should be bent around the lower edge of the

bale to form a hook, by which they are easily drawn down and secured with the bale.

Price, including pair of short guides and long tongue, per pair \$1 00

Eccentric Stud Gauge

This Gauge is turned from a solid bar of metal and is provided with a fixed lip instead of an adjustable tongue.



Eccentric Stud Gauge

The face of the gauge is round instead of flat. It is made fast to the tympan by a knurled nut, which draws a circular plate against the under side of the tympan and binds the whole together. It may be attached from underneath or by inserting the circular plate from above. In thick tympan a slot

should be made, so that the screw may move freely in it.
Price, per set of three \$0 75

Iron Gauge Pin Drawer

Made of iron, screws on under the feed board of press table. Useful for gauge pins when not in use.

Size 2 1/2 x 3 1/2 x 3/4 in.
Price each, including screw \$0 25
Postage 08

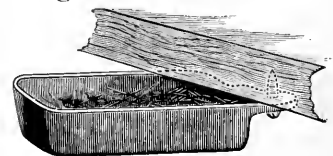

Solid Brass Gauge

This is a job press gauge or gauge, made of solid brass. It is twelve point, and when glued to tympan acts as an effective gauge. Price, per dozen \$0.50



Cylinder Side Guide

This device is secured to the feed board by the sharp point shown in the outline in cut, which is placed at the side of pillar, so that hair-adjustments may be obtained by simply turning the pillar to the desired position. The bendable brass tongue is adjustable in every direction.

Price, each

\$0.50

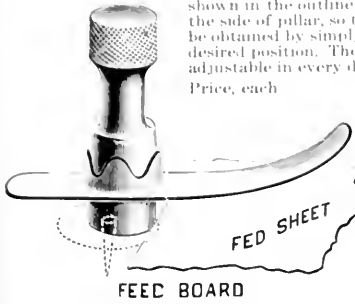

Gauge Pins

Gauge Pins are probably more used today than ever before. They are really a necessity in most printing offices. They are inexpensive and save considerable time in make-ready. In order to meet the demands of our customers we keep a large assortment of the very best lines made.



Key for Gauge

Price, set of three, including six extra tongues, per set \$1.25

Double Grip Gauge

A new method of attachment was developed for this Gauge. In fastening it there is no need to pry teeth protruding near pillar. No other part necessary to cut piece out of or slit the tympan transversely. All that is required is to cut a slit through the top sheet straight from the feed line one inch in length. Into this slit the under plate is inserted & drawn up to the screw studs, and there fastened by the two nuts. Sufficient hold can be produced with the fingers for ordinary stock as it is secured at two points along the slit, but for cardboard the key should be used. One-quarter inch adjustment is obtained with the inch slit. If more is required it can be had by cutting the slit longer. A very powerful hold is obtained by the use of a manila top sheet. It does not injure packing, the tympan may be turned back or its use repeated. Sheets cannot be fed under the gauge-head. This is a very handy and useful device and is a gauge, not a pin.

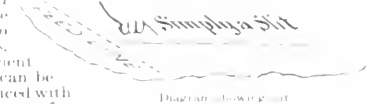

Megill Automatic Register Gauge

The highest class printing, whether in colors or in black, demands uniformity and this cannot be obtained without accurate register. The Automatic Register Gauge will not only produce absolutely perfect register but will increase the output and save stock. It will allow the press to be run at a higher rate of speed without the usual spoilage and use of the throw-off. The Automatic is instantly applicable to all sizes and makes of platen presses. No changes are required. On reference to the illustration it will be seen that the Gauge is complete in itself and, though operated by the gripper, has no connection with it and is free to be placed anywhere. The speed arm touches the gripper near the bottom end, having a lateral motion across it, always works easily and is adapted to any inclination of gripper or platen. All wearing parts are of hardened steel and the device is constructed on the interchangeable system. It takes less than a minute to attach, and the method of attachment is simple and reliable. The finest adjustment can be obtained and no parts are employed which are liable to disarrange during the run. The forward feet prevent the sheets from feeding under the setter-head. A tongue is unnecessary as the lip prevents the sheets from slipping up over the setter-head in feeding. The gripper is set so as to come down between the setter-head and toggle-joint when flat. All parts depress to twelve points. The speed arm is needed only when running. It is applied at the notch and runs easily to position. The pressure of the

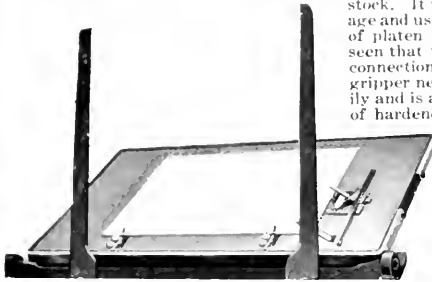

Fig. 1. Platen Open

gripper will not displace it. The illustrations show a twelve point setter-head.

Price, delivered

\$4.80

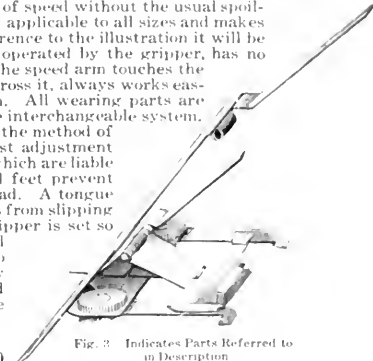
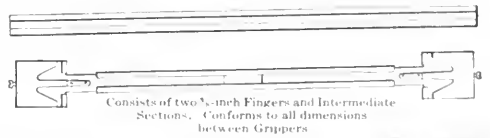
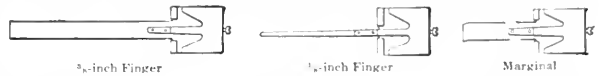
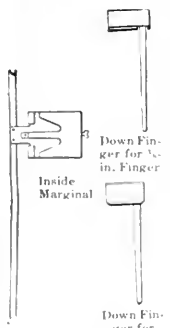

Fig. 2. Indicates Parts Referred to in Description

Gripper Cross-Bar and Gripper Fingers

These devices will do the work which has defied the ordinary grippers. They are designed for the platen press and can be quickly applied and adjusted, holding immovably. The Cross-bar is the first invention to completely cross the platen and conform to all



3/8-inch Gripper Finger, size one inch, reduced one-half

obliged to resort to make-shift methods in order to obtain the line results he desires. Sometimes the forms may slur, or the stock will permit of very small margin. Often the stock curls and wrinkles, or will not lie flat. Frequently the sheets adhere to the form, or a variety of other difficulties may arise, all tending to obviate good work and causing loss of time. The prices of the Gripper Cross Bar and Gripper Fingers make it possible for a pressroom to own a complete complement of this useful device.

Prices of Gripper Cross-Bars and Gripper Fingers

3/8-inch Gripper Finger, each	\$0.50
1/2-inch Gripper Finger, each	.50
Marginal Finger, each	.50
Down Finger for 3/8-inch Finger, each	.25
Down Finger for Cross-Bar, each	.25
Complete Cross-Bar for all size presses up to 10x15	1.50
Complete Cross-Bar for all size presses up to 13x19	1.75
Complete Cross-Bar for larger presses	2.25

Cross Bar with Down Finger Applied. Also an Inside Marginal Finger which admits a side gauge with a narrow head between it and the gripper

Tweezers



No. 11 A Tweezer

No. 11 A, nickel plated. Price \$0 25

The No. 5 is the best Tweezer procurable at the price; has file point, steel, nickel plated; 4 inches long. Price \$0 50



No. 5 Tweezer



No. 7 Tweezer

points and backs. No. 7, 4 inches long. Price \$0 75

This is the No. 8 Tweezer, 4 3/4 inches long.



No. 8 Tweezer

Price No. 8 Tweezer \$0 85



Improved Locking Tweezer

ally by holding the points up or down. Can be carried in the pocket with comfort and safety.

Nickel plated. Price \$0 90

No. 3 Combination Bodkin and Tweezer. When not in use the bodkin folds into the tweezers. Pressure on the file cut brings the bodkin out readily and when extended it locks securely.



No. 3 Combination Bodkin and Tweezer

Nickel plated. Price \$1 00

This is a good and cheap Tweezer. It is made of polished steel, nickel plated; 3 1/2 inches long.

The Nos. 7 and 8 are the best Tweezers made; tempered steel, nickel plated, with file cut

The Improved Locking Tweezer cannot get out of order easily. Locks and unlocks automatically by holding the points up or down. Can be carried in the pocket with comfort and safety.

Leader Boxes

There are two types of practical Leader Boxes, the Hamilton and the May, both strong, well made and unexcelled in the purpose for which each is intended.

For the job man the Hamilton Box is probably the best, as it can be used anywhere about the office, carried to the job bank or used on a stone. For the type compositor the May Box is doubtless the best, as it does not cover the type boxes when in use and is placed in a certain position and kept there.



Hamilton Leader Box.



May Leader Box

Prices

Hamilton Leader Box, size 5x8x1 3/4 inches, weight six ounces.
Price, per dozen \$2 50
Each 25

May's Patent Leader Box, size 4 1/2 x 6 1/2 x 1 1/2 inches, weight four ounces.
List price, per dozen . . . \$5 00
Each 50

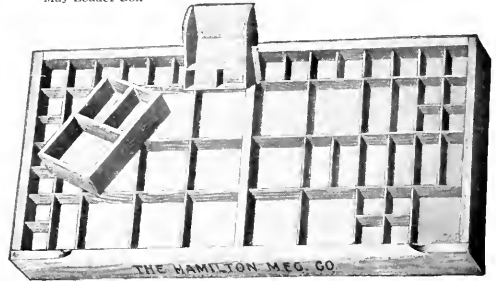

This illustration shows how the May Leader Box and the Hamilton Leader Box may be placed on a Case

Bodkins



Steel Needle Bodkin

Steel Needle Bodkin with wooden handle. Price \$0 10

Marble Ink Slabs

These Marble Ink Slabs are made from the best grade of Vermont marble, especially finished for the purpose.

Marble Ink Slabs, 8x12 inches, each \$1 25
Marble Ink Slabs, 12x18 inches, each 2 00
Marble Ink Slabs, 18x24 inches, each 3 75

Saws

The Back Saw is one of the most essential articles for the composing room. It cuts wood or soft metal with the greatest of ease.



Back Saw

Price \$1 25

Miter Boxes



Miter Box

Unbreakable Miter Box, 13 1/2 inches wide, weight two pounds. Price \$0 50

Unbreakable Miter Box, 3 inches wide, weight three and one-quarter pounds. Price 60

Other sizes of Laminated Miter Boxes can be made to order. Prices furnished on application.

We have a Miter Box so strongly built that it cannot be broken. It is made of lumber that is built up of various layers with the grain crossed.

Case Pulls

The No. 1 Case Pull is attached to all steel run and wood run cabinets and is a most convenient pull for all type cases.

No. 1 Case Pull

Price, with screws for attaching to case fronts, each . . . \$0 05
Price, with screws, in bulk, each 04

No. 2 Case Pull

For attachment to shallow cases and narrow drawers.
Price, with screws, each \$0 04
Price, with screws, in bulk, each 03

No. 3 Case Pull

This is a pull and label holder combined.
Price, with screws, each \$0 05
Price, with screws, in bulk, each 04

Bellows

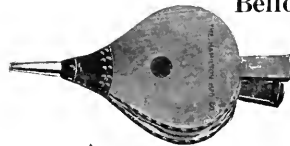

Bellows

These Bellows are made exactly as illustrated and are correctly shaped; they are very strongly made of best selected materials. In the construction of these bellows, a reed has been placed inside which greatly assists inflation.

Small size Bellows, 8 inches, weight eighteen ounces.
List Price \$1 00
Large size Bellows, 10 inches, weight, twenty-three ounces.
List price 1 25

Cylinder Bellows

The operation of "blowing out" dusty cases is far better controlled by the use of the Cylinder Bellows than with the ordinary old fashioned bellows. The former is more powerful.



Cylinder Bellows

Small Cylinder Bellows. Price \$1 25
Large Cylinder Bellows. Price 1 50

American Lettering Pallet

This Lettering Pallet is made of solid brass, substantially constructed, and handsomely finished. It is admitted to be one of the best pallets manufactured. It has capacity for a line four and one-half inches long. It is readily adjusted by two thumb screws, which center the line with one operation from either end. It is an indispensable tool for every bookbinder. The American Type Founders Company makes the best and largest assortment of Brass Type, reproducing in brass many of its type designs that are most suitable for the purpose. A complete, modern and up-to-date specimen book of Brass Types, Ornaments and Borders will be furnished on application.

Price, American Lettering Pallet

\$6.00

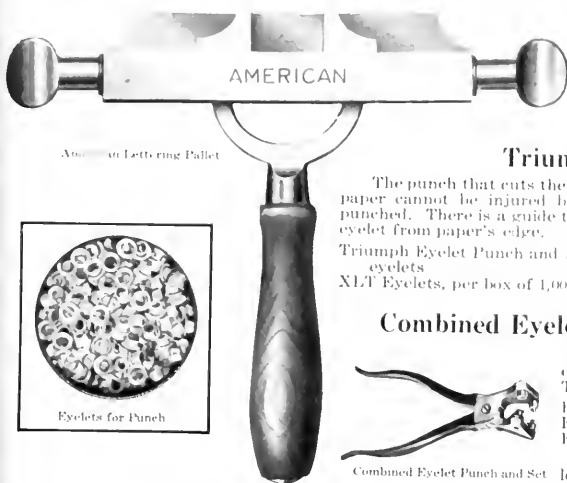

American Lettering Pallet

Eyelets for Punch

Triumph Eyelet Punch and Set

The punch that cuts the paper is separate from the eyelet set, so that paper cannot be injured by the latter while being punched. There is a guide to regulate the distance of eyelet from paper's edge.

Triumph Eyelet Punch and Set, including 1,000 eyelets \$2.25
 XLT Eyelets, per box of 1,000 10

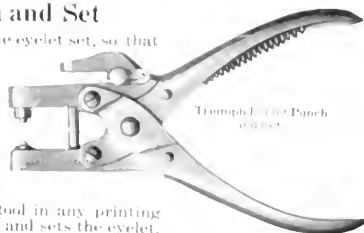

Triumph Eyelet Punch and Set

Combined Eyelet Punch and Set

This is a very useful tool in any printing office. It punches the hole and sets the eyelet. Takes only one size eyelet (No. 2 Skirt).

Price complete \$1.50
 Eyelets, per box of 1,000 50
 Eyelets, per box of 500 25



Combined Eyelet Punch and Set

The sizes of the punches and the dies correspond with the eyelets made. Order by number.

American Job Press Brake

Our Job Press Brake is a simple, durable and effective brake for Gordon and other platen presses. It is made entirely of cast iron in a workmanlike manner. Anyone can attach it in a very few minutes. One of the most important features of this Job Press Brake is that a belt may also be used on the fly wheel of the press without interfering in any way. The Job Press Brake stops the press instantly, thus often avoiding accidents and expensive repairs. It is a safeguard that should be placed on every job printing press. In addition to the list of regular sizes and prices given below, we can furnish special brakes at a slight advance in price for any press, if the following dimensions are given: the diameter of the fly wheel; the distance from the fly wheel to the floor and the distance from the center of the fly wheel to the front of machine.

Price of American Job Press Brake (in regular sizes)

\$5.00



American Job Press Brake

Tape in Rolls

A good quality of tape is necessary in the press room and bindery. Cheap tape is dear at any price. There is scarcely anything more annoying than the breaking of a tape on the press, or on any other machine. This invariably happens when one is in a hurry. We have tested many makes of tapes and have concluded that the quality we offer is the best that has been made up to this date.

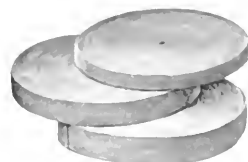

Tape in Rolls

Prices of Press Tape in Rolls of Thirty-Six Yards

Size	5 Rolls or less Per Roll
3/8 inch	\$0.65
1/2 inch	.80
5/8 inch	1.00
3/4 inch	1.20
7/8 inch	1.40

Size	6 to 11 Rolls Per Roll	12 Rolls and over Per Roll
3/8 inch	\$0.58	\$0.50
1/2 inch	.70	.60
5/8 inch	.85	.75
3/4 inch	1.05	.95
7/8 inch	1.20	1.10

Size	5 Rolls or less Per Roll	6 to 11 Rolls Per Roll	12 Rolls and over Per Roll
1 inch	\$1.50	\$1.30	\$1.15
1 1/8 inch	1.75	1.55	1.35
1 1/4 inch	1.80	1.60	1.40
1 1/2 inch	2.10	1.85	1.60
2 inch	3.00	2.65	2.35

Metallc Tape Couplers

This is a device for connecting the ends of tape on presses and folders, so that there will be no wear on the joined parts. This method is more durable than any other for securing the ends of tape. The Couplers prevent the tape from running crooked and throwing paper out of register.

They can be put on in a few seconds by means of parallel pliers made for this purpose. The Metallc Couplers are not made larger than one and one-eighth inches. If one and one-quarter-inch size is wanted, use two of the five-eighth-inch Couplers.



Parallel Pliers

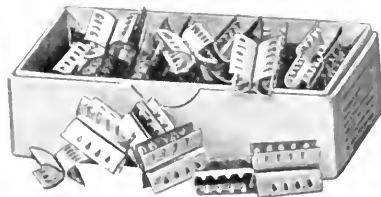

Metallc Tape Couplers

Prices of Metallc Tape Couplers, per Box of Fifty

3/8 inch	\$1.10	7/8 inch	\$1.60
1/2 inch	1.10	1 inch	1.75
5/8 inch	1.25	1 1/8 inch	1.75
3/4 inch	1.50	1 1/4 inch	2.00

Steel Roller Supporters

For job presses these are among the best supporters yet devised. They only occupy one-quarter of an inch of the inside space of a chase; they ease the pressure of the rollers on the form, prevent over inking and save rollers from cutting, as they are three-quarters of an inch wide on top. Being nickel plated they will not affect the daintiest ink.

List Prices and Dimensions of Steel Roller Supporters

	Per Pair
For 7x11 Chase	\$0.40
For 8x12 Chase	.45
For 9x13 Chase	.50
For 10x15 Chase	.50
For 11x17 Chase	.60
For 12x18 Chase	.75
For 13x19 Chase	.75
For 14x20 Chase	.80
For 11 1/2 x 22 Chase	.90

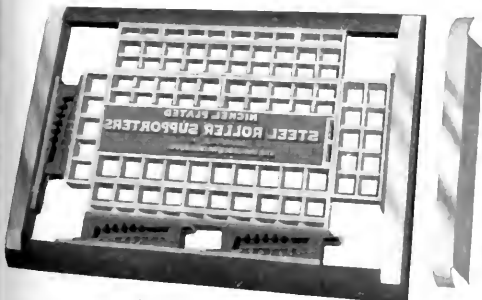

Steel Roller Supporters

The Superior Steel Tableting Press

Here is an improvement in the lasting qualities of a Tableting Press. While the old method of building this device mainly of wood was fairly satisfactory, a better way has been adopted. The Superior is constructed entirely of steel and iron and is as rigid and strong as it is really possible for human hands to make it. There will be no more warping or cracking when this improved line of Steel Tableting Presses comes into general use. The Superior Press has no clamps or screws to be operated and is very rapid and effective in operation. This apparatus has an iron brick and base plate, which forms the bottom of the box. The sheets are placed in the box, as shown in the illustration, and the iron brick placed on top of the pile. Then by taking the press by the handle and leg and placing it in a perpendicular position, and withdrawing it from under the base plate, the pile is left standing on the base plate all ready for the glue brush, as depicted in the cut. This press is a trifle more expensive than if made of wood, but will be found much more economical in the long run. Every printer needs one of these Steel Tableting Presses for his office equipment.

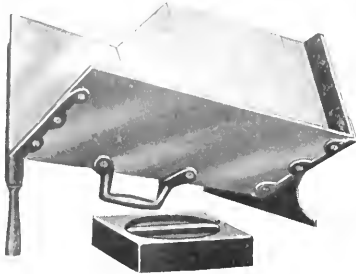

Superior Steel Tableting Press

Extra Cast Iron Bricks, weight about twenty-five pounds, each
Extra Base Plates, each

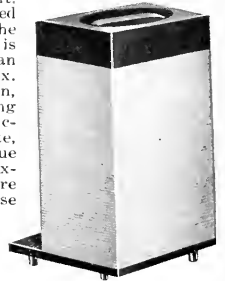

Sheets Ready for Gluing
Illustration showing the cast iron brick and base plate in position

List Price of Superior Steel Tableting Press
Superior Steel Tableting Press, complete with sheet steel box, cast iron brick and base plate, size 8x8x18 inches; capacity 6000 sheets

\$8 50
2 75
75

The Perfection Steel Tableting Press

Like the Superior, the Perfection Steel Tableting Press is made of steel and iron, with the same careful workmanship as is used in the manufacture of the higher priced apparatus. While the price is somewhat higher than for wooden presses, the lasting qualities are so much greater that it is bound to prove cheaper in the long run. The Perfection Steel Tableting Press is intended to straighten up and hold the sheets of paper while being glued. It is simple and convenient and will be found to be one of the best and handiest articles yet devised for the purpose. It will handle any number of sheets up to three thousand with equal ease. Is made sloping so that the paper will rest alone while being adjusted. The clamp is separate from the box and is quickly arranged to take various thicknesses. Any desired pressure may be obtained by turning the screw crank.

The advisability of equipping with the Perfection Steel Tableting Press will be apparent to the up-to-date printer. We supply them on short notice.

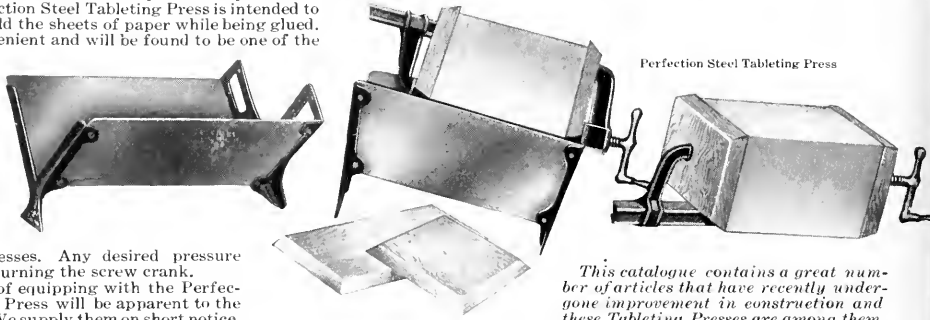

Perfection Steel Tableting Press

This catalogue contains a great number of articles that have recently undergone improvement in construction and these Tableting Presses are among them.

Prices of Perfection Steel Tableting Press and Clamps

Perfection Steel Tableting Press, sheet steel holder, complete with clamp and five boards \$5 00
Extra Clamp, with Five Boards 2 50
Extra Clamp, only 1 40

Cott's Tablet Holder and Clamp

Cott's Tablet Holder and Clamp is similar in construction to other tableting presses, except that it is made of wood and is more economical in price. It will hold any number of sheets up to three thousand and any size from two and one-half by two and one-half inches to eighteen and one-half by fourteen inches. The clamp is adjustable to the various thicknesses and any desired pressure can be obtained quickly and effectively.

List Prices of Cott's Tablet Holder and Clamp

Holder and Clamp, complete, set of Five Press Boards . . . \$3 50
Extra Set of Five Press Boards 1 60
Extra Clamp, without Press Boards 1 40

Liquid Padding Glue

This Liquid Padding Glue is an elastic, tough, quick drying preparation, which is always ready for use and requires no heating. It is not subject to change of temperature, but is perfect under all conditions. It is free from odor and is furnished in red, blue, green or colorless, as you may desire.

Prices Liquid Padding Glue

Half Pint Cans \$0 35
Pint Cans 60
Quart Cans 1 00
Gallon Cans 3 75



Glue Pot

Glue Pots

Glue Pots, while ordinary, are very essential. We have but one quality and that the best.

Prices Glue Pots

Glue Pot, one quart \$0 90
Glue Pot, two quarts 1 20

Padding Composition

Many printers prefer padding composition to a liquid glue. To those who do, we offer an excellent article at a reasonable price. The friction top tin cans, in which it is put up keep it in good condition. It is made only in white, except on special order. This composition must not be boiled but simply heated.

Prices of Padding Composition

Padding Composition, in friction top tin can, 1 pound . . . \$0 30
Padding Composition, in friction top tin can, 5 pounds . . . 1 25
Padding Composition, in friction top tin can, 10 pounds . . . 2 25

Tablet Knife



Tablet Knife

This Knife is made especially for separating pads. Has extra thin, strong blade made of approved design.
Tablet Knife, each \$0 50

Cement Brush

Cement Brush of French bristles, flat and double thick.



Cement Brush

Prices of Cement Brushes

1 inch \$0 30
1 1/2 inches 40
2 inches \$0 55
3 1/2 inches 75

Paper Counter

This Pad or Paper Counter is a device adjustable for dividing any number of sheets into equal parts for padding. To use, you count out the number sheets wanted by hand on top of which place the plate. Then draw the adjustable gauge up firmly against the paper, screwing the handle in to hold the stab in place. To operate, place plate on top of lot to be counted and push stab into paper, bearing down at same time. The gauge is nickel plated and adjustable up to one and five-eighths inches.



Paper Counter

Price \$0 75

ELECTRIC-WELDED STEEL CHASES

Every bar of steel used in the manufacture of these Electric-Welded Steel Chases is made up from a special grade of open hearth steel. This special mixture was compounded to meet the peculiar conditions of electro-welding, which always require that the impurities shall be very low, so that the steel shall weld well and also prevent what is known as a congregation of impurities rendering the steel brittle and liable to breakage, which happens when the impurities collect together. In order to bring about the right mixture, the proper proportions of carbon and manganese must be effected. Carbon imparts the property of brittleness, therefore only a small percentage of carbon may be used. It is also necessary to have manganese in the proper quantity for the purpose of making it dense, close-grained, tough and strong. Sulphur and phosphorus are great enemies of steel and the best steel contains only very slight traces of these ingredients. Our steel contains the proper proportions of carbon and manganese and is as free from sulphur, phosphorus and other impurities as it is possible to make it. After the steel is made it is first hot drawn through dies of approximately the size, then cold drawn to the correct size. This very

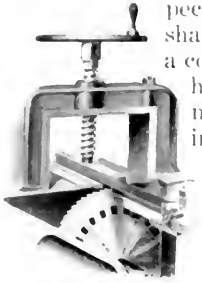

Cuts through the hard steel with astonishing ease

process of drawing is a guarantee of strength of each and every bar used by us as it takes a pull of some 40,000 pounds to draw each bar through the dies. Any bar which breaks in this drawing process is thrown aside as defective. Therefore the secret of the Electric-Welded Steel Chase lies, first, in the grade of steel used, and second, in the method of welding—in electric-welding the heat is first generated at the center of the bars, and thus the weld is made from the center outward. In electric-welding, too, exactly the right amount of heat may be applied to bring the metal to just the degree of fusibility which gives the best results. The material is not weakened by burning, nor is its temper drawn at any point except where the weld is made; and yet the heat is sufficient to cause the molecules of steel to intermingle just as they would were the metal melted and cast in a mold; hence it is that the four bars originally used for making an Electric-Welded Chase really become one solid, perfect piece of steel, without flaw or blemish of any sort to indicate that a weld has ever been made. The steel used in our chases has a tensile strength almost double that of the material used in the past, as has been demonstrated by tests made in the testing laboratory of one of the largest steel plants in this country. The tests by no means ended here; mere strength lacks much of being the only test of a good chase. Defective tests showed that, on two chases of the same size, when each was sprung a quarter of an inch the Electric-

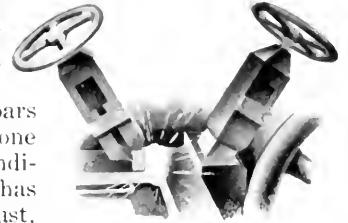

Gradually becomes bright until in a few seconds it is dazzling

Welded Chase returned to its original shape on the removal of the pressure, while the one made from cast-steel remained three-sixty-fourths of an inch permanently out of true. A series of these tests was made, every one of which showed the Electric-Welded Chases to have more than double the resisting power of any others. The tests were all made with a view of determining which of the many samples submitted was best for chase-making. Because of its bright, glossy finish we have named the new material Silver-Gloss Steel. The bars of steel from which the Electric-Welded Steel Chases are made are drawn expressly for us. Being cold-drawn every bar is of the finest texture, and is perfectly true in all dimensions. The

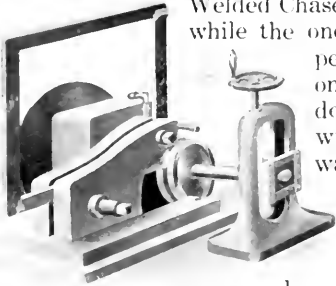

Double Cutter Milling Machine

bars come from the steel mill in all the special sizes and shapes used in chases. The first process of manufacture is the sawing of the bars to lengths suitable for the work in hand, for which purpose a circular saw

which cuts through the hard steel with astonishing ease and speed is used. When they leave the saw the pieces are passed to the man in charge of the welding. He places them in the electric-welder, where they are held tightly against each other by huge, vise-like jaws, which gradually, at the will of the operator, close up as the heat increases, the movement being just sufficient to insure a perfect unblemished joint. This weld being made, the now solid piece is rigidly held in a right angle vise which prevents warping out of shape or springing while cooling. But for small ridges of excess metal at the point where the weld is made, the welding would finish the chase; as it is, all that remains to be done is to cut away the ridge, which work is quickly done by the milling and grinding machines which leave the bars from which the chase is made as smooth and perfect as they were before the welding. The excess of metal formed in the welding process in each inside corner is removed on the punch press (see illustration). If the chase is to be fitted with bars, the special automatic dovetailing machine is brought into play. Printers throughout the country have recognized the value of improved chases for their jobbers and thousands of them have been sold.



Punch Press for squaring out inside of corners

Steel Electric-Welded Book Chases

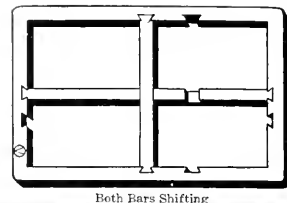
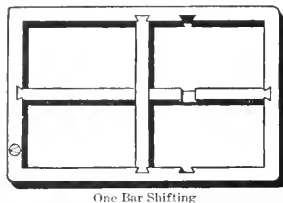
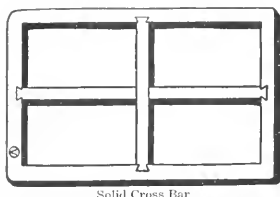

Size No.	Outside Measurement	Measurement Length and Breadth	SIZE OF MATERIAL				Thickness of Bars	Price of Chase With Solid Cross Bars	Price of Chase One Bar Shifting	Price of Chase Both Bars Shifting	
			Width								
			Side Bars	End Bars	Long Cross Bars	Short Cross Bars					
1	17	x21 inches	38 inches	1 inches	1 inches	4 picas	6 picas	5/8 inch	\$8 50	\$9 50	\$10 50
2	20	x25 inches	45 inches	1 1/16 inches	1 1/16 inches	4 picas	6 picas	5/8 inch	8 95	9 95	10 95
3	21	x27 inches	48 inches	1 1/16 inches	1 1/16 inches	4 picas	6 picas	5/8 inch	9 30	10 30	11 30
4	22	x27 inches	49 inches	1 1/16 inches	1 1/16 inches	4 picas	6 picas	5/8 inch	9 40	10 40	11 40
5	22	x28 inches	50 inches	1 1/16 inches	1 1/16 inches	4 picas	6 picas	5/8 inch	9 50	10 50	11 50
6	23	x29 inches	52 inches	1 1/16 inches	1 1/16 inches	4 picas	6 picas	5/8 inch	9 70	10 70	11 70
7	24	x30 inches	54 inches	1 1/16 inches	1 1/16 inches	4 picas	6 picas	5/8 inch	9 95	10 95	11 95
8	25	x30 inches	55 inches	1 1/16 inches	1 1/16 inches	4 picas	6 picas	5/8 inch	10 05	11 05	12 05
9	26	x32 inches	58 inches	1 1/16 inches	1 1/16 inches	4 picas	6 picas	5/8 inch	10 40	11 40	12 40
10	26	x34 inches	60 inches	1 1/16 inches	1 1/16 inches	4 picas	6 picas	5/8 inch	10 60	11 60	12 60
11	25	x35 inches	60 inches	1 1/16 inches	1 1/16 inches	4 picas	6 picas	5/8 inch	10 60	11 60	12 60
12	26	x36 inches	62 inches	1 3/16 inches	1 3/16 inches	4 picas	6 picas	5/8 inch	10 80	11 80	12 80
13	27	x39 inches	66 inches	1 3/16 inches	1 3/16 inches	4 picas	6 picas	5/8 inch	11 25	12 25	13 25
14	29	x41 inches	70 inches	1 3/16 inches	1 3/16 inches	4 picas	6 picas	5/8 inch	11 70	12 70	13 70
15	29	x42 inches	71 inches	1 3/16 inches	1 3/16 inches	4 picas	6 picas	5/8 inch	11 80	12 80	13 80
16	30	x42 inches	72 inches	1 3/16 inches	1 3/16 inches	4 picas	6 picas	5/8 inch	11 90	12 90	13 90
17	32	x44 inches	76 inches	1 3/16 inches	1 3/16 inches	4 picas	6 picas	5/8 inch	12 35	13 35	14 35
18	32	x46 inches	78 inches	1 3/16 inches	1 3/16 inches	4 picas	6 picas	5/8 inch	12 60	13 60	14 60
19	32	x47 inches	79 inches	1 3/16 inches	1 3/16 inches	4 picas	6 picas	5/8 inch	12 70	13 70	14 70
20	33 1/2	x46 inches	79 1/2 inches	1 3/16 inches	1 3/16 inches	4 picas	6 picas	5/8 inch	12 80	13 80	14 80
21	33 1/2	x48 inches	81 1/2 inches	1 3/16 inches	1 3/16 inches	4 picas	6 picas	5/8 inch	13 00	14 00	15 00
22	34	x48 inches	82 inches	1 3/16 inches	1 3/16 inches	4 picas	6 picas	5/8 inch	13 00	14 00	15 00
23	35	x50 inches	85 inches	1 3/16 inches	1 3/16 inches	4 picas	6 picas	5/8 inch	13 35	14 35	15 35
24	36	x52 inches	88 inches	1 3/16 inches	1 3/16 inches	4 picas	6 picas	5/8 inch	13 70	14 70	15 70
25	38	x51 inches	89 inches	1 3/16 inches	1 3/16 inches	4 picas	6 picas	5/8 inch	13 80	14 80	15 80
26	37 1/2	x52 inches	89 1/2 inches	1 3/16 inches	1 3/16 inches	4 picas	6 picas	5/8 inch	13 90	14 90	15 90
27	39	x53 inches	92 inches	1 3/16 inches	1 3/16 inches	4 picas	6 picas	5/8 inch	14 10	15 10	16 10
28	41	x55 inches	96 inches	1 3/16 inches	1 3/16 inches	4 picas	6 picas	5/8 inch	14 55	15 55	16 55
29	43	x56 inches	99 inches	1 3/16 inches	1 3/16 inches	4 picas	6 picas	5/8 inch	14 90	15 90	16 90
30	40	x60 inches	100 inches	1 3/16 inches	1 3/16 inches	4 picas	5 picas	5/8 inch	15 00	16 00	17 00
31	43	x60 inches	103 inches	1 3/16 inches	1 3/16 inches	4 picas	6 picas	5/8 inch	15 35	16 35	17 35
32	43	x63 inches	106 inches	1 3/16 inches	1 3/16 inches	4 picas	6 picas	5/8 inch	15 65	16 65	17 65
33	45	x62 inches	107 inches	1 3/16 inches	1 3/16 inches	4 picas	6 picas	5/8 inch	15 75	16 75	17 75
34	45	x65 inches	110 inches	1 3/16 inches	1 3/16 inches	4 picas	6 picas	5/8 inch	16 10	17 10	18 10
35	47	x66 inches	113 inches	1 3/16 inches	1 3/16 inches	4 picas	6 picas	5/8 inch	16 45	17 45	18 45

The above list of sizes and prices applies also to Brazed Steel Chases—see page 1221.

To Estimate Price of a Book Chase, size not listed

Find price of same size Poster or Skeleton chase and add \$4.00 if solid bars only are wanted. Add \$5.00 if one bar only is to be shifted and \$6.00 if both bars are to be shifted. Unless otherwise ordered, Book chases will be furnished with one bar only shifting. Minimum price of Book chase with both bars shifting, \$10.50. For bar only, add \$1.00 to list; for pair of dovetails add \$1.00 to list; for both add \$2.00 to list. For extra stock charge same as in Poster chases. See Poster list for figuring measurements ending in fractions.

Steel Electric-Welded Folio Chases

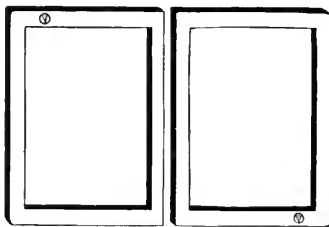

No.	Column Folio	Size of Pair Over All Inches	Size of Each Chase Outside Inches	Measurement Length and Breadth Over All	SIZE OF MATERIAL						Price of Pair			
					Side Bars		End Bars		Back Bars					
					Width	Thick-ness	Width	Thick-ness	Width	Thick-ness				
1	*5	28	x21 3/4	14	x21 3/4	49 3/4 inches	1 1/16 inches	5/8 inch	1 1/16 inches	5/8 inch	1 3/16 inch	5/8 inch	\$ 9 50	
2	5	29 1/2	x22 1/4	14 1/16	x22 1/4	51 3/8 inches	1 1/16 inches	5/8 inch	1 1/16 inches	5/8 inch	1 3/16 inch	5/8 inch	9 90	
3	*6	32 1/2	x24	16 1/4	x24	56 1/2 inches	1 1/16 inches	5/8 inch	1 1/16 inches	5/8 inch	1 3/16 inch	5/8 inch	10 85	
4	6	33 1/2	x24	16 1/16	x24	57 7/8 inches	1 1/8 inches	5/8 inch	1 1/8 inches	5/8 inch	1 3/16 inch	5/8 inch	11 00	
5	*7	38	x25 3/4	19	x25 3/4	63 3/4 inches	1 1/8 inches	5/8 inch	1 1/8 inches	5/8 inch	1 3/16 inch	5/8 inch	12 15	
6	7	38 1/2	x26	19 1/16	x26	64 7/8 inches	1 1/8 inches	5/8 inch	1 1/8 inches	5/8 inch	1 3/16 inch	5/8 inch	12 35	
7	Special	41	x27	20 1/2	x27	68 inches	1 1/8 inches	5/8 inch	1 1/8 inches	5/8 inch	1 3/16 inch	5/8 inch	12 90	
8	*8	42	x28	21	x28	70 inches	1 3/16 inches	5/8 inch	1 3/16 inches	5/8 inch	1 3/16 inch	5/8 inch	13 30	
9	8	43 1/2	x28 1/4	21 1/16	x28 1/4	71 7/8 inches	1 1/4 inches	5/8 inch	1 1/4 inches	5/8 inch	1 3/16 inch	5/8 inch	13 70	
10	*9	47	x30 1/2	23 1/2	x30 1/2	77 1/2 inches	1 1/4 inches	5/8 inch	1 1/4 inches	5/8 inch	1 3/16 inch	5/8 inch	14 80	
11	9	48 3/8	x30 1/4	24 3/16	x30 1/4	78 3/4 inches	1 1/4 inches	5/8 inch	1 1/4 inches	5/8 inch	1 3/16 inch	5/8 inch	15 00	
12	Paper	24x36	40	x26 1/4	20	x26 1/4	66 1/4 inches	1 1/8 inches	5/8 inch	1 1/8 inches	5/8 inch	1 3/16 inch	5/8 inch	12 75

The above list of sizes and prices applies also to Brazed Steel Chases—see page 1221.

To Estimate Price of Pair of Folios, size not listed

Add length and breadth of pair over all in inches and multiply this by nineteen cents per inch. In figuring extra-stock charges, consider each chase separately; charges will be same as for Poster chases. Minimum price of pair folios \$9.00. See Poster list for figuring measurements ending in fractions.

*These sizes carried in stock and will be furnished unless otherwise specified.

Steel Electric-Welded Poster Chases

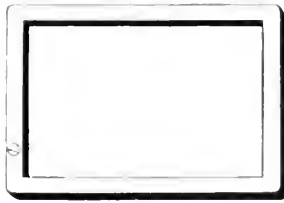

Without Bar

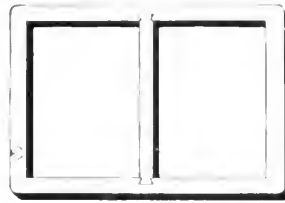

With Bar

No.	Outside Measurement	Measurement Length and Breadth	Side Bars		End Bar		Cross Bar	Depth of Bars	Price of Poster Chase Without Bars	Price of Poster Chase With Bar	
			Width of Bars								
			With Bar	Without Bar	With Bar	Without Bar					
1	17	x21 inches	38 inches	1 1/16 inches	1 1/16 inches	1 1/16 inches	1 1/16 inches	6 picas	3/8 inch	\$1 50	\$6 50
2	20	x25 inches	45 inches	1 1/16 inches	1 1/8 inches	1 1/16 inches	1 1/8 inches	6 picas	3/8 inch	1 95	6 95
3	21	x27 inches	48 inches	1 1/16 inches	1 1/8 inches	1 1/16 inches	1 1/8 inches	6 picas	3/8 inch	3 30	7 30
4	22	x28 inches	50 inches	1 1/16 inches	1 1/8 inches	1 1/16 inches	1 1/8 inches	6 picas	3/8 inch	5 50	7 50
5	24	x30 inches	54 inches	1 1/16 inches	1 1/8 inches	1 1/16 inches	1 1/8 inches	6 picas	3/8 inch	5 95	7 95
6	26	x32 inches	58 inches	1 1/16 inches	1 1/8 inches	1 1/16 inches	1 1/8 inches	6 picas	3/8 inch	6 40	8 40
7	25	x35 inches	60 inches	1 1/16 inches	1 1/8 inches	1 1/16 inches	1 1/8 inches	6 picas	3/8 inch	6 60	8 60
8	27	x39 inches	66 inches	1 3/16 inches	1 1/4 inches	1 3/16 inches	1 1/4 inches	6 picas	3/8 inch	7 25	9 25
9	29	x42 inches	71 inches	1 3/16 inches	1 1/4 inches	1 3/16 inches	1 1/4 inches	6 picas	3/8 inch	7 80	9 80
10	32	x46 inches	78 inches	1 3/16 inches	1 1/4 inches	1 3/16 inches	1 1/4 inches	6 picas	3/8 inch	8 60	10 60
11	32	x47 inches	79 inches	1 3/16 inches	1 1/4 inches	1 3/16 inches	1 1/4 inches	6 picas	3/8 inch	8 70	10 70
12	33 1/2	x48 inches	81 1/2 inches	1 3/16 inches	1 3/8 inches	1 3/16 inches	1 3/8 inches	6 picas	3/8 inch	9 00	11 25
13	34	x50 inches	84 inches	1 3/16 inches	1 3/8 inches	1 3/16 inches	1 3/8 inches	6 picas	3/8 inch	9 25	11 55
14	35	x52 inches	87 inches	1 3/16 inches	1 3/8 inches	1 3/16 inches	1 3/8 inches	6 picas	3/8 inch	9 55	11 55
15	37	x54 inches	91 inches	1 3/16 inches	1 3/8 inches	1 3/16 inches	1 3/8 inches	6 picas	3/8 inch	10 00	12 00
16	39	x53 inches	92 inches	1 3/16 inches	1 3/8 inches	1 3/16 inches	1 3/8 inches	6 picas	3/8 inch	10 10	12 10
17	39	x55 inches	94 inches	1 3/16 inches	1 3/8 inches	1 3/16 inches	1 3/8 inches	6 picas	3/8 inch	10 35	12 35
18	41	x55 inches	96 inches	1 3/16 inches	1 3/8 inches	1 3/16 inches	1 3/8 inches	6 picas	3/8 inch	10 55	12 55
19	43	x60 inches	103 inches	1 7/16 inches	1 1/2 inches	1 7/16 inches	1 1/2 inches	6 picas	3/8 inch	11 35	13 35
20	47	x66 inches	113 inches	1 7/16 inches	1 1/2 inches	1 7/16 inches	1 1/2 inches	6 picas	3/8 inch	12 45	14 45

The above list of sizes and prices applies also to Brazed Steel Chases—see page 1221.

To Estimate Price of a Poster Chase, size not listed

Add length and breadth in inches together to obtain measure. Multiply this measure by eleven cents. For price of News or Poster with bar add \$2.00 to list of Poster without bar. Minimum price of Poster chase \$1.50. For extra bar only, add \$1.00. For extra pair dovetails only, add \$1.00. Measurements ending in fractions to be figured as next full figure. For example: 17x20 3/4 in. = 37 3/4 in., figure 38 in.; 33 1/2 x 45 3/4 = 79 1/4 in., figure 80 in.; 29 3/8 x 10 1/2 in. = 69 7/8 in., figure 70 in.

*Charges for Extra Stock

For each 1/4 inch wider than regular, add for measurement, length, and breadth, 40 inches and smaller	\$0 20
For each 1/4 inch wider than regular, add for measurement, length, and breadth, 41 to 60 inches, inclusive	30
For each 1/4 inch wider than regular, add for measurement, length, and breadth, 61 to 80 inches, inclusive	45
For each 1/4 inch wider than regular, add for measurement, length, and breadth, 81 to 100 inches, inclusive	60
For each 1/4 inch wider than regular, add for measurement, length, and breadth, 101 inches and larger	75
For 3/4 inch thick stock add for measurement, length, and breadth, 40 inches and smaller	60
For 3/4 inch thick stock add for measurement, length, and breadth, 41 to 60 inches inclusive	1 00
For 3/4 inch thick stock add for measurement, length, and breadth, 61 to 80 inches inclusive	1 40
For 3/4 inch thick stock add for measurement, length, and breadth, 81 to 100 inches inclusive	1 80
For 3/4 inch thick stock add for measurement, length, and breadth, 101 and larger	2 20
For extra width and 3/4 inch thick stock, add both of the above charges.	

*Charges for extra stock are based on 1/4 inch increase in width over size of stock regularly used for a chase of similar total length and breadth. If a chase is ordered with side bars 1/16 inch, 1/8 inch or 3/16 inch wider than regular, no extra charge will be made. If extra stock is ordered for three side bars only take three-quarters of the extra charge for that size chase; for two bars one-half, and if only for one bar one quarter.

NOTE.—There will be no extra charge for special size cross bars.

Steel Electric-Welded Job Chases

Owing to the fact that we find no two presses of any platen bed make other than the Chandler & Price which have the same length of bed, or the clamps in the same position, we are compelled to make chases for these presses with lugs long enough that they may be fitted to the press by purchaser, and also make the chase enough wider to cut out, as shown by diagram than fit clamp. To insure a perfect fit on bed of press, we recommend customers to send complete chase with order after ascertaining that sample chase fits correctly.

7x11	\$5 00	12 x18	\$6 50
8x12	5 00	13 x19	6 50
9x13	5 00	14 x20	7 25
10x15	5 50	14 x22	7 25
11x17	5 50	14 1/2 x22	7 25

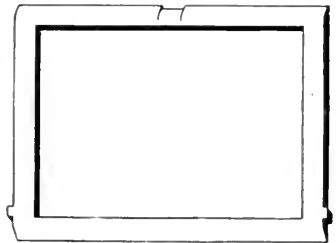

Job Chase with Bar and Job Chase with Roller Bearers

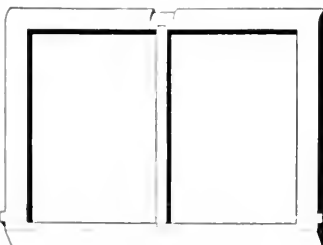

Job Chase with Bar

7 x11	\$7 00
8 x12	7 00
9 x13	7 00
10 x15	7 50
11 x17	7 50
12 x18	8 50
13 x19	8 50
14 x20	9 25
14 x22	9 25
14 1/2 x22	9 25

For each additional bar put in chase add \$2.00 to above prices.



Job Chase with Roller Bearers

Steel Electric-Welded Quarto Chases

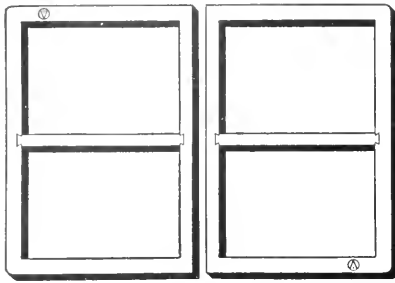

Quarto Chase

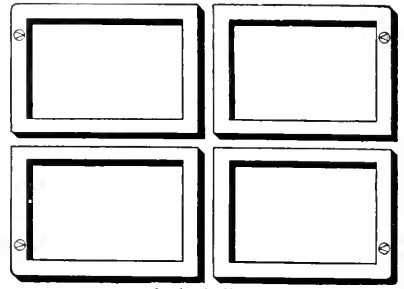

Quadruple Chase

Size No.	Col. Quarto	Size of Pair Over All Inches	Size of Each Chase Outside Inches	Measurement Length and Breadth Over All	SIZE OF MATERIAL								Price of Pair
					Side Bars		End Bars		Back Bars		Cross Bars		
					Width	Thick-ness	Width	Thick-ness	Width	Thick-ness	Width	Thick-ness	
1	*4	35 $\frac{7}{8}$ x24 $\frac{1}{4}$	17 $\frac{5}{16}$ x24 $\frac{1}{4}$	60 $\frac{1}{8}$ inches	1 $\frac{1}{16}$ inches	$\frac{5}{8}$ inch	1 $\frac{1}{16}$ inches	$\frac{5}{8}$ inch	1 $\frac{3}{16}$ inch	$\frac{5}{8}$ inch	6 picas	$\frac{5}{8}$ inch	\$13 40
2	4	36 x24 $\frac{1}{2}$	18 x24 $\frac{1}{2}$	60 $\frac{1}{2}$ inches	1 $\frac{1}{16}$ inches	$\frac{5}{8}$ inch	1 $\frac{1}{16}$ inches	$\frac{5}{8}$ inch	1 $\frac{3}{16}$ inch	$\frac{5}{8}$ inch	6 picas	$\frac{5}{8}$ inch	13 40
3	*5	43 x28 $\frac{1}{2}$	21 $\frac{1}{2}$ x28 $\frac{1}{2}$	71 $\frac{1}{2}$ inches	1 $\frac{3}{8}$ inches	$\frac{5}{8}$ inch	1 $\frac{3}{8}$ inches	$\frac{5}{8}$ inch	1 $\frac{3}{16}$ inch	$\frac{5}{8}$ inch	6 picas	$\frac{5}{8}$ inch	15 85
4	5	44 $\frac{1}{8}$ x29 $\frac{1}{2}$	22 $\frac{1}{16}$ x29 $\frac{1}{2}$	73 $\frac{3}{8}$ inches	1 $\frac{3}{8}$ inches	$\frac{5}{8}$ inch	1 $\frac{3}{8}$ inches	$\frac{5}{8}$ inch	1 $\frac{3}{16}$ inch	$\frac{5}{8}$ inch	6 picas	$\frac{5}{8}$ inch	16 30
5	*6	46 x32 $\frac{1}{2}$	23 x32 $\frac{1}{2}$	78 $\frac{1}{2}$ inches	1 $\frac{3}{4}$ inches	$\frac{5}{8}$ inch	1 $\frac{3}{4}$ inches	$\frac{5}{8}$ inch	1 $\frac{3}{16}$ inch	$\frac{5}{8}$ inch	6 picas	$\frac{5}{8}$ inch	17 40
6	*6	47 x32 $\frac{1}{2}$	23 $\frac{1}{2}$ x32 $\frac{1}{2}$	79 $\frac{1}{2}$ inches	1 $\frac{3}{4}$ inches	$\frac{5}{8}$ inch	1 $\frac{3}{4}$ inches	$\frac{5}{8}$ inch	1 $\frac{3}{16}$ inch	$\frac{5}{8}$ inch	6 picas	$\frac{5}{8}$ inch	17 60
7	6	47 $\frac{3}{8}$ x34	23 $\frac{1}{16}$ x34	81 $\frac{3}{8}$ inches	1 $\frac{3}{4}$ inches	$\frac{5}{8}$ inch	1 $\frac{3}{4}$ inches	$\frac{5}{8}$ inch	1 $\frac{3}{16}$ inch	$\frac{5}{8}$ inch	6 picas	$\frac{5}{8}$ inch	18 05
8	*7	51 x37 $\frac{1}{2}$	25 $\frac{1}{2}$ x37 $\frac{1}{2}$	88 $\frac{1}{2}$ inches	1 $\frac{5}{16}$ inches	$\frac{5}{8}$ inch	1 $\frac{5}{16}$ inches	$\frac{5}{8}$ inch	1 $\frac{3}{16}$ inch	$\frac{5}{8}$ inch	6 picas	$\frac{5}{8}$ inch	19 60
9	7	52 $\frac{1}{8}$ x39	26 $\frac{1}{16}$ x39	91 $\frac{1}{8}$ inches	1 $\frac{5}{16}$ inches	$\frac{5}{8}$ inch	1 $\frac{5}{16}$ inches	$\frac{5}{8}$ inch	1 $\frac{3}{16}$ inch	$\frac{5}{8}$ inch	6 picas	$\frac{5}{8}$ inch	20 25
10	*8	56 $\frac{1}{8}$ x43 $\frac{1}{2}$	28 $\frac{1}{16}$ x43 $\frac{1}{2}$	99 $\frac{3}{8}$ inches	1 $\frac{5}{16}$ inches	$\frac{5}{8}$ inch	1 $\frac{5}{16}$ inches	$\frac{5}{8}$ inch	1 $\frac{3}{16}$ inch	$\frac{5}{8}$ inch	6 picas	$\frac{5}{8}$ inch	22 00

The above list of sizes and prices applies also to Brazed Steel Chases—see page 1221

To Estimate Price of Pair of Quartos, size not listed

Add length and breadth of pair over all in inches and multiply this sum by twenty-two cents per inch. In figuring extra-stock charges, consider each chase separately; charges will be same as for Poster chases. Minimum price for pair of Quartos, \$12.00. See Poster list for figuring measurements ending in fractions.

*These sizes carried in stock, and will be furnished unless otherwise specified.

Steel Electric-Welded Quadruple Chases

Size No.	Col. Quarto	Size of Set Over All Inches	Size of Each Chase Outside Inches	Measurement Length and Breadth Over All	SIZE OF MATERIAL								Price for Set of Four
					Side Bars		Inside End Bars		Outside End Bars		Back Bars		
					Width	Thick-ness	Width	Thick-ness	Width	Thick-ness	Width	Thick-ness	
1	*5	28 x42 $\frac{1}{2}$	14 x21 $\frac{1}{4}$	70 $\frac{1}{2}$ inches	1 $\frac{1}{16}$ inches	$\frac{5}{8}$ inch	1 $\frac{3}{16}$ inch	$\frac{5}{8}$ inch	1 $\frac{1}{16}$ inches	$\frac{5}{8}$ inch	1 $\frac{3}{16}$ inch	$\frac{5}{8}$ inch	\$19 90
2	*6	32 $\frac{1}{2}$ x47	16 $\frac{1}{4}$ x23 $\frac{1}{4}$	79 $\frac{1}{2}$ inches	1 $\frac{1}{16}$ inches	$\frac{5}{8}$ inch	1 $\frac{3}{16}$ inch	$\frac{5}{8}$ inch	1 $\frac{1}{16}$ inches	$\frac{5}{8}$ inch	1 $\frac{3}{16}$ inch	$\frac{5}{8}$ inch	22 40
3	*7	38 x50 $\frac{1}{2}$	19 x25 $\frac{1}{4}$	88 $\frac{1}{2}$ inches	1 $\frac{3}{8}$ inches	$\frac{5}{8}$ inch	1 $\frac{3}{16}$ inch	$\frac{5}{8}$ inch	1 $\frac{3}{8}$ inches	$\frac{5}{8}$ inch	1 $\frac{3}{16}$ inch	$\frac{5}{8}$ inch	24 90

The above list of sizes and prices applies also to Brazed Steel Chases—see page 1221

To Estimate Price of a Set of Quadruples, size not listed

Add length and breadth in inches of set over all and multiply by twenty-eight cents per inch. In figuring extra-stock charges consider each chase separately; charges will be same as for Poster chases. Minimum price for set of Quadruples, \$18.00. See poster list for figuring measurements ending in fractions.

*These sizes carried in stock, and will be furnished unless otherwise specified.

Steel Electric-Welded Electrotype Chases

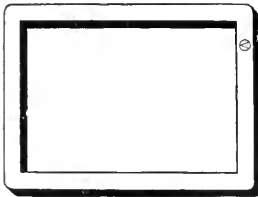

Size Number	Outside Measurement	Inside Measurement	SIZE OF MATERIAL			Price of Chase
			Width		Thickness of Bars	
			Side Bars	End Bars		
*1	13x17 inches	10x14 inches	1 $\frac{1}{2}$ inches	1 $\frac{1}{2}$ inches	$\frac{5}{8}$ inch	\$4 90
*2	15x21 inches	12x18 inches	1 $\frac{1}{2}$ inches	1 $\frac{1}{2}$ inches	$\frac{5}{8}$ inch	4 90

The above list of sizes and prices applies also to Brazed Steel Chases—see page 1221

*Compute cost of Electrotype chases same as Poster, adding for extra stock. Minimum price \$4.90. See Poster list for figuring measurements ending in fractions.

Steel Electric-Welded Stereotype Chases

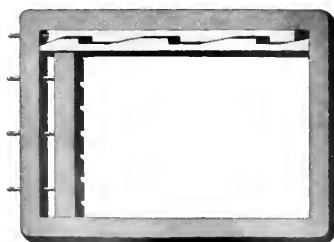

Steel Electric-Welded Stereotype Chase

These Stereotype chases are made in the most accurate manner, exactly type high, perfectly square and true. The side lock-up screw is attached to the side stick with a collar in such a manner so as to enable the operator to lock up and unlock the form with the wrench, moving the side stick backward and forward instantly, thus saving much time and avoiding the use of shooting stick and mallet, and consequent injury to the side stick.

6 Column	\$36 00	9 Column	\$42 00
7 Column	38 00	Blank Column	3 50
8 Column	40 00	Lock-up Wrenches for Stereotype Chases	2 00

*NOTE—One wrench is furnished gratis with each set of four stereotype chases. If less than four stereotype chases are ordered wrenches are not supplied except at regular price. Chase without side or foot sticks or screws, one-half of list price of complete chase quoted above.

Side Sticks, per pair	\$12 00	Foot Sticks, each	\$3 50
Side Sticks, one only	7 50	Foot Stick Screws, each	40
Side Stick Screws, each	80		

Steel Electric-Welded Heading Chases

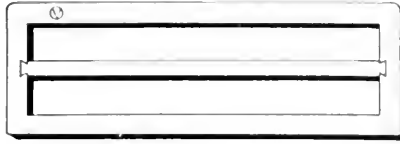

FIG. 1. MATERIAL

No.	Size of Chase Outside With Bar Inches	Size of Chase Inside Inches	Measurement Length and Breadth	Width of Bar				Cross Bar	Height of Bar	Price of Chase Without Bar	Price of Chase With Bar
				Side Bars		End Bars					
				With Bar	Without Bar	With Bar	Without Bar				
1	8 x 19	6 x 17	27 inches	1 inch	1 1/16 inches	1 inch	1 1/16 inches	6 picas	3/8 inch	\$1 50	\$6 50
2	10 x 23	8 x 21	33 inches	1 inch	1 1/16 inches	1 inch	1 1/16 inches	6 picas	3/8 inch	1 50	6 50
3	10 1/2 x 30 1/2	8 x 28	40 1/2 inches	1 1/16 inches	1 1/8 inches	1 1/16 inches	1 1/8 inches	6 picas	3/8 inch	4 50	6 50

The above list of sizes and prices applies also to Brazed Steel Chases—see below

Estimate Price of Heading Chase, size not listed, same as Poster Chase

Minimum price of Heading Chase without bar, \$1.50. For bar and pair of dovetails add \$2.00. Unless otherwise ordered, cross bar Heading chases will be furnished. Figure extra stock same as in Poster chases. See Poster List for figuring measurements ending in fractions.

McGreal Combination Printer's Chase

Every printer knows the advantage of having an adequate chase equipment in order to save time and money. In a plant equipped with McGreal Chases there is always on hand chases of the proper size to fit the form. A perfect lock-up is assured in the shortest time, and "springy" forms are avoided.

The McGreal Chase is made from bars of high grade cold drawn steel, outside bars one and one-half inches wide by five-eighths of an inch thick; shifting cross bars three-quarters of an inch wide by five-eighths thick. Each piece is perfectly interchangeable with every other piece. Any two pairs and shifting cross bars necessary to form a chase can be put together and taken apart in a few seconds. They are perfectly true, and resist one-third more pressure than the old wrought iron chase. The smallest size is four inches in length, and each successive size is two inches longer up to twenty-eight inches.

Prices of McGreal Combination Printer's Chase

Plain Bars, Each		Plain Bars, Each	
4-inch lengths	\$1 60	35-inch lengths	\$3 80
6-inch lengths	1 70	35 1/2-inch lengths	3 80
8-inch lengths	1 80	37 1/2-inch lengths	3 90
10-inch lengths	1 90	38 3/4-inch lengths	4 00
12-inch lengths	2 10	39 3/4-inch lengths	4 00
14-inch lengths	2 20	42-inch lengths	4 30
16-inch lengths	2 30	42 3/4-inch lengths	4 45
18-inch lengths	2 40	43 1/2-inch lengths	4 45
20-inch lengths	2 50	44-inch lengths	4 45
22-inch lengths	2 80	44 1/2-inch lengths	4 60
23-inch lengths	2 90	46-inch lengths	4 60
24-inch lengths	2 90	46 3/4-inch lengths	4 75
25-inch lengths	3 00	48 3/4-inch lengths	4 90
26-inch lengths	3 00	49 1/4-inch lengths	4 90
28-inch lengths	3 10	51 1/4-inch lengths	5 20
29 1/2-inch lengths	3 20	52 1/4-inch lengths	5 35
32-inch lengths	3 60	58 3/4-inch lengths	5 80
32 3/4-inch lengths	3 70	61 1/4-inch lengths	6 10
34 3/4-inch lengths	3 80	62 1/4-inch lengths	6 25

Above are inside measurements. Example: two twenty-four-inch pieces and two thirty-six-inch pieces make a chase 24x36, inside measurement.

A Few Combinations

2-size lengths make	1-size chase	9-size lengths make	36-size chases
3-size lengths make	3-size chases	10-size lengths make	45-size chases
4-size lengths make	6-size chases	11-size lengths make	55-size chases
5-size lengths make	10-size chases	12-size lengths make	66-size chases
6-size lengths make	15-size chases	13-size lengths make	78-size chases
7-size lengths make	21-size chases	14-size lengths make	91-size chases
8-size lengths make	28-size chases	15-size lengths make	105-size chases

American Brazed Steel Chases

American Brazed Steel Chases are made from high grade cold drawn steel, mill to a perfectly square and even finish and beveled so as to insure perfect uniformity. They are constructed with an indestructible overlapped countersunk corner joint which cannot be broken by any ordinary usage. The illustration shows the Sledge Hammer Test. The cut on the left shows the brazed corner when subjected to a blow of a twenty pound sledge, chase lying flat on anvil. The right hand cut shows test made with section of chase stuck upright in anvil and struck so as to break the corner if possible. The lower cut shows actual condition of the All Steel Chase after the test. American Brazed Steel Chases are uniform in size, and it has been demonstrated that they are undoubtedly the strongest chases

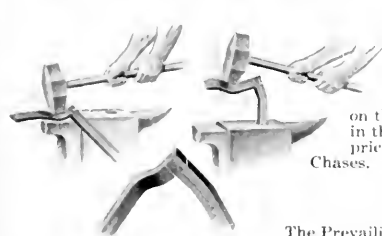

on the market. Thousands of them are in daily use in many of the best printing offices in the country, and the demand for them is constantly increasing. The list of sizes and prices quoted on Steel Electric Welded Chases also apply to American Brazed Steel Chases. Write for circular and net selling prices.

Prevailing Beveled Edge Bright Steel Chases

The Prevailing Beveled Edge Bright Steel Chases for job presses are also made of cold drawn steel and brazed in the same manner as

the American Brazed Steel Chases, and in addition possess the advantage of having indestructible overlapped countersunk corners.

List Prices of Prevailing Beveled Edge Bright Steel Chases

Size Press	Inside Chase	Price	Size Press	Inside Chase	Price
7x11	7 x 11	\$2 50	12 x 18	12 1/2 x 18 1/4	\$3 50
8x12	8 x 12	2 50	13 x 19	13 1/2 x 19 1/4	3 50
9x13	9 x 13	2 50	14 x 20	14 1/2 x 20 1/2	4 00
10x15	10 1/2 x 15 1/4	2 75	14 x 22	14 1/2 x 22 1/4	4 25
11x17	11 1/2 x 17 3/4	3 00	15 x 22 1/2	15 x 22 1/4	4 25

Chases for C. & P. Gordon Presses

Inside Measure	Cast Iron	Cast Iron Screw	Cast Steel	Steel Screw	Spider
7 x 11 in	\$1 00	\$1 50	\$2 50	\$1 00	\$1 00
8 x 12 in	1 25	1 90	2 50	1 50	1 25
10 x 15 in	1 50	2 25	2 75	6 75	1 50
12 x 18 in	2 00	3 00	3 50	8 00	2 00
14 x 20 in	2 50	3 75	4 00	8 50	2 50
14 1/2 x 22 in	3 00	4 50	4 25	9 00	3 00
13x19 in, special, for 12x18 press,	3 50				6 00

Metal Leads and Slugs

To the user of American Leads and Slugs it is not necessary to say a word about quality. These leads and slugs are cast in a continuous strip, are shaved, smoothly finished by rollers and come out absolutely accurate to point bodies. They are cast from a uniform quality of exceptionally durable metal, the formula of which is kept at a certain standard from year to year regardless of cost of raw material. This lead alloy is the result of an experiment extending over several years, and is made up of new metals, no inferior scrap or old metal being used.

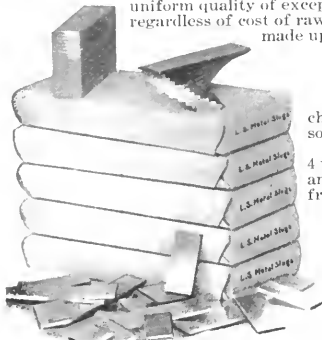

Labor Saving Slugs

Labor-Saving Leads and Slugs

Our Labor-Saving Leads and Slugs are accurately trimmed to measure on improved machinery. The leads pass between two rapidly revolving trimming heads which can be adjusted so finely that the highest standard of accuracy is secured.

A twenty-five pound font of 2-point labor-saving leads is composed of sixty-two pieces each, 4 to 25 ems inclusive. Other sized fonts in proportion. Special scheme fonts can be made up to any desired scheme. Packages of five pounds are made up and carried in stock in all lengths from 4 to 36 ems. Other lengths are cut to order, but can be obtained on short notice.

American Line Leads for Rapid Justification

These are special fonts of Labor-Saving Leads, cut from 1 em to 20 ems for use in lining type cast on American Line or the lining system of other foundries. These fonts are cut from 1 point, 2 point and 3 point leads, and put up as follows:

1 Point Brass Leads—Font contains seven pieces each 1 to 10 ems graduated by 6 points; seven pieces each 11 to 14 ems graduated by 12 points; and five pieces each 15 to 20 ems graduated by 12 points. Font measures about 260 inches.

Price, without Case \$1 00
Price, with Midget Case 1 60

2 Point Metal Leads—Font contains twelve pieces 1 to 10 ems graduated by 6 points; also twelve pieces each 11 to 20 ems graduated by 12 points. Font weighs 4 pounds.

Price, without Case \$1 00
Price, with Midget Case 1 60

3 Point Metal Leads—Font contains eight pieces each 1 to 10 ems graduated by 6 points; also eight pieces each 11 to 20 ems graduated by 12 points. Font weighs 4 pounds.

Price, without Case \$1 00
Price, with Midget Case 1 60

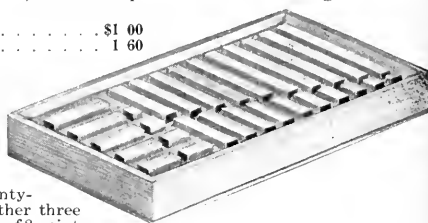

Midget Labor-Saving Case

The Midget Labor-Saving Case

The Midget Labor-saving Case has twenty-nine compartments and will hold either three fonts of 1 point, or one font each of 2 point or 3 point. Size of case, 4³/₈x8¹/₂ inches.

The Midget Case filled with short lengths of leads is an exceedingly handy thing for compositors, and will save many unnecessary trips to the main lead and slug case.

Price of Case \$0 60

Short Leads and Slugs

These handy little cases speak for themselves. They are almost essential in the equipment of every compositor. Each font contains 1, 2, 3 and 6 point thicknesses cut to one of the bodies shown below:

Prices of Short Leads and Slugs

18 point, including box	\$1 50	48 point, including box	\$1 50
24 point, including box	1 50	60 point, including box	1 50
36 point, including box	1 50		

List Prices of Leads and Slugs

	2 point and thicker	1 1-2 point	1 1-5 point	1 point
In Strips	\$0 16	\$0 24	\$0 30	\$0 40
Labor-Saving Fonts	20	30	37	48
Cut 7 ems and longer	20	30	37	48
Cut 2 to 6 ¹ / ₂ ems	35	44	54	68

Leads and Slugs in Strips, 2, 3, 6 and 12 point are packed one hundred and fifty pounds to the box, and are sold at slightly lower prices for this quantity.

2 point and thicker, 12 lb. labor-saving font \$2 40
2 point and thicker, 25 lb. labor-saving font 5 00

These standard size fonts are carried in stock. Every office should be liberally supplied with 2 point leads and 6 point slugs.

Angular Quads

Angular Quads were introduced by the American Type Founders Company and will be found a great convenience when setting rules and lines at an angle. There will always come a time when these Quads are needed and it will pay printers to have a font ready. Angular Quads are cast in type molds and range in sizes from twelve points to seventy-two points. Each font contains twenty-eight pieces, conveniently assorted to meet ordinary requirements, but when additions are required, sorts may be added at the prices listed.



Angular Quads—12, 18, 24, 36, 48, 60 and 72 Point

List Prices of Angular Quads

Angular Quads, complete font of four of each size \$1 50

List Price per set of four of each size

12 Point . . \$0 20	24 Point . . \$0 20	48 Point . . \$0 30	72 Point . . \$0 40
18 Point . . 20	36 Point . . 25	60 Point . . 35	

Circular Quads

We can now offer a more complete font of Circular Quads than heretofore. The font is made up of ninety-six pieces, cast in the following lengths: sixteen pieces of twelve picas, sixteen pieces of nine picas, sixteen pieces of seven picas, sixteen pieces of six picas, sixteen pieces of five picas and sixteen pieces of three picas. The various pieces are quickly adjusted with quads and leads to make the required circles. For label and similar work Circular Quads quickly pay for themselves.

The accompanying illustration shows some of the pieces in the font of Circular Quads considerably reduced in size.

These quads are accurately cast.



Circular Quads (Illustration slightly reduced)

Circular Quads, put up in a neat box, price per font \$3 50

Labor-Saving Metal Furniture

This popular design of metal furniture is cast from high grade metal and accurately finished with improved machinery.

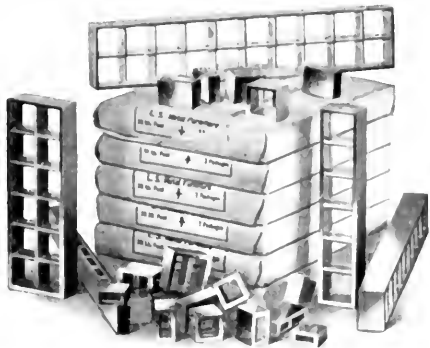

Labor-Saving Metal Furniture

Made in 2, 3, 4, 5, 6, 8 and 10 cm widths, and 1, 5, 6, 8, 10, 15, 20, 25, 30, 40 and 50 cm lengths. The twenty-five pound font includes sizes from 2x4 to 10x25 cms. Fonts fifty pounds and larger include sizes from 2x4 to 10x50 cms.

Capacity of Fonts

A twenty-five pound font of Improved Metal Furniture as regularly assorted covers 235 square inches—about 9½ square inches to the pound. An assortment of smaller lengths, up to 10x12, will cover about 6½ square inches to the pound.

List Prices of Labor-Saving Metal Furniture

12 pound font	\$3 60	50 pound font	\$15 00
25 pound font	7 50	100 pound font	28 00

Quantity Prices of Labor-Saving Metal Furniture

Regular Scheme Fonts and Sorts larger than 6x6 cms.

Less than 100 Lbs.	100 Lbs.	500 Lbs.	1000 Lbs.	2000 Lbs.
\$0 30	\$0 28	\$0 26	\$0 21	\$0 22

Sorts 6x6 cms and smaller.

Less than 5 Lbs.	5 Lbs.	25 Lbs.	50 Lbs.	100 Lbs.
\$0 50	\$0 46	\$0 41	\$0 36	\$0 31

Labor-Saving Quotation Furniture

The well known pattern with closed bottom which presents smooth surface for electrotyping and stereotyping is cast from



Labor-Saving Quotation Furniture

high grade metal and accurately finished. Regular fonts contain 2, 3, and 1 cm widths, and 4, 8, 12, 16 and 20 cm lengths. Can also be cast to order in 2, 3 and 4 cm widths and practically any lengths up to 80 cms.

List Prices of Labor-Saving Quotation Furniture

12 pound font	\$3 60	50 pound font	\$15 00
25 pound font	7 50	100 pound font	28 00

A twenty-five pound font of Quotation Furniture, regular assortment, covers 162 inches, and smaller lots practically the same proportion.

Quantity Prices of Labor-Saving Quotation Furniture

Regular Scheme Fonts and Sorts larger than 6x6 cms.

Less than 100 Lbs.	100 Lbs.	500 Lbs.	1000 Lbs.	2000 Lbs.
\$0 30	\$0 28	\$0 26	\$0 21	\$0 22

Sorts 6x6 cms and smaller.

Less than 5 Lbs.	5 Lbs.	25 Lbs.	50 Lbs.	100 Lbs.
\$0 50	\$0 46	\$0 41	\$0 36	\$0 31

Corner Quads—Brass and Metal

Better junctions of mitered corners can be obtained by using Corner Quads, as their use prevents rules from slipping. Made in both brass and metal.

For prices see page 1111

Labor-Saving Railroad or Reversible Furniture

Especially designed for margins between pages and general blanking out. Accurately finished in 2, 3, 1, 5, 6, 8, 9 and

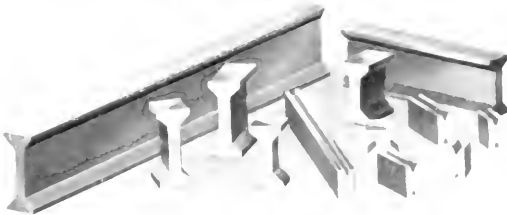

Labor-Saving Railroad or Reversible Furniture

10 cm widths and cut any desired length by points, 12 point cms or inches up to 16½ inches or 99 cms.

Approximate Weight Per Inch

2 cms wide	1¼ ounces	6 cms wide	3½ ounces
3 cms wide	1¾ ounces	8 cms wide	3½ ounces
1 cms wide	2½ ounces	9 cms wide	3½ ounces
5 cms wide	2½ ounces	10 cms wide	3½ ounces

A twenty-five pound font of Railroad Furniture covers 150 square inches and is cut same widths as Improved, and any length up to 16½ inches equal to 99 cms. Especially suited for margins in book forms.

List Prices of Labor-Saving Railroad Furniture

12 pound font	\$3 60	50 pound font	\$15 00
25 pound font	7 50	100 pound font	28 00

Quantity Prices of Railroad Labor-Saving Furniture

Regular Scheme Fonts and Sorts larger than 6x6 cms.

Less than 100 Lbs.	100 Lbs.	500 Lbs.	1000 Lbs.	2000 Lbs.
\$0 30	\$0 28	\$0 26	\$0 21	\$0 22

Sorts 6x6 cms and smaller.

Less than 5 Lbs.	5 Lbs.	25 Lbs.	50 Lbs.	100 Lbs.
\$0 50	\$0 46	\$0 41	\$0 36	\$0 31

Labor-Saving Quotation Quads

These quads are cast on regular type casting machines in the following sizes:

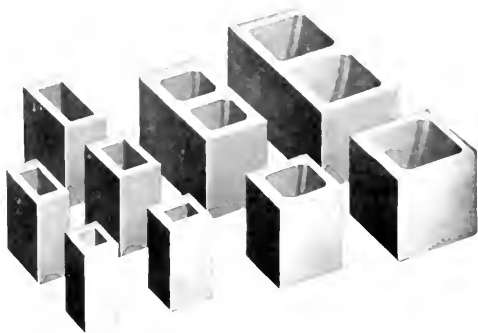

Labor-Saving Quotation Quads

18x24 points, 18x36 points, 24x24 points, 24x36 points, 24x18 points, 36x36 points, 36x18 points, 36x72 points, 48x18 points and 48x36 points.

List Price, per lb.	\$0 50
5 lbs. and over, per lb.	\$0 46
25 lbs. and over, per lb.	41
100 lbs. and over, per lb.	34

Copper Alloy Take Slugs

These are the only Take Slugs cast in a mold in extra durable copper alloy metal. They are better, cheaper and more durable than electrotype slugs. Any number from 1 to 100, but in one style of figure only.

Copper Alloy Take Slug, price each \$0 15

Electrotyped Take Slugs

Electrotyped Take Slugs, with word, letter or figure, first one of kind, price each	\$0 40
Duplicates as per Chicago Electrotype Scale list, per running inch, with thirty cents minimum charge	15

Foot Slugs—Brass and Metal

Brass Foot Slugs, 12 Point	Single Column	Double Column
Brass Foot Slugs, 18 Point	\$0 15	\$0 25
Brass Foot Slugs, 24 Point	20	30
Metal Foot Slugs, 12 Point	25	35
Metal Foot Slugs, 18 Point	01	06
Metal Foot Slugs, 24 Point	05	07
	06	08

Wesel Steel-Clad Safety Benzine Cans

These Cans are practically indestructible. They can be abused to almost any extent without impairing their usefulness, or springing a leak.

They are being used by many of the best printers in the United States and are giving results.



Wesel Steel-Clad Safety Benzine Cans

Pint Can, coppered
 Quart Can, coppered
 Extra Patent Stoppers, each

\$0 90
 1 20
 40

Success Safety Benzine Cans

Success Cans are made of brass and are strong and durable. They have recently been strengthened fifty per cent to conform to the more exacting demands of the Underwriters. Hundreds of thousands are in use.

The line of Benzine Cans shown here represents the best of their kind which have been made up to the present time.



Success Safety Benzine Cans

Prices Success Safety Benzine Cans

Half Pint Can \$0 60
 One Pint Can 70
 One Quart Can 85
 Two Quart Can 1 50

Benzine Brushes

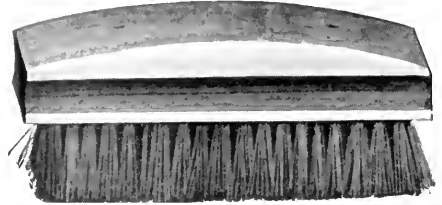

Benzine Brush

Benzine Brush, all bristle, oval back \$0 40
 Benzine Brush, all bristle, with handle 40
 Medium bristle 50
 Large bristle 75

Benzine Brush with Handle



Benzine Brush with Handle

Price \$0 40

Boston Benzine Brush

For Half-tone Cuts

To avoid all chances of scratching half-tones with rags, pins, buttons, or hooks and eyes, it is advisable to use a



Boston Benzine Brush

Boston Benzine Brush, which will wear for six months under ordinary usage.

Price \$0 25

Imperial Non-Explosive Benzine Cans



One Quart Size

These Cans meet the requirements of the Board of Underwriters as a protection to life and property. Explosion and fire are often caused when vapors are allowed to escape from benzine, gasoline, naphtha or similar fluids. With these cans all such danger is practically eliminated. They have self-closing tops and are made in four sizes.

Prices of Imperial Non-Explosive Benzine Cans

One quart size \$1 50
 Two quart size 1 75
 One gallon size 1 85
 Two gallon size 2 50
 Five gallon size 5 00

Flicker Combined Benzine Can and Brush

In the Flicker Benzine Can and Brush, as its name implies, the can and brush are combined, thus making it into a quick and handy article. The can is filled with benzine and the act of using it permits a certain quantity of benzine, sufficient for cleaning the type, to pass through a small tube into the brush. It is economical, as by its use both benzine and time are saved, sufficient to cover its cost in a few days. A new brush can be attached at any time.

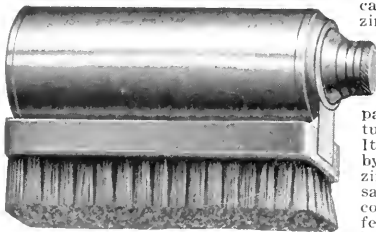

Flicker Combined Benzine Can and Brush

Flicker Combined Benzine Can and Brush, each \$1 25
 Extra Bristle Brush 75

Solid Back Lye Brushes

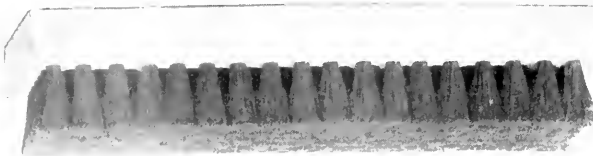

Solid Back Lye Brush

No. 20, medium, all bristle, per dozen \$5 00 Each 50
 No. 30, large, all bristle, per dozen 7 00 Each 75
 No. 8, medium Tampico, per dozen 3 50 Each 40
 No. 9, large Tampico, per dozen 4 50 Each 50

Stereotype Beating Brushes

These brushes are of the best material and very strongly built.

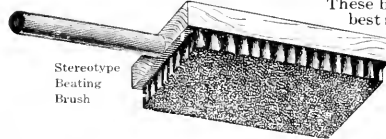

Stereotype Beating Brush

Prices
 No. 120 \$5 00
 No. 121 6 00
 No. 122 7 00

Bronzing Pad



Bronzing Pad

The bronzing pad has become an article of necessity in the pressroom as it effects economy in time and bronze, and insures clean work. The bronze is received in a cavity on the top (closed tightly with a slide) and is delivered through valves, which are opened and closed by the thumbscrew at the end, which regulates the flow of bronze into a sieve in the midst of fine fur. The bronze is fed only where, and just when it is wanted on the work, and is not scattered over the table.

Large, 2¹/₂ x 6 inches \$2 50
 Small, for light work, 2¹/₂ inches square 1 50

Bronzing Mitten

These Mittens are made of sheep's wool with back of strong cloth. They are convenient for bronzing and are made impervious to bronze.

Price, each \$0 50

The Robinson Improved Printer's Mallets

There is many a little printing office accessory, the utility of which has become so manifest and the article so generally used that the wonder is the idea did not suggest itself sooner. This process will repeat itself in connection with the Robinson Improved Printer's Mallet, the illustration of which we show here. The hammer head of this Mallet is oval, or egg shaped. A blow struck upon the planer is always a square blow, which is a most important consideration when striking a proof. It is not possible to strike a glancing blow with this Mallet. There are no sharp corners to wear away, slip or mar the delicate type faces.



Robinson Improved Mallet

Each single mallet is packed in a paper carton, properly labeled as to contents. A trial order for one of these improved mallets will convince any printer of its superiority over other mallets.

This mallet stands on end when not in use and in correct position to be quickly and rapidly grasped by the stone man at times when a second counts in the lock-up.

The Robinson Improved Mallet is made in five sizes of lignumvitae and hickory. The best selected stock is used and the surface is smooth and polished, finished with shellac.



List Prices and Dimensions of the Robinson Improved Mallets

No. 1—Ball, 1 1/2 x 4 inches—full length, 9 1/2 inches	Lignumvitae	\$1 50	Hickory	\$1 00
No. 2—Ball, 3 7/8 x 3 1/4 inches—full length, 8 1/2 inches	Lignumvitae	1 30	Hickory	85
No. 3—Ball, 3 1/2 x 3 1/4 inches—full length, 8 inches	Lignumvitae	1 10	Hickory	70
No. 4—Ball, 3 1/8 x 2 3/4 inches—full length, 7 3/4 inches	Lignumvitae	90	Hickory	60
No. 5—Ball, 2 3/4 x 2 1/4 inches—full length, 6 3/4 inches	Lignumvitae	70	Hickory	50

Wooden Mallets

These Wooden Mallets are of attractive shapes; made of thoroughly well seasoned and selected stock; the handles are screwed in and all are finished in oil. The lignumvitae mallets are especially recommended as they are much heavier than hickory mallets.



Hickory Mallet

List Prices of Wooden Mallets

No. 1, Hickory, small, size 2 1/2 x 1 1/2 in., weight ten ounces.	Hickory Mallet	\$0 25
No. 2, Hickory, medium, size 3 x 5 inches, weight one pound.	Hickory Mallet	\$0 30
No. 3, Hickory, large, size 3 1/2 x 6 inches, weight one and one-half pounds.	Hickory Mallet	\$0 40
No. 4, Lignumvitae, size 1 1/2 x 2 1/2 inches, weight five ounces.	Lignumvitae Mallet	30
No. 5, Lignumvitae, size 1 7/8 x 3 inches, weight seven ounces.	Lignumvitae Mallet	40
No. 6, Lignumvitae, size 2 1/4 x 3 1/2 inches, weight ten ounces.	Lignumvitae Mallet	50
No. 7, Lignumvitae, size 3 x 5 inches, weight one and one-half pounds.	Lignumvitae Mallet	60
No. 8, Lignumvitae, size 3 1/2 x 5 1/2 inches, weight two and one-quarter pounds.	Lignumvitae Mallet	75
No. 9, Wood, iron bound, weight one and one-half pounds.	Wood, iron bound Mallet	1 00

Rawhide Bound Mallets

These Rawhide Bound Mallets are extremely durable, finely finished and handsomely made. The hide-facing cushions, with which each end is covered give a spring to each blow and prevent the jarring of the muscles. They positively will not split.

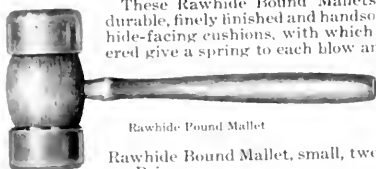

Rawhide Bound Mallet

Rawhide Bound Mallet, small, two-inch face.	\$0 60
Rawhide Bound Mallet, medium, two and one half inch face.	75
Rawhide Bound Mallet, large, three-inch face.	1 00

All Rawhide Mallets

The All Rawhide Mallets, as their name implies, have heads that are made throughout of rawhide, specially treated, formed into their shape by means of hydraulic pressure and kept in shape by waterproof adhesives. They will be found serviceable mallets for the printers' use. Each handle, which is of wood, is firmly fastened into the head. These mallets are well made, strong, durable and handsome in appearance. The heads are so made that they will not split.

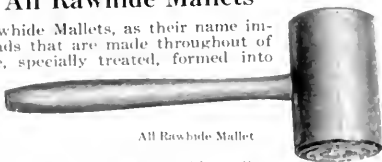

All Rawhide Mallet

All Rawhide Mallet, No. 4, 2 x 3 1/2 inches, weight ten ounces.	\$0 75
All Rawhide Mallet, No. 10, 2 x 3 1/2 inches, weight twenty-four ounces (loaded).	90
All Rawhide Mallet, No. 5, 2 1/2 x 3 1/4 inches, weight twenty-one ounces.	1 50

Planers

These Planers are all made of the best selected rock maple and they will hold their surface much longer than cheaper woods. These Maple planers are durable.

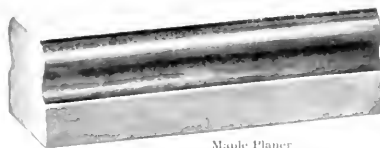

Maple Planer

Maple Planer, small, size 3 1/4 x 6 inches, weight one and one-quarter pounds.	List price	\$0 25
Maple Planer, large, size 3 1/2 x 8 inches, weight one and three-quarter pounds.	List price	30
Maple Planer, leather top, 3 1/2 x 8 inches, weight two pounds.	List price	40

Proof Planers

These Proof Planers are all made of maple, carefully faced with very high priced, closely woven, firm and durable felt. They will produce sharp, clear proofs on being struck lightly; they are so made that there need not be the slightest fear of injuring the type in any way.

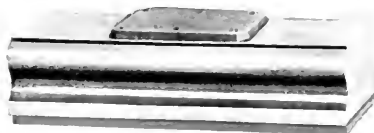

Proof Planer

Proof Planer, size 3 1/4 x 8 inches, weight two pounds.	Price	\$0 60
Proof Planer, size 3 1/2 x 8 inches, with leather top, weight two pounds.	Price	70

Linotype Planer

The Linotype Planer is a necessity in every office that uses the Linotype machines. Each is faced with corrugated rubber, which removes the burr from the linotype slugs without the slightest injury to the face of the type. The Planer is well and strongly made and satisfactorily fulfills the purposes for which it is intended.

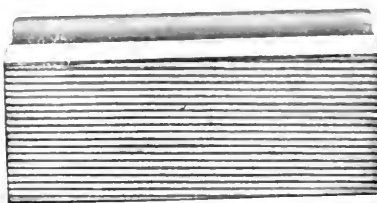

Linotype Planer

Linotype Planer, size 3 1/4 x 6 inches.	Price	\$0 50
Linotype Planer, size 3 1/2 x 6 inches with leather top.	Price	70

The Rouse Copy Holder

This is a device for the job printer, practical and effective. It saves time and patience and prevents the loss of copy. Designed as an adjunct to the Rouse Job Stick, but can be readily attached to any composing stick by having the necessary holes drilled in the stick for that purpose and putting it in place. It is convenient and is becoming popular.

Rouse Copy Holder	\$0 25
-------------------	--------

Yankee Side Sticks

The Yankee Side Stick has double bevel and two sliding quoins, which are fastened to the brass-lined edge of the main stick. The quoins can be moved from the center to the ends, but cannot be taken off, being held in position by brass plates which engage and overlap the brass edge of the main body piece. For a quick lock-up this Side Stick is very convenient.

Length, 22½ inches; width at center, 1½ inches; weight, 9 ounces. List price, each \$0 60

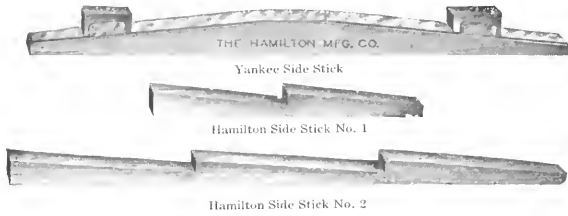

Hamilton Side Sticks

Side Stick No. 1 is made with two bevels. Length, 11¼ inches; width at wide end, 1 inch; width at narrow end, ½ inch. List price, each 05

Side Stick No. 2 is made with three bevels. Length, 23¼ inches; width at wide end, 1 inch; width at narrow end, ½ inch. List price, each 08

Wood Quoins of All Kinds

There always has been and there always will be a demand for good Wood Quoins. There is a reason, as it is impossible to estimate the amount of type that is injured by iron quoins and keys. Besides wood quoins are cheaper than any other similar device. Wood Quoins are put up either in boxes, bags or barrels to suit the convenience of our customers.

Wood Quoins in Boxes

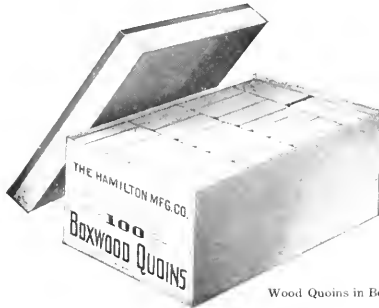

Wood Quoins in Boxes

For the convenience of customers requiring but a small quantity we have had one hundred quoins put up in a neat box ready for delivery. You can have them either made of hickory, boxwood or lignumvitae, but the boxes do not come assorted.

Quoins in Barrels and Bags

For large orders of Wood Quoins we have them put up in barrels and burlap bags. The barrels contain about 7,500 Quoins.



Wood Quoins in Barrels and Bags

Boxwood Quoins in Barrels, per 1000 quoins . \$5 00
Hickory, in Barrels, per 1000 3 25

List Prices of Wood Quoins in Boxes and Bags

KIND	Weight per 100	Boxes of 100	Burlap Bags of 500	Burlap Bags of 1000
Hickory	1¾ lbs.	\$0 40	\$1 80	\$3 50
Boxwood	2 lbs.	60	2 70	5 25
Lignumvitae	2½ lbs.	80	3 60	7 00

Tympan Press Boards

28x42 inches, each . \$0 50 40x60 inches, each . \$1 00
30x45 inches, each . 60 45x60 inches, each . 1 20

Wells Long Wood Quoins

The Wells Quoins have long bearing surface and by their use a perfect lockup is secured. They are improved by a top notch, which greatly assists in unlocking the forms. Made in four sizes, all working in pairs with straight furniture, or they can be used singly with side sticks. Any two Quoins make a pair. They are beveled on one side only. Put up in neat paper boxes.

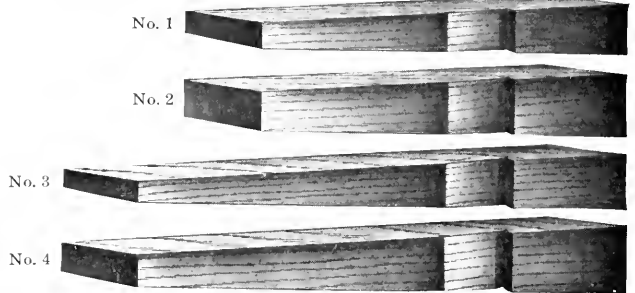

Wells Long Wood Quoins

List Prices of Wells Quoins

	Number of Quoins in Box	Weight	Price Hickory	Price Boxwood
No. 1	100	1¼ lbs.	\$0 75	\$1 10
No. 2	100	2¼ lbs.	75	1 10
No. 3	100	2½ lbs.	1 10	1 75
No. 4	100	3 lbs.	1 10	1 75

Iron and Wood Side and Foot Sticks

Iron Side Sticks are made, unless otherwise ordered, one-quarter inch longer than the standard length of form and Foot Sticks are made one-quarter inch shorter than



Iron Side and Foot Stick

of form. If larger than six point column rules are used, or columns wider than thirteen ems pica, allowance will have to be made.

List Prices of Iron Side and Foot Sticks

Iron, straight, per inch \$0 04 Iron, beveled, per inch \$0 05

SIZES OF SIDE AND FOOT STICKS	Length Side Stick	Length Foot Stick	Total Length	
			2 of Each	4 of Each
4-column folio or quarto	15	8¾	49	99
5-column folio or quarto	19	11¼	60	120
6-column folio or quarto	21	13¾	70	140
7-column folio or quarto	23	15¾	78	146
8-column folio or quarto	25	18	86	172
9-column folio or quarto	27	21¼	98	196

List Prices of Wood Side Sticks, Per Yard

	Length	Thick End	Thin End	Price
Extra Thin	1 Yard	½ Inch	¾ Inch	\$0 04
Thin	1 Yard	¾ Inch	1 Inch	05
Medium	1 Yard	1 Inch	1½ Inch	06
Thick	1 Yard	1½ Inches	2 Inch	07

Side Sticks, Wesel Step-Lockup

A lockup device similar to the side lock used on stereotyping chases; made same height as an ordinary chase; operated by a double pin wrench; occupies a space of two inches and has lateral spread of three-sixteenths of an inch. Price twenty-five cents per running inch per pair. On orders less than fifty inches add twenty-five per cent to list.

Wrenches for Wesel Step-Lockup \$1 25

Shooting Sticks

No. 2, 7½ inches, wrought steel, nicked, small. Price, each . \$0 60
No. 3, 9½ inches, wrought steel, nicked, large. Price, each . 75
Malleable Iron, Japanned each . 30
Boxwood, per dozen \$1 50 each . 12
Hickory, per dozen 85 each . 08
Iron, Wesel make, No. 3, black each . 45



Shooting Stick

The Dixie Hand Cleaner

This hand cleaner has been prepared for printers and pressmen especially. It has antiseptic properties that cure chapped hands and keep the skin smooth and soft. It is one of the best hand cleaners on the market, and is guaranteed to give perfect satisfaction. It goes down into the pores, and removes the dirt and grime. It may also be used for household purposes, and will be found excellent for cleaning pots, kettles, tinware, floors, white paint, etc.



The Dixie Hand Cleaner

Price, per can

\$0 10

Kleenu

Kleenu is a harmless and antiseptic preparation, which is better than soap for dirty hands. It is a great necessity in the printshop, as it removes, with remarkable quickness and thoroughness, all stains, grease stains and dirt which are unaffected by soap. For general hand-cleansing purposes it is without an equal.

Kleenu, price per can

\$0 10

Eureka Type Wash

1-pound can
5-pound can

\$0 20
75

10-pound can
50-pound can

\$1 25
5 00



Kleenu

American Roller Spray

The American Roller Spray is a liquid preparation for retaining ink on the press and rollers without drying, and also for reducing ink to a useable condition, while still preserving the color and working consistency. The Roller Spray enables presses to be run up to the last minute of working time, thus effecting a great economy. It can be applied to any style cylinder or job press, in less than a minute, at the end of a day's run, and will keep the ink and rollers in perfect condition to begin work without delay. It is applied to the rollers, ink table or cylinder in a mechanical atomizer or sprayer and with a few revolutions of the press the Spray mixes with the ink. After applying the Spray the rollers should be left in the press. It protects the rollers from the atmosphere and prolongs their life. It removes dirt, fuzz and lint from the rollers while the press is running. It prevents the ink from caking, brightens up dull or muddy ink and produces clean, brilliant and smooth impressions. It avoids washing up at noon or night, increases output and is excellent for cleaning all kinds of machinery. It is economical in use as it costs less than a cent for any application.

Price, American Roller Spray, One Gallon Can

\$3 00

Also put up in three and five gallon cans. Sprayers, each.

75



American Roller Spray



Mechanical Sprayer or Atomizer

C. E. Donnell's Ink Regulator

Donnell's Ink Regulator is a combined ink reducer and dryer. It will increase the quality of any ink from twenty-five to fifty per cent. It enables one to print and back work on any quality of paper in from ten minutes to one hour without the least offset. It will work in all qualities and colors of ink equally well. Old inks can be used.

Prices of C. E. Donnell's Ink Regulator

Donnell's Ink Regulator, pint	\$0 50
Donnell's Ink Regulator, quart	1 00
Donnell's Ink Regulator, gallon	3 00



Donnell's Ink Regulator

Chesapeake Economy Compound

A well known Compound, free from mineral products or acids. Absolutely safe to use and will not dry on forms or rollers. Varnishes may be added if required. It is very economical in use.

1-pound can	\$0 75	5-pound can	\$3 25	10-pound can	\$6 00	25-pound can	\$13 75	50-pound can	\$25 00.
-------------	--------	-------------	--------	--------------	--------	--------------	---------	--------------	----------

Crawford's Ink Reducer

1/2 pint	\$0 10	1/2 pint	\$0 30	1 pint	\$0 50
----------	--------	----------	--------	--------	--------

Inkoleum

A liquid preparation for reducing and refining printing inks, without impairing their color. Inkoleum has been on the market a number of years and has made good. It is a splendid preparation to have in the pressroom when ink, paper and weather are at loggerheads. Try a bottle and note the results.

Price per bottle, half pound

\$0 50

Burbank's Embossing Composition

This is a semi-liquid chemical preparation for making counter dies for embossing. The composition is spread over a piece of cardboard glued to the platen of the press and covered with two sheets of tissue paper. The impression of the die is then made upon the composition, which results in a perfect counter die. Well adapted for use on all classes of embossing presses.

Prices of Embossing Compositions

Burbank's Embossing Composition, price per can	\$0 75
Michener's Embossing Composition, price per package	1 00

Richter's Metal Cleaner

Richter's Metal Cleaner is a time-tried preparation which will thoroughly clean electrotype, stereotype, linotype and monotype metals; it also prevents to a great extent oxidation, and reduces dross to the minimum. It will temper, clean, flux and regulate metals.

Prices of Richter's Metal Cleaner

One-pound can (sample)	\$0 65	Ten-pound can	\$ 5 00
Five-pound can	3 00	Fifty-pound can	22 00



Inkoleum



Richter's Metal Cleaner

Promptness in filling orders is usually an important factor. The American Type Founders Company, with its vast facilities and its selling houses in nearly all the important cities of the country, is particularly well adapted to fill every order for supplies of every description used by printers, with promptness and despatch.

Steel Furniture

Steel Furniture has been in use for many years past and is one of the greatest labor-savers ever introduced to the printing trade. It is a well tried and useful device for saving time in making up and locking up printing forms. It is made from especially cold drawn steel, accurate in every dimension to the thousandth part of an inch, and cut to accurate lengths with milled notched ends, which can be quickly set around blank spaces instead of filling them in the ordinary way with wood or metal furniture.

For color and blank work it is exceptionally valuable, as it eliminates shrinkage due to changes in temperature. Weight for weight it goes six times as far in filling space as metal furniture and can be used in from one-half to one-sixth the time. It is practically indestructible, and being made of steel, always remains accurate. Four pieces each forty-two picas long will fill a blank of forty-nine square inches, weigh but little, be almost instantly installed and prove more secure with a minimum of pieces. Using the larger pieces, eight will fill a blank twelve by twenty-four inches, or two hundred and eighty-eight square inches. The few pieces required for large spaces, its security, and little liability to damage by use or from corrosion, gives this steel furniture advantages possessed by no other material for the purpose.



Style No. 1. 21 point steel with one 12 point notch



Style No. 2. 36 point steel with two 12 point notches



Style No. 3. 36 point steel with one 18 point notch



Style No. 4. 48 point steel with three 12 point notches

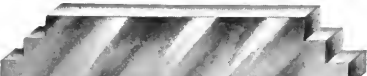

Style No. 5. 54 point steel with two 18 point notches

This Steel Furniture is made of twenty-four, thirty-six, forty-eight or fifty-four point steel five-eighths of an inch high, and with either twelve or eighteen point notches.

For Fonts A, B, E, G, H and J, each \$1 50
Double A, E, G and J, each 2 00

List Prices and Styles of Steel Furniture

Font A has eight pieces each 8, 10, 12, 14, 16, 18, 20, 22, 24, 26, 28, 30, 32, 34, 36, 38, 40 and 42 picas of Style One, and 45, 48, 51, 54, 57, 60, 63, 66, 69 and 72 picas of Style Two, two hundred and twenty-four pieces. List price . . . \$54 00
Font B is half of Font A, one hundred and twelve pieces. List price 27 00
Font C, first section of Font A, one hundred and forty-four pieces. List price 29 00
Font D has half the quantity of Font C, seventy-two pieces. List price . . . 14 50
Font E is the second section of Font A, Style Two, eighty pieces. List price. 25 00
Font F has half the quantity of Font E, forty pieces. List price 12 50
Font G has eight pieces each of Style Three; lengths, 9, 12, 15, 18, 21, 24, 27, 30, 33, 36, 39, 42, 45, 48, 51, 54, 57, 60, 63, 66, 69 and 72 picas. Total, one hundred and seventy-six pieces. List price 44 00
Font H has half the quantity of Font G, eighty-eight pieces. List price . . . 22 00
Font I is made of Style Five; lengths 15, 18, 21 and 24 inches; four outside pieces, two cross-bars for each length, twenty-four pieces in all. List price 21 00
Font J has eight pieces each 6, 8, 10, 12, 14, 16, 18, 20, 22, 24, 26, 28 and 30 picas of Style One, and 33, 36, 39, 42, 45, 48, 51, 54, 57 and 60 picas of Style Two, and 63, 66, 69 and 72 picas of 48 point steel, with 12 point notches. Total, twenty-seven different lengths, two hundred and sixteen pieces. List price 60 00

Prices of Cases for Steel Furniture

For Fonts C and D, each \$1 00
Double C 1 25

Hand Rollers

The best roller composition is the cheapest. We furnish rollers cast three inches in diameter with the best roller composition when complete rollers are ordered.

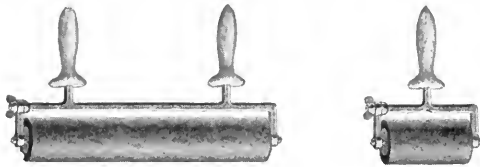

	Number of Handles	Frame Core and Handle	Roller Complete	Extra Stock
6 inch	1	\$1 25	\$ 1 85	\$0 40
8 inch	1	1 50	2 30	45
10 inch	1	1 75	2 75	50
12 inch	1	2 00	3 20	60
14 inch	2	2 25	3 65	70
16 inch	2	2 50	4 10	75
18 inch	2	2 75	4 55	80
20 inch	2	3 00	5 00	85
22 inch	2	3 25	5 45	1 85
24 inch	2	3 50	5 90	1 90
26 inch	2	3 75	6 35	1 15
28 inch	2	4 00	6 80	1 20
30 inch	2	4 25	7 25	1 25
36 inch	2	4 50	8 10	1 60
40 inch	2	5 50	9 50	1 50
44 inch	2	6 00	10 40	1 60
50 inch	2	6 50	11 50	1 75
54 inch	2	7 00	12 40	2 00

Roller Cores for Job Presses

	7x11	8x12	10x15	12x18	13x19	14x20	14 ¹ / ₂ x22
C & P or Challenge	\$0 35	\$0 35	\$0 45	\$0 60	\$0 60	\$0 60	\$0 60
Peerless		75	75	75	75	75	75
Colt's Armory			50	60	60	75	75

Rollers for Hand and Cylinder Presses

Cylinder Press Rollers, best composition, per pound . . . \$0 35
Hand Press Rollers, 3 ins. in diameter, per running inch . . . 10
Hand Press Rollers, larger than 3 ins. in diameter, per lb. . . 35

	2-ply 1-16 inch thick	3-ply 1-12 inch thick		2-ply 1-16 inch thick	3-ply 1-12 inch thick		2-ply 1-16 inch thick	3-ply 1-12 inch thick
26 inches wide, per yard . . .	\$ 9 75	\$12 25	40 inches wide, per yard . . .	\$15 50	\$19 50	52 inches wide, per yard . . .	\$22 75	\$28 75
30 inches wide, per yard . . .	11 25	14 25	42 inches wide, per yard . . .	16 75	21 00	54 inches wide, per yard . . .	24 00	30 50
32 inches wide, per yard . . .	12 00	15 00	44 inches wide, per yard . . .	17 75	22 50	56 inches wide, per yard . . .	25 50	32 25
34 inches wide, per yard . . .	12 75	16 00	46 inches wide, per yard . . .	19 00	24 00	58 inches wide, per yard . . .	26 75	34 00
36 inches wide, per yard . . .	13 50	17 00	48 inches wide, per yard . . .	20 25	25 50	60 inches wide, per yard . . .	28 00	35 75
38 inches wide, per yard . . .	14 50	18 25	50 inches wide, per yard . . .	21 50	27 25			

Rubber Blankets

Roller Casting

	Size of Press	Gordon or Peerless, Each	Universal or Colts, Each
Eighth Medium	7 x11	\$0 40	\$0 40
Eighth Medium	8 x12	40	60
Eighth Medium	9 x13	45	
Quarto Medium	10 x15	80	80
Quarto Medium	11 x17	85	
Quarto Medium	12 x18	1 00	
Half Medium	13 x19	1 00	1 00
Half Medium	14 x20	1 10	
Half Super-Royal	14 ¹ / ₂ x22	1 25	1 25

Brayers

Cast one and three-quarter inches in diameter

	Frame and Core	Roller Complete
6 inch	\$0 90	\$1 20
8 inch	1 00	1 40

Felt Roller Cloth

Felt Roller Cloth, 12 yard rolls, 2¹/₂ inch, each \$5 00

Felt Cloth Distributing Rollers

Size of Bed	If Stocks are Furnished	Including Stocks	Size of Bed	If Stocks are Furnished	Including Stocks
17x21	\$1 90	\$6 90	32x46	\$4 00	\$10 25
20x25	2 00	7 25	34x50	4 25	10 75
21x27	2 25	7 55	36x52	4 50	11 25
24x30	2 50	8 00	40x54	4 75	11 75
25x35	3 00	8 75	40x60	5 00	12 50
29x42	3 50	9 50			

Roller Composition

Bingham's Standard, per pound \$0 35
Bingham's Durable, per pound 50
Bingham's Gem, for Northwest, per pound 35

Felt Blankets

Thick, 36 inches wide, per yard \$5 40
Thick, 44 inches wide, per yard 6 60
Thick, 54 inches wide, per yard 8 10
Thin, 44 inches wide, per yard 3 50

American Bookbinders' Steel Wire

The American Bookbinders' Steel Wire is drawn especially for us and is the very best obtainable. The quality of wire used upon the various wire stitching machines has much to do with their successful operation. It is therefore advisable and more economical to buy nothing but the best. We recommend American Bookbinders' Steel Wire.

Each spool holds five pounds of wire and a case contains twenty spools. Spools are charged for to be rebated at same rate when same spools are returned to seller, freight prepaid, and in good condition.

The following prices apply to our best quality Tinned Bookbinders' Wire and to lots of one size. In lots of five hundred pounds and more special prices will be made according to market. We shall be pleased to quote current prices and discount on application. While the prices given below may to a great extent be relied on, there are times when the fluctuations in the cost of materials make it impossible for us to guarantee them absolutely and they are therefore subject to change without notice. As the American Type Founders Company supplies a very large part of the wire used in the various binderies in this country, it is in a position to secure from the manufacturers a high quality of wire which by its long and varied experience it knows to be eminently suited for bookbinders' requirements.



Bookbinders' Steel Wire

The above prices, as has already been stated, are based on the current market prices, which are subject to fluctuations. Special prices will be quoted on lots of five hundred pounds and more. The lowest market price for high grade wire will always govern regardless of the above prices.

List Prices of Bookbinders' Steel Wire

Round Wire	Less than 100 pounds	100 pounds and under 500 pounds
Nos. 18 to 23 Round, per pound	\$0 12	\$0 09
Nos. 24 and 25 Round, per pound	12	10
No. 26 Round, per pound	13	11
No. 27 Round, per pound	14	12
No. 28 Round, per pound	15	13
No. 30 Round, per pound	16	14
Flat, per pound	14	12

Wire Staples for all Machines

The American Type Founders Company is also the largest dealer in Wire Staples for printers' and bookbinders' use. We supply millions of them annually and consequently are in a position to quote the very lowest prices on the very highest grade staples. We exercise the same care and attention in the selection of our Wire Staples for all machines as we do in choosing the highest type of printing machine. That is probably the reason why we sell so many staples. There are thousands of stapling machines in use in the smaller printing offices throughout the country and they are always consuming staples. The next time you are in the market for staples, send us an order; we shall be pleased to supply you and you will be readily convinced of the unusually high quality of our staples. The American Staples are all arranged in the most practical and convenient manner and are put up in neat boxes.

Boston Wire Staples



Prices of Boston Wire Staples, either size, are as follows:

5,000 lots, per box of 5,000	\$0 90	50,000 lots, per box of 5,000	\$0 70
25,000 lots, per box of 5,000	75	100,000 lots, per box of 5,000	65

Yarger Staples

These staples are furnished on tin sticks, fastened with a strand of wire and are much superior to the old style with wooden sticks held with rubber bands. All sizes carried in stock for Yarger Binders Nos. 1, 2, 4, 5, 6, 7, 8, 9 and 10. Give number of staple or style of binder and size of staple desired when ordering. Can be supplied at a moment's notice.

Nos. 1 to 15 per box of 5,000 of one size \$0 90
Larger quantities at same prices as Boston Wire Staples quoted above.
Nos. C, D, E, L, M and N per box of 1,000 of one size 25

Acme Staples

We carry a large stock of staples for the Sure Shot Binder and Acme Binders Nos. 1, 4 and 6. There is no delay in filling orders.

Staples Nos. 21, 22, 23, 24, X, XX. Per box of 5,000 of one size \$0 90
Larger quantities at the same prices as Boston Wire Staples quoted above

Table Showing Number of Wire Staples to One Pound of Wire

To ascertain the number of staples to one pound of wire, measure full length of wire in staple, go to first column on left of table and pass down same until you reach the size that corresponds with staple measured; pass along to right until you reach size of wire used, shown by top row of figures. Example: If your staple measures 1 1/2 inches, and the size of wire is No. 28, there are 11,940 staples to one pound as shown in following table submitted for convenience of our patrons.

Length of Wire in Staple	18	19	20	21	22	23	24	25	26	27	28	29	30
1/2 inch	4104	5394	7408	8856	11594	14544	17142	22640	28236	31578	35820	40678	47058
5/8 inch	3283	4315	5926	7084	9275	11635	13713	18112	22582	25262	28656	32542	37646
3/4 inch	2736	3596	4938	5904	7729	9696	11428	15093	18824	21052	23800	27118	31372
7/8 inch	2345	3082	4233	5060	6625	8310	9795	12937	16134	18044	20468	23244	26890
1 inch	2052	2697	3704	4428	5797	7272	8571	11320	14118	15789	17910	20339	23529
1 1/8 inch	1824	2397	3292	3936	5152	6464	7618	10062	12549	14034	15920	18079	20914
1 1/4 inch	1641	2157	2963	3542	4637	5817	6856	9056	11294	12631	14328	16271	18823
1 1/2 inch	1492	1961	2693	3220	4116	5288	6233	8232	10267	11482	13025	14792	17122
1 3/4 inch	1368	1798	2469	2952	3864	4848	5714	7546	9412	10526	11940	13559	15686
1 7/8 inch	1262	1659	2279	2724	3567	4475	5274	6966	8688	9716	11021	12516	14479
1 5/8 inch	1172	1541	2116	2530	3312	4155	4897	6468	8067	9022	10234	11622	13445
2 inch	1094	1438	1975	2361	3091	3878	4571	6037	7529	8422	9552	10847	12548
2 1/8 inch	1026	1348	1852	2214	2898	3636	4285	5660	7059	7894	8955	10169	11764
2 1/4 inch	965	1269	1743	2083	2728	3422	4033	5327	6643	7430	8428	9571	11072
2 3/8 inch	912	1198	1646	1968	2576	3232	3809	5031	6274	7017	7960	9039	10457
2 1/2 inch	864	1135	1559	1864	2440	3061	3608	4706	5944	6648	7541	8563	9806
2 5/8 inch	820	1078	1481	1771	2318	2908	3428	4528	5647	6315	7164	8135	9311
2 3/4 inch	781	1027	1411	1686	2208	2770	3265	4312	5378	6014	6822	7748	8963
2 7/8 inch	746	980	1346	1610	2108	2644	3116	4116	5133	5741	6512	7396	8556
2 5/4 inch	713	938	1288	1540	2016	2529	2981	3937	4910	5491	6229	7074	8184
3 inch	684	899	1234	1476	1932	2424	2857	3773	4706	5263	5970	6779	7843
3 1/8 inch	656	863	1185	1416	1855	2327	2742	3622	4517	5052	5731	6508	7529
3 1/4 inch	631	820	1139	1362	1783	2237	2637	3483	4344	4858	5510	6258	7239
3 3/8 inch	608	799	1097	1312	1717	2154	2539	3354	4183	4678	5306	6026	6971
3 1/2 inch	586	770	1058	1265	1656	2077	2448	3234	4033	4511	5117	5811	6722
Number of feet in one pound.	171	221 1/4	308 1/2	369	483 1/2	606	711 1/4	943 1/2	1176 1/2	1315 1/2	1512 1/2	1694 1/2	1960

Table copyrighted by C. D. Blackhall, 1893. Published by permission

Engraving Tools

Each tool is made of the finest quality, highly tempered steel, ground and sharpened ready for use.



No. 1. V-Shaped, large, sharp edge



No. 2. V-Shaped, small, sharp edge



No. 3. Flat, face 7-64-inch wide



No. 4. Flat, face 1/4-inch wide



No. 5. Oval, face 7-64-inch wide



No. 6. Diamond, 5-32-inch square

Engraving tools, set of six, packed in box

\$2 50

Engravers' Wood

Engravers' Boxwood is made in four grades, the blocks being made any size desired, the usual size being twelve by twelve. Boxwood blocks weigh approximately four and one-half pounds per square foot.

Prices of Engravers' Wood

Engravers' Boxwood, per square inch, according to the quality \$0 02, \$0 03, \$0 04 and \$0 05
 American Boxwood, per square inch 02
 Engravers' Maple, per square inch 01

An additional charge of twenty or twenty-five per cent is made for furnishing Maple Blocks dressed on both sides.

Eye Shades

The Ellis Adjustable Eye Shade, with a shield from the side light, is a great improvement over other shades.

Adjustable Eye Shade, each . . . \$0 25
 Adjustable Eye Shade, per doz. . . 2 25



Reglet and Furniture in Yard Lengths

In yard lengths and bundles. (Reglet is shipped in yard lengths unless otherwise ordered.) Thoroughly kiln-dried stock is used for our Reglet and Furniture, and made on machines especially designed for the purpose, thus insuring accuracy and smoothness. For Labor-Saving Reglet and Labor-Saving Reglet Cases see page 1267.

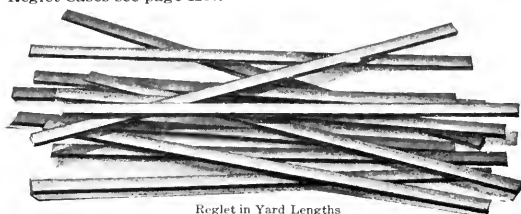

Reglet in Yard Lengths

List Prices of Reglet and Furniture in Yard Lengths

Widths	Weight 100 yards Pounds	Price Per Yard	Widths	Weight 100 yards Pounds	Price Per Yard
5 to 12 Pt.	10	\$0 02	11 Line	110	\$0 08
18 Point	15	03	12 Line	120	08
2 Line	20	03	13 Line	130	10
3 Line	30	04	14 Line	140	10
4 Line	40	04	15 Line	150	10
5 Line	50	04	16 Line	160	10
6 Line	60	06	17 Line	170	12
7 Line	70	06	18 Line	180	12
8 Line	80	06	20 Line	200	14
9 Line	90	06	24 Line	240	16
10 Line	100	08			

Hamilton Newspaper File

This is the most satisfactory newspaper file in use today. It is strong and efficient, yet simple in operation. Thousands of these Files are in use in the best newspaper offices in the country. Made of oak, nicely finished with brass fastenings and polished steel thumbscrews. The method of closing and opening the File is novel and simple. The clasp end of file has a flat-headed thumbscrew



Hamilton Newspaper File—Closed

is passed through a slot, and by giving the screw a quarter turn the File is securely locked. When the head is turned parallel with the File it opens instantly. Files in the following sizes are in stock; other sizes to order: Four-column paper, sixteen and one-half inches clear, ten ounces. Five-column paper, twenty and one-half inches clear, eleven ounces. Six-column paper, twenty-two and one-half inches clear, twelve ounces. Seven-column paper, twenty-four and one-half inches clear, thirteen ounces. Eight-column paper, twenty-six and one-half inches clear, sixteen ounces. Nine-column paper, twenty-eight and one-half inches clear, seventeen ounces. The sizes given above allow one-half inch play.

List price, each \$1 25

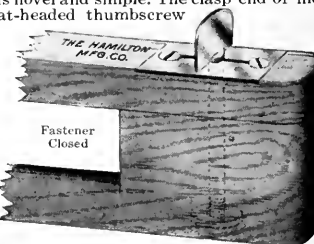

Fastener Closed

Stick Rest

This little article fills a long felt want. It saves time, temper and type. Made of wood; for holding the stick on top of type form while making corrections.



Stick Rest

Size of Stick Rest 4x10 inches, weight six ounces. Price, per dozen \$4 00
 Price, each 40

Magnifying and Reducing Glasses

The regular Engravers' Magnifying Glasses are the very best that can be procured for the purpose. The lenses are accurately ground, very powerful and are set in vulcanite.

Prices of Magnifying and Reducing Glasses

No. A 30. Magnifying Glass, 1-inch focus. Price . . . \$1 00
 No. A 36. Magnifying Glass, two lenses, 1-inch and 2 1/2-inch focus. Price 60

Pocket Magnifiers

These Pocket Magnifiers are made in two styles. The single lens is double convex, mounted in black vulcanite and finished in oval shape.

List Prices of Pocket Magnifiers

No. A 5. Pocket Magnifier, diameter of lens, 1 3/4 inches. Price \$0 75
 No. A 6. Pocket Magnifier, diameter of lens, 2 inches. Price 1 00

The Bellows-shaped Pocket Magnifier has two double convex lenses of different powers, which combined, give a third higher power. Black vulcanite mounting.

No. A 12. Pocket Magnifier, diameter of lens, 7/8-inch and 1-inch. Price \$0 75

Enlarging and Reducing Glasses

In these Enlarging and Reducing Glasses the lens is set in a nickel plated brass rim, and each has an ebonized hardwood handle. They are the best glasses procurable for the purpose.

Prices of Enlarging Glasses

No. A 80. Enlarging Glass, diameter, 2 inches \$0 80
 No. A 82. Enlarging Glass, diameter, 2 1/2 inches 1 00
 No. A 84. Enlarging Glass, diameter, 3 inches 1 50
 No. A 86. Enlarging Glass, diameter, 3 1/2 inches 1 75

Prices of Reducing Glasses

No. A 70. Reducing Glass, diameter, 2 inches \$1 50
 No. A 72. Reducing Glass, diameter, 3 inches 2 50
 No. A 74. Reducing Glass, diameter, 4 inches 4 00
 No. A 75. Reducing Glass, diameter, 5 inches 6 00

Brass and Copper Thin Spaces

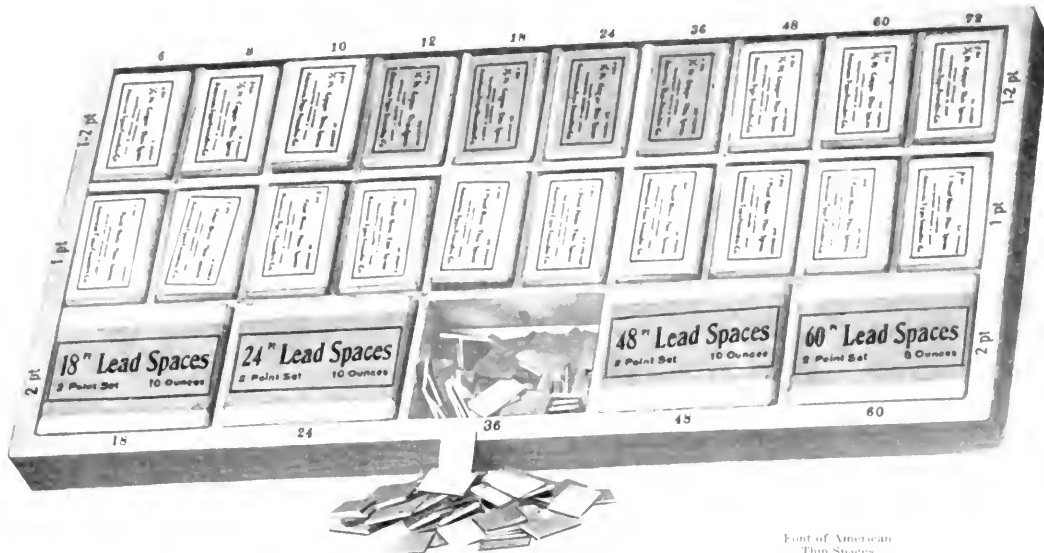

Font of American Thin Spaces

BRASS AND COPPER THIN SPACES

Make justification so easy that no office should be without them

That these 1/2 Point Copper and 1 Point Brass Thin Spaces may be readily distinguished, the 1/2 Point Spaces are made of Copper and the 1 Point Spaces are made of Brass.

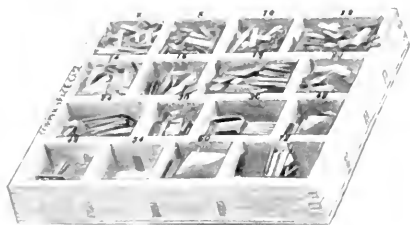

Style of Fonts Nos. 1, 2 and 3

Assortment No. 1. 1/2 Point Copper Thin Spaces. This font includes assortment of 6, 8, 10, 12, 14, 16, 18, 20, 21, 30, 36, 42, 48, 60 and 72 Point sizes, put up in wooden case, 16 ounces.

Price, including case \$1 75

Assortment No. 2. 1 Point Brass Thin Spaces. This font includes assortment of 6, 8, 10, 12, 14, 16, 18, 20, 24, 30, 36, 42, 48, 60 and 72 Point sizes, put up in wooden case, 16 ounces.

Price, including case \$1 75

Assortment No. 3. Assorted 1/2-Point Copper and 1 Point Brass Thin Spaces. This font includes an equal amount of both 1/2 Point Copper and 1 Point Brass Thin Spaces cut the following sizes : 6, 8, 10, 12, 14, 16, 18, 20, 24, 30, 36, 42, 48, 60 and 72 Point, put up in wooden case, 16 ounces.

Price, including case \$1 75

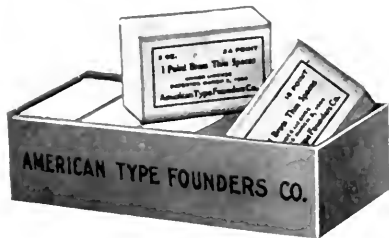

Style of Fonts Nos. 4, 5, 6, 7 and 8

Assortment No. 4. 1/2 Point Copper Thin Spaces. This font includes a two ounce package each 12, 18, 24, 36 and 48 Point, 10 ounces.

Price \$1 00

Assortment No. 5. 1 Point Brass Thin Spaces. This font includes a two ounce package each 12, 18, 24, 36 and 48 Point, 10 ounces.

Price \$1 00

Assortment No. 6. 1/2 Point Copper and 1 Point Brass Thin Spaces. This font includes an assortment of two ounces each of the following sizes : 12, 18, 24, 36 and 48 Point, 10 ounces.

Price \$1 00

Assortment No. 7. 1/2 Point Copper Thin Spaces. This font includes a two ounce package each 6, 8, 10, 12 and 18 Point, 10 ounces.

Price \$1 25

Assortment No. 8. 1 Point Brass Thin Spaces. This font includes a two ounce package each 6, 8, 10, 12 and 18 Point, 10 ounces.

Price \$1 25



Style of one pound packages

BRASS OR COPPER THIN SPACES

One Pound Packages

5 Point, per pound	\$2 50
5 1/2 Point, per pound	2 25
6 Point, per pound	2 00
7 Point, per pound	1 85
8 Point, per pound	1 75
9 Point, per pound	1 65
10 Point, per pound	1 55
11 Point, per pound	1 45
12, 14 and 16 Points, per pound	1 40
18, 20, 24 and 30 Points, per pound	1 35
36 Point and larger, per pound	1 30

AMERICAN THIN SPACES

Make Justification Easy

The American Thin Spaces include a complete assortment of 1/2 Point Copper and 1 Point Brass Thin Spaces and also of 2 Point Metal Spaces put up in the following proportions :

1/2 Point Copper Thin Spaces. Include two ounces each cut 6, 12, 18, 24, 36 and 48 Point sizes. One ounce each cut 8, 10, 60 and 72 Point sizes. Assortment weighs one pound.

1 Point Brass Thin Spaces. Include two ounces each cut 6, 12, 18, 24, 36 and 48 Point sizes. One ounce each cut 8, 10, 60 and 72 Point sizes. Assortment weighs one pound.

2 Point Metal Spaces. Include ten ounces each 18, 24, 36 and 48 Point sizes. Also eight ounces cut 60 Points. Weighs 3 pounds.

Price complete including Quarter Case \$5 00

Price of case only 65

Bookbinding Machinery

In addition to the numerous Machines and Appliances for Bookbinding listed in this Catalogue, the American Type Founders Company sells all other Machines used by Bookbinders, such as:

Folding Machines
Ruling Machines
Bindery Presses
Book Sewing Machines
Standing Presses
Bench Shears
Table Shears
Crimping Machines
Automatic Index Cutters
Stamping Presses
Waste Paper Balers
Etc., etc.

Full information and descriptive circulars, and lowest market quotations, will be supplied upon request. Estimates will be furnished for complete Bookbinding Plants for pamphlet, commercial or publication work.

American Type Founders Company

EVERYTHING FOR THE PRINTER



Modernized
Furniture

FOR THE

Composing
Room

AND

Press Room

American Type Founders Company



Steel and Iron Equipments

WHEN properly made, Steel and Iron Printing Plant Equipments are undoubtedly more economical than those made entirely of wood, because of their superior stability and durability. The economy of them is not to be measured by first cost, but by their practical indestructibility and the continuance of their good and dignified appearance after long use. When wooden equipments (bought at the same time) have become shaky, shop-worn and shabby, steel and iron equipments will be giving undiminished satisfaction. In buying well-made Steel and Iron Equipments printers are making an investment for their grandchildren. There is nothing so economical and lasting. These are the only Composing Room Equipments that may be depended upon to

*Keep the Printing
Plant Young*



American Type Founders Company



A Composing Room Equipped with Polhemus Cabinets

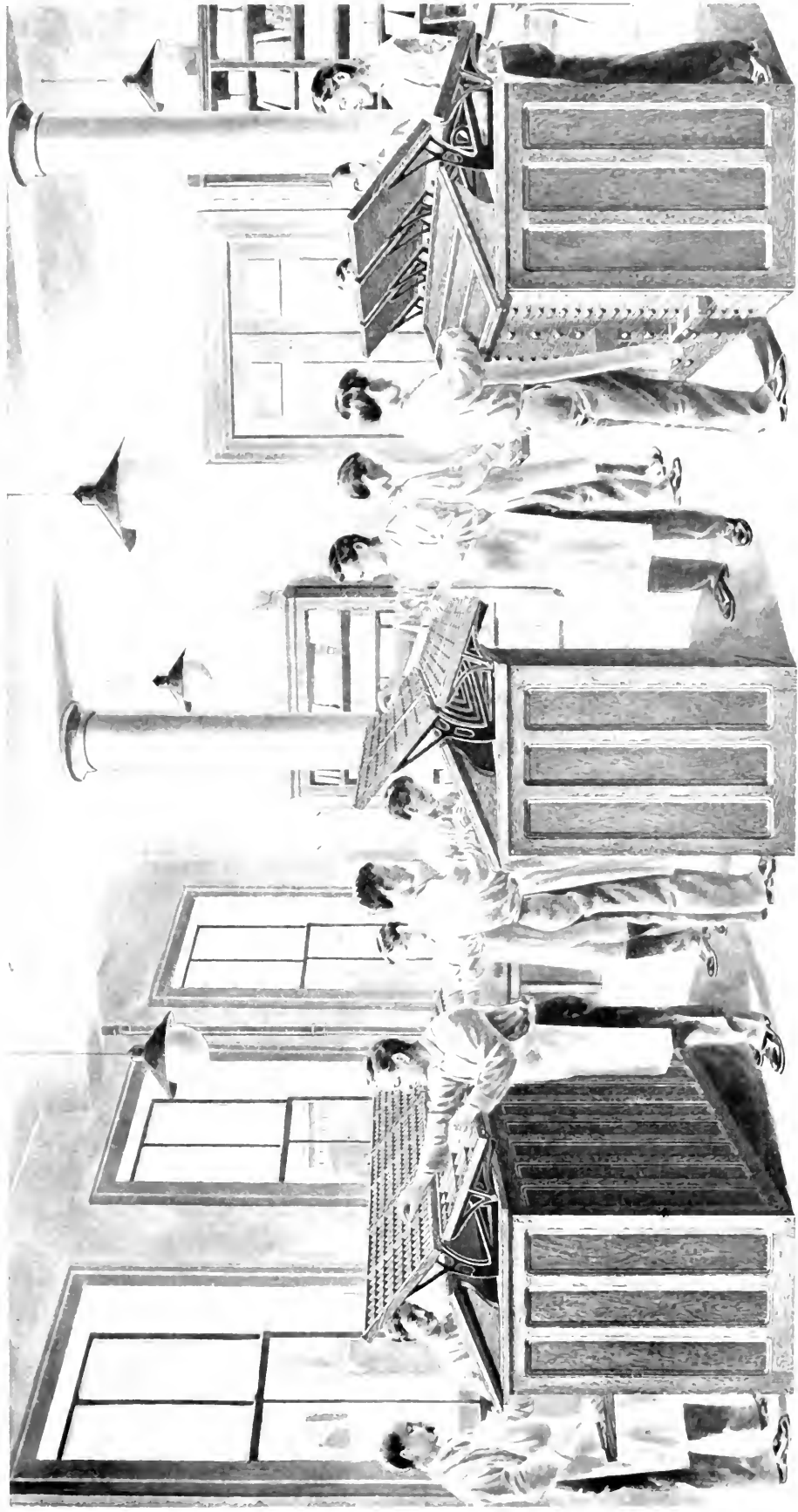

In starting a new office it is advisable to thoroughly consider the installation of modern equipment, thus saving greatly in space as well as making it more convenient for the work.

The Polhemus Cabinets

It is a remarkable fact that from the day of their first introduction the Polhemus Cabinets took the lead and are still considered among the most popular type cabinets. Perfected by and named after the late Mr. John Polhemus, at one time one of the leading printers of New York City, they were thoroughly tested and their sterling qualities fully proved before they were put upon the market. The No. 4

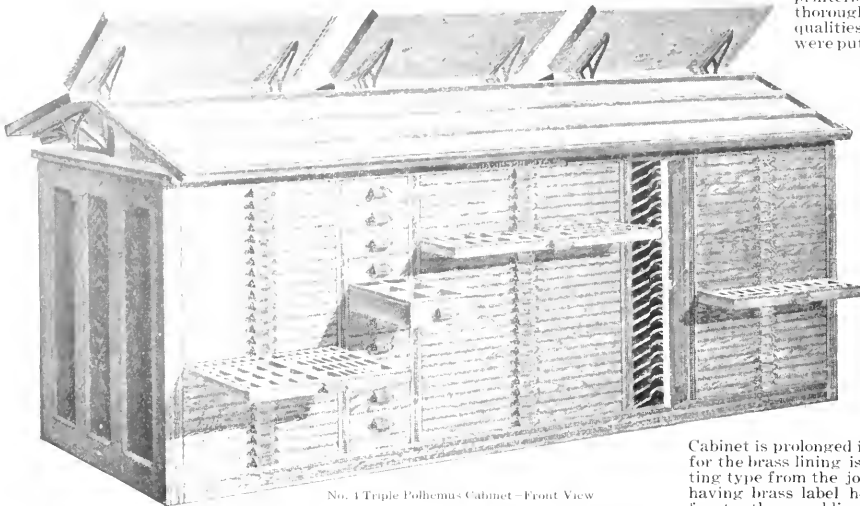

No. 4 Triple Polhemus Cabinet—Front View

glance the face of the type in any job case. The increased capacity of this Cabinet, particularly those with wood runs, places it at once at the head of the list as one of the best and most compact type cabinets ever constructed. This Cabinet embraces all the good features of Polhemus construction, combined with ease concentration. It has the full length galley dump, the sort cabinet, the galley cabinet closed with door, and the patent tilting brackets with galley boards under the lower cases.

NO. 4 TRIPLE POLHEMUS CABINET. With Steel Runs, containing fifty two-thirds California job cases, twenty-five cases in each tier, and twenty-five full size California job cases, in the center tier; three pairs of news cases and three pairs of No. 1 Hamilton Patent Tilting Brackets on top. Galley boards under lower cases. Full length galley dump, one tier of sort drawers and one series of galley shelves.

List Price and Dimensions

Height, 41³/₈ inches;
width, 104 inches;
depth, 27 inches.
Weight, crated for shipment, 1175 lbs.
List price \$140 00

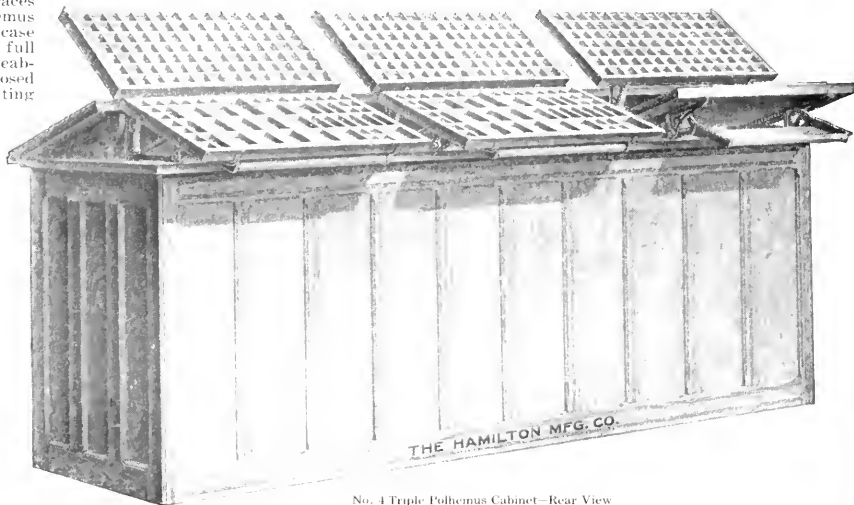

No. 4 Triple Polhemus Cabinet—Rear View

NOTE.—The galley dump on this No. 4 Triple Polhemus Cabinet can be furnished full brass lined, using No. 21 gauge patent leveled sheet brass for the bottom and square brass tubing for the surrounding rim and division strips. Extra to list price for brass lined dump, \$35.00.

The No. 5 DOUBLE POLHEMUS CABINET illustrated here is also one of the popular Polhemus Cabinets. Many printers prefer the tier of sort drawers between the two tiers of cases, in lieu of the tier of galley shelves. This Cabinet represents the extreme of ease concentration, twenty-five cases in each tier within working height for type-setting purposes. It has the full length galley dump and job cases on the reverse side from the news cases. Four men can work at this Cabinet without interfering. Polhemus Cabinets are essentially space and material savers, therefore money makers.

NO. 5 DOUBLE POLHEMUS CABINET. With Steel Runs, containing twenty-five full size California job cases in one tier, and twenty-five two-thirds California job cases in the other tier, two pairs of news cases and two pairs of No. 1 Hamilton Patent Tilting Brackets on top, with galley boards under lower cases. Full length galley dump and one tier of sort drawers between the two tiers of cases.

The series of Polhemus Cabinets shown on this page will be supplied without brass lined galley dump unless otherwise ordered.

List Price and Dimensions

Height, 44³/₈ inches; width, 70 inches; depth, 27 inches.
Weight, crated for shipment, 700 pounds. List Price \$95 00

NOTE.—The galley dump on this No. 5 Double Polhemus Cabinet can be furnished full brass lined, using No. 21 gauge patent leveled sheet brass for the bottom and square brass tubing for the surrounding rim and division strips. All screws on the Polhemus Cabinets are placed from the under side in order to make

a smooth all brass top throughout. Extra to list price for brass lined dump, \$24.00. Brass Label Holders, 1x3 inches, attached to any cabinet, at an addition to the list price of five cents per case.

The prices quoted here are subject to our usual discounts.

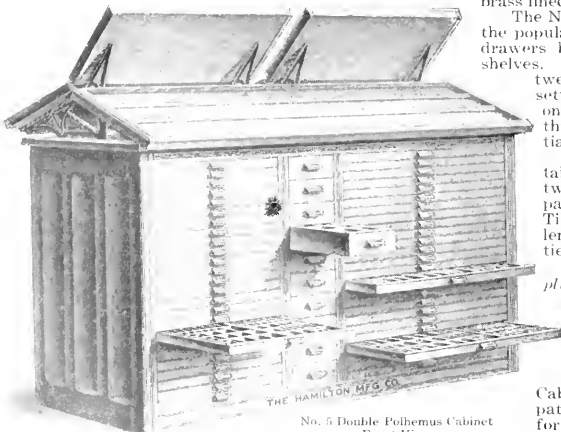

No. 5 Double Polhemus Cabinet Front View

The Cabinets Grand

Every feature of recognized merit found in any other style of type Cabinet is embodied in the construction of the No. 22 Cabinet Grand. It possesses the extension fronts to job cases, the distinctive feature of the Porter construction, the placing of the news and job compositors on opposite sides, and the full length galley dump, which are the distinctive features of Pullman construction.

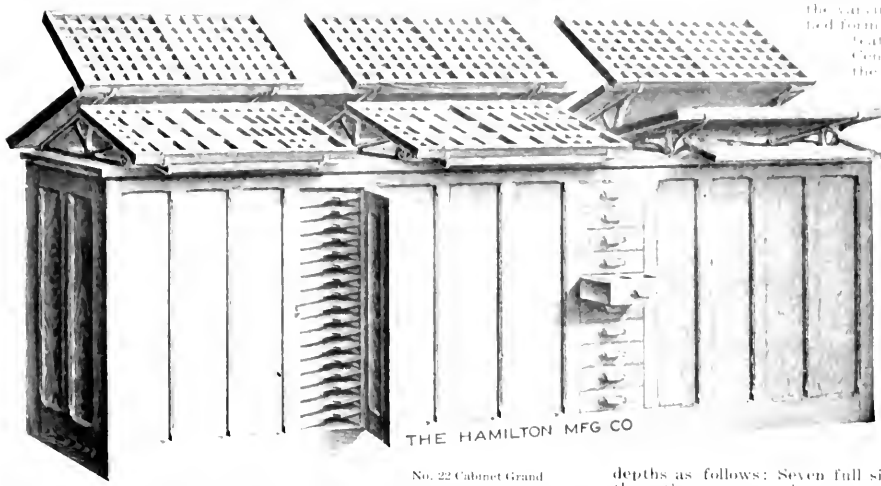

THE HAMILTON MFG CO

No. 22 Cabinet Grand

The various depth cases mentioned herein, which are the distinctive feature of the Twentieth Century construction. It has the case of sort drawers, and the tier of galley shelves opening from the news side. It has a seven and quad case, a seven and two inch lead and slug case, with duplicate compartments, on the job side. It is supplied with the new improved Three-Case Tilting Bracket, with galley boards under the lower cases.

full size cases one and three-eighths inches deep; seventeen three-quarter size cases one and three-eighths inches deep; three full size cases one and three-quarter inches deep; three three-quarter size cases one and three-quarter inches deep; three full size cases one inch deep; seventeen two-thirds size cases one and three-eighths inches deep; three two-thirds size cases one and three-quarter inches deep.

SORT DRAWERS. A series of ten Sort Drawers between the two tiers of cases, each Sort Drawer divided into ten equal size compartments, making one hundred compartments.

GALLEY SHELVES. A series of sixteen galley shelves enclosed by door, opening from the news side of the cabinet. The shelves are inclined and wide enough to take double column galleys.

TOP EQUIPMENT. Three pairs of No. 2 Three-Case Hamilton Patent Tilting Brackets, with galley boards under the lower cases, on which are placed the following cases: Three pairs of news cases, one blank case, one thirty-inch space and quad case, one No. 8 Bettis lead and slug case.

List Price and Dimensions of No. 22 Cabinet Grand

Height, 83 inches; width, 110½ inches; depth, 27 inches. Weight, crated for shipment, 1200 pounds. List price, complete with full top equipment \$1500 00

The No. 20 Cabinet Grand contains a total of forty-seven California job cases, arranged in two tiers, one tier of twenty-four full size cases and one tier of twenty-three two-thirds size cases. These cases are of three different outside depths as follows: Seven full size cases one inch deep; three two-thirds size cases one inch deep; fourteen full size cases one and three-eighths inches deep; seventeen two-thirds size cases one and three-eighths inches deep; three full size cases one and three-quarter inches deep; three two-thirds size cases one and three-quarter inches deep.

SORT DRAWERS. A series of ten Sort Drawers between the two tiers of cases, each Sort Drawer divided into ten equal size compartments, a total of one hundred compartments.

TOP EQUIPMENT. Three pairs of No. 2 Three-Case Hamilton Patent Tilting Brackets, with galley boards under the lower cases, on which are placed cases as follows: One pair of news cases; one blank case; one thirty-inch space and quad case; one No. 2 Adjustable lead and slug case, one No. 8 Bettis lead and slug case.

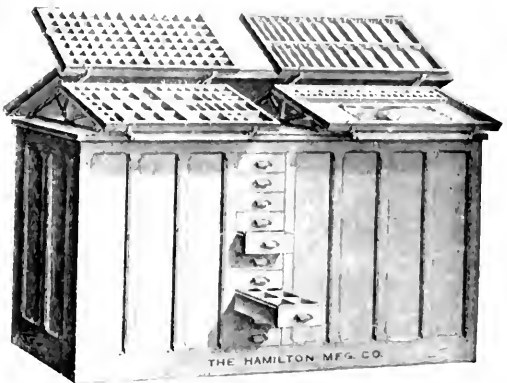

THE HAMILTON MFG CO

No. 20 Cabinet Grand

List Price and Dimensions of No. 20 Cabinet Grand

Height, 43 inches; width, 71 inches; depth, 27 inches. Weight, crated for shipment, 700 pounds. List price, complete with full top equipment \$1000 00

The news compositor on the No. 21 Cabinet Grand works undisturbed at the pair of news cases and dumps on the galley placed in the blank case. A thirty-inch space and quad case is placed back of the galley, wherein is carried a large assortment of spaces and quads in various sizes. Over the blank case on the upper bracket is placed a No. 2 adjustable lead and slug case, with center bar. A series of galley shelves is arranged between the two tiers of cases. With this arrangement the news compositor is not disturbed by the job man, and has all his material within reach.

CASES. The No. 20 Cabinet Grand contains a total of forty-seven California job cases, arranged in two tiers, one tier of twenty-four full size cases, and one tier of twenty-three two-thirds size cases. These cases are of three different outside depths as follows: Seven full size cases one inch deep; three two-thirds size cases one inch deep; fourteen full size cases one and three-eighths inches deep; seventeen two-thirds size cases one and three-eighths inches deep; three full size cases one and three-quarter inches deep; three two-thirds size cases one and three-quarter inches deep.

The cases one inch deep will easily take all small and medium size job fonts; the one and three-eighths inch cases are standard; the cases one and three-quarter inches deep are useful for holding large advertising fonts and metal type of large size.

GALLEY SHELVES. A series of sixteen Galley Shelves, enclosed by door, opening from the news side of the Cabinet. The shelves are inclined and wide enough to take double column galleys.

TOP EQUIPMENT. Two pairs of No. 2 Three-Case Hamilton Patent Tilting Brackets, with galley boards under the lower cases, on which are placed cases as follows: One pair of news cases; one blank case; one thirty-inch space and quad case; one No. 2 Adjustable lead and slug case; one No. 8 Bettis lead and slug case.

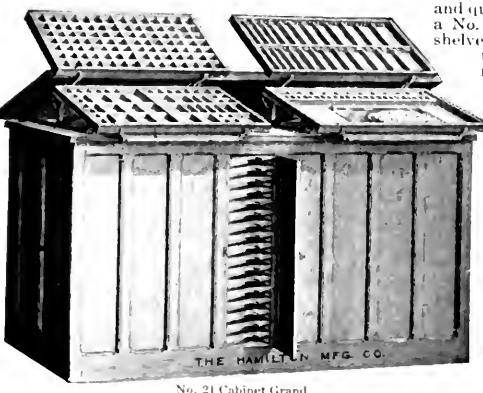

THE HAMILTON MFG CO

No. 21 Cabinet Grand

List Price and Dimensions of No. 21 Cabinet Grand

Height, 43 inches; width, 71 inches; depth, 27 inches. Weight, crated for shipment, 700 pounds. List price, complete with full top equipment \$1000 00

Reversible Unit Cabinets

Reversible Unit Cabinet Combination No. 1. This Cabinet is made up by combining one Unit No. 10 with twelve large cases, California pattern; one Unit No. 12 with twenty-four half size Wells job cases; one cap piece and one base piece; one Bank No. 1; one pair tilting brackets with one pair of news cases. Occupies floor space twenty-five by thirty-five inches.



Reversible Unit Cabinet Combination No. 1

Reversible Unit Cabinet Combination No. 2

This Cabinet is made by combining one Unit No. 12, holding twenty-four half size Wells job cases; one Unit No. 16, holding twenty-two California job cases, two-thirds size, pulling from the ends; one Unit No. 10, holding twelve large California job cases; one cap piece and one base piece. Note that the cases draw from four sides of the Cabinet. Four compositors can set type from this Cabinet without interfering. This is something not obtainable in any other type of cabinet. Occupies floor space twenty-five by thirty-five inches.

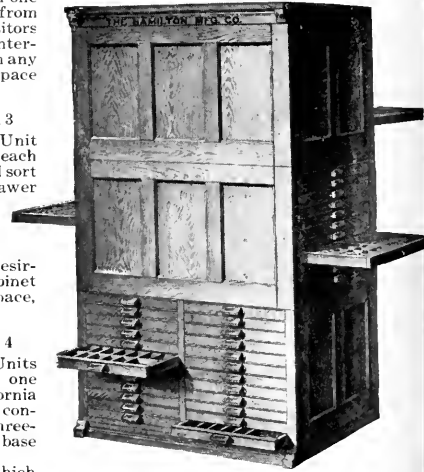

Reversible Unit Cabinet Combination No. 2

Reversible Unit Cabinet Combination No. 3

This Cabinet is made by combining one Unit No. 20, containing twenty-four sort drawers, each drawer having fourteen removable individual sort boxes; (the second unit above the sort drawer unit can be selected to suit the requirements of any printing office); one base piece and one cap piece; one galley box; two pairs New York case brackets; two pairs of news cases. This Cabinet combines all the desirable features of a window cabinet, a unit cabinet and a Polhemus cabinet. Occupies floor space, twenty-five by thirty-five inches.

Reversible Unit Cabinet Combination No. 4

This Cabinet is made by combining two Units No. 22, each containing seven letter boards; one unit No. 10, containing twelve large California job cases, standard depth; one unit No. 11, containing fifteen large California job cases three-

quarters of an inch deep inside the rail; two No. 1 banks, two cap pieces and two base pieces; two pairs of tilting brackets; two pairs of news cases on brackets.

This makes a cabinet with all the desirable features of the unit system, and one which can be made into two single cabinets by separating the two sections; a cabinet which can be

changed at will, reversed or added to in order to meet the requirements of a growing office. When you have in mind the equipping of your composing room, these cabinets should be seriously considered.

Unquestionably one of the greatest improvements in printers' cabinet construction during recent years has been the addition of the unit system—a system which has grown and expanded from a small beginning until now it is found in all lines of trade where system has made any material progress. There are many points of superiority in the unit system over any other construction. It allows of expansion with a small outlay. A single unit will often provide the additional room required, and the expense involved in the purchase of a complete new cabinet is avoided. At the same time the cabinet will always be complete and the general balance of the office equipment will be maintained.

Heretofore the unit system, so far as printing office furniture is concerned, has not been attempted beyond regular type cabinet construction. The line of units now offered allow almost unlimited possibilities in the way of different combinations including type case units, of various patterns, galley units, letter-board units, and sort drawer units. This allows the furniture in any printing office equipped with these new reversible units to be kept at an even balance. If new fonts of type are added, a unit containing a few type cases can be ordered.

If more storage room is required for tied up forms, a letter board unit can be added. A branching out in legal blank or railroad work may require the purchase of a sort drawer unit, etc. In connection with this, the fact that all these new units are made reversible, so as to face to the front or rear, or to pull from the ends, doubles the utility of the system. It is safe to say that there has never been offered to printers a line of cabinets possessing such a wide range of elasticity and adjustment, and we expect to see the reversible unit generally adopted in many of the up-to-date printing offices in the very near future. Reversible units holding type cases, are of New Departure construction—New Departure cases, with three-ply unbreakable bottoms covered with the best quality manila paper—that's what makes a new departure case. All fitted with new departure flat steel runs, on which the cases rest. Scarcely any wear or friction, and the life of the cases is prolonged indefinitely.

Reversible Unit Galley Box

This Galley Box is intended for use on top of a working cabinet, between two pairs of case brackets. It is ten and three-quarters inches wide by twenty-five inches long outside. It is provided with six galley shelves, which are nine and one-quarter inches wide inside. Provides a convenient dumping place and storage for galleys filled with body type, near the compositor.

List Prices, Dimensions and Weights of Reversible Unit Cabinets, etc.

Units	Floor Space Occupied	Outside Height	Outside Size of Cases	Number of Cases, Etc., per Unit	Style of Cases, Etc.	Approximate Weight, Crated	Price
No. 10	25 x35 inches	19 inches	21½x32¼ inches	12 Cases	California Job Cases	185 pounds	\$25 00
No. 11	25 x35 inches	19 inches	21½x32¼ inches	15 Cases	California Job Cases	195 pounds	28 00
No. 12	25 x35 inches	19 inches	21½x15½ inches	24 Cases	Wells Job Cases	200 pounds	30 00
No. 13	25 x35 inches	19 inches	21½x15½ inches	30 Cases	Wells Job Cases	210 pounds	35 00
No. 14	25 x35 inches	19 inches	21½x15½ inches	24 Cases	Yankee Job Cases	200 pounds	30 00
No. 15	25 x35 inches	19 inches	21½x15½ inches	30 Cases	Yankee Job Cases	210 pounds	35 00
No. 16	25 x35 inches	19 inches	15½x21¾ inches	22 Cases	California Job Cases	195 pounds	28 00
No. 17	25 x35 inches	19 inches	15½x21¾ inches	28 Cases	California Job Cases	200 pounds	35 00
No. 18	25 x35 inches	19 inches	21½x32¼ inches	12 Cases	Indexed ElectroCases	185 pounds	25 00
No. 19	25 x35 inches	19 inches	21½x15½ inches	24 Cases	Indexed ElectroCases	200 pounds	30 00
No. 20	25 x35 inches	19 inches	7½x22½ inches	24 Drawers	Sort Drawers	235 pounds	40 00
No. 21	25 x35 inches	19 inches	6 and 8¾x24 inches	27 Shelves	Galley Shelves	135 pounds	16 00
No. 22	25 x35 inches	19 inches	23¾x32 inches	7 Boards	Letter Boards	195 pounds	18 00
Galley Box	10¾x25 inches	13 inches	9¾x24 inches	6 Shelves	Galley Shelves	55 pounds	6 00
Cap	26 x35 inches	2¾ inches				45 pounds	6 00
Base	26 x35 inches	2 inches				35 pounds	6 50
Bank No. 1	17 x35 inches	Rear 7½ inches				30 pounds	3 00
Bank No. 2	28½x35 inches	Rear 11½ inches				50 pounds	6 00

Two Units with Cap and Base make a Cabinet forty-two and three-quarters inches high. Three Units with Cap and Base will make a Cabinet sixty-two and one-eighth inches high. Four Units with Cap and Base will make a Cabinet eighty and three-quarters inches high. The price of Unit No. 20 includes the removable sort boxes, fourteen for each drawer, or three hundred and thirty-six separate boxes for each Unit.

Reversible Unit Cabinets and Banks

A composing room entirely equipped with Reversible Unit Cabinets would not only make a striking appearance but would also be the most convenient and time-saving outfit imaginable. Should a printer desire to change the layout of his composing room at any time the Unit Cabinets will be found very easy to move from one place to another, one unit at a time.



Reversible Unit Cabinet No. 10

Each Unit of this pattern is fitted with twelve of the large California job cases of standard depth. Size of these cases is thirty-two and one-quarter by twenty-one and one-half inches, outside measure. The cases in this Unit will easily take the very largest cap, lower case and figure fonts without crowding. No other type case has a like capacity.

When you think of anything for the Printing Office also think of the American Type Founders Company

The American Type Founders Company will be pleased to give you additional information regarding these cabinets.

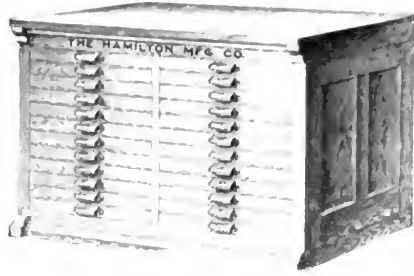

Reversible Unit Cabinets Nos. 12 and 11

Reversible Unit No. 12 is fitted with twenty-four of the half size Wells job cases. The size of these cases is twenty-one and one-half by fifteen and one-half inches outside. In this unit the cases are all standard depth. Unit No. 11 externally the same as unit No. 12, but fitted with twenty-four half size Yankee job cases, which will conveniently hold all small and medium size cap, lower case and figure fonts.



Reversible Unit Cabinet No. 16

Unlike the other units of this series, the cases pull from both ends. By adding one of these units to a cabinet the arrangement can be such as to have cases pull from the four sides of the cabinet. Holds twenty-two California job cases, size fifteen and one-half by twenty-one and three-quarters.

Reversible Unit Cabinets are easily taken apart and quickly put together again

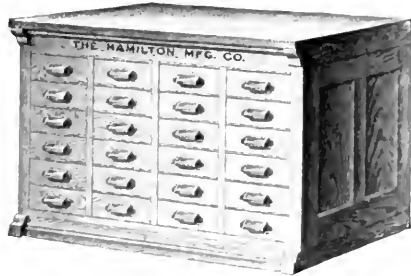

Reversible Unit Cabinet No. 20

This Unit is fitted with twenty-four sort drawers, each sort drawer being filled with fourteen removable sort boxes. The size of each sort box is two and three-eighths by two and three-eighths by two and one-eighth inches inside. The side rails of the drawers are cut away, leaving the sort boxes projecting above the rails, which allows their easy removal.



Reversible Unit Cabinet No. 21

This Unit has four tiers of galley shelves, each tier taking nine galleys, or forty-six galleys to the Unit. Three tiers are for double column galleys, having a width of eight and one-eighth inches in the clear. One tier takes single column galleys having a width of six inches.

Your compositors will like them and be enabled to do better work

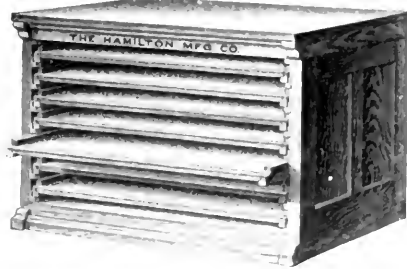

Reversible Unit Cabinet No. 22

This Unit is fitted with seven large letter boards, size of each board twenty-two by thirty and one-quarter inches inside, with one-half inch lip at front to receive the brass galley. Provides thirty-two square feet of letter-board surface in each Unit for the storage of standing forms and tied-up matter.

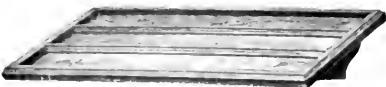

Reversible Unit Bank No. 1

Length, thirty-five inches; width, seventeen inches, outside measure. Divided into three equal spaces, each space four and five-eighths by thirty-three inches inside. This bank makes a convenient working space and provides storage room for standing jobs. It is intended to be used at the back of a pair of case brackets holding a pair of news cases. While the investment is somewhat greater in equipping a composing room in a modern manner, yet in the long run the modern way will undoubtedly be found the most economical.

A modern practical idea

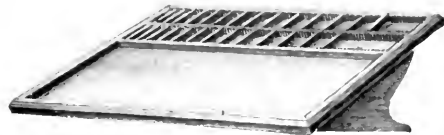

Reversible Unit Bank No. 2

Length, thirty-five inches; width, twenty-eight and one-half inches, outside measure. It has a working space at the front thirty-three inches long by sixteen and three-quarters inches wide, inside measure. At the back is an adjustable lead and slug rack divided into sections, each four and one-quarter inches wide. This rack is slotted at intervals of two picas and the division strips can be adjusted to meet requirements.

Cap pieces add two and three-quarters inches and base piece two inches to height.

For List Prices and general description of the Reversible Unit Cabinets and Banks, see preceding page.

Units occupy floor space 25x35 inches; height 19 inches

The American Steel Run Cabinet No. 2

This new Cabinet is an exclusive design of the American Type Founders Company, and embodies the latest ideas in cabinet construction. It contains forty-four extra depth cases, one or more of which may be placed on top. These justifying cases and the individual lead and slug case on upper bank, are removable. Underneath the bank are two deep copy drawers and a galley dump, nine by seventy-two inches.

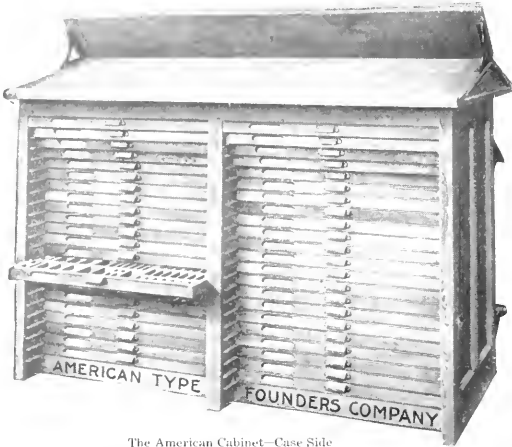

The American Cabinet—Case Side

or case may be placed on top. These justifying cases and the individual lead and slug case on upper bank, are removable. Underneath the bank are two deep copy drawers and a galley dump, nine by seventy-two inches.

This Cabinet may also be finished with plain work-bank without justifying cases. The individual lead and slug case, being removable, permits the upper bank to be used for upper cases when necessary.

List Price American Steel Run Cabinet

The American Cabinet with plain bank, forty-eight standard California job cases, with label mortises, in body, galley bank, copy drawers, etc. \$97 00

Prices of Equipment and Extras

Justifying cases, and mortise in lower bank to receive them. 6 00
 Nine-inch Bettis Lead and Slug Case No. 7 on upper bank. 5 00
 Blue Steel Foot Rail 6 00
 Electric wiring and fixtures complete 10 00

The American Steel Run Cabinet can also be furnished with a special assortment of cases if desired. We shall be pleased to mail you a circular thoroughly describing this splendid piece of furniture.

Height to top of upper bank, fifty-seven inches; floor space, twenty-four by seventy inches.

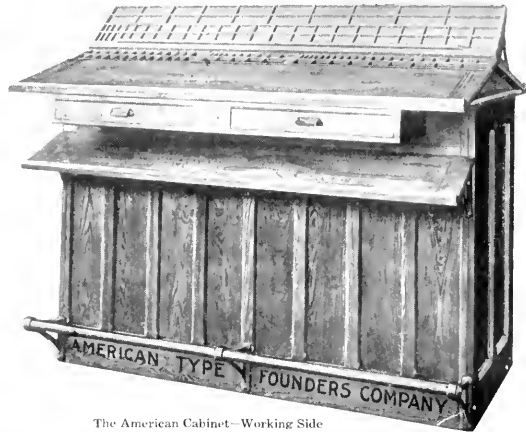

The American Cabinet—Working Side

The Porter Extension Front Steel Run Cabinet

This Cabinet possesses distinctive features which are found in no other cabinet, and which place it at the very front rank of all cabinets. It has been thoroughly tried by extensive printing establishments in all parts of the world, and all who have used it are enthusiastic in its praise. It has also been adopted in the Government Printing Office, at Washington, D. C.

The distinct feature of this Cabinet is the extension of the front. This enables the compositor to draw any case well out beyond the other cases, and makes the back tier of type boxes as accessible as any boxes in the case. It also allows, owing to the absence of extension side rails, the use of job cases on the brackets. The extension front also permits the top or bottom cases to be drawn from their places and placed at the proper height for type setting purposes.

Combined with the improved steel run and the extension front, the Porter Cabinet has all the excellent features of other steel run cabinets. The depth of the extension front is four inches. As these Cabinets are fitted on the twenty-three case and forty-six case sizes, with patented tilting brackets, they can be attached so that news cases on top are on the opposite side from the job cases. Unless otherwise stated, all Porter Cabinets are filled with California job cases.

The Porter Extension Front Steel Run Cabinets No. 6 and No. 7 have paneled backs while all other Cabinets of this series have plain backs. The cases ride upon the side rails only and the bottoms do not come in contact with the case runs.

The American Type Founders Company will always be pleased to offer practical suggestions to printers desiring to refurnish their composing rooms. We employ experts who are making this work a study and are responsible for some wonderful improvements for the printing office.

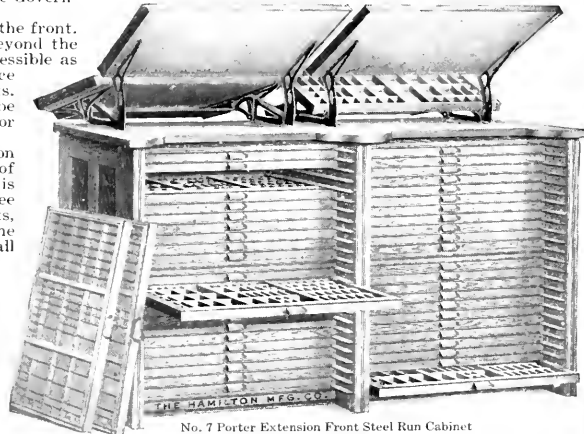

No. 7 Porter Extension Front Steel Run Cabinet

List Prices of Porter Extension Front Steel Run Cabinets

DESCRIPTION OF CABINET	Weight Crated Pounds	Height Inches	Length Inches	Depth Inches	Price Complete
No. 1. With 25 Cases, Single Tier, Flat Top	325	46	35½	22	\$ 43 00
No. 2. With 30 Cases, Single Tier, Flat Top	385	53¾	35½	22	51 00
No. 3. With 40 Cases, Single Tier, Flat Top	500	69	35½	22	68 00
No. 4. With 50 Cases, Single Tier, Flat Top	640	84	35½	22	85 00
No. 5. With 60 Cases, Single Tier, Flat Top	770	99	35½	22	100 00
No. 6. With 23 Cases, Single Tier with one pair No. 1 Tilting Brackets and one pair of News Cases on top	400	43	35½	22	45 00
No. 7. With 46 Cases, Double Tier with two pair No. 1 Tilting Brackets and two pair of News Cases on Top	725	43	69¾	22	90 00

The prices quoted are subject to prevailing discounts

The Masterman Composing Room Cabinet

The Masterman Composing Room Cabinet is the result of much thought and experimentation on the part of one of New York City's greatest printers. That these ideas were practical is proven by the large number of Masterman Cabinets in use in composing rooms where only the very best equipment is desired.

The evolution from the old style cases stand to the highly convenient and economical composing room equipment, a consummation of the Masterman Composing Room Cabinet has been remarkable. This Cabinet includes all the good features of any cabinet ever devised and it is safe to say that almost final perfection has already been achieved.

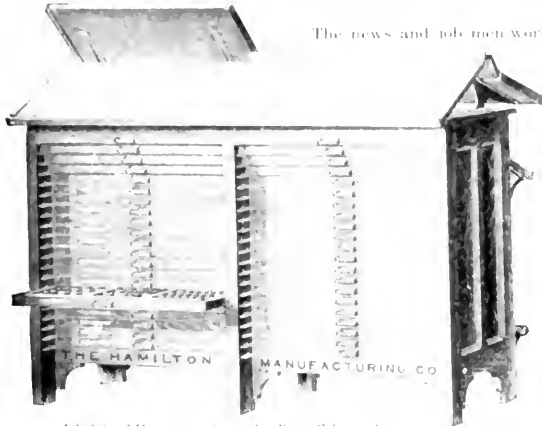

Job Side of Masterman Composing Room Cabinet showing forty-two job cases with gradual projection in top cases, and with plain 18x72 inch bank.

Equipment

Forty-two cases in the body of the Cabinet. Two pairs of No. 18 Brackets with detachable upper arms. Two job cases for the top, interchangeable with cases in Cabinet. Two double surface galley boards, thirty-two inches long.

Dimensions

Occupies floor space 21x70 inches. Height, floor to flat top, 11 inches. Clearance underneath for sweeping, 6 inches. Copy-drawer box projection, 11 inches. Size of two copy-drawers, 12 $\frac{1}{2}$ x22 $\frac{1}{2}$ x2 $\frac{1}{2}$ inches inside. Size of galley bank under copy box 38 $\frac{1}{2}$ inches. Lead and slug trays, 32 inches long; sloping face 23 picas wide; horizontal face, 11 picas. Sloping galley board between the cases on top, 7 $\frac{1}{2}$ inches wide. Foot rail, 1 5-16 inches diameter. Rail and supporting brackets polished and blued. Plain dump on job side, 18x72 inches. Label-holder mortises, 1x5 inches.

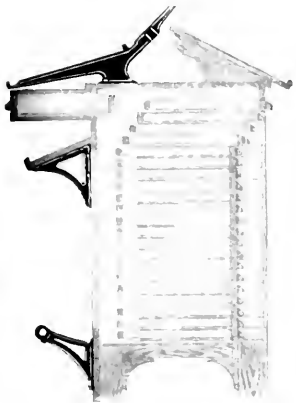

Sectional view of Masterman Composing Room Cabinet showing position of job cases, foot rail, supplementary galley bank, copy-drawer box and the brackets and 18x72 inch bank on top.

on opposite side. It provides a convenient means for transferring the cases and is supported on heavy flat feet on all sides. The angle projecting copy-drawer under the composing cases. The plain bank on the job side can be used independently or it will take a standard cylinder by seventy-two inch Bell case. It has detachable upper bracket arms, so that the top case can be used in box form, dispensing with the cap case and using job case only. By attaching the bracket, pairs of new cases can be used in the same form. Where job cases are used on the lower part of bank, it leaves room for storage of lead and slugs. The most distinctive feature is the gradual projection of the case line in the four upper cases in each tier. This allows these upper cases to be withdrawn as they have extension rails. The bank compartment are accessible without taking the cases from the case. Another attractive feature is the mortised label holders with transparent celluloid covers, size three-quarters by six inches.

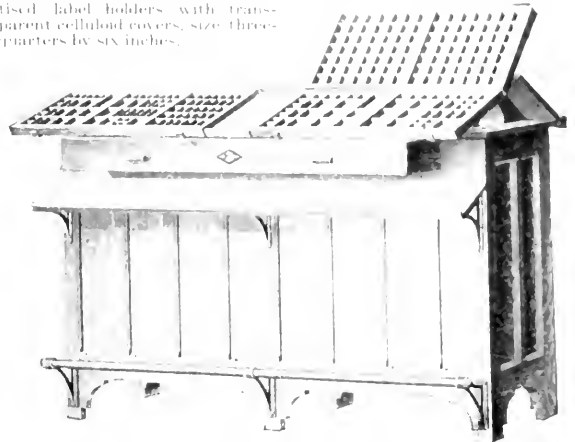

News Side of Masterman Composing Room Cabinet showing galley board and foot rail. One end showing news cases in place, the other end with job case arrangement and lead bank above.

List Prices of the Masterman Composing Room Cabinet and Extras

Complete with cases, brackets, copy box and 18-inch bank	\$90 00
Extra for galley dump under copy drawers	5 00
Extra for polished and blued foot rail	6 00
Extra for label-holder mortises in case fronts, with celluloid covers	2 50
Weight, crated for shipment, 800 pounds.	

One may easily imagine the beautiful appearance twenty or more Masterman Cabinets finished in Mission style would make, and how handy they would be for the compositors. With them there is a place for everything and everything in its place. If the desire is to have style combined with practicability, there is nothing better than the Masterman. The work-day hours are shorter than they were and labor and rents are climbing. These conditions make it necessary for printers to study economy as to space and time. In the larger cities these are both prominent factors, and the desire has been to equip with such composing room furniture as will not only save floor space, but also save the employees time in doing their work. With the handy Masterman Composing Room Cabinets these difficulties are greatly overcome.

The American Type Founders Company will be pleased to quote prices on any special furniture that you may require. Its representatives may be called upon at any time to confer with you and offer suggestions that will materially assist you in your work. Unquestionably the American Type Founders Company is the largest dealer in printing office outfits in the world, and there is no other concern so competent to advise you.

Handy Sort Cabinets

The Handy Sort Cabinets are very compact and will hold an immense amount of material within a small floor space. A cabinet of this kind should supplant the various tin can and cigar box arrangements which are to be found in so many printing offices. Such makeshift arrangements are most wasteful of time and material, while Handy Sort Cabinets, when properly equipped, filled and labeled are decidedly economical. The cabinets are made of hardwood throughout and are nicely finished. Drawers are eight and one-half by twenty inches over all and two and one-eighth inches deep inside. Each drawer is divided into ten compartments, each compartment three and one-fourth by three and one-eighth by two and one-eighth inches inside. Brass label holders attached to any cabinet at an addition to the list price of five cents for each holder.

List Prices and Dimensions of Handy Sort Cabinets

CABINETS	Number of Tiers	Number of Drawers	Depth Inches	Length Inches	Height Inches	Weight Crated Pounds	List Price
No. 1	1	10	21	11 $\frac{1}{2}$	35	100	\$17 50
No. 2	2	20	21	21 $\frac{1}{2}$	35	165	27 00
No. 3	3	30	21	30 $\frac{1}{2}$	35	230	36 00
No. 4	4	40	21	40	35	290	45 00
No. 5	5	50	21	49 $\frac{1}{2}$	35	350	54 00

Prices subject to prevailing discounts



Handy Sort Cabinet No. 3

The Ad-Man's Cabinet

The Ad-Man's Cabinet is designed to meet the requirements of the ad-man who must necessarily have recourse to an abundance and great variety of material. The aim is to place all this material directly before the workman in the most convenient form. The two tiers of cases and other equipment are reversed, both sides of the Cabinet being alike. A two-faced lead and slug bank is supported by uprights over the working top; this bank has adjustable partitions providing separate compartments on each side for leads and slugs. This entire lead and slug bank can be raised or lowered six inches. Four men can work at the Cabinet on straight work without interference, two on each side. The ad-man places his type case at the right hand end of the working top. He will have before him within reach his leads and slugs. At his left on the working top he will place a large dumping galley; his copy drawer will be directly under the working type case; under the copy drawer on the supplementary bank he can place another dumping galley. The illustration shows the Cabinet fully equipped with electric lights, mortised label holders and foot rails, which are listed as extras. The inverted V-shaped lead and slug bank has electric lights arranged inside where the direct rays will not reach the workman's eyes.

List Prices and Dimensions of Ad-Man's Cabinets

Occupies floor space, 23¹/₂x70¹/₂ inches; height to apex of Cabinet proper, 53 inches; height to apex of adjustable lead and slug bank, maximum, 74 inches; minimum, 68 inches. Weight, crated for shipment, 950 pounds. Cabinet No. 1, 24 regular cases in each tier

\$120 00

Cabinet No. 2, 22 extra deep cases in each tier

120 00

List Prices for Extras for Ad-Man's Cabinets

Electric light equipment complete for attachment, including sockets, shades, switch and elongated lamps over each tier of cases and under the lead and slug bank

15 00

Mortised Label Holders complete for Cabinet No. 1

2 88

Mortised Label Holders complete for Cabinet No. 2

2 64

Two foot rails for either cabinet

7 00

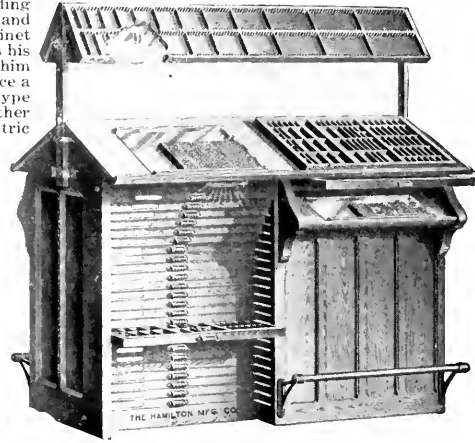

Ad-Man's Cabinet

Tracy Cabinets

The popularity of the Tracy Cabinets is amply demonstrated by the fact that large numbers of them have been installed in the leading printing plants throughout this and foreign countries.

Has flat steel runs providing a five-inch extension front. No brackets are required as the solid top serves as a working bank on both sides, or for the accommodation of case equipment. The top is removable and adjustable.

No. 28 Tracy Cabinet is illustrated with forty-eight standard depth California job cases. Has solid, removable, reversible and adjustable top permitting four-inch change in the overhang. Takes eighteen by seventy-two-inch Bettis Case on one side. The news side will take two full size job cases at the front and a nine by seventy-two inch lead and slug case at the back. Two pairs of news cases can be put in place on this side of top when required.

Floor space twenty-eight by seventy and one-half inches. Height at front forty-three and one-quarter inches. Extreme height at top fifty-eight and one-quarter inches. Working bank eighteen by seventy-two inches. Weight, crated for shipment, eight hundred and fifty pounds.

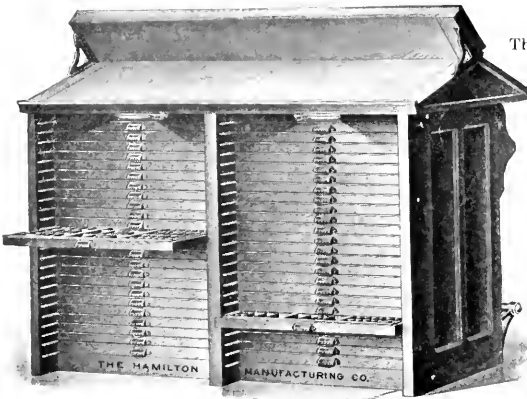

No. 28 Tracy Cabinet with forty-eight Standard California Job Cases and two copy drawers

List Prices of Tracy Cabinets

No. 28 Tracy Cabinet with forty-eight Standard California job cases and two copy drawers

\$97 00

The No. 29 Tracy Cabinet is the same as No. 28, except for the omission of two copy drawers and supplementary galley bank under copy drawers. Price, with forty-eight Standard California job cases

90 00

List Prices for Extras for Tracy Cabinets

No. 8 Bettis Lead and Slug Case

5 00

Nine-inch Lead and Slug Case

4 00

Polished and blued foot rail

6 00

Mortised Label Holders, with celluloid covers, each

06

Number Tacks attached to case fronts or cabinet rails, each

05

Electric Light Equipment complete, with Lamps and Shades

10 00

Extra deep cases can be supplied at the following difference in list price:

With 44 cases, with 1¹/₈ inch slats; add list

2 00

With 40 cases, with 1¹/₁₆ inch slats; add list

6 00

With 34 cases, with 1¹/₃₂ inch slats; add list

10 00



Reverse side of No. 28 Tracy Cabinet showing adjustable and removable top

Strip Lead and Rule Cabinet

A most convenient Cabinet for the storage of full lengths of leads, slugs and brass rule. No device of the kind has heretofore been offered printers, and this little Cabinet will surely find a prominent place. It is thoroughly well made of hardwood, with the ends paneled, finished antique, same as the best of our cabinet work. There are seventeen vertical compartments one inch wide, six inches in height, at the top of the Cabinet, which will take twenty-four-inch lengths of brass rule. Under the rule compartments are twenty vertical compartments thirteen-sixteenths of an inch wide, nine inches in height, which will accommodate twenty-four-inch lengths of leads and slugs. On the right-hand end, underneath the overhanging top is placed a drawer, running full depth of the cabinet and containing two compartments to receive the cuttings from the mitering machine and the lead cutter; the cuttings being dropped into the drawer by means of an opening through the hardwood top into each compartment, one compartment for leads and one for brass. The drawer is removable and can be dumped as required. At the bottom is a large compartment for storing the mitering machine and the lead cutter, when not in use, thus allowing the top to be used for other working purposes. The front of Cabinet is closed by two swinging doors, fastened by lock, which secures the valuable material stored therein under direct care of the foreman or party holding the key.

List Price and Dimensions of Strip Lead and Rule Cabinet

Occupies floor space 22¹/₂x26 inches; height, 38 inches. List price \$40 00

Prices are subject to prevailing discounts

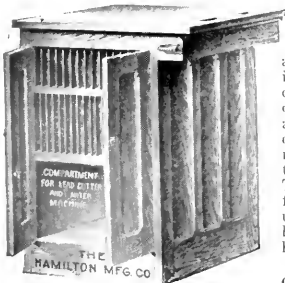

Strip Lead and Rule Cabinet

New Departure Type Cabinets

The New Departure Type Cabinets are constructed of hardwood, finished antique, the ends are tastefully paneled and moulded, and the fronts ornamented and fitted with bronzed pulls. The

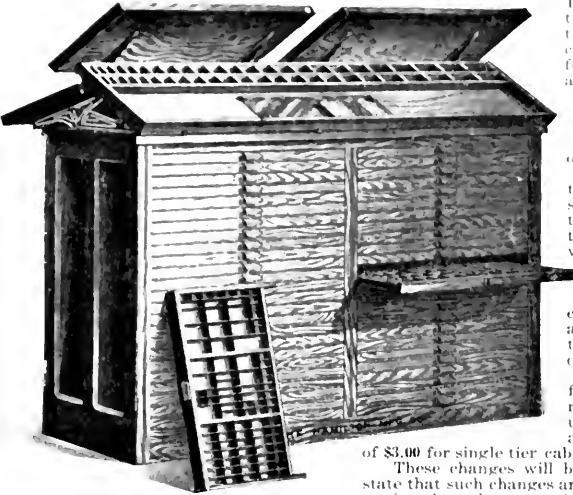

No. 68 New Departure Cabinet with Top Equipment

cases are of our best New Departure pattern. The New Departure Type Cabinets possess all the advantages of other cabinets and have the remarkable feature of combining from twenty-five to thirty-three cases within the height of forty-three inches, which is the correct height for a flat top cabinet with cases and brackets on top for typesetting purposes. This represents a gain of thirty-three and one-third per cent. in case capacity over the best steel run construction heretofore offered to printers. These steel runs are thin pieces of steel of great strength, fitted into saw-kerfs cut in the sides of the Cabinet and held in place by means of lips on the ends of the runs, so that such runs cannot possibly get out of place or become loose.

These flat steel runs were originated and perfected more than ten years ago, and have been in continual use in steel run stands since that time. They have given such universal satisfaction that they are now incorporated in this line of Steel Run Cabinets. Owing to the fact that the cost of constructing these Cabinets is somewhat less than the regular steel run construction, the prices on them are somewhat lower than those of other cabinets shown.

Of all the cabinets shown within these pages, the No. 62 New Departure has had the greatest sale of any. Of this particular Cabinet there have been manufactured and sold each year about one thousand. This certainly emphasizes the popularity of the No. 62, which has a single tier and contains twenty-five standard size California job cases of regular depth.

The No. 68, another popular style, has two tiers containing fifty full size job cases. Both the No. 62 and the No. 68 are fairly representative of the whole line of New Departure Cabinets, so it is unnecessary to illustrate them further. All the cabinets are flat top and if galley tops are wanted, there will be an additional charge

of \$3.00 for single tier cabinets and \$6.00 for double tier cabinets.

These changes will be made whenever desired, but in ordering it will be necessary to state that such changes are wanted in order to secure them. This is imperative. The illustration above, however, shows the No. 68 New Departure Flat Top Cabinet with a top equipment made up as follows: Two pairs No. 2 Three Case Tilting Brackets, two pairs of News Cases and one No. 8 Bettis Lead and Slug Case. The individual prices of these articles

may be found in other parts of this catalogue. The No. 68 New Departure Cabinet is of standard dimensions containing fifty regular full size California Job Cases in two tiers, or twenty-five cases in each tier. This cabinet occupies a floor space twenty-one by sixty-nine and seven-eighths inches, the height is forty-three inches. The top equipment may be selected to suit the customer.

The seven special cabinets described below with a variety of cases, have a uniform height of forty-three inches, which is the correct height for typesetting purposes. These cabinets represent an achievement in type case construction never before attained. Heretofore the most compact cabinets have contained only twenty-five cases in the height of forty-five inches; here we have cabinets containing thirty-three cases all within the height of forty-three inches, and all of the cases deep enough for practical purposes except for the very largest fonts of metal type. In two cabinets, Nos. 64 and 70, containing cases of four different depths, we have a result of twenty-eight cases within forty-three inches, and some of these cases are unusually deep, thus accommodating the very largest sizes of metal type. All of the cabinets in the detailed list, as given below, with the following seven exceptions contain cases of standard depth, one and three-eighths inches outside the front.

No. 51 contains thirty-three two-thirds size cases sixteen and five-eighths by twenty-one and three-quarters inches outside measure. The cases have a uniform depth of one inch outside the front and are deep enough for all medium and small sizes of metal type without doubling fonts.

No. 57 contains thirty-three three-quarter size cases, size sixteen and five-eighths by twenty-six and one-half inches outside measure. The cases have a uniform depth of one inch outside the front and are deep enough for all medium and small sizes of metal type without doubling fonts.

No. 63 contains thirty-three full size cases, size sixteen and five-eighths by thirty-two and one-quarter inches outside measure. The cases have a uniform depth of one inch outside the front and deep enough for all medium and small sizes of metal type without doubling fonts.

No. 64 contains twenty-eight full size cases, size sixteen and five-eighths by thirty-two and one-quarter inches outside measure. These cases are of four different depths; five cases are three-quarters of an inch, ten cases are one inch, ten cases are standard one and three-eighths inches and three cases are extra deep, being one and three-quarters inches, all measured outside the front.

No. 69 is a two-tier cabinet, containing sixty-six full size cases, size sixteen and five-eighths by thirty-two and one-quarter inches outside measure. There are thirty-three cases in each tier. All cases have a uniform depth of one inch outside the front and are deep enough for all medium and small sizes of metal type without doubling fonts.

No. 70 is a two-tier cabinet containing fifty-six full size cases, size sixteen and five-eighths by thirty-two and one-quarter inches outside measure. There are twenty-eight cases in each tier of four different depths; five cases are three-quarters of an inch, ten cases are standard one and three-eighths inches and three one and three-quarters inches, all measured outside the front.

No. 72 contains three tiers of full size cases and represents New Departure Cabinets Nos. 62, 63 and 71 combined. The center tier contains thirty-three cases one inch deep outside, and one tier contains twenty cases one and three-quarters inches deep outside of fronts. A total of seventy-eight cases of the three most convenient depths.

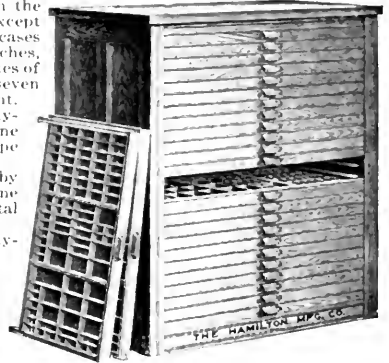

No. 62 New Departure Cabinet

List Prices and Dimensions of New Departure Type Cabinets

No.	Number of Cases	Number of Tiers	Size of Cases Outside Measure	Depth of Cases Outside Front	Floor Space	Height	Weight	Price
50	25	Single tier	Two-thirds 16 $\frac{5}{8}$ x 21 $\frac{1}{4}$ inches	Standard 1 $\frac{3}{8}$ inches	21x24 $\frac{1}{2}$ inches	43 inches	230 pounds	\$29 00
51	33	Single tier	Two-thirds 16 $\frac{5}{8}$ x 21 $\frac{1}{4}$ inches	Special 1 inch	21x24 $\frac{1}{2}$ inches	43 inches	260 pounds	37 00
52	30	Single tier	Two-thirds 16 $\frac{5}{8}$ x 21 $\frac{1}{4}$ inches	Standard 1 $\frac{3}{8}$ inches	21x24 $\frac{1}{2}$ inches	52 inches	280 pounds	34 50
53	40	Single tier	Two-thirds 16 $\frac{5}{8}$ x 21 $\frac{1}{4}$ inches	Standard 1 $\frac{3}{8}$ inches	21x24 $\frac{1}{2}$ inches	67 inches	390 pounds	45 00
54	50	Single tier	Two-thirds 16 $\frac{5}{8}$ x 21 $\frac{1}{4}$ inches	Standard 1 $\frac{3}{8}$ inches	21x24 $\frac{1}{2}$ inches	82 inches	430 pounds	56 50
55	50	Double tier	Two-thirds 16 $\frac{5}{8}$ x 21 $\frac{1}{4}$ inches	Standard 1 $\frac{3}{8}$ inches	21x19 $\frac{1}{2}$ inches	43 inches	110 pounds	57 00
56	25	Single tier	Three-quarters 16 $\frac{5}{8}$ x 26 $\frac{1}{2}$ inches	Standard 1 $\frac{3}{8}$ inches	21x29 $\frac{1}{2}$ inches	43 inches	250 pounds	34 50
57	33	Single tier	Three-quarters 16 $\frac{5}{8}$ x 26 $\frac{1}{2}$ inches	Special 1 inch	21x29 $\frac{1}{2}$ inches	43 inches	275 pounds	43 00
58	30	Single tier	Three-quarters 16 $\frac{5}{8}$ x 26 $\frac{1}{2}$ inches	Standard 1 $\frac{3}{8}$ inches	21x29 $\frac{1}{2}$ inches	52 inches	300 pounds	39 50
59	10	Single tier	Three-quarters 16 $\frac{5}{8}$ x 26 $\frac{1}{2}$ inches	Standard 1 $\frac{3}{8}$ inches	21x29 $\frac{1}{2}$ inches	67 inches	100 pounds	52 00
60	50	Single tier	Three-quarters 16 $\frac{5}{8}$ x 26 $\frac{1}{2}$ inches	Standard 1 $\frac{3}{8}$ inches	21x29 $\frac{1}{2}$ inches	82 inches	100 pounds	63 50
61	50	Double tier	Three-quarters 16 $\frac{5}{8}$ x 26 $\frac{1}{2}$ inches	Standard 1 $\frac{3}{8}$ inches	21x58 $\frac{1}{2}$ inches	43 inches	115 pounds	64 25
62	25	Single tier	Full size 16 $\frac{5}{8}$ x 32 $\frac{1}{4}$ inches	Standard 1 $\frac{3}{8}$ inches	21x35 $\frac{1}{4}$ inches	43 inches	300 pounds	38 75
63	33	Single tier	Full size 16 $\frac{5}{8}$ x 32 $\frac{1}{4}$ inches	Special 1 inch	21x35 $\frac{1}{4}$ inches	43 inches	330 pounds	49 00
64	28	Single tier	Full size 16 $\frac{5}{8}$ x 32 $\frac{1}{4}$ inches	Special four depths	21x35 $\frac{1}{4}$ inches	43 inches	310 pounds	42 50
65	30	Single tier	Full size 16 $\frac{5}{8}$ x 32 $\frac{1}{4}$ inches	Standard 1 $\frac{3}{8}$ inches	21x35 $\frac{1}{4}$ inches	52 inches	360 pounds	45 00
66	10	Single tier	Full size 16 $\frac{5}{8}$ x 32 $\frac{1}{4}$ inches	Standard 1 $\frac{3}{8}$ inches	21x35 $\frac{1}{4}$ inches	67 inches	185 pounds	59 25
67	50	Single tier	Full size 16 $\frac{5}{8}$ x 32 $\frac{1}{4}$ inches	Standard 1 $\frac{3}{8}$ inches	21x35 $\frac{1}{4}$ inches	82 inches	585 pounds	72 50
68	50	Double tier	Full size 16 $\frac{5}{8}$ x 32 $\frac{1}{4}$ inches	Standard 1 $\frac{3}{8}$ inches	21x67 $\frac{1}{2}$ inches	43 inches	600 pounds	71 00
69	66	Double tier	Full size 16 $\frac{5}{8}$ x 32 $\frac{1}{4}$ inches	Special 1 inch	21x67 $\frac{1}{2}$ inches	43 inches	670 pounds	93 00
70	56	Double tier	Full size 16 $\frac{5}{8}$ x 32 $\frac{1}{4}$ inches	Special four depths	21x67 $\frac{1}{2}$ inches	43 inches	630 pounds	81 00
71	20	Single tier	Full size 16 $\frac{5}{8}$ x 32 $\frac{1}{4}$ inches	Special 1 $\frac{3}{8}$ inches	21x35 $\frac{1}{4}$ inches	43 inches	275 pounds	38 00
72	78	Three tiers	Full size 16 $\frac{5}{8}$ x 32 $\frac{1}{4}$ inches	Special three depths	21x103 $\frac{1}{4}$ inches	43 inches	850 pounds	113 00

All the above prices and descriptions are for flat top cabinets. If wanted with galley tops add to the price given for single tier cabinets \$3.00, and for double tier cabinets \$6.00. Brass label holders attached to cabinet at an additional price of five cents per case, list. Add for paneled backs, single tier, \$2.50; for two tiers, \$1.00; for three tiers, \$5.50

Wisconsin Window Cabinet

The Wisconsin Window Cabinet differs from other flat top cabinets in the arrangement of the top, which projects behind seven inches. Two pairs of brackets are placed so as to face the cases to the sides. The top is cleated to prevent the projecting top from being broken. The back is paneled.

Designed for placing in front of a window, as it does not obstruct the light. Two men may work undisturbed at the sides, while the job cases in front are convenient for the job men.

This Cabinet has the patent Tilting Bracket with galley rest, which enables a compositor to empty his stick without leaving the Cabinet, by simply tilting his lower case, thus exposing the galley board.

Made in ash, with antique finish. Bottom is made flush to floor to prevent dirt from getting underneath Cabinet.

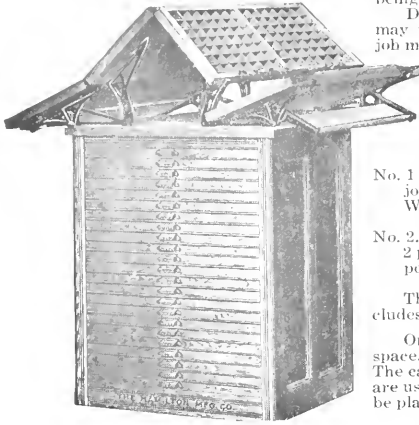

No. 2 Wisconsin Window Cabinet

List Prices and Dimensions of Wisconsin Window Cabinets

No. 1 Wisconsin Window Cabinet, with wood runs and filled with 18 full size California job cases, 2 pairs of news cases and 2 pairs of Patent Tilting Brackets No. 1 on top. Weight, 350 pounds. List price \$36 00

No. 2. With 23 full size California job cases and steel runs, 2 pairs of news cases and 2 pairs of patent Tilting Brackets No. 1 on top, same height as No. 1. Weight, 375 pounds. List price 47 00

The width is 35 $\frac{1}{4}$ inches, height, 43 inches, depth 21 $\frac{1}{2}$ inches. The weight given includes the cases and brackets on top, all crated, ready for shipment.

One of the great advantages of this Cabinet is that it saves twenty-five per cent in floor space. Each can be utilized for body type composition by attaching case brackets on top. The capacity of the type cases for holding type is not reduced in the least as regular cases are used. The saving of space is attained by using the steel runs, which allow the cases to be placed more compactly in the Cabinet.

Wisconsin Steel Run Cabinets

The Wisconsin Steel Run Cabinets for many years have been considered very moderate priced cabinets. There are today hundreds upon hundreds of them in use throughout the country giving entire satisfaction. To those printers who do not wish to invest in the higher-priced printing office furniture, we have no hesitancy in recommending the Wisconsin Steel Run. While we have illustrated but one of these Cabinets, by referring to the list below, it will be seen that the Wisconsin is made in a great many styles and it should be an easy matter to make a selection of the size best suited to your purpose. If requested, we will supply any additional information required regarding these Cabinets.

The American Type Founders Company is the largest dealer in printing office requisites in the world, and is in a position to give its customers better service than can be obtained elsewhere. We are always ready to give quotations on anything special that may be required. Correspondence is invited on subjects pertaining to the equipment of a printing plant.

There are no better Cabinets made for all around general use than are represented in the Wisconsin Steel Run Cabinets. They are substantially constructed of selected hardwoods, beautifully finished in antique shade of color, and will prove an ornament in any office wherever installed. They represent the maximum of case concentration and are space savers in the fullest sense of the term. All these Cabinets have paneled sides with tastefully moulded edges.

The one, two and three-tier Wisconsin Steel Run Cabinets with flat tops and holding twenty-five cases in each tier, can be utilized for body type composition by attaching case brackets on top. Accommodating twenty-five cases in the space usually taken up by eighteen or twenty cases in the ordinary cabinet or stand, it saves twenty-five per cent in the floor space. The capacity of the type cases for holding type is not reduced in the least, as regular cases are used. The saving in space is attained by using the Steel Runs, which allow the cases to be placed more compactly in the Cabinet.

The proper Brackets to use on the top of a Cabinet forty-four and one-quarter inches in height are as follows:

- No. 6, Style A. Double Case Bracket to attach to the edge of the Cabinet. List price, per pair \$1 50
- No. 7, Style B. Double Case Bracket to set on the flat top. List price, per pair 1 25
- Patent Tilting Bracket No. 1. To set on the flat top. List price, per pair 2 00
- No. 2. Three-Case Tilting Bracket to set on the flat top—takes 18-inch dump at the back. List price, per pair 2 40
- No. 4. Three-Case Bracket to set on the flat top—takes 18-inch dump at the back. List price, per pair 1 90

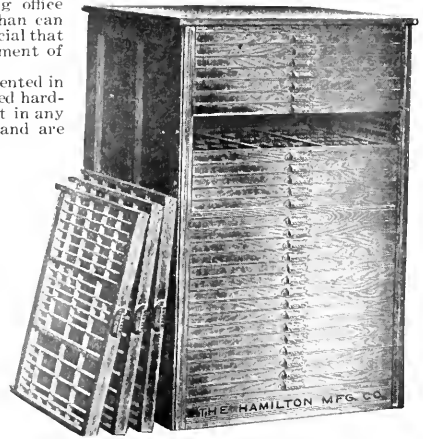

No. 122 Wisconsin Steel Run Cabinet. Flat Top

List Prices and Dimensions of Wisconsin Steel Run Cabinets

ORDER BY NUMBER ONLY	OUTSIDE DIMENSIONS			Weight Pounds	WITH FLAT TOP		WITH GALLEY TOP		WITH FLAT TOP, BLANK CASES		
	SIZE AND NUMBER OF CASES CONTAINED	Height Inches	Width Inches		Depth Inches	No. of Cabinet	Price	No. of Cabinet	Price	No. of Cabinet	Price
20 Two-Third Cases in one tier	37 $\frac{3}{4}$	25 $\frac{1}{4}$	21	180	100	\$ 25 00	200	\$ 28 00	300	\$ 21 00	150
25 Two-Third Cases in one tier	45	25 $\frac{1}{4}$	21	225	101	30 00	201	33 00	301	25 00	190
30 Two-Third Cases in one tier	53 $\frac{1}{4}$	25 $\frac{1}{4}$	21	275	102	35 00	202	38 00	302	29 00	230
40 Two-Third Cases in one tier	69	25 $\frac{1}{4}$	21	350	103	48 00	203	52 00	303	40 00	290
50 Two-Third Cases in one tier	84	25 $\frac{1}{4}$	21	425	104	60 00	204	65 00	304	50 00	350
50 Two-Third Cases in two tiers	45	48 $\frac{1}{4}$	21	425	105	60 00	205	65 00	305	50 00	350
75 Two-Third Cases in three tiers	45	72 $\frac{1}{4}$	21	600	106	88 00	206	95 00	306	73 00	480
60 Two-Third Cases in one tier	99	25 $\frac{1}{4}$	21	475	107	72 00	207	78 00	307	60 00	385
60 Two-Third Cases in two tiers	53 $\frac{1}{4}$	48 $\frac{1}{4}$	21	475	108	72 00	208	78 00	308	60 00	385
90 Two-Third Cases in three tiers	53 $\frac{1}{4}$	72 $\frac{1}{4}$	21	700	109	105 00	209	113 00	309	88 00	575
20 Three-Quarter Cases in one tier	37 $\frac{3}{4}$	29 $\frac{3}{4}$	21	200	110	30 00	210	33 00	310	26 00	170
25 Three-Quarter Cases in one tier	45	29 $\frac{3}{4}$	21	250	111	35 00	211	38 00	311	30 00	215
30 Three-Quarter Cases in one tier	53 $\frac{1}{4}$	29 $\frac{3}{4}$	21	300	112	40 00	212	43 00	312	34 00	265
40 Three-Quarter Cases in one tier	69	29 $\frac{3}{4}$	21	400	113	53 00	213	57 00	313	45 00	340
50 Three-Quarter Cases in one tier	84	29 $\frac{3}{4}$	21	475	114	65 00	214	70 00	314	55 00	400
50 Three-Quarter Cases in two tiers	45	58	21	475	115	65 00	215	70 00	315	55 00	400
75 Three-Quarter Cases in three tiers	45	86 $\frac{1}{4}$	21	675	116	95 00	216	102 00	316	80 00	550
60 Three-Quarter Cases in one tier	99	29 $\frac{3}{4}$	21	550	117	78 00	217	84 00	317	66 00	460
60 Three-Quarter Cases in two tiers	53 $\frac{1}{4}$	58	21	550	118	78 00	218	84 00	318	66 00	460
90 Three-Quarter Cases in three tiers	53 $\frac{1}{4}$	86 $\frac{1}{4}$	21	800	119	112 00	219	121 00	319	95 00	650
20 Full Size Cases in one tier	37 $\frac{3}{4}$	35 $\frac{3}{4}$	21	250	120	35 00	220	38 00	320	31 00	220
25 Full Size Cases in one tier	45	35 $\frac{3}{4}$	21	300	121	40 00	221	43 00	321	35 00	265
30 Full Size Cases in one tier	53 $\frac{1}{4}$	35 $\frac{3}{4}$	21	350	122	45 00	222	48 00	322	39 00	305
40 Full Size Cases in one tier	69	35 $\frac{3}{4}$	21	475	123	60 00	223	64 00	323	52 00	415
50 Full Size Cases in one tier	84	35 $\frac{3}{4}$	21	575	124	75 00	224	80 00	324	65 00	500
50 Full Size Cases in two tiers	45	69 $\frac{3}{4}$	21	575	125	75 00	225	80 00	325	65 00	500
75 Full Size Cases in three tiers	45	103 $\frac{3}{4}$	21	800	126	110 00	226	119 00	326	95 00	680
60 Full Size Cases in one tier	99	35 $\frac{3}{4}$	21	650	127	90 00	227	96 00	327	78 00	560
60 Full Size Cases in two tiers	53 $\frac{1}{4}$	69 $\frac{3}{4}$	21	650	128	90 00	228	96 00	328	78 00	560
90 Full Size Cases in three tiers	53 $\frac{1}{4}$	103 $\frac{3}{4}$	21	900	129	130 00	229	140 00	329	113 00	750

These prices are subject to prevailing discounts

The Wisconsin Cabinets

Wisconsin Cabinets are all substantially made of selected, thorough, seasoned hardwood, beautifully finished, and made with double panels, tastefully moulded.

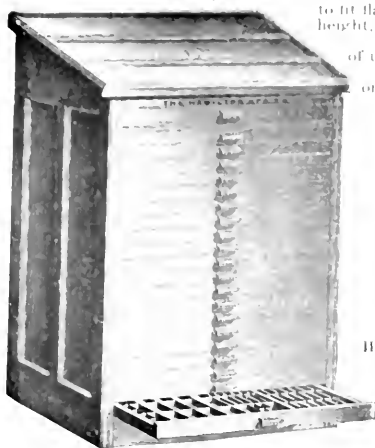

No. 27 Galley Top 20-Case Wisconsin Cabinet, with Copy Drawer

Bottoms are made flush with floor to prevent ink from getting underneath. Brackets are made to fit flat top Cabinets. Cases placed with these brackets on twenty-one Cabinet are regular height, forty-three inches from floor for typesetting purpose.

Wisconsin Cabinets are made in a handsome form, the wood being very hard and one of unusual strength, with excellent finishing qualities.

All Wisconsin Cabinets are fitted with New Department Case. These cases are on the side rails and the bottoms do not come in contact with the drawers.

List Prices of Wisconsin Wood-Run Cabinets

No.	Number of Cases	Height, inches	Width, inches	Depth, inches	Weight, lbs.	List Price	Net Price
19	12 Two-third cases	41 1/2	23 1/2	20 1/2	140	\$15 00	\$18 00
20	16 Two-third cases	43	25 1/2	20 1/2	170	18 00	21 00
21	20 Two-third cases	43	25 1/2	20 1/2	190	21 00	24 00
22	12 Three-quarter cases	41 1/2	29 1/2	20 1/2	180	18 00	21 00
23	16 Three-quarter cases	43	29 1/2	20 1/2	215	22 00	25 00
24	20 Three-quarter cases	43	29 1/2	20 1/2	245	26 00	29 00
25	12 Full Size cases	41 1/2	35 1/2	20 1/2	190	22 00	25 00
26	16 Full Size cases	43	35 1/2	20 1/2	225	26 00	29 00
27	20 Full Size cases	43	35 1/2	20 1/2	270	30 00	33 00

When ordering by number state clearly whether flat top or galley top Cabinet, and whether

The height of the galley top Cabinets is the same as the front as the flat top Cabinets. The backs of galley top Cabinets are six and three-quarter inches higher than given in the list for flat top Cabinets. All galley top Cabinets are supplied with an extra blank copy drawer at the top. This drawer will be found useful for the storage of copy and small tools used on the working bank of galley top Cabinets. It is also useful for the storage of electrotypes and small tied-up forms.



No. 27 Flat Top 20-Case Wisconsin Cabinet

Brackets for Use on Flat Top Cabinets

To get the full value of a flat top Cabinet of standard height, brackets and cases should be placed on top. See bracket section of this catalogue. The styles of brackets which will work most conveniently with these Cabinets are as follows:

- No. 6. Style A—Double Case Bracket, per pair \$1 50
- No. 7. Style B—Double Case Bracket, per pair 1 25
- No. 1. Hamilton Patent Tilting Bracket, per pair 2 00
- No. 2. Three-Case Tilting Bracket, per pair 2 40
- No. 4. Three-Case Bracket, per pair 1 90

Brass Label Holders attached to the cases in any Cabinet at an addition to the list price of five cents per case.

The City Stands

The upper case projects forward over the lower, bringing it near the compositor, who sets caps with greater ease than from the ordinary stand. Under the lower case there is a shelf to hold the galley, and the lower case may be pushed back (see cut) as far as is necessary to permit emptying type on galley without leaving stand.

The Single City Stands are made to hold fifteen full size cases, and the Double City Stands to hold thirty full size cases.

The City Stands are crated and shipped in knock-down form. The prices given are for stands only and do not include the cases on top or in the body of the stand. Case pulls to attach to the fronts of the cases in bulk, four cents each, list.

List Prices and Dimensions of City Stands

- No. 1. Single, with racks for 15 full size cases; weight, 55 pounds; occupies floor space 26x36 inches. List price \$5 75
- No. 2. Double, with racks for 30 full size cases; weight, 80 pounds; occupies floor space 26x70 1/2 inches. List price 8 00

The Polhemus Stands

The news compositor stands behind the job cases, where he works without being interrupted by the job men. He can empty his stick without leaving the stand, on a galley kept under the lower case, as the top cases are held on

Patent Tilting Brackets. Over the job cases there is a working bank or galley top, for keeping live and dead matter. Between the case racks on the No. 3 stand there is a galley cabinet.

The prices given below include the brackets, but not the cases on the brackets or in the body of the stand.

Double City Stand. Capacity 30 cases

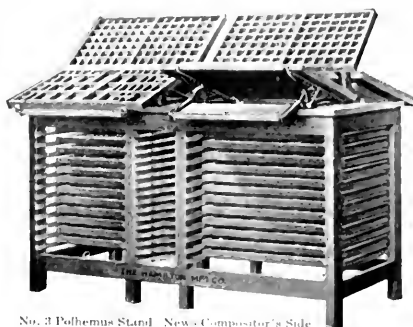

No. 3 Polhemus Stand. News Compositor's Stand

Polhemus Stands are crated and shipped in knock-down form.

List Prices and Dimensions of Polhemus Stands

- No. 1. Single, with rack for 12 full size cases; with brackets, 100 pounds; occupies floor space 20 1/2 x 36 inches. List price \$ 7 50
- No. 2. Double, with racks for 21 full size cases, and no galley cabinet; weight, 180 pounds; occupies floor space 26x70 1/2 inches. List price 13 00
- No. 3. Double, with racks for 12 full size cases, and 12 two-thirds cases, with galley cabinet; weight, 250 pounds; occupies floor space 20 1/2 x 71 1/2 inches. List price 20 00

Fly Sticks for Cylinder Presses

In small or large lots. We have special facilities for this class of work, and solicit an opportunity to quote to press builders.



Fly Sticks for Cylinder Presses

We can replace fly sticks on presses in use. List price, a dozen (weight, five pounds) . . . \$1 50

HAMILTON MFG. CO.

The Popular Steel Run Stands

No. 21 Steel Run Stand represents the maximum of case capacity. It is strongly made and durable, and will prove economical wherever installed. It is made with flat top and requires case brackets to hold the news cases. The job cases can be put into the racks from either side of the frame, and the steel runs are placed so close together as to require pulls on the fronts of the job cases to get best results. Regular cases can be put into the racks without planing off the fronts.

It has capacity for forty cases under the top. Brackets and cases for the top can be selected to meet the requirements. Several kinds of brackets can be used on this stand, as listed below.

The top equipment illustrated is as follows: Two pairs No. 2 three-case tilting brackets, one pair news cases, two blank cases, one thirty inch space and quad case, one No. 8 Bettis lead and slug case, and four quarter cases, as follows: Ideal brass leader case, compact rule case, time-table quarter case, Wisconsin quarter case, Style C. Occupies floor space twenty-one and one-half by seventy inches. Height from floor to flat top forty-four and one-eighth inches.

The prices given below are for stand only and do not include the cases in the body of the frame or the news cases on the top. Selections of case equipment can be made as requirements demand.

Prices given for brackets in the list below are net and any discount allowed on the Steel Run Stand does not apply on such brackets. Case pulls can be furnished in bulk to attach to the fronts of old cases for four cents each, list.

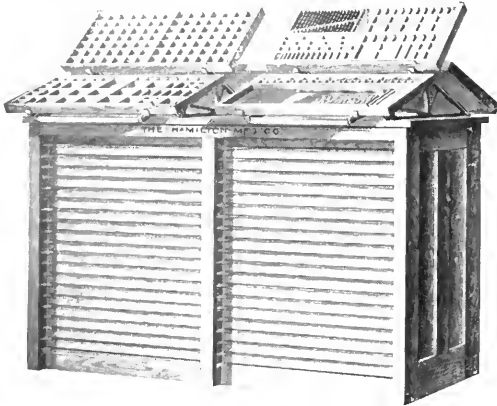

No. 21 Steel Run Stand—News Composer's Side

List Prices of No. 21 Steel Run Stand and Equipment

EQUIPMENT	Weight Pounds	Price
Stand only, open front	215	\$20 00
Stand only, closed plain front	260	23 50
Stand only, closed paneled front	255	25 00
Plain Galley Dump	30	3 50
No. 8 Bettis Lead and Slug Case, as illustrated	22	5 00
No. 9 New York Case Brackets, per pair	25	1 50
No. 7 Style B, Double Case Brackets, per pair	17	1 25
No. 1 Hamilton Patent Tilting Brackets, per pair	28	2 00
No. 2 Three-Case Tilting Brackets, per pair	35	2 40
No. 4 Three-Case Brackets, per pair	25	1 90
30-inch Space and Quad Case	1 1/4	75
News Cases, per pair	14	1 60

With the exception of the Case Brackets specified, prevailing discounts apply to this line of Steel Run Stands.

This excellent piece of cabinet work, Steel Run Stand No. 24, when fully equipped with New Departure Cases, represents the acme of Steel Run Stand construction, and the most advanced type of composing room equipment. The ends are paneled with neatly mottled edges. The back has seven panels with chamfered edges like a Polhemus Cabinet. The front rail is set back several inches, and the job cases, when in place set back several inches from the front, providing an extension front feature. This allows plenty of knee room for the compositor.

Constructed of hardwood throughout, with all exterior surfaces nicely varnished like the best of cabinets. The runs are of flat steel, capable of sustaining great weight.

This equipment, as illustrated, places the job compositor and the news compositor on opposite sides, so that there will be no interference.

The top equipment illustrated is as follows: Two pairs of No. 4 three-case brackets; one pair of news cases; two blank cases; one No. 8 Bettis lead and slug case, and four quarter-size cases as follows: One Perfection rule case, one Compact rule case, one All-right space and quad case, one Wisconsin quarter case, Style D. Under the top there are steel runs to accommodate forty full size cases.

The No. 8 Bettis lead and slug case is seventy-two inches long and has an eleven-inch blank space at the front to be used as a working dump. This space will take a ten by twenty-four inch galley. The compartments for leads and slugs in this case are one and one-half inches deep and for lengths from four to twenty-eight picas, varying by single picas, omitting the twenty-seven em length.

Occupies floor space twenty-two and one-half by seventy inches. Height, from floor to flat top forty-four and one-eighth inches.

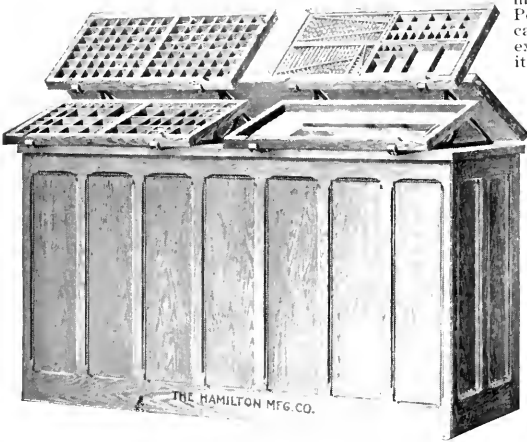

No. 24 Steel Run Case Stand—News Composer's Side

The prices given below are for stand only and do not include the cases in the body of the stand or the news cases on the top. Selection of case equipment can be made as requirements demand.

Prices given for brackets in the list are net, and any discount allowed on the Steel Run Stand does not apply on such brackets.

Case pulls can be furnished in bulk to attach to the fronts of old cases at four cents each, list.

List Prices of No. 24 Steel Run Stand and Equipment

EQUIPMENT	Weight Pounds	Price
Stand only, without top equipment	260	\$25 00
Plain Galley Dump	30	3 50
No. 8 Bettis Lead and Slug Case, as illustrated	22	5 00
No. 9 New York Case Brackets, per pair	25	1 50
No. 7 Style B, Double Case Brackets, per pair	17	1 25
No. 1 Hamilton Patent Tilting Brackets, per pair	28	2 00
No. 2 Three-Case Tilting Brackets, per pair	35	2 40
No. 4 Three-Case Brackets, per pair	25	1 90
News Cases, per pair	14	1 60

See additional illustrations and descriptive matter on following page

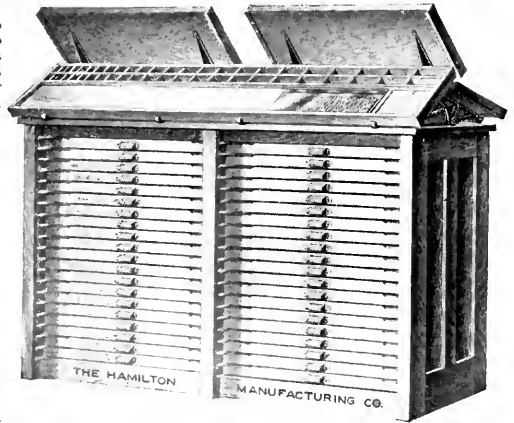

No. 21 Steel Run Stand—Job Composer's Side

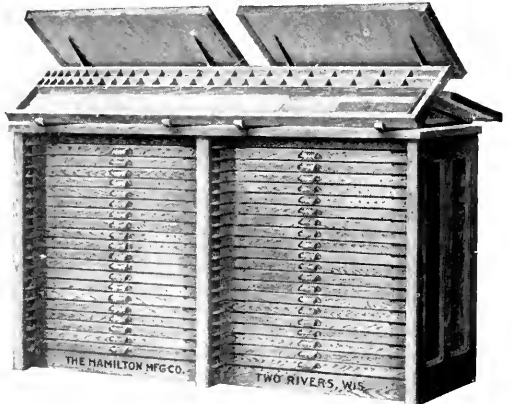

No. 24 Steel Run Case Stand—Job Composer's Side

The Popular Steel Run Stands

Modern Steel Run Stands place the job compositor and the news compositor on opposite sides, thus preventing all interference. Four men can work at the No. 22 Steel Run Stand continuously, and the saving in time will quickly pay for its cost. It is made of hardwood throughout, very strongly bolted, and the Steel Runs are New Departure style, let into saw kerfs and held in place by means of lips at the ends, which interlock with wooden strips. There are no nails or screws to become loose. The stand is practically indestructible, and will give lasting service.

The No. 22 Steel Run Stand requires no brackets, as it is built with a top to hold news cases. The job cases are put in from the back. There is ample knee room for the news compositor, as the cases do not come to a line at the front of the stand, but set back about five inches. The blank space between the two pairs of news cases will serve as a galley board and type matter can be placed in this space to advantage. It will also serve admirably as a lead and slug bank. Regular full size lip cases can be used and there is ample finger room between cases, so that pulls are not required. However, the withdrawing of the job cases is facilitated by attaching pulls to the case fronts.

Occupies floor space twenty-six by seventy inches. Height at front forty-four and three-quarters inches.

The prices given below are for the stand only and do not include the cases in the body of the frame or the news cases on top. Selection of case equipment can be made as requirements demand.

Case pulls can be furnished in bulk to attach to the fronts of old cases for four cents each, list.

List Prices of No. 22 Steel Run Stand

Capacity, Thirty-two Full Size Cases	Weight Pounds	Price
Open Front	285	\$25 00
Closed Plain Front	330	28 50
Closed Paneled Front	320	30 00

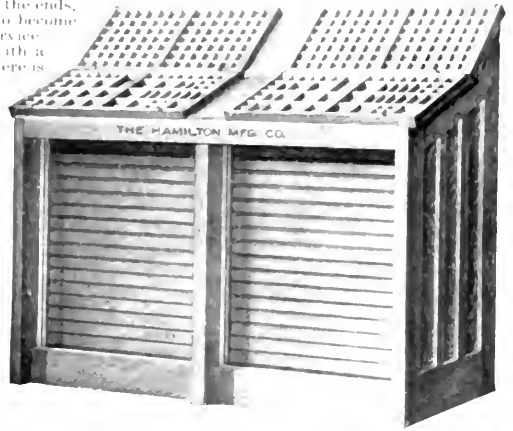

No. 22 Steel Run Stand, Front View, showing News Cases—Job Cases pull from the Rear

This is an excellent line of moderately priced printing office furniture as many satisfied customers will testify.

Steel Run Stand No. 23 has copy drawers under the news cases, and full length dump over the job cases. It also has other points of superiority and is most substantially and compactly built. It will give service for an indefinite period, and will prove ornamental as well as useful in any composing room. This stand is made with paneled front or with closed plain front. The news compositors and the job compositors are placed on opposite sides and there will be no interference. Four men can work continuously at the same stand, two on each side. Made of selected hardwood and finished like the best grades of cabinets. The runs are of flat steel, New Departure style, let into saw kerfs and held by lips, which interlock with wooden strips. These modern Steel Run Stands when filled with cases and fully equipped compare in every respect with the best of cabinets. The No. 23 Stand will take thirty-two full size lip cases arranged in two tiers, sixteen cases in each tier.

It requires no case brackets, as it is built with a top to hold news cases. The job cases are put in from the back, as the illustration shows. There is ample knee room at the side for the news compositors, as the cases do not come to a line at the front of the stand, but set back about five inches as shown. The blank space between the two pairs of news cases will serve as a galley board and type matter can be placed in this space to advantage. It will also serve admirably as a lead and slug bank. Regular full size lip cases can be used in all of these stands, and there will be ample finger room between cases, so that pulls will not be required. However,

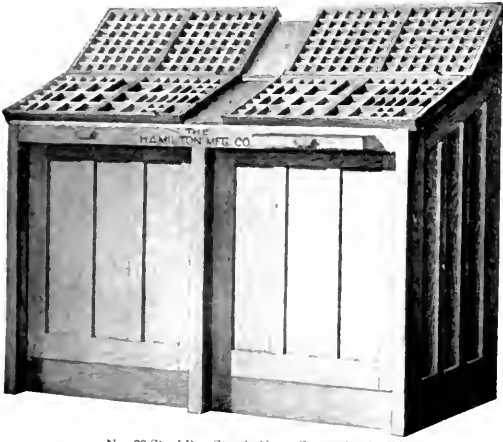

No. 23 Steel Run Stand—News Compositor's Side

the withdrawing of the job cases will be facilitated by attaching pulls to the case fronts. Occupies floor space twenty-six by seventy inches. Height at front, forty-four and three-quarters inches.

The prices below are for the stand only and do not include the cases in the body of the cabinet or the news cases on top. Selection of case equipment can be made as requirements demand.

Case pulls can be furnished in bulk to attach to the fronts of old cases at four cents each, list.

List Prices of No. 23 Steel Run Stand

Capacity, Thirty-two Full Size Cases	Weight Pounds	Price
Open Front	300	\$30 00
Closed Plain Front	345	33 50
Closed Paneled Front	340	35 00

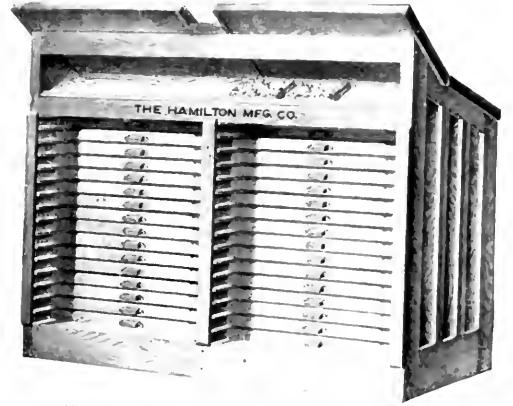

No. 23 Steel Run Stand, Showing Full Length Galley Dump

The prices quoted on this page are subject to prevailing discounts

Ruling Pen Cabinet

This is a convenient cabinet, which it has hitherto been difficult to obtain, except when made to order. It is a necessity in every bookbinding for the systematic storage of ruling pens.

Made of ash, finished antique, with three-ply veneer bottoms, which cannot crack or shrink, making a first-class piece of work in every respect. Each drawer has six compartments, three of

List Prices and Dimensions of Ruling Pen Cabinets

No.	Height Inches	Depth Inches	Width Inches	Weight Pounds	No. of Drawers	Price
1	13 ⁷ / ₈	13 ¹ / ₄	17	70	1	\$12 00
2	19 ³ / ₄	13 ¹ / ₄	17	100	6	11 00
3	25 ⁵ / ₈	13 ¹ / ₄	17	135	8	16 00
4	31 ¹ / ₂	13 ¹ / ₄	17	170	10	18 00

Other sizes can be made to order at proportionate prices.

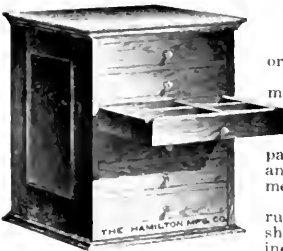

Ruling Pen Cabinet for Paper Rulers and Blank Book Makers

Every establishment doing paper ruling or blank book manufacturing should have one of these handy Cabinets. It often happens that its cost is saved in a very few months, for employees all appreciate a convenience which will permit of a systematic way

of storing ruling pens and requisites. Add one of these Cabinets to your plant and note the improvement in shop conditions.

Tracy Steel Run Stands

Economy in composing room equipment and cleanliness are combined in these stands. They comprise the latest development in steel run stand construction. No dust can accumulate under the cases on these stands, and there is no waste space.

Brackets have been disregarded, thus providing a solid board top, one side of which can be used as a working bank, or it will take a full length Bettis lead and slug case, eighteen inches wide. On the other side can be placed a pair of job cases on the lower section, and the upper board used as a galley bank or a lead and slug bank, or two pairs of news cases can be placed in the usual way. There are forty California job cases in the body of the Cabinet, taking twenty standard, full size, lip front cases in each tier. Under the news case bank there is an additional bank for the storage of galleys containing type matter.

This bank is nine inches wide and extends the full length of the Cabinet. Immediately over this bank are two copy drawers ten and three-quarters by thirty-one inches inside. The tops are removable and adjustable, thus allowing a movement of four inches to control the overhang, which can be thrown to either side of the stand to the extent of four inches.

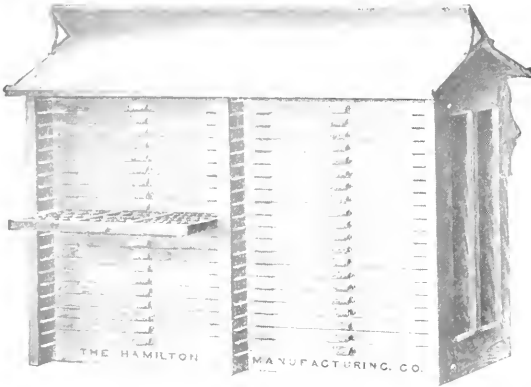

Job side Nos. 26 and 27 Tracy Steel Run Stands, with forty lip front California job cases in place. The bank can be used independently, or with an 18x72 inch Bettis lead and slug case.

Flat steel runs of extra thickness and extra width are used to hold the job cases, with five-inch extension fronts when cases are pushed back in position. This permits the withdrawal of any case, which can be placed in any desired position in front of another case without withdrawing it, a most valuable and economic feature.



The News Side No. 26 Tracy Steel Run Composing Room Stand

No brackets are required with these stands. They are perfectly rigid and guaranteed to remain so. They are made of selected hardwood, filled, stained and varnished.

List Prices and Dimensions of Tracy Steel Run Stands

No. 27 Tracy Steel Run Stand. Occupies floor space 28x70½ inches. Height at front 43¼ inches. Total height from floor to extreme top, when cap cases are not used, 57 inches, thus allowing a clear view of the composing room with no obstruction. Weight, crated for shipment, 440 pounds. List price, without cases . . . \$42 00

No. 26 Tracy Steel Run Stand. Same as No. 27, described above, except for the omission of the two copy drawers under the news case bank, and also omitting the special 9-inch bank under the two copy drawers. Weight, crated for shipment, 400 pounds. List price, without cases . . . 35 00

List price of Tracy Stand Tops only . . . 12 50



The News Side No. 27 Tracy Steel Run Stand, with copy drawers and galley bank under the news cases

Tracy Steel Run Stands have proven very popular with many of the larger printers of this country. There are several composing rooms entirely equipped with them. The one great advantage of the Tracy Steel Run Stands is the fact that when the cap cases are not used the extreme height of the stand is but fifty-seven inches, allowing a clear view of the entire composing room.

Galley Racks

These Galley Racks and Galley Brackets are the most substantial brackets made and are in general use in thousands of printing offices throughout the world.

The brackets are held on a stout hardwood frame, and braced as shown in cut. Made of iron, and held in sockets which are firmly screwed to the frame; take single and double galleys. The prices quoted below are for Racks with 8-inch Arms (No. 14), to take double column galleys.

For medium and small composing rooms these Galley Racks will be found a great convenience. There is always a blank wall space where the rack may be attached without interfering with the workmen.

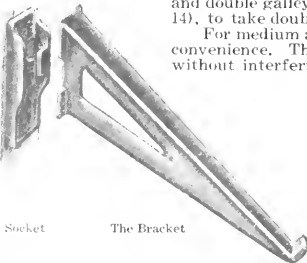

The Socket

The Bracket

List Prices of Brackets and Sockets

LENGTHS	PRICE PER PAIR		
	Weight Pounds	No. 14 Inclined	No. 15 Reversible
8-inch Arms	2½	\$0 40	\$0 40
10-inch Arms	4	75	75
12-inch Arms	7	1 25	1 25

List Prices and Dimensions of Galley Racks

	Dimensions of Frame Inches	Weight, Complete Pounds	Price
For 6 Galleys	1½x14½x31	22	\$ 3 00
For 8 Galleys	1½x14½x38	27	4 00
For 10 Galleys	1½x14½x46	35	5 00
For 12 Galleys	1½x14½x55	40	6 00
For 15 Galleys	1½x14½x67	50	7 50
For 20 Galleys	1½x14½x86	65	10 00

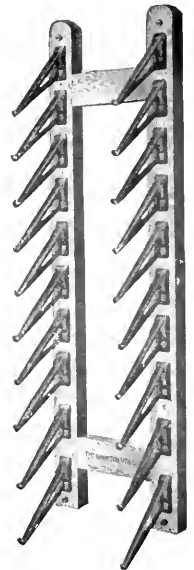

Galley Rack

The prices quoted on this page are subject to prevailing discounts

New York Double and Quadruple Stands

The New York Case Stands were designed to economize floor space, they give the greatest capacity to least area. The lower case projects into the alley several inches, affording the compositor ample knee room. The angle of the lower case is just right for rapid setting.

The cap case is raised above the lower and brought forward closer to the compositor's hand, while not obstructing the figure boxes of the lower case.

The cases are held on strong iron brackets, securely screwed to a hardwood top, which is very useful for storing tied-up matter. The utility of the No. 2 Double Stand can be increased by substituting three case brackets.

A double stand holds thirty cases and two pairs of news cases on top. A quadruple stand holds sixty cases and four pairs of news cases on top. Prices given below include the brackets, but not the case on top.

These stands have been in use in some of the best printing offices for many years and have been found entirely satisfactory in every way.

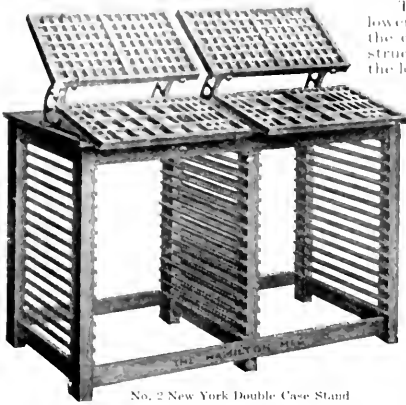

No. 2 New York Double Case Stand

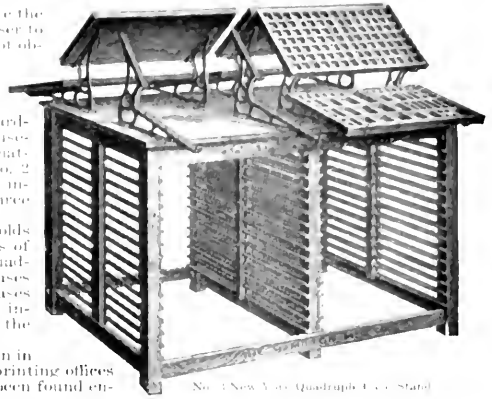

No. 1 New York Quadruple Case Stand

List Prices and Dimensions of New York Double and Quadruple Stands

No.	DESCRIPTION	Capacity	Floor Space Inches	Weight with Brackets	Price
1	New York Single Stand	15 Cases and 1 pair on top	18x36 $\frac{1}{2}$	75 pounds	\$ 6 50
2	New York Double Stand	30 Cases and 2 pairs on top	18x70 $\frac{1}{2}$	135 pounds	10 50
3	New York Quadruple Stand	60 Cases and 4 pairs on top	35x70 $\frac{1}{2}$	225 pounds	18 00
4	New York Window Stand	30 Cases and 2 pairs on top	35x36 $\frac{1}{2}$	135 pounds	10 50

Case Stands and Racks

These Case Stands and Racks are all made of hardwood, and bolted together firmly. The high case racks are braced at the center with bolted rods to prevent spreading, and both stands and racks will remain rigid after long and steady use. To equip a printing plant with these case stands probably requires the very least investment, and when price is an object and must be considered, in preference to style, they will prove to be satisfactory in every way. As a matter of fact a very serviceable office equipment may be purchased with a very small pecuniary outlay. For offices located in districts where space is not of vital importance, these case stands and racks are just as satisfactory as higher priced steel run case stands. They are shipped to purchasers in the natural wood and in a knocked down condition. When assembled, and if it is desired to improve their appearance, they may be covered with a coat of shellac and then varnished. This may be done at a cost of only a few dimes and almost anyone who can use a brush can apply the shellac and afterwards the varnish to the stands. The varnish will add a lustre and brighten the woodwork considerably.

As will be observed, there is a large assortment of Case Stands and Racks listed, both in single and double tiers, fitted for cases of various sizes. Should you, however, not find in the list exactly what you require, the American Type Founders Company invites you to correspond on the subject. Its vast experience and intimate knowledge on all matters pertaining to the printing craft and the proper equipment of printing offices is always at your service. As the largest dealer in all requisites for the printer, the American Type Founders Company is in a position to render to its customers better service than can be obtained from any other supply house. The convenient location of the many selling houses of the American Type Founders Company gives it a great advantage in filling orders promptly. No matter where the customers are located this company has a selling house nearby that will give all business prompt and careful attention.

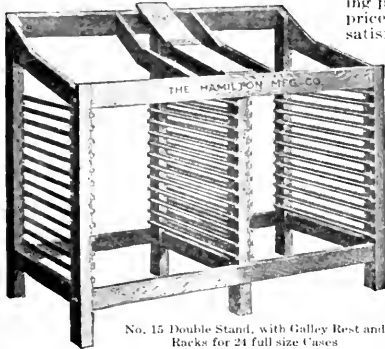

No. 15 Double Stand, with Galley Rest and Racks for 24 full size Cases

List Prices and Dimensions of Case Stands

No.	DESCRIPTION	Floor Space Ins.	Weight Pounds	Price
1	Single, without Racks	26 x 36 $\frac{1}{2}$	32	\$2 75
2	Single, with Racks for 12 two-thirds Cases	26 x 25 $\frac{1}{2}$	38	3 00
2 $\frac{1}{2}$	Single, with Racks for 12 three-quarter Cases	26 x 30 $\frac{1}{2}$	42	3 00
3	Single, with Racks for 8 full size Cases	26 x 36 $\frac{1}{2}$	39	3 00
4	Single, with Racks for 12 full size Cases	26 x 36 $\frac{1}{2}$	45	3 25
5	Double News, without Racks	26 x 60	50	3 25
6	Double News, with Racks for 8 full size Cases	26 x 60	55	3 75
7	Double News, with Racks for 10 full size Cases	26 x 60	56	4 25
8	Double News, with Racks for 12 full size Cases	26 x 60	58	4 75
9	Double Job Stand, with Racks for 8 full size and 8 two-thirds Cases	26 x 60	61	1 25
10	Double Job Stand, with Racks for 10 full size and 10 two-thirds Cases	26 x 60	65	5 00
11	Double Job Stand, with Racks for 12 full size and 12 two-thirds Cases	26 x 60	70	5 50
12	Double Job Stand, with Racks for 12 full size & 12 three-quarter Cases	26 x 64 $\frac{1}{2}$	72	5 75
13	Double Stand, with Galley Rest and Racks for 16 full size Cases	26 x 70 $\frac{1}{2}$	70	5 50
14	Double Stand, with Galley Rest and Racks for 20 full size Cases	26 x 70 $\frac{1}{2}$	74	5 75
15	Double Stand, with Galley Rest and Racks for 21 full size Cases	26 x 70 $\frac{1}{2}$	78	6 00
16	Double Stand, with Galley Rest and Racks for 30 full size Cases	26 x 70 $\frac{1}{2}$	83	7 00

Punched ends to any of above Stands, \$2.00 extra

List Prices and Dimensions of Case Racks

No.	CAPACITY	Height Inches	Floor Space Inches	Weight Pounds	Plain, as in Cut	Closed Back and Sides
20	Single tier 10 full size Cases	38	20 $\frac{1}{2}$ x36 $\frac{1}{2}$	45	\$ 5 50	\$ 7 75
21	Single tier 12 full size Cases	41	20 $\frac{1}{2}$ x36 $\frac{1}{2}$	49	6 00	8 50
22	Single tier 16 full size Cases	50	20 $\frac{1}{2}$ x36 $\frac{1}{2}$	56	7 00	9 50
23	Single tier 20 full size Cases	60	20 $\frac{1}{2}$ x36 $\frac{1}{2}$	58	8 00	11 00
24	Single tier 21 full size Cases	70	20 $\frac{1}{2}$ x36 $\frac{1}{2}$	67	9 00	12 00
25	Single tier 30 full size Cases	84	20 $\frac{1}{2}$ x36 $\frac{1}{2}$	83	10 00	13 00
26	Double tier 40 full size Cases	60	20 $\frac{1}{2}$ x70 $\frac{1}{2}$	104	14 00	17 00
27	Double tier 60 full size Cases	84	20 $\frac{1}{2}$ x70 $\frac{1}{2}$	111	18 00	22 50

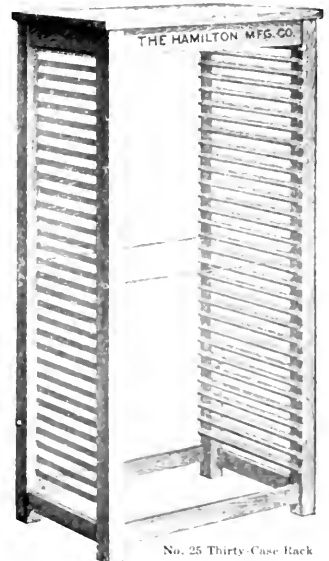

No. 25 Thirty-Case Rack

All Case Stands and Racks are furnished unfinished and shipped knockdown

Roll Front Case Racks

Many printers have desired to do away with the ordinary case racks and substitute cabinets, and thus increase the life of the type by keeping it free from dust. On account of the expense involved and the fact that their old cases could not be sold or utilized, they have hesitated in making the needed improvement. This new Case Rack solves the problem. The Roll Front Case Racks are equal to cabinets in every way, and they really are cabinets and not case racks in the ordinary sense of the term. They are fitted with steel runs, and are thoroughly well built. The roll front is fitted with the finest brass desk lock. A single lock secures the entire tier of cases.

Made of ash, finished in antique, same as regular high-grade cabinets.

The prices are for Case Racks only and do not include the cases. These Racks can be made to fit special cases. Case pulls, attached to case fronts, 5 cents each; in bulk, 4 cents each.

List Prices and Dimensions of Roll Front Case Racks

	Capacity	Height	Width	Depth	Weight	Price
No. 1	16 full size cases	45 inches	36 inches	21 inches	175 pounds	\$20 00
No. 2	20 full size cases	53 inches	36 inches	24 inches	210 pounds	23 00
No. 3	25 full size cases	63 inches	36 inches	24 inches	225 pounds	28 00
No. 4	30 full size cases	73 inches	36 inches	24 inches	260 pounds	32 00
No. 5	35 full size cases	83 inches	36 inches	24 inches	290 pounds	35 00
No. 6	40 full size cases	93 inches	36 inches	24 inches	325 pounds	40 00

The prices quoted are subject to prevailing discounts

"Everything for the printer" is a slogan which has the earmarks of accuracy when applied to the American Type Founders Company. Its aim is always, not only to keep abreast of the times, but to aid its customers in every way by bringing to their notice every new device or machine which will aid the development of the printing art. Write us your requirements. Our service and experience are at your disposal.

Indexed Electrotpe Cabinet

A practical Indexed Electrotpe Cabinet is here offered in the Indexed Electrotpe Cabinet No. 18. The question of the proper filing of the original cuts and electrotypes is a vital one in houses where the assortment is large. A large amount of money is usually tied up in them and it is economy to place them in a cabinet where they will be preserved and

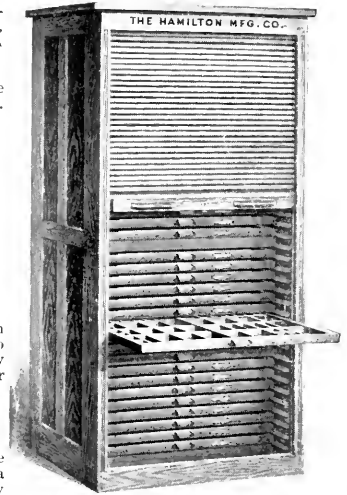

No. 5 Roll Front Case Rack

protected from injury, and where they can be found when wanted. The use of the Indexed Electrotpe Cabinet absolutely prevents any cut from being lost or mislaid, and but a moment is required to find any original cut or electrotpe. When in use the Cabinet is so arranged that each cut or electrotpe has a place specially partitioned off for its accommodation. The space is laid out in the right size to accommodate the cut, and there is no waste of room. It is properly recorded in the Index Book, which accompanies each Cabinet.

To find a cut, a glance at the Index Book will show its exact location, giving the number of the drawer in which it is located, also the section of the drawer and the division of the section as shown in the illustration. When an original cut is withdrawn from the Cabinet for the purpose of having electrotypes cast from it, a record is made in the Index Book, giving the date of its withdrawal and where it was sent, thus maintaining a constant control of each cut. The method of laying out the drawers is shown in the illustration below. The drawers are slotted on the inside, all around on the front, sides and back at intervals of three-eighths of an inch. The full-length divisions, which run from front to back, are also slotted at intervals of three-eighths of an inch on both sides. These full-length divisions are placed in the proper position, leaving sufficient space to accommodate the cuts which are about to be placed in the Cabinet. The smaller cross divisions are then placed in position sepa-

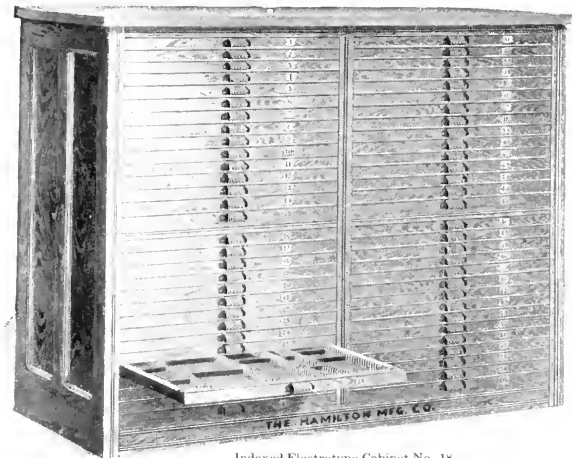

Indexed Electrotpe Cabinet No. 18

rating each cut and making a distinct compartment to fit each cut. As soon as cuts are properly laid, a record should be entered in the Index Book. Full details as to indexing are furnished elsewhere.

POINTS OF SUPERIORITY. These Cabinets, with steel runs, allow the drawers to be placed compactly in the Cabinet and afford a saving in space occupied of twenty-five per cent. Each drawer is also fitted with a metal number plate, and the Index Book accompanies each Cabinet without extra charge. The Cabinets are made of ash, finished in antique oak, and will give thorough satisfaction. They are constructed in three sizes like regular type cabinets. The two-third size drawer is fifteen and one-eighth by twenty and one-half inches inside; the three-quarter drawer is fifteen by twenty-four and five-eighths inches inside; the full-size drawer is fifteen by thirty and one-half inches inside. All drawers have extension side rails at the back, enabling a drawer to be fully drawn and making the cuts in the back readily accessible. The prices given are for the Cabinets, fully equipped, ready for use. All drawers are of the favorably-known pattern, "New Departure."

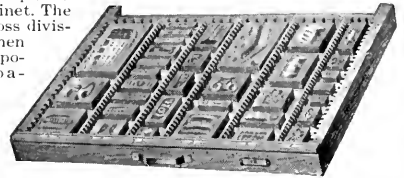

Indexed Electrotpe Drawer. This cut shows a drawer as it appears when divided off and filled with cuts or electrotypes. Note that every cut is in a distinct compartment, and that the dimensions are arranged in both directions to fit various sizes of cuts.

List Prices and Dimensions of Indexed Electrotpe Cabinets

No.	Number and Size of Drawers	Height Inches	Width Inches	Depth Inches	Weight Pounds	Price	No.	Number and Size of Drawer	Height Inches	Width Inches	Depth Inches	Weight Pounds	Price
1	20 Two-thirds	37 $\frac{3}{4}$	25 $\frac{1}{4}$	21	180	\$25 00	10	40 Three-quarter	68	29 $\frac{3}{4}$	21	400	\$53 00
2	25 Two-thirds	45 $\frac{1}{4}$	25 $\frac{1}{4}$	21	225	30 00	11	50 Three-quarter	84	29 $\frac{3}{4}$	21	475	65 00
3	30 Two-thirds	53 $\frac{3}{4}$	25 $\frac{1}{4}$	21	275	35 00	12	60 Three-quarter	99	29 $\frac{3}{4}$	21	550	78 00
4	40 Two-thirds	69	25 $\frac{1}{4}$	21	350	48 00	13	20 Full-size	37 $\frac{3}{8}$	35 $\frac{3}{4}$	21	250	35 00
5	50 Two-thirds	84 $\frac{1}{2}$	25 $\frac{1}{4}$	21	425	60 00	14	25 Full-size	44 $\frac{1}{4}$	35 $\frac{3}{4}$	21	300	40 00
6	60 Two-thirds	99	25 $\frac{1}{4}$	21	475	72 00	15	30 Full-size	53	35 $\frac{3}{4}$	21	350	45 00
7	20 Three-quarter	37 $\frac{3}{8}$	28 $\frac{3}{4}$	21	200	30 00	16	40 Full-size	68	35 $\frac{3}{4}$	21	475	60 00
8	25 Three-quarter	44 $\frac{1}{4}$	28 $\frac{3}{4}$	21	250	35 00	17	50 Full-size	84	35 $\frac{3}{4}$	21	575	75 00
9	30 Three-quarter	53	29 $\frac{3}{4}$	21	300	40 00	18	60 Full-size	99	35 $\frac{3}{4}$	21	650	90 00

The Fifty Drawer and Sixty Drawer Cabinets are furnished in one or two tiers, as desired, at the same price.

SPECIAL NOTICE. The above prices include the Cabinets fitted with a full equipment of division slats, including five of the slotted divisions for each drawer in the two-third size Cabinets, and six for each drawer in the three-quarter and full-size Cabinets; also with a large assortment of cross divisions, in various lengths. Extra slotted division strips 5 cents each, list. Each drawer is fitted with a metal number plate, as shown in the illustration.

One Indexed Book is furnished for each Cabinet, regardless of the size of the Cabinet. Additional Books, if required will be furnished for \$1.00 each, list. Write for discounts.

Wood Type Cabinets

Our Wood Type Cabinets are fitted with either wood or steel runs and equipped with New Departure Cases. In the Cabinet the Type is preserved and kept free from dust and at the same time every letter is available without disturbing others.

The No. 9 Cabinet shown here occupies but nine square feet of floor space and affords one hundred and forty square feet of case surface for the systematic storage of wood type.

Wood Type Cabinets are made to hold two sizes of cases, viz. Nos. 1, 2, 3, 5 and 8, to hold cases twenty-three by thirty-two and one-quarter inches and known as the regular Wood Type Cabinet, while Nos. 4, 5, 6, 9 and 10 are made to hold cases twenty-three by forty inches, and this size is known as the Mammoth Wood Type Cabinet. They are very substantially constructed of ash, finished in antique oak. The cases are slotted on the sides and have movable strips which may be adjusted to picas. The cases in the Mammoth size (twenty-three by forty-four) have a center bar, as shown in the illustration, while the cases in the regular cases have no center bar.

To meet the demand for Cabinets of greater storage capacity, there are four new sizes, represented by Nos. 7, 8, 9 and 10. These Cabinets are made with steel runs and have twenty-five cases in each tier, but occupy the same floor space and are the same height as Cabinets with wood runs holding twenty cases in each tier. This represents a gain in floor space of twenty-five per cent, an item of interest where space is limited and rents are high.

Wood Type Cases for Wood Type Cabinets. All cases having movable strips are adjustable by picas. The strips are also cut by even picas so that the variations are by single picas. For instance, a whole case can be adjusted to hold five line type or six line or eight line as desired, or part of each in the same case. The No. 2 Wood Type Case has no center bar, while the No. 3 Case is fitted with a center bar to add strength and to sustain the heavy load which will be carried when cases are filled. The sides and center bars of Wood Type Cases are slotted for pica adjustment. Each case in every Wood Type Cabinet is fitted with a suitable number of division strips without extra charge.

IMPORTANT. Each Wood Type Cabinet is listed with flat top or with galley top under the same number. Customers should not fail to specify clearly which is wanted.



No. 9 Mammoth Wood Type Cabinet with Galley Top



Style No. 3 Wood Type Case used in Nos. 1, 5, 6, 9 and 10 Cabinets, Size 23x44 inches

List Prices and Dimensions of Wood Type Cabinets

No.	Steel or Wood Runs	Number of Cases	Size of Cases Inches	Height Inches	Width Inches	Depth Inches	Weight Pounds	Price	WITH GALLEY TOP			
									Height at Front Inches	Height at Back Inches	Weight Pounds	Price
1	Wood Runs	12	23x32 ¹ / ₄	36	35 ¹ / ₂	26 ⁵ / ₈	250	\$ 21 00	36	12	275	\$ 27 50
2	Wood Runs	16	23x32 ¹ / ₄	41 ¹ / ₄	35 ¹ / ₂	26 ⁵ / ₈	300	30 00	41 ¹ / ₄	50 ¹ / ₄	325	33 50
3	Wood Runs	20	23x32 ¹ / ₄	52 ¹ / ₂	35 ¹ / ₂	26 ⁵ / ₈	350	36 00	52 ¹ / ₂	58 ¹ / ₂	375	39 50
1	Wood Runs	12	23x44	36	47 ¹ / ₂	26 ⁵ / ₈	300	30 00	36	12	325	31 00
5	Wood Runs	16	23x44	41 ¹ / ₄	47 ¹ / ₂	26 ⁵ / ₈	370	40 00	41 ¹ / ₄	50 ¹ / ₄	395	41 00
6	Wood Runs	20	23x44	52 ¹ / ₂	47 ¹ / ₂	26 ⁵ / ₈	435	48 00	52 ¹ / ₂	58 ¹ / ₂	460	52 00
7	Steel Runs	25	23x32 ¹ / ₄	50 ¹ / ₂	35 ¹ / ₂	26 ⁵ / ₈	400	46 50	50 ¹ / ₂	56 ¹ / ₂	425	50 00
8	Steel Runs	50	23x32 ¹ / ₄	50 ¹ / ₂	60 ¹ / ₂	26 ⁵ / ₈	750	87 00	50 ¹ / ₂	56 ¹ / ₂	800	91 00
9	Steel Runs	25	23x44	50 ¹ / ₂	47 ¹ / ₂	26 ⁵ / ₈	500	63 00	50 ¹ / ₂	56 ¹ / ₂	525	67 00
10	Steel Runs	50	23x44	50 ¹ / ₂	93 ¹ / ₂	26 ⁵ / ₈	950	118 00	50 ¹ / ₂	56 ¹ / ₂	1000	125 00

The Cabinets Nos. 8 and 10 with steel runs and 50 cases are double tier, 25 cases in each tier. Six division strips are sent with every case in a Cabinet. Extra strips over this amount are furnished at 2 cents each.

List Prices of Wood Type Cases Only

No.	WITH LID FRONTS LIKE ORDINARY TYPE CASES	Weight Pounds	Price
1	16 ⁵ / ₈ x32 ¹ / ₄ inches, size of regular type case, no center bar	6	\$ 0 90
2	23x32 ¹ / ₄ inches, can be put in any regular case stand, and gives 224 square inches more space than No. 1	8	1 00
3	23x44 inches, gives 276 square inches more space than No. 2—with center bar	11	1 30
	Case Rack with Wood Runs to hold 20 No. 3 Wood Type Cases, flat top, height, 57 ³ / ₈ inches	85	9 00
	Case Rack with Steel Runs to hold 25 No. 3 Wood Type Cases, flat top, height 57 ³ / ₈ inches	100	11 00



No. 1 Specimen Cabinet

Specimen Cabinets for Particular Printers

The proper classification and preservation of specimens of printing will enable the printer to show his work to prospective customers to the best advantage. There is a large line of specimen cabinets, which include a variety of sizes, forms and prices in order to meet the requirements of large and small printing offices. The Cabinets contain a large number of shallow drawers, which can be labeled and properly indexed. By this method the specimens of printing are not merely bunched and are easy of access and convenient for display. The Cabinets can be used for other purposes than the storage of specimens of printing. Samples of stock, small supplies, blanks, legal papers and periodicals can be systematically stored.

We can furnish any style of cabinet and shall be pleased to give you information regarding the complete line. Every printing office should have a specimen cabinet of some kind. The American Type Founders Company handles a large variety and they range in prices and finish from the No. 1 shown in the illustration at \$22.00 list, up to the beautiful Specimen Cabinet No. 3 at \$120.00. This Cabinet is conveniently arranged with a large number of shallow drawers accommodating almost any size of printed matter. The successful printer will not be slow to acknowledge the usefulness of the Specimen Cabinet. Realize for a moment how a much better impression is created in a customer's mind, when you go to a neat cabinet for samples of your work, when you wish to exhibit them to a prospective buyer of printing. In any other line of business neatness in the display of merchandise counts as an important factor. Why should not the same hold good in the case of the printer, especially when the desired result can be obtained at such a small expenditure?

In addition to these Specimen Cabinets, neatly framed samples of your best efforts in printing displayed in prominent positions on the walls of your office are very effective and may assist materially in interesting prospective customers who may visit your establishment.

List Price and Dimensions of No. 1 Specimen Cabinet

No. 1 Specimen Cabinet contains 8 drawers with inside dimensions 15⁷/₈x20 inches. Four of these drawers are 2 inches deep, inside, and four are 4¹/₂ inches deep, inside. This Cabinet occupies floor space 20¹/₄ inches deep, by 25³/₈ inches wide. The height is 37¹/₂ inches. The Cabinet is made of ash and is nicely finished. Each drawer is divided into nine compartments, with removable partitions. Weight, crated for shipment, 165 pounds. List price \$22 00

Prices quoted on this page are subject to prevailing discounts

Linotype Magazine Cabinet

The advent and adoption of machine composition, especially in newspaper and book offices, has necessitated the introduction of a special line of furniture particularly adapted to this class of work. The Linotype Magazine Cabinet has met with much favor, and will be found a labor saving and convenient addition to the equipment of the machine office.



Linotype Magazine Cabinet

to accommodate all sizes of liners. Cleats engage the slots in the liners and hold them in position.
BLANK DRAWERS. Beneath the liner drawers are two blank drawers, size inside twelve and one-half by sixteen inches and two and three-quarter inches deep. On the end is located another blank drawer, size sixteen and three-quarters by twenty-two and one-half by two and one-half inches. These drawers will accommodate tools and other accessories.

EJECTOR BLADE RACKS. In the center tier at the bottom, enclosed by a roll front secured with lock, are three shelves for ejector blades. Each shelf will hold seventeen blades; any size blade is held in proper position.
SORTS TRAY RACK. At the side of the ejector blade rack is another compartment, secured by a lock, fitted with flat steel runs. This will accommodate eight standard size sort trays.

MAGAZINE DRAWERS. There are eight upright drawers with wheel bearings made to accommodate the No. 5 model magazine. They are held on brackets engaging the lugs on the side of the magazine. If No. 3 magazines are to be accommodated they require deeper drawers, and this size cabinet will hold five of them. In ordering state what magazine it is desired to accommodate.

GALLEY RACKS. These are arranged in double tier, fourteen shelves to each tier. Will accommodate twenty-eight standard double column galleys eight by twenty-four inches.

CUPBOARD. On the opposite side is a cupboard with door, fitted with two adjustable shelves. Size twelve and one-half by nineteen and one-quarter inches by twenty-three and one-half inches inside.

WORKING TOP. This top is of hardwood, one and one-half inches deep, cleated on the ends. Size thirty-seven by seventy-six inches. The American Type Foundry Company will be pleased to quote prices and submit sketches on any special cabinets required. We are in a position to offer you suggestions in your equipment which will save you time and money.

List Price, Dimensions and Weight of Linotype Magazine Cabinet

Occupies floor space, 35x74 inches; height, 38 inches; weight, crated, 1,000 pounds. List price \$160 00
 Special magazine cabinets of any desired size can be made to order. Drawings and prices furnished on request.

Job Press Cabinets

A pressman's time can be saved and economy effected in waste of stock by the use of this Cabinet. It affords a suitable receptacle for tympan paper, gauge pins and other tools, benzine can and wiping rags. One cabinet will serve two presses when placed in the center, a little back of the pressmen. Where space is available the best results are obtained by having a cabinet for each press.

Each unit is mounted on an iron pedestal of convenient working height and on the top is a plate-glass mixing slab. There is a special compartment for the benzine can and to avoid the danger of spontaneous combustion, the compartment for oily rags is metal-lined. The usual gauge pin drawer is provided.

There is one compartment for hard press board, cardboard and filler stock, in various grades for use as draw sheets, also three compartments for slip sheets.

The Cabinets are made in three sizes, for eight by twelve, ten by fifteen and fourteen and one-half by twenty-two inch presses. Intermediate sizes may be accommodated in the next size larger.

As there is undoubtedly a desire on the part of many printers to improve conditions in the pressroom we have listed here a very serviceable and up-to-date cabinet for the pressman. While to some the investment in an article of this nature may seem unnecessary, yet undoubtedly the time is not far distant when such improvements will be eagerly sought for by the discriminating and progressive printing office proprietor.

List Prices and Dimensions of Job Press Cabinets

- Job Press Cabinet No. 1. Contains three compartments for slip sheets, 14¹/₂x8 inches inside; one compartment for draw sheets, 14¹/₂x11 inches; metal-lined compartment for rags, gauge pin drawer, etc. Height, 42 inches; weight, complete, 90 pounds. Complete, with plate glass top. Price . . . \$15 00
- Job Press Cabinet No. 2. Contains three compartments for slip sheets, 17¹/₂x10¹/₂ inches inside; one compartment for draw sheets 17¹/₂x13 inches inside; metal-lined compartment plate-glass top, etc. Height, 42 inches; weight, complete, 110 pounds. Price 18 00
- Job Press Cabinet No. 3. Contains three compartments for slip sheets, 24¹/₂x17¹/₂ inches inside; one compartment for draw sheets, 24¹/₂x17¹/₂ inches inside; metal-lined compartment, plate-glass top, etc. Height, 42 inches; weight, complete, 150 pounds. Price 22 00

Ink and Roller Cabinets

A considerable saving of ink and rollers will quickly follow the introduction of this Ink and Roller Cabinet. It is an essential portion of the equipment of any printing office and is made in three sizes.

List Prices and Dimensions of Ink and Roller Cabinets

- Ink and Roller Cabinet No. 1. With shelf for ink, shelf for brayers and slab and brackets to hold 6 eighth and 6 quarto rollers. Weight, 75 pounds. Height, 36¹/₄ inches. Width, 27¹/₂ inches. Depth, 15 inches, outside. List price . . . \$6 50
- Ink and Roller Cabinet No. 2. With shelves for ink, brayers and slab and brackets, for 6 each eighth, quarto and half medium rollers. Weight, 100 pounds. Height, 36¹/₄ inches. Width, 33¹/₂ inches. Depth, 15 inches, outside. List price . . . 9 50
- Ink and Roller Cabinet No. 3. With shelves as before and brackets to hold 12 each eighth, quarto and half medium rollers. Weight, 135 pounds. Height, 48¹/₄ inches. Width, 33¹/₂ inches. Depth, 15 inches, outside. List price . . . 13 00

Ink Slabs, Marble

Marble, 8x12 . . . \$1 25 12x18 . . . \$2 00 18x24 . . . \$3 75
 Prices quoted on this page are subject to prevailing discounts which will be quoted on application.



Ink and Roller Cabinet

Linotype Matrix Cabinets

This Cabinet provides a convenient and safe receptacle for the storage of the valuable matrices, space bands and tools which accompany every linotype outfit. The construction is based on a careful study of the requirements of and after the suggestions of practical linotype experts. No linotype outfit is complete without one. This is the only practical cabinet ever made for holding the matrices, space bands and the small tools which accompany a linotype setting machine. They are firmly and substantially constructed of hardwood, nicely finished. The roll curtain front will effectually exclude the dust, and being provided with a first-class lock insures the contents of the drawer from being tampered with.

The use of these cabinets enables the linotype operator to separate his matrices, space bands and small tools, keeping each in separate compartments. There can be little wear and no damage under this arrangement. The roll curtain front is canvas-backed, and can be removed from the cabinet by lifting off the top. It is smooth-running and easy to manipulate.

Each drawer is fourteen and one-quarter by fifteen inches inside, having ten grooves upon which the matrices are placed edgewise as illustrated here. The capacity of each drawer is one hundred and forty-two running inches of matrices set edgewise. These drawers are set in the cabinet on an incline. This position of the drawers prevents the matrices from falling down or becoming disarranged when the grooves are not full. The illustration shows the matrices in place, the padded lines being held by metal slugs.

Six metal slugs are furnished with each drawer in all these cabinets. These will be found very useful holding up the ends of lines of matrices and also for separating special characters not always required. These slugs are made the same shape and size of matrix and three-quarters of an inch wide.

List Prices and Dimensions of Matrix Cabinets for Linotype Machines

No.	Capacity	Tool Drawer	Height	Width	Depth	Weight	Price
1	6 Drawers - for 1 or 2 machines	1	33 1/2 in.	18 in.	20 1/2 in.	150 lbs.	\$22 00
2	8 Drawers - for 2 to 4 machines	1	36 1/2 in.	18 in.	20 1/2 in.	175 lbs.	28 00
3	10 Drawers - for 4 to 6 machines	1	40 1/2 in.	18 in.	20 1/2 in.	200 lbs.	34 00
4	12 Drawers - for 6 to 8 machines	1	45 1/2 in.	18 in.	20 1/2 in.	225 lbs.	40 00



Eight-Drawer Linotype Matrix Cabinet
Suitable for an office running two to four machines. Height, 36 1/2 inches; width, 18 inches; depth, 20 1/2 inches

Special Cabinets of this pattern built to order. Prices and drawings furnished on receipt of specifications.

Monotype Cabinet

This Cabinet has been designed to embody the ideas of monotype users and operators for a safe and convenient place for holding all accessories to the monotype casting machine when not in use, screw-drivers and gauges furnished with the machine so that the Cabinet gives the operator a place for safely and neatly keeping all appliances and tools.

The molds are kept in two sliding trays at the top of the Cabinet; each holds six molds in such a manner that it is impossible for them to strike. Beneath these trays are two shelves for normal wedges; each shelf holds fifteen wedges, and each wedge has its particular place, where it is protected from injury and where it may be quickly found. Two additional shelves provide for twenty-eight matrix cases; each case being held on edge and prevented from striking the other cases. Beneath these shelves are four drawers for individual matrices; each drawer is divided into thirty-seven grooves, in which the matrices are stood on end. A bar across the center of each drawer divides it so that matrices taken from the matrix case, in making changes, are put above the bar in the same groove from which the matrices below the bar are taken to replace those removed from the matrix case. This simple and convenient arrangement reduces the time of the change to a minimum, and avoids mistakes.

List Price and Dimensions of Monotype Cabinet

Height, 25 1/2 inches; width, 14 inches; depth, 16 inches; weight, ready for shipment, 75 pounds.
List price \$22 00

The door is arranged with holders for the various wrenches,



Monotype Cabinet

Monotype Correcting Case

This Case was designed to save floor space and time in correcting monotype matter. Ordinarily the corrector occupies a full size stand, resting the galley on one lower case and taking the sorts required from the other. In the Monotype Correcting Case a place is provided for the galley itself so that the corrector occupies but half the space formerly used and the distance his hand has to travel to reach any lower case character, space, figure or point is reduced to the minimum. List price, each \$2 00

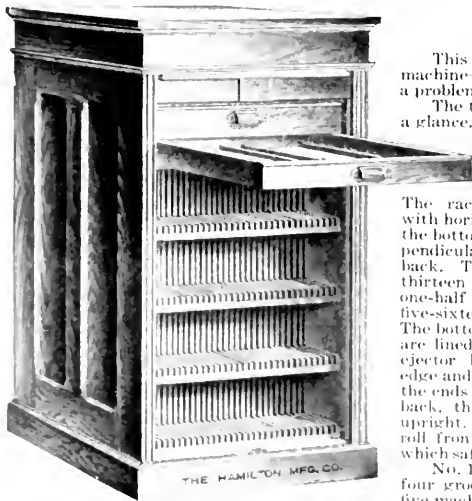

Liner and Ejector Blade Cabinet

Liner and Ejector Blade Cabinet

This Cabinet has been designed to hold those essential parts of a Linotype machine—the liners and ejector blades. How to take care of the latter has been a problem for years.

The trays for the liners are so arranged that each liner can readily be seen at a glance. The rails are so adjusted that the short liners come opposite the longer ones, thus every inch of space in the tray can be utilized, giving sufficient room to hold the liners for five machines. The trays are removable.

Below the liner trays are racks for holding the ejector blades.

The racks are arranged with horizontal grooves at the bottom, that meet perpendicular grooves at the back. These grooves are thirteen points wide and one-half inch deep and are five-sixteenths inch apart. The bottoms of the grooves are lined with brass. The ejector blades are set on edge and pushed back until the ends rest in grooves at back, thus holding them upright. The cabinet has a roll front, with Yale lock, which safely secures the valuable contents.

No. 1 CABINET has one liner tray and two ejector blade racks, with thirty-four grooves in each rack, and will give ample room for liners and ejectors for five machines.

No. 2 CABINET has two liner trays and four ejector blade racks, sufficient for from six to fifteen machines.

No. 3 CABINET has three liner trays and six ejector blade racks, sufficient for from sixteen to thirty machines.

List Prices and Dimensions of Liner and Ejector Blade Cabinets

No.	Outside Dimensions			Weight Cast-iron Pounds	List Price
	Width Inches	Depth Inches	Height Inches		
1	22 1/2	19 1/2	21 1/2	120	\$35 00
2	22 1/2	19 1/2	35 1/2	180	48 00
3	22 1/2	19 1/2	52 1/2	240	60 00

Special sizes and special orders, with any desired arrangement, built to order. Drawings and estimates will be submitted on receipt of specifications.

Dorsey Compositor's Working Cabinet

The Dorsey Compositor's Working Cabinet is a time saver and money maker. This Cabinet is as handsome as it is useful. Beautifully varnished and finished it stimulates personal pride and neatness, and is conducive to better workmanship.

Sloping top is same size as ordinary lower case. Eight-inch flat surface at top for slugs, etc. Two drawers each with two compartments for copy, tools, etc.

Five letter boards, twenty-one and one-half by twenty-four inches inside, to store forms as completed. Convenient galley racks at side to keep galleys off the floor, free from dust, and dirt, accommodate four brass galleys, as follows: One fifteen and one-half by twenty-two inches; one twelve and one-half by eighteen inches, and two regulation single column galleys.

List Price and Dimensions of Dorsey Compositor's Working Cabinet

Height, front, 45 inches; back, 53 inches. Width, 31 inches; depth, 25 inches.

List price **\$36 00**

Working Galley or Job Bank

The entire surface, including the main working space and the compartments for sort boxes, rule case, etc., is full brass lined with heavy sheet brass. All division strips are also brass lined on both sides. The brackets fit into removable sockets which can be fastened to the end of a cabinet, or to the wall.

At the right is a compartment into which can be placed a quarter size rule case. At the top is a space filled with sixteen removable type or sort boxes, with metal bottoms screwed to the wooden rims. At the upper left-hand corner is a space with a heavy zinc cover. This space is for working tools like imposing rule, bodkin, etc. At the front is the main work-space, with open end at the left fitted with a lip to serve as a rest for brass galley. Size same as full size case.

Under letter boards is large open space for storage of cuts in work, personal property of compositor, etc.

List Prices of Working Galley or Job Banks

List price, full brass lined, including brackets **\$20 00**
 List price, full zinc lined, including brackets **16 00**

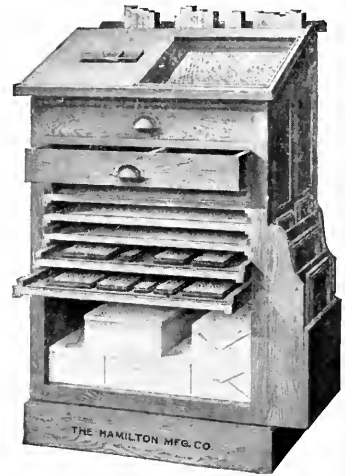

The Dorsey Working Cabinet

Galley Cabinets

The Galley Cabinets displayed on this page show the two styles of construction. One style with flat tops and flat ends, the other with galley tops and paneled ends. The Galley Top Cabinets are superior articles and the shelves rest on strips fastened to the upright center divisions and ends. This method of construction reinforces the frame and they are more rigid than the Cabinets with flat sides. In addition they have the sloping galley shelves on top, which are convenient for correcting purposes.

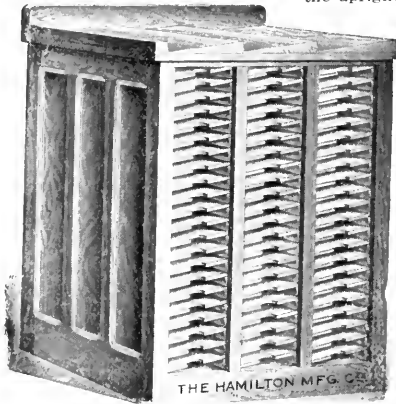

No. 3 Galley Top Cabinet with Paneled Ends

The Cabinets with flat tops and flat sides have the shelves grooved into the uprights and ends. They are strong and serviceable and in the smaller sizes they provide a satisfactory article at a very moderate cost.

Each shelf of a large size Galley Cabinet should be numbered, using metal number plates. When the galley is put in shelf, after being proofed, the number of the shelf should be put on the proof slip. When proof is read the number on it indicates where the galley can be found. When the galley is corrected, the compositor may find that the shelf corresponding with the number of his proof slip is occupied by another galley, in which case he puts his galley in the handiest vacant shelf, and changes the number on the proof slip, so that when proofs are handed to make-up he finds the galley without any loss of time. The No. 3 Cabinet shown here is the most popular form and size and meets the requirements of the average printing office fully. It has galley top and paneled ends. An

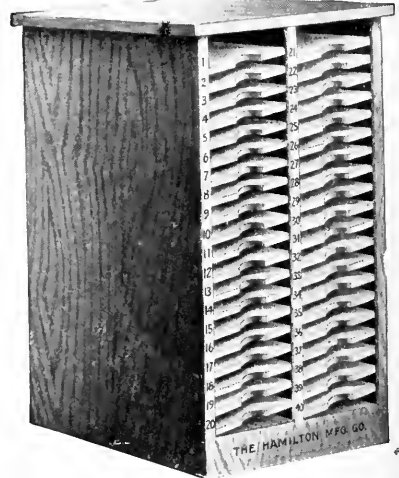

No. 9 Flat Top Galley Cabinet with Flat Ends and Number Plates Attached

adequate equipment of Galley Cabinets will prove of great economical value in any well equipped office. No feature will prove so wasteful as the lack of a suitable place to store the loaded galleys. Such a condition results in much running about looking for desired matter; consequently, delays in the execution of work. It results in much pi, which is always expensive. All of this can be avoided by installing a systematic equipment of Galley Cabinets.

The No. 9 Flat Top Cabinet holds forty galleys and has flat ends.

Realizing fully the severe strain to which large galley Cabinets are subjected when filled with loaded galleys, the construction of these is such as to enable us to give an absolute guarantee that every galley Cabinet, large or small, will remain firm and rigid for an indefinite period. They are made of selected hardwoods throughout from well seasoned stock and finished like the best grades of printers' Cabinets.

The efficiency of a Galley Cabinet is greatly increased by having the galley shelves numbered consecutively. This feature, as noticed by the price list below, is provided at a small addition to the list price.

List Prices and Dimensions of Cabinets with Galley Tops and Paneled Ends

No.	Tiers	Style	Capacity	OUTSIDE DIMENSIONS			Weight Pounds	Price	Extra with Number Plates
				Height Inches	Length Inches	Depth Inches			
1	1	Galley Top	22 Double Galleys	50 $\frac{3}{4}$	12 $\frac{1}{2}$	26 $\frac{3}{4}$	165	\$14 00	\$1 10
2	2	Galley Top	44 Double Galleys	50 $\frac{3}{4}$	23 $\frac{1}{2}$	26 $\frac{3}{4}$	280	25 00	2 20
3	3	Galley Top	66 Double Galleys	50 $\frac{3}{4}$	34 $\frac{1}{2}$	26 $\frac{3}{4}$	350	36 00	3 30
4	4	Galley Top	88 Double Galleys	50 $\frac{3}{4}$	45	26 $\frac{3}{4}$	475	47 50	4 40
5	6	Galley Top	132 Double Galleys	50 $\frac{3}{4}$	66 $\frac{1}{2}$	26 $\frac{3}{4}$	650	62 00	6 60
6	9	Galley Top	198 Double Galleys	50 $\frac{3}{4}$	98 $\frac{1}{2}$	26 $\frac{3}{4}$	900	85 00	9 90

Cabinets with Flat Tops and Flat Ends

7	1	Flat Top	20 Double Galleys	43 $\frac{3}{4}$	11 $\frac{1}{4}$	26 $\frac{1}{2}$	125	\$ 8 00	\$1 00
8	1	Flat Top	30 Double Galleys	62	11 $\frac{1}{4}$	26 $\frac{1}{2}$	165	11 50	1 50
9	2	Flat Top	40 Double Galleys	43 $\frac{3}{4}$	21 $\frac{1}{4}$	26 $\frac{1}{2}$	200	15 00	2 00
10	2	Flat Top	60 Double Galleys	62	21 $\frac{1}{4}$	26 $\frac{1}{2}$	280	22 00	3 00

Prices quoted on this page are subject to prevailing discounts. We shall be pleased to give any further information desired

Rowen Border and Script Type Cabinets

These Cabinets are invaluable for the life and preservation of delicate borders and script faces which soon become battered and worn by friction when thrown into the ordinary type or border cases. The hair lines soon become battered and the type is unfit for first class work. The result is inevitably the purchase of new type—the most expensive kind—or the production of inferior work, which eventually is still more costly.



No. 2 Rowen Border and Script Type Cabinet with Six Drawers

This unnecessary waste of good material is completely avoided by the systematic use of the Rowen Cabinets.

The Rowen Cabinets are handsome in appearance, made of hardwood throughout and beautifully finished. The ends are tastefully paneled and bronzed handles are attached to the case fronts.

These Cabinets are constructed, as shown in the illustration, with the drawers or cases pitched on an angle. The pieces of border or script type are set on end between the movable division strips, which leaves the faces exposed to the compositor and prevents any possibility of wear or friction of delicate type faces. The

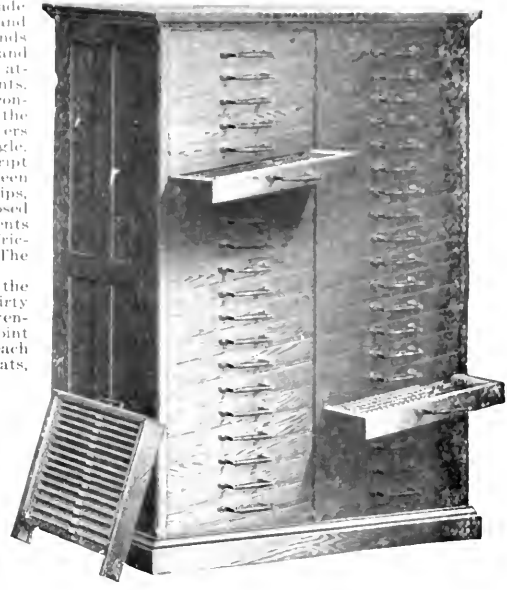

No. 7 Rowen Border and Script Type Cabinet with Forty Drawers

tilt of the cases prevents the type from falling down.

The slats or division strips are all made 18 points in thickness and the side rails are grooved at intervals of 6 points. Each case will hold thirty feet of 6 point, twenty-four feet of 12 point, twenty feet of 18 point, seventeen feet of 24 point, fifteen feet of 30 point, thirteen feet of 36 point type, etc. Fifteen pinch springs and fifteen division slats furnished for each drawer of a Cabinet. Extra springs, two cents each. Extra division slats, two cents each. All division slats are interchangeable.

List Prices of Rowen Border and Script Type Cabinets

No.	Number of Drawers and Tiers	Length Inches	Depth Inches	Height Inches	Weight Crated Pounds	List Price
1	4 Drawers, one tier	14 ³ / ₄	14 ¹ / ₄	12	30	\$ 8 00
2	6 Drawers, one tier	14 ¹ / ₄	14 ¹ / ₄	17 ¹ / ₄	50	10 50
3	10 Drawers, one tier	14 ³ / ₄	14 ¹ / ₄	25 ³ / ₈	75	16 00
4	16 Drawers, two tiers	28 ¹ / ₂	14 ¹ / ₄	21	110	25 00
5	20 Drawers, two tiers	28 ¹ / ₂	14 ¹ / ₄	24 ³ / ₄	120	30 00
6	30 Drawers, two tiers	28 ¹ / ₂	14 ¹ / ₄	35	160	45 00
7	40 Drawers, two tiers	28 ¹ / ₂	14 ¹ / ₄	41	200	60 00

Prices are subject to prevailing discounts

Hamilton Correcting Bank

The Hamilton Correcting Bank is intended for the use of small or medium sized newspaper and job offices, where machine composition is done, and where the higher priced correcting banks somewhat exceed requirements. A large number of these banks are in use in newspaper offices throughout the country and are giving universal satisfaction. A convenient piece of furniture of this kind creates greater efficiency in any printing office. To get the desired amount of work out of employees it is essential to provide them with necessary conveniences so as to economize labor and time. While at first this class of furniture may seem somewhat expensive, yet in actual use it will be found to effect a considerable economy and after installation would not readily be dispensed with.



Hamilton Correcting Bank with Truck

The Hamilton Correcting Bank is a piece of modern printing office furniture especially adapted to linotype work. It is compact in form without waste of space. Three men can work at it without interference. It holds one hundred and twenty-six loaded galleys.

Above the top is a lead rack, subdivided into thirty-six divisions, which will accommodate thirteen-em leads and slugs. Immediately under the lead rack is an opening extending to a metal lined chute, through which the discarded slugs drop to the truck below. A rim extends around the edge of the sloping top to hold the galley and prevent material from falling off. The truck is of improved form, full metal lined, and mounted on heavy double castors, which insures easy motion when loaded with metal. This truck is equipped with a lever, which dumps the contents.

Floor space, twenty-five and one-half by fifty-nine inches; height at the front and ends, forty-four and three-quarters inches; total height to top of lead rack, fifty-seven and one-quarter inches. There are six tiers of galley racks, each tier accommodating twenty-one standard linotype galleys, twenty-four inches long. These galley shelves are five inches wide inside. The two shelves over the truck are twenty inches wide, and eighteen and three-quarters inches deep. The drawer under the top is seventeen by eighteen and one-quarter inches inside. The metal box of truck is thirteen inches wide, nineteen inches long, and sixteen and one-half inches deep, tapered with round bottom. Weight, without truck, crated for shipment, 650 pounds. Weight of truck, crated for shipment, 140 pounds.

List Prices of Hamilton Correcting Bank

With wood top, without truck	\$ 90 00
With full brass lined top, without truck	110 00
Metal lined dumping truck	10 00

American Brass Label Holder

This is a simple and unique device for holding labels on the fronts of cases, cabinets, sort drawers, racks, trays, etc. It is stamped from sheer brass in one piece, and the labels can be changed as often as required without injuring the holder. The holder is attached to the case or drawer by three brass tacks and the label is inserted through the opening in the top. It is impossible for the label to slip sideways. Made in one size only.

List Price of American Brass Label Holder, complete with cards and tacks, per 100 \$1 00

List Price of Celluloid Cards, 1x1¹/₂ inches, to cover labels, per 100 1 50



American Brass Label Holder

Page Form Storage Cabinets

It is only a few years since the letter board idea for the storage of standing matter was introduced. It would be difficult now to find a printing office without an adequate supply of letter boards arranged under the stone frames or in suitable cabinets. The letter board idea is certainly a most economical one and its general introduction has led to other improvements along this line.

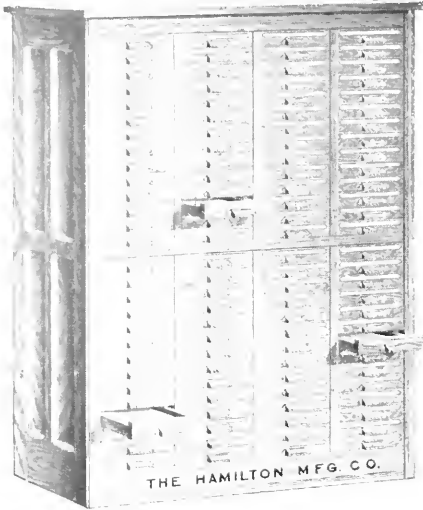

Page Form Storage Cabinet No. 5

This new Page Form Storage Cabinet is primarily a cabinet filled with small letter boards of a suitable size to take standard size book pages. Each board is intended to take a single catalogue or book page. The idea has been thoroughly tested by some of the best stone men in the country, and it has met with unqualified approval. The page forms are stored away in the dust proof slides until required, and the long label-holder attached to the outside front of each slide enables the stone man to keep an accurate record of the contents of the cabinet. These labels are changed from time to time as the jobs progress. The labels are removed as the forms are taken to the pressroom. The unlabeled drawers will always show the space available for new page forms. The use of this cabinet concentrates an immense amount of material close to the hand of the stone man, so that there is little lost time in looking for material when it is required. Each slide has a back rail which is removable, so that the type forms can be pushed out from the back end to the stone. The back edges of the slides are beveled, as shown in the illustration, so as to facilitate the transfer of the type matter from the board to the stone.

These cabinets are constructed of selected hardwood. They are thoroughly braced to stand great weight, and are guaranteed to give perfect satisfaction. The woodwork is nicely finished and the cabinet as a whole will help to clean up the office and also give it an up-to-date appearance.

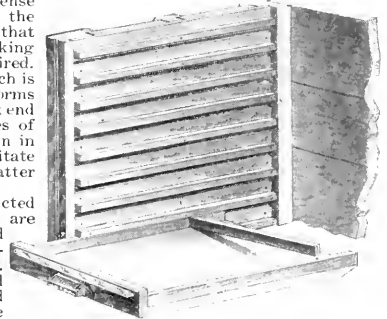

Detail showing construction of Page Form Storage Cabinet—Note Back Rail in Drawer

List Prices and Dimensions of Page Form Storage Cabinets

No.	Slides in each Tier	Number of Tiers	Total Page Slides	OUTSIDE DIMENSIONS			Weight, Pounds	List Price
				Height, Inches	Depth, Inches	Width, Inches		
1	19	3	57	38	17 ³ / ₈	33 ⁷ / ₁₆	250	\$ 49 00
2	19	4	76	38	17 ³ / ₈	43 ⁷ / ₈	340	62 00
3	28	2	56	57 ¹ / ₈	17 ³ / ₈	23	250	48 00
4	28	3	84	57 ¹ / ₈	17 ³ / ₈	33 ⁷ / ₁₆	375	68 00
5	28	4	112	57 ¹ / ₈	17 ³ / ₈	43 ⁷ / ₈	485	85 00
6	28	5	140	57 ¹ / ₈	17 ³ / ₈	54 ³ / ₁₆	600	100 00

Size of Boards, inside, eight by twelve inches. All prices subject to prevailing discounts

Book and Job Galley Cabinet

This Book and Job Galley Cabinet facilitates the handling of work and at the same time protects the type and plates. With the index system, used in connection with it, one is able to locate any page immediately, thus economizing time and labor.

It has horizontal three-ply galley shelves, all numbered consecutively. Each tier of shelves will accommodate fifty standard galvanized iron galleys, size eight and three-quarter by thirteen inches, the galley compartments being nine inches wide by thirteen and one-eighth inches deep. Total capacity of cabinet, two hundred and fifty galleys.

Two of these galley cabinets can be placed tightly together side by side, or back to back.

List Price and Dimensions of Book and Job Galley Cabinet

Occupies floor space 14³/₈x52³/₄ inches. Height, 74 inches. Weight, crated, 475 pounds \$75 00

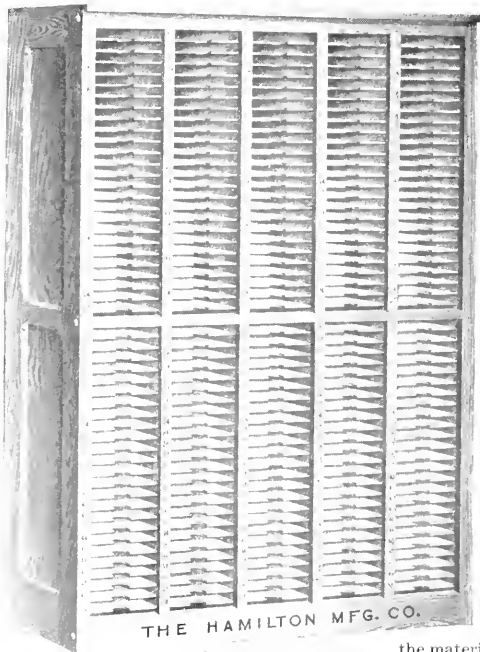

Book and Job Galley Cabinet

Dorsey Combination Press Room Cabinet

The Dorsey Combination Press Room Cabinet holds everything unsightly found around a pressroom. Will clear up the office and reduce danger from fire. The top is covered with plate glass, substituting the old ink slab, so that the ink cannot penetrate the glass and can thus be readily scraped off; copying ink is as easily cleaned off as any other. Beneath the glass are receptacles for inks, oil cans, tympan paper, etc. Beneath this there is a drawer three and one-quarter inches deep, wherein are kept the wrenches and the other miscellaneous which should ever be quickly available. Beneath this drawer is a compartment for scraps of paper, spoiled sheets and anything of a waste-basket nature.

The material is thrown into this drawer through a peculiar V-shaped open bin on the opposite side from where the drawer pulls; it is not necessary to open the drawer in order to put the material into it, but it is only open when the rubbish is removed to be emptied at night into the big trash sacks and carried to the furnace room. Below this drawer is a compartment for old rags. This rag compartment is lined with metal throughout to effectually obviate all danger should spontaneous combustion take place. This compartment is accessible from both sides of the cabinet by means of trap doors secured at the bottom with spring hinges. The cabinet is mounted on castors and therefore can be pushed about the pressroom as required.

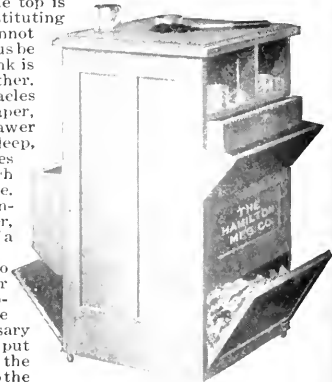

Dorsey Combination Press Room Cabinet

List Price and Weight of Dorsey Combination Press Room Cabinet

Weight, crated, ready for shipment, and including glass top, 150 pounds. List price \$36 00

Desks for Proof Readers, Copy Cutters and Ad Foremen

The Desks listed on this page have been designed at the suggestion of various proof readers and copy handlers in the more efficient plants, and have all proved to be aids to accurate, systematic and rapid work on the part of these important classes of employees, whose wants are generally neglected in the equipment of composing rooms. The work of these men is largely clerical, but as a rule they are working on makeshift desks, with inadequate facilities for taking care of their copy, proofs and records, while a clerk in the counting room drawing half the wages is provided with modern facilities. Upon the ad foremen, copy cutters and proof readers depends in a large measure the expeditious and economical development of the work from the time it enters the composing room until the forms are ready for press, and it is the reverse of economical to leave them unprovided with proper working facilities.

These desks are all made of hardwood, nicely finished, strongly constructed, and are attractive in appearance.

No. 3 Proof Reader's Desk. This is a good practical flat top desk, with sloping writing top. The sloping top can be raised and provides a convenient compartment underneath for the storage of proofs, which can be secured by locking. Medium sized hood, with drawers and book compartments in the pedestal. Made of selected hardwood throughout and with paneled backs and ends. The drawer bottoms are of three-ply material which cannot crack, swell or shrink.

List Price and Dimensions of Proof Reader's Desk No. 3

Extreme height to top of hood, 41 inches; width, 51 inches; depth, 21 inches; height of hood above writing bed, 10 inches; size of compartment under sloping writing bed, 20 $\frac{1}{2}$ x38 $\frac{1}{2}$ inches; size of three drawers in pedestal, 6 $\frac{1}{2}$ inches deep by 11 $\frac{1}{2}$ inches wide by 19 inches long inside; size of two end drawers under writing top, 2 $\frac{1}{2}$ inches by 11 $\frac{1}{2}$ inches by 19 inches inside; size of center drawer under writing top, 2 $\frac{1}{2}$ inches by 22 $\frac{1}{4}$ inches by 19 inches inside; height of book compartments in right-hand pedestal, 23 inches. Weight, crated for shipment, 300 pounds. List price

\$52 00

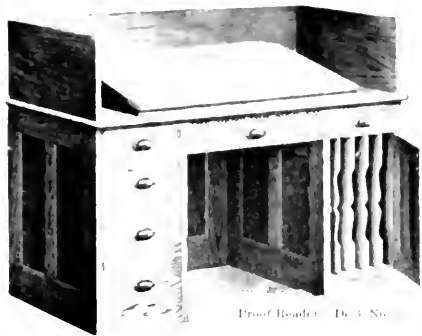

Proof Reader's Desk No. 3

Mills Proof Reader's Desk No. 1 is specially designed for newspaper work; accommodates reader and copyholder, giving them facilities for alternating their duties if desired, and affords as great a degree of privacy and quietness as is possible in a busy news composing room. Each man has his own locked writing surface, which is hinged, and has a receptacle underneath. The receptacles at either end are for the receipt of copy and proofs without interrupting the readers, and the center receptacle is for dead copy. This desk is furnished with or without the Linolite shown in illustration. Each Linolite has a line of light ten inches long, and the hood acts as a reflector, at once diffusing the light over a large area and protecting the eyes from the glare.

List Price and Dimensions of Mills Proof Reader's Desk No. 1

Length, over all, 60 inches; depth, overall, 23 inches, height to lower edge of writing surfaces, 33 inches; height, over all, 61 inches; size of hinged writing surfaces, 16x20 inches; size of copy and proof receptacles, 8x20x7 inches. List price \$45 00
Linolites, attached and wired to the floor, extra, each 5 00

Mills Ad Foreman's Desk No. 1 is very strongly yet attractively made to withstand the stress of newspaper work. The foreman may work standing or sitting on a high seat. In front of him is a holder for the pad on which he makes his records, so devised that the pad may be kept level with top of desk. There are seven compartments for the classification of copy, and eight locked drawers for taking care of all papers and records. The desk is furnished with or without the Linolite shown in illustration, and described above.

Mills Ad Foreman's Desk No. 1

the illustration. The merit of the Linolite is that it diffuses its light widely, while the hood acts as a reflector and protects the eyes from the glare.

List Price and Dimensions of Mills Ad Foreman's Desk No. 1

Length, 72 inches; depth, over all, 36 inches; height to writing surface, 41 inches; height, over all, 49 $\frac{1}{4}$ inches; size of classification compartments, 6x9 $\frac{1}{2}$ x12 inches. Six drawers are 7x17 inches inside, and two drawers are 13 $\frac{1}{2}$ x17 inches inside.

List price

\$105 00

Linolite attached and wired for connection, extra

5 00

Mills Copy Cutter's Desk No. 1 is another piece of furniture strongly made to meet the needs of newspaper work, yet attractive in design. The copy cutter may work standing or sitting. In front of him is an ingenious holder for the pad on which he keeps his records, with a device for keeping the pad always on a level with the top of the desk. There are four copy classification divisions of the copy shelf, on which the copy files are kept, and there are eight locked drawers for holding paper and records. This desk is furnished with or without the Linolite shown in illustration, and described above.

List Price and Dimensions of Mills Copy Cutter's Desk No. 1

Length, over all, 60 inches; depth, over all, 32 inches; height to writing surface, 41 inches; height, over all, 51 inches, size inside of each division of copy shelf, 12x13 $\frac{1}{2}$ x11 inches; six drawers are 7x17 inches inside, and two drawers are 13 $\frac{1}{2}$ x17 inches inside. List price

\$90 00

Linolite, attached and wired for connection, extra

5 00



Mills Proof Reader's Desk No. 1



Mills Copy Cutter's Desk No. 1

The Kaufman Imposing Stone Frame

The Kaufman is an improved imposing stone frame with a different interior arrangement accommodating electrotype cases and galley rack than found in most other stone frames of the kind. It will be found very useful in large offices and has proved to be one of the best popular imposing stone frames.

STONE. Of the most selected Vermont marble, two inches thick with a smooth imposing surface. All stones which we supply are from the famous Vermont quarries.

LETTER BOARDS. There are eleven letter boards, size fifteen inches by twenty-eight and one-half inches, inside measure, and twenty-two letter boards fifteen by twenty inches inside measure. These letter boards have a lip at the front on which to rest the galley and type matter can be pushed from the galley onto the board without difficulty. There is a rail at the back and also side rails to push the type against and hold it in position; they are made of the finest selected hardwood, free from imperfections, and a special feature of all the letter board construction is the provision for expansion.

DRAWERS. There are two drawers pulling clear through which can be drawn from either side of the frame; size, sixteen by forty and three-quarters by two and three-quarters inches. In the center there are two drawers for metal furniture, which pull clear through and can be drawn from either side. These drawers are sixteen by forty and three-quarters by one inch. They provide a convenient place for the systematic storage of the metal furniture where the stone man can always have it handy without leaving his work.

INDEXED ELECTROTYPE CASES. There are eighteen special indexed electrotype cases in this frame, twenty inches by twenty inches, inside. These cases are of the New Departure pattern with three-ply bottoms, covered with first quality manila paper. These bottoms cannot swell or contract, and owing to the nature



The Kaufman Imposing Stone Frame.

Size of Stone, 40x80 inches. Showing one side of the Frame with Indexed Electrotype Cases filled with cuts, Gallies in place on the Racks, Metal Furniture in upper shallow Drawers, and Sort Drawers showing sort divisions.

of their construction, they cannot crack. These cases are numbered consecutively so that a proper record can be kept in the index book of the contents of each case. With each case there is an assortment of all kinds of division strips, including four of the long, double slotted ones which run from front to back of the case, and various sizes of the short, cross-division strips. An indexed book accompanies this frame for use in connection with these indexed electrotype cases.

SORT DRAWERS. There are sixteen sort drawers in this frame, each divided into ten equal size compartments, the size of each compartment being three by four by three inches. These sort drawers provide storage room for an immense amount of special type not in general use, but which must be kept in readiness for special and large jobs.

GALLEY RACKS. This frame has accommodation for sixty galleys. There are three tiers to accommodate double-column galleys, and one tier to accommodate single-column galleys, fifteen galleys in each tier.

List Price and Dimensions of Kaufman Imposing Stone Frame
The shipping weight of this Frame, complete, with the Stone, is 1750 pounds. Weight of stone only, 770 pounds. This frame occupies floor space 42 1/4 x 82 1/4 inches. List price, complete with stone \$150 00

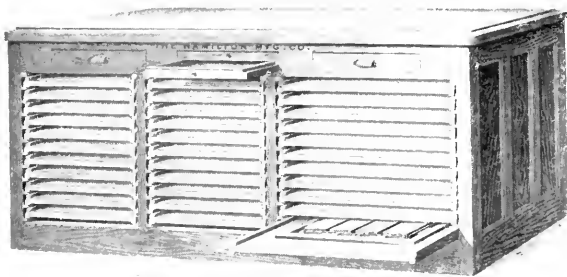

The Kaufman Imposing Stone Frame.

Showing the opposite side of the same Stone with full Letter Board Equipment, providing 80 square feet of Letter Board surface for the storage of standing forms and tied-up type matter.

The Algoma Imposing Stone Frame

The Algoma Frame takes a stone thirty-six by sixty inches, but with a change in equipment. The placing of the furniture on end is an especially good feature. It prevents waste of room. One end is entirely taken up by the reglet and furniture, which leaves the entire surface of both sides to be utilized for letter boards, chase racks and sort drawers, with the exception of ten inches, which is covered by panels, as shown. The assortment of reglet and furniture is in the usual widths from two to ten picas wide, and in the most convenient lengths from ten to sixty picas long, with variations of three to six picas. The reglet assortment is of nonpareil and pica from thirty to sixty picas long, with variations by single picas.

This is a most convenient frame for all around purposes, and embraces most of the good features of other stone frames combined into one piece of furniture. It is thoroughly made of selected hardwood, nicely finished and strongly bolted to safely carry any load to which it can be subjected. The use of this modern stone frame is decidedly economical. It contracts the space occupied by material used about the stone, and brings it within easy reach of the make-up man.

LETTER BOARDS. There are twenty-two letter boards arranged in two tiers, eleven boards in each tier, size fifteen by seventeen inches, inside. These letter boards are made with lips on the front to receive the brass galley, so that type can be easily transferred from the galley to the letter boards or vice versa.

SORT DRAWERS. Eight sort drawers arranged in one tier. Each drawer is sub-divided into six compartments of equal size. Size of each compartment, five and one-quarter by four and three-quarters by two and three-quarters inches deep, inside.

DRAWERS. Under the coffin there are five drawers. All of these drawers run clear through the frame and can be withdrawn from either side. At the ends the two large drawers are four inches deep and thirteen and one-half by thirty-six and three-quarters inches inside. In the center are three shallow drawers for metal furniture, one inch deep and thirteen and one-half by thirty-six and three-quarters inches, inside. These three drawers will hold a large amount of metal furniture in a place most convenient for immediate use.

CHASE RACKS. One side of the frame is taken up with chase-rack equipment. There are thirteen racks ten and one-half inches in height by twelve and one-half inches deep; ten racks sixteen inches high by eighteen inches deep; six racks twenty-seven and three-eighths inches high by eighteen inches deep. All of these chase-rack compartments are lined with iron on the bottom, turned at the edges to prevent damage to the woodwork when heavy forms are pushed into the compartments.

FURNITURE. A total of one hundred and eighty-one yards of selected oak soaked furniture of various widths cut on the point system and cut into ten hundred and eight pieces in the following assortments:

Sixteen pieces each 2, 3, 4, 5 and 6 picas wide cut into each of the following lengths—18, 21 and 24 picas long.

Eight pieces each 8 and 10 picas wide cut into each of the following lengths—18, 21 and 24 picas long.

Twenty pieces each 2, 3, 4, 5 and 6 picas wide cut into each of the following lengths—30, 36, 42, 48, 54 and 60 picas long.

Following lengths—30, 36, 42, 48, 54 and 60 picas long.

Ten pieces each 8 and 10 picas wide cut into each of the following lengths—30, 36, 42, 48, 54 and 60 picas long.

Single picas in the following lengths:
Thirty-four pieces each of nonpareil and pica thirty picas long to sixty picas long, with variations by single picas; a total of four hundred and fifty-eight yards cut into twenty-one hundred and eight pieces.

List Price and Dimensions of Algoma Imposing Stone Frame

Weight of Algoma Frame complete with stone and full equipment, crated, 1100 pounds. Weight of stone only, 500 pounds. The Algoma Frame occupies floor space 38 1/2 x 62 1/2 inches. List price, complete \$136 00

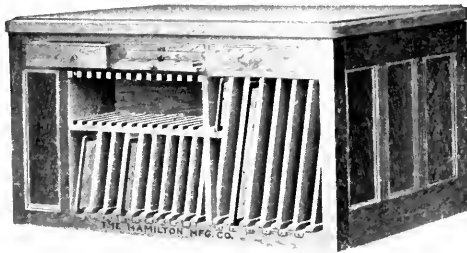

The Algoma Imposing Stone Frame. Size of Stone 36x60 inches.

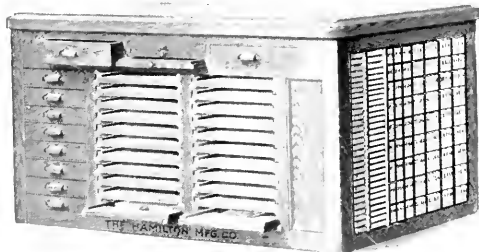

The Algoma Imposing Stone Frame. Size of Stone 36x60 inches.

Ten pieces each 8 and 10 picas wide cut into each of the following lengths:
REGLET. An assortment of nonpareil and pica, smooth and perfect in every respect and on the point system. Variation is by single picas in the following lengths:

Thirty-four pieces each of nonpareil and pica thirty picas long to sixty picas long, with variations by single picas; a total of four hundred and fifty-eight yards cut into twenty-one hundred and eight pieces.

Metropolitan Imposing Stone Frame

The difficulty of devising an imposing stone frame to meet the requirements of all printers has been recognized, but it is claimed that the Metropolitan Frame will help to solve some of the problems. A successful effort has been made to meet the constant demand for a special stone frame, not only spread in size, but special in arrangement of material under the stone.

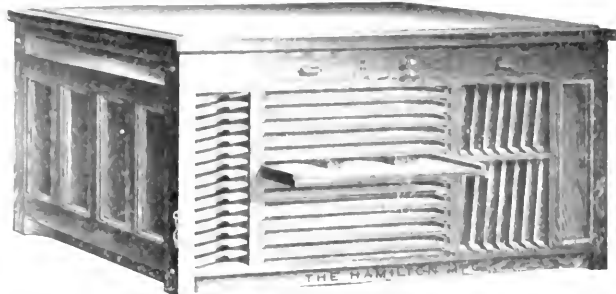

Metropolitan Imposing Stone Frame, Showing one side and one paneled end with planer shelf. Note the recessed base with rounded, dustless corners.

LETTER BOARDS. There are twenty-four letter boards, arranged in two tiers; twelve boards in each tier. Size inside, twenty-three and one-quarter by thirty and one-half inches, one tier on each side of the frame. Letter boards supported on heavy steel runs.

DRAWERS. Under the collar there are four drawers, all of which run through the frame and can be drawn from either side. Two large drawers three inches deep and fourteen by forty-eight and three-quarters inches inside. Two shallow drawers one inch deep for metal furniture. These drawers are fourteen by forty-eight and three-quarters inches inside.

CHASE RACKS. On one side are six chase racks with vertical clearance of twenty-five and seven-eighths inches. Measurement from front to back thirty-two and one-eighth inches. On the other side are two series of six chase racks, measuring vertically fourteen inches and eleven inches, both series measuring seventeen and one-half inches from front to back. All chase racks are metal lined on the bottom, thus preventing injury to woodwork.

GALLEY RACKS. Two tiers of galley racks, one tier on each side of the frame, each tier having fourteen shelves for double column galleys.

FURNITURE. A total of two hundred and six yards selected, oil soaked, hardwood furniture in various widths and lengths, comprising eleven hundred and fifty-five pieces in the following assortment: Eighteen pieces two, three, four and five lines pica in width, cut 12, 18 and 21 picas long. Twelve pieces six and eight lines pica in width, cut 12, 18 and 21 picas long. Nine pieces ten lines pica in width, cut 12, 18 and 21 picas long. Twenty-four pieces two, three, four and five lines pica in width, cut 30, 36, 42, 48, 54 and 60 picas long. Sixteen pieces six and eight lines pica in width, cut 30, 36, 42, 48, 54 and 60 picas long. Twelve pieces ten lines pica in width, cut 30, 36, 42, 48, 54 and 60 picas long.

REGLET. An assortment of nonpareil and pica reglet, cut on the point system, smooth and perfect, with variations by single picas in the shorter lengths, and by three picas in the longer lengths. A total of two hundred and eighty yards, comprising twenty hundred and sixteen pieces.

List Price and Dimensions of Metropolitan Imposing Stone Frame

Height from floor to top of stone, 38 inches. Size of stone, 48x72 inches. Frame occupies floor space 50 $\frac{1}{2}$ x74 $\frac{1}{2}$ inches. Weight, complete with stone and full equipment of reglet and furniture, 2250 pounds. Weight, complete without stone, 1300 pounds. List price, complete with stone, \$195 00

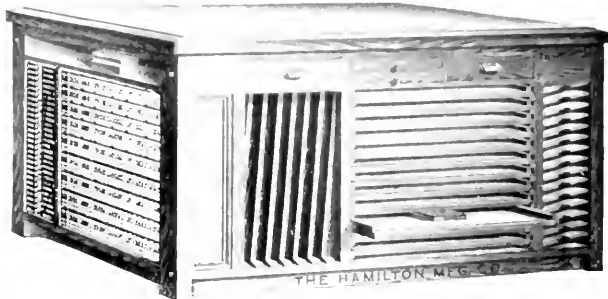

The Metropolitan Imposing Stone Frame, Showing one side and one end with open planer shelf and reglet and furniture racks. Recessed dustless base.

The Dorsey Imposing Stone Frame

The Dorsey Frame is the pioneer of all modern stone frames. It has proved very popular and is more often called for than any other frame of its kind. Modifications of this frame can be furnished at proportionate prices. It is made in one size only. The size of stone is forty by eighty inches, with smooth face and free from imperfections. The stone is two inches thick, of the best Vermont marble. The height from floor to top of stone is forty-one and one-half inches. The frame occupies floor space forty-two and one-quarter by eighty-two and one-quarter inches.

The frame contains a labor-saving rack filled with furniture. The furniture is cut in the following lengths and widths:

Eighteen pieces, each two, three and four-line; fifteen pieces, each five and six-line; nine pieces, each eight and ten-line, cut 25, 35, 50, 70, 80, 90, 100, 120, 140 and 160 ems long. Twenty-four pieces, each two, three and four-line; twenty pieces, each five and six-line; twelve pieces, each eight and ten-line, cut 30, 40, 50 and 60 ems long. A total of five hundred yards cut into fifteen hundred and sixty-two pieces. The length and width is stamped on the end of each piece.

On the opposite side from the one shown in the illustration, over the chase rack, are two large compartments for general storage; one compartment is seventeen inches deep, thirty-seven inches long and ten and one-half inches high; the other is twenty-eight inches deep, thirty-seven inches long and thirteen inches high. This arrangement utilizes racks for chases for 10x15 job press, and eighteen chases for 8x12 job press. On the sides of second tier of drawers there are eight compartments, four on each side of the frame, for string or small tools.

In the center, arranged in double tier, are thirty-six compartments for steel furniture or cut reglets. These compartments hold the following lengths: 12, 15, 18, 21, 24, 27, 30, 33, 36, 39, 42, 45, 48, 51, 54, 57 and 60 ems; two compartments for each length, except the 42-em length, which has four compartments. Each compartment holds thirty-five pieces of pica or seventy pieces of nonpareil reglet, or eleven pieces of steel furniture, three picas wide.

There are six drawers at the top. On the left-hand side, extending half-way through, are two pulling out from each side and two on the right-hand side at the top, reaching clear through, and can be pulled out from either side.

List Prices and Dimensions of the Dorsey Imposing Stone Frame and Equipment

Complete, ready for shipment, including stone, 1700 pounds. Weight of stone only, 770 pounds. Price of font of reglet to fill the center racks, \$11.00. Price of font of steel furniture to fill the center racks, \$100.00. This font consists of 22 pieces of each length as mentioned above, except the 42-em length, of which there are 41 pieces - a total of 396 pieces. Without the steel furniture or reglet, but including the labor-saving wool furniture, complete \$140 00

The Hamilton Imposing Stone Frame

This is the largest stone frame made or ever listed. In large offices it will be found of inestimable value in providing a large space where the stone hand can work freely without interfering. It is firmly constructed of hardwood throughout and finished the same as the best cabinets. The stone is hard and the best procurable. This is the only stone frame or other piece of printing office furniture which provides labor-saving reglet and furniture from small sizes up to yard-lengths, with frequent variations.

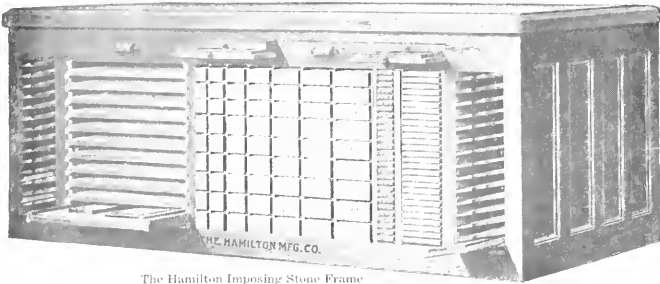

The Hamilton Imposing Stone Frame

regil and thirty-eight pieces of pica of each length, making a total of forty-two hundred and fifty-six pieces of reglet, amounting to sixteen hundred and thirty-nine yards, all cut labor-saving and comprising lengths by short variations from twelve picas to one yard, or two hundred and sixteen picas.

FURNITURE. There are two furniture racks—one on each side of the frame; on one side the following lengths are accommodated: 12, 18, 24, 30, 36, 42, 48, 54 and 60 picas, the variations being by six picas or inches.

The assortment is as follows: Eighteen pieces of two-line; fifteen pieces of three, four, five and six-line; twelve pieces eight and ten-line; all cut 12, 18 and 24 picas long. Twenty-four pieces two-line; twenty pieces three, four, five and six-line; sixteen pieces eight and ten-line, cut 30, 36, 42, 48, 54 and 60 picas long.

On the other side of the frame, the following lengths are accommodated: 70, 80, 90, 100, 120, 140, 160, 180, 200 and 216 picas, the latter being yard lengths.

The assortment is as follows: Eighteen pieces two-line; fifteen pieces three, four, five and six-line; twelve pieces eight and ten-line, of each of the lengths from seventy to two hundred and sixteen picas, as given above, together, comprising the furniture on both sides of the frame, this makes a total of twenty-two hundred and forty-four pieces or eight hundred and eighty-eight yards of labor-saving furniture.

LETTER BOARDS. The frame contains eleven letter boards, size twenty-four and one-half by forty-nine inches inside measure. These run through the frame and can be drawn from either side. They have a removable partition bar across the center which can be used to back the type against when desired. The fronts of these letter boards are rabbeted so that the galley can rest on the front edge and type matter readily pushed on the boards.

DRAWERS. There are six drawers in the upper part of the frame, all of which run clear through and can be drawn from either side. The sizes of the drawers are as follows (inside measurements): One drawer thirteen and three-quarters by forty-eight and one-half by two and one-half inches; one drawer twenty-five by forty-eight and one-half by two and one-half inches; two drawers eight and three-quarters by forty-eight and one-half by one inch; two drawers thirteen and three-quarters by forty-eight and one-half by one inch. The four one-inch drawers are for the storage of metal furniture laid in single depth.

List Price of Hamilton Imposing Stone Frame

The weight of this stone and frame, complete, ready for shipment, including all the reglets and furniture is 2800 pounds.
Weight of stone only, 1100 pounds. List price \$290 00

Ramaley Imposing Stone Frame

This is a Frame of general utility and of considerable service in small and medium size offices where the stone service is not extensive. It contains a wide variety of equipment in limited form. In compactness it cannot be surpassed, as all space is utilized.

Built of hardwood throughout with ends paneled and moulded and well finished. Furnished with the following equipment:

LETTER BOARDS. Thirteen letter boards on one side in one tier, size inside, thirty and one-half by twenty-one and one-half inches. These letter boards are supported on heavy angle-iron steel runs, guaranteed to carry any load which can be placed on the boards. All boards are lipped at the front.

SORT DRAWERS. Six drawers easy of access, all being located near the top, each drawer divided into ten compartments. Size of each compartment three and five-sixteenths by three and one quarter by two and one-eighth inches.

CHASE RACKS. On one side the chase racks are placed in double tiers, the lower tier having a perpendicular clearance of sixteen and seven-eighths inches and with a depth of twenty-four inches. The upper tier has a clearance of twelve and seven-eighths inches and with a depth of seventeen inches. Each tier accommodates twelve chases. On the other side the chase racks have a clearance of seventeen and five-eighths inches, and a depth of twelve and three-quarters inches, accommodating nine chases. All chase racks are steel-lined on the bottom.

FURNITURE. Of clear, selected stock, each piece with the length stamped on the end. There are nine lengths and seven widths, assorted as follows: Eighteen pieces each of two and three line, cut 10,

15 and 20 picas long. Fifteen pieces of four line, cut 10, 15 and 20 picas long. Twelve pieces each of five and six line, cut 10, 15 and 20 picas long. Nine pieces each of eight and ten line, cut 10, 15 and 20 picas long.

Twenty-four pieces each of two and three line, cut 25, 30, 40, 50, 60 and 70 picas long. Twenty pieces of four line cut, 25, 30, 40, 50, 60 and 70 picas long. Sixteen pieces each of five and six line, cut 25, 30, 40, 50, 60 and 70 picas long. Twelve pieces each of eight and ten line, cut 25, 30, 40, 50, 60 and 70 picas long.

A total of ten hundred and twenty-three pieces, comprising one hundred and eighty-one yards of the best oil-soaked furniture.

REGLET. A double rack, with separate compartments for nonpareil and pica in each of the following lengths: 10, 11, 12, 13, 14, 15, 16, 17, 18, 19, 20, 21, 22, 23, 24, 25, 26, 27, 28, 30, 33, 36, 40, 42, 48, 50, 60 and 70 picas, a total of two hundred and forty-four yards cut into nineteen hundred and four pieces.

METAL FURNITURE AND TOOL DRAWERS. There are six drawers in the rail under the stone. The top drawer in the center runs clear through and pulls from either side. The size of this drawer is thirteen and one-half by thirty-seven by one and one-half inches inside. The other five drawers run half way through, three pulling from one side and two from the opposite side. These drawers are most convenient for the storage of metal furniture, side sticks, column rules and all small tools.

OPEN BINS. At the end are open bins, each divided into two compartments, useful for holding mallets, planers and other similar tools.

List Price and Dimensions of Ramaley Imposing Stone Frame

The Frame occupies floor space of 38 1/2 x 62 1/2 inches. Weight of stone only, 500 pounds. Shipping weight, complete with stone, 1150 pounds. List price, complete with stone, including the furniture and reglet \$135 00

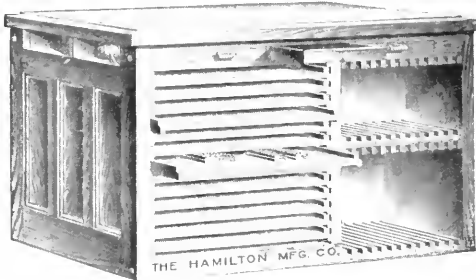

Ramaley Imposing Stone Frame. One view showing letter boards and chase racks

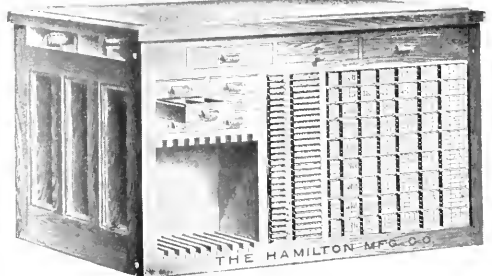

Ramaley Stone Frame. View showing furniture and reglet rack

The Texas Imposing Stone Frame

This Stone Frame differs from others only in the interior arrangement under the stone. It is most substantially constructed of selected hardwood, strongly bolted, and the floor space occupied is reduced to the minimum. It is economical in the fullest sense of the term as it replaces several pieces of ordinary printing office furniture. While the expense may seem large to install, it ends with the purchase. This saving in expense is not only in material but in labor.

SORT DRAWERS. There are twenty drawers for sorts, and each drawer is sub-divided into twenty equal compartments. Each drawer is two and one-half inches deep, fourteen inches wide and forty and three-eighths inches long, inside measure. Each of the four hundred compartments is three and three-quarters inches by six and three-quarters inches. Ten of these drawers are at each end of the frame, and all run clear through and draw from either side. Each drawer runs on twelve steel rollers, fitted into the runs, six on each side.

LETTER BOARDS. In the center, arranged in four tiers, two tiers drawing from each side, are fifty-six hardwood letter boards, fourteen boards in each tier. These are placed compactly and represent one hundred and forty square feet of storage surface. These letter boards are eighteen and one-half inches by nineteen and one-quarter inches, inside measure. They are lipped in front to receive the galley and have retaining walls at side and back.

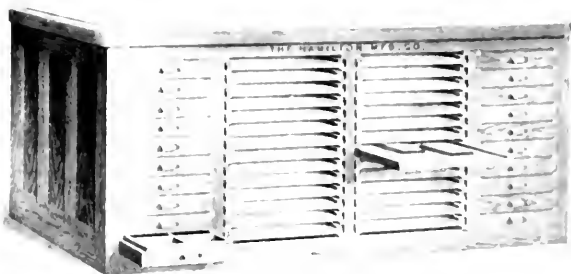

The Texas Imposing Stone Frame with Letter Board and Sort Drawers.

List Price and Dimensions of Texas Imposing Stone Frame

Occupies floor space 42 $\frac{1}{2}$ x21 $\frac{1}{2}$ inches. The size of the stone is 40x80 inches and 2 inches thick. The coffin enclosing the stone is depressed $\frac{1}{16}$ of an inch below the top of stone, and is used as a rest for the galley, so that type matter can be passed from the stone to the galley. Height from floor to top of stone, 11 $\frac{1}{2}$ inches. Weight, complete, ready for shipment, including stone, 1900 pounds. Weight of stone only, 750 pounds. List price, complete \$150 00

The Two Rivers Imposing Stone Frame

The Two Rivers Frame embodies many good features of other frames, at the same time providing letter board and sort drawer equipment. It is strongly constructed of selected hardwood and is well bolted. The finish is like the best printers' cabinets.

LETTER BOARDS. Eleven Boards on one side, inside measure, twenty-five by thirty and one-half inches.

These boards are lipped at the front to receive the brass galley.

SORT DRAWERS. Sixteen in two tiers, each divided into ten equal compartments, size four and one-half by four and three-eighths by three inches inside.

DRAWERS. Two large drawers at top which run through frame and can be drawn from either side. Size inside, thirteen and one-quarter by thirty-seven by two and three-quarters inches.

In the center, at the top, one above the other, running through the frame from side to side are two drawers for the storage of metal furniture. Size inside, thirteen and one-quarter by thirty-seven by one inch.

FURNITURE. Of clear selected stock, oil soaked, each piece with length stamped on the end. This furniture and reglet equipment is cut on our own special machinery, which insures its accuracy.

There are nine different lengths, as follows: 12, 18, 24, 30, 36, 42, 48, 54 and 60 picas, the variation being by inches or six picas. The widths and number of pieces are as follows:

Eighteen pieces of two-line cut 12, 18 and 24 picas long. Twenty-four pieces of two-line cut 30, 36, 42, 48, 54 and 60 picas long; fifteen pieces of three, four, five and six-line cut 12, 18 and 24 picas long; twenty pieces of three, four, five and six-line cut 30, 36, 42, 48, 54 and 60 picas long; twelve pieces of eight and ten-line cut 12, 18 and 24 picas long; sixteen pieces of eight and ten-line cut 30, 36, 42, and 60 picas long. Total number of pieces, eleven hundred and twenty-two; amounting to two hundred yards.

REGLET. Absolutely accurate and on the point system. A double rack for holding thirty-seven pieces of nonpareil and thirty-seven pieces of pica of each of the following lengths: 12, 13, 14, 15, 16, 17, 18, 19, 20, 21, 22, 23, 24, 25, 26, 27, 28, 30, 33, 36, 39, 42, 45, 48, 51, 54, 57 and 60 picas, a total of twenty hundred and seventy-two pieces, amounting to two hundred and ninety yards.

Stones are of the best Vermont marble, and with perfect imposing surfaces. All our stones are from the famous Rutland quarries.

Roller Compartment is made with door. Rollers stand on end. Has accommodations for three rollers each for eight, quarto and half medium presses. When roller compartment is not required, this cupboard can be used for a variety of purposes. An additional shelf will convert it into a convenient ink cabinet or it can be used for the storage of galleys, etc.

List Price and Dimensions of Two Rivers Imposing Stone Frame

Shipping weight, with stone complete, 1110 pounds. Weight of stone only, 500 pounds. The Two Rivers Frame takes a floor space 38 $\frac{1}{2}$ x26 $\frac{1}{2}$ inches. List price, complete with furniture, reglet and stone \$125 00



Two Rivers Imposing Stone Frame—Front View

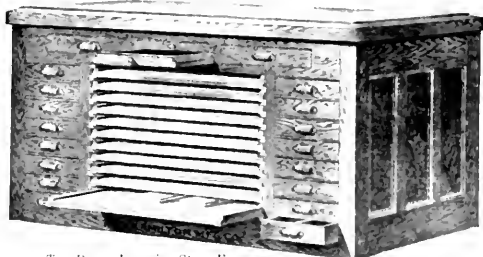

Two Rivers Imposing Stone Frame—Rear View

The Universal Imposing Stone Frame

There is an increasing demand for large Imposing Frames with an abundance of Letter Board surface. The size of Stone, forty-eight by seventy-two inches, which the Universal Frame takes, is coming into general use.

This thoroughly modern and compact Frame is fitted with the dustless recessed bottom, with no square corners for the accumulation of dust. The runs supporting the letter boards are of heavy angle iron.

The material is all selected hardwood throughout; the ends are paneled with moulded edges, and all outside surfaces have the same finish as our best cabinets.

Both sides are alike, there being four tiers of letter boards—two tiers on each side, fourteen boards in each tier. These letter boards are made of the very choicest selected hardwood, free from every imperfection, and are lipped at the front to receive the galley. The fifty-six letter boards provide two hundred and eighty-eight square feet of surface, while the frame occupies a floor space of twenty-six square feet, and, in addition, provides twenty-four square feet of stone surface and sixteen square feet for metal furniture in the four drawers. The ends of the frame under the stone are open, providing convenient shelving for planers and other working tools.

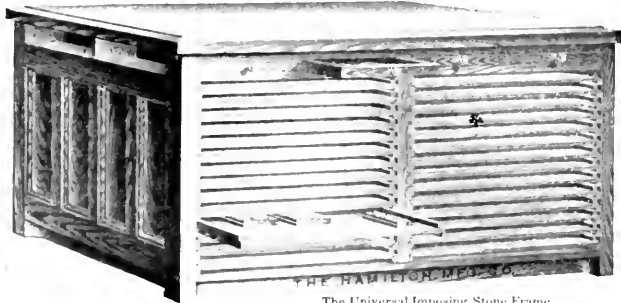

The Universal Imposing Stone Frame

List Price and Dimensions of Universal Imposing Stone Frame

Size of stone, 48x72 inches; occupies floor space, 50 $\frac{1}{2}$ x71 $\frac{1}{2}$ inches; height from floor to top of stone, 38 inches; size of letter boards, 31 $\frac{1}{2}$ x23 $\frac{1}{2}$ inches, inside measure; four drawers for metal furniture in the upper rail, size 12 $\frac{1}{2}$ x18 $\frac{1}{2}$ x1 inches, inside measure. These drawers run through the frame and can be pulled from either side. Weight, crated, without stone, 1000 pounds; stone only, 900 pounds. List price, complete with letter boards and stone \$165 00

Savage Imposing Stone Frames

The Savage Imposing Stone Frames are designed to carry individual galleys. The shelves are numbered consecutively, and by marking the proofs of the pages with the corresponding numbers of the shelves upon which the pages are stored, any particular page can be located instantly when wanted. While specially valuable for pages of tariffs, directories, catalogues, etc., this arrangement is equally adapted to forms of every description. Some disposition, temporary at least, must be made of every form. If left on the stone, it occupies working space; if placed upon letter boards or stacked upon shelving, no one but the compositor who put it there can find it. When found, it is frequently underneath or surrounded by other matter which has to be removed and replaced, with consequent loss of time and damage to material.

These frames provide a place for every form, where it does not occupy valuable working space, yet where any compositor can go directly to the galley containing the desired page without unnecessary loss of time.

The pages being on galleys can be handled quickly and conveniently, without danger of pi. Corrections can frequently be made on the galleys and proofs taken if desired. Printers will recognize the advantage of this method of carrying standing pages. These frames have recessed sanitary bases, as shown in illustrations.

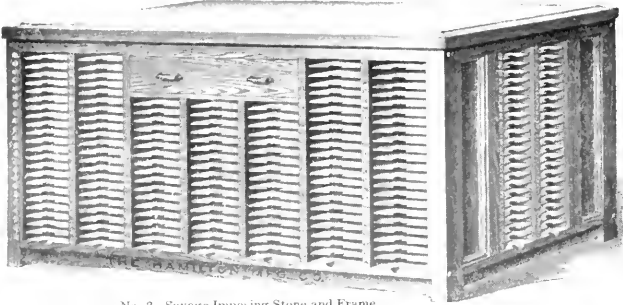

No. 2. Savage Imposing Stone and Frame

List Price and Dimensions of Savage Imposing Stone Frame No. 1

Size of stone, 36x60 inches; capacity, 302 galleys; galley compartments, 9 inches wide, 13¹/₈ inches deep, taking a standard 8³/₄x13 inches galvano steel galley. Galley shelves on both sides and both ends of the Frame. All galley shelves are numbered consecutively. One large drawer for mallet, planer, and other tools, running through the Frame, pulling from either side. Weight of Frame, complete with stone, 1100 pounds. Weight of stone only, 500 pounds. Occupies floor space 38¹/₂x62¹/₂ inches. List price, complete with stone

\$135 00

List Price and Dimensions of Savage Imposing Stone Frame No. 2

Size of stone, 48x72 inches; capacity, 384 galleys; galley compartments, 9 inches wide, 13¹/₈ inches deep, taking a standard 8³/₄x13 inches galvano steel galley. Galley shelves on both sides and both ends of the Frame. All galley shelves numbered consecutively. Two drawers for mallet, planer, and other tools, running half way through the Frame, one pulling from each side. Weight of Frame, complete with stone, 1700 pounds. Weight of stone only, 900 pounds. Occupies floor space 50¹/₂x74¹/₂ inches. List price, complete with stone

\$165 00

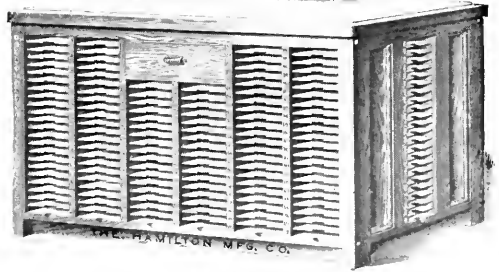

No. 1. Savage Imposing Stone and Frame

Economic Imposing Stone Frame

This is the smallest imposing frame made, taking a stone twenty-four by thirty-six inches. It is a modern Frame and possesses many of the excellent features found in much larger frames. There are eleven letter boards on one side, size inside, thirty-three inches wide and of varying depths from thirteen and one-half to nineteen inches.

At the top there are two drawers for the storage of metal furniture and one deep drawer for quoins, tools and other accessories; these drawers run clear through the Frame, and can be drawn from either side.

On the other side of the Frame is an assortment of wood furniture, as follows: twenty-one pieces, two, three and four-line; fifteen pieces, five and six-line; twelve pieces, eight and ten-line, cut 12, 18 and 24 picas long. Twenty-eight pieces, two, three and four-line; twenty pieces, five and six-line; sixteen pieces, eight and ten-line, cut 30, 36, 42, 48, 54 and 60 picas long. This is a fine assortment of lengths and widths most used, and brings the furniture close to the stone man, where it is required.

The Frame is strongly constructed, of hardwood throughout, and the stone is of the finest quality. A strictly first-

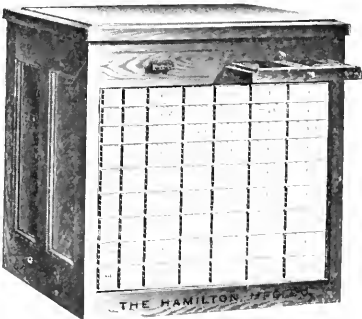

Economic Imposing Stone Frame. Size of Stone 24x36

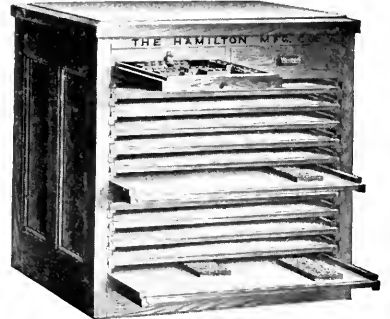

Economic Imposing Stone Frame. Size of Stone 24x36

class piece of furniture in every way, and fully guaranteed to give perfect satisfaction to our customers.

List Price and Weight of the Economic Imposing Stone Frame

Weight, crated, ready for shipment, without stone, 450 pounds, including stone, 650 pounds. List price \$60 00

Imposing Stone Frames with Letter Boards

No. 1 Imposing Stone Frame is constructed of hardwood throughout, strongly bolted to carry great weight and handsomely finished. Letter boards are lipped at the front

to receive the galleys and have retaining rims at the ends and back. Boards can be pulled from either side of the Frame, but are lipped only on one edge. Size of stone, twenty by twenty-five inches, best Vermont marble, two inches thick. Furnished complete with ten hardwood letter boards. Size of letter boards, inside measure, twenty by twenty-two inches.

No. 2 Imposing Stone Frame is the same as No. 1, except it is made in the following dimensions, and is most convenient for six-column two-page forms: Size of stone, twenty-four by thirty-six inches. Size of letter boards, inside measure, twenty-four by thirty-two inches.

No. 3 Imposing Stone Frame is the same as No. 1 and No. 2, except it is made in the following dimensions: Size of stone, thirty-two by forty-eight inches. Size of letter boards, inside measure, thirty-two by forty-four inches. This frame is especially recommended as one to meet the requirements of the average modern printing shop.

List Prices and Dimensions of Imposing Stone Frames

Imposing Stone Frame No. 1: Height, 38 inches; width, 22¹/₂ inches; length, 27¹/₂ inches. Weight, crated, complete without stone, 200 pounds. Weight, crated, complete with stone, 310 pounds. List price, complete with stone . . . \$27 00

Imposing Stone Frame No. 2: Height, 38 inches; width, 26¹/₂ inches; length, 38¹/₂ inches. Weight, crated, complete without stone, 285 pounds. Weight, crated, complete with stone, 465 pounds. List price, complete with stone . . . 34 00

Imposing Stone Frame No. 3: Height, 38 inches; width, 34¹/₂ inches; length, 50¹/₂ inches. Weight, crated, complete without stone, 450 pounds. Weight, crated, complete with stone, 870 pounds. List price, complete with stone . . . 50 00

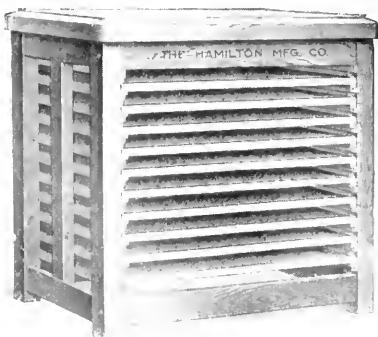

Style of Nos. 1, 2 and 3 Imposing Stone Frames with Letter Boards

The Wisconsin Imposing Stone Frame

This is a most useful Frame, containing racks for large sizes of chases. We furnish this Frame with plain blank cases, as shown in the illustration, or with indexed electrotype cases. This Frame is thoroughly well built of hardwood throughout and bolted at the ends. The coffin is of selected oak. The ends are tastefully paneled with moulded edges.

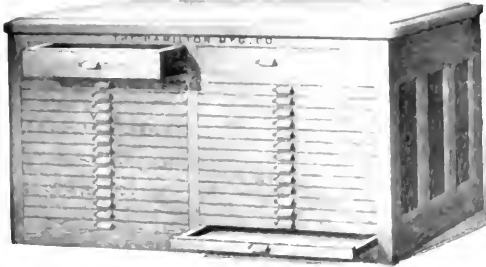

The Wisconsin Imposing Stone Frame - Front View

The stone is of the best Vermont marble, two inches thick, and free from imperfections. This stone is hard and makes the best stone imposing surface ever offered. The top of the stone is thirty-eight inches above the floor.

Weight of frame, complete with stone, eleven hundred pounds.
Weight of stone only, five hundred pounds.
Occupies floor space, thirty-eight and one-half by sixty-two and one-quarter inches.

List Prices of the Wisconsin Imposing Stone Frame

With twenty-eight blank cases as shown in the illustration and including the stone, complete \$ 95 00
With twenty-eight indexed electrotype cases and full equipment of division strips and index book, complete and including the stone 105 00

On one side of this Frame there are twenty-eight cases, size inside, fifteen by twenty-six inches. These cases are arranged in two tiers, fourteen cases in each tier. They are of the New Departure pattern with three-ply bottoms, and as placed in the Frame are practically dust proof. On the other side are chase racks, as follow

Nine compartments, size inside, twenty-six by eighteen inches
Nine compartments, size inside, fourteen by eighteen inches
Nine compartments, size inside, eleven and one-half by fifteen inches.

The bottoms of chase racks are covered with heavy sheet iron, turned at front edge and securely fastened, thus preventing injury to the Frame by the iron chases when pushed into place.

At the top are two drawers, running through the frame, and they can be drawn from either side. These are for quions, tools, furniture, etc.

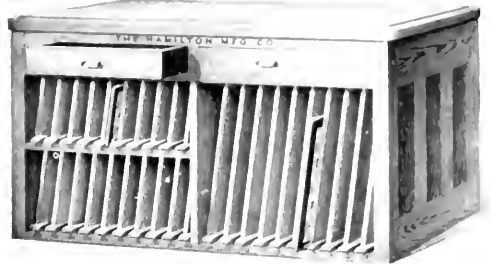

The Wisconsin Imposing Stone Frame - Rear View

Imposing Stone Frames with Square Legs

The imposing stone frame is an important piece of furniture in every printing office and should be carefully selected with a view of getting the best the market affords. This splendid frame is substantially constructed of selected hardwoods, the coffin is of oak, and is so made that when the stone is bedded it will project one-sixteenth of an inch above the coffin. This ledge is to receive the galley which rests on the coffin. Type matter can be transferred from galley to stone without danger of damage. The Square Leg Frame is made with four or six legs, according to size. All six leg frames have two drawers, while the four leg frames have one drawer.

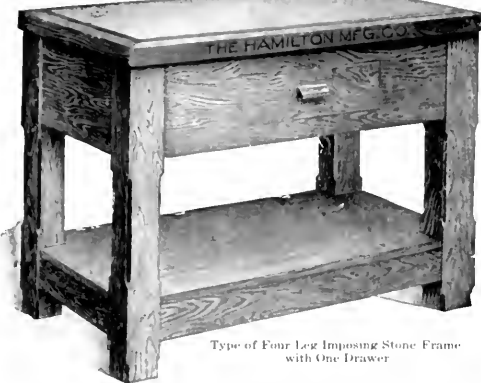

Type of Four Leg Imposing Stone Frame with One Drawer

These drawers run through the frame and can be withdrawn from either side. The frame is furnished in the white, without finish, and shipped in knockdown form, with the stone crated separately.

It is equipped with the finest grade of Vermont marble, the best stone imposing surface in the world. The weight of the imposing stone is the standard thickness of two inches, is approximately thirty pounds per square foot, uncrated, and thirty-seven pounds crated.

A liberal equipment of imposing surface will help to secure the maximum output. The utility of a stone frame is doubled by utilizing the space underneath for letter boards, chase racks, furniture, reglet, etc. The low-priced, square-legged frame will answer admirably in a country office where space is not at a premium.

These frames are made of hardwood in knockdown form. This insures convenience in handling, and large frames can be taken up stairways and through narrow doors.

To properly bed an imposing surface it should be laid in putty. Take the stone and place on skids on the floor face down. Roll strips of putty and lay on the stone where the supporting strips will rest. Take coffin and reverse, placing it over the stone. Lift coffin and stone together and place on the frame. Tap stone to thoroughly bed it and see that it projects evenly above the inner edge of the coffin the thickness of a

brass galley bottom. Fill space between edges of stone and coffin with putty.

Square leg stone frames can be furnished for iron surfaces. These do not usually require a coffin, which reduces the list price of the frame 50 cents per foot the long way. For instance a 36x60 frame without the coffin would take a reduction in the list price of \$2.50. When iron surface is to be used customers should determine the exact size of the iron surface which should conform with the size of the frame. It is usual to allow iron surfaces to overlap the edges of the frame one-half inch all around.

All imposing stones are crated separately and are shipped at customer's risk. As stones are very heavy this is necessary in order to get a low freight rate. If shipped released they take fourth-class rate, if not released they take first-class rate.

List Prices and Dimensions of Imposing Stone Frames with Square Legs

No.	Capacity of Stone	Size of Stone Inches	Weight of Stone Pounds	Price of Stone	Floor Space Taken by Frame, Ins.	Height to Top of Stone	Weight of Frame Pounds	No. of Legs	Price of Frame
60	2 pages, 6 column	21x36	210	\$ 6 00	26 ¹ / ₂ x38 ¹ / ₂	38 ¹ / ₂ in.	130	4	\$ 7 25
61	2 pages, 7 column	26x44	280	8 00	28 ¹ / ₂ x46 ¹ / ₂	38 ¹ / ₂ in.	140	4	8 00
62	2 pages, 8 column	28x50	350	10 00	30 ¹ / ₂ x52 ¹ / ₂	38 ¹ / ₂ in.	160	4	9 00
63	For Job Work	36x48	420	12 00	38 ¹ / ₂ x50 ¹ / ₂	38 ¹ / ₂ in.	190	4	9 50
64	2 pages, 9 column	32x60	470	13 50	34 ¹ / ₂ x62 ¹ / ₂	38 ¹ / ₂ in.	200	4	10 00
65	4 pages, 7 column	26x76	475	13 75	28 ¹ / ₂ x78 ¹ / ₂	38 ¹ / ₂ in.	200	6	10 75
66	4 pages, 8 column	28x80	530	15 50	30 ¹ / ₂ x82 ¹ / ₂	38 ¹ / ₂ in.	270	6	12 50
67	4 pages, 9 column	30x80	650	18 75	32 ¹ / ₂ x82 ¹ / ₂	38 ¹ / ₂ in.	290	6	11 50
68	4 pages, 7 col. Quarto	36x60	525	15 00	38 ¹ / ₂ x62 ¹ / ₂	38 ¹ / ₂ in.	200	4	12 00
69	4 pages, 7 col. Quarto	48x60	675	20 00	50 ¹ / ₂ x62 ¹ / ₂	38 ¹ / ₂ in.	225	4	15 00

When coffins only are desired they can be furnished in any size at 75 cents per running foot the long way. The prices of tables without stones include the coffins. Imposing stones only for larger frames list at \$1.00 per square foot.

Hamilton Transfer Imposing Stone Frame

This frame will be found a convenient and economical piece of modern printing office furniture. Forms can be transferred about the office without lifting from the stone. The frame is mounted on heavy swivel castors, which insure easy motion.

List Price and Dimensions of the Hamilton Transfer Imposing Stone Frame
Occupies floor space 28¹/₂x46¹/₂ inches. Height from floor to top of stone, 38 inches. Size of end drawer, inside measure, 7 inches wide, 24 inches long, 4 inches deep. Size of center drawer, inside measure, 12 inches wide, 8 inches long, 1¹/₂ inches deep. Size of imposing stone, 26x44 inches. Weight, crated, complete without stone, 230 pounds. Weight, crated, complete with stone, 475 pounds. List price, complete with stone \$45 00

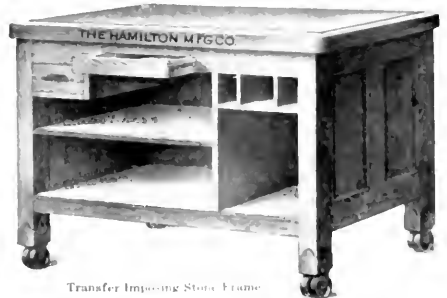

Transfer Imposing Stone Frame

Imposing Stone Frames With Letter Boards

The general use of Imposing Stone Frames with all space under the stone utilized is steadily increasing and few printing offices are now without one or more of these decidedly economical pieces of modern printing office furniture. The following list of imposing stone frames with letter boards is a comprehensive one, but as it is not always possible to meet the requirements of every printer with a stock frame, we are prepared to supply special frames to meet any desired condition. The No. 1 Imposing Stone with Letter Boards, as well as all the frames

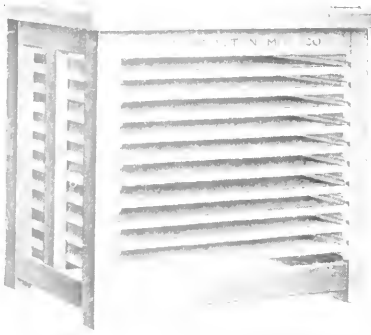

Style of Nos. 1, 2 and 3 Imposing Stone Frames with Letter Boards

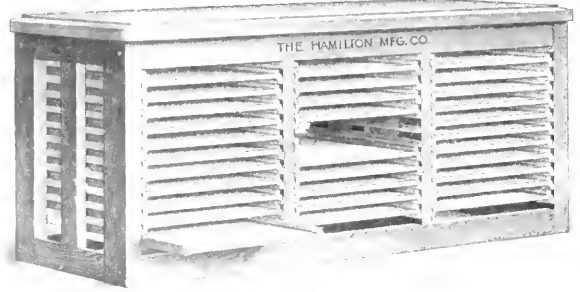

No. 4 Imposing Stone Frame with Letter Boards

described here are constructed of hardwood throughout and strongly bolted to carry great weight. They are all handsomely finished. The letter boards are lipped at the front to receive the galleys and with retaining rims at the ends and back. The boards can be pulled from either side of the frame, but are lipped only on one edge. All stones are of the best Vermont marble, two inches thick. For dimensions and prices, etc., see list below.

The No. 2 Imposing Stone Frame is the same as the No. 1, except in size and is most convenient for six-column two-page forms. The No. 3 Imposing Stone Frame is the same as the Nos. 1 and 2, except in dimensions, which will be found in the list annexed.



No. 6 Imposing Stone Frame with Letter Boards

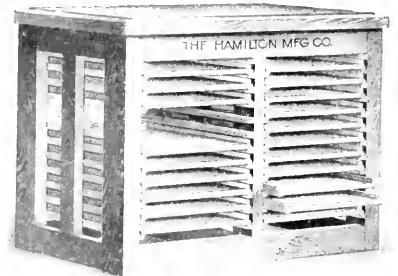

No. 5 Imposing Stone Frame with Letter Boards

The No. 4 Imposing Stone Frame is large and commodious and will safely carry any load to which it can be subjected. All outside surfaces are nicely varnished and finished in a manner equal to the best cabinet work. The boards are arranged in three tiers, eleven boards to each tier. This size is most convenient for nine-column four-page forms.

The No. 5 Frame is compact and substantial and most servicable for seven-column two-page forms. The boards can be drawn from either side of the Frame.

The No. 6 Imposing Stone Frame is most substantially constructed to carry great weight. The boards are lipped on one front edge only to receive the brass galleys, so that type can be easily transferred from the galleys to the boards, and back to the galleys again. The size is most convenient for seven-column four-page forms.

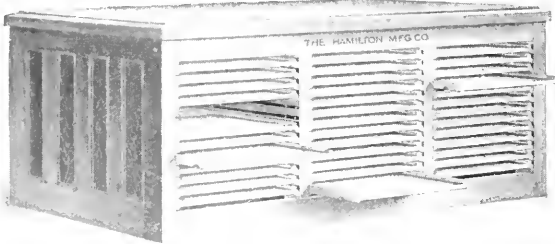

No. 7 Imposing Stone Frame with Letter Boards

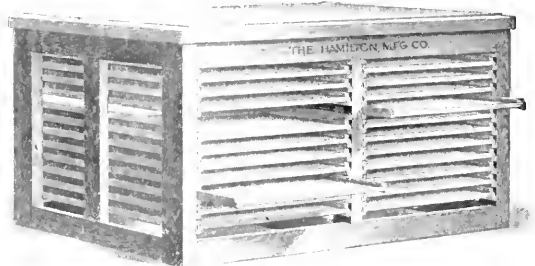

No. 8 Imposing Stone Frame with Letter Boards

The No. 7 Frame with Letter Boards. Where concentration and great storage capacity is desired, the No. 7 Frame will meet all requirements. Nothing could be more substantial. The materials are the best selected hardwood, steel and stone throughout. The ends are paneled, with moulded edges, and all outside surfaces are nicely varnished and finished equal to the best grades of cabinet construction. There are six tiers of hardwood letter boards, arranged thirteen boards to each tier; three tiers of boards

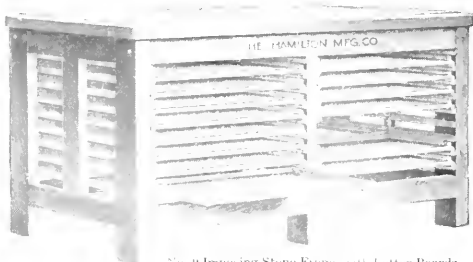

No. 9 Imposing Stone Frame with Letter Boards

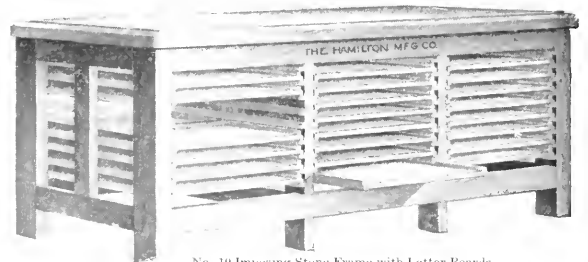

No. 10 Imposing Stone Frame with Letter Boards

pulling from each side of the Frame. The letter boards are of the finest selected stock, free from imperfections, and are smooth and well finished. They have retaining rims on the ends and backs to hold the type forms in position. All the runs on which the

Imposing Stone Frames With Letter Boards—Continued

boards ride are of heavy angle iron, and will carry any weight which can be placed on the boards. Each letter board has four steel rollers fitted on the under side to insure easy motion when boards are heavily loaded. There can therefore be no wear on the wooden parts, and the frame will last indefinitely, and will give excellent service.

The No. 8 Frame represents a good example of economical construction. It has great storage capacity, and the stone is of a size most convenient for seven-column quarto four-page forms; is substantially constructed throughout, and nicely finished. The boards are arranged in four tiers, two tiers pulling from each side of the frame; eleven boards in each tier.

The No. 9 Frame is a most popular medium sized frame, and comparatively low priced. While not so compact as some of the other frames, it has large storage capacity. The bottom rails being raised from the floor prevents dust and dirt from accumulating underneath. The boards are arranged in four tiers, two tiers drawing from each side of the frame. This frame is a most convenient size for six-column quarto four-page forms.

The No. 10 Frame represents one of the best all around pieces of printing office furniture ever listed. Hundreds are in use in the best offices. It is strongly constructed of selected hardwood, well belted and will carry any weight which can be put into it. The boards are arranged in six tiers, three tiers drawing from each side of the frame. The fronts of these boards are hipped to receive the brass galley, and they have retaining rims on the ends and at the back.

Illustrations of the No. 8, No. 9 and No. 10 Frames will be found on the preceding page.

List Prices and Dimensions of Imposing Stone Frames with Letter Boards

No.	Size of Stone Inches	Number of Letter Boards	Size of Letter Boards Inside	OUTSIDE DIMENSIONS OF FRAME			Weight Cabinet Pounds	Weight with Stone Pounds	List Price Complete
				Height Inches	Width Inches	Length Inches			
1	20x25	10	20 x 22 1/2	38	22 1/2	27 1/2	200	310	\$ 27 00
2	24x36	10	24 x 32	38	26 1/2	38 1/2	285	465	31 00
3	32x48	10	32 x 34	38	34 1/2	50 1/2	450	870	50 00
4	30x90	33	30 x 26	38	32 1/2	92 1/2	800	1400	110 00
5	26x44	22	26 1/2 x 18 1/2	38	28 1/2	46 1/2	380	620	57 00
6	26x76	33	26 1/2 x 21 1/2	38	28 1/2	78 1/2	650	1050	81 00
7	48x80	78	23 1/2 x 22 1/2	38	50 1/2	82 1/2	1100	2000	220 00
8	48x60	44	23 1/2 x 26	38	50 1/2	62 1/2	850	1450	100 00
9	36x60	32	17 1/2 x 26	38	38 1/2	69 1/2	600	1050	72 50
10	40x80	48	19 1/2 x 22 1/2	38	42 1/2	82 1/2	800	1500	95 50

These prices are subject to our prevailing discounts.

Standing Galley with Letter Boards

This standing galley is specially constructed for use in machine offices requiring large storage room for type forms. It is equipped with twenty hardwood letter boards, providing one hundred and two square feet of letter-board surface and accommodating twenty-eight double-column galleys.

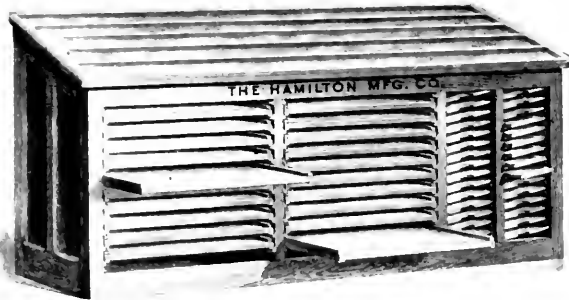

No. 10 Standing Galley with Twenty Letter Boards and Galley Racks

in regular column galleys. The dimensions are: length over all, eight feet; depth, twenty-seven inches; height, at front, three feet; height, at back, three feet ten inches.

Size of letter boards is twenty-four by thirty and one-half inches inside.

This standing galley can be furnished with ten letter boards twenty-four by twenty-one inches inside, in place of the galley rack, without change in price. Triple-column brass-lined galleys to fit galley racks, size eight and one-quarter by twenty-three and one-quarter inches inside, \$3.25 each, list.

List Prices of Standing Galley with Letter Boards

	Wgt. lbs.	Price
No. 10 Unlined, wood top, with twenty Letter Boards and Galley Racks	775	\$72 00
No. 11 Zinc lined top, with twenty Letter Boards and Galley Racks	825	95 00
No. 12 Brass lined top, with twenty Letter Boards and Galley Racks	815	107 00

These prices are subject to our prevailing discounts.

The American Type Founders Company carries the largest line of Printers' Supplies and also gives the best service because it is the largest concern in the world dealing in type, printers' machinery and supplies, and has conveniently located selling houses ready to receive your orders and fill them with the least possible delay and at the right prices.

Hardwood Letter Boards

These can be supplied with or without cabinets. The boards are of standard size and will fit any regular case stand or rack for standard size type cases. No. 1 is the same length as a two-thirds size case. No. 2 is the same length as a three-quarter size case. No. 3 is the same length as a full size case. They are made of the finest selected hardwood with retaining rims on three sides. The open side is hipped to receive the galley. The boards are made to provide for contraction and expansion. Climatic changes do not affect them. Boards can be ordered singly or in lots and will always be found uniform in size. No feature of modern printing office equipment has undergone a larger development than letter boards. For the convenience of customers who have no stand room for the accommodation of these boards they can be listed with cabinets to hold sixteen boards at the prices shown in the following table:

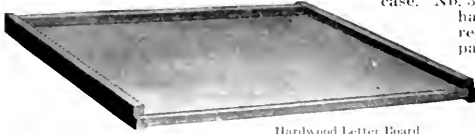

Hardwood Letter Board

List Prices of Letter Boards Without Cabinet

Boards Only	Size Outside Inches	Size Inside Inches	Weight per Board	Price
No. 1 Letter Board	21 1/2 x 20 1/2	20 x 19 1/4	9 pounds	\$1 20
No. 2 Letter Board	26 1/2 x 20 1/2	24 1/2 x 19 1/4	12 pounds	1 40
No. 3 Letter Board	32 1/2 x 20 1/2	30 1/2 x 19 1/4	13 1/2 pounds	1 70

Subject to prevailing discounts.

List Prices of Cabinet and Boards

Cabinets	Number of Boards	Floor Space Occupied Inches	Height	Complete	Price Complete
No. 28	16 No. 1 size	22x25 1/4	48 inches	240 pounds	\$32 00
No. 29	16 No. 2 size	22x30	48 inches	350 pounds	36 00
No. 30	16 No. 3 size	22x35 1/4	48 inches	430 pounds	42 00

Subject to prevailing discounts.

Handy Letter Board Cabinets

It is seldom that the composing room is equipped with sufficient letter boards to properly provide for the standing matter which must necessarily be kept alive. In many cases makeshift boards are stacked up in some corner of the workroom, which in a way answer the purpose, but do not provide properly for the type forms. The Handy Letter Board Cabinets are made purposely to provide ample space and to take excellent care of the type. They also permit one to readily get at the page or form required with the very smallest effort and in the quickest possible time. The Cabinets and boards may be numbered and indexed at slight cost, thus enabling one to keep track of the work in a systematic manner. The American Type Founders Company offers the printer a sufficient variety to meet the requirements of any office, but in case you do not find illustrated exactly what you want, we invite you to correspond with us and we will do our best to fill your wishes.

For job work these small Handy Letter Board Cabinets are unrivaled. Nos. 25, 26 and 27, in single tier, occupy floor space of sixteen and one-half by nineteen inches, and are filled with letter boards constructed of hardwood throughout. The sides of the Cabinets are tastefully paneled and all exterior surfaces are finished and varnished like the best type cabinets. The letter boards are lipped at the front to receive the galleys and have retaining walls at the ends and back to hold the type forms. Cabinets have hardwood tops and are made with closed backs.

List Prices and Dimensions of Handy Letter Board Cabinets

	Floor Space	Number of Letter Boards	Inside Size of Letter Boards	Height of Cabinet	Weight	Price
No. 25	16 $\frac{1}{2}$ x19 $\frac{1}{4}$ ins.	10	12x15 ins.	32 inches	125 pounds	\$14 50
No. 26	16 $\frac{1}{2}$ x19 $\frac{1}{4}$ ins.	12	12x15 ins.	36 inches	145 pounds	17 00
No. 27	16 $\frac{1}{2}$ x19 $\frac{1}{4}$ ins.	16	12x15 ins.	44 inches	175 pounds	21 00

Other sizes containing any number of standard size Handy Letter Boards built to order.

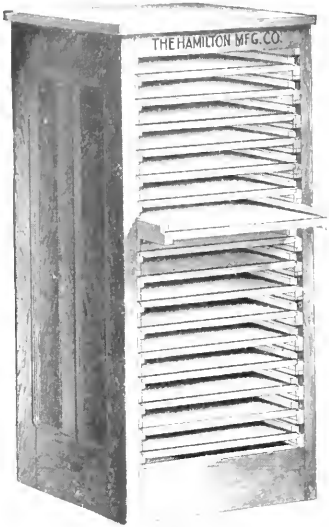

No. 27 Handy Letter Board Cabinet with Sixteen Hardwood Letter Boards

makes a convenient working table. The construction is entirely of hardwood, the ends are paneled, with edges tastefully moulded. All exterior surfaces are varnished and finished in a first-class manner. The letter boards are lipped at the front to receive the galleys, and in size are the same as the boards put into the standard Handy Letter Board Cabinets listed above.

If you are desirous of reducing the cost of labor in your composing room, one of these Letter Boards will materially assist you.

The No. 21 is a good, medium-sized Letter Board Cabinet, which provides sixty-six square feet of letter board surface. It is constructed of selected hardwoods, firmly glued and bolted. The ends are paneled, with moulded edges. All exterior surfaces are nicely finished. Cabinet has closed back and hardwood top, which can be used as a working surface. Contains twenty standard letter boards, size No. 2, which are lipped at the front to receive the galleys and have retaining walls at the sides and back.

A compact and convenient storage cabinet is the No. 22 Letter Board Cabinet. It is used for tied-up forms and standing matter. The top is no higher from the floor than most imposing frames, and it provides a convenient working surface of large size. This Cabinet is constructed of selected hardwood throughout,

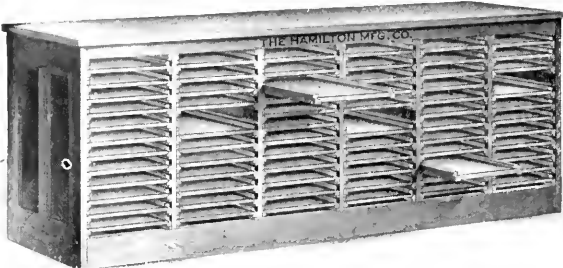

No. 20 Letter Board Cabinet complete with Seventy-two Hardwood Letter Boards

runs, which allow all space to be utilized without waste. The frame is substantially constructed of hardwood throughout, strongly bolted, and will carry an immense load safely. Letter boards are of selected hardwood, lipped at the front to receive the galleys and made with retaining walls at the ends and back. The ends of the Cabinet are paneled, and tastefully moulded on the edges. All exterior surfaces are varnished and nicely finished, like the best of cabinets. Made with a heavy hardwood top and closed back.

On account of the limited space allotted to Letter Board Cabinets we are unable to show illustrations of No. 22 and No. 24. We shall be pleased to send to any one interested a catalogue showing the complete line.

List Prices and Dimensions of Letter Board Cabinets

No.	Floor Space	No. of Letter Boards	Inside Size of Letter Boards Inches	Height of Cabinet Inches	Weight Pounds	Price
20	16 $\frac{1}{2}$ x108	72	12 x15	36	640	\$ 95 00
21	22 $\frac{1}{2}$ x 58 $\frac{1}{2}$	20	19 x24 $\frac{1}{2}$	34	390	52 00
22	22 $\frac{1}{2}$ x104	36	19 $\frac{1}{4}$ x30 $\frac{1}{2}$	38 $\frac{3}{4}$	750	84 00
23	22 $\frac{1}{2}$ x 96 $\frac{1}{2}$	64	19 $\frac{1}{4}$ x20	48	900	110 00
24	28 $\frac{1}{2}$ x 88	45	25 x25	41	1000	120 00

The prices quoted on this page are subject to prevailing discounts

Letter Board Cabinets

The No. 20 Cabinet is the most valuable storage cabinet for a job office having continually on hand a large number of standing forms or tied-up matter of any kind. It can also be utilized for the storage of electros, plated matter, etc. The top of the cabinet being only thirty-six inches from the floor,

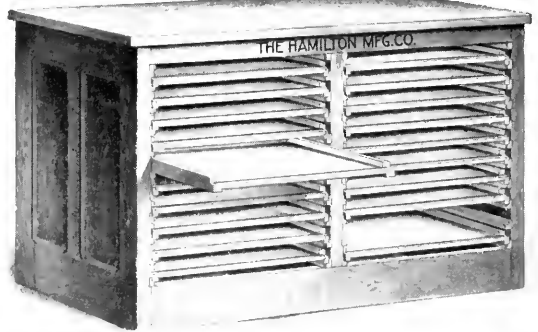

No. 21 Letter Board Cabinet complete with Twenty Hardwood Letter Boards

and it provides a convenient working surface of large size, with paneled ends, and closed back. Letter boards are lipped at the front to receive the brass galleys, and have retaining walls at the ends and back. Contains thirty-six standard size No. 3 letter boards, providing one hundred and forty-seven square feet of letter board surface.

A large and compact storage cabinet for standing forms is the No. 23 Letter Board Cabinet. It occupies comparatively little space, but provides one hundred and seventy square feet of letter board surface. It is constructed of selected hardwood throughout, and the ends are paneled with moulded edges. All exterior surfaces are varnished and finished like the best grades of cabinets. The letter boards are lipped at the front to receive the brass galleys and have retaining walls at the ends and back. This Cabinet contains sixty-four standard size No. 1 letter boards.

The No. 24 Cabinet is the most compact of all letter board cabinets. It occupies but seventeen and a half square feet of floor space and provides one hundred and ninety-five square feet of letter board surface. This large storage capacity is obtained by using heavy angle steel



No. 23 Letter Board Cabinet complete with Sixty-four Hardwood Letter Boards

Cardboard Cabinets

These Cabinets, unless otherwise specified, are furnished with heavy unfinished tops one and one-half inches thick. These tops serve admirably for counter purposes and for laying out and cutting stock, estimating, etc. Cardboard Cabinets are substantially constructed of hardwood with heavy three-ply bottoms, five-sixteenths of an inch thick. They have paneled ends and bronze pulls attached to drawer fronts.

List Prices of Cardboard Cabinets

No. 1 contains 16 drawers; four have an inside depth of 11½ inches; the other twelve are 13½ inches deep inside. Each drawer will take 22½x25-inch stock. Occupies floor space 28½x31½ inches. Height, 41½ inches. Weight, crated, 350 pounds.

List price \$10 00

No. 2 contains 16 drawers; four have an inside depth of 11½ inches; the other twelve are 13½ inches deep inside. Each drawer will take 28x11-inch stock. Occupies floor space 31½x39½ inches. Height, 41½ inches. Weight, crated, 400 pounds.

List price \$52 00

Tympan-Paper Cabinets

A suitable receptacle for the flat storage of proper tympan stock cut to sizes. Such stock should be of hard pressboard, cardboard, and filler stock in various grades, to use under the draw-sheet. A pressman without proper tympan stock cut to size and kept conveniently arranged in a cabinet must first search for a suitable draw-sheet, and after he has found that, he must search again for suitable slip-sheet material, which must be cut to size with much loss of time and waste of stock. All this waste can be saved when he has a suitable stock of tympan paper in proper grades, cut to size. The individual units are made in proper size for stock to fit standard eight by twelve, ten by fifteen and fourteen and one-half by twenty-two presses. Intermediate sizes can be accommodated in the same units. The lower shelf in any unit is for the draw sheets, which are usually the length of the bed of the press and cut three inches wider than the slip-sheet. The three upper shelves in each unit are for different grades and thicknesses of paper for slip-sheets, which should be cut in proper size to fit the bed of the press. Units can be arranged in pyramid form or a unit can be used separately and placed near the particular press in connection with which it is to be used. The units and the base are listed separately, and as many units of each size can be ordered as will be required to provide for the press outfit. The base is provided with a gauge-pin drawer. This base can be conveniently used in connection with units when arranged in pyramidal form. An illustration of this Cabinet will be sent upon request.

List Prices and Dimensions of Tympan-Paper Cabinets

UNIT No. 1—Size outside, 16 inches long, 18 inches deep, 11½ inches high. Has three compartments 11½x8 inches inside for slip-sheets, and one compartment 11½x11 inches inside for draw-sheets. Weight, 35 pounds. List price \$1 00

UNIT No. 2—Size outside, 19 inches long, 18 inches deep, 11½ inches high. Has three compartments 17½x10½ inches inside for slip-sheets, and one compartment 17½x13 inches inside for draw-sheets. Weight, 45 pounds. List price 5 00

UNIT No. 3—Size outside, 26 inches long, 18 inches deep, 11½ inches high. Has three compartments 21½x11½ inches inside for slip-sheets, and one compartment 21½x17½ inches inside for draw-sheets. Weight, 60 pounds. List price 6 50

BASE—Occupies floor space 18½x27½ inches; height, 6 inches; fitted with drawer for gauge pins, divided into 36 compartments, 2 inches square. Weight, 30 pounds. List price 6 00

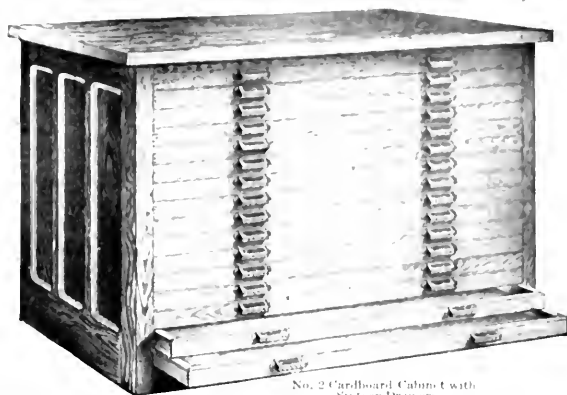

No. 2 Cardboard Cabinet with Sixteen Drawers.

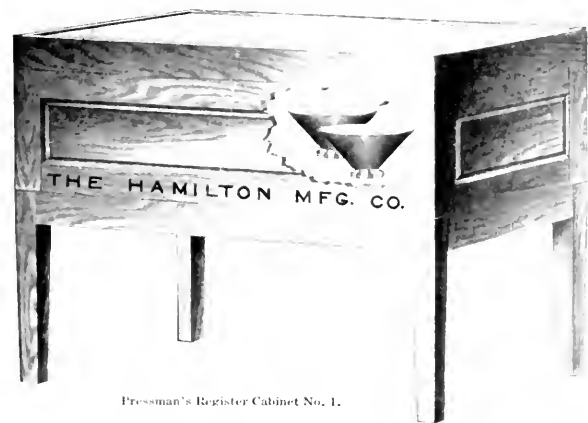

Pressman's Register Cabinet No. 1.

Pressman's Register Cabinets

For testing the register on sheets printed in two or more colors, these Cabinets offer an economical and convenient arrangement. The top is of heavy plate glass, with compartment under glass, finished in white enamel. The light reflectors in the bottom of this compartment are thrown upwards, throwing a strong white light through the sheets when laid on the plate glass to determine the register. The rim surrounding the glass is raised about one-eighth of an inch and serves as a stop for the sheets, when being tested.

When not in use as a register cabinet, the top can be utilized as a most convenient working table. All cabinets are made of hardwood.

List Prices and Dimensions

PRESSMAN'S REGISTER CABINET NO. 1. Occupies ground space 30x11 inches; height from floor to plate glass, 32 inches. Size of plate glass top, 28½x12½ inches. Thickness of glass 5-16 inch. Three lights are fitted in the light compartment, in triangular form, wired and complete with reflectors. Light compartment is finished in white enamel. Top is removable, thus providing ready access. Shipping weight, 325 pounds. List price \$50 00

PRESSMAN'S REGISTER CABINET NO. 2. Occupies ground space 32x11 inches; height, from floor to plate glass, 32 inches. Size of plate glass top, and thickness of glass, same as Cabinet No. 1. The base contains four drawers, 17½x21x33¼ inches inside, and one drawer 36½x28½x33¼ inches inside. Lights and finish of interior, same as No. 1. Access to light compartment is provided by sliding doors on each side. Approximate shipping weight, 125 pounds. List price \$80 00

American Drying Rack and Stock Table

Economy of space, material and time is essential, and the idea of combining the drying rack with the stock table effects a saving alone of nearly fifty per cent. The storage of printed sheets in small lifts avoids back setting and smutting, and all work is thoroughly protected while drying. Further economy is effected by dispensing with excessive handling and bringing the whole drying arrangement close to the job presses.

The American Drying Rack and Stock Table will take care of the work turned out on several job presses, as the dryers run through the frame and can be pulled out from either side. The frame is raised three inches from the floor, providing additional ventilation and ensuring cleanliness.

Contains twenty-four dryers in two tiers, twelve in each tier. The dryers are thirty by thirty inches by one and one-half inches deep, inside measure. There is a clearance of two inches between dryers, providing ample ventilation. All dryers pull from either side. Pulls attached on both fronts. The bottoms of dryers are made of strips one and five-eighths inches wide, three-eighths of an inch thick, spaced one and five-eighths inches apart and will carry any load placed on them.

Dimensions, Weight and Price

Occupies floor space, 32x69 inches; height, 40 inches; weight, crated for shipment, 480 pounds. List price \$56 00

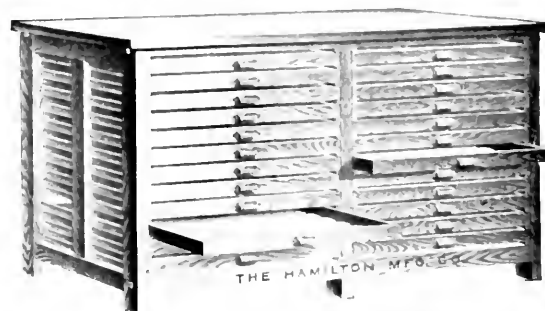

American Drying Rack and Stock Table

Labor-Saving Cabinets and Racks for the Composing Room

There is an increasing demand for labor-saving devices for the composing room and we therefore illustrate on this page a variety of very useful and convenient Lead and Slug Racks, as well as a splendid Metal Furniture Cabinet. Our Lead and Slug Racks will be found great time-savers when properly distributed in convenient places throughout the composing room. Some offices use as many as eight racks and compositors are never obliged to walk more than a few feet to obtain their leads and slugs.

Metal Furniture Cabinet

This rack has a double face and has been designed to hold a large quantity of metal furniture in a compact form and at the same time allow free access to every size. Every printer knows how readily metal furniture can be damaged. The use of this rack will prove economical as it will greatly prolong the life of metal furniture. Having the double face it can be filled from both sides. It has two compartments for each length and width, one on each side of the cabinet. Each compartment holds sixteen pieces arranged in two tiers, stacked eight pieces high, giving a total capacity of over three hundred pounds of metal furniture. Each compartment is numbered for easy reference.

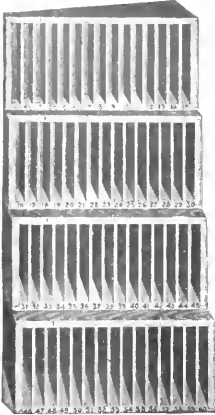

Boston Lead Rack

Description and List Price
The size of this rack is 15 $\frac{1}{2}$ inches wide, 9 inches deep and 4 feet 10 inches long, outside dimensions. Weight crated, 75 pounds. List price **\$12 00**

Boston Lead Rack

Made in four sections, which are sold separately, if desired. The different lengths which go in each section are stamped at the bottom of each compartment, as shown in cut. A line-gauge for determining lengths is attached to each section. The four sections accommodate lengths from four to seven, varying by ems, and from seven to sixty, varying by ems. Compare the space occupied by these racks with that now taken up by your leads and slugs.

Wisconsin Lead Racks

They commend themselves to practical printers as being common-sense and in which leads will not pi. These are made in a superior solid style, and each compartment is numbered very plainly. A line-gauge rule is attached to every Lead Rack to assist the workman in determining lengths, while distributing leads.

Two-Tier Wisconsin Rack

In this rack leads and slugs lie flat and will not pi. (In racks where leads are placed on edge pi inevitably results.) There are compartments to take leads from four to twelve and one-half ems (varying by ems), and from thirteen to sixty ems (varying by ems), the lengths being stamped over each compartment. The rack is solidly built. Compartment are eight inches high. Will hold seven hundred and fifty pounds of leads and slugs. Weight, forty pounds.

Four-Tier Wisconsin Rack

Has two compartments each for all sizes in the two-tier rack described above, and is similar in design and construction. One compartment of each size may be used for leads and the other for slugs or reglet. Will hold fifteen hundred pounds of leads and slugs. A font of labor-saving reglet to fill this rack, consists of twelve hundred yards, cut into nine thousand, one hundred and eight pieces, forty-six pieces of pica and ninety-two pieces of nonpareil of each of the sixty-six different lengths. Weight, eighty pounds.

Eureka Lead Rack

Substantially constructed in two sections, each section holds lengths from four to twenty-eight ems, varying by single ems. One section may be used for leads and the other for slugs. The partitions in this rack are placed on an incline to prevent the leads and slugs from falling. These partitions are also inclined backwards, so that the material cannot be easily thrown from the case by a slight jar. The Eureka Lead Rack is essentially a space-economizing and labor-saving device. It differs in many particulars from other lead and slug racks and offers superior advantages both in construction and details of workmanship. Racks of this description assist materially in insuring order in a printing office and their use obviates all danger of the leads becoming pied. The compartments are all numbered and the Rack is solidly built. The fact that the partitions are placed on an incline is an advantageous feature of the Eureka Rack. Weight, eleven and one-half pounds.

The American Type Founders Company is always prepared to fully equip printing offices with all the latest devices for expediting work and effecting economies. The services of its experts are at the disposal of those desiring them and as their experience is wide and varied they are in a position to tender advice, which if adopted is bound to achieve the best possible results. If in this list you do not see just what you desire, write us and we shall be happy to assist you in any way we possibly can to attain satisfaction.

List Prices of Lead Racks and Reglets to Fill

STYLE	Size Outside Inches	Capacity Leads Pounds	Height of Compartm'ts Inside, In.	Width of Compartments Inside, Inches	Price Rack Only	Weight Boxed Pounds	Price of Reglet to Fill	Weight Reglet Only Pounds
Two-tier Wisconsin Rack	18 x 42 $\frac{1}{2}$	750	7 $\frac{1}{2}$		\$6 00	73	\$14 00	40
Four-tier Wisconsin Rack	34 $\frac{1}{2}$ x 42 $\frac{1}{2}$	1500	7 $\frac{1}{2}$		9 00	105	28 00	80
Eureka Lead Rack	11 $\frac{1}{2}$ x 28 $\frac{1}{2}$	230		5 $\frac{1}{2}$ in.	2 50	15	4 25	11 $\frac{1}{2}$
Boston Rack, No. 1, 4 to 15 ems	8 $\frac{1}{2}$ x 17 $\frac{1}{2}$	50	6 $\frac{3}{4}$	Price	0 90	5	80	2 $\frac{1}{2}$
Boston Rack, No. 2, 16 to 30 ems	8 $\frac{1}{2}$ x 17 $\frac{1}{2}$	130	6 $\frac{3}{4}$	Complete	1 20	11	1 80	6 $\frac{1}{2}$
Boston Rack, No. 3, 31 to 45 ems	8 $\frac{1}{2}$ x 17 $\frac{1}{2}$	210	6 $\frac{3}{4}$	set of four	1 50	15	3 00	10 $\frac{1}{2}$
Boston Rack, No. 4, 46 to 60 ems	8 $\frac{1}{2}$ x 17 $\frac{1}{2}$	300	6 $\frac{3}{4}$		\$5.40	1 80	4 25	15

For prices of Labor-Saving Metal Leads and Slugs, see page 1222. For price list of Labor-Saving Reglet, see page 1267.

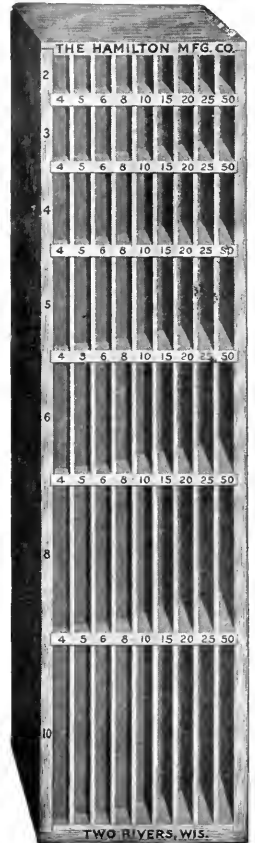

Metal Furniture Cabinet

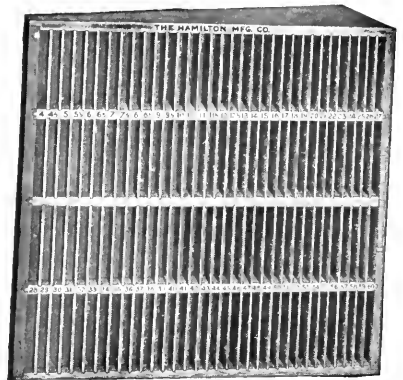

Four-Tier Wisconsin Lead Rack

Labor-Saving Reglet Cases

The use of Labor-Saving Reglet results in a great economy of time and material. A calculation based on the cost of Reglet in yard lengths will demonstrate that our Reglet Cases secure these savings to printers at *an absolute low price* for Reglet, and at moderate charges for the Case. The best and most accurate oil-coated Reglet is used and each Case contains equal proportions of nonpareil and pica. No Reglet is wasted when these Cases are used, as each piece is returned to its place in the Case after use. The Case can be refilled at a moderate cost.

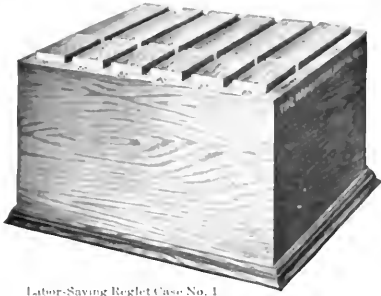

Labor-Saving Reglet Case No. 1

The Cases are made of selected hardwood and finished in antique oak, of fine appearance and substantial build. We put a line gauge on each Case and the different lengths are stamped on edges of all Cases over each compartment, so there will be no difficulty in replacing the Reglet in the several compartments after use.

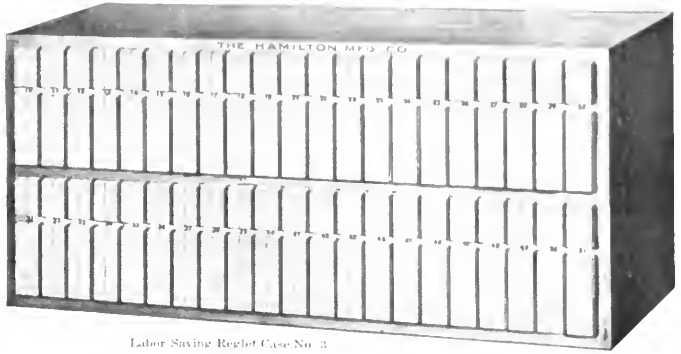

Labor-Saving Reglet Case No. 3

The several Labor-Saving Reglet Cases carried by us are made up according to the schemes given below and sold at the prices listed on this page.

Reglet Case No. 1 contains 1800 pieces (300 yards) of the best Reglet, half pica and half nonpareil, 300 pieces each of 10, 20, 30, 40, 50 and 60 ems long.

Refilling No. 1 Reglet Case, the same assortment as the above. List price, (reglet only) **\$6.00.**

Reglet Case No. 2 contains 2100 pieces (560 yards) half pica and half nonpareil, 300 pieces each of 10, 20, 30, 40, 50, 60, 72 and 120 ems long.

Refilling No. 2 Reglet Case, the same assortment as the above. List price (reglet only) **\$12.00.**

Reglet Case No. 3 contains 4200 pieces (600 yards) half pica and half nonpareil, in lengths from 10 to 51 ems, varying by one pica only, 100 pieces of each length. Height, 16½ inches; length, 35½ inches; depth, 9½ inches.

Refilling No. 3 Reglet Case, the same assortment as the above. List price (reglet only) **\$11.00.**

Reglet Case No. 4 contains 2100 pieces (300 yards) one-half the amount in No. 3; same lengths, from 10 to 51 ems, varying by picas, 50 pieces of each length. Height, 16½ inches; length, 20½ inches; depth, 9½ inches.

Refilling No. 4 Reglet Case, the same assortment as the above. List price (reglet only) **\$3.50.**

For prices and sizes of Reglet and Furniture in Yard Lengths see page 1230.

List Prices of All Reglet Cases

DESCRIPTION OF REGLET CASES	DIMENSIONS OF CASE, INCHES			Case and Reglet	Weight Pounds	Reglet Only	Weight Pounds
	Height	Length	Depth				
No. 1 contains 300 yards, cut into 1800 pieces, 10 to 60 picas	10½	16¾	15	\$10 00	62	\$ 6 00	30
No. 2 contains 560 yards, cut into 2100 pieces, 10 to 120 picas	20½	21¾	15	18 00	120	12 00	60
No. 3 contains 600 yards, cut into 4200 pieces, 10 to 51 picas	16½	35½	9½	18 00	110	11 00	60
No. 4 contains 300 yards, cut into 2100 pieces, 10 to 51 picas	16½	20¾	9½	11 00	62	5 50	30
No. 5 contains 1550 yards, cut into 6200 pieces, 10 to 150 picas	16½	53¼	26	15 00	275	30 00	150
No. 6 contains 775 yards, cut into 3100 pieces, 10 to 150 picas	16½	31	26	27 00	175	15 00	75

A line gauge, graduated by picas, with a stop at the end, is attached to every Case, for convenience in determining lengths while replacing Reglet.

Labor Saving Reglet

For the convenience of those who wish to replace the most used lengths in their Reglet Cases, and for those who require large amounts of certain lengths, we list below nonpareil and pica Reglet in hundred piece lots, cut to picas and tied in bundles.

Thoroughly kiln-dried stock is used in the manufacture of our Reglet and Wood Furniture, and it is made on machines especially designed for this purpose, consequently it has a well deserved reputation for accuracy and smoothness. It is all cut to point standard, and will be found entirely satisfactory in that respect. Thousands upon thousands of yards of reglet and furniture are used annually, yet a printing office rarely ever has enough pieces of the desired lengths. It now becomes an easy matter for our customers to keep their reglet cases sorted up in good shape at very small cost.

The American Type Founders Company is always in the lead with new ideas of practical value to the printer. A careful perusal of this catalogue will confirm our claims that we can supply "everything for the printer" on short notice.

List Prices of Nonpareil and Pica Reglet Cut in Labor-Saving Lengths and Tied in Bundles

PIECES AND WIDTHS	10	15	20	25	30	35	40	45	50	55	60	65
	Picas Long	Picas Long	Picas Long	Picas Long	Picas Long	Picas Long	Picas Long	Picas Long	Picas Long	Picas Long	Picas Long	Picas Long
100 pieces, nonpareil or pica	\$0 15	\$0 20	\$0 25	\$0 30	\$0 35	\$0 40	\$0 45	\$0 50	\$0 55	\$0 60	\$0 65	\$0 70
Weights for pica reglet. (Figure nonpareil one-half these weights)	8 ozs.	12 ozs.	1 lb.	1¼ lbs.	1½ lbs.	1¾ lbs.	2 lbs.	2¼ lbs.	2½ lbs.	2¾ lbs.	3 lbs.	3¼ lbs.
PIECES AND WIDTHS	70	75	80	85	90	95	100	105	110	115	120	125
	Picas Long	Picas Long	Picas Long	Picas Long	Picas Long	Picas Long	Picas Long	Picas Long	Picas Long	Picas Long	Picas Long	Picas Long
100 pieces, nonpareil or pica	\$0 75	\$0 80	\$0 85	\$0 90	\$0 95	\$1 00	\$1 05	\$1 10	\$1 15	\$1 20	\$1 25	\$1 30
Weights for pica reglet. (Figure nonpareil one-half these weights)	3½ lbs.	3¾ lbs.	4 lbs.	4¼ lbs.	4½ lbs.	4¾ lbs.	5 lbs.	5¼ lbs.	5½ lbs.	5¾ lbs.	6 lbs.	6¼ lbs.

Other lengths and widths of Labor-Saving Reglet can be furnished at proportionate prices, subject to our prevailing discounts.

Labor Saving Furniture Cases

Experience in building Printing Office Furniture has shown that the most convenient form of furniture case is one without doors and with partitions separating the various widths and lengths. In designing this new line of Furniture Cases this idea has

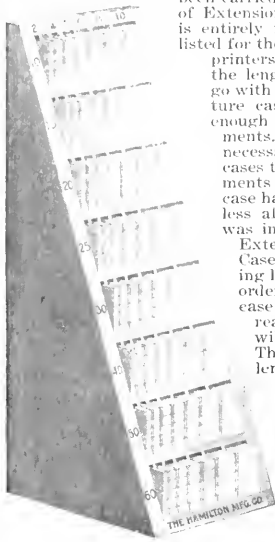

No. 10 Midget Furniture Case

been carried out. The feature of Extension Furniture Cases is entirely new and is here listed for the first time. Many printers have found that the lengths which usually go with an ordinary furniture case are not long enough for all requirements. Thus it has been necessary to make special cases to meet the requirements and often the old case has been found useless after the new case was installed. With the Extension Furniture Cases a printer requiring longer lengths can order the companion case to the one he already has and the two will work together. The case with shorter lengths can be set on top of the one with the longer lengths. The two cases combined make practically one complete furniture case.

All furniture which goes into these cases is cut from carefully selected stock, thoroughly seasoned and oil-soaked. With special machinery a furniture has been produced, which is smoothly finished, accurate and uniform.

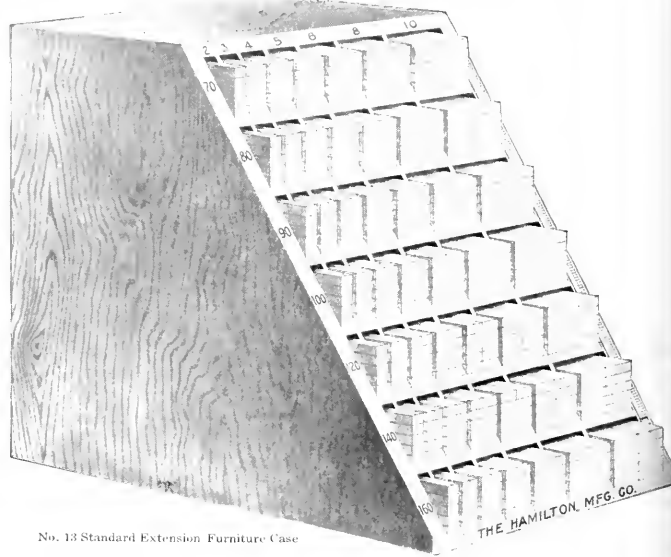

No. 13 Standard Extension Furniture Case

soned and oil-soaked. With special machinery a furniture has been produced, which is smoothly finished, accurate and uniform.

The No. 10 Midget Furniture Case is the smallest of all furniture cases. It is one-half the size of the No. 12 Standard Furniture Case, and contains one-half the amount of furniture of the same assortment.

It contains a total of forty-two yards of oil-soaked furniture, cut into two hundred and eighty pieces, five pieces of each length and width, in the following assortment of lengths and widths: Widths, five pieces each 2, 3, 4, 5, 6, 8 and 10 line picas; lengths 10, 15, 20, 25, 30, 40, 50 and 60 picas.

No. 12 Standard Furniture Case is the most commonly used furniture case. For many years has been the standard pattern used in ordinary country printing offices. It is twice the size and contains twice the amount of furniture in a No. 10 Midget

Furniture Case, is one-half the size and contains one-half the amount of furniture in a No. 14 Double Standard Furniture Case. Contains a total of eighty-four yards of oil-soaked furniture, cut into five hundred and sixty pieces,

there being ten pieces, of each length and width in the following assortment: Widths, 3, 4, 5, 6, 8 and 10 line picas; lengths, 10, 15, 20, 25, 30, 40, 50 and 60 picas.

No. 13 Standard Extension Furniture Case is a companion piece to the No. 12 Standard Furniture Case, but containing longer lengths. This case is twice the size and contains twice the amount of furniture in a No. 11 Midget Extension Furniture Case, and one-half the size and contains one-half the amount of furniture in a No. 15 Double Standard Extension Furniture Case. Contains a total of two hundred and fifty-two yards of oil-soaked furniture cut into four hundred and ninety pieces, ten pieces of each length and width, in the following assortment: Widths, 2, 3, 4, 5, 6, 8 and 10 line picas. Lengths, 70, 80, 90, 100, 120, 140 and 160 picas.

No. 17 Mammoth Furniture Case. This is a most popular and much used case, probably the best all-around furniture case ever designed. It contains a wide variety of lengths and widths, properly assorted for general use. It contains a total of four hundred and eighty yards of oil-soaked furniture, cut into fifteen hundred and thirty pieces in the following assortment: Eighteen pieces each of two, three and four line wide in the following lengths: 10, 15, 20, 25, 30, 40, 50, 60, 70, 80, 90, 100, 120, 140 and 160 picas.

Fifteen pieces each of five and six line wide, in the following lengths: 10, 15, 20, 25, 30, 40, 50, 60, 70, 80, 90, 100, 120, 140 and 160 picas. Nine pieces each of eight and ten line wide, in the following lengths: 10, 15, 20, 25, 30, 40, 50, 60, 70, 80, 90, 100, 120, 140 and 160 picas.

Sengbusch Beveled Furniture

The difficulty in locking up forms which contain long vertical rules, and obtaining an even distribution of ink, as well as preventing the cutting of rollers, are obviated by the use of the Sengbusch Beveled Furniture. It is a time economizer in locking up a form on a slant and still maintain a square lock-up in the chase. In locking-up with this furniture, the form is inclined towards the left lower corner of the platen. This assists the feeding of the sheet. The Sengbusch Furniture throws the rules out of perpendicular; the point of contact is spread longitudinally, thus preventing cutting of the rollers and providing a better inking surface.

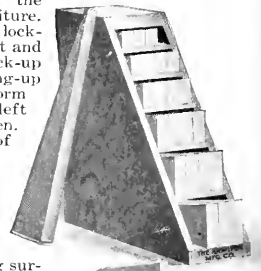

Sengbusch Beveled Furniture

Each font of Sengbusch Furniture consists of twenty-four pieces, four pieces each of the following lengths: 20, 25, 30, 40, 50 and 60 picas. All pieces are two picas wide on the narrow end and of varying widths on the wide end of each.

List Price of Sengbusch Beveled Furniture
Per font of 24 pieces, including cabinet \$2 00

List Prices and Dimensions of all Furniture Cases

NAME	Pica Lengths	No. of Pieces	Height Inches	Width Inches	Depth at Base Inches	Case and Furniture	Weight Crated	Furniture Only	Weight Boxed
No. 10 Midget	10 to 60	250	31	10	10 ¹ / ₂	\$ 6 00	50	\$ 2 75	25
No. 11 Midget Extension	70 to 160	245	28	10	27 ¹ / ₂	17 00	130	8 25	70
No. 12 Standard	10 to 60	560	31	16 ¹ / ₂	10 ¹ / ₂	10 00	80	5 00	50
No. 13 Standard Extension	70 to 160	490	28	16 ¹ / ₂	27 ¹ / ₂	23 00	190	15 50	140
No. 14 Double Standard	10 to 60	1176	41 ³ / ₄	22 ¹ / ₂	10 ¹ / ₂	20 00	175	11 50	100
No. 15 Double Standard Extension	70 to 160	1029	34 ¹ / ₂	22 ¹ / ₂	27 ¹ / ₂	45 75	375	33 75	275
No. 16 Baby Mammoth	10 to 160	765	41	18 ¹ / ₄	27 ¹ / ₂	29 00	240	15 00	136
No. 17 Mammoth	10 to 160	1530	41	31 ¹ / ₄	27 ¹ / ₂	40 00	400	25 00	230

We shall be pleased to give you information regarding Labor Saving Furniture Cabinets not shown here

Pyramid Lead and Slug Bank

The most practical Lead and Slug Bank ever devised. It has a double faced sloping top divided into sections, each section adjustable, so as to accommodate any desired lengths. There is also provided a series of drawers, between the sloping banks, for the storage of surplus stock of leads and slugs. The working bank can be replenished from this stock as the occasion requires. The Sort Drawer Base serves to raise the Lead and Slug Bank to a convenient working height. The Bank and Base are most substantially constructed of hardwood throughout, so as to carry safely the immense load of metal approximately 8,000 pounds, which it is designed to hold.



No. 1 Pyramid Lead and Slug Bank

No. 1, Sort Drawer Base \$56 00 No. 2, Lead and Slug Bank \$61 00 No. 2, Sort Drawer Base 36 00

NOTE.—The No. 2 is just half the size of the No. 1, illustrated and described above. Double-faced with six sections in Lead and Slug Bank on each side, and with five drawers on the end running through and pulling from either end. Also with Sort Drawer Base containing twelve drawers in three tiers, pulling from either side. Capacity, one-half the amounts given for the No. 1.

All space inside and out-side is utilized to the very best advantage. The space-saving qualities of this piece of furniture will be appreciated when it is considered that the floor space occupied is only a little more than twelve square feet.

LEAD AND SLAG BANK. In the No. 1 Bank there are twelve sections on each side, providing a total of seventy-five square feet of lead and slug surface, when the metal is stacked double depth, each section supplied with a number of adjustable partitions which can be so placed as to accommodate any length of leads and slugs. In the ends, between the sloping banks, is a series of ten storage drawers, five in each end, all 27 inches long, 4 1/2 inches deep, inside measure, and of varying widths, 37, 61 1/2, 9, 11 1/2 and 11 1/2 inches respectively. Thirty-five hundred pounds of leads and slugs can be stored in these ten drawers.

Sort Drawer Base. This Base contains a total of twenty-four sort drawers, each divided into ten compartments; size of each compartment 1 1/2 x 2 1/2 inches inside. These drawers run through the bank and can be pulled from either side.

Dimensions, Weights and Capacity

Height, without base, 18 inches; base, 18 inches; total height, bank and base, 66 inches. Occupies floor space, 25 1/2 x 72 inches. Depth of Lead and Slug Bank, 1 1/2 inches, inside. Capacity, leads and slugs, on bank, 3,000 pounds. Capacity, leads and slugs, in drawers, 3,500 pounds. Capacity, Sort Drawer Base, 1,500 pounds. Weight of No. 1 Lead and Slug Bank, crated, 100 pounds. Weight of Sort Drawer Base for No. 1, crated, 300 pounds.

List Prices of Pyramid Lead and Slug Banks

No. 1, Lead and Slug Bank \$100 00

Furneaux Storage Cabinet for Leads, Slugs and Metal Furniture

There has always existed a lack of storage room for leads and slugs, metal furniture, etc. Likewise the line of modernized Printing-office Furniture has lacked a convenient Lead and Slug Bank of large capacity. Both of these wants are supplied in the Furneaux Lead and Slug Bank and Storage Cabinet.

This equipment has given such great satisfaction and has proven its economical value so thoroughly, that we offer this Cabinet as a standard article to our customers. It has an enormous storage capacity and is most substantially constructed to support the great load of metal which it will accommodate.

Dimensions of the Furneaux Storage Cabinets

Occupies floor space, 36x26 inches; height at the front, 15 inches; height at back, 70 inches. The lower Lead and Slug Bank is two inches deep inside and divided into two sections, each section measuring 11 1/4 inches from front to back. The upper Lead and Slug Bank is 3 1/4 inches deep inside, and measures 13 1/2 inches from front to back. These Lead and Slug Banks are adjustable by pieces, and the divisions can be arranged to accommodate any desired lengths. The body of the Cabinet is fitted with twelve storage drawers, all eighteen inches long from front to back, and thirteen inches wide, inside measure. The two upper drawers are eight inches deep inside and the ten lower drawers are five inches deep inside. All these drawers have removable partitions, adjustable by inches, running from front to back. Cabinet is fitted with heavy flat steel runs, capable of sustaining any load which can be stored in the drawers. Weight of Cabinet, crated for shipment, 500 pounds.

List price \$85 00

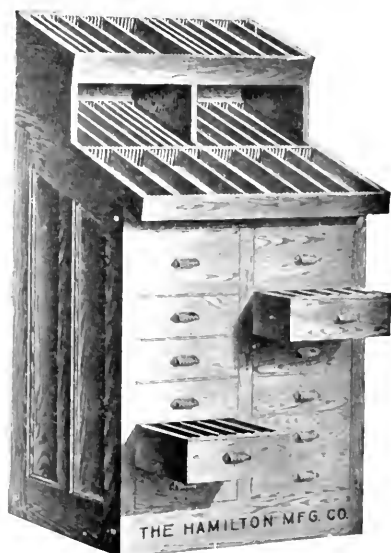

Furneaux Storage Cabinet.

Make-up Tables with Iron or Brass Imposing Surfaces

Make-up Tables are valuable in newspaper offices, where speed in getting ready is essential. They are fast coming into general use. They provide a place for every form without interfering with other imposing surfaces. The table and form can be quickly transferred to the stereotyping room. The iron tops are heavy and ribbed on the underside, which adds additional strength. The surfaces of the iron tops are smoothly and accurately finished. When brass covered, extra heavy, hard-rolled sheet brass is used, ten-rauge in thickness. The supporting posts of the frames fit into pockets cast into the iron top. This feature braces the frame and keeps the top always in correct position. Mounted on two-wheeled revolving castors of the most improved pattern. The drawer under the iron surface for column rules is subdivided into various compartments to keep the rule face up. The shelving underneath this drawer is useful for storage of galleys, furniture, sidesticks, tools, etc.



Make-up Table with Tray Attached

The Rule Tray on Top

The supplementary tray is attached to the table by means of a pair of supporting brackets. These brackets are detachable and the tray and brackets can be removed when the Make-up Table is transferred to the stereotyping room. This tray is full brass lined, the bottom being covered with heavy hard-rolled sheet brass. The surrounding rim and the heavy division bars are of square brass tubing. The various narrow divisions are also of brass tubing with rounded tops, like the slats in printers' type cases.

List Prices and Dimensions of Make-up Tables with Imposing Surfaces

Size of Iron Top	Size of Form Accommodated	Weight Complete Crated, Pounds	Tray and Brackets for Top	Frame with Iron Top	Frame with Brass Covered Iron Top
No. 1 20 1/2 x 26 1/2	6 column	295	\$13 00	\$35 00	\$51 50
No. 2 23 x 28 1/2	7 column	345	11 00	40 00	60 00
No. 3 25 1/2 x 30 1/2	8 column	390	15 00	45 00	69 00
No. 4 27 1/2 x 32 1/2	9 column	440	16 00	50 00	79 00
No. 5 27 1/2 x 36	10 column	480	18 00	55 00	87 00

These prices are subject to prevailing discounts

Bookbinders' Materials and Supplies

During the past few years many improvements and additions have been made in the tools and machinery used by Bookbinders. Recognizing this fact the American Type Founders Company is now in a position to supply its many customers promptly with the very best of everything in this special line. Many of the machines and devices represented in the following pages are of exceptional merit and afford to any printer contemplating the addition of bookbinding to his equipment, a splendid line from which to make a choice selection. Should there be any device not specifically mentioned in this list, it will afford us pleasure to supply the fullest details and prices of same with the utmost despatch upon request. Our aim is to supply everything for the Bookbinder.

Stuart Finishing Stand

The Stuart Finishing Stand is far superior to the devices ordinarily used. It is made of oak and is very substantial. The clamp is faced with felt, and the part which presses against the book swings on a pivot so that it always strikes the cover of the book squarely, no matter what the thickness of the book may be. The clamp is closed by foot power with a treadle attached to a heavy coiled spring, and when closed is held in a fixed position by an iron ratchet. The connection between the treadle and the clamp is a heavy steel coiled wire which will stand any strain to which it can be subjected.



Stuart Finishing Stand

The piece which supports the book, is adjusted with a lever and ratchet and this supporting shelf can be lowered fourteen inches below the top of the clamp, or it can be raised to the lower edge of the clamp; any size book can therefore be placed conveniently in the clamp and no time is lost in making the adjustment.

The clamp can be easily adjusted to a table by two pins which drop into holes in the top of the table. When the table only is used, the clamp can be taken off and put away until required. The device is sold with or without the table, as desired.

List Price and Weight of Stuart Finishing Stand

Weight of clamp, 85 pounds, crated;
weight of table, 75 pounds, crated;
List Price \$12 00
Price of hardwood table with drawer 10 00

Roll Cloth Cutting Machine

The Roll Cloth Cutting Machine is a new apparatus for handling binders' cloth and cutting same to size with great convenience and without waste.

It will take six rolls of cloth in any length up to forty-two inches. The rolls of cloth are held on iron rods which are fitted in the uprights on the frame and are removable. The cloth from all of the rolls passes down to the bottom of the frame and under a pressure roll. It then passes along over the bed of the machine as shown in the illustration.

There is a cutting groove across the bed, which is lined with steel on both sides. The knife used in cutting, slips in this slot between the pieces of steel and the cloth can be quickly and smoothly cut. There is a measuring gauge marked off in inches to enable the operator to gauge the sizes of cloth which he is cutting.

Directly in front of the cutting slot there is a heavy pressure roll of iron which holds the cloth down close to the bed of the machine. All parts of wood are hardwood, nicely fitted and varnished. The machine as a whole is well and substantially made.



Roll Cloth Cutting Machine

List Price and Dimensions Roll Cloth Cutting Machine and Table

44 $\frac{3}{4}$ inches wide; 41 $\frac{3}{4}$ inches long; thickness of bed, 2 $\frac{1}{4}$ inches; height of uprights, 18 $\frac{1}{2}$ inches; weight, crated for shipment, 160 pounds; weight of Table, crated ready for shipment, 75 pounds; length of bed from cutting groove to the gauges, 22 inches; size of Table, 40x43 inches. List Price, without Table \$25 00
List Price of Table 10 00

Gilding Presses

The Gilding Press is here shown combined with the Stand. We can supply it with or without the Stand or the Stand alone, as desired. All materials entering into these Gilding Presses is the best procurable. They are made of hardwood throughout except

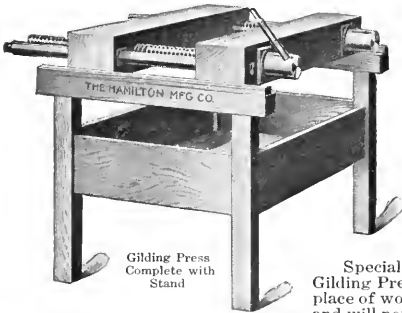

Gilding Press Complete with Stand

the screws, which are of iron. The boxes are of iron or gun metal as desired. The screws work easily and accurately. Lever bar accompanies each Press. The distance between screws is twenty-eight inches. The jaws can be spread eighteen inches. Special Presses

List Prices and Dimensions of Gilding Presses

No.	Length of Iron Screws Inches	Size of Screw Inches	Size of Wood Inches	Style of Box	Weight Pounds	Prices
1	35	1 $\frac{3}{4}$	5 $\frac{1}{2}$ x5 $\frac{1}{2}$	Iron Boxes	150	\$36 00
2	35	1 $\frac{3}{4}$	5 $\frac{1}{2}$ x5 $\frac{1}{2}$	Gun Metal Boxes	150	40 00
3	36	2	6 $\frac{3}{4}$ x5 $\frac{3}{4}$	Iron Boxes	200	44 00
4	36	2	6 $\frac{3}{4}$ x5 $\frac{3}{4}$	Gun Metal Boxes	200	46 00

Prices of hardwood Stand, to fit any size, as shown in illustration, \$11.00. Weight 100 pounds

with additional spread of jaw can be furnished at an advance of 50 cents per inch for the additional spread. All woodwork is nicely filled and varnished. Special attention is directed to an important improvement made in the construction of these Gilding Presses. The slide pins running parallel to the jaw screws are now made of steel in place of wood, as formerly. This imparts additional rigidity. The steel guide pins cannot bend and will not wear. These Gilding Presses are now all metal except the two jaw bars.

Plow and Press

This illustration shows the Plow and Press complete with lever bar, which accompanies each Press. All materials are the best procurable. The diameter of the wood screw is two and seven-sixteenth inches. The distance between screws is twenty-six and one-half inches. The jaws have a spread of twelve inches. The knife is of the best tool steel. All Plows are equipped with the English pattern knife. This knife is short and stocky and cannot spring. It is a great improvement over the old style knife.

List Prices of Plow and Press

Complete Plow, Press, Knife and Pin, \$12 75 Press alone \$9 00
Plow alone 4 00 Press Pin alone 75
Knife alone 75

Weight, complete, 130 pounds.

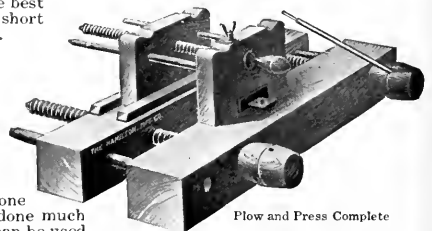

Plow and Press Complete

Bookbinders' Band and Rubbing-Up Sticks

Made of smoothly finished rock maple and put up in a set of six sizes—one each $\frac{3}{32}$, $\frac{1}{8}$, $\frac{5}{32}$, $\frac{3}{16}$, $\frac{1}{2}$, $\frac{5}{8}$ -inch widths of groove. By their use the work is done much quicker and bands of uniform width and finish are formed. The two larger sizes can be used for forming the larger bands on the backs of blank books, turning sharp corners, etc., thus taking the place of the folder, rubbing-up stick, burnisher, etc., heretofore used for this purpose. Weight, per set, $\frac{3}{4}$ pound. Price, per set of six, in neat paper box, \$1.00.

Blank Book Sewing Bench

This Blank Book Sewing Bench is a decided improvement over the usual construction of such articles. The screw clamps are of brass and work smoothly in the follower grooves. The screws are large with deep slotted heads. The uprights on these Benches are screwed into the bottom board. All screws are interchangeable with those in the regular Sewing Benches and are absolutely uniform in size.

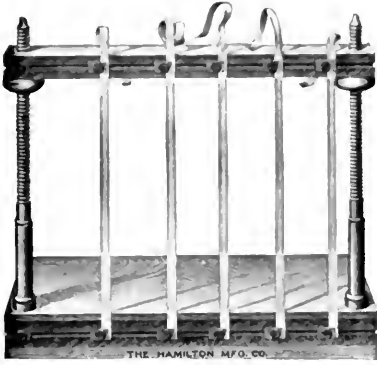

Blank Book Sewing Bench

List Price and Dimensions Blank Book Sewing Bench
Weight, crated for shipment, 35 pounds

\$7 00

Bookbinders' Sewing Benches

These Sewing Benches and Finishing Presses are made in a strictly first-class way, of good material and thorough workmanship. The uprights are screwed to base and are detachable. The Screws are accurately cut from dies and are uniform and interchangeable. A broken or worn-out Screw can be replaced with the certain knowledge that it will fit.

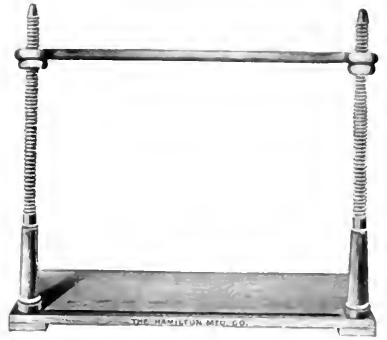

Bookbinders' Sewing Bench

List Prices and Dimensions of Bookbinders' Sewing Benches

No. 1, Bookbinders' Sewing Bench—24 inches between screws, weight, 9 lbs.	\$1 50
No. 2, Bookbinders' Sewing Bench—30 inches between screws, weight, 10 lbs.	2 00
No. 3, Bookbinders' Sewing Bench—36 inches between screws, weight, 11 lbs.	2 50

Finishing Presses

List Prices and Dimensions of Finishing Presses

No. 1, Finishing Press—14 inches between screws, weight, 12 pounds	\$2 25
No. 2, Finishing Press—18 inches between screws, weight, 15 pounds	2 50
No. 3, Finishing Press—21 inches between screws, weight, 17 pounds	2 75
No. 4, Finishing Press—21 inches between screws, weight, 19 pounds	3 00
No. 5, Finishing Press—28 inches between screws, weight, 22 pounds	3 25
No. 6, Finishing Press—31 inches between screws, weight, 24 pounds	3 50

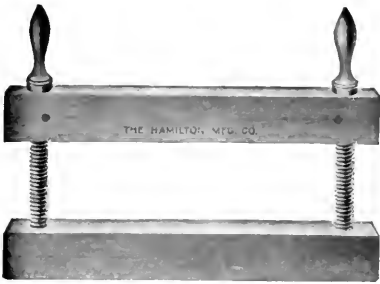

Finishing Press

Bookbinders' Press Boards

This line of Bookbinders' Press Boards has been greatly developed, and is guaranteed, whether plain, laminated or brass bound, to be the best ever manufactured.

They are made of selected cherry, or of five-ply laminated stock as shown in the two illustrations below. The Laminated Brass



18 Brass Bound Press Boards in Cases

Bound Boards are meeting with great favor, and are now used by the best and largest binders. All stock going into these boards is the very best procurable. Any little defect in the wood is firmly plugged and smoothed.

List Prices and Dimensions of Cases for Press Boards

The Cases for holding Press Boards are of three sizes, each size in 14, 16 and 18 board capacity. Other sizes made to order. These cases are made of hardwood, nicely finished, and the sides are paneled. The boards are separated by fixed hardwood strips. The prices of Cases given below do not include the Boards. Prices for the boards appear in the table below.

Case to hold 14 Boards 16x24 inches	\$ 9 50
Case to hold 16 Boards 16x24 inches	10 50
Case to hold 18 Boards 16x24 inches	11 50

Approximate weight of empty Case, 100 pounds.

Case to hold 14 Boards 18x24 inches	\$10 00
Case to hold 16 Boards 18x24 inches	11 00
Case to hold 18 Boards 18x24 inches	12 00

Approximate weight of empty Case, 120 pounds.

Case to hold 14 Boards 20x28 inches	\$11 00
Case to hold 16 Boards 20x28 inches	12 00
Case to hold 18 Boards 20x28 inches	13 00

Approximate weight of empty Case, 140 pounds

List Prices and Dimensions of Brass Bound and Unbound Press Boards

Size of Board Inches	Approximate Weight per Board Pounds	Unbound		Zinc, Brass or Aluminum Bound		Nickel Plated Brass Bound	
		Laminated	Cherry	Laminated	Cherry	Laminated	Cherry
6x10 ¹ / ₂	1 ¹ / ₂	\$0 25	\$0 20	\$0 90	\$0 85	\$1 30	\$1 25
8x10 ¹ / ₂	2	30	25	1 00	95	1 45	1 40
8x12	2 ¹ / ₄	35	30	1 15	1 10	1 65	1 60
10x13	3	45	35	1 35	1 25	1 95	1 85
11x14	3 ³ / ₄	55	45	1 55	1 45	2 15	2 05
10x16	4	60	50	1 65	1 55	2 30	2 20
12x16	4 ¹ / ₂	65	55	1 80	1 70	2 50	2 40
12x18	5	75	60	1 95	1 80	2 70	2 55
15x20	6 ³ / ₄	90	70	2 20	2 00	3 00	2 80
15x20	7 ¹ / ₄	1 05	85	2 45	2 25	3 30	3 10
17x22	9	1 30	1 05	2 85	2 60	3 75	3 50
16x24	9 ¹ / ₄	1 35	1 10	2 95	2 70	3 95	3 70
18x24	10 ¹ / ₂	1 50	1 20	3 20	2 90	4 25	3 95
20x24	11 ¹ / ₂	1 65	1 35	3 40	3 10	4 50	4 20
20x28	13 ¹ / ₂	1 95	1 55	3 85	3 45	5 05	4 65
22x28	14 ³ / ₄	2 10	1 70	4 10	3 70	5 35	4 95
24x30	17 ¹ / ₄	2 50	2 00	4 65	4 15	6 00	5 50
24x32	18 ¹ / ₂	2 65	2 15	4 90	4 40	6 30	5 80
26x40	25	3 60	2 90				
30x36	26	3 75	3 00				
36x44	38	5 50	4 40				

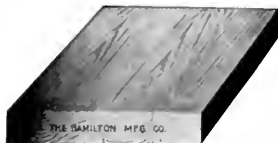

Cherry Press Boards



Laminated Press Boards

Prices quoted on this page are subject to prevailing discounts

Cutting Gauge for Binders' Cloth

No satisfactory device for cutting Binders' Cloth has heretofore been on the market. Printers and binders have resorted to home-made affairs or used an ordinary straight edge. This Cutting Gauge will be found very useful. It is well made, of hardwood and cannot get out of order or become broken with ordinary usage. It has a raised handle bar twenty-four inches long. The cutting edge is faced with angle brass, fastened with screws from the under side. The arms are gauged by half-inches up to twenty-four inches. The length of the cutting edge is forty-two inches. The arms are detachable and fastened with screws. Weight, 4 pounds.

List Price of Cutting Gauge for Binders' Cloth \$4 00

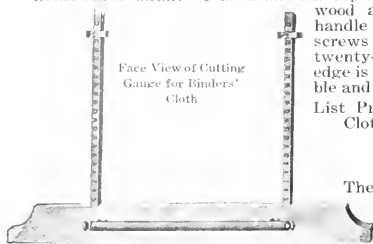

Face View of Cutting Gauge for Binders' Cloth

Finishing Stand

These Finishing Stands, Gold Cushions and Tables are strictly first-class and guaranteed to give perfect satisfaction. All materials are of the best procurable and every piece is carefully inspected before sent out. The Finishing Stand can be attached to the Table, as shown. Made of hardwood, with cleated ends.

List Prices and Dimensions of Finishing Stands
 Small size, 12x20 inches, with cleated ends; weight, crated, 19 pounds \$3 00
 Large size, 16x24 inches, with cleated ends; weight, crated, 25 pounds 5 00

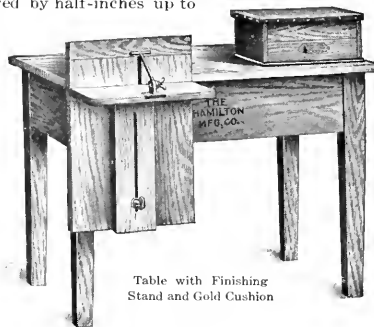

Table with Finishing Stand and Gold Cushion

Gold Cushions

Covered with the best law calf, securely fastened on edges with tacks, and reinforced with binding strips fastened with round headed brass upholsterers' tacks. Made of hardwood, with drawer in base.

List Prices and Dimensions of Gold Cushions

No. 1, size 7x13 inches; weight boxed, 8½ pounds \$3 00
 No. 2, size 8x16 inches; weight boxed, 12 pounds 4 00
 No. 3, size 9x18 inches; weight boxed, 15 pounds \$5 00

Table

Substantially made of hardwood, with heavy top and finished. Height, 32¼ inches; length, 42¼ inches; width, 24¾ inches. Weight, 100 pounds. List Price \$4 50

Straight Edges for Cutting Stock

Accurately made of straight-grained rock maple. Each Straight Edge has a large hole in one end for convenience in hanging up.



Straight Edge of Rock Maple

List Prices and Dimensions of Straight Edges for Cutting Stock

14 inches long, 1½ inches wide, ¼ inch thick, each \$0 08
 18 inches long, 2 inches wide, ¼ inch thick, each 10
 24 inches long, 2½ inches wide, ¼ inch thick, each 20
 36 inches long, 3 inches wide, ½ inch thick, each \$0 45
 48 inches long, 4 inches wide, ¾ inch thick, each 60
Other sizes at proportionate prices

Bookbinders' Cabinets

Made with bronzed pulls on each case, and highly finished. The cases are made in exactly the same style as printers' cases, with three-ply bottoms, are the same size and proportioned like one-half of the regular cap case. These Cabinets may be put on or under a bench. "A place for everything and everything in its place" is a rule bookbinders should live up to, and these Cabinets will enable them to do so.

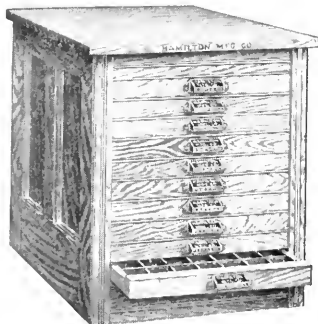

No. 2 Bookbinders' Cabinet

List Prices of Bookbinders' Cabinets

No.	CAPACITY	Weight Pounds	Height Inches	Floor Space Inches	Price
1	6 Cases	75	16	20x20	\$ 8 00
2	10 Cases	110	24½	20x20	12 00
3	15 Cases	150	33¾	20x20	16 50
4	18 Cases	190	39	20x20	19 00
5	20 Cases	210	43	20x20	21 00
6	25 Cases	250	61¾	20x20	25 00

Other sizes can be furnished at proportionate prices.

Paper and Card Stock Cabinets

This is a proper receptacle for high-priced papers and fancy cardboard stock. Such material quickly becomes soiled and unfit for high-grade work if exposed to the air and dirt. These Cabinets are practically dust proof and the colors will not fade or the quality of the paper deteriorate when stock is stored in them.

They are very strongly constructed to stand great weight and can be used for a variety of purposes. The bottoms are of heavy three-ply material, five-sixteenths of an inch thick, with the grain of the wood crossed. Such bottoms cannot shrink, swell or crack. All drawers are made with removable divisions so that each can be sub-divided for small sizes of cut stock when found desirable. Cabinets are made of hardwood throughout and nicely finished. The ends are paneled and bronze pulls are attached to the drawer fronts.

The prices quoted are subject to prevailing discounts. We make a great many Paper and Card Stock Cabinets to special measurements. If you require something out of the ordinary write us.

List Prices and Dimensions of Paper and Card Stock Cabinets

No. 1 contains 12 drawers; eight of these drawers are 2 inches deep inside; the other four are 4½ inches deep inside. Each drawer will take 22½x28 inch stock and smaller sizes. Occupies floor space 28½x34¾ inches. Height, 48 inches. Weight, crated, 340 pounds. List price \$37 00
 No. 2 contains 12 drawers; eight of these drawers are 2 inches deep inside; the other four are 4½ inches deep inside. Each drawer will take 28x44 inch stock and smaller sizes. Occupies floor space 34½x49½ inches. Height, 48 inches. Weight, crated, 400 pounds. List price 48 00



No. 1 Paper and Card Stock Cabinet
 Takes full sheet of Cardboard (22½x28 inches). Occupies space of 34½x28½x48 inches

About the New Departure Type Cases

In order that customers may have little trouble in making their selections of type cases, the American Type Founders Company presents, in the following pages, many absolutely correct illustrations and much invaluable general information with regard to its extensive line of New Departure Type Cases. The list is very complete and we believe there is scarcely a type case, used to any extent, that is not represented in these pages. That there should be uniformity in the layout of all type cases is beyond any question of doubt and the large number of illustrations detailing many layouts should prove of the greatest assistance to printers.

As we carry at all times an extensive stock of the New Departure Cases, all orders will receive careful and very prompt attention. The prices quoted are subject to prevailing discounts.

While most printers are familiar with our line of Cases, the following descriptions and list prices may prove of service for general reference:

The leading feature of the New Departure Cases is the one piece bottom the full width of the case, without joints or splices. This is made of three layers of wood, the grain of the middle layer running in an opposite direction from the grain of the outer layers. This makes cracking impossible. The cases slide smoothly on side rails and not on the bottoms, with the screws forever catching. This feature lengthens the life of the cases. The bottom cannot be torn off, because it is rabbeted into the side rails and front. Made of thoroughly seasoned wood.

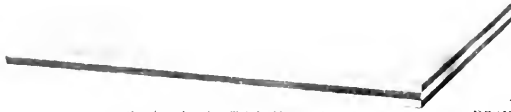

Section showing Triple-Venier Bottom

Another important feature in type case construction which improves and prolongs the life of each case is the fact that all of the New Departure Cases

have three-ply bottoms covered with the best quality of manila paper. The paper absorbs the moisture from the type and prevents it entering the wood, dissolving the glue and destroying the case bottom.

Brass Clasp Cases

To add strength and make the cases practically indestructible at a very slight additional cost brass joint clasps are added. A long pin driven through and clinched holds the partition firmly to the bottom.

The paper covering of the New Departure Cases is a final process and is used because it improves and prolongs the life of the case. Twenty-five years' experience in manufacturing type cases has demonstrated that it is required. Since its introduction the New Departure style of type case has become practically the only construction known to printers, not only in the United States, but the whole of North America and every foreign country, where the art of printing has made material progress. It is safe to say that there is not a first-class printing office in the world, which is not equipped, in part at least, with New Departure Cases.

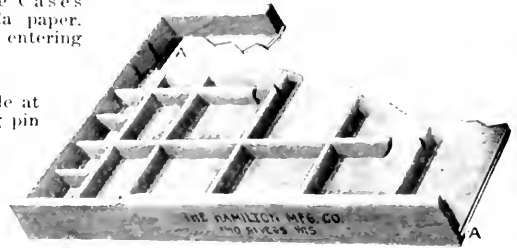

Sectional view of the New Departure Case, showing three-ply bottom and grooves in side rails and front (A-A)

List Prices of New Departure Cases. Illustrated on following pages

	FULL SIZE CASES		THREE-QUARTER CASES		TWO-THIRD CASES	
	Ordinary	Clasp	Ordinary	Clasp	Ordinary	Clasp
Adjustable Lead and Slug Case No. 1, single depth	\$1 50		\$1 25		\$1 00	
Adjustable Lead and Slug Case No. 1, double depth	2 50		2 25		2 00	
Adjustable Lead and Slug Case No. 2, single depth	1 75		1 50		1 25	
Adjustable Lead and Slug Case No. 2, double depth	2 75		2 50		2 25	
Blank Case						
Border Case	65		60		45	
Brass Leader Case	1 25	\$1 50	1 15	\$1 40	1 00	\$1 30
California Job Case	90				75	
Combination Job Case	1 20	1 35	85	95		
Dearing Accent Case	1 50	1 80				
Dearing Job Case	1 00	1 15	85	1 00	75	85
Double Lower Job Case	1 20	1 40				
Double Yankee Job Case	1 20	1 40				
Duplex Job Case	1 10	1 25	1 00	1 15	90	1 05
Figure Case	1 00	1 10	90	1 00	80	90
Figure Case Byerly	1 10	1 20				
Furneaux Rule Case	1 10	1 50	1 15	1 40	1 05	1 30
German News Cases, per pair	1 60	1 75				
Greek Cases (upper and lower), per pair	2 00	2 30				
Half Cap Case			60			
Hamilton Job Case	90	1 00	85	95	75	85
Hebrew Cases, per pair	1 60	1 75				
Improved New York Job Case	1 00	1 15				
Improved Space and Quad Case	1 00	1 10	90	1 00	80	90
Improved Job Case	1 20	1 40	1 10	1 25		
Indexed Electrotype Case, including partitions	1 10					
Italic Job Case	90	1 00	85	95	75	85
Jones Metal Furniture Case			7 00			
Lead and Slug Case	1 00		90		75	
Metal Furniture Case, single depth	1 50		1 40		1 30	
Metal Furniture Case, double depth	2 00		1 70		1 60	
Music Cases (upper, lower and side), per set	3 00	3 45				
Neshota Rule Case	2 00					
News Cases, per pair	1 60	1 75	1 50	1 65	1 40	1 55
Paterson Job Case	1 00	1 15				
Practical Space and Quad Case	1 10	1 20	1 00	1 10	90	1 00
Quadruple Job Case	1 20	1 35				
Rule Case	1 15	1 25	1 00	1 15	90	1 00
Russell Tabular Job Case	1 80	2 00				
Spaceless Job Case	1 00	1 15	90	1 00	80	90
Thirty-inch Space and Quad Case			75			
Triple Cases	90	1 00	85	95		
Two Rivers Cap Case	90	1 00	85	95	75	85
Two Rivers Lead and Slug Case	1 75					
Wells Job Case	1 00	1 15	85	1 00	80	90
Wheeler Job Case	90	1 00	85	95		
Wood Type Case	90				75	
Yankee Job Case	1 00	1 15	85	1 00	75	85
Zenobia Rule Case	1 50					

Dimensions over all, in inches .
Weight of a bundle of 10 cases .

32 $\frac{1}{2}$ x16 $\frac{5}{8}$ inches
75 pounds

26 $\frac{1}{2}$ x16 $\frac{5}{8}$ inches
60 pounds

21 $\frac{1}{2}$ x16 $\frac{5}{8}$ inches
50 pounds

These prices are subject to our usual discounts.

Prices, Illustrations and Layouts of Popular Type Cases

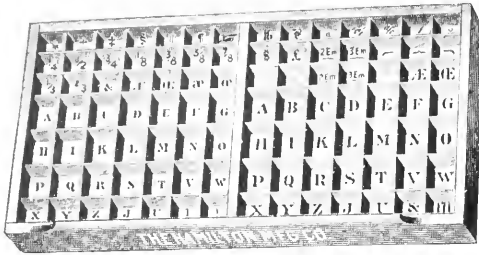

News Cap Case, \$0 80

A new Cap Case that meets all requirements and one that is exceptionally popular with all compositors.

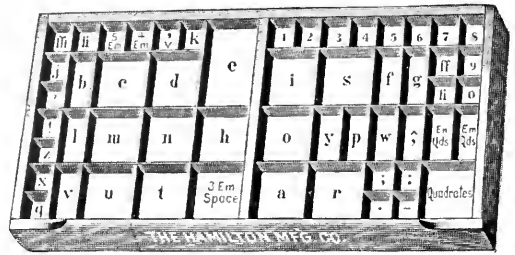

News Lower Case, \$0 80

The universal layout as put into the regular Lower Case from which every printer has learned his a-b-c's.

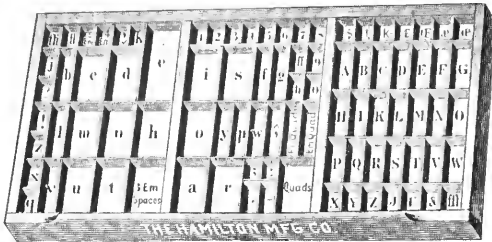

California Job Case, \$0 90

Most popular of all Job Cases. Note the large cap boxes. Used exclusively in all our type cabinets unless otherwise ordered.



Italic Job Case, \$0 90

Old standard Job Case, universally used before the introduction of the California Job Case. Convenient for fonts with accented letters.

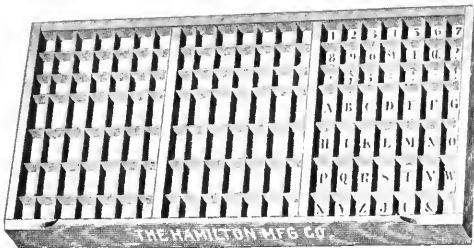

Triple Case, \$0 90

A most useful and popular Case. Will take three fonts of caps, figures and points.

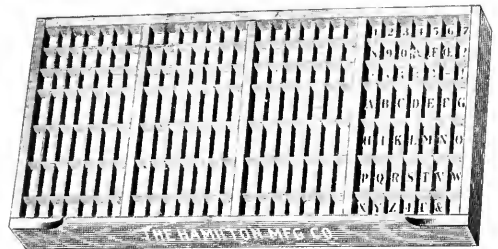

Quadruple Case, \$1 20

Very useful for certain fonts. It is a double Cap Case. Holds four fonts caps, figures and points.



Improved Job Case, \$1 20

The only Case combining all the boxes found in a regular pair of News Cases. Takes caps, small caps and lower case with figures.

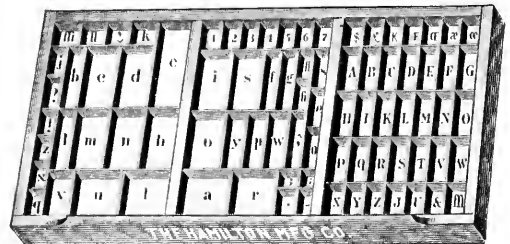

Spaceless Job Case, \$1 00

The Spaceless Job Case should be a twin companion to the Space and Quad Case. All space and quad boxes omitted.

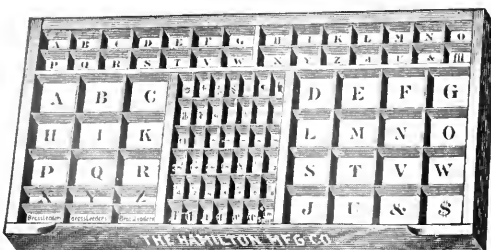

Two Rivers Cap Case, \$0 90

A sensible Cap Case now coming into general use. Large cap boxes, 2 3/4 x 3 inches. Copy covers least used characters. Economical.

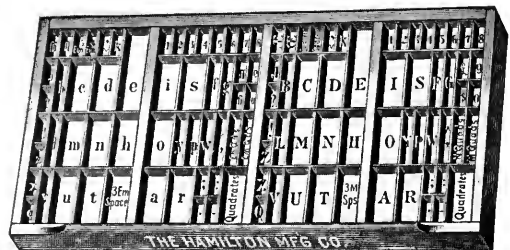

Double Lower Case, \$1 20

For holding two fonts of caps and figures; or caps, lower case and double font of figures; or a font each of Roman and bold face.

Prices, Illustrations and Layouts of Popular Type Cases



Yankee Job Case, \$1 00

The cap boxes in this Case are placed at the back instead of the right side. A popular case in two-thirds and three-quarter sizes.



Double Yankee Job Case, \$1 20

A very useful Case. Accommodates two complete fonts of caps, lower case, figures and points. Size of boxes allows ample finger room.



Improved New York Job Case, \$1 00

Holds cap, small cap, lower case and figure fonts. Cap side California style with five rows of boxes.



Paterson Job Case, \$1 00

Like the New York Case, this is designed to hold cap, small cap, lower case and figure fonts.



Wells Job Case, \$1 00

Holds two fonts of caps and figures. Large boxes insuring large capacity. Cap boxes one-third larger than those in a News Case.

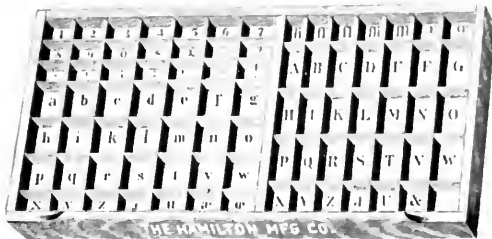

Dearing Job Case, \$1 00

For large sizes of type. Has greater capacity than any other Job Case. Lower case boxes extra large. Cap side California pattern.



Hamilton Job Case, \$0 90

Accommodates large sizes cap and figure fonts of metal type and small sizes of wood type. Holds one font caps, figures and points. Cap boxes 2 1/4 x 4 3/8 inches.

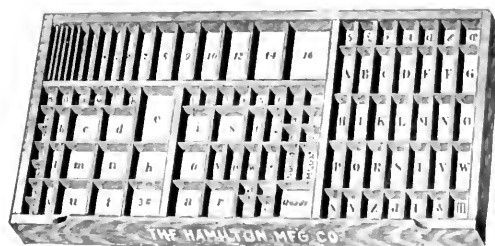

Combination Job Case, \$1 20

For use in legal blanks and similar work. Holds brass leaders from 1 to 16 ems, half ems from 1 to 5.



Dearing Accent Case, \$1 50

Five sections for caps, small caps and lower case of Roman, and caps and lower case of Italic. Extra boxes at front for Spanish, French and Portuguese accents.



Wheeler Job Case, \$0 90

Six rows of boxes on cap side. Extra large E box. Lower tier of cap boxes reduced to enlarge boxes for most used letters.

Prices, Illustrations and Layouts of Popular Type Cases



Russell Tabular Job Case, \$1 80

Has separate series of boxes for odd characters and diacritical marks, brass rules and brass leaders, piece fractions, quads, spaces, fractions, etc.



Duplex Job Case, \$1 10

Takes capital and lower case characters in adjoining boxes. Usual lower case layout in duplicate. Large cipher, period and hyphen boxes.



German Cap Case, \$0 80

Same as the regular Cap Case. The illustration simply shows how the German characters should be laid.

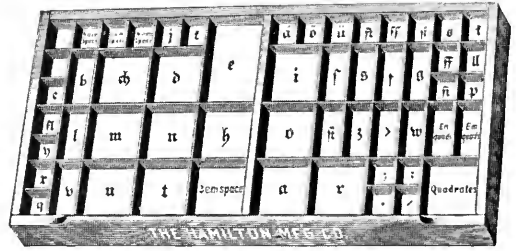

German Lower Case, \$0 80

This Case is the same as the regular Lower Case with the exception of the double "s" boxes, as shown.



Hebrew Cap Case, \$0 80

Same as the regular Cap Case. The illustration simply shows how the Hebrew characters should be laid.

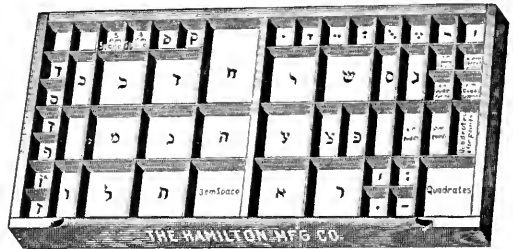

Hebrew Lower Case, \$0 80

Same as the regular Lower Case. The illustration simply shows how the Hebrew characters should be laid.



Greek Cap Case. Upper and Lower, per pair, \$2 00

We are prepared to furnish Cases specially for foreign languages. Prices quoted on application.



Greek Lower Case. Upper and Lower, per pair, \$2 00

All these Cases are made after the New Departure style—the best that can be produced.

A	B	Γ	Δ	E	Z	H	á	â	ã	ä	å	ä	ä	ä	ä	ä	η	ω
Θ	I	K	Λ	M	N	Ξ	é	ê	ë	ê	ë	ê	ë	ê	ë	ê	ï	ι
Ο	Π	Ρ	Σ	T	Τ	Φ	γ	η	η	η	η	η	η	η	η	η	ι	ι
X	Ψ	Ω	ƒ	g	η	ω	í	î	ï	î	ï	î	ï	î	ï	î	ξ	ξ
α	β	γ	δ	ε	ζ	η	ó	ô	õ	ô	õ	ô	õ	ô	õ	ξ	ξ	
θ	κ	λ	μ	ν	ξ	ω	ύ	υ	υ	υ	υ	υ	υ	υ	υ	υ	υ	
ο	π	ρ	σ	τ	υ	φ	ώ	ω	ω	ω	ω	ω	ω	ω	ω	ω	ω	
χ	ψ	ω	ς	ρ	ρ	ω	α	β	γ	δ	ε	ζ	η	θ	ι	κ	λ	

Porson Greek Case for Job Fonts, \$2 00

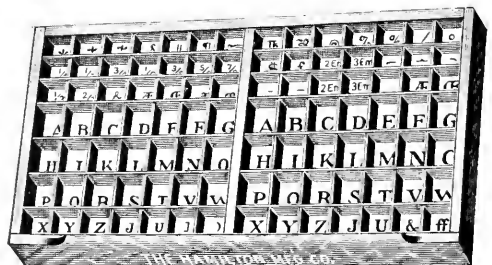

The Improved Cap Case

The new case has the regular arrangement of forty-nine compartments on each side of the center bar.

Prices, Illustrations and Layouts of Miscellaneous Cases

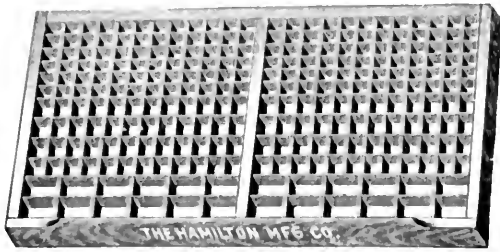

Border Case, \$1 25

A roomy Case of large capacity for all sizes of borders.



Music Case—Side, \$1 00



Music Case—Upper, \$1 00

Music composers will find these illustrations of great service in laying type. If the lettering is not distinct use a hand glass.



Music Case—Lower, \$1 00



Figure Case, \$1 00

A necessity in every large office. Takes extra large supply of figures and fractions. Can be furnished double depth.

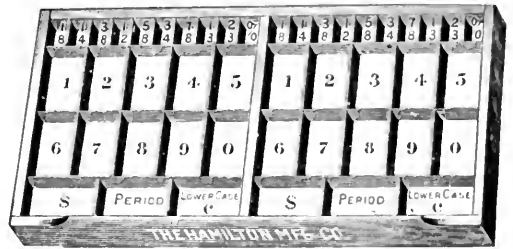

Byerly Figure Case, \$1 10

An improved Figure Case of great value. Figure boxes 2 1/2 x 1 1/2 inches. Fraction boxes 2 1/2 x 1 1/2 inches.



Improved Space and Quad Case, \$1 00

A slight modification of the old Space and Quad Case which we no longer list. Furnished on all orders for regular Space and Quad Cases.

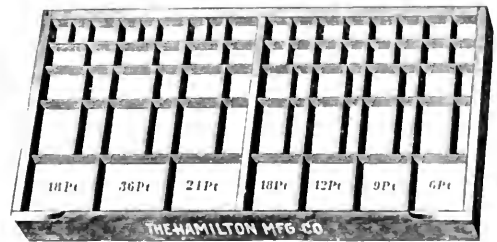

Practical Space and Quad Case, \$1 10

Provides for half-point and one-point spaces without the necessity of mixing. Accommodates seven sizes of spaces and quads.



No. 1 Adjustable Lead and Slug Case (single depth), \$1 50
Can be adjusted by picas to meet any requirement, and furnished also in double depth, if desired.

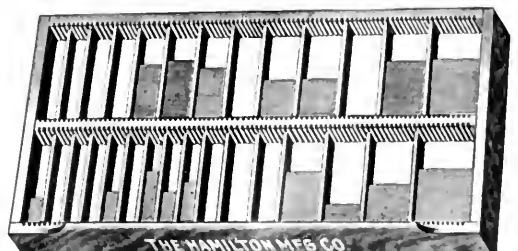

No. 2 Adjustable Lead and Slug Case (double depth), \$2 50
The center bar adds both strength and utility. Furnished in either single or double depth as desired.

Prices, Illustrations and Layouts of Miscellaneous Cases

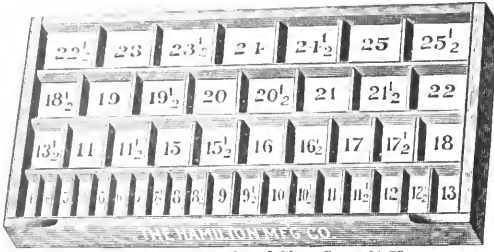

Two Rivers Lead and Slug Case, \$1 75

A new and most valuable Case. Takes lengths from 4 to 25 1/2 with variations by half picas.

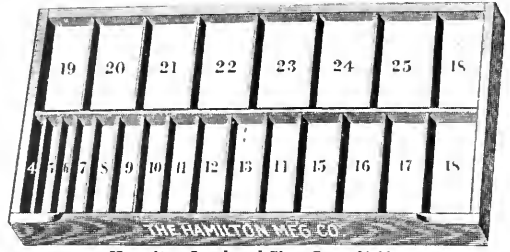

Hamilton Lead and Slug Case, \$1 00

Leads and slugs can be stacked two tiers deep. Can be had in double depth, if desired.

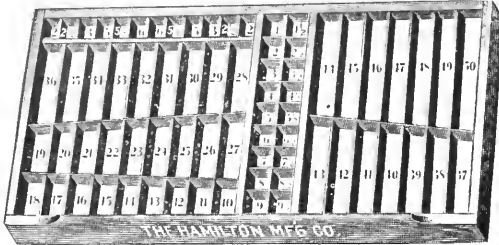

Rule Case (ordinary), \$1 15

The old style full-sized Brass Rule Case.

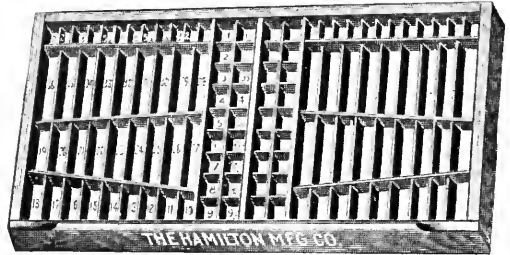

Furneau Rule Case, \$1 40

Designed by Geo. A. Furneau, Superintendent of The Inland Printer composing room. This Case will hold two large fonts of rule.

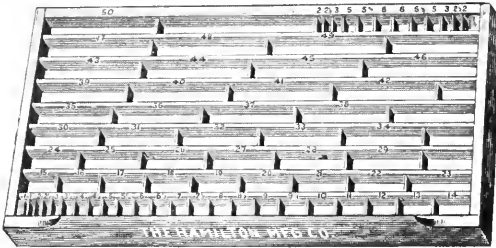

Neshota Rule Case, \$2 00

Takes a larger number of lengths than any other Rule Case. All lengths from 1 to 50 picas, with the usual half-pica lengths and places for mitered pieces.

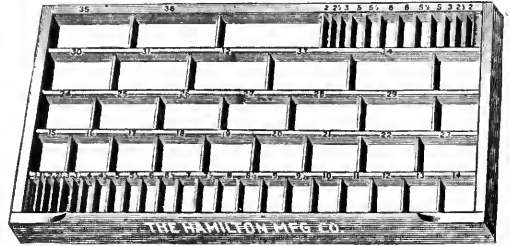

Zenobia Rule Case, \$1 50

Holds fewer sizes and larger fonts than the Neshota. Takes all lengths up to 36 ems.

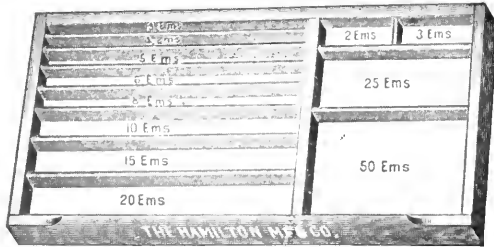

Metal Furniture Case, \$1 50

Compartments for each length as shown. Furnished in single or double depth, \$2 00

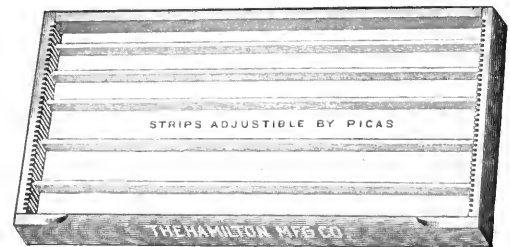

Wood Type Case, \$0 90

Graduated by picas on the ends. Strips can be adjusted to fit any size of type.



Italic Job and California Job Case, \$0 75

The standard two-thirds Case for all cabinets.

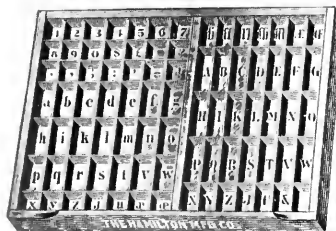

Dearing Job Case, \$0 75

The largest capacity of any two-thirds Case.



Yankee Job Case, \$0 75

The most popular of all two-thirds Cases.

Prices, Illustrations and Layouts of Miscellaneous Cases



Spaceless Job Case, \$0 80

Two-thirds size. All boxes for spaces and quads are omitted from this Case.



Hamilton Lead and Slug Case, \$0 75

Two-thirds size. Separate compartments, by picas, for lengths 1 to 25 picas inclusive.



Brass Leader Case, \$0 75

Two-thirds size. Compartments for lengths 1 to 25 picas. Half ems 1 1/2 to 9 1/2 picas.

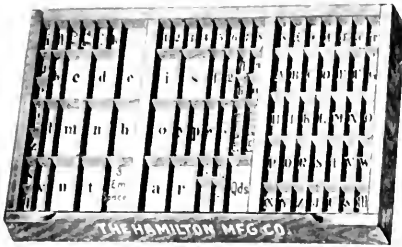

California Job Case, \$0 85

Three-quarter size. All three-quarter Cases listed by us are made in the same form and arrangement as the full size of the corresponding styles. We therefore illustrate but one three-quarter Case to show the comparative size.



Improved Job Case, \$0 90

Two-thirds size. An odd size, 21 3/4 by 19 3/4 inches deep. Fits regular two-thirds case rack.

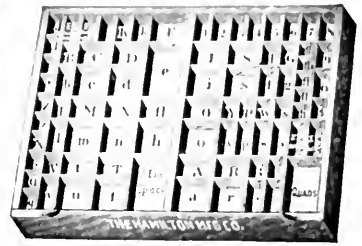

Duplex Job Case, \$0 90

Two-thirds size. The Duplex Job Case is unique. No other Case like it. Takes capital and lower case characters in adjoining compartments.

Jones Metal Furniture Case

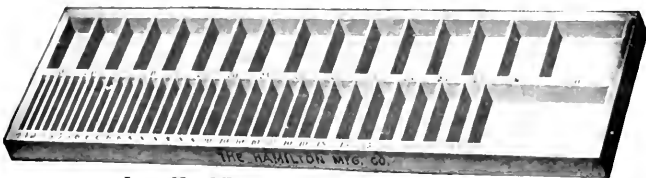

Jones Metal Furniture Case

half inches deep on the inside, it will hold a great quantity of metal, and is strongly constructed with this end in view. It has forty-nine compartments as shown by the illustration. Size, outside measure, 18x72 inches. Weight, not crated, 30 pounds. List price \$7 00

The Jones Metal Furniture Case for the proper storage of metal furniture will facilitate its use and maintain its accuracy. When thrown around promiscuously in boxes and drawers the delicate edges of metal furniture become battered, and it is permanently injured and rendered unfit for use in fine work. Much time will be saved by keeping metal furniture in cases with compartments numbered so that any desired length can be picked up without sorting a miscellaneous collection.

This Case is constructed of hardwood with a thick 3-ply bottom, firmly fastened to the edges and also to the center bar. Being two and one-half inches deep, it is strongly constructed with this end in view. It has forty-nine compartments as shown by the illustration.

The Bettis Lead and Slug Cases

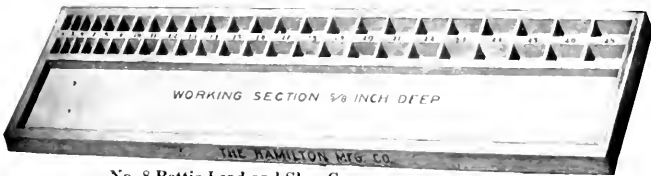

No. 8 Bettis Lead and Slug Case

depth, inside lead compartments, 1 1/2 inches; working space, 5/8-inch. Weight, not crated, 22 pounds. List price \$ 5 00
List price, with full brass lined working space 15 00

The No. 8 Bettis Lead and Slug Case takes the most commonly used sizes—from 4 to 28 picas, varying by single picas, but skipping the 27-em length. There are two compartments for each length, each compartment two and three-eighths inches wide from back to front, so that leads and slugs can be kept in separate compartments. The blank space at the front is five-eighths of an inch deep and eleven inches wide, and will readily take a ten by twenty-four brass-lined or all-brass job galley, and is intended for a working space. This is the proper case to use in connection with steel run stands.

Length, 72 inches; width, 18 inches, outside;

Weight, not crated, 22 pounds. List price \$ 5 00

List price, with full brass lined working space 15 00

The Bettis Space and Quad Case is of the same ground dimensions as the series of Bettis Lead and Slug Cases, being 72 inches long and 18 inches wide. It provides boxes for fourteen sizes of spaces and quads, six boxes for each size from six to forty-eight point, as the illustration shows; large deep boxes at the front for quads and smaller and shallower boxes at the back for spaces. It is six inches deep at the front and two and one-half inches deep at the back.

The use of this Case will enable all spaces and quads for job fonts to be kept in a single case. It is impossible to estimate the gain in time, and the saving in material when this Case is used. There is one place for every size of space or quad, and the compositor can find in a moment just what he wants. The Case is a great convenience as it forms an easily accessible storage place for all spaces and quads. It can be laid on the top of any stand in the most convenient location in the printing office, so that all can reach it readily. Weight, uncrated, 32 pounds. List price \$10 00



Bettis Space and Quad Case

The Bettis Lead and Slug Cases

Few printing offices are now without the Bettis Cases. They possess wonderful capacity and are strongly built to sustain a full load of leads and slugs, stacked two tiers deep. All these Cases are one and one-half inches deep, thus readily taking two tiers of three-quarter inch leads and slugs. These Cases having proved so very popular and so thoroughly practical, we have extended the line to meet the demand for a variety of inside arrangement. Cases of this size, specially designed, can be furnished to meet the requirements of any office. The No. 2, Three Case Tilting Brackets, or the No. 4, Three Case Brackets, without tilting feature, are the proper brackets to use.

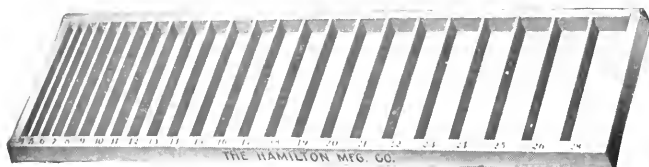

No. 1 Bettis Lead and Slug Case

The No. 2 Bettis Lead and Slug Case has compartments from 30 to 60 picas wide—one compartment for each of the following lengths: 30, 32, 34, 36, 38, 40, 42, 45, 50 and 60 picas. Partitions run from front to back without central division.

Length, 72 inches; width, 18 inches, outside; depth, inside, 1½ inches. Weight, not crated, 18 pounds.

List price \$4 00



No. 2 Bettis Lead and Slug Case

The No. 1 Bettis Lead and Slug Case has compartments from 4 to 28 picas wide, varying by single picas, omitting the 27-em length. Partitions run from front to back without central division.

Length, 72 inches; width, 18 inches, outside; depth, inside, 1½ inches. Weight, not crated, 21 pounds.

List price \$4 00

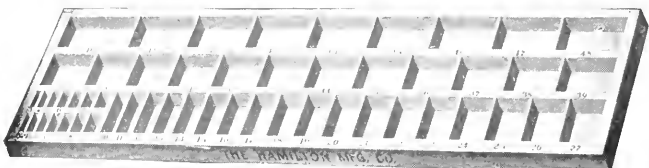

No. 3 Bettis Lead and Slug Case

The No. 3 Bettis Lead and Slug Case has compartments from 3 to 48 picas wide, varying by single picas. It also has compartments for ½ pica lengths from 3½ to 9½ picas inclusive. The case is divided into three sections, there being two central division bars running the long way of the case.

Length, 72 inches; width, 18 inches, outside; depth, 1½ inches, inside. Weight, not crated, 23 pounds.

List price \$5 00

The No. 4 Bettis Lead and Slug Case is the same as the No. 1 and No. 2 combined, having a central bar running the long direction of the case. The front section has compartments from 4 to 28 picas wide, varying by single picas, omitting the 27-em length; the back section has compartments from 30 to 60 picas wide—one compartment for each of the following lengths: 30, 32, 34, 36, 38, 40, 42, 45, 50 and 60 picas.

Length, 72 inches; width, 18 inches, outside; depth, inside, 1½ inches. Width, not crated, 21 pounds.

List price \$5 00

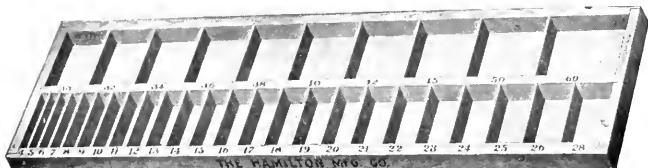

No. 4 Bettis Lead and Slug Case

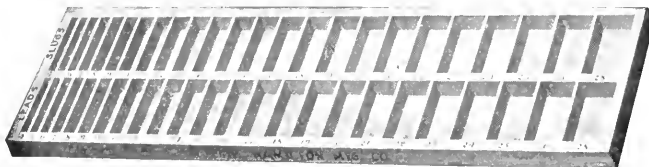

No. 5 Bettis Lead and Slug Case

The No. 5 Bettis Lead and Slug Case is a duplicate of the No. 1, with one exception—it has a center bar running the long way, dividing the case into two sections, which are alike in every respect. One section can be used for leads and the other section for slugs. Each section has compartments from 4 to 28 picas wide, varying by single picas, omitting the 27-em length.

Length, 72 inches; width, 18 inches, outside; depth, inside, 1½ inches. Weight, not crated, 22 pounds.

List price \$5 00

The No. 6 Bettis Lead and Slug Case is a duplicate of the No. 2, with one exception. It has a center bar running the long way, dividing the case into two sections. These sections are alike in every particular. One section can be used for leads and the other for slugs. Each section has compartments for lengths from 30 to 60 picas wide—one compartment in each section for each of the following lengths: 30, 32, 34, 36, 38, 40, 42, 45, 50 and 60 picas.

Length, 72 inches; width, 18 inches, outside; depth, inside, 1½ inches. Weight, not crated, 19 pounds.

List price \$5 00

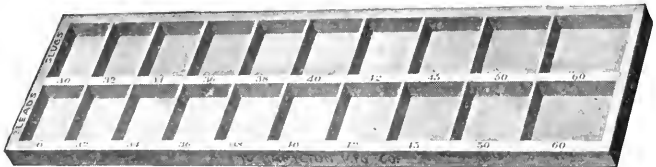

No. 6 Bettis Lead and Slug Case



No. 7 Bettis Lead and Slug Case

The No. 7 Bettis Lead and Slug Case represents the No. 5 and No. 6 combined. It has compartments in duplicate for all the lengths provided for in Cases No. 1 and No. 2. Leads and slugs for all lengths can be carried in separate compartments. There are two compartments for each of the following lengths: 4 to 28 picas, varying by single picas, omitting the 27-em length; also 30, 32, 34, 36, 38, 40, 42, 45, 50 and 60 picas.

Length, 72 inches; width, 18 inches, outside; depth, inside, 1½ inches. Weight, not crated, 23 pounds.

List price \$6 00

Quarter Size and Other Rule Cases

The series of Harris Rule Cases, quarter-size, and including the Sanspareil Harris Rule Case, one-half size, are in some respects the most economical, efficient and satisfactory Rule Cases ever constructed. The saving in time and space and in prolonging the life of brass rule by always keeping it face up, has made the Harris Cases popular with systematic printers.

They Save Space, Time and Material

It is seldom that a font of plain rule exceeds thirty-two pounds in weight, while sixteen pounds of dotted rule is usually ample even in large offices. It will take two ordinary rule cases to hold these two fonts, while they will fill only three-fourths of a set of

Harris Rule Cases, leaving the other quarter for one or (if a No. 1 case is used) two more fonts. Four Harris Rule Cases fit into one full size blank case, and will hold sixty-four pounds of brass rule.

No space is wasted in the Harris Rule Cases, and there is room provided for a large proportion of the smallest lengths—the most valuable part of a font. It takes much longer to trim one 1-em length than a 20-em length, and not one man out of ten can get the 1-em piece square at that. As each Harris Case is only one-quarter the size of a full size case, the compositor can put it on his cap case, or on the stone, or on his galley rest, without inconvenience.

HARRIS RULE OR INDIVIDUAL LEAD CASE No. 0.

In this a compositor may keep his much valued 12 to pica and other thicknesses of leads for justifying purposes, his pickups of dashes, rule, etc. It has boxes from 1 to 9½ ems (varying by ems), from 10 to 22 ems (varying by ems), and from 22 to 28 ems (varying by two ems), with

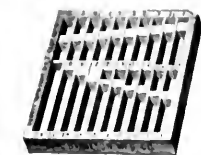

Harris Rule or Individual Lead Case No. 0

Size, 7¾x7½ inches, or one-eighth inside size of full size case. Weight, 10 ounces. List price . . . \$0 75

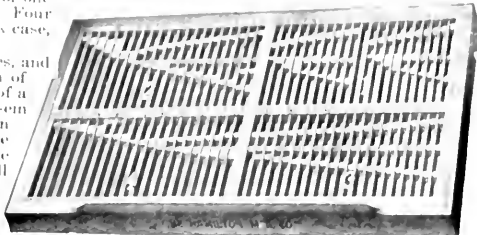

Four Harris Rule Cases in a Full Size Blank Case

List price, including blank case . . . \$1 65

postor may keep his much valued 12 to pica and other thicknesses of leads for justifying purposes, his pickups of dashes, rule, etc. It has boxes from 1 to 9½ ems (varying by ems), from 10 to 22 ems (varying by ems), and from 22 to 28 ems (varying by two ems), with a long box for longer lengths.

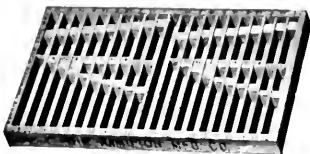

No. 1 Harris Rule Case

Size, 7¾x15½ inches. Weight, 19 ounces. List price . . . \$1 25

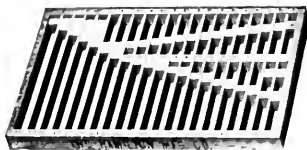

No. 2 Harris Rule Case

Size, 7¾x15½ inches. Weight, 19 ounces. List price . . . \$1 00

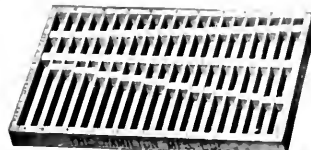

No. 3 Harris Rule Case

Size, 7¾x15½ inches. Weight, 18 ounces. List price . . . \$0 75

No. 1 HARRIS RULE CASE. This case holds two complete small fonts of labor-saving rule, each weighing eight pounds, or sixteen pounds in all. Each half of this case holds eighteen pieces each length from 1 to 8½ ems (varying by ems), eighteen pieces each from 9 to 18 ems (varying by ems), and nine pieces each of 19, 20, 21, 22, 24, 26 and 28 ems, besides boxes for right and left miters.

No. 2 HARRIS RULE CASE. This case holds one complete font of sixteen pounds weight. It has compartments for thirty-six pieces each from 1 to 9 ems long (varying by ems), eighteen pieces each from 10 to 21 ems (varying by ems), and eighteen pieces each of 26, 28, 30, 32, 34 and 36 ems long, besides boxes for right and left miters. A large proportion of small lengths.

No. 3 AND 4 HARRIS RULE CASES. These two cases are designed to be used together to hold a large font of rule, suitable for a large office, weighing thirty-two pounds or less. Two, and in some cases four boxes are used to hold the most used sizes. Each case has its proportion of the small sizes, so that if it is desired to carry one case to a compositor's stand for use in rule work, the other is available in its regular place. Case No. 3 has compartments for all short lengths up to and including the 20 em length.

Case No. 4 has compartments for all of the short lengths and also all long lengths up to and including the 36 em lengths. Together these cases have compartments for seventy-two pieces each from 1 to 9 ems long (varying by ems), thirty-six pieces each from 10 to 24 ems long (varying by ems), and eighteen pieces each from 25 to 36 ems long (varying by ems), besides boxes for right and left miters.

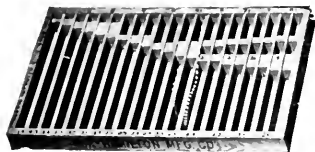

No. 4 Harris Rule Case

Size, 7¾x15½ inches. Weight, 17 ounces. List price . . . \$1 00

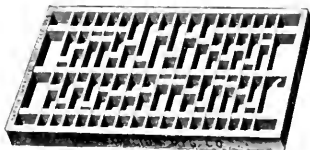

No. 5 Harris Border Case

Size, 7¾x15½ inches. Weight, 18 ounces. List price . . . \$1 00

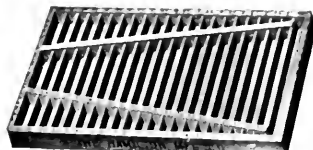

Perfection Rule Case

Size, 7¾x15½ inches. Weight, 17 ounces. List price . . . \$0 90

No. 5 HARRIS BORDER CASE. This case may be used in combination with any other quarter-size cases, being exactly the same size. To meet the varied requirements of all border and ornament fonts, the sort partitions are movable, but are so nicely fitted that they remain in any position in which they are placed. This special and novel feature makes it an easy matter to change the sizes of the boxes at will.

PERFECTION RULE CASE. This is another first-class quarter-size brass rule case. In size it is similar to the Compact Rule Case and accommodates the same lengths, but with a different arrangement of compartments. It has two compartments for all lengths from 1 to 12 ems, and one compartment for lengths from 13 to 36 ems. The variations are by ems from 1 to 10 and by ems from 10 to 36. Four of these cases will fit into an ordinary blank case in a cabinet or rack.

COMPACT RULE CASE. The Compact Rule Case has one compartment for each length from 1 to 36 ems (varying by ems up to 10 ems) and by single ems from 10 to 36 ems. It will hold twenty pieces of each length. It also has compartments for the miters. This rule case is preferred by

printers, owing to its compact arrangement and even quantity of each length accommodated. All rule remains standing when placed in this case. The Compact Rule Case is one of the most popular of all rule cases. Few printing offices are without some of them and many offices use this case exclusively. Four of these cases will fit inside a full size blank case. They can be kept in blank cases in cabinets or stands or in quarter case cabinets.

THE SANSPAREIL HARRIS RULE CASE. This is without doubt one of the best rule cases yet designed. The walls and partitions are a trifle higher than type high, so the rules are at all times protected; anything can drop, or be laid on the case without touching the face of the rule. The rule cannot get wedged or fall flat on account of the narrow compartments.

Each compartment is the exact size of the rule it is to contain, and the next size will not fit into it, thus preventing sizes being mixed. The rule is easy to extract on account of low cross partitions and the special slot in downward partitions. The compositor need not study the case every time he wants a rule; the compartments follow in consecutive order, from 1 to 42 ems. Each case is complete with all sizes from 1 to 9½ ems (varying by ems), and from 10 to 12 ems (varying by ems), with an extra allowance for small sizes; also an additional row for miters (second row of small sizes) which, when no miters are carried, can be used for overflow on small sizes, of which there is always a large stock. For large fonts of rule, running in lengths not usually included in fonts of labor-saving brass rule as now put up by the makers, it is especially valuable, and there is no case to replace it.

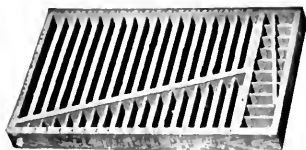

Compact Rule Case

Size, 7¾x15½ inches. Weight, 17 ounces. List price . . . \$0 90

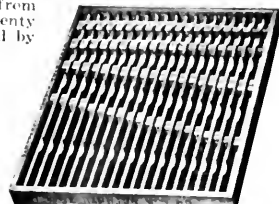

Sanspareil Harris Rule Case

Size, 11¾x15½ inches. Weight, 35 ounces. List price . . . \$1 50

Hamilton New Rule Cases

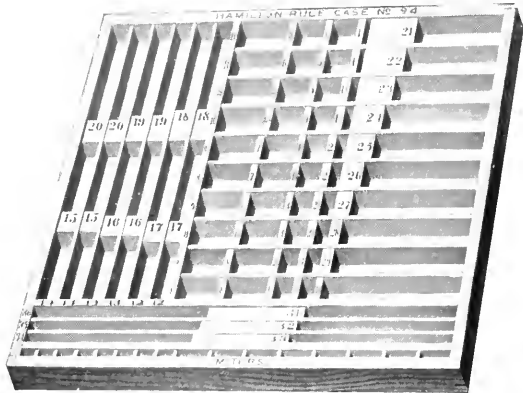

No. 94 Hamilton Rule Case

The Hamilton Rule Case, No. 94, takes a 25-pound font of standard rule on 2-point body. Separate compartments are provided for every length from 1 to 36 picas long, inclusive, with separate compartments for two sizes of miters. Where there are a large number of pieces in the shorter lengths, the compartments are doubled, two for each length, so as to maintain narrowness of compartments in order to keep the rules standing.

Size, 15³/₈x12¹/₂ inches, outside measure. Weight, 33 ounces. List price \$1 40

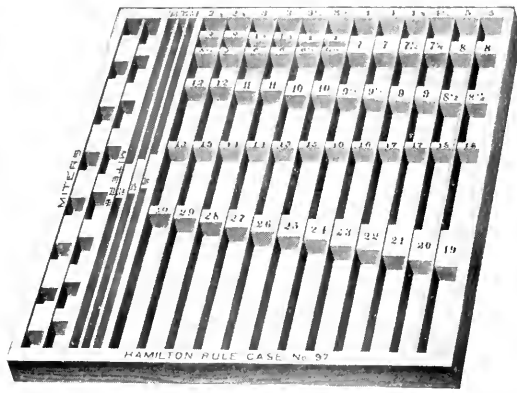

No. 97 Hamilton Rule Case

The No. 97 Hamilton Rule Case takes a 25-pound font of standard rule on 6-point body. Separate compartments are provided for every length from 1 to 36 picas long, inclusive, with separate compartments for two sizes of miters. Where there are a large number of pieces in the shorter lengths, the compartments are doubled, two for each length, so as to maintain narrowness of compartments in order to keep the rules standing.

Size, 13¹/₄x16¹/₄ inches, outside measure. Weight, 40 ounces. List price \$1 40

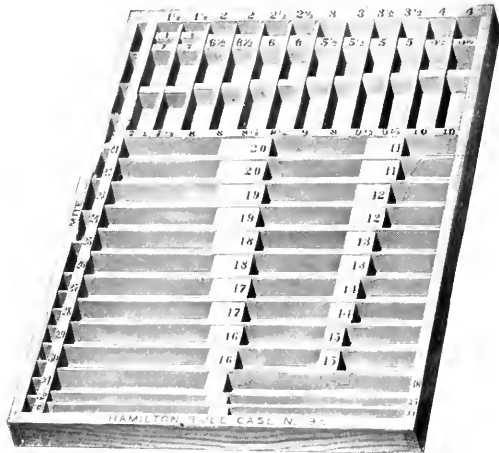

No. 95 Hamilton Rule Case

The Hamilton Rule Case, No. 95, takes a 25-pound font of standard rule on 3-point body. Separate compartments are provided for every length from 1 to 36 picas long, inclusive, with separate compartments for two sizes of miters. Where there are a large number of pieces in the shorter lengths the compartments are doubled, two for each length, so as to maintain narrowness of compartments in order to keep the rules standing.

Size, 13³/₈x14¹/₄ inches, outside measure. Weight, 34 ounces. List price \$1 40



No. 61 Hamilton Rule Case

The No. 61 Hamilton Rule Case takes a 5-pound font of standard rule on 6-point body. Separate compartments are provided for every length from 1 to 26 picas long, inclusive, with separate compartments for miters. All compartments are narrow, so that the rules will remain standing on edge.

Size, 5³/₈x11¹/₂ inches, outside measure. Weight, 14 ounces. List price \$0 75

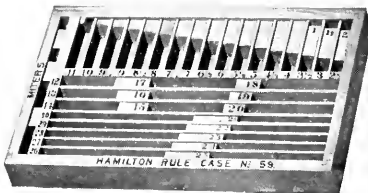

No. 59 Hamilton Rule Case

The Hamilton Rule Case No. 59, takes a 5-pound font of standard rule on 3-point body. Separate compartments are provided for every length from 1 to 26 picas long, inclusive, with separate compartments for miters. All compartments are narrow, so that the rules will remain standing on edge.

Size, 5⁷/₈x11³/₄ inches, outside measure. Weight, 15 ounces. List price \$0 75

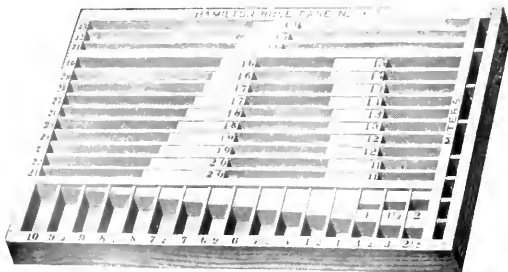

No. 68 Hamilton Rule Case

The No. 68 Hamilton Rule Case takes a 10-pound font of standard rule on 3-point body. Separate compartments are provided for every length from 1 to 36 picas long, inclusive, with separate compartments for miters. These compartments are narrow, so that the pieces of rule will always remain standing on edge.

Size, 8¹/₂x15 inches, outside measure. Weight, 28 ounces. List price \$1 25

The No. 70 Hamilton Rule Case takes a 10-lb. font of standard rule on 6-point body. Separate compartments are provided for every length from 1 to 30 picas long, inclusive, with separate compartments for miters. The compartments are narrow, so that the pieces of rule will always remain standing on edge.

Size, 9¹/₄x11 inches, outside measure. Weight, 19 ounces. List price \$1 00

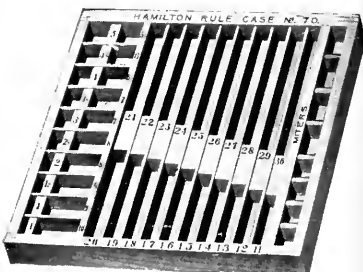

No. 70 Hamilton Rule Case

All Cases shown on this page have a line gauge printed on the edge for determining lengths

Hamilton New Rule Cases

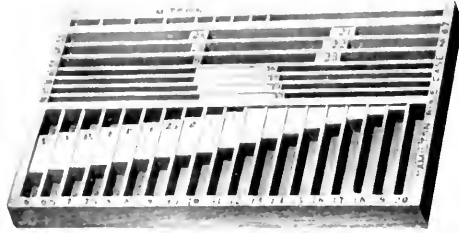

No. 67 Hamilton Rule Case

The Hamilton Rule Case No. 67, takes a 10-pound font of standard rule on 2-point body. Separate compartments are provided for every length from 1 to 36 picas long, inclusive, with separate compartments for miters. All compartments are narrow, so that the rules will always remain standing on edge.

Size, 7¹/₂ x 11¹/₄ inches, outside measure. Weight, 21 ounces. List price \$1 25

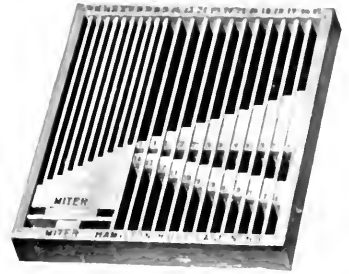

No. 58 Hamilton Rule Case

The Hamilton Rule Case No. 58, takes a 5-pound font of standard rule on 2-point body. Separate compartments are provided for every length from 1 to 36 picas long, inclusive, with separate compartments for miters. All compartments are narrow, so that the rules will always remain standing on edge. Size, 8¹/₂ x 9¹/₂ inches, outside measure. Weight, 15 ounces. List price \$0 75

A line gauge for determining lengths is printed on the edge of the above Hamilton Rule Cases

Space, Quad, Leader and Border Quarter Cases

The series of four Wisconsin Quarter-size Cases have become very popular and are now widely used. They are intended to hold odd material not usually provided for in regular full size cases. For signs, borders, accents, split fractions, figures, spaces and quads, etc., they are most convenient. The Wisconsin Quarter Cases provide a means of keeping these valuable sorts where they can be found. These Cases are 7³/₈ x 15¹/₈ inches in size, and can be placed on a cap case, a stand, or a stone, convenient to the compositor's hand. In setting mathematical work, foreign languages, dictionaries, special catalogues, with much table work, these Quarter Cases will prove invaluable. A few schemes are shown for laying signs, fractions and figures. Various other arrangements can be provided which will suggest themselves to the intelligent compositor.

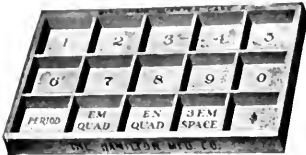

Wisconsin Quarter Size Case "A"

Convenient for holding figures, spaces and quads, fractions, etc. Size, 7³/₈ x 15¹/₈ inches. Weight, 15 ounces. List price \$0 65



Wisconsin Quarter Size Case "B"

This pattern is suitable for holding accented letters and split fractions. Size, 7³/₈ x 15¹/₈ inches. Weight, 17 ounces. List price \$0 65



Wisconsin Quarter Size Case "C"

This pattern has large boxes for figures and smaller compartments for fractions. Size, 7³/₈ x 15¹/₈ inches. Weight, 11 ounces. List price \$0 65

The American Type Founders Company sells the best of Everything for the Printer.



Wisconsin Quarter Size Case "D"

Especially convenient for holding signs, borders and odd characters. Size, 7³/₈ x 15¹/₈ inches. Weight, 16 ounces. List price \$0 65



All Right Space and Quad Case

Size, 7³/₈ x 15¹/₈ inches. Weight, 15 ounces. List price \$0 75



Happy Border Case

Size, 7³/₈ x 15¹/₈ ins. Weight, 22 ounces. List price \$1 25

THE ALL RIGHT SPACE AND QUAD CASE is a most useful addition to the family of Quarter-size Cases. It has compartments for one-half point thin copper spaces, one point thin brass spaces, also compartments for 3, 4, 5 and 6 em spaces, em, en and 2 and 3 em quads. Compartments are proportioned in size correctly to take the amount of each size as put up by the type foundry. Each case will hold a standard 10-pound font of spaces and quads of any size without over-filling the boxes.

THE HAPPY BORDER CASE has adjustable partitions by picas the long way and by 6 points from front to back. Any font of border can be laid in this Case and the compartments laid out to accommodate the different characters, and left that way. Eight long slotted divisions and an assortment of short divisions in various lengths, accompany each Case. Four of these Border Cases will fit inside an ordinary blank case in a cabinet or case rack.



Carpenter Quarter Case

Size, 7³/₈ x 15¹/₈ ins. Weight, 17 ounces. List price \$0 75



Ideal Brass Leader Case

Size, 7³/₈ x 15¹/₈ inches. Weight, 17 ounces. List price \$0 90



Time-Table Quarter Case

Size, 7³/₈ x 15¹/₈ ins. Weight, 17 ounces. List price \$0 75

THE CARPENTER QUARTER CASE is most useful in tabular and other intricate work. It is intended to set on the ends of the lower cases in the center between two lower cases covering the space usually occupied by a galley board, and the lugs on the back end hold the case from slipping off at the front. It also has a lip at the front which enables other small cases to be put on top of this Case and remain in place without danger of slipping off. In use it is a vertical figure case with double spaces for 5's and ciphers - the figures most used - and compartments for justifying material and special sorts.

THE IDEAL BRASS LEADER CASE is designed to hold ordinary five and ten-pound fonts of brass leaders as put up by the type foundry. Has compartments for all lengths from 1 to 22 picas, variations by ems from 10 to 22. Four of these cases will just fit inside a regular blank case in a rack or cabinet. The Case is fitted with a New Departure bottom. Numbers printed over each compartment.

THE TIME-TABLE QUARTER CASE is a new and popular quarter-size case for tabular work. It has special compartments for A.M. and P.M. This case can be made useful in other work, such as legal notices, market reports, etc. The type can be laid in the case as required for the work in hand. Like other quarter-size cases, four will fit into a regular full-size blank case. They will also fit into our regular line of quarter case cabinets.

Koerner's Patent Interlocking Drying Racks

With these Racks sheets are taken *direct from the fly*, and may be stacked ceiling high, in a perfectly straight and rigid pile, which cannot be knocked over by accident, and with no more weight on the bottom than on the top sheets. This pile is a most effective drying room, occupying only the floor space of one rack, and from the time the sheets are fed into the machine until ready for the bindery they need not be handled.

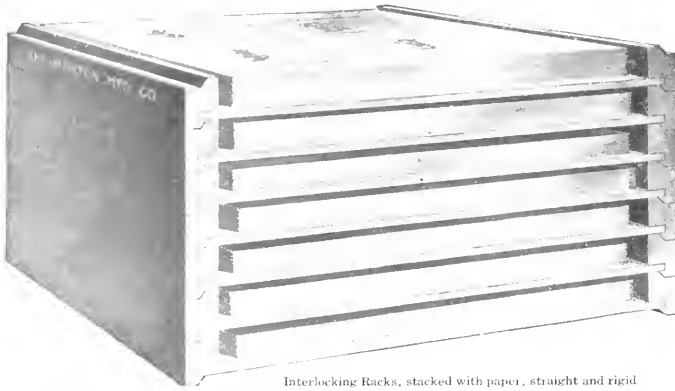

Interlocking Racks, stacked with paper, straight and rigid

The slats which support the sheets are three-eighths of an inch thick. When stacked, each Rack adds one and nine-sixteenths inches to the height. Unless otherwise ordered, the side rails are always made to run the longest dimension.

The prices given below are for Racks with a clearance of one and three-sixteenths inches between, when Racks are stacked. For a clearance of two and one-half inches add twenty-five per cent to prices mentioned below, and for a clearance of three inches add thirty-five per cent to the prices mentioned below. Special Racks of any size and pattern can be made to order. Prices will be furnished on application and receipt of particulars.

List Prices, Weights and Dimensions of Koerner's Patent Interlocking Drying Racks

Size, Inside	Weight, Each	Price	Size, Inside	Weight, Each	Price
8 ¹ / ₂ x 13 inches	1 ¹ / ₂ pounds	\$0 20	21x36 inches	8 pounds	\$0 55
11 x 17 inches	3 pounds	25	32x48 inches	12 pounds	85
13 x 19 inches	3 ¹ / ₂ pounds	30	38x52 inches	15 pounds	1 20
15 x 21 inches	4 pounds	35	43x63 inches	19 pounds	1 55
18 x 25 inches	5 pounds	45	45x65 inches	20 pounds	1 60

The interlocking device makes the pile straight and rigid. Each Rack is firmly locked on its neighbor, but each slides with ease on the Rack immediately below it. They save handling, all the time of that operation, and the consequent waste of paper through offset, smearing, fingermarks and tearing. In many cases these Racks save expensive slip-sheeting. They circumvent electricity by receiving the sheet direct from the fly.

They insure evenness of temperature and thereby assist in getting a perfect register on lithographic work.

They save seventy-five per cent of floor space over any other method of drying sheets, from one to two per cent of paper, and a vast amount of time.

The Patent Interlocking Drying Racks are made with hardwood sides, wide softwood slats, and are very strongly put together.

The side rails on Koerner Racks are one and one-quarter inches wide.

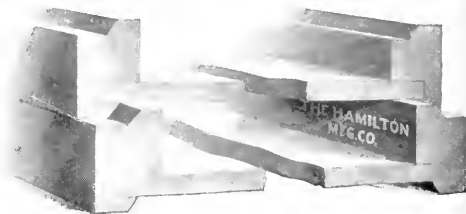

End View of Interlocking Device

Chicago Drying Racks

A more economical addition cannot be made to a modernly equipped printing office than a suitable outfit for the proper drying of the printed sheets. These Drying Racks are substantially constructed of selected hardwood, and the framework is finished in the best cabinet style. They have wide bases, which prevent the frames from toppling over under heavy loads. The side rails extend at the rear and are notched to receive round lugs which project from the frame upright. When loaded the Dryers can be placed in a horizontal position, and when not loaded, they can be inclined upward and out of the way until required.

These Drying Racks are made in three sizes, to take sheets 24x24, 24x36 and 30x48 inches. The Racks are supplied complete with Dryers, and the Dryers are also sold separately in dozen lots. Each rack is mounted on heavy castors, and can be transferred about the press room as the work in hand requires.

List Prices of Chicago Drying Racks

NAME OF DRYING RACK	SHELVES IN EACH RACK		Price Complete	Complete Weight Pounds	Price of Racks Only	Price per Dozen Shelves Only	Weight per Doz. Pounds
	Number of Shelves	Size Inches					
Chicago No. 5	12 Shelves	24x24	\$20 25	200	\$12 50	\$7 75	95
Chicago No. 6	10 Shelves	24x36	22 00	225	14 00	9 60	125
Chicago No. 7	10 Shelves	30x48	32 25	250	21 00	13 50	185



Chicago Drying Rack

The New York Drying Racks

The New York Dryers are also removable and can be transferred to the press in order to take the sheets direct from the fly. Thus undue handling, which means an excess of spoilage, is avoided. The use of these Dryers prevents undue stacking of freshly printed sheets, and expensive slip sheeting is reduced to a minimum. The rightful use of a good set of Dryers will prevent much of the smutting commonly experienced.

The New York Drying Rack is made in four sizes. The Dryers are made in two sizes to take sheets twenty-four by thirty-six and twenty-eight by forty-two inches. The frames are made to take twenty or thirty dryers, as desired. Each rack is mounted on castors and can be transferred about the press room as the requirements demand. Dryers are sold complete with supporting Racks or loosely by the dozen.

List Prices of New York Drying Racks

NAME OF DRYING RACK	SHELVES IN EACH RACK		Price Complete	Complete Weight Pounds	Price of Racks Only	Price per Dozen Shelves Only	Weight per Doz. Pounds
	Number of Shelves	Size Inches					
New York No. 1	20 Shelves	24x36	\$22 75	225	\$12 00	\$6 50	80
New York No. 2	30 Shelves	24x36	32 00	300	15 75	6 50	80
New York No. 3	20 Shelves	28x42	28 75	250	12 75	9 60	105
New York No. 4	30 Shelves	28x42	40 50	350	16 50	9 60	105



New York Drying Rack

The prices on this page subject to prevailing discounts

The Best Ideas in Case Brackets

We show here illustrations of all the best ideas in Case Brackets, Galley Brackets and also Roller Brackets. We handle the complete line and can promptly supply your wants.

No. 1 Tilting Bracket

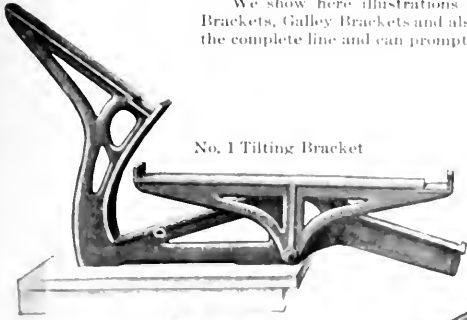

No. 2 Three-Case Tilting Bracket

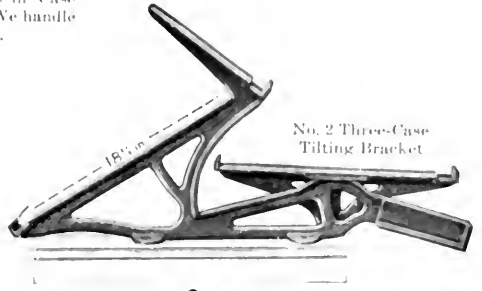

No. 3 Three-Case Tilting Bracket

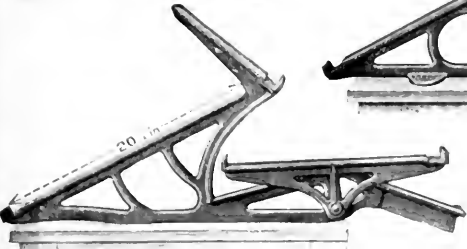

No. 16 Low Job Case Bracket

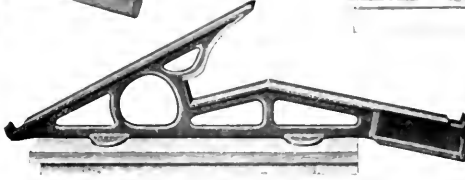

No. 4 Three-Case Bracket

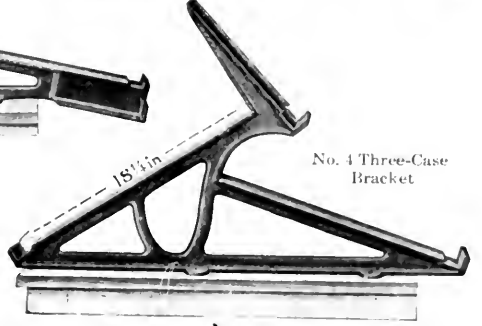

No. 9 New York Case Brackets

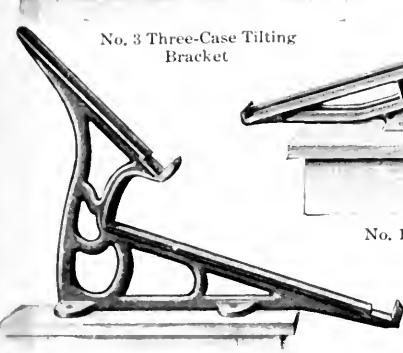

No. 17 Low Job Case Bracket

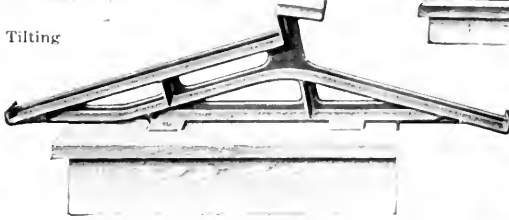

No. 5 Three-Case Bracket

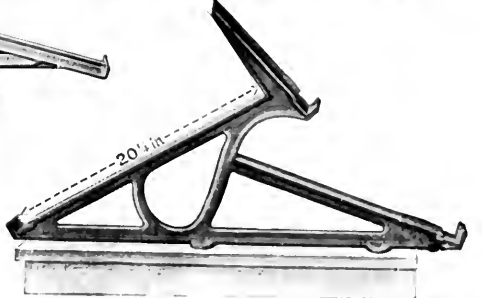

No. 8 Double Case Bracket, Style C

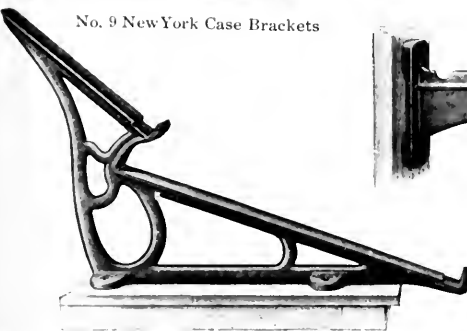

No. 13 Roller Bracket

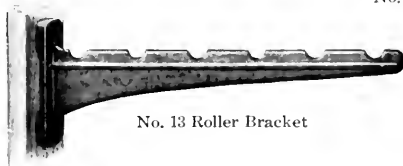

No. 10 Detachable Single Case Bracket

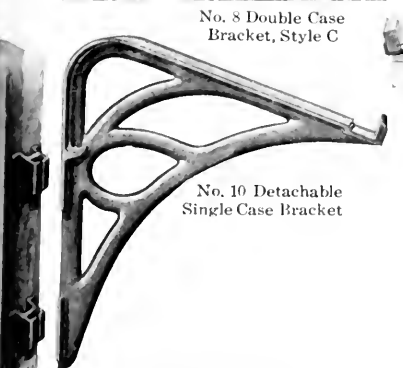

No. 18 Case Bracket with Upper Arm detached

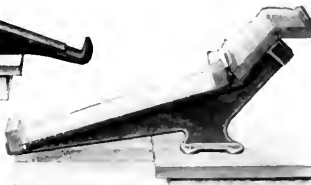

No. 18 Case Bracket with Upper Arm extension in place

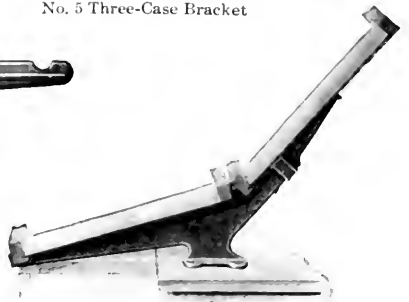

No. 14 Double Galley Bracket

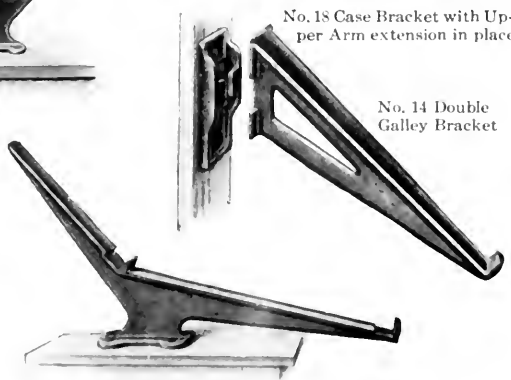

For complete description and prices of all Brackets see page 1284b

No. 7 Double Case Bracket, style B

Case and Roller Brackets

Brackets are made for Type Cases, Lead and Slug Banks, Working Banks, Galleys, Rollers, etc. We illustrate on the opposite page a selection from which almost any possible requirement can be met. The three-case brackets are made with and without the tilting feature in two sizes. All Brackets are of cast iron, free from flaws and are furnished with black japanned finish, with holes drilled for screws.

The No. 1 Tilting Bracket takes a pair of standard size news cases. The lower case can be tilted back to expose the galley board underneath.
Price, per pair \$ 2 00

The No. 2 Three-Case Tilting Bracket takes a pair of standard size news cases at the front, and an eighteen inch working bank or standard size Bettis lead and slug case at the rear.
Price, per pair \$ 2 40

The No. 3 Three-Case Tilting Bracket is the same as the No. 2 except that it takes a twenty inch dump at the rear. Takes a pair of standard size news cases at the front.
Price, per pair \$ 2 50

The No. 4 Three-Case Bracket is without tilting feature. Takes a pair of standard size news cases at the front, and an eighteen inch working bank or standard Bettis lead and slug case at the rear.
Price, per pair \$ 1 90

The No. 5 Three-Case Bracket is without tilting feature and is same as the No. 4, except that it takes a twenty inch dump at the rear. Accommodates a standard pair of news cases at the front.
Price, per pair \$ 2 00

The No. 7 Double Case Bracket, style B, is for attachment on a flat surface. It takes a pair of standard size news cases.
Price, per pair \$ 1 25

The No. 8 Double-Case Bracket, style C, takes an eighteen inch working bank or standard Bettis lead and slug case at the front and a standard full size case at the top.
Price, per pair \$ 1 75

The No. 9 New York Case Bracket, takes a pair of standard size news cases. Provides for bringing the cap case forward several inches over the lower case and close to the compositor.
Price, per pair \$ 1 50

The No. 10 Detachable Single Case Bracket, with sockets, will attach to an upright surface, particularly on the end of a cabinet. Will hold a single full size case or a working bank.
Price, per pair \$ 2 00

The No. 13 Roller Bracket will attach to a perpendicular surface. Bracket arms extend horizontally and will hold six rollers.
Price, per pair 50 cents

The No. 16 Low Job Case Bracket will take two job cases on one side, one placed on top of the other. Can be tilted back and held in reversed position. The opposite side will take a standard eighteen inch Bettis lead and slug case or working bank.
Price, per pair \$ 2 00

The No. 17 Low Job Case Bracket will take a standard size job case on one side, which can be tilted back. The opposite side will take a standard size eighteen inch Bettis lead and slug case or working bank. In the center is a four-inch space for lead bank.
Price, per pair \$ 2 00

The No. 18 Case Bracket with upper arm detached will take a job case at the front and a two-surface lead and slug tray at the top.
Price, per pair \$ 2 00

The No. 18 Case Bracket with upper arm extension in place will take a pair of news cases.
Price, per pair \$ 2 00

Everything that is Good for the Printers as Quick as It Appears

The American Type Founders Company, in its capacity as Universal Provider for Printing Plants, furnishes every standard and approved and also every new and good machine, apparatus, appliance or tool as soon as it appears. This is the most complete catalogue of Printers' Requirements ever issued, but when from time to time in the future anything new in this line appears, and if it is worthy to be recommended, it will be on sale by this company.

*IF IT IS GOOD FOR THE PRINTER THE
AMERICAN HAS IT FIRST*

IMPORTANT TO BUYERS OF STEEL EQUIPMENTS

In the design and the method of construction and the materials used the printing equipments catalogued in the following pages are for the most part quite new. It is the aim to make these steel and iron equipments not only more durable but also more space- and time-saving than any equipments heretofore offered to printers. The initial expense of the dies and formers required for each piece of steel furniture is so great, that the selection of the most advanced and best approved designs is a matter of the utmost importance to the manufacturer, a consideration that cannot fail to benefit the buyers. There can be no question of the ultimate economy of installing properly constructed steel and iron equipments.

GOOD QUALITY AND BAD QUALITY

The mere fact that iron and steel are used does not establish Stability and Durability. A method of construction which may be suitable for ordinary office furniture is quite unsuitable and inadequate for printing plant equipments, which have to sustain heavy weights and withstand great strain and wear and tear. Good quality in steel and iron equipments depends (even more than in wood) on careful, workmanlike and substantial construction. The place to look for the essential quality is in the interior or concealed work and material. While steel and iron construction lends itself to attractive designs, the attractiveness may serve to conceal poor construction and inadequate materials. The line of equipments offered here is not only attractive in appearance, but has behind the attractiveness a method of construction and a selection of materials which make these equipments the most economical and best value procurable, when tested by length of service and the maintenance of good appearance long after flimsy steel constructions and the best wooden constructions have reached the scrap heap.

A shelf of steel, if made too light, is not so serviceable as one made of wood of suitable thickness, on account of the greater spring in the steel. Iron make-up and storage tables, if not adequately supported by a sufficient number of legs, will soon disclose a degree of instability which will retard the work done on them. The first consideration in purchasing steel and iron equipments should be Stability and Durability.

The American Type Founders Company is behind every piece of steel and iron equipment it sells. It recommends this class of equipment to those who are looking for permanent investments in equipments of a nature which may be passed along to their grandchildren with little practicable impairment of quality, and which will maintain a good and dignified appearance to their successors. If properly made, this class of equipment cannot, at present, be made as cheaply as wooden equipments, and any attempt to cheapen construction will result in a poor bargain for the purchaser.

SPECIAL REQUIREMENTS FOR NEWSPAPER PLANTS

Newspaper plants of the larger and growing kind require equipments of extra Durability. Furniture which may be adequate to the use of commercial printing plants may not withstand the greater wear and tear of daily newspaper usage. Steel and Iron Equipments which have been in use on daily newspapers for ten years are now as satisfactory both in service and in good appearance as when first bought.

QUESTION OF FIRE INSURANCE

In buildings constructed to be fireproof, the installation of wood equipments increases the hazard and the rate of insurance. If the contents are inflammable the building is in grave danger as well. The use of steel and iron equipments will lessen the risks from fire.

THIS IS THE AGE OF STEEL

In every direction the increasing use of steel and iron furniture and fittings is observable. The demand is for permanency, for the best value, and that quality which is more appreciated years after the purchase than in the beginning. When the printing plant *runs down* the operating expenses *run up*. Those who invest in *well constructed* steel and iron printing plant equipments are insuring themselves against the plant running down. These equipments will keep the printing plant perennially young. Those who install iron and steel equipments have served notice that they are in business to stay.

Rogers Steel Cabinet No. 553

This highly efficient cabinet occupies the least possible floor space, holds the greatest number of full-size cases it is possible to put into a working cabinet, and gives the compositor liberal facilities for disposing of copy, proofs, tools, and the materials used in the work in hand. Above the cases there is a lead and slug bank holding sizes from four to twenty-five picas. This lead and slug bank is a great convenience and time-saver both to the compositors stationed in the same alley and to compositors who come to the alley from other stations to use the cases below.

The Rogers Cabinet conforms to the only efficient principle: that access to cases in a cabinet or stand should never be obstructed by compositors working in front of them. Alleys should contain cases on one side and working banks on the other side. All the cases and the lead and slug bank are readily available for the compositors using the working banks, and also available without hindering any man's work for compositors stationed in other alleys. Each case should be provided with spaces and quads, to save the time wasted in walking to and from a central space and quad

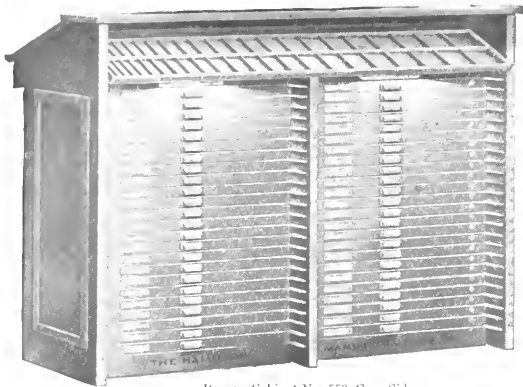

Rogers Cabinet No. 553, Case Side

supply every time a line is to be justified, a waste that very quickly foots up more than the cost of the spaces and quads.

An entirely new and good feature is a shelf, ten inches by seventy inches, forming a top to the cabinet, but not in any way interfering with its uses as a working cabinet. This shelf will be found very convenient for holding such things as cuts and other material and quarter-cases holding auxiliary materials required for the work immediately in hand.

The cabinet contains forty-eight full-size California job cases, twenty-four on each side. The runs project three inches beyond the cases to afford a secure hold for each case when it is pulled out for setting a line without removing it from its place in the cabinet.

On the working side there is a full length working bank, seventeen inches deep, on which two full-size cases can be placed, if required. This being a job compositor's cabinet, no provision is made for pair cases. On this side also are two spacious drawers.

The construction is strong, durable and very attractive. The frame and working bank are of heavy reinforced steel, the ends and sides of pressed sheet steel. The runs are so incorporated with the frame as to be more than sufficiently strong to withstand the heaviest weights which may properly be placed on them. Color, olive green.

Linolite Lamps, as described on page 1300, may be attached on brackets over the working bank or above the case racks, as shown in illustration, if required.

Dimensions and Contents of Rogers Cabinet No. 553

Cases are of wood, with boxes $1\frac{1}{16}$ -inch deep, and with Steel Front Protectors and Bronzed Pulls.

Contains 48 full-size California job cases. Length, over all, 71 inches; depth, over all, 25 $\frac{1}{2}$ inches; height to lower edge of working bank, 43 inches; height, over all, 50 inches. Case numbers extra. Linolite Lamps extra. Label holders (as shown in cut) are extra. Price on application. Extra deep California job cases, with boxes $1\frac{1}{16}$ inch deep, furnished at advance on price of regular cases.

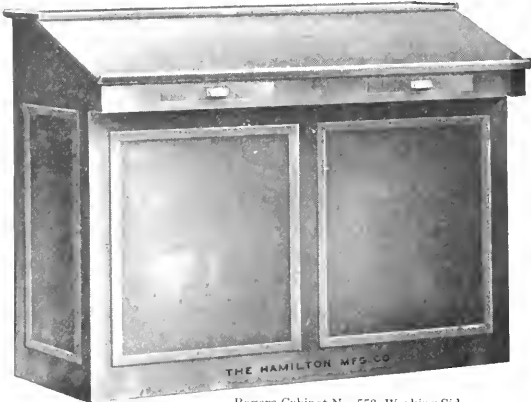

Rogers Cabinet No. 553, Working Side

Tracy Steel Cabinet No. 550

For those who do not object to having a working bank on the case side of a cabinet, the Tracy Cabinet will commend itself, all giving good facilities for bunching the maximum number of compositors in the least possible area. On the case side there is a working bank above the cases, which, however, serves a better purpose in being available for quarter-cases holding auxiliaries of all kinds, or brass rule cases, or special space and quad cases, bringing such material handy to the compositor in the alley and also to compositors stationed elsewhere who may have occasion to use the cases in the alley.

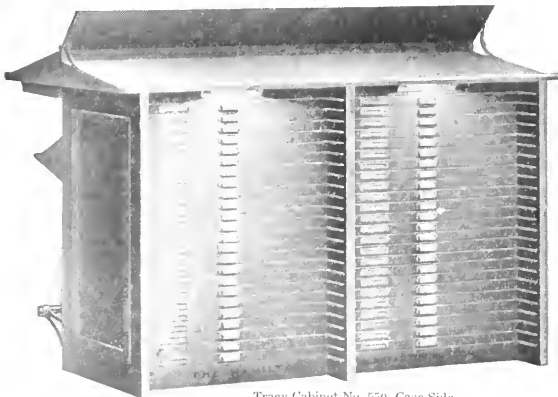

Tracy Cabinet No. 550, Case Side

On the working side there are three banks: a working bank, seventeen inches deep; a bank below the working bank, 8 $\frac{1}{2}$ inches deep, for holding cuts and other materials in use in the work immediately in hand; and (above the working bank) a bank 8 $\frac{1}{2}$ inches deep, suitable for holding a long lead and slug rack, or a long space and quad case, or quarter-cases filled with brass rule or auxiliary materials. There are also two capacious drawers and a round iron foot rail which tends to prevent fatigue.

The construction is strong and durable and attractive. The frame is made of heavy steel, the banks are of reinforced steel and the sides and ends of pressed steel. Color, olive green. Linolite Lamps, as described on page 1300, may be attached on brackets over the working banks above the case racks, as shown in illustration, if required. Label holders (as shown in cut) are extra.

Dimensions and Contents of Tracy Cabinet No. 550

Cases are of wood, with boxes $1\frac{1}{16}$ -inch deep, and with Steel Front Protectors and Bronzed Pulls.

Contains 48 full-size California job cases; length, 71 inches; depth, on floor, 21 $\frac{1}{2}$ inches; depth over all, 37 inches; height to lower edge of working bank, 43 inches; height over all, 54 inches. Foot rail extra. Linolite Lamps extra. Price on application. Extra deep California job cases, with boxes $1\frac{1}{16}$ -inch deep, furnished at advance on price of regular cases.

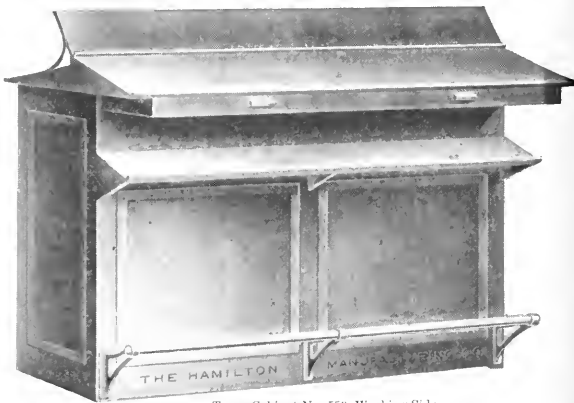

Tracy Cabinet No. 550, Working Side

Extension Front Steel Cabinets

Extension Front Cabinets are undoubtedly the most convenient and time-saving. Before the introduction of this style of cabinet it was necessary to add a clumsy, inconvenient rear extension to each cabinet case—an intolerable nuisance when it was desired to set from such cases on the tops of other cases, stands or cabinets. By extending the sides of cabinet and the case runs four inches as shown in the illustration, any case can be pulled out and every box in it exposed without removal from runs.

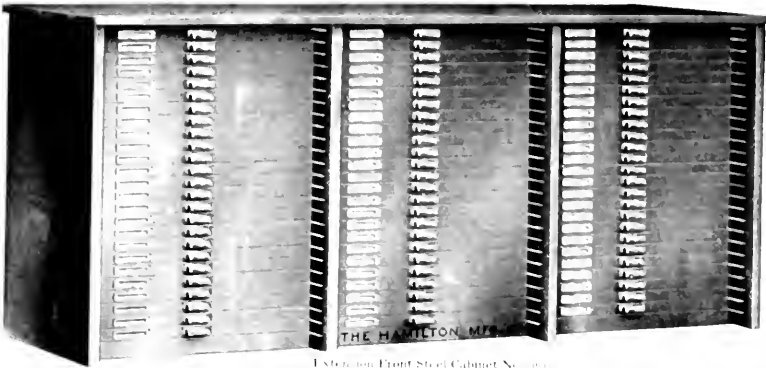

Extension Front Steel Cabinet No. 501

Further, if it is desired to set from a case which is either too high or too low to be conveniently reached, such case may be slipped into a convenient position between any of the runs and it will be held securely there by the extension of the runs, without removing the case already held between the same runs.

The construction is strong, durable and attractive. The frame and runs are of heavy steel, the top, sides and backs are of sheet steel, reinforced where required. For compactness these cabinets cannot be excelled. Color, olive green.

The cabinet illustrated here is correct height for utilizing the top of it for storing matter or material

or for attaching case brackets or steel sectional working tops. If required, any suitable case brackets shown in the illustration are extra. There are 21 full-size cases

in each tier. These cases have extra deep boxes, so that their type holding capacity is one-sixth more than that of regular full-size job cases. This increase of capacity is an important consideration to those printers who are realizing the economies derived from the purchase and the use of weight fonts of job type.



Extension Front Steel Cabinet No. 501



Extension Front Steel Cabinet No. 502

Contents and Dimensions of Extension Front Steel Cabinets

Cases are made of wood, with boxes $1\frac{1}{4}$ inch deep, and with Steel Front Protectors and Bronzed Palls.

No. 501, contains 25 full-size California job cases. Height, 43 inches; depth, 23 inches; width, $36\frac{1}{4}$ inches. See illustration.

No. 503, contains 50 full-size California job cases. Height, 43 inches; depth, 23 inches; width, $69\frac{1}{4}$ inches. See illustration.

No. 505, contains 50 full-size California job cases, in one tier. Height, $83\frac{1}{2}$ inches; depth, 23 inches; width, $36\frac{1}{4}$ inches.

No. 507, contains 75 full-size California job cases. Height, 43 inches; depth, 23 inches; width, $103\frac{1}{4}$ inches. See illustration.

Prices on application. Extra deep California job cases, with boxes $1\frac{1}{4}$ inch deep, furnished at advance on prices of regular depth cases.

Flush Front Steel Cabinets

The cases in these cabinets have extensions on the rear, so they may be pulled out, exposing all the boxes of the case, when it is desired to set from it without removing from the cabinet. The boxes in the cases in these and all steel cabinets are fifteen-sixteenths inch deep, giving them one-sixth greater type capacity than heretofore, without increasing the space occupied by the cases in the cabinet, the frames of the cases being of the same dimensions as those of regular cases. This is an important consideration to those printers who wish to realize the economical advantages derived both from purchasing and using weight fonts of job type.

The steel runs in the cabinets are incorporated with the inner steel lining, and are capable of sustaining extraordinary weights and strains. Strength in the frame is useless if the strength of the case runs is inadequate to several times the strain caused by the weight of a full case.

Label holders and numbers on cases are extra. The cabinets shown here are 43 inches high, and case and other working brackets and sectional working tops may be screwed on them, for which purpose holes are tapped in the steel tops.

The construction is strong, durable and attractive. The frame and runs are made of heavy steel; the top and sides and back are of sheet steel, reinforced where required. Color, olive green.



Flush Front Steel Cabinet No. 500

Contents and Dimensions of Flush Front Steel Cabinets

Cases are of wood, with boxes $1\frac{1}{4}$ inch deep, and have Steel Front Protectors and Bronzed Palls.

No. 500, contains 25 full-size California job cases. Height, 43 inches; depth, 23 inches; width, $36\frac{1}{4}$ inches.

No. 502, contains 50 full-size California job cases. Height, 43 inches; depth, 23 inches; width, $69\frac{1}{4}$ inches.

No. 506, contains 75 full-size California job cases, in three tiers. Height, 43 inches; depth, 23 inches; width, $103\frac{1}{4}$ inches.

Prices on application for above and other sizes. Extra deep California job cases, with boxes $1\frac{1}{4}$ inch deep, furnished at advance on price of regular depth cases.

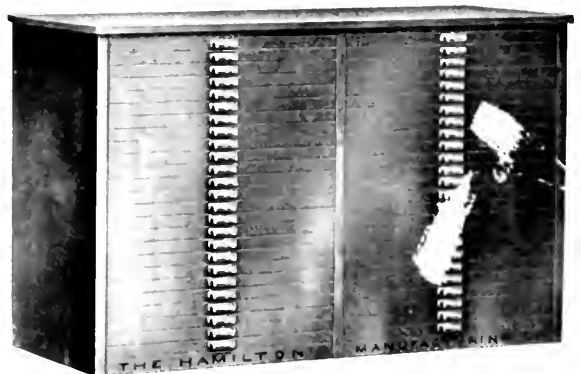

Flush Front Steel Cabinet No. 503

Mills Extra Strong Iron and Steel Case Cabinets

In addition to the irreducible minimum space occupied by these case stands or cabinets, they are the strongest and most durable made. The frame is made of extra heavy angle iron and the case runs are of heavy angle iron. The Working Bank and both Auxiliary Banks are made of steel, reinforced where necessary. The ends and back are of sheet steel. When a Contents Frame is added, it is made of steel. The color is olive green. As delivered the design will vary from that shown in the illustration, which is that of a cabinet of wooden construction.

The Mills Extra Strong Case Cabinets are sold with or without cases. When an office is being renovated it is not infrequently a desirable economy not only to save the cases in use but to save the cost of transferring type from old to new cases. The old cases can be cut out for finger holds by any local carpenter, and when transferred to these exceedingly strong, compact and attractive looking stands or cases the result is entirely satisfactory.

The illustration shows cabinet holding cases with regular fronts, which have been transferred from old style stands, and being placed close together, have been cut out at top and bottom of front rail, in centre, to afford finger holds for pulling out cases.

When this cabinet is ordered with cases, cabinet front California job cases are supplied, with boxes $1\frac{1}{4}$ -inch deep, with bronzed pulls, as usual in other cabinets.

A Contents Frame (shown at left of the lower illustration) is added as an extra. Two cards upon which are printed specimen lines of each font in the cabinet are placed in this frame, facing the general gangway, enabling compositors to locate fonts without entering the alleys.

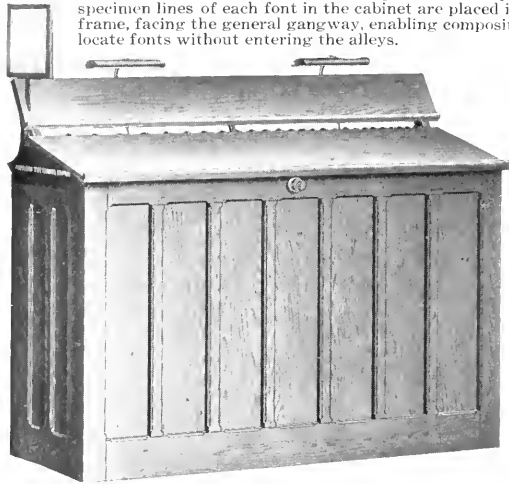

Mills Extra Strong Cabinet (working side) showing Auxiliary Bank, Linolite Lamps and Contents Frame

Single Cabinets occupy floor-space of $36\frac{1}{2} \times 20$ inches; depth over all, 24 inches; depth of Working Bank, 20 inches; depth of Auxiliary Bank, 9 inches; depth of Lead and Slug Bank, 8 inches; height to Working Bank, 44 inches; height over all, $56\frac{1}{4}$ inches. Double Cabinets occupy floor-space of 72×20 inches; depth over all, 24 inches; depth of Working Bank, 20 inches; depth of Auxiliary Bank, 9 inches; depth of Lead and Slug Bank, 8 inches; height to Working Bank, 44 inches; height over all $56\frac{1}{4}$ inches.

Capacity of Mills Extra Strong Case Cabinets. (Dimensions are given in two preceding paragraphs)

Single Mills Extra Strong Cabinet, with runs for 20 full-size regular front cases, but without cases.

Single Mills Extra Strong Cabinet, with 24 full-size cabinet front California job cases, with boxes $1\frac{1}{4}$ -inch deep, and bronzed pulls.

Double Mills Extra Strong Cabinet, with runs for 40 full-size regular front cases (as illustrated), but without cases.

Double Mills Extra Strong Cabinet, with 40 full-size cabinet front California job cases, with boxes $1\frac{1}{4}$ -inch deep, and bronzed pulls.

Contents Frame, Linolite Lamps, Lead and Slug Bank, Label Holders, and Case Numbers are extra.

Prices on application. California job cases, with extra deep ($1\frac{1}{4}$ -inch) boxes can be furnished, if desired, at an advance on price of regular cases. These cases occupy same space in runs as regular cases.

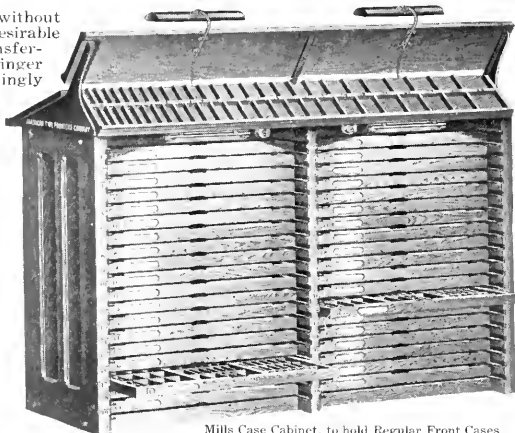

Mills Case Cabinet, to hold Regular Front Cases without pulls

On the working side there are a Working Bank and an Auxiliary Bank. On the latter, material for the work immediately in hand or quarter-cases holding auxiliary material of all kinds may be placed within easy reach. On the case side there is a bank on which leads and slugs are kept, convenient alike to compositors working in the alley or for compositors stationed elsewhere who enter the alley to use the cases.

The space occupied is the least possible that is required for holding and easily handling the cases. The runs project three inches beyond the cases, affording a secure hold when it is desired to set from them without removing them from their regular positions in the cabinet.

Special attention is invited to the method of lighting these stands or cabinets by means of Linolite Lamps, as shown in the illustrations. On a double stand or cabinet two Linolite Lamps are suspended on brackets over the Auxiliary Bank, on the working side, and two under the fore edge of the lead and slug case, on the case side, throwing light on any case that may be used to set from without removing from rack. These four Linolite Lamps are controlled by two switches, handily placed. (For description of the Linolite Lamps see page 1300.) Linolite Lamps are extra.

Extension Front Steel Case Stands

These stands are made to hold cases with regular fronts, such as body type pair cases; and they are recommended to those who, having an ample supply of regular cases, wish to discard old-fashioned and space-wasting case stands and racks, without being involved in the expense of new cases and the cost of transferring the type from the old to new cases. Case pulls may be applied to the old cases, or the front frames of the cases may be cut away in the center at top and bottom (as shown in the illustration above) to afford the necessary finger hold for pulling cases from the stand.

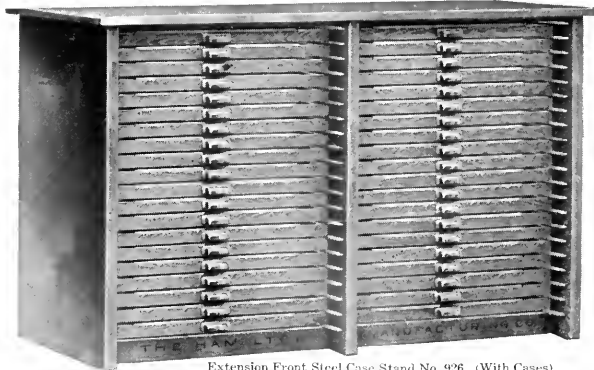

Extension Front Steel Case Stand No. 926. (With Cases)

The frame and runs extend four inches further than the cases, so that a case may be pulled out far enough to expose all the boxes, and type set from it, without removing it from the stand; or if it is desired to use a case which is too high or too low in the stand to set from with comfort, such case may be transferred to any other run in stand, and be securely held by projection.

Any style of iron bracket for holding cases, etc., or any style of working top manufactured by us, may be attached to the top of Case Stands Nos. 925, 926, and 928, which are all 43 inches high. The tops of these three stands are tapped with holes in which to screw the working tops.

As the sides and backs of these cabinets are of pressed steel, they are as dust proof as cabinets, except for the openings between the fronts of the cases.

The construction is strong, durable and attractive. The frame and interior supports are made of heavy steel; the top of reinforced steel; and the sides and back of pressed steel. Color, olive green.

Capacity and Dimensions of Extension Front Steel Case Stands

No. 925, to hold 20 full size-regular front cases in one tier; floor space, $21\frac{1}{2} \times 35$ inches; height, 43 inches.

No. 926, to hold 40 full-size regular front cases in two tiers (see illustration); floor space, $21\frac{1}{2} \times 69\frac{3}{4}$ inches; height, 43 inches.

No. 927, to hold 40 full-size regular front cases in one tier; floor space, $21\frac{1}{2} \times 35$ inches; height, $83\frac{1}{4}$ inches.

No. 928, to hold 60 full-size regular front cases in three tiers; floor space, $21\frac{1}{2} \times 103\frac{1}{4}$ inches; height, 43 inches.

Prices for above case stands on application. Cases not included unless separately ordered.

Mills Iron and Steel Head Letter Case Cabinets

This case cabinet is appreciated in the lively newspaper plants, in several of which it has proved to be very practical. If necessary (on a double Mills Case Cabinet) four cases may be put into convenient positions to set from, when a head contains four kinds of type-

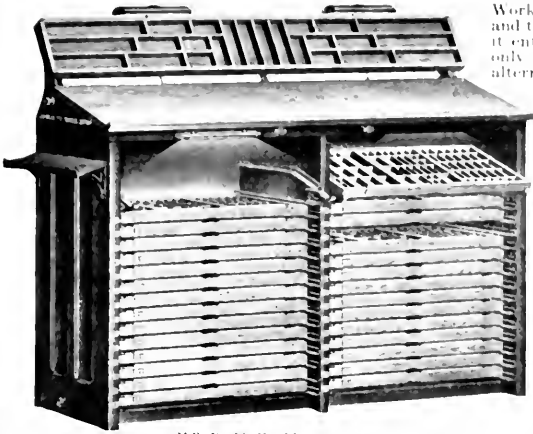

Mills Double Head Letter Cabinet, to hold 28 full size cases, and showing positions of Linolite Lamps

The space occupied is the least possible that is required for storing and the easy handling of the cases. The runs project three inches beyond the cases, affording a secure hold when it is desired to set from them without removing them from their regular positions in the cabinet.

The back of the cabinet and the Auxiliary Bank are flush, and may be set in close contact with a wall or another piece of furniture without wasting any space.

Special attention is invited to the method of lighting these cabinets by means of four Linolite Lamps, two on brackets overhanging the Auxiliary Bank and two located under the fore edge of Working Bank (as shown in illustration), lighting the cases on the brackets or in the racks. Linolite Lamps are controlled by switches, placed in handy positions on the cabinet. (For description of Linolite Lamps see page 1300).

Capacity and Dimensions of Mills Head Letter Case Cabinets

Single, to hold 14 full-size California job cases. Length, 39 $\frac{1}{2}$ inches; depth on floor, 20 inches; depth over all, 24 inches; depth of full length Working Bank, 20 inches; depth of full length Auxiliary Bank, 9 inches; height to Working Bank, 44 inches; height over all, 56 $\frac{1}{4}$ inches.

Double, to hold 28 full size California job cases. Length, 72 inches; depth on floor, 20 inches; depth over all, 24 inches; depth of full length Working Bank, 20 inches; depth of full length Auxiliary Bank, 9 inches; height to Working Bank, 44 inches; height over all, 56 $\frac{1}{4}$ inches.

Linolite Lamps and Case Numbers extra. Prices on application. Cases are not included unless separately ordered.

Steel Cut Cabinets, with Steel Cases

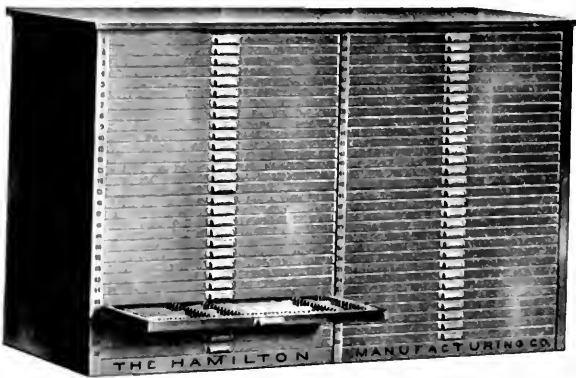

Steel Cut Cabinet No. 514A

Contents and Dimensions of Flush Front Cut Cabinets

- No. 510, with 30 plain cases; floor space, 21 $\frac{1}{2}$ x35 inches; height, 43 inches.
- No. 510A, with 30 indexed cases; floor space, 21 $\frac{1}{2}$ x35 inches; height, 43 inches. See illustration.
- No. 512, with 50 plain cases; floor space, 21 $\frac{1}{2}$ x35 inches; height, 72 inches.
- No. 512A, with 50 indexed cases; floor space, 21 $\frac{1}{2}$ x35 inches; height, 72 inches.
- No. 514, with 60 plain cases, in two tiers; floor space, 21 $\frac{1}{2}$ x69 $\frac{1}{4}$ inches; height, 43 inches.
- No. 514A, with 60 indexed cases, in two tiers; floor space, 21 $\frac{1}{2}$ x69 $\frac{1}{4}$ inches; length, 43 inches. See illustration.
- No. 516, with 90 plain cases, in three tiers; floor space, 21 $\frac{1}{2}$ x103 $\frac{1}{4}$ inches; height, 43 inches.
- No. 516A, with 90 indexed cases, in three tiers; floor space, 21 $\frac{1}{2}$ x103 $\frac{1}{4}$ inches; height, 43 inches.

Contents and Dimensions of Extension Front Cut Cabinets

- No. 511, with 30 plain cases; floor space, 21 $\frac{1}{2}$ x35 inches; height, 43 inches.
- No. 511A, with 30 indexed cases, floor space, 21 $\frac{1}{2}$ x35 inches; height, 43 inches. See illustration.
- No. 513, with 50 plain cases; floor space, 21 $\frac{1}{2}$ x35 inches; height, 72 inches.
- No. 513A, with 50 indexed cases; floor space, 21 $\frac{1}{2}$ x35 inches; height, 72 inches.
- No. 515, with 60 plain cases, in two tiers; floor space, 21 $\frac{1}{2}$ x69 $\frac{1}{4}$ inches; height, 43 inches.
- No. 515A, with 60 indexed cases, in two tiers; floor space, 21 $\frac{1}{2}$ x69 $\frac{1}{4}$ inches; height, 43 inches.
- No. 517, with 90 plain cases, in three tiers; floor space, 21 $\frac{1}{2}$ x103 $\frac{1}{4}$ inches; height, 43 inches.
- No. 517A, with 90 indexed cases, in three tiers; floor space, 21 $\frac{1}{2}$ x103 $\frac{1}{4}$ inches; height, 43 inches. Prices on application.

These are the first all-steel cut cabinets ever made, and commend themselves on account of being more compact and space-saving than any other cut cabinets heretofore made, as well as minimizing the danger of loss by fire and by dust.

These cabinets are made with flush fronts (as illustrated) and also with extension fronts, and may be purchased with Indexed Steel Cut Cases or Plain (Blank) Steel Cases.

Cases in flush front cabinets have four-inch projections in rear, to hold cases securely on the runs when drawn out to expose all the contents. These rear projections are not required where the cabinets have projecting fronts, as described on page 1287.

Indexed Cut Cases are illustrated on page 1248 of this catalogue. To those who insist upon systematic care of cuts these Indexed Cut Cases are indispensable.

The construction is strong, durable and attractive. The frames and top and partitions are of reinforced steel. The cases are of heavy steel, capable of sustaining all the weight of metal-body cuts that can be placed in them. The backs are of pressed steel. Color, olive green.

Cases are all steel, with bronzed pulls, full size, 32 $\frac{1}{4}$ x16 $\frac{1}{2}$ inches over all. Case numbers and an indexed cut catalogue are included with cabinets containing indexed cases. Case numbers are extra when ordered with cabinets containing plain cases.



Steel Cut Cabinet No. 510A

American Steel and Iron Newspaper Make-up Tables

In the larger and livelier newspaper plants the American Make-up Tables are superseding make-up tables on trucks because they undoubtedly afford facilities for quicker and more systematic work. In addition to their time-, labor- and space-saving merits, the construction is massive, giving unexcelled strength, rigidity and durability, withstanding the hardest usage.

This style of long make-up tables was first designed by Messrs. Oviatt and Clark, of the *New York American*, and first used on that newspaper, hence the name "American."

American Make-up Tables are made to order to any size desired, and with such disposition of the space under the table as may best meet the special requirements of each newspaper. The utilization of this space should be a matter of careful study, and the Efficiency Department (see pages 36, 37) of the American Type Founders Company is prepared to furnish suggestions based upon the experience of the majority of the leading newspaper plants using American Make-up Tables.

Two illustrations of American Make-up Tables now in use are shown on this page, and each is more particularly described within the half-tone. Each table is twelve feet long. Attention is invited to the number of substantial supports upon which the iron top rests. These are necessary, owing to the tendency of very heavy iron tops to spring. An unstable make-up surface is an intolerable

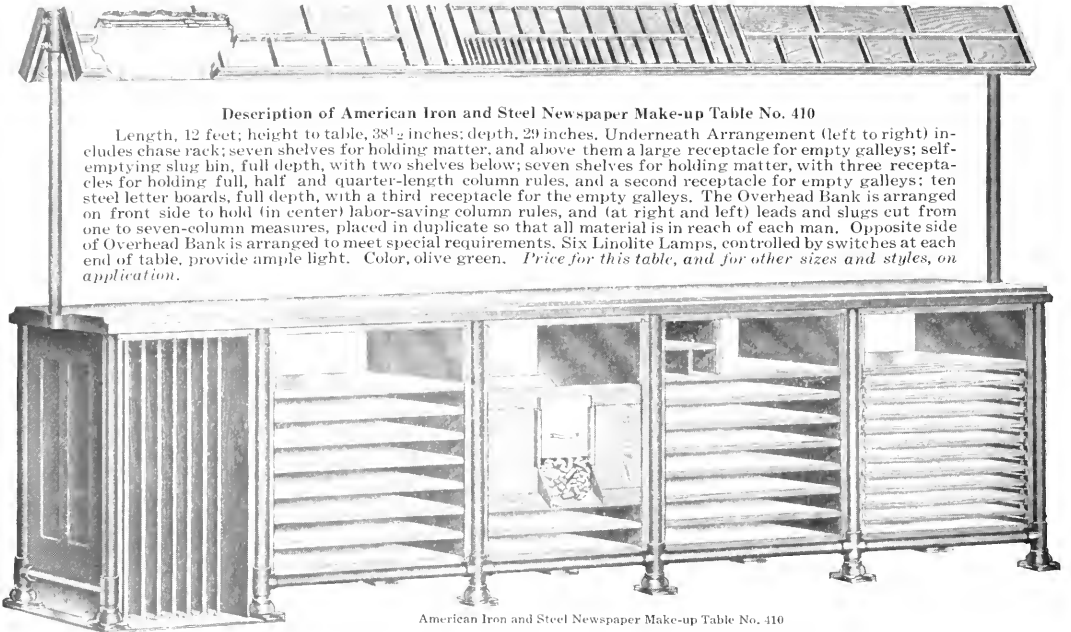

Description of American Iron and Steel Newspaper Make-up Table No. 410

Length, 12 feet; height to table, 38½ inches; depth, 29 inches. Underneath Arrangement (left to right) includes chase rack; seven shelves for holding matter, and above them a large receptacle for empty galleys; self-emptying slug bin, full depth, with two shelves below; seven shelves for holding matter, with three receptacles for holding full, half and quarter-length column rules, and a second receptacle for empty galleys; ten steel letter boards, full depth, with a third receptacle for the empty galleys. The Overhead Bank is arranged on front side to hold (in center) labor-saving column rules, and (at right and left) leads and slugs cut from one to seven-column measures, placed in duplicate so that all material is in reach of each man. Opposite side of Overhead Bank is arranged to meet special requirements. Six Linolite Lamps, controlled by switches at each end of table, provide ample light. Color, olive green. Price for this table, and for other sizes and styles, on application.

American Iron and Steel Newspaper Make-up Table No. 410

nuisance. In selecting make-up tables following the idea original with Messrs. Oviatt and Clark, of the *New York American*, the matter of the number of supports is of great importance. No matter how much their omission may reduce the selling price, it is economy to buy tables having as many of them as the underneath arrangement will permit.

In the illustrations the Overhead Banks rest on iron supports at either end. In practice a twelve-foot Overhead Bank is supported in the center by a chain or wire from the ceiling. Any center support resting upon the make-up surface is to be avoided, as it materially interferes with the free use of the table. When desired the Overhead Bank is made by us to be suspended rigidly from the ceiling, which is the better method where practicable.

The lighting of the American Make-up Tables is perfectly done by means of Linolite Lamps (described on page 1300), and the

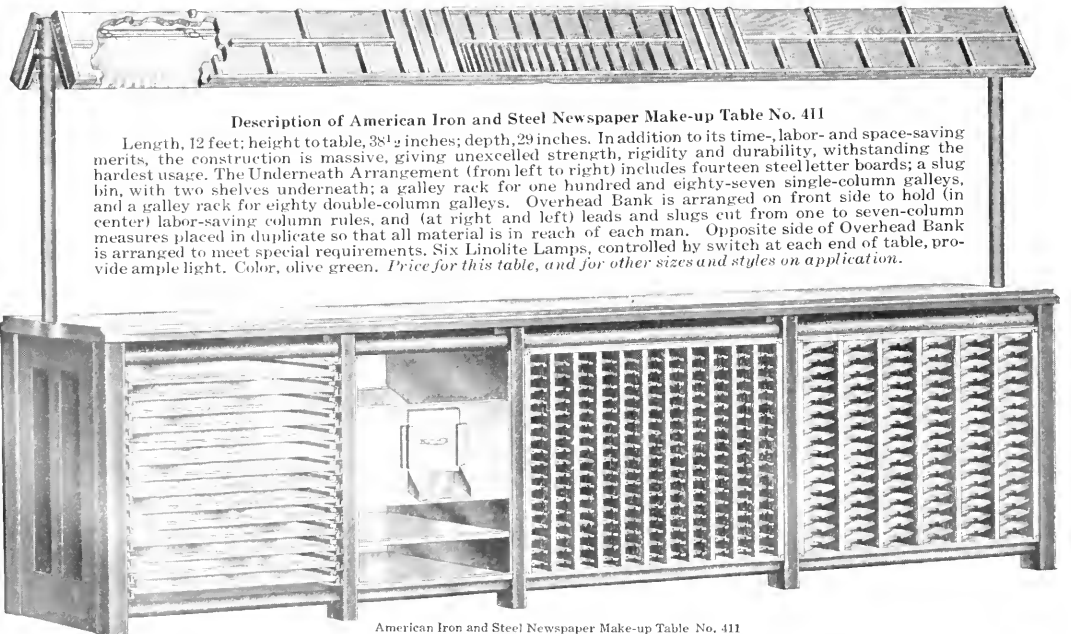

Description of American Iron and Steel Newspaper Make-up Table No. 411

Length, 12 feet; height to table, 38½ inches; depth, 29 inches. In addition to its time-, labor- and space-saving merits, the construction is massive, giving unexcelled strength, rigidity and durability, withstanding the hardest usage. The Underneath Arrangement (from left to right) includes fourteen steel letter boards; a slug bin, with two shelves underneath; a galley rack for one hundred and eighty-seven single-column galleys, and a galley rack for eighty double-column galleys. Overhead Bank is arranged on front side to hold (in center) labor-saving column rules, and (at right and left) leads and slugs cut from one to seven-column measures placed in duplicate so that all material is in reach of each man. Opposite side of Overhead Bank is arranged to meet special requirements. Six Linolite Lamps, controlled by switch at each end of table, provide ample light. Color, olive green. Price for this table, and for other sizes and styles on application.

American Iron and Steel Newspaper Make-up Table No. 411

American Iron and Steel Make-up Newspaper Tables (Continued)

under sides of of the Overhead Banks are treated to reflect the light. The arrangement of Overhead Banks may be changed to suit local conditions. The Overhead Banks illustrated on preceding page are arranged to hold leads and slugs cut to 1, 2, 3, 4, 5, 6 and 7-foot column lengths and labor-saving column rules.

In the illustrations, bins for receiving dead slugs are shown; these are self-emptying into metal trucks, when the trap doors are raised. Some American Make-up Tables are made to receive metal trucks, under the tables, into which the dead slugs are thrown direct. As a rule we advise against putting drawers in make-up tables. They almost invariably become harbors for all sort of materials which should not be in them, but they can be added when desired.

An important detail in our American Make-up Table is the rigidity of all letter and form shelves. Metal has more spring than wood, and in selecting a make-up table or any other piece of furniture containing letter and form shelves it will be profitable to look closely into this matter. A letter or form shelf which is not rigid is a constant source of annoyance and delay.

Specifications of two styles of these tables are printed on within each illustration, on preceding page.

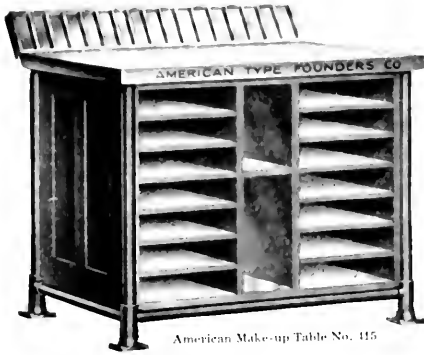

American Make-up Table No. 415

American Make-up Tables

These have proved very practical, especially when used in connection with Make-up Trucks. They can be furnished in any length, and the Underneath Arrangement may be varied to suit special conditions.

The table illustrated here has an iron top, supported in a strong iron frame. The fourteen galley shelves, the three galley bins (on center and both ends) and the back are made of pressed sheet steel, reinforced where required. The Bank at the back is divided to hold the various lengths of leads and slugs commonly used on the publication. Linolite Lamps may be suspended over the Bank. Color, olive green.

Dimensions of American Make-up Table No. 415

Length, 48 ins.; depth, 28 ins.; height, 38½ ins. Linolite Lamps extra, if required. Prices for this table and for other lengths and styles on application.

American Steel and Iron Linotype Correcting Tables

In the larger plants it is desirable to use separate correcting tables. The American Correcting Table, No. 420, illustrated here, has been found very practical in a number of plants. This style of table can be furnished to order in any length, and the Underneath Arrangement may be varied.

There are two openings in the top of the table; that at the left is for take slugs, which drop into the drawer below; that near the centre is for dead slugs, which fall into a large self-emptying dead slug bin built in the form of a chute, and closed by a trap door. These tables are also made with dead slug trucks which are placed under the opening in the tables.

The construction is designed to resist the hardest usage and maintain a good appearance. The top is of reinforced steel, supported by substantial iron legs, rigidly braced. The take slug drawer, dead slug bin and both ends are of steel. The ten shelves for holding loaded galleys are of reinforced steel. Color, olive green.

An overhead Linolite lighting arrangement may be added, if required, and is frequently desirable.

Dimensions of American Correcting Table No. 420

Length, 84 ins.; depth, 28 ins.; height, 38½ ins. Prices for this table and for other lengths and styles on application.

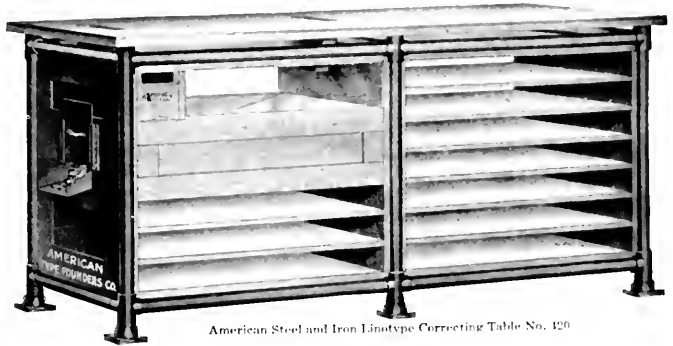

American Steel and Iron Linotype Correcting Table No. 420

American Galley Receiving and Storage Tables

These are made to any size, and the Underneath Arrangement may be varied. The table illustrated here is in use in several plants, and is very practical. The top is of reinforced steel, supported by a strong iron frame. The seven galley shelves are of reinforced steel; the three galley bins and the three galley racks (two for single and one for double-column galleys) and both ends are made of sheet steel. Color, olive green.

Dimensions of American Galley Receiving and Storage Table No. 422

Length, 60 ins.; depth, 26 ins.; height, 38½ ins. Prices for this table and for other sizes and styles will be quoted on application.

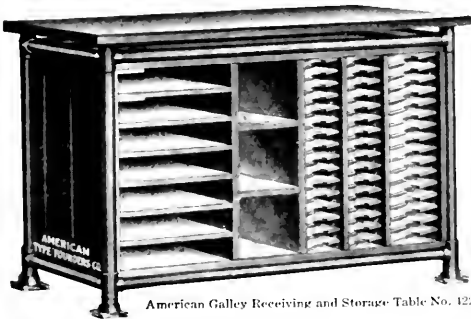

American Galley Receiving and Storage Table No. 422

American Steel Dumping Tables

The top is 72x25¼ inches, made of heavy leveled steel, with tubular steel cleats for supporting galleys at necessary angle.

The take slug rack, held on brackets at rear of table, is of steel, and is (as shown in illustration) divided for single and double column measures, but may be divided to suit any special requirements.

The Underneath Arrangement includes (left to right), 3 steel drawers, each 22x22½x37½ inches; 3 steel bins for holding empty galleys; 3 tiers of steel shelves for holding 51 double column galleys; and 13 reinforced steel shelves for storing loaded galleys.

The construction is strong, durable, and attractive. The ends and all supports are of double steel in tubular construction, and the back is of pressed steel. Color, olive green.

Dimensions of American Dumping Bank No. 800

Length, 72 inches; depth, 25¼ inches; height to working top, 38½ inches; height over all, 49 inches; size of take slug rack, 9x72 inches; size of galley bins, 20¾x24x8½ inches; size of galley storage shelves, 21x24 inches; size of drawers, 22x22½x37½ inches. Price for this table and for tables of other lengths and styles on application.

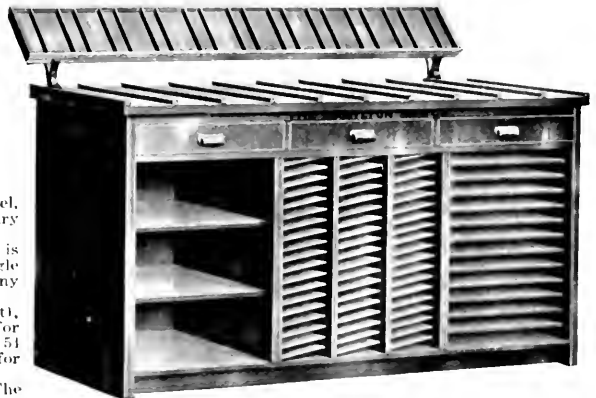

American Dumping Table No. 800

American Combination Dumping and Correcting Tables

For plants using about ten machines or less these combination tables are very practical and convenient. They are made with a variety of Underneath Arrangements to suit special conditions in composing rooms.

On the dumping side, metal cleats are secured to the reinforced steel top to support galleys. On the correcting side there is an opening in the reinforced steel top of table through which dead slugs drop into a self-emptying slug bin, made of steel, built in the form of a chute, and closed with a trap door. Some of these tables are built to accommodate a metal dumping truck under the opening in the top, instead of the slug bin.

The Overhead Bank is usually divided on the correcting side for leads on one side and leads and take slugs on the other, but this arrangement can be varied to meet special conditions. The metal brace-bar above the Overhead Bank has copy hooks on both sides.

These tables are furnished (if required) with Linolite Lamps under Overhead Bank, the bank acting as a reflector and protecting the eyes from the glare. This is the best method of lighting now in use. It is described on page 1300. When Linolite Lamps are furnished they are attached and wired for connection.

The construction of this table is the best for the exceptional wear and tear of newspaper plants. The frame is made of one and a quarter inch iron pipe, the top and shelves and bins of reinforced steel, the Overhead Bank of heavy steel, and the ends of pressed steel. Nothing short of sledge hammer blows will injure equipments constructed in this manner.

In the table illustrated, No. 450, the Underneath Arrangement includes, on the correcting side (left to right), a steel self-emptying slug bin, and three bins for dead galleys and twelve shelves for matter, all of reinforced steel. On the dumping side there are steel bins for quoins and sidesticks, and two bins for dead galleys, and eight shelves, all of reinforced steel. The color is olive green.

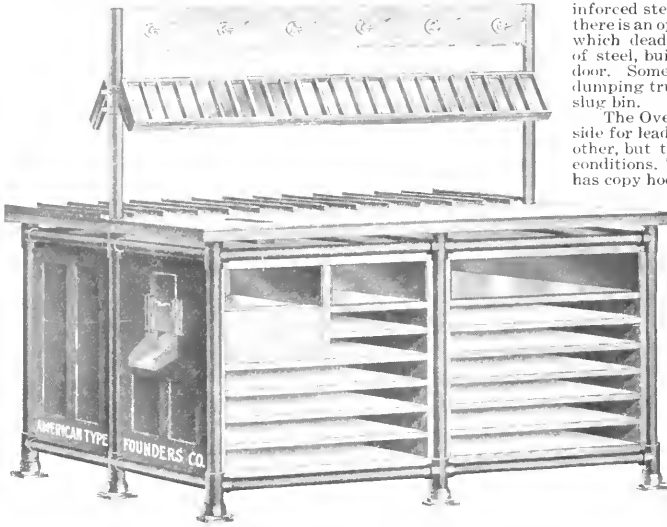

American Combination Dumping and Correcting Table No. 450

Description of American Combination Dumping and Correcting Table No. 450

Length, 72 inches; depth, 54 inches; height to top of table, 38½ inches; height to copy hook bar, 68 inches. Linolite Lamps extra. Prices for this table and for other sizes and styles on application.

American Iron and Steel Dumping Banks

These Banks are practically indestructible. They are built any desired length, and the bank proper, take slug rack and Underneath Arrangement can be varied to meet special conditions in the composing room.

The frame is of one and one-quarter inch pipe, the top is made of sheet brass, with brass dividing strips, the take slug rack and copy hook bar are made of steel. The ends are of sheet steel.

Particular attention is invited to the thorough support (consisting of five pairs of legs) provided for this bank. The cost would be considerably decreased by lessening this support, but when fully loaded these banks carry tons of weight, and in tables less well supported the bank itself and the storage shelves will sag and get out of line and gradually rack themselves to pieces. The manufacturers would very willingly reduce the cost of manufacture if it could be done without ultimate injury to the buyer's best interests.

These banks are also made to order, with removable letter boards, or galley racks, or blank steel cases for storing cuts, or page storage galleys, underneath the bank. In short, the Underneath Arrangements and the longitudinal divisions of the bank itself should be made to conform to the special conditions of each composing room. Linolite Lamps (as described on page 1300) may be placed on brackets and suspended over the bank. If the special conditions of a printing plant are detailed to the designers of the Efficiency Department of this Company, they will submit drawings showing such rearrangements of the bank here illustrated as may best meet the requirements of the buyer.

The Underneath Arrangement of the table illustrated here has three long steel-lined receptacles for holding dead galleys, three steel bins for holding quoins and sidesticks, and twenty shelves for storing matter, all made of reinforced steel.

Dimensions of American Dumping Bank No. 430

Length, 12 feet; depth, 22 inches; height to lower edge of bank, 42 inches; height to lower edge of take slug rack, 48 inches; height to copy hook bars, 67 inches; shelves, 26x21¾ inches. Linolite Lamps extra, if required. Prices for this bank and for other sizes and styles on application.

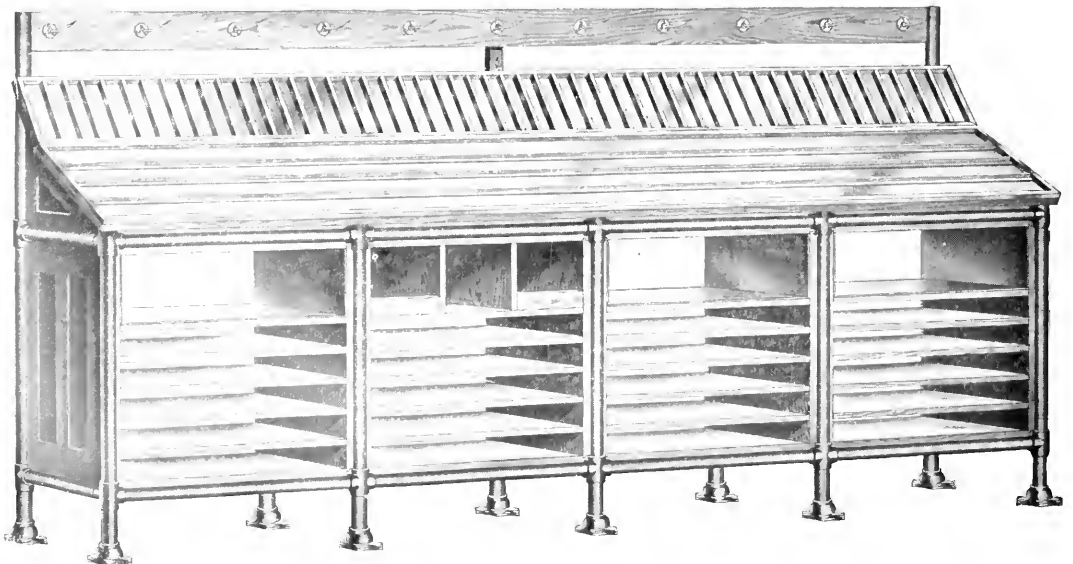

American Dumping Bank No. 430

Hamilton Steel Make-up and Storage Table No. 801

These tables are very practical for making-up the more intricate pages, such as Sunday edition matter. The make-up may have all the required matter under the table, including advertisements. These tables can be made any length and with Underneath Arrangements to suit special conditions.

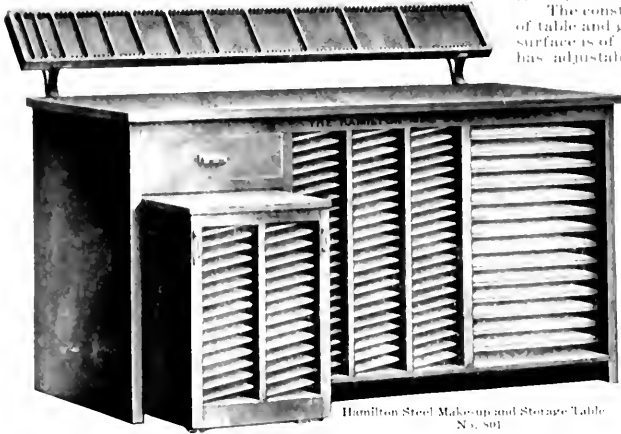

Hamilton Steel Make-up and Storage Table No. 801

The construction is not only very strong, but is attractive. Frames of table and galley truck are of heavy steel, rigid and stable. The top surface is of steel. The bank is nine inches by seventy-two inches, and has adjustable division for bars, slugs, rules, etc., and is made of steel, brass-lined. The ends, back and drawer are of sheet steel. The galley shelves and the stationary storage shelves are of steel, properly reinforced. Color, olive green.

The Underneath Arrangement of the table here illustrated has (left to right) a drawer, a movable Galley Truck by means of which live or dead matter is conveyed quickly and easily in a wholesale manner from or to any department of a composing room, three tiers of double-column galley shelves, each holding eighteen galleys, fifty-four in all; and fifteen storage shelves. Linolite Lamps (described on page 1390) may be added on brackets overhanging the bank, if desired.

Dimensions of Hamilton Make-up and Storage Table No. 801

Length, 72 inches; depth, 25 $\frac{1}{4}$ inches over all; height to iron top, 38 $\frac{1}{2}$ inches; height to top of bank, 49 inches; galley shelves accommodate double-column galleys; storage shelves, 21 inches wide and 21 inches deep; drawer, 51 x 19 $\frac{1}{2}$ x 22 $\frac{1}{2}$ inches over all; overhead bank, 9 inches by 72 inches. Linolite Lamps extra. *Prices of this and other sizes and styles on application.*

Hamilton Steel Linotype Correcting Table No. 802

Flat tables are generally preferred for correcting linotype matter. No one style of Underneath Arrangement can meet all conditions, but for many plants this table will be found practical and effective. Another style is illustrated on page 1291.



American Linotype Correcting Table No. 802

The top is 72 x 25 $\frac{1}{4}$ inches, made of heavy levelled steel, with an opening through which dead slugs are conveyed through a chute into a self-dumping metal truck.

The take slug rack, held on brackets at rear of table, is made of steel, and is (as shown in the illustration) divided for single and double column measures, but may be divided to suit any special requirements.

The Underneath Arrangement includes (left to right) 3 steel drawers, each 22 x 22 $\frac{1}{2}$ x 37 $\frac{1}{2}$ inches; 3 tiers of steel shelves for holding 51 double column galleys; a recess to accommodate a Hamilton Self-Dumping Metal Truck (described fully on page 1299); and 13 reinforced steel shelves for holding loaded galleys.

The construction is strong, durable and attractive. The ends and all supports are of double steel or tubular construction; the top and the storage shelves are of reinforced steel; the slug rack, back, drawers and galley shelves are of pressed steel. Color, olive green.

This table may be purchased with or without the Hamilton Self-Dumping Metal Truck.

Dimensions of American Linotype Correcting Table No. 802

Length, 72 inches; depth, 25 $\frac{1}{4}$ inches; height to working top, 38 $\frac{1}{2}$ inches; height over all, 49 inches; size of take slug rack, 9 x 72 inches; size of galley storage shelves, 21 x 21 inches; size of drawers, 22 x 22 $\frac{1}{2}$ x 37 $\frac{1}{2}$ inches. *Prices for this table and for Hamilton Self-Dumping Metal Truck on application.*

American All-Iron Make-up or Transfer Trucks



American Three-Leg Make-up or Transfer Truck

Two styles are offered, each style at same prices. The strength, rigidity and stability of these trucks are unexcelled. They are practically indestructible. The swivel ball-bearing castors run easily and are easily guided. The Three-Leg Make-up or Transfer Trucks are more easily guided than any four-leg trucks. All trucks, unless otherwise ordered, are made 38 $\frac{1}{2}$ inches high.

In ordering it is necessary to state whether three- or four-leg trucks are required.



American Four-Leg Make-up or Transfer Truck

Dimensions and List Prices of American Three-Leg and Four-Leg Make-up or Transfer Trucks

Any 6-column size (standard size, 29 $\frac{1}{2}$ x 26 $\frac{1}{2}$ inches) . . .	\$10 00	Any 8-column size (standard size, 25 $\frac{1}{4}$ x 30 $\frac{1}{2}$ inches) . . .	\$48 00
Any 7-column size (standard size, 23 $\frac{1}{2}$ x 28 $\frac{1}{2}$ inches) . . .	14 00	Any 9-column size (standard size, 27 $\frac{1}{2}$ x 32 $\frac{1}{2}$ inches) . . .	52 00

Other sizes made at proportionate prices

Hamilton Steel and Iron Imposing Table No. 726

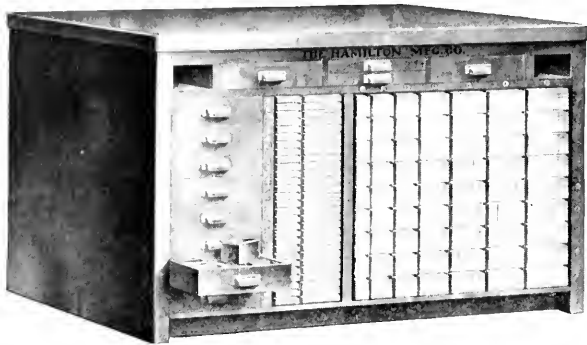

Hamilton Imposing Table No. 726 (see also view below)

consisting of 1260 pieces assorted in widths as follows: Twenty-four each of 2- and 3-line; twenty each of 4-, 5-, and 6-line; sixteen each of 8- and 10-line, all widths cut to lengths of 12, 18, 24, 30, 36, 42, 48, 54 and 60 picas; and a font of labor-saving reglet consisting of 2072 pieces, half six and half twelve point, cut to lengths of 12, 13, 14, 15, 16, 17, 18, 19, 20, 21, 22, 23, 24, 25, 26, 27, 30, 33, 36, 39, 42, 45, 48, 51, 54, 57 and 60 picas. *Price on application.*

General Merits of the Hamilton Imposing Table No. 726.

The steel and iron construction is not only stylish, but is easily kept clean and bright looking, and it also keeps the contents of the table clean. In printing offices the product is not acceptable if not clean; and it is a marvel how work is delivered in a clean condition, notwithstanding the unclean condition of some printing plants. Where the equipments and premises are not kept clean there is an inevitable increase of expense in getting the work delivered in a clean condition. The general movement toward profit-making efficiency will bring about a greater degree of cleanliness in all departments of the printing plant, and steel and iron constructions such as this Hamilton Imposing Table are aids to such increased cleanly efficiency.

Of course, all the steel and iron imposing tables have iron surfaces. Iron tops are ever so much better, smoother and more level, and will outlast marble twenty to one.

In commercial plants a supply of labor-saving wood furniture and labor-saving reglet under the table is especially economical.

The particularly labor-saving feature of the sort drawers shown in the upper illustration is found in the removable steel sort boxes, one for each character, each of which may be lifted out and easily filled or emptied.

The Underneath Arrangement of this table, as here shown in two illustrations, is remarkably comprehensive, convenient and labor-saving for commercial printing plants. The construction is very strong and durable, as well as attractive. The frame and chase racks are of heavy steel; the top of heavy iron; drawers of pressed steel; the removable letter boards, galley shelves and blank cases are of steel, reinforced where required to sustain heavy weights. Color, olive green.

Dimensions and Contents of Hamilton Imposing Table No. 726

Length, 63 inches; depth, 39 inches; height, 38½ inches. Fifteen removable letter boards, each 21¾ inches deep and 27½ inches long; two chase racks, one holding six chases, 10¼x14½ inches over all or smaller, the other holding six chases 14½x16½ inches over all or smaller; twenty blank cases for cuts, etc., each 21¾x16½ inches over all; eight drawers for sundries (immediately under the top), four on each side, four being 3¾ inches deep and four 1½ inches deep; eight sort drawers, each 17¾ inches long, 12¾ inches wide, and 3¼ inches deep, all fitted with removable pressed steel sort boxes (as shown in illustration); a font of labor-saving wood furniture,

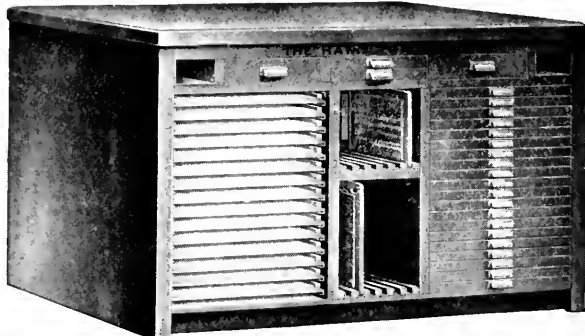

Hamilton Imposing Table No. 726 (another view)

Steel and Iron Imposing and Storage Table No. 725

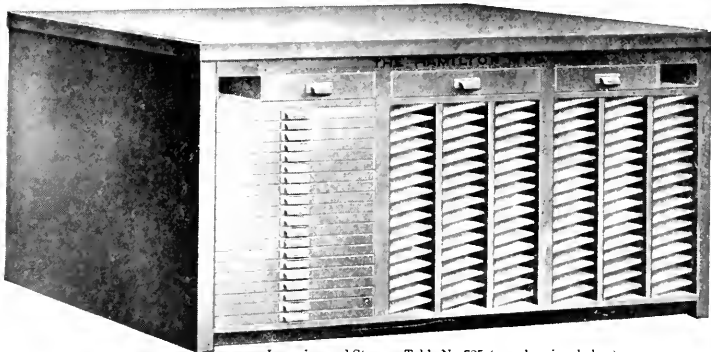

Imposing and Storage Table No. 725 (see also view below)

This very serviceable and capacious table is shown in two illustrations. The construction is strong, durable and attractive. The frame is made of heavy steel, the top is of heavy iron, and the drawers, galley shelves, blank cases and removable letter boards are of steel, reinforced where required to sustain heavy weights. Color, olive green.

Dimensions and Contents of Imposing and Storage Table No. 725

Length, 75 inches; depth, 51 inches; height, 38½ inches. There are forty-five letter boards, each 22½ inches wide and 20½ inches deep over all, giving a storage area of 350 square feet; twenty blank cases for cuts, etc., each 22¾ inches wide and 21½ inches deep; six large drawers (three on each side); and shelves for ninety-six double-column full-length galleys. *Price on application.*

There can be no question that for much matter so stored is alive,

whether dead or alive, the most convenient place for storing it is under an imposing table. If the matter so stored is alive, it is just where it can be quickly and easily lifted to the surface for locking up. If the matter so stored is dead, it is lifted (after unlocking) from the surface to the shelves quickly and easily.

In breaking up forms on the imposing surface, any cuts or electrotypes therein are quickly and easily transferred to the blank steel cases.

When paged matter is made up on galleys, and tied up, two or more pages on a galley, the most convenient place to store them, ready for locking-up, is under the imposing table.

The six drawers afford the means of separating the various materials used by the stoneman, and enable him to have adequate supplies on each side of the table.

The four recesses, one at each corner, are suitable for holding mallets, planers, quoins, straight edges, and other appliances in constant use on imposing tables.

The use of steel letter boards makes it possible to put more of them in a given space than is possible when wood is used.

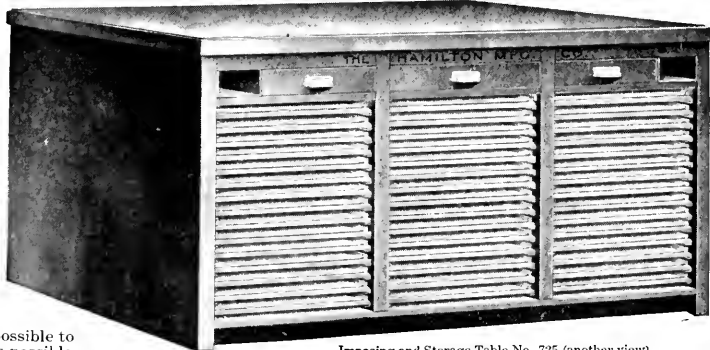

Imposing and Storage Table No. 725 (another view)

Mills Extra Strong Iron and Steel Imposing Tables

These are designed for use in the larger book and periodical plants, and are exceptionally strong and durable. There are two useful minor but characteristic features peculiar to these tables; at one end there are three bins for holding mallets, planers, benzine can, etc., and at the other end there is a receptacle (full depth of the table) for holding quoms and quom keys.

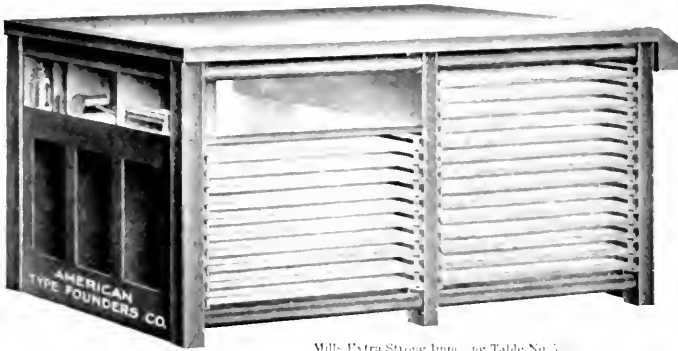

Mills Extra Strong Imposing Table No. 703

48 inches; height, 38½ inches. Price for this table and for tables of other lengths on application. As delivered the design of this table will differ somewhat from illustration.

Steel and Iron Imposing Table No. 717

In many plants the Underneath Arrangement of imposing tables is best utilized for storing live or dead matter on removable letter shelves. This table has the maximum storage capacity possible in its area.

There are four tiers of heavy steel letter boards, two on each side, and each has 15 shelves, or 60 removable letter boards in all, affording a storage area of 230 square feet. There are also four capacious drawers, two on each side. The recesses at sides of the drawers are useful for holding mallets, planers, quoin keys, etc.

The construction is strong, durable and attractive. The frame is made of heavy steel, the top is of heavy iron, the drawers of sheet steel, and the removable letter shelves are of reinforced steel. Color, olive green.

Dimensions of Hamilton Imposing Table No. 717

Length, 63 inches; depth, 51 inches; height, 38½ inches. Price on application.



Hamilton Imposing Table No. 717

Steel and Iron Imposing Tables With Storage Trucks

The special feature of this style of table is that the Underneath Arrangement is movable, consisting of four trucks, two holding removable letter boards and two holding galley cabinets. By means of these trucks live or dead matter can be conveyed to and from the imposing table quickly and easily.

The lower illustration is of the imposing table without the trucks. The legs and frame are of heavy steel, the top of heavy iron, and drawers of pressed steel. Color, olive green.

The trucks are of reinforced steel throughout, supported by strong angle-iron platforms on four strong castors. No. 1 Storage Truck has twelve removable letter boards. No. 2 Storage Truck has forty-five galley shelves. There are four trucks, two of each style, and each is provided with two strong hand holds, by which it is easily directed. The arrangement of these storage trucks can be varied to suit special conditions. Color, olive green.



Imposing Table with Four Storage Trucks No. 727

Dimensions of Imposing Table with Four Storage Trucks No. 727

Length, 60 inches; depth, 48 inches; height, 38½ inches; removable letter shelves in Truck No. 1, 24½ inches wide and 23 inches deep over all; galley shelves in Truck No. 2, take double-column full-length galleys; dimensions of Trucks, 27½ inches wide, 24½ inches deep, and 27½ inches high, over all. Price for this table and for other sizes and styles on application.

Steel and Iron Imposing Tables Without Storage Trucks

These tables (as illustrated here) meet conditions which only require the means of imposing forms. Storage Trucks may be added at any time, if required, or special form racks or other fixtures may be added as conditions develop or change.

The construction is strong, durable and attractive. The legs and frame are made of heavy steel; the top is of heavy iron; the drawers are of pressed steel. Color, olive green.

Dimensions of Steel and Iron Imposing Tables Nos. 730 to 738 inclusive

No. 730, 24x36 inches over all; height, 38½ inches; capacity, two 6-column pages.

No. 731, 26x44 inches over all; height, 38½ inches; capacity, two 7-column pages.

No. 732, 28x50 inches over all; height, 38½ inches; capacity, two 8-column pages.

No. 733, 26x76 inches over all; height, 38½ inches; capacity, four 7-column pages.

No. 734, 28x80 inches over all; height, 38½ inches; capacity, four 8-column pages.

No. 735, 36x60 inches over all; height, 38½ inches; capacity, four 6-column quarto pages.

No. 736, 48x60 inches over all (as illustrated); height, 35½ inches; capacity, four 7-column quarto pages.

No. 737, 48x72 inches over all; height, 35½ inches.

No. 738, 40x80 inches over all; height, 35½ inches.



Showing Imposing Table without Trucks No. 736

Hamilton Steel and Iron Imposing Tables No. 700

These are made any size and with Underneath Arrangements to suit special conditions. The construction is the strongest and most durable used in composing room equipments, practically indestructible, withstanding the hardest usage and always maintaining a good appearance.

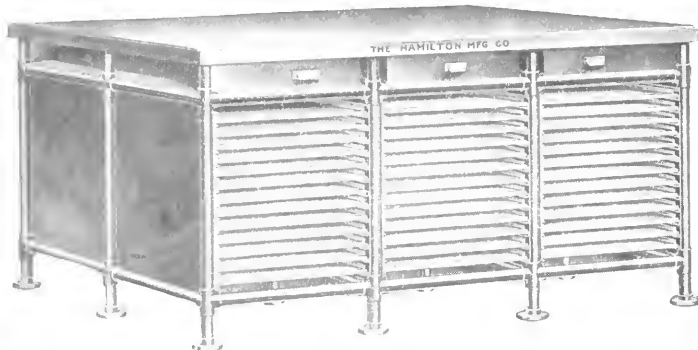

Hamilton Steel Imposing Table No. 700

Dimensions of Hamilton Steel Imposing Table No. 700

Length, 75 inches; depth, 51 inches; height, 38 $\frac{1}{2}$ inches; letter shelves, 21 $\frac{1}{2}$ inches wide and 23 inches deep. *Prices for this and other sizes and styles on application.*

Hamilton Steel Galley Cabinets

(For other Galley Cabinets see page 1297).

These are made any length and will be divided for any widths of galleys.

The galley cabinet illustrated here is 72x25 $\frac{1}{4}$ inches, and holds 136 full-length double column galleys, and has three steel drawers, each 23 $\frac{1}{2}$ x16x3 $\frac{1}{2}$ inches.

The construction is strong, durable and attractive. The frame and top are made of reinforced steel, the drawers and back are made of pressed steel. Color, olive green.

The height is 38 $\frac{1}{2}$ inches, which is convenient for using the top for correcting, etc.; or the top may be used for storage purposes.

Dimensions of Steel Galley Cabinet No. 655

Length, 72 inches; depth, 25 $\frac{1}{4}$ inches; height, 38 inches; size of drawers, 23 $\frac{1}{2}$ x16x3 $\frac{1}{2}$ inches. *Price for this and for other sizes and styles on application.*

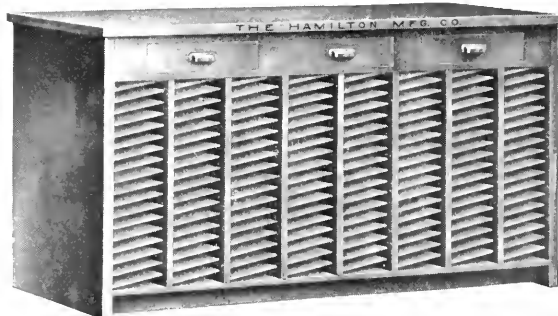

Steel Galley Cabinet No. 655

Hamilton Steel Page Storage Galley Cabinets

This cabinet holds 62 galleys, each 8 $\frac{1}{2}$ x11 $\frac{3}{4}$ inches inside. Other sizes of this useful cabinet are made to order.

When the cheapness and durability of pressed steel galleys are taken into consideration, together with the economy and convenience of carrying both live and dead matter on galleys rather than sliding the matter from and to movable letter boards (especially in the case of the smaller forms or pages) it will be found advisable to carry all such forms and pages on galleys, even if the full galleys are stored on the removable letter boards. Where there is a constant use of standard sizes of forms and pages, galleys can be made to fit such standard sizes, and cabinets (such as this one illustrated here) with runs instead of shelves to accommodate the galleys can be furnished, and will prove safe, space-saving, cleanly and convenient.

The construction of the Page Storage Galley Cabinet here illustrated is strong, durable and attractive. The frame and runs are of heavy steel, the sides and back of pressed steel. The galleys are also of pressed steel, and bottoms of standard galley thickness. Color, olive green.

Dimensions and Contents of Page Storage Galley Cabinet No. 660*

Capacity, 62 galleys, each 8 $\frac{1}{2}$ x11 $\frac{3}{4}$ inches inside. Height, 43 inches; width, 20 $\frac{3}{4}$ inches; depth, 13 $\frac{3}{4}$ inches. *Price for this cabinet and for other sizes on application.*

Steel Letter Board Cabinets

These cabinets are unexcelled for convenience and utility. They occupy little space and can be placed in the most advantageous positions in commercial plants.

The cabinet here illustrated has 22 steel letter boards, each 12x15 inches inside. The sides of the cabinet and the runs extend two inches beyond the letter boards, so that the latter may be pulled out to expose their entire contents without detaching them from the supporting runs. The construction is strong, durable and attractive. The frame and runs are made of heavy steel, the letter boards of reinforced steel, and the sides and back of pressed steel. Color, olive green.

Steel Letter Board Cabinet No. 576

inside. The sides of the cabinet and the runs extend two inches beyond the letter boards, so that the latter may be pulled out to expose their entire contents without detaching them from the supporting runs. The construction is strong, durable and attractive. The frame and runs are made of heavy steel, the letter boards of reinforced steel, and the sides and back of pressed steel. Color, olive green.

Dimensions and Contents of Steel Letter Board Cabinet No. 576*

Capacity, 22 letter shelves, each 12x15 inches inside. Height, 43 inches; width, 19 inches; depth, 15 $\frac{1}{2}$ inches. *Price on application.*

*As made the sides will be without the panel effect shown in the illustration.

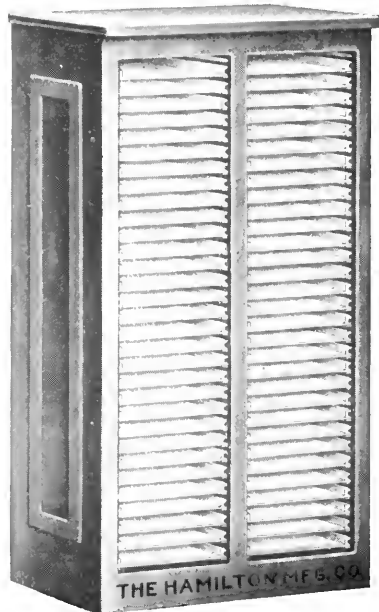

Page Storage Galley Cabinet No. 660

Steel Flat Top Galley Cabinets

(For other Galley Cabinets see page 196)

These useful cabinets very forcibly illustrate the space-saving advantages of steel construction. The two-tier cabinet illustrated here accommodates 50 double-column galleys in the same (in little less, in fact) space occupied by a cabinet of wooden construction holding 40 galleys. This is a capacity increase of twenty-five per cent. The increase in durability is much greater. These steel cabinets are indestructible in regular use.

Storage galleys are now so low-priced that in many plants it is found to be more economical and more convenient to store all standing matter on galleys in galley cabinets rather than on letter boards.

The construction is strong, durable and attractive. The frame, top and supports are made of reinforced steel, the back and the shelves are made of pressed steel. Color, olive green.

Capacity and Dimensions of Steel Flat Top Galley Cabinets

No. 650, holds 50 double-column galleys, in two tiers. Height, 33 inches; width, 18 $\frac{1}{2}$ inches; depth, 21 $\frac{1}{4}$ inches.

No. 651, holds 100 double-column galleys, in four tiers. Height, 43 inches; width, 35 inches; depth, 21 $\frac{1}{4}$ inches.

No. 652, holds 150 double-column galleys, in six tiers. Height, 43 inches; width, 51 $\frac{1}{4}$ inches; depth, 21 $\frac{1}{4}$ inches.

Prices on application for above and other sizes.

Numbers on upright opposite each shelf are extra.

Galley Tops will be furnished when specially ordered, and are extra.

Other sizes and styles of Galley Cabinets will be found in our Catalogue of Steel and Iron Equipments.

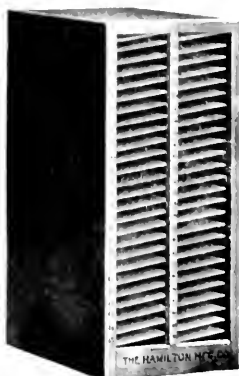

Flat-Top Galley Cabinet No. 650
to hold 50 galleys

Steel Galley Storage or Mail List Cabinets No. 658

These are made in a variety of sizes. The top is of reinforced steel, capable of sustaining great weight, the runs are of strong angle iron, the ends and back of sheet steel. Color, olive green.

These cabinets afford the most compact and safe method of storing mail lists or other matter. Metal galleys are now furnished

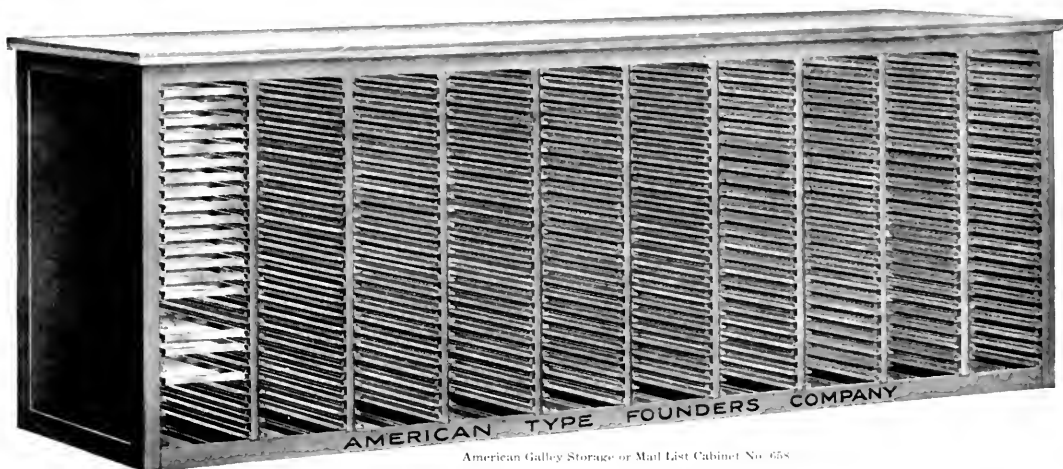

American Galley Storage or Mail List Cabinet No. 658

at such moderate prices that the most economical way of storing live or dead matter is to keep it on galleys rather than letter boards, unless the forms are large.

The regular height of these cabinets is 38 inches, the correct height for a working table, and the steel tops of these cabinets may be used for correcting or any other purpose for which a table is convenient. American Galley Storage and Mail List Cabinets can be furnished any height desired or to suit any width or length of galley.

The illustration is intended to show the construction and represent the large variety of such cabinets which can be supplied. The galleys are usually held flat with the matter secured in them, but the racks can be made to hold galleys at an angle suitable for storing unsecured matter.

Dimensions of American Galley Storage or Mail List Cabinet No. 658

Capacity, 250 double column galleys. Length, 9 feet 6 inches; depth, 26 inches; height, 38 inches. Price of cabinet as illustrated and for other sizes on application.

Wrought Iron Case Stands

These are made of wrought iron pipe, threaded together rigidly at all joints; the runs are made of angle iron; the galley rests are of steel. Very durable and well-appearing. No better case stands are made.

The prices listed below apply to stands holding full-size, quarter or Rooker size cases.

List Prices and Capacities of Wrought Iron Case Stands

In ordering it is necessary to state the size of cases the stands are required to hold.

No. 901. Single Stand, without runs	\$ 9 00
No. 902. Single, with runs for 8 full cases (see illustration)	12 25
No. 903. Single, with runs for 8 full cases and galley rest	13 25
No. 904. Double Stand, without runs	14 30
No. 905. Double, with runs for 8 full cases	17 50
No. 906. Double, with runs for 8 full cases and galley rest	18 50
No. 907. Double, with runs for 8 full cases, galley rest and 16 galley racks	27 50
No. 908. Double, with runs for 8 full and 8 two-third cases	20 50
No. 909. Double, with runs for 16 full cases and galley rest	21 70
No. 910. Double, with runs for 8 full and 8 two-third cases, galley rest and 16 galley racks	30 00
Extra runs, attached, per pair	10

Wrought Iron Case Racks

These are made of wrought iron pipe, threaded together rigidly at all joints; the runs are made of angle iron.

No. 911. Rack to hold 12 cases	\$16 00
No. 912. Rack to hold 16 cases	17 00
No. 913. Rack to hold 20 cases	18 00
No. 914. Rack to hold 24 cases	19 00
No. 915. Rack to hold 30 cases	21 00
No. 916. Double Rack to hold 40 cases	36 25



Wrought Iron Case Stand No. 902
(shown with cases)

Drying Rack and Stock Table No. 917

A very useful piece of pressroom equipment in commercial printing plants. The top serves for piling paper ready for the presses or for handling printed matter when ready for delivery. Underneath there are twenty-four large, strong steel drawers, each 30x30 inches and 1½ inches deep inside, with pulls on both sides, arranged to give ample circulation of air between them. These drawers may be pulled out of the rack on either side.

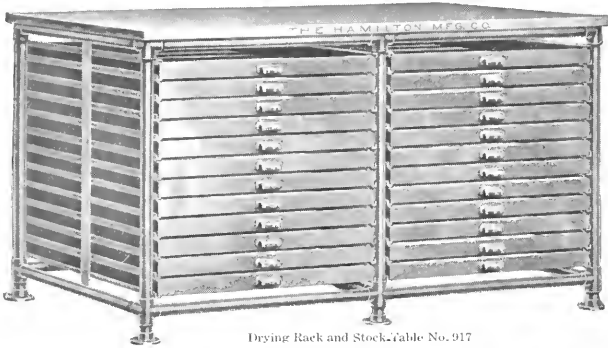

Drying Rack and Stock Table No. 917

Tables of other sizes are made to order, with or without drying racks. The Underneath Arrangement can be varied to suit all requirements. Bins or shelves can be substituted for drying racks.

The construction is strong, durable and attractive. The frame and central supports are made of heavy iron pipe rigidly threaded together at all joints; the top is of sheet steel, smooth, rigid and capable of sustaining great weight; the drawers are of wood, with steel fronts. Color, olive green.

The bottoms of the drawers have 1½-inch openings at 1½-inch intervals, to permit extra circulation of air through all the drawers.

Contents and Dimensions of Drying Rack and Stock Table No. 917

Contains twenty-four drawers, each 30x30x1½ inches inside; length of table, 69 inches; depth, 32 inches; height, 40 inches. *Price on application.*

Hamilton Steel Form Rack No. 935

This Form Rack is a fine example of the printing office equipments of the future. In compactness, in the security with which it holds the forms, in the range of sizes of forms which it accommodates it leaves nothing to be desired. Added to this efficiency is practical indestructibility in its proper use. It is capable of sustaining much more than the maximum weight that can be put into it.

Another great feature is the ease with which it may be kept clean. Nothing is concealed. There are no hiding places for dirt.

The frame and racks are of heavy steel in tubular construction, rigid, strong, durable and attractive in appearance. Color, olive green.

Dimensions and Capacity of Hamilton Steel Form Rack No. 935

Holds 72 chases (24 in each rack); width, 54 inches; height, 6 feet 9 inches; depth, over all, 23 inches. *Prices for this Form Rack and for other sizes on application.*

Steel Bindery Work Tables

The accompanying illustration is to call attention to the fact that all sorts of printing plant equipment can be supplied by us in steel and iron, fire-proof and indestructible, and maintaining good appearance long after wooden equipments have gone into the furnace.

The top of the Steel Bindery Work Table here illustrated is of level reinforced steel; the frame of 1¼-in. iron pipe, strongly braced with the same material, all joints being threaded together, making a perfectly rigid and stable construction. They are also made with steel frames instead of pipe frames. The color is olive green.

Bindery equipments of this style are made to order to any specifications. The standard height of bindery work tables is 32 inches, but other heights can be furnished if preferred.

Dimensions of Steel Bindery Work Tables

No. 775, pipe frame; length, 6 feet; depth, 3 feet; height, 32 inches; approximate weight, 175 pounds.

No. 776, steel frame; dimensions same as those of preceding item; approximate weight, 125 pounds.

No. 777, pipe frame (as per illustration); length, 9 feet 6 inches; depth, 3 feet; height, 32 inches; approximate weight, 225 pounds.

No. 778, steel frame; dimensions same as those of preceding item; approximate weight, 175 pounds.

No. 779, pipe frame; length, 12 feet; depth, 3 feet 6 inches; height, 32 inches; approximate weight, 275 pounds.

No. 780, steel frame; dimensions same as those of preceding item; approximate weight, 220 pounds.

Prices for above tables and tables of other sizes on application.

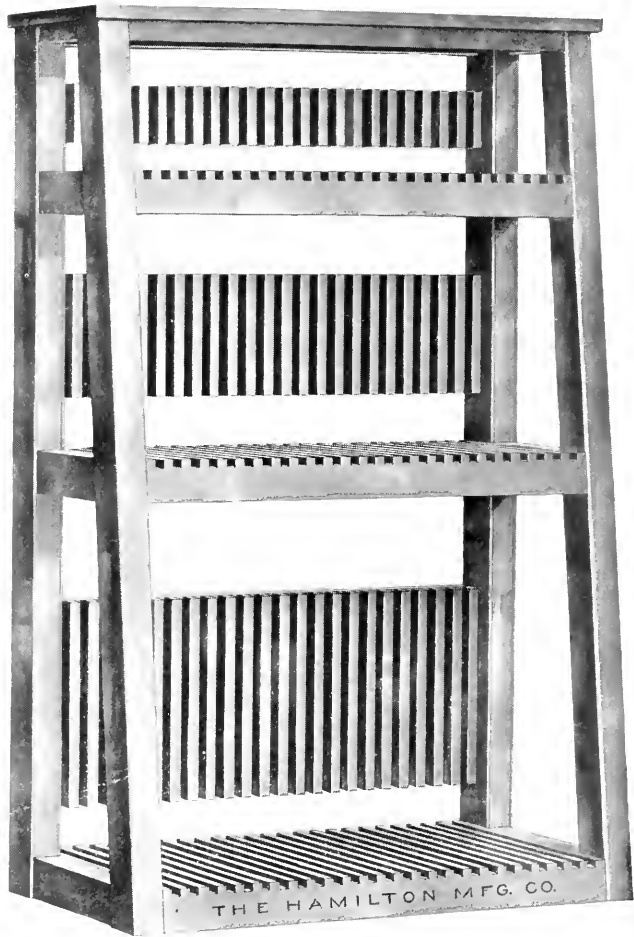

Hamilton Steel Form Rack No. 935

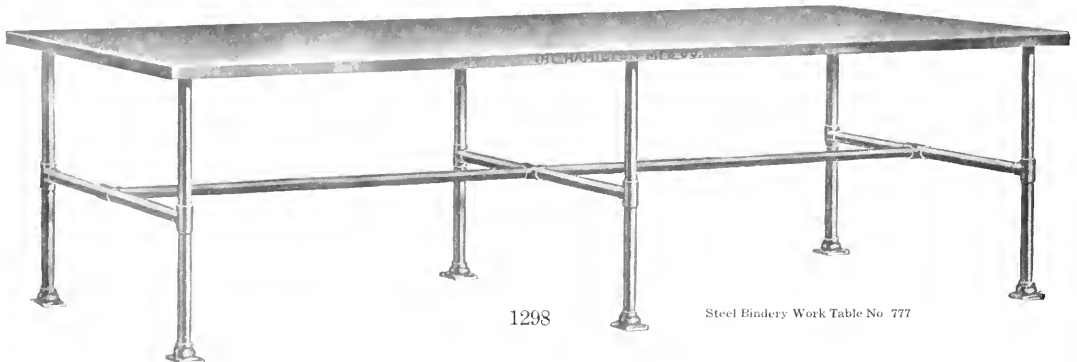

Steel Self-Dumping Metal Trucks

These two trucks were designed by men practical in handling material in newspaper composing rooms, with a view to economizing in time. The Hamilton is specially adapted for use under correcting and break-up tables, having chutes leading into the trucks.

The American is better adapted for use with tables in which the dead slug bins are part of the tables. The construction of the American is such that it can be dumped clean with the least possible effort.

The economical feature is facility for self-dumping; any other style of trucks increases labor cost. The construction of both trucks is substantial and both are designed for maximum durability under rough usage.

American Self-Dumping Metal Truck has frame and box in one strong steel construction. The box is balanced on 8-inch wheels with oval-shaped tires and a swivel roller-bearing castor at the handle end. The other end is a strong door, held by two strong locking-levers. When receiving metal, these locking-levers are held securely by a pin in the side brackets which engages in a notch in each locking-lever. To empty the box, the levers are lifted about one inch by their handle-bar, and when the truck is so tilted the door is opened by the weight of the contents.

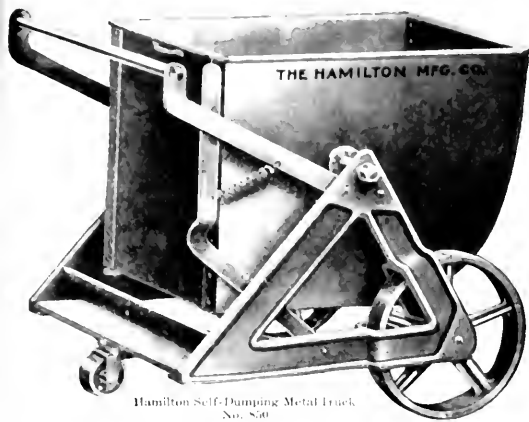

Hamilton Self-Dumping Metal Truck, No. 540

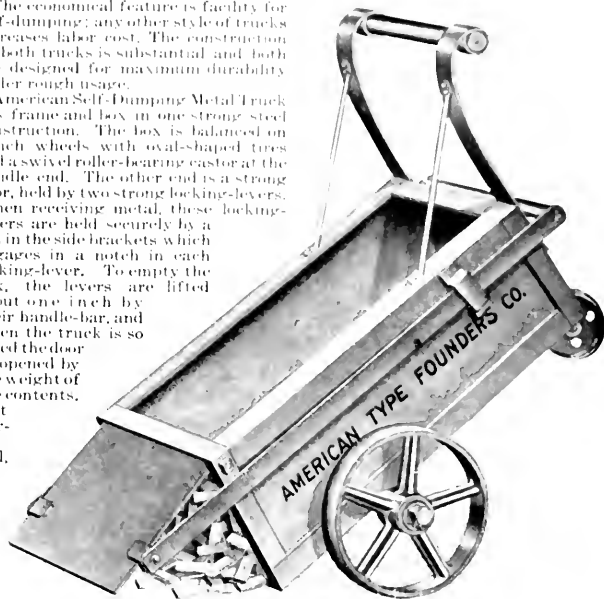

American Self-Dumping Metal Truck No. 551

When tilted the box is at a sharp angle, and all the slugs run out freely. The truck handle-bar is high enough to enable the operator to direct the truck without stooping.

Hamilton Self-Dumping Metal Truck has a frame of semi-steel, on castors with broad tires, controlled by a handle-bar, and easily directed. The box is made of heavily-riveted pressed steel, hung on a substantial shaft. The box is dumped very easily by disengaging the hand lever. When empty the box automatically recovers its upright position. Color, olive green.

Dimensions of Steel Self-Dumping Trucks

Hamilton Self-Dumping Truck No. 850; length, 24 $\frac{1}{2}$ inches; width, 18 $\frac{1}{2}$ inches; height, 22 $\frac{1}{2}$ inches; all over all. Price on application.

American Self-Dumping Truck No. 851; length of box, 22 inches; width of box, 16 inches; height of box, 12 inches; height to upper handle-bar, 32 inches. Price on application.

American Matrix Tissue Holder

The object of this recent invention is to make it easy to paste up stereotype flongs quickly and easily and in better shape than can be done by the old method. This is the invention of a practical stereotyper, and it has proved very practical and popular wherever used.

This apparatus enables one operator to lay the tissue sheets smoothly and rapidly on the pasted matrix paper. The supply of tissue paper is held on the movable shelf A, under a rubber cover, which keeps it flat and clean. This shelf runs freely between eight grooved wheels at F. The matrix paper is kept on movable shelf D (see cut below). The matrix paper is pasted when on the marble top B; the operator draws the shelf B toward him as he stands at G, and releases one tissue, which he secures with his fingers on the near edge of the pasted matrix paper. He then lifts the matrix roller from the brackets GG and rolls tissue in the usual manner. As the matrix roller is pushed over the paper it draws the tissue down from the shelf A, and at the same time pushes the shelf A back. The tissue lies flat and unwrinkled, and is always squared with the other sheets of the flong.

The matrix paste is kept on movable shelf E. A paste-holder is provided, but no brush. The apparatus is on castors, so that it can be used in an advantageous position and returned to any little used place in the stereo department. The shelf A is in an iron frame, the top is marble, the frame of wood. The hand matrix roller is extra.

This apparatus is also furnished without the stand, with bracket for attaching to a heating table.



American Matrix Tissue Holder with Matrix Roller in Use



American Matrix Tissue Holder, Ready for Use

List Prices and Dimensions of American Matrix Tissue Holder

Length, when extended, 60 inches; length, when not extended, 42 inches; width, when extended, 62 inches; width, when not extended, 28 inches; height, to marble top, 36 inches. List price, with Paste Holder, but without Hand Matrix Roller and Brush	\$85 00
Price without Stand, including only Shelf A and a Bracket for attaching to heating table	55 00
Hand Matrix Roller, solid iron, 20-inch cylinder (6 columns)	9 00
Hand Matrix Roller, solid iron, 22-inch cylinder (7 columns)	10 00
Hand Matrix Roller, solid iron, 24-inch cylinder (8 columns)	11 00
Stereotype Paste Brush	3 00

Weights: Matrix Tissue Holder, complete, 176 pounds; without stand, 150 pounds. Hand Matrix Rollers, 20-inch, 51 pounds; 22 inch, 60 pounds; 24-inch, 66 pounds. Stereotype Paste Brush, 1 $\frac{1}{4}$ pounds.

Flexityp Dry Cold Stereotype Flong

Flexityp Flongs are unexcelled for rapid results in getting press starters on the press. With them a good matrix is made in one minute. The operation is explained below. Flexityp Flongs are unexcelled among dry flongs, but dry flongs are recommended only where time and economy are the first considerations. All claims to the contrary notwithstanding, the properly prepared wet flong used expertly on efficient drying tables produces the better matrix.

Where "ad" matrices are exchanged Flexityp Flongs enable the users to produce a number of matrices as quickly and as easily as running off a corresponding number of proofs on a galley proof press.

Flexityp Dry Cold Stereotype Flong

The quality of stereotypes procurable from Flexityp Flongs is so good, the time saved by their use so important, the wear and tear of forms so reduced, and the comfort of stereotyping so greatly increased by eliminating the drying tables (especially in hot weather), that an increasing number of publishers prefer to stereotype by this method entirely. The daily newspaper with the largest circulation in Great Britain has discarded drying tables in favor of dry cold flongs. The leading newspapers of Germany (where this invention originated) have very generally discarded drying tables. In America the progress of dry cold flongs has been retarded by ignorance of the correct method of using them. Matrix Rolling Machines, which are ordinarily geared to pass over the form in five seconds, must be re-gearred to

pass over the form at the very slow speed of thirty seconds. It is essential to give ample time to make the impression, and it is essential to use the right kind and right thickness of felt blanket, and ample pressure. All these conditions being right, there will be no difficulty in procuring stereotypes of uniform good quality from Flexityp Cold Stereotype Flongs.

Consider the collateral advantages: The form is never heated. As soon as the impression is taken (or a number of impressions) the form is returned for make-overs, and can be handled immediately, instead of being excessively hot, as it often is when it leaves the drying tables. The forms may be moulded a number of times in succession, at intervals of forty-five seconds, so that starters may be put into a number of boxes almost simultaneously. It is possible to get one press started in a minute and a half after closing the last form. Many newspapers which make a specialty of late baseball news have been doing this constantly for four or five years. When a number of forms reach the stereotyping room together, a few minutes before the edition closes, Flexityp enables them to be handled with the greatest ease and without delaying the presses.

Where the wet flongs and drying tables are preferred, Flexityp may be used as an auxiliary for use in emergencies, such as receipt of news important enough to stop the presses, or when frequent make-overs are necessary.

Directions for use are furnished with the first order. When the form reaches the matrix rolling machine the Flexityp Flong is laid on (smooth side on type) and covered with a moulding blanket of good quality and a rubber blanket; then run very slowly (thirty seconds at least) under matrix roller. Trim at head and sides only; bake bone-dry in dryer; cut tail at gauge and apply packing where necessary; dust with French chalk, and cast. If a large number of casts are required rub the matrix with cocoanut oil after half a dozen casts.

Prices and Dimensions of Flexityp Dry Cold Stereotype Flongs

Size, 19x25 inches. Minimum quantity sold is one dozen.

List Prices, per sheet; lots of 12, at 40 cents; not less than 25, at 37½ cents; not less than 50, at 35 cents; not less than 75, at 32½ cents; not less than 100, at 30 cents; lots of not less than 200, 27½ cents. Directions gratis with first order.

Linolite System of Lighting

We have adopted the Linolite System of Lighting for such equipments as require to have lights attached to them, on account of the superior diffusion of light as compared with bulb lamps. A Linolite Lamp (see Fig. 1) is literally a *line of light*. It is an improvement on the ordinary bulb lamp. In the bulb lamp there is a coil of filament through which the electric current enters and leaves at the same end. In the Linolite Lamp a tube nearly a foot long is substituted for the bulb, and the electric current enters at one end of it and comes out at the other. It is self-evident that the light is diffused over a larger area by the tube, and, in addition, the extent of reflection by means of reflectors is much more than proportionately increased. Linolite Lamps are used exclusively in reflectors, and they can be removed from a reflector and replaced in a second or two. The position of a Linolite Lamp in its Reflector is shown in Fig. 2.

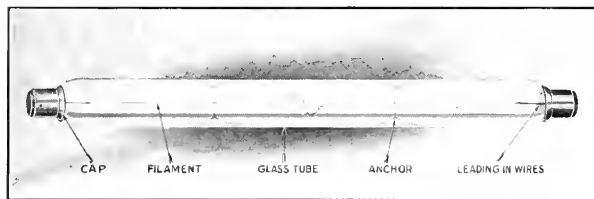

Fig. 1. A Linolite Tubular Carbon Lamp

The Reflector also effectively protects the eyes from the glare of the lamps.

For composing room equipments two kinds of Linolite Reflectors are used. Where the light is to be diffused downward and laterally in all directions (as, for instance, in the American Make-up Tables shown on page 1290) the Type A Reflector (Fig. 3) is used. Except where cabinets, banks and tables are placed against the wall, Type A Reflectors are used, as shown on Mills Extra Strong Cabinets on page 1288. When any equipments requiring overhead lighting are placed against a wall, or when it is required to light cases in racks of cabinets or shelves in the underneath arrangements of tables, etc., then Type L Reflectors (Fig. 4) are used, because they diffuse the light downward and outward toward the compositors or make-ups, and do not waste it on the wall.

Linolite Reflectors are sold by the foot, in units of twelve inches, at the same price per foot, whether holding one or several lamps. If a continuous line of light (i. e., lamps) is not required in a reflector the lamps may be placed in a reflector with any desired intervals between them. There is no limit to length of reflectors. Linolite Lamps are easily taken from and replaced in the reflectors.



Fig. 2. Single Linolite Lamp in Reflector (Sectional View)

List Prices of Linolite Reflectors and Lamps

Type A Reflector for one lamp, with clip for attaching to bracket, but without bracket	\$4 00
Type A Reflector for two or more lamps (Fig. 3), with clips for attaching to brackets, but without brackets, per foot	4 00
Type L Reflector for one lamp, with clip for attaching to bracket, but without bracket	5 00
Type L Reflector for two or more lamps (Fig. 4), with clips for attaching to brackets, but without brackets, per foot	5 00
Linolite Tubular Lamp, carbon filament (Fig. 1), for 100 to 125 volts, 16 candle power, each	1 00
Linolite Tubular Lamp, tungsten filament, 25 watts, 20 candle power, 25-32 volts, each	2-25
Linolite Tubular Lamp, tungsten filament, 35 watts, 28 candle power, 25-32 volts, each	2 50

These prices for unattached Reflectors and Lamps are subject to liberal discounts.

Brackets and all other means of attaching to Cabinets, Banks, etc., and wiring for connection are extra, and are included in the prices listed with each kind of equipment requiring Linolite Lamps.

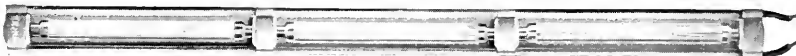

Fig. 3. Type A Reflector, with Three Lamps, showing reflecting area, which in use is hidden from the eyes

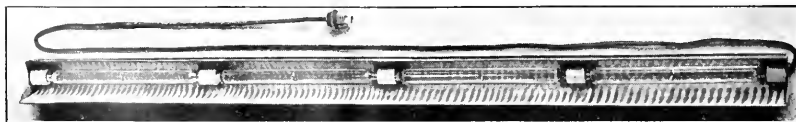

Fig. 4. Type L Reflector, with Four Lamps, showing reflecting area, which in use is hidden from the eyes

Wherever in a printing plant the light requires to be concentrated the use of the Linolite System is recommended.

The money value of efficient lighting in composing rooms is too little appreciated. The

work of the compositors cannot be done so quickly or so efficiently in composing rooms which are imperfectly lighted. The more diffused a light is the nearer it approximates sunlight on banks, tables, imposing tables, and case stands. All lights on such equipments should be concealed in reflectors. The reflectors diffuse the light naturally, and protect the eyes from the blinding effects of unprotected electric lamps.

National Ingot Casters

These Ingot Casters, three sizes of which are made, are easily attached to any metal furnace without being connected to the furnace, merely hanging over the upper edge of the furnace. In attaching them to metal furnaces, the only expert work required is that of a plumber to make water connections, as the mould is water-cooled. Two men can easily remove the caster from the metal pot and replace it as easily.

The National Ingot Caster illustrated here is the size most in use. It casts thirty-two (32) linotype or sixty-four (64) monotype ingots of regular size each minute, the fluid metal being pumped to the moulds by means of the long lever, and the ingots discharged by pulling back the short lever, which opens and closes the moulds. This is very quick work. Fully 33 1/3 per cent quicker than ingots can be produced by any other method.

In addition to the advantages of rapid output, there is the greater advantage of producing ingots that are uniformly clean and free from dross. The metal is always pumped from the bottom of the pot where it is found thoroughly mixed. Clean metal improves the quality of the work, and effects a number of important indirect savings.

Users of these National Ingot Casters report very favorably on them. "We turn out the required number of ingots in one-fifth the time." "I find it a fuel-saver. I now cast once a week, instead of every day, and save five tons of coal per year." "We cast an average of 1,200 ingots, or two and a half tons of metal a day, and the saving is immense."

"Casting our ingots formerly required several hours of one man's time each day. We now produce the same number of better quality, in twelve minutes."

Three sizes are made, as per particulars below. These casters are in use in over fifty plants.

As furnished, the National Ingot Casters produce linotype ingots 6 1/2 x 2 1/2 x 8 inches, weighing 3 pounds. This size has been adopted because it is better than the old size. It casts quicker. As shown in Fig. 1, the long, thin ingot is put into the metal pot without splash or danger of burning the hand. As shown in Fig. 2, the long, thin ingot stands better in the ingot holder, which is thus made to carry nearly twice as much metal as formerly. If specially ordered the ingot moulds are made to cast 6 3/4 x 2 1/2 x 1/2 inches (weight of ingot, 2 pounds), or any other thickness up to 7 inches, without extra charge. Other shapes are made to order at reasonable extra charges.

As furnished, the National Ingot Casters produce monotype ingots 3 x 2 7/8 x 1/4 inches, weighing 1 1/2 pounds, which is the size and weight recommended by the manufacturers of the monotype machines.

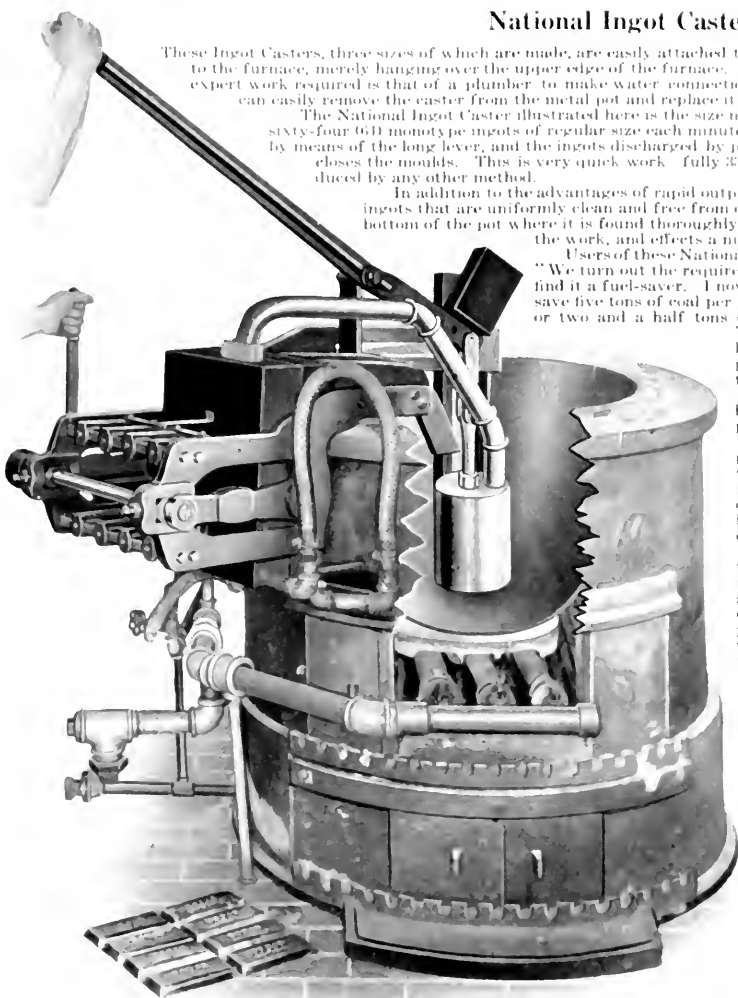

National Ingot Caster Attached to Metal Furnace

The National Ingot Caster may be operated with metal pots of one ton and greater capacity.

The Junior National Ingot Caster may be operated with metal pots of 500 pounds and greater capacity. An illustration of this apparatus will be sent on application.

The words "Mono" and "Lino" are inserted in the moulds without extra charge, if request is made when order for caster is placed.

A short name or initials of users will be put in the mould, for which an extra charge is made.

Prices and Particulars of National Ingot Casters

Junior National Ingot Caster, for plants using five or six machines	\$100 00
National Ingot Caster, the size most used, as illustrated	200 00
National Ingot Caster No. 4, for largest newspaper plants and plants in which a caster is used continuously, metal merchants, etc.	300 00
Extra for inserting initials or short name in linotype ingot mould	18 00
Extra for inserting initials or short name in monotype ingot mould	23 75

Shipping weights: Junior National, 200 pounds; National, 300 pounds; National No. 4, 450 pounds.

The Government Printing Office at Washington, D. C., is using four No. 4 National Ingot Casters.

National Ingot Casters are in use in the following well-known plants: *Globe*, Boston, Mass.; *Enterprise*, Brockton, Mass.; *Times*, Brockton, Mass.; *Daily Evening Item*, Lynn, Mass.; *Evening News*, Salem, Mass.; *Republican*, Springfield, Mass.; Phelps Publishing Co., Springfield, Mass.; *Journal*, Lowell, Mass.; *Globe* (2), Herman Feinberg and Wm. B. Dana Co., New York City; *Herald*, Syracuse, N. Y.; *American*, Baltimore, Md.; *North American*, Philadelphia, Pa.; *Star*, Toronto, Canada; *Telegram*, Toronto, Canada; Canada Metal Company, Spectator, Hamilton, Canada; *Times-Star*, Cincinnati, Ohio; *Post-Dispatch*, St. Louis, Mo.; *Ice*, Omaha, Neb.; *Star*, Kansas City, Mo.; *Herald*, Salt Lake City, Utah; *Star*, Los Angeles, Cal.; *Call*, San Francisco, Cal.; *Oregonian*, Portland, Ore.; *Spokesman-Review*, Spokane, Wash.

The *Times-Mirror* Co., Los Angeles, Cal., writes: "The Ingot Caster which we purchased from you prior to October 1, was salvaged from the wreck of the *Times* building, and is now again in active use. It works satisfactorily, and is a labor-saving as well as a time-saving apparatus."

The Boston *Globe's* superintendent of stereotyping writes: "One metal is used in this entire plant. Your Ingot Caster has been used under my supervision for the past three months, and has given entire satisfaction. We cast an average of 1,200 ingots, or two-and-a-half tons of metal each day. The ingots are convenient in size and shape."

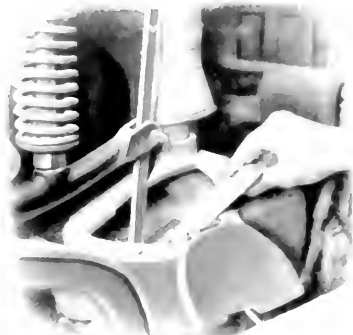

Fig. 1. Shows convenience of long linotype ingot, which is slid into pot without splashing



Fig. 2. Shows how well the long linotype ingot packs in ingot holder





