

HOME MADE
POULTRY
APPLIANCES

E. T. BROWN

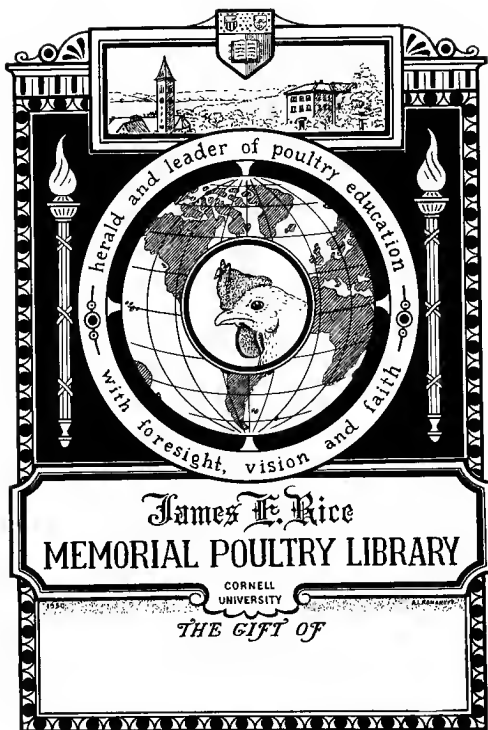

ALBERT R. MANN LIBRARY

NEW YORK STATE COLLEGES
OF
AGRICULTURE AND HOME ECONOMICS

Cornell University Library
SF 486.B87

Home-made poultry appliances; what to mak



3 1924 003 119 678

man

OTHER VOLUMES BY E. T. BROWN.

POULTRY FOR PROFIT. Crown 8vo.
Cloth. With 15 full-page Illustrations.
Price 3/6 net (postage 5d.).

FARM TRACTORS. Fully Illustrated. Crown
8vo. Cloth. Price 3/6 net (postage 4d.)

PROFITABLE POULTRY KEEPING. For
Smallholders and others. With Photographs
and many Diagrams. Stiff paper wrapper.
Price 1/6 net (postage 3d.)

DUCKS, GEESE, AND TURKEYS. Illus-
trated with Photographs and Diagrams. Stiff
paper wrapper. Price 1/6 net (postage 3d.)

**ONE THOUSAND ANSWERS TO ONE
THOUSAND QUESTIONS ON SMALL-
HOLDING SUBJECTS.** Stiff boards.
Price 1/6 net (postage 3d.)

STOCK FEEDING MADE EASY. Stiff
paper wrapper. Price 1/6 net (postage 3d.)

C. ARTHUR PEARSON, LTD.

**HOME-MADE POULTRY.
APPLIANCES**



Cornell University Library

The original of this book is in
the Cornell University Library.

There are no known copyright restrictions in
the United States on the use of the text.

HOME-MADE POULTRY APPLIANCES

WHAT TO MAKE AND HOW TO MAKE IT

E. T. BROWN, 1877

AUTHOR OF

“POULTRY FOR PROFIT,” “1000 ANSWERS TO 1000 QUESTIONS,”
“PROFITABLE POULTRY KEEPING,” “FARM TRACTORS,”
ETC. ETC.

ILLUSTRATED BY 87 DIAGRAMS

London

C. Arthur Pearson, Ltd.

Henrietta Street

1921

PREFACE

THE poultry-keeper who is able to make his own houses, brooders, coops, and troughs can reduce his capital expenditure very greatly. It is not too much to say that he can save from 40 to 50 per cent, even though he has to buy timber specially for the purpose. If he is able to use up odd pieces of wood, crates, and boxes he can reduce his initial expenditure upon appliances almost to vanishing point.

In the following pages an endeavour has been made to show in the simplest language exactly how poultry appliances can be made by the veriest novice. Technical details have been carefully avoided, while the fact that in all cases exact quantities of materials have been given should render the task of making appliances a simple job to anyone who is able to handle a hammer and a saw.

The man who makes his own appliances scores in three separate ways. He is able to carry out his own ideas; he is able to save a considerable amount of money; and he is able to put good material into his work. Apart from these manifest advantages there is the further point that one derives great pleasure in constructing one's own houses, coops, brooders, etc., to one's own designs. Creative work is always fascinating.

CONTENTS

CHAPTER	PAGE
I. THE AMATEUR CARPENTER	13
II. THE CHOICE OF MATERIALS	17
III. THE VALUE OF PLANS	29
IV. MAKING JOINTS	35
V. LAYING OUT A POULTRY YARD	39
VI. GENERAL PRINCIPLES OF POULTRY PLANT CONSTRUCTION	47
VII. VARIOUS FORMS OF POULTRY HOUSES	54
VIII. INSIDE THE POULTRY HOUSE	83
IX. POULTRY RUNS	96
X. NATURAL HATCHING—SHEDS AND APPLIANCES	102
XI. INCUBATOR HOUSES AND INCUBATORS	110
XII. BROODER HOUSES AND BROODERS	118
XIII. FATTENING SHEDS, CAGES, &C.	131
XIV. DUCK AND DUCKLING HOUSES.	141
XV. GOOSE AND TURKEY HOUSES	149
INDEX	153

HOME-MADE POULTRY APPLIANCES

CHAPTER I

THE AMATEUR CARPENTER

IF you want a thing really well done you must do it yourself. The truth of this statement is proved over and over again every year in every poultry yard in the kingdom.

The present-day poultry-keeper has perforce to be more or less a Jack-of-all-trades. He must be able to turn his hand to all manner of jobs. That is, of course, unless he wishes to spend his profits in labour.

There is, perhaps, no knowledge that comes in so opportunely as that of carpenter's work. There is so much wood employed for houses and appliances, and there is a constant need for renewals and repairs.

This class of work is practically the limit of the novice's capabilities. After a while, however, he gains sufficient experience to enable him to tackle much larger jobs and, moreover, to complete them successfully.

WHAT HE CAN DO

Poultry-house building presents no untoward difficulties, but, as in every other direction, a knowledge of the various operations is essential. It is this knowledge which turns a novice into a skilled amateur. It is this knowledge which will enable you to erect your own poultry buildings and construct the necessary appliances.

There is no reason why you as an amateur carpenter should not succeed where others have succeeded. There is no reason why you should not be able to design and construct every article in wood which you require for your poultry.

It is, of course, possible for you to purchase all that you need in the way of houses, incubators, brooders, fattening cages and the like. You will find yourself, however, in a difficulty if you elect to buy. In the first place, you are not likely to find a house designed according to your own ideas. It is necessary, therefore, to effect a compromise. At any rate, you will have to accept a house which does not entirely meet with your approval. It is accepted since it is the nearest approach to your ideal.

JERRY-BUILT VERSUS EXPENSIVE HOUSES

In the second place, a choice will have to be made between a cheap house and an expensive one. The difference in price is not due to profiteering on the part of the maker of the latter. The difference lies

in the quality of the material employed and the quality of the workmanship. It is not as though it were only a matter of a few shillings between the one and the other ; it is frequently a difference of pounds.

The only cheapness which can be tolerated is that cheapness born of excellence. One cannot say for a moment that this is the form of cheapness found in a cheap poultry house. Far from it, since such a structure is generally jerry-built of very inferior material.

It is jerry-built in that the framework is chiefly noticeable by its absence. The houses are weak, and although they may last one or two seasons, they never give satisfaction. Again, the material is too thin. It does not afford sufficient protection for the inmates in this cold, changeable climate of ours. Lastly, the timber is only partially seasoned. It is affected by climatic conditions, with the result that the joints between the boards open, making the interior draughty and unfit for the birds.

Well-built houses of properly seasoned wood are expensive. They are excellent in many ways, but they are expensive. Your banking account may be quite able to meet the strain of investing in such buildings, but if you are keeping fowls with the object of making them pay you do not want to burden the business with too great a capital outlay. Many highly successful undertakings have come to grief for this reason alone. The ideal is to equip the plant thoroughly well for the smallest sum possible.

THE THREE MAIN POINTS

The poultry-keeper who makes his own appliances and builds his own houses derives three great advantages. First of all he can carry out his own ideas, erecting the structures along lines laid down by himself. There are many labour-saving devices which he may wish to incorporate in the houses and many improvements which he may desire to effect. The first advantage, therefore, is that the finished building is just as the owner wishes it to be.

The second advantage is that the home-built house costs no more than the cheap one referred to above. The question of the price of labour does not intrigue the amateur carpenter, since the labour involved is his own.

Lastly, although the cost is only that of a cheap house, the quality is equal to, if not better than, the expensive form of building. It comes to this, that by building your own appliances you will get them as good as the best which can be bought and at a figure no higher than the cost of a jerry-built cheap make.

There is one further point, but I do not propose to lay much stress on it, namely, the great pleasure and enjoyment which is derived from constructing one's own houses to one's own designs. Creative work is always fascinating, and this, therefore, should be classed among the advantages which accrue to the amateur carpenter.

CHAPTER II

THE CHOICE OF MATERIALS

FOR the construction of the majority of the buildings, houses and appliances used on a poultry farm timber is undoubtedly* the best to employ. A wooden house, if properly built of sound material, affords sufficient protection to the inmates. - It is quite unnecessary to use bricks for the construction of any building or house which is to be used for fowls.

It is essential, however, that the material selected shall be well seasoned. Fresh cut wood is unsuited to the purpose, and no satisfactory house can be built therefrom. It stands to reason the well-seasoned wood is more expensive, but the difference in cost is much more than made good by its more durable qualities.

Three kinds of boarding can be used for the main parts of the house. For the walls and roof either tongued and grooved boarding (matching or match-boarding) or weather-boarding may be employed. The former, as the name implies, is so cut that the tongue of one board fits into a groove on the next board. In this way a solid area is produced. Weather-boarding, on the other hand, is cut with

one edge thinner than the other, and the thicker edge overlaps the thinner of the next board. There are two kinds of weather-boarding, as will be seen from Fig. 1.

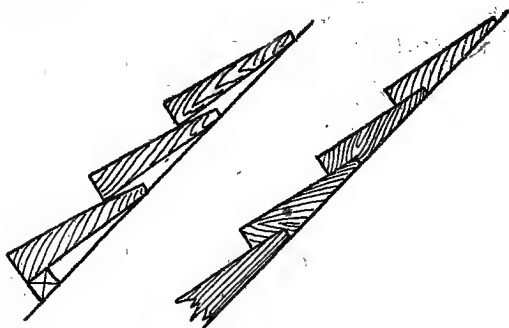

Fig. 1.

The third kind of boarding is known as sawn boards. These are square-edged and unplanned. This wood is generally employed for the roof—when it is afterwards to be covered with felt and corrugated iron or iron alone—and for some of the internal fittings, such as nests.

THICKNESS AND WIDTH OF MATCHING

When buying matching there are two points to be taken into consideration. In the first place, the timber must be sufficiently thick to afford protection to the inmates. For a permanent house, if the wood is to be used alone, it should not be less than 1 in. in thickness. In the case of a portable house—a too heavy house is undesirable—thinner match-

ing, say, $\frac{3}{8}$ in. thick, covered with felt or tarred brown paper, should prove ample.

The second point is with reference to the width. It may be taken that the wider the boarding the more expensive it is per square. For this reason it is advisable to select matching which is about 5 in. or 6 in. wide. Two very common widths are $5\frac{1}{2}$ in. and 7 in. In the following chapters, wherein specifications of various houses are given, I have calculated all boarding at 7 in. wide.

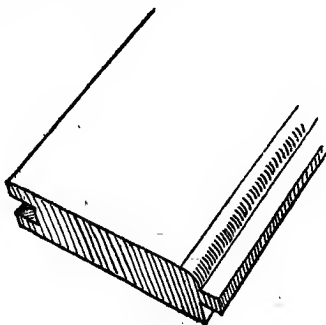

Fig. 2.

Reference has been made to a square of boarding in the preceding paragraph. All boarding, matching and sawn boards is bought by the 100 sq. ft., irrespective of thickness or width. This is termed a square, and the price varies according to the width and thickness of the boards.

Three-ply Wood

This is an excellent material for making partitions and some of the smaller internal fittings in a

poultry house. It is particularly strong, and being thin takes up considerably less room than ordinary boarding. It is sold in sheets varying in size up to 6 sq. ft.

The Framing

For the various forms of appliances, houses and buildings which are used on a poultry farm many different kinds of framing are employed. For some of the smaller structures wood 2 in. by 1 in. is quite heavy enough. For houses up to 10 ft. by 20 ft., 2 in. by 2 in., with 3 in. by 2 in. for the sills at the bottom of the structure, will answer the purpose. For larger buildings, such as fattening sheds and incubator houses, 3 in. by 2 in. for the main part of the building, with perhaps 4 in. by 2 in. for the roof rafters and 5 in. by 2 in. for the ridge, should prove sufficient. The size of the rafters and ridge is governed by the roofing material which is used. For instance, a roof made of sawn boards and corrugated iron is heavy, and therefore requires considerably more support than a plain wooden roof.

Framing wood is bought by the 100 ft. run—that is, pieces totalling 100 ft. irrespective of size.

FOUNDATIONS

Small houses which are erected in a dry spot require no special foundations. The ground should be levelled and a base made of ashes. When the ashes have been well beaten down a little tar can be sprinkled on top. This forms an excellent base on which to rest the house.

When foundations are needed, it stands to reason that their strength must be in proportion to the weight they have to carry. A laying-house, say, 10 ft. deep by 20 ft. long, can either be stood on a foundation of bricks; or a very excellent material to use when it can be obtained is old railway sleepers. It is, however, generally very difficult to procure them. For similar sized houses bricks are the best to employ; but for large buildings, or heavy buildings, such as a double-walled incubator house, a cement base is preferable. When a wooden floor is fitted to any building, it is necessary to build foundations for the support of the floor joists. These can either be of brick or cement. (See Fig. 4.)

Bricks

A stock brick is $8\frac{3}{4}$ in. by $4\frac{1}{2}$ in. by $2\frac{1}{2}$ in., and weighs about 5 lb. When bricks are laid they occupy a space 9 in. by 3 in. by $4\frac{1}{4}$ in. Mortar is used for binding the bricks together, and this is made from sand, lime and water in the proportion of 6 bus., 3 bus. and 14 gals. respectively. A cubic yard of brickwork takes 410 bricks, $6\frac{1}{2}$ cub. ft. of sand and $2\frac{1}{2}$ cub. ft. of lime. The quantity of sand used depends largely on the quality of the lime. It is sometimes possible to use 4 parts of sharp sand to 1 of lime.

Cement

To make cement foundations for a large house use 1 part of Portland cement to 6 or 7 of broken stone, burnt ballast, shingle, gravel or slag. What-

22 HOME-MADE POULTRY APPLIANCES

ever material is employed, it must be free from loam, mud, fine sand or dirt of any kind. A wooden mould must be made, and it is necessary to soap the inner walls.

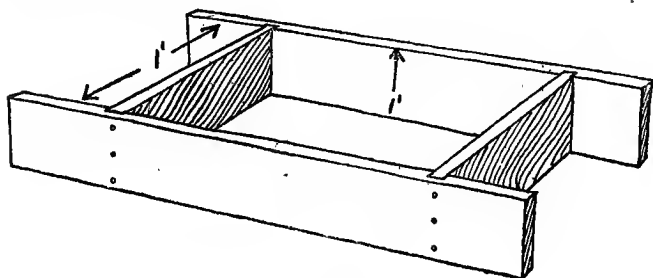

Fig. 3.

The width of the base is governed by the size and weight of the structure. It should, however, not be less than 1 ft. deep nor less than 9 in. in width. The supports for the floor joists should measure 9 in. square. To make the floor rigid these should be 3 ft. apart when 3 in. by 2 in. joists are used.

FLOORS

Many different materials are employed for floors, and to a great extent the choice of material is decided by the use to which the house is to be put. One thing is essential, however, with all floors, namely, that the upper surface should be at least 4 in. higher than the surrounding ground. If otherwise, there is always the probability that the floor will be damp. Dampness is fatal in poultry-keeping, except in the case of the floor of a sitting-hen house,

when a certain degree of humidity in the flooring material is highly desirable.

Earth Floors

• For an ordinary poultry house, an incubator house or a fattening shed the practice of making an earth floor is not to be recommended. It is not only that the earth tends to hold the moisture—even if raised above the ground level—but such a floor is difficult to clean. The fowls, moreover, scratch it up, and it is difficult to keep an earth floor in a decent state of repair. A floor made of this material, however, is excellent for a house used exclusively for broody hens.

Ashes and Tar

A mixture of these two constitutes an excellent flooring material for poultry houses and fattening sheds. The following is a successful method of preparing this kind of floor: The natural earth should be well, but roughly, beaten down. Ashes to the depth of $3\frac{1}{2}$ in., after being tightly trodden or rolled down, are placed on top of the earth. The upper crust of the floor is made by laying on a thin coating of sifted ashes which has been just damped with tar. This must be beaten down, and a sprinkling of fine sand on top will complete the floor. Such a floor requires a few days to harden.

Gravel

Good binding gravel can also be employed for making floors for poultry houses and fattening sheds.

24 HOME-MADE POULTRY APPLIANCES

This must be well rammed down, and the upper inch should be made from finer gravel than that used for the bottom three inches. If properly prepared, such a floor gives most satisfactory results.

Wooden Floors

Wooden floors should only be used for two types of buildings. In the case of portable houses such floors are a necessity, since there is no really satisfactory method of making a fairly large house movable and at the same time floorless. A small house for growing stock which is sufficiently light to be lifted can be constructed so that it rests on

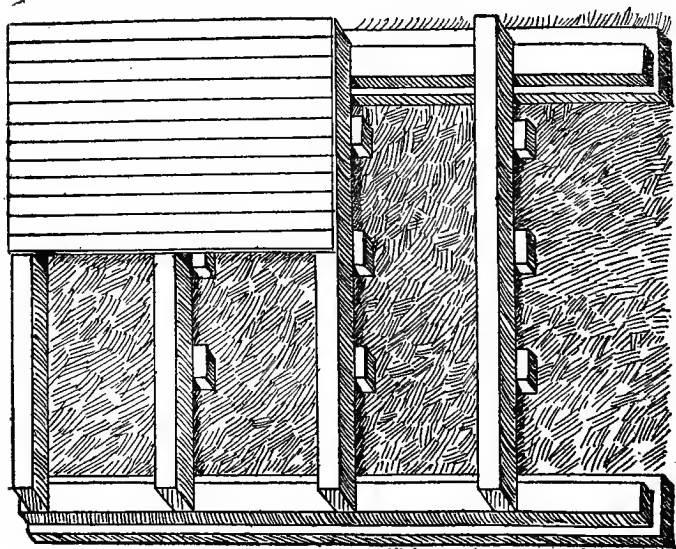

Fig. 4.

the ground, but even here it is generally found advisable to fix in a floor. When wood is employed for this purpose it should never be less than 1 in. in thickness, and it must be well supported by a goodly number of joists. A wooden floor must be very carefully made, since ground draughts are fatal to fowls.

A wooden floor can also be used for incubator houses. Here, however, heavier timber must be used, since the slightest vibration is very detrimental to hatching eggs. Floor boards $1\frac{1}{2}$ in. to $1\frac{1}{2}$ in. thick should be employed and well secured to joists at least 3 in. by 2 in.

Concrete Floors

Undoubtedly the best flooring for an incubator shed is concrete. Concrete can be made of 1 part of Portland cement to 4 parts of gravel and 2 of sand. When this has been laid it should be levelled off roughly and allowed to dry. When dry, the surface should be wetted and a layer of concrete made of 1 part of Portland cement to 4 parts of clean sand spread on top. This must be levelled off evenly with a trowel and allowed to set. A concrete floor for an incubator shed should not be less than 1 ft. in depth, and, in the case of a large building, it is advisable to have it slightly deeper.

THE ROOF

The choice of materials for the construction of the roof should be guided by the size of the house

and the purpose for which it is built. For ordinary poultry houses a roof composed of $\frac{5}{8}$ -in. sawn boards, covered with a reliable roofing felt, should prove sufficient. In other cases, wood can be used alone, but it should then be at least 1 in thick, and either tongued and grooved or weather-boarding, so that no rain can penetrate.

Corrugated iron should never be used by itself for roofing, since it causes the interior of the building to be too hot in summer and too cold in winter. Placed above boarding—with an air space and a layer of felt between—however, it is particularly useful. An incubator house should always be roofed in this manner, for it is desirable to maintain an even temperature within.

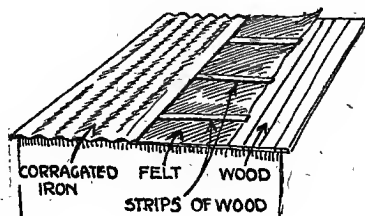

Fig. 5.

Corrugated iron is heavy, and therefore this fact must be taken into account when determining the size of the rafters. A 100 sq. ft. of No. 16 gauge weighs about 3 cwts. A square of No. 20 weighs approximately 1 cwt. 2 qrs. This is a considerable addition to the weight of a plain wooden roof

Thick brown paper is sometimes used in place of felt for roofing purposes. It can also be used for covering the walls of a house. The wood is first of all tarred, and while the tar is still wet the brown paper is stuck on. The outer surface of the paper is then given two coats of tar, and directly after the last coat fine sand is sprinkled evenly over.

WHEELS

The only satisfactory method of making a house portable is to place it on wheels. At various times suggestions have been made for using detachable wheels or a system of wheels whereby one set would answer the purpose for any number of houses.

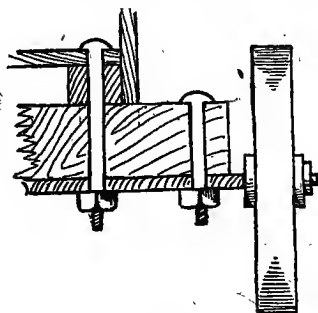

Fig. 6.

These, however, have never proved particularly efficient. Two stout axles made of $4\frac{1}{2}$ in. by $3\frac{1}{2}$ in. quartering should be fixed across the under side of the sills of the house, and to both ends of each a strong stub axle should be securely bolted.

28 HOME-MADE POULTRY APPLIANCES

Iron wheels are mounted on the stub axles. Such wheels should not be less than 2 in. in width with a diameter of at least 10 in. Large houses naturally require larger wheels in proportion to the weight which has to be carried.

CHAPTER III

THE VALUE OF PLANS

As I have already suggested, one of the chief advantages of building your own poultry houses and appliances is that you can follow your own ideas. For this reason I cannot hope to illustrate and describe every form and type of house, building and appliance which it is possible to construct. At most I can but give particulars and specifications of sample buildings, but in such a way that the average amateur carpenter should be able to gain sufficient knowledge to enable him to make his own plans and follow them.

The various houses with which I deal are all designed on scientific lines, and the method suggested for constructing them is the most simple which is known. Even if followed in their entirety they will one and all prove highly satisfactory in use.

THE FIRST STEP

When you have once and for all determined in your own mind exactly what form the house or appliance you propose to build is to take, the first thing to do is to place your design on paper. It is

most difficult—with a house of any dimensions, at any rate—to work from a mind picture alone. It doesn't matter at all whether you have learnt drawing or not, you should be able to plan out with a pencil and ruler the different parts of the building.

It is but seldom necessary to draw a plan of the foundations. These can usually be laid straight away. The first plan to tackle is, therefore, the framework. Consider carefully what size framing will be required and locate the exact spot where each joint must be made. This does not necessitate your drawing the framing to scale. It will suffice if the exact measurements are written down, so that, when you come to construct the house, you will know what length each individual piece of wood must be and where each joint must be cut.

This may appear a rather intricate job, but in reality it is nothing of the sort. If you look over any of the plans given in Chapters VII, X, XI, XII, XIV or XV, and read the detailed specifications given in each instance, you will realise that the matter is a quite simple one. Even if it presents a few difficulties at the outset, a little practice will quickly enable you to figure out your own requirements for yourself.

ESTIMATING QUANTITIES

The plan of the framing is the only one which it is essential to draw. From it you will be in a position to estimate the exact quantity of material

required, whether it be framing or matching. From the same plan you can also determine the amount of felt or corrugated iron needed for the roof.

Knowing the length of each piece of framing necessary, the total quantity required can be calculated. There is bound, however, to be a certain amount of wastage, since there will be a number of odd ends left. The wastage can be reduced to a minimum by carefully selecting the original lengths from which the various pieces are to be cut. Many of the odd ends, moreover, will come in handy afterwards for the internal fittings of the house.

It is advisable to reckon that the total amount of framing needed will be 10% to 15% more than the total of the pieces which constitute the framing. This figure is only approximate, since the percentage of wastage depends in great measure on the care which is taken in cutting the various lengths. It may be taken, however, that it is a fair average in the majority of cases. It will be noted that this is the figure I have selected in the examples given.

THE BOARDING

To calculate the quantity of boarding required is also an easy matter. The mean height of the house, its width and length are known, and these measurements are sufficient. The mean height of the house is obtained by adding together the highest and lowest parts of the house and dividing by 2. For instance, a lean-to house $7\frac{1}{2}$ ft. high in front and

6 ft. high at the back has a mean height of $6\frac{3}{4}$ ft. Again, a gable house 9 ft. to the ridge and $6\frac{1}{2}$ ft. to the eaves has a mean height of 7 ft. 9 in.

In estimating the quantity of boarding it must be remembered that there must be an overlap at each end of the back and front equal to the thickness of the matching used.

To obtain the amount necessary for the ends, multiply the mean height in feet by the width of the house and multiply by 2. This will give the quantity for the two ends in square feet.

For the back and front of the house respectively multiply the height by the length, plus double the thickness of the boarding, and the answer is the superficial area to be covered. In the case of the front any wire-netted portion must be deducted.

When it comes to a question of the roof the overlap must be reckoned. It is advisable to allow the roof to protrude at least 3 in. all round, so as to prevent the rain from penetrating. The slope of the roof must also be taken into account, since the exact width of the roof is greater than the width of the house itself.

THE PITCH OF THE ROOF

The pitch of the roof will depend on the material employed. When corrugated iron is used, the slope need not be so great as when wood alone or wood and felt are employed. It is sufficient in the case of a lean-to house if an iron roof has a slope of $7\frac{1}{2}\%$

to 10% of the width of the house; whereas a wooden roof should slope not less than 15% of the width of the house, or, in other words, 1 ft. 6 in. for every 10 ft. in width. A gable house requires a greater pitch to the roof, since the highest part is generally in the centre. In this case the figure just given must be doubled—that is, 15% to 20% must be allowed for an iron roof and not less than 30% for a wooden roof.

In working out the materials required for the roof of a lean-to house allow, in addition to the length of the house, double the thickness of the matching plus 6 in. for overlap. For the width allow, say, 3 in. in a 10 ft. house for the slope plus double the thickness of the match-boarding and 6 in. for the overlap, all of which must be added to the width of the house at the bottom. By multiplying these two measurements together the area of the roof can be determined. The quantity of felt needed can be calculated in the same way, but an additional overlap of 3 in. must be allowed all round for securing underneath the overlap of the wooden roof. This means that 6 in. must be added to both the width and the length.

To ensure a watertight roof the corrugated iron sheets should overlap about 6 in. The bolts or rivets, with washers, must be on the ridge of the iron and not in the valleys; otherwise the roof will leak. Three pounds of rivets are required for every 100 sq. ft. of iron roofing. Felt is generally 32 in. wide, and a 2 in. overlap should be allowed. Broad-

34 HOME-MADE POULTRY APPLIANCES

headed nails must be used for felt, and they should be put in close together wherever two pieces join.

To estimate the requisite material for the internal fittings is not difficult, and therefore does not call for any further notice than that given in Chapter VIII.

CHAPTER IV

MAKING JOINTS

It is not necessary when making small appliances, such as coops, nest-boxes and the like, to join the framing together by letting one piece into the other. These appliances can be made sufficiently strong without going to so much trouble. In the case of poultry houses and the permanent sheds it is essential to make firm joints wherever two pieces of wood meet.

All joints should be cut to fit tightly, the one piece into the other, and to secure them they should be fastened with wooden pegs and the whole glued. If the joints have been properly made they will be as strong, if not stronger than the original wood.

Figs. 7 and 8 illustrate the various joints in common use in poultry house construction, and they explain themselves.

In Fig. 7 A and B represent those joints in which one-half of each piece of wood is cut away. These are joints at right angles. C and D show a half and half joint at an angle of 45 degrees, or half a right angle above the horizontal. E and F show a corner joint used in erecting a small portable run.

A better joint than the half and half is that shown

in A and B (Fig. 8), and known as the tenon and mortise joint. In this case one-third of the end of one piece is left, and this fits into a hole, corresponding in size, either at the end or in the length of the

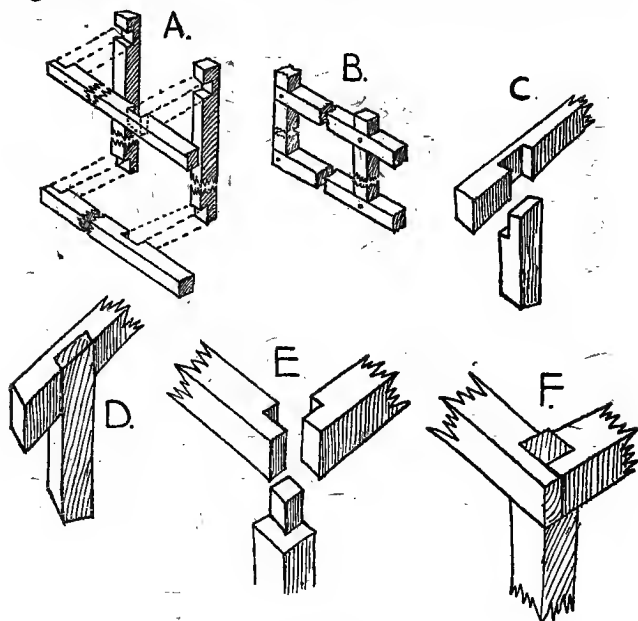

Fig. 7.

second piece. This joint is very much stronger, and should always be used for large structures.

C and D in Fig. 8 illustrate a good method of joining the rafters and the ridge together in a gable house. E shows a simple method of attaching the framing of the roof to the rafters. The rafters are bolted to the roof framing, but to give added support a small block of wood is also used.

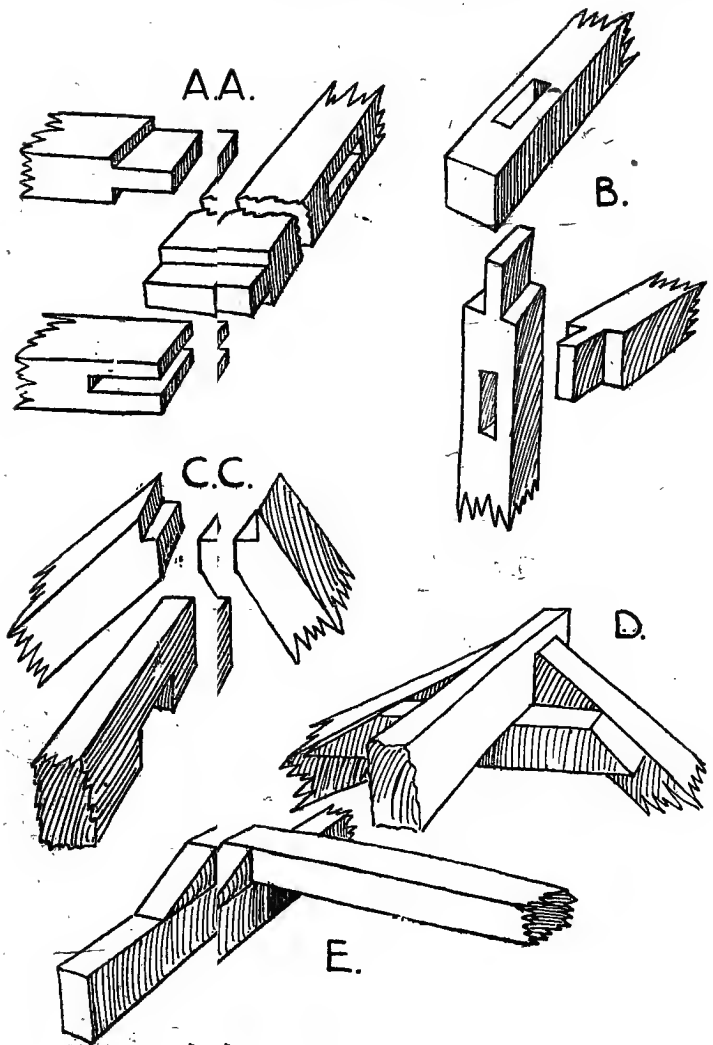

Fig. 8.

NAILS, SCREWS AND BOLTS

The best nails to use are what are known as cut-iron nails. Wire nails are frequently recommended, but I have not found them so satisfactory.

When dealing with 5-in. to 7-in. matching, two nails should be driven into each support in each board. Wider boarding requires three nails. Have them sufficiently long to take a good grip of the framing. With 1-in. boarding 2-in. to 2½-in. nails should be employed. For appliances necessitating the use of thinner wood and smaller framing shorter nails answer the purpose admirably.

The use of screws is practically confined to hinges, locks and catches. It is but seldom necessary to use them for other purposes. All screws should be oiled before use. If this be done they will come out easier when the necessity arises.

It is found very much better to make all houses and sheds in sections—that is, the sides and ends separate—and to bolt them together. The length of the bolts will, of course, depend on the thickness of the framing. They should be ½ in. to ¾ in. in diameter, and two washers should be used with each, one below the head of the bolt and one below the nut. All nuts and bolts should be oiled before being used. Keep the heads of the bolts outside, since by so doing the nuts are not so likely to get rusted on to the thread of the bolts

CHAPTER V

LAYING OUT A POULTRY YARD

THE primary object of this book is to deal with poultry plant construction, but it would be incomplete if no reference were made to the important subject of planning the poultry yard.

There are a number of points to be taken into consideration, and therefore these must be dealt with, at any rate, briefly. The selection of the site is the first in order of importance. It is extremely difficult to secure a house and sufficient land so arranged and of such a nature that it is eminently suited for poultry-keeping. One cannot expect to attain one's ideal, but there are certain characteristics which, when present, make the site valueless from the poultry-keeper's point of view.

The ideal is a gentle southerly or south-westerly slope, well protected on the northern and eastern sides. North-east winds must be guarded against as much as possible, since they tend to affect the egg yield considerably. Failing natural protection, artificial shelter must be provided.

SOILS AND SUBSOILS

It is unquestionably true that soils have a very great influence on animals and birds existing there-

on. To such an extent is this influence noticeable that it has been proved that on certain soils it is quite impossible to keep some classes and breeds of poultry successfully.

When the production of table poultry is the object in view, clay land must be avoided. Heavy, wet land is particularly deleterious to those birds which belong to the table class. No birds thrive very well on such soil, but the yellow-legged varieties appear to suffer least in this respect.

A good porous subsoil is highly desirable. This induces natural drainage, a state of affairs which is an essential factor in poultry-keeping. The presence of a hard pan or crust on the subsoil, or below a thin subsoil through which the water cannot percolate, will render the upper soil wet. If the natural drainage is not sufficient to allow the surface water to pass away quickly, artificial drainage by pipes or some other method must be resorted to. This is a costly undertaking; hence the necessity for selecting a piece or area of land which will not retain any excess of water.

A medium loam on a porous subsoil is excellent for fowls. The land can be kept in good heart without any undue danger of becoming foul or tainted with the poultry manure which it receives. Naturally, the ground must not be overstocked, but a considerable number of birds can be maintained on such soil year in and year out with careful management.

There are certain precautionary measures which

should be taken to ensure against any trace of tainted land, and the principal one is the provision of dual runs to each house. This can, of course, only be done when there is sufficient land available, but an endeavour should always be made so to arrange the house that it is possible.

PLOTTING OUT THE LAND

At the outset the arrangement of the permanent buildings should be decided. Among these will be numbered the food store and mixing room; a fattening shed; sitting-hen house; and incubator shed. These should be erected as near the dwelling-house as possible, since this will reduce labour considerably.

Allowing Room for Extension

A word must be said here with reference to possible future requirements. Don't build with the idea that the sheds erected in the first place will always prove sufficient for your needs. It may be, and in all probability will be, necessary to enlarge all of the permanent buildings as time goes on. Allow room for this, so that it will be a simple matter to provide more accommodation when success warrants increasing the stock.

Take this point into consideration when designing all of the buildings. Make the end facing the direction in which extension will take place as a separate section, so as to allow for additions. It will be found cheaper in the long run if this be done.

42 HOME-MADE POULTRY APPLIANCES

Otherwise new buildings will have to be erected at a later date, perhaps some distance away.

What has been said as regards the permanent structures is equally true of the poultry houses. Ranges of scratching sheds, ranges of individual houses, even the brooder house, should be so arranged that uniform extension is possible.

Special Features

Allocate the most suitable parts of your land to those branches which will do best thereon. An orchard, for instance, if not too far away from the dwelling, makes an ideal ground for rearing. Not only should the brooder house be erected here, but the coops and brooders should also be situated in the same place.

A special field should be set apart for growing stock. Whenever possible such birds should be given their entire liberty. A field with plenty of natural shelter should be selected, otherwise this will have to be provided.

A running stream should be made use of for breeding ducks. The house and run should be arranged in such a way that each flock of, say, ten ducks and three drakes can be housed apart and each with access to the water.

Face all houses towards the south or south-east. This will afford the birds the maximum amount of sunshine and protect them from the cold winds from the north and east.

Footpaths

It will be found that it pays to lay down footpaths to the permanent sheds and poultry houses. The cost of tracks made of cinders or rubble is not great, and their value during the winter months more than counterbalances the capital outlay.

THE SMALLHOLDER'S POULTRY PLANT

As an indication of what can be accomplished on an acre of land under poultry the suggested plan on page 44 may prove useful.

The area covered by the outside lines in Fig. 9 represents practically an acre of grass land. Divided as shown, and explained later, an acre of grass land will maintain 150 to 200 birds for many years without any danger of the soil becoming overcharged with manure.

The plot measures 68 yds. by 68 yds. Round the three sides—that is, excepting the south—pens are wired off 17 yds. square. This gives 10 pens, each 289 sq. yds. The centre plot of land will consist of 1734 sq. yds., which can either be left open as a rearing ground or divided into 4 runs each $25\frac{1}{2}$ yds. by 17 yds., but rather less in the case of plot D, on which are erected the permanent buildings.

It is suggested that a range of eight scratching sheds for laying fowls, each $25\frac{1}{2}$ ft. long by 8 ft. deep, should be erected along the north boundary. This arrangement gives two houses to each run—the

The remaining six pens would each accommodate an individual poultry house for breeding stock. It would be an advantage if each of these runs were divided into two, so that the dual run system would be followed.

By having the runs 17 yds. square a 50-yd. roll of netting would be sufficient for each, without cutting, to cover three sides, but leaving room for the door. The range of sheds at the north would fill in the remaining fourth side.

The gates are denoted by a cross. It is generally found better not to erect gates allowing passage from one run to another. This must be done, however, on occasion, but there is always a danger that a gate may be left open, in which case carefully selected pens might get hopelessly mixed.

THE BACKYARDER'S PLANT

The opportunities of the backyarder are distinctly limited, but, all the same, care should be taken to arrange the house and run or runs in a convenient manner.

The front of the house should face south or southwest, and the run should be protected on the north and east by making the walls solid. This is generally an inexpensive matter, since the garden wall can be utilised for this purpose on one side, if not two.

It is highly desirable to provide two runs to each house. Owing to the restrictions of space the run cannot be made very large, and therefore there is

considerable danger of the ground becoming tainted. On the dual run system one run can be cropped as part of the garden while the other is occupied by the birds.

A suitable house is described and illustrated in Chapter VII, and the single and dual run systems are dealt with in Chapter IX, to which readers are referred.

CHAPTER VI

GENERAL PRINCIPLES OF POULTRY PLANT CONSTRUCTION

THERE are hundreds of designs of poultry houses and allied buildings extant. Many of them are excellent ; others are unsuitable for the purpose for which they were constructed. The details of construction do not signify at all so long as the structure has been designed in such a way that the essential principles have been embodied in it.

The general principles which are requisite are few in number, but they are essentially important. They are size, height and cubic air space ; lighting ; ventilation ; the roof ; and the floor. These five make up the list, and since the last two mentioned have been dealt with fully in Chapter II, I shall confine my remarks to the three first enumerated.

FLOOR SPACE PER ADULT BIRD

To overcrowd is to invite trouble. To undercrowd—if I may use such a word—is almost as bad in its effects. The superficial area of floor space allowed for each fowl depends largely on the system under which they are kept. The following figures have been proved to give the best results :—

48 HOME-MADE POULTRY APPLIANCES

Two square feet per adult bird should be allowed in the house when only a roosting compartment and a run are provided ;

With a roosting chamber and scratching shed house, with run, 2 sq. ft. of floor space must be allowed in the former and 4 sq. ft. in the latter ;

A combined roosting and scratching shed in one, with run, must be sufficiently large to give 4 sq. ft. to each fowl ;

An intensive house, in which case the birds are but seldom given a run out in the open, should only contain that number of birds which will allow 8 sq. ft. to each.

In the case of a half-way house for growing stock from 2 to 4 months old, 1 sq. ft. to 1½ sq. ft. of floor space need only be reckoned as necessary.

Ducks should be allowed 4 sq. ft. of floor space ; geese 6 sq. ft. to 8 sq. ft., according to breed ; and turkeys 8 sq. ft. to 10 sq. ft.

The superficial area of the floor is obtained by multiplying the width of the house by the length. Inside measurements should be taken in both cases. The area of the floor in square feet divided by the figures given above will determine the capacity of the house.

Head Room Essential

A low house is an abomination. It is bad for the birds, and it renders the work of cleaning and attention to the fowls more difficult.

The height of the house must be governed by the

class of birds for which it is erected. Houses for growing stock—which should not be allowed to perch—ducks and geese need not be so high as those employed for housing adult fowls.

A mean or average height of 4 ft. 6 in. is ample for half-grown birds and ducks; and 5 ft. for geese will prove sufficient. An ordinary poultry house should have a mean height of 5 ft. 6 in. to 6 ft. A turkey shed requires to be higher, and an average height of 8 ft. is a convenient basis on which to work.

CUBIC AIR SPACE

From the figures given above it will be seen that birds under different conditions will require the following allowance of air space each:—

Roosting house, with run .	12 cub. ft. per bird.
Roosting and scratching shed compartment house	12 cub. ft. and 24 cub. ft. respectively.
Combined roosting and scratching shed house .	24 cub. ft.
Intensive house . . .	48 cub. ft.
Half-way house . . .	4½ to 6 cub. ft.
Duck house	18 cub. ft.
Goose house	30 to 40 cub. ft.
Turkey house	64 to 80 cub. ft.

The cubic contents of a house is calculated by multiplying the mean height by the length and the answer to this by the width.

LIGHTING

An abundance of sunlight is a great asset in poultry-keeping. A dark house is very difficult to keep clean and free from vermin and disease germs. All poultry houses should be well lighted, particularly on the south side.

When an open-fronted scratching shed is used there is no further need for lighting, since the sun's rays have free access to every part of the house.

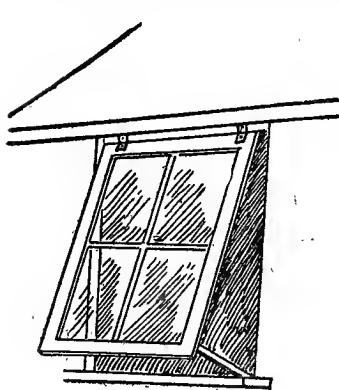

Fig. 10.

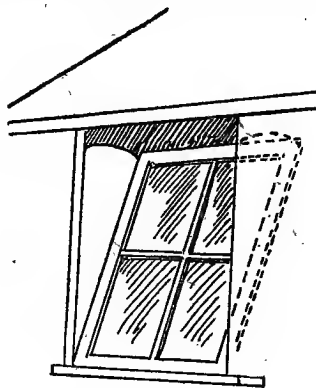

Fig. 11.

This is undoubtedly the best form of house to use, for this and other reasons which will be mentioned later.

Failing an open front to the house, large windows should be built into the house extending almost to the ground. There are many kinds of windows which can be used, the best being the form hinged at the top and opening outwards (Fig. 10) and that hinged at the bottom and opening inwards (Fig. 11).

For incubator sheds the double window as shown in Fig. 12 gives excellent results, since it prevents draught.

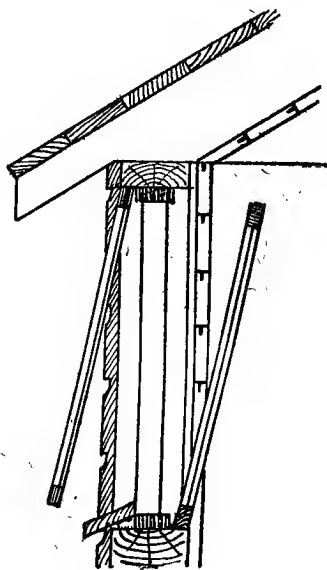

Fig. 12.

VENTILATION

Even though a house be not overcrowded efficient ventilation is a necessity. An opportunity must be given to the impure air to pass out of the building and fresh air to take its place. Impure air, being warm, naturally rises, and therefore all ventilating shafts should be in the highest part of the house.

An open-fronted poultry house is automatically

ventilated, and therefore no further arrangements are necessary.

In small poultry houses the simplest way of arranging for this change of air is by using louvre boards in the highest part of each end of the structure. A convenient form is that shown in Fig. 13, adapted for a gable house.

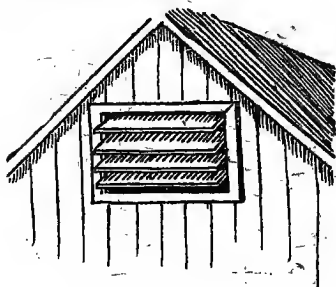

Fig. 13.

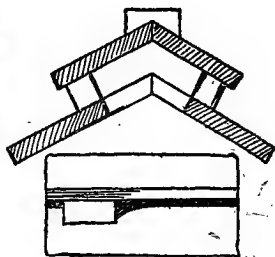

Fig. 14.

Another method, and one which is equally efficient, is to arrange for an air space between the ridge and the roof in a gable house, as is illustrated in Fig. 14. As will be seen, small blocks of wood are placed at intervals to support the ridge itself.

To ventilate an incubator house or brooder house properly it is necessary to arrange the device in such a way that the current of air can be regulated. This is rendered essential, since the volume of air required in each case for the lamps, as also for the embryo chickens within the shell and the chickens, varies. An efficient ventilating shaft is depicted in Fig. 15.

In the case of an incubator shed or brooder house

it is also necessary to arrange for a supply of pure air. This supply should be made to enter about

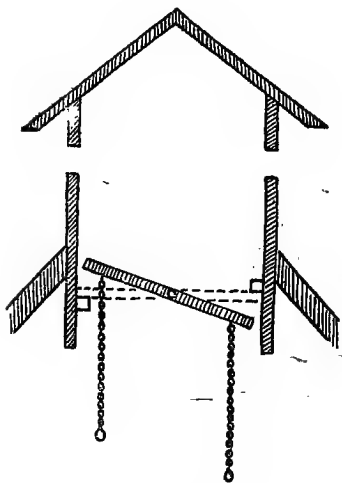

Fig. 15.

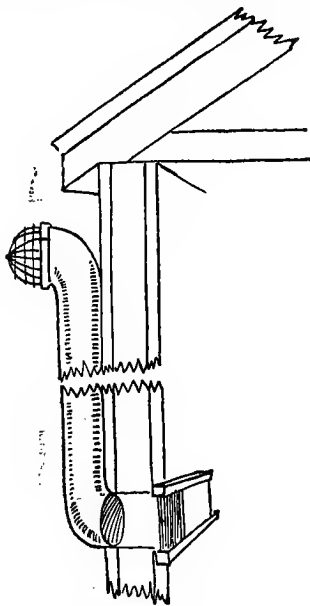

Fig. 16.

1 ft. above the floor. A convenient method is shown in Fig. 16. The pipe—4-in. gutter piping is used—should be placed 6 ft. apart on three sides of the house.

CHAPTER VII

VARIOUS FORMS OF POULTRY HOUSES

PLANS, SPECIFICATIONS AND DETAILED QUANTITIES

AN OPEN-FRONTED SCRATCHING SHED HOUSE

A CONVENIENT size for a house of this description is 10 ft. by 10 ft., 7 ft. high in front and 5 ft. 6 in. high at the back. The ends, back and roof are made solid, as is the lower 3 ft. of the front. The upper part of the front is filled in with $\frac{1}{2}$ -in. mesh netting. The door is in the front, but can be made in the end if thought desirable. A shutter, 2 ft. wide, is fixed at an angle of 45 degrees to the top of the front. The trap-door is placed in the door, but if dual runs are used a second trap-door will be necessary either in the back or one end. The nest boxes—7 in number—are rested on the ground, facing the back and 1 ft. therefrom, with an alley-way 15 in. wide at one end leading to the passage at the back. The top of the nests is continued the whole length and acts as a dropping board under the perches. The perches are placed on top at a height of 5 in. The house is shown in Fig. 17, and the nests and perches in Fig. 34.

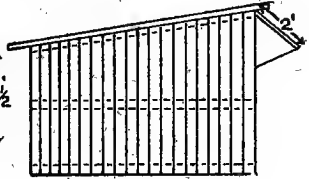
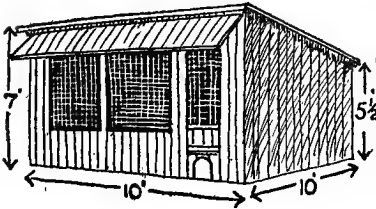

END ELEVATION

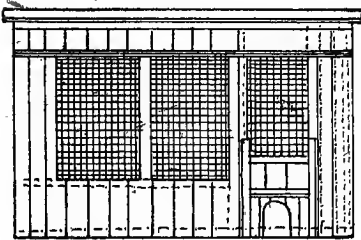

ELEVATION OF FRONT

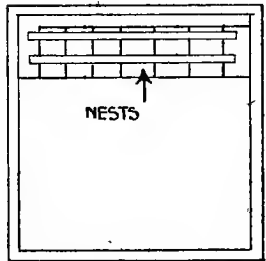

GROUND PLAN

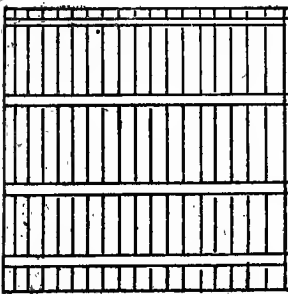

ROOF, UNDER-SIDE



SECTION OF DOOR SHEWING TRAP RUNNERS

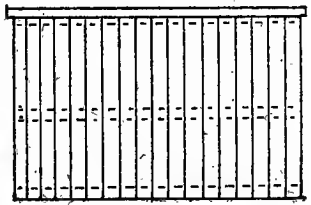

BACK ELEVATION

Fig. 17.

56 HOME-MADE POULTRY APPLIANCES

DETAILED QUANTITIES

FRAMING 2" X 2"	BOARDING T. & G. 7" X 1"
<i>Back.</i>	
3 pieces 5' 7" for uprights	17 pieces 5' 6"
3 " 9' 8" horizontals	1 piece 5' 6" 3" X 1"
<i>End, East.</i>	
1 piece 5' 7" uprights	17 pieces
1 " 7' " "	1 piece 1 X 1 } 5' 6" to 7'
1 " 6' 3 1/2" " "	
2 pieces 10' horizontals	
1 piece 10' 3" " "	
<i>End, West. Same as East End.</i>	
<i>Roof.</i>	
4 pieces 10' 8" rafters	18 pieces 10' 11"
	1 piece 10' 11" 2" X 1"
<i>Front.</i>	
4 pieces 7' uprights	6 pieces 10'
3 " 9' 8" horizontals	11 " 3'
2 " 6' door	1 piece 3' 3" X 1"
3 " 3'	
2 " 3' 2" X 1" } guides	2 pieces 1' 6" trap-door
2 " 3' 1" X 1" } for trap	
<i>Shutter.</i>	
2 pieces 10' 8"	18 pieces 2'
	1 piece 2' 2" X 1"
<i>Perches.</i>	
2 pieces 9' 6"	
<i>Dropping Board.</i>	
	6 pieces 10'
<i>Nests. See Chapter VIII.</i>	
<i>Total, with allowance for wastage :</i>	
2" X 2" 340'
7" X 1" 410 sq. ft.
Netting 34 sq. ft.
Bolts 20, 6" X 3/4"
Hinges 1 pr. 8" T.

If the roof is covered with corrugated iron, six sheets, each 11 ft. long, will be required. In this case 135 sq. ft. of 7 in. by $\frac{3}{4}$ in. sawn boards can be used in place of the same quantity of 7 in. by 1 in. t. & g. In addition, three pieces of 2 in. by 1 in., 10 ft. 8 in. long, will be needed. The rafters, moreover, would have to be made of stouter wood, and for this purpose 2 in. by 3 in. would have to be used.

If the roof is to be covered with felt, 126 sq. ft. of this material would be necessary. Sawn boards could also be used for the roof in place of the t. & g. boarding, the quantity being 135 sq. ft.

ROOSTING AND SCRATCHING SHED COMPARTMENT HOUSE

This house allows for a special roosting chamber 5 ft. by 10 ft. apart from the scratching shed—10 ft. by 10 ft.—and divided therefrom by a solid partition. The roosting chamber is enclosed and ventilated by means of louvre boards in the end and partition. It is glazed by two windows—hinged at the bottom and opening inwards—each 4 ft. by 1 ft. 7 in. The wired front of the run compartment begins 18 in. from the roof and extends to within 14 in. of the floor—the width of two boards 7 in. wide. Three perches are allowed and six nests, as shown in the illustration. The nests can be made outside, as shown in Fig. 33.

58 HOME-MADE POULTRY APPLIANCES

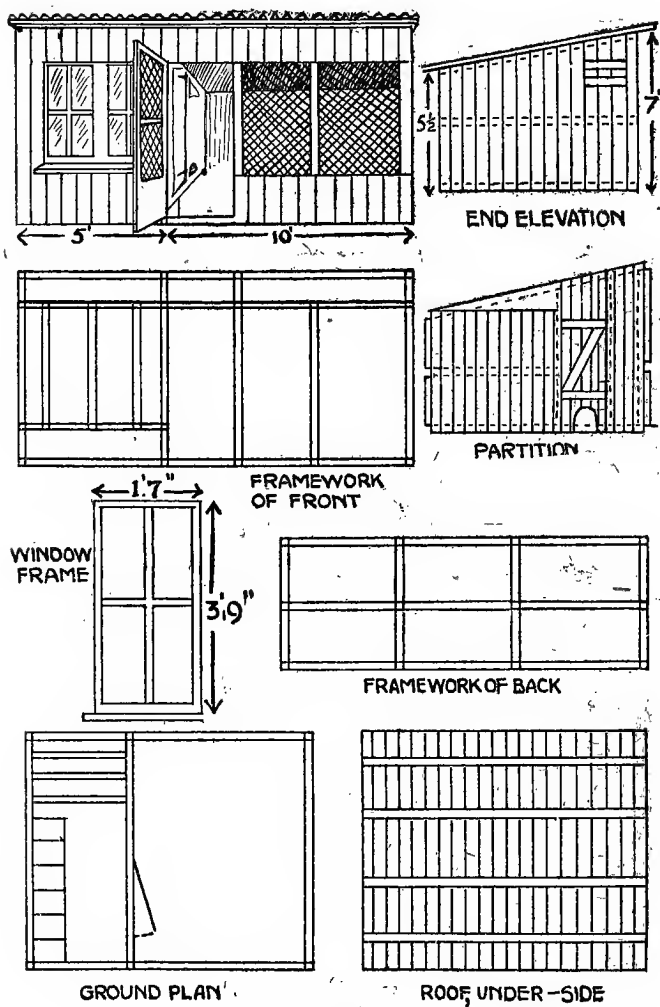

Fig. 18.

DETAILED QUANTITIES

FRAMING 2" × 2"

BOARDING 7" × 1"

Back.

3 pieces 14' 8"
4 " 5' 6"

26 pieces 5' 6"

End (2).

4 pieces 10'
2 " 10' 3"
2 " 5' 6"
2 " 6' 3½"
2 " 7'

17 pieces } 7' to
1 piece 1" × 1" } 5' 6"
17 pieces } 7' to
1 piece 1" × 1" } 5' 6"

Partition.

1 piece 10'
3 pieces 5' 6"
1 piece 10' 3"
1 " 7'
1 " 6' 9"
1 " 6' 4½"

9 pieces 5' 6"
1 piece 5' 6" 1" × 1"
8 pieces 7' to 5' 6"

Roof.

4 pieces 15' 8"

26 pieces 15' 8"
1 piece 15' 8" 6" × 1"

Front.

3 pieces 14' 8"
4 " 7'
1 piece 5' 6"
3 pieces 4'
1 piece 5'

5 pieces 7' <
8 " 1' 6"
2 " 1' 6" 5" × 1"
16 " 1' 6"
1 piece 1' 6" 2" × 1"
2 pieces 7'

Doors.

4 pieces 5' 6"
6 " 3'

2 pieces 3'

Perches.

3 pieces 5'

60 HOME-MADE POULTRY APPLIANCES

<i>Totals.</i>	2" × 2"	..	560'
	7" × 1"	..	550 sq. ft.
	Netting	..	50 sq. ft.
	Bolts	..	33, 6" × ½"
	Hinges	..	2 prs. 8" T, 2 prs. 3" butt
	Glass	..	4 pieces 1' 9" × 1' 7"

If corrugated iron is used, nine sheets 11 ft. long will be required, in which case 200 sq. ft. of sawn boards can be used for the roof instead of 200 sq. ft. of t. & g. If felt is used, 190 sq. ft. will be needed. With an iron and wood roof three pieces of 2 in. by 1 in., 15 ft. 8 in. long, will be wanted to form the air space between the two.

ONE FORM OF PORTABLE HOUSE

The house illustrated in Fig. 19 is an excellent form of portable house. It is built rather low so as to make it sufficiently light for easy moving. It is 9 ft. long, 4 ft. 6 in. wide, 4 ft. 3 in. high at the back and 5 ft. high in front. The front is fitted with a door 4 ft. 6 in. by 2 ft. 3 in., and a sliding shutter 5 ft. 2 in. by 1 ft. 10 in. The opening is 5 ft. by 2 ft. 3 in., and is covered with netting. The perches are placed crosswise, and the nests, placed inside, have a door outside for collecting the eggs. Four wheels, 13 in. in diameter, are fitted on iron stub axles bolted to 3½-in. by 4½-in. quartering.

DETAILED QUANTITIES

	FRAMING 2" × 2"	BOARDING 7" × 1"
<i>Back.</i>		
	3 pieces 9'	15 pieces 4' 3"
		1 piece 4' 3" 3" × 1"

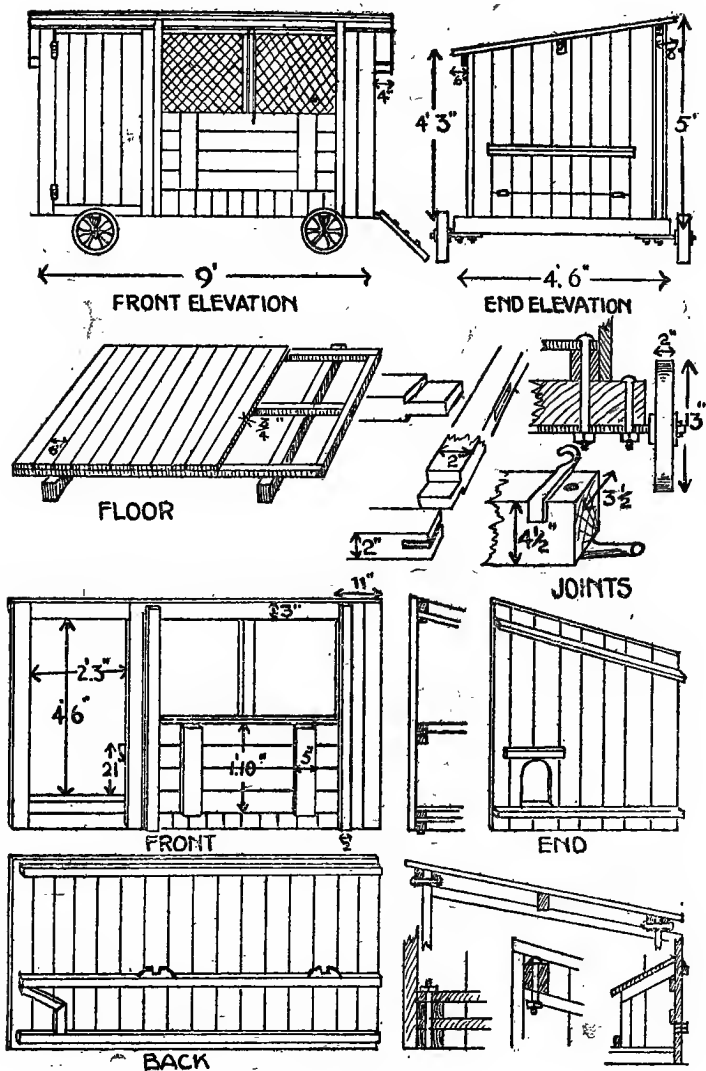

Fig. 19.

62 HOME-MADE POULTRY APPLIANCES

Ends (2).

2 pieces 4' 6"
2 " 4' 8"

7 pieces } 5' to
1 piece 5" × 1" } 4' 3"
7 pieces } 5' to
1 piece 5" × 1" } 4' 3"

Roof.

3 pieces 9' 8" 2" × 1"

16 pieces 5' 10"
1 piece 5' 10" 4" × 1"

Front.

2 pieces 8' 10½"
1 piece 6'
4 pieces 5'
2 " 5' 2" × 1" } for
2 " 5' 1" × ¾" } runner

2 pieces 2' 3" door
7 " 5'
1 piece 5' 6" × 1"
8 pieces 6'
1 piece 6' 4" × 1"

Floor.

3 pieces 8' 10½"

15 pieces 4' 4½"
1 piece 4' 4½" 1½" × 1"

Shutter.

2 pieces 4' 4½"

3 pieces 5' 2"
1 piece 5' 2" 1" × 1"
2 pieces 1' 10"

Perches.

2 pieces 4' 6"

Ladder.

1 piece 1' 6"

Bearers.

2 pieces 5' 6" 4½" × 3½"

Wheels.

4, 13" diameter, 2" tyres.

Totals. 2" × 2" .. 110'
2" × 1" .. 10'
4½" × 3½" .. 11'
7" × 1" .. 240 sq. ft.
Netting .. 6', 2½' wide, ½" mesh
Bolts .. 8, 6" × ½"; 4, 9" × ¾"
Hinges .. 1 pr. 3" butt, 1 pr. 1½" butt

This house can be made of $\frac{3}{4}$ -in. matching, with the exception of the floor, and felted on walls and roof. In this case 195 sq. ft. of $\frac{3}{4}$ -in. matching would be required, and 185 sq. ft. of felt and 45 sq. ft. of 1-in. t. & g.

ANOTHER FORM OF PORTABLE HOUSE

The second form of portable house is that illustrated in Fig. 20. It is 8 ft. long by 5 ft. wide, 5 ft. to the eaves and 6 ft. 6 in. to the gable. Outside nests are fitted as shown. A window 4 ft. long by 1 ft. 9 in. wide is placed on each side. Ventilation is by a movable shutter in the top of each end. There is a door 2 ft. 6 in. wide by 5 ft. 6 in. high, and the trap-door is fitted therein. The house is mounted on two bearers, each 5 ft. 6 in. long, of $4\frac{1}{2}$ -in. by $3\frac{1}{2}$ -in. quartering. Two perches, each 5 ft. long, are fitted at the end opposite the door.

DETAILED QUANTITIES

FRAMING 2" X 2"	BOARDING 7" X 1"
<i>Sides (2).</i>	
6 pieces 7' 8"	28 pieces 5'
8 " 5'	
4 " 4' 2" X 1"	
<i>Windows.</i>	
4 pieces 4' 2" X 1"	
6 " 1' 9" 2" X 1"	
<i>Door End.</i>	
1 piece 5'	} 5' to 6' 6" to 5'
2 pieces 5' 2"	
	8 pieces
	1 piece 4" X 1"

64 HOME-MADE POULTRY APPLIANCES

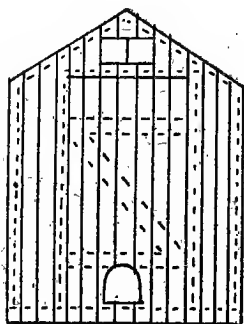
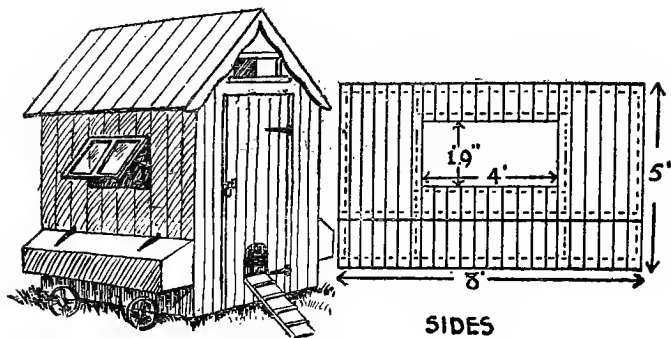

DOOR END

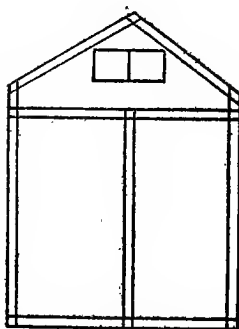

FRAMEWORK OF OPPOSITE
END TO DOOR

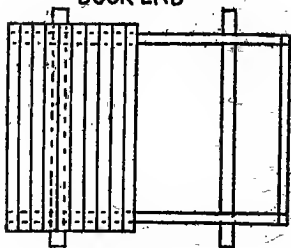

FLOOR

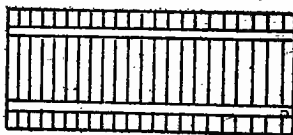

ONE SIDE OF ROOF
(UNDERSIDE)

Fig. 20.

VARIOUS FORMS OF POULTRY HOUSES 65

2 pieces 5' 9"
 1 piece 2' 10"
 2 pieces 3' 1"
 2 " 1' 3" 2" x 1"
 2 " 6" 2" x 1"

2 pieces 2' 6" } for
 1 piece 4' } door

Ladder.

1 piece 1' 6"

End.

2 pieces 5' 2"
 2 " 5'
 1 piece 4' 8"
 2 pieces 3' 1"
 2 " 1' 3" 2" x 1"
 2 " 6" 2" x 1"

8 pieces 4" x 1" } 5' to
 1 piece } 6' 6"
 to 5'

Floor.

2 pieces 8'
 2 " 5'
 2 " 5' 6" 4½" x 3½"

13 pieces 5'
 1 piece 5' 5" x 1"

Roof.

4 pieces 8' 8"

28 pieces 3' 3"
 2 " 3' 3" 6" x 1"
 2 " 8' 8"

Ridge.

<i>Totals.</i>	2" x 2"	..	240'	7" x 1"	260 sq. ft.
	2" x 1"	..	55'		
	4½" x 3½"	..	11'		
	Wheels	..	4, 13" x 2"		
	Stub axles		4		
	Hooks	..	2		
	Bolts	..	4, 9" x ¾"; 16, 6" x ½"		
	Glass	..	4 pieces 1' 9" x 1' 7"		
	Hinges	..	1 pr. 8" T, 2 prs. 5" T, 1 pr. 2" butt		

If made of ¾-in. boarding, except floor, 210 sq. ft. of ¾-in., 50 sq. ft. of 1 in. and 200 sq. ft. of felt will be needed.

66 HOME-MADE POULTRY APPLIANCES

A MEDIUM-SIZED INTENSIVE HOUSE

Figs. 21 and 22 illustrate a reliable design for an intensive poultry house suitable for twenty-five birds. It is 20 ft. square, 6 ft. high in front, 4 ft. high at the back and 8 ft. to the gable, which is 7 ft. 4 in. from the front and 12 ft. 8 in. from the back. It is fitted with two windows, each 3 ft. wide and 4 ft. deep, and a curtained open space 4 ft. long by 2 ft. deep in the front. A door is placed in the east end 3 ft. 6 in. wide by 6 ft. high. A window is also built into the west end, measuring 5 ft. 4 in. wide by 4 ft. 2 in. deep. All three windows are hinged at the top and made to open outwards. Eight nests are placed on the east side between the door and the back. The perches, with dropping-board below, which can be hinged, are placed at the back, as shown in the ground plan. The house is double-walled round the roosts.

DETAILED QUANTITIES

FRAMING 2" X 2"	BOARDING 7" X 1"
<i>Back.</i>	
5 pieces 4' upr.	34 pieces 4'
2 " 10' 4" } hor.	1 piece 4' 4" X 1"
2 " 2" X 3" } hor.	33 pieces 4' sawn boards
2 " 10' 4" } hor.	1 piece 6" X 1" 4' 7" X 3/8"
<i>East End.</i>	
1 piece 4' 2" } uprights	21 pieces } 8' to 4'
1 " 6' 1" } uprights	1 piece 5" X 1" } 8' to 6'
1 " 8' } uprights	12 pieces } 8' to 6'
1 " 7' 3" } uprights	1 piece 4" X 1" } 8' to 6'
1 " 6' 2" } uprights	

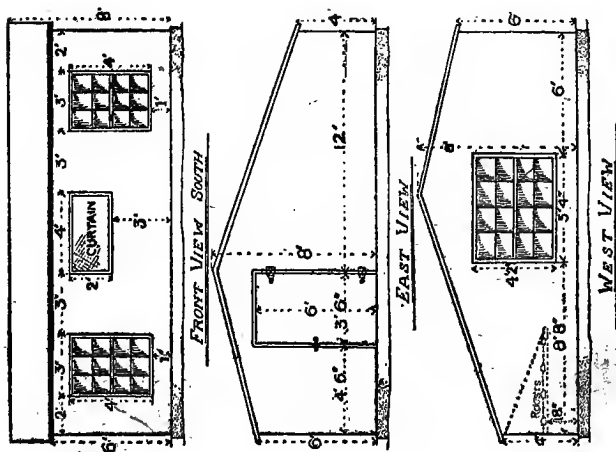

WEST VIEW

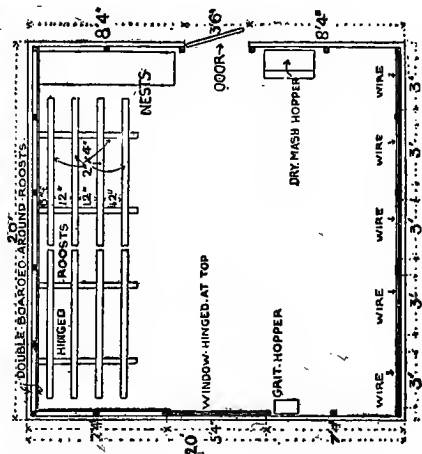
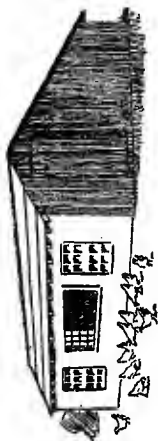

GROUND PLAN

Fig. 21.]

68 HOME-MADE POULTRY APPLIANCES

1 piece 3' 10"	} hor.	21 pieces 8' to 4' } sawn boards
2 pieces 10' 6" 2" x 3"		
1 piece 7' 7"		
1 " 12' 11"		

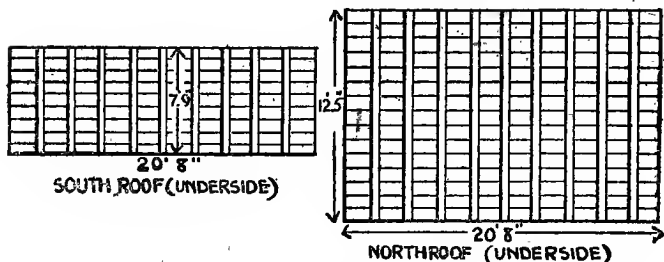

Fig. 22.

West End.

1 piece 4' 2"
 1 " 6' 1"
 1 " 7' 7" 2" x 3"
 1 " 6' 8" 2" x 3"
 2 pieces 10' 6" 2" x 3"
 1 piece 7' 7"
 1 " 12' 11"
 2 pieces 5' 8"

12 pieces 7' 7" to 6'
 9 " " } 2' 5" to
 1 piece 1" x 1" } 2' 10"
 " " } to 1' 6"
 9 pieces 1'
 1 piece 1' 1" x 1"
 13 pieces } 6' 8"
 1 piece 1" x 1" } to 4'
 13 pieces 6' 7" to } sawn
 4', 7" x 5/8" } brds.

Front.

2 pieces 10' 4" 2" x 3"
 2 " 10' 4"
 8 " 6'
 4 " 3' 4"
 2 " 4' 4"

4 pieces 6'
 8 " 1'
 6 " 6'
 6 " 1'
 6 " 3'
 6 " 6'
 10 " 1'
 3 " 6'
 1 piece 6' 4" x 1'

Front Roof.

9 pieces 7' 9" 2" × 3"

13 pieces 20' 8"

1 piece 20' 8" 2" × 1"

Back Roof.

9 pieces 12' 5" 2" × 3"

21 pieces 20' 8"

1 piece 20' 8" 2" × 1"

Ridge.

2 pieces 10' 10" 4" × 1"

Perches.

8 pieces 7' 6"

4 " 5'

Dropping-board.

5 pieces 5' 5"

8 pieces 16'

1 piece 16' 4" × 1"

<i>Totals.</i>	2" × 2"	..	350'
	2" × 3"	..	330'
	7" × 1"	..	t. & g. 940 sq. ft.
	7" × $\frac{5}{8}$ "	..	Sawn boards, 220 sq. ft.
	Felt	..	440 sq. ft.
	Bolts	..	10, 7" × $\frac{3}{4}$ "; 20, 6" × $\frac{1}{2}$ "
	Hinges	..	1 pr. 8" T, 3 prs. 3" butt, 6 prs. 6" T.
	Glass	..	8 pieces 1' 3" × 1' 9", 4 pieces 2' 5" × 1' 10"
	Canvas	..	1 piece 4' 6" × 2' 6"

A LARGE INTENSIVE HOUSE

Large intensive houses are not used in this country very much, but Figs. 23 and 24 illustrate an excellent house for this purpose. It is 40 ft. long by 20 ft. wide, 9 ft. high in front and 5 ft. high at the back. The front is open, with the exception of 3 ft. at the top and 1 ft. 6 in. at the bottom, thus giving 4 ft. 6 in. as the wire-netting portion. There are four canvas-covered frames with which the open

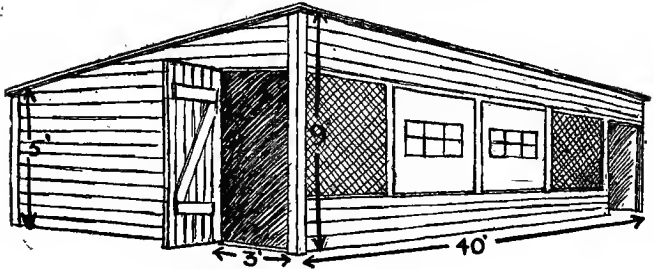

GENERAL VIEW OF HOUSE

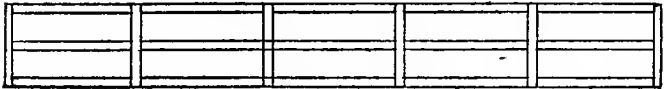

FRAMEWORK OF BACK

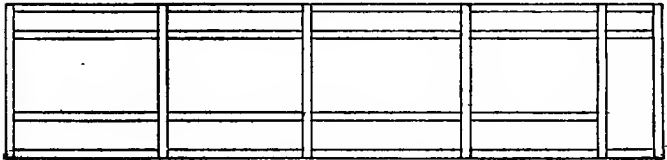

FRAMEWORK OF FRONT

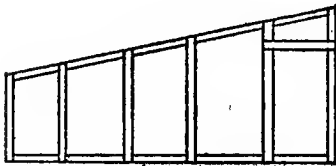

DOOR
END

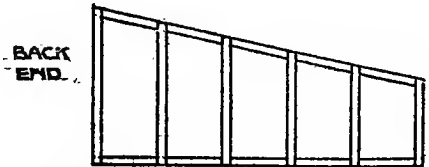

BACK
END

Fig. 23.

front can be covered at will. These are hinged at the top and, when not in use, are secured to the underside of the roof. An opening is cut in each 4 ft. 6 in. long and 2 ft. deep. There are two doors, one in the west end and the other in the east end of the front. The doors are 3 ft. wide by 6 ft. high. Eight perches, each 6 ft. long, with dropping-boards and nests below. This house can be divided into four compartments, if desired, by wire-netting partitions.

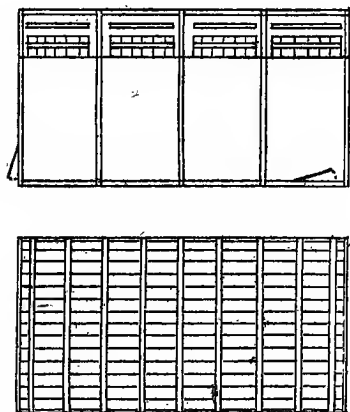

Fig. 24.

DETAILED QUANTITIES

FRAMING 3" X 2"		BOARDING 7" X 1"	
<i>Back.</i>			
6 pieces	5' upr.	68 pieces	5'
4 "	10' 4" hor.	1 piece	5' 6" X 1"
4 "	11' hor.		

72 HOME-MADE POULTRY APPLIANCES

East End.

1 piece	5' 3"	} uprights
1 "	6'	
1 "	6' 9"	
1 "	7' 6"	
1 "	8' 3"	
1 "	9'	
1 "	3' 4"	top of door

34 pieces	} 9' to 5'
1 piece 2" x 1"	

West End.

1 piece	5' 3"	} uprights
1 "	6'	
1 "	6' 9"	
1 "	7' 6"	
1 "	8' 3"	
1 "	9'	

34 pieces	} 9' to 5'
1 piece 2" x 1"	

Front.

6 pieces	9' upr.	} hor.
7 "	10' 4"	
8 "	11'	
1 piece	7' 6"	
8 pieces	9' 4"	2" x 1"
8 "	4' 10"	2" x 1"
16 "	2'	2" x 1"

68 pieces	3'	} 6" x 1"
1 piece	9'	
5 pieces	6'	} 1" x 1" door
1 piece	6'	
62 pieces	1' 6"	} 6" x 1"
1 piece	1' 6"	

Roof.

9 pieces	21' 3"	4" x 2"	72 pieces	10'	7" x $\frac{3}{4}$ " s. brds.
			2 "	10'	3" x $\frac{3}{4}$ " "
			72 "	10' 4"	7" x $\frac{3}{4}$ " "
			2 "	10' 4"	3" x $\frac{3}{4}$ " "

Perches.

8 pieces 6' 2" x 2"

Dropping-board.

16 pieces 10' 7" x 1"
t. & g.

Totals.	2" x 3"	..	500'
	2" x 4"	..	220'
	2" x 2"	..	60'
	2" x 1"	..	170'
	7" x 1" t. & g.		750 sq. ft.

7" × ¾"	..	Sawn boards, 950 sq. ft.
Bolts	..	16, 7" × ¾"; 42, 7" × ½", for roof
Felt	..	900 sq. ft.
Canvas	..	200 sq. ft.
Hinges	..	2 prs. 8" T, 8 prs. 3" butt

A RANGE OF COCKEREL HOUSES

This range of cockerel houses, as illustrated in Figs. 25 and 26, is 8 ft. in width, 10 ft. in depth, 3 ft. 6 in. high at the back, 4 ft. to the ridge, 3 ft. 3 in. high in front and 2 ft. 6 in. high at the front of the run. It is divided into four compartments, each 2 ft. wide. Doors are fitted in the back and also in the front of the runs. Trap-doors are in the front of the houses.

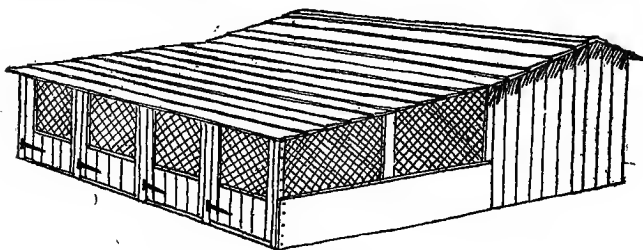

Fig. 25.

DETAILED QUANTITIES

The House Section

FRAMING 2" × 1"

BOARDING 7" × 1"

Back.

2 pieces	7' 10½"	hor.
2 "	3' 6"	upr.
8 "	3' 2"	} for
12 "	1' 9"	

13 pieces	3' 6"
1 piece	3' 6" 3½" × 1"

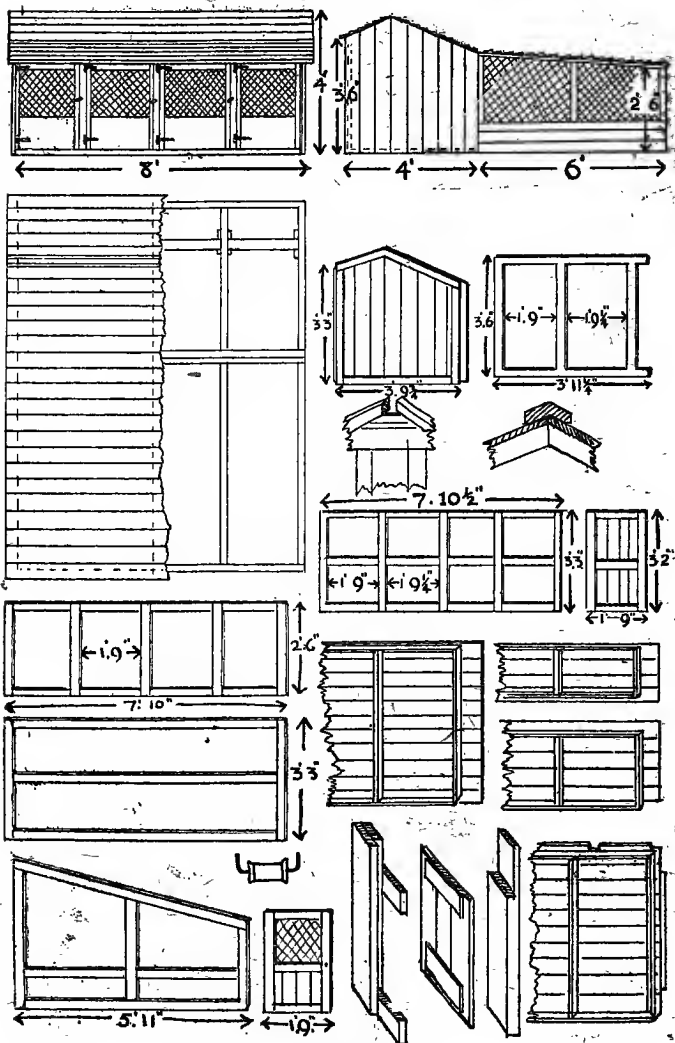

Fig. 26.

VARIOUS FORMS OF POULTRY HOUSES 75

East End.

<table style="border-collapse: collapse;"> <tr> <td style="padding-right: 10px;">1 piece 3' 6"</td> <td rowspan="2" style="font-size: 3em; padding: 0 10px;">}</td> <td rowspan="2" style="vertical-align: middle;">upr.</td> </tr> <tr> <td>1 " 3' 3"</td> </tr> <tr> <td>1 " 3' 9$\frac{3}{4}$"</td> <td rowspan="4" style="font-size: 3em; padding: 0 10px;">}</td> <td rowspan="4" style="vertical-align: middle;">hor.</td> </tr> <tr> <td>1 " 2' 8"</td> </tr> <tr> <td>1 " 1' 8"</td> </tr> </table>	1 piece 3' 6"	}	upr.	1 " 3' 3"	1 " 3' 9 $\frac{3}{4}$ "	}	hor.	1 " 2' 8"	1 " 1' 8"	<table style="border-collapse: collapse;"> <tr> <td style="padding-right: 10px;">6 pieces</td> <td rowspan="2" style="font-size: 3em; padding: 0 10px;">}</td> <td rowspan="2" style="vertical-align: middle;">3' 6" to 4' to 3' 3"</td> </tr> <tr> <td>1 piece 6" x 1"</td> </tr> </table>	6 pieces	}	3' 6" to 4' to 3' 3"	1 piece 6" x 1"
1 piece 3' 6"	}			upr.										
1 " 3' 3"														
1 " 3' 9 $\frac{3}{4}$ "	}	hor.												
1 " 2' 8"														
1 " 1' 8"														
6 pieces			}	3' 6" to 4' to 3' 3"										
1 piece 6" x 1"														

West End. Same as *East End.*

Front.

<table style="border-collapse: collapse;"> <tr> <td style="padding-right: 10px;">3 pieces 7' 10$\frac{1}{2}$" hor.</td> <td rowspan="4" style="font-size: 3em; padding: 0 10px;">}</td> <td rowspan="4" style="vertical-align: middle;">guides for traps</td> </tr> <tr> <td>5 " 3' 3" upr.</td> </tr> <tr> <td>8 " 3' 3" 2" x 1"</td> </tr> <tr> <td>8 " 3' 3" 1" x 1"</td> </tr> </table>	3 pieces 7' 10 $\frac{1}{2}$ " hor.	}	guides for traps	5 " 3' 3" upr.	8 " 3' 3" 2" x 1"	8 " 3' 3" 1" x 1"	<table style="border-collapse: collapse;"> <tr> <td style="padding-right: 10px;">13 pieces 1' 7$\frac{1}{2}$"</td> </tr> <tr> <td>1 piece 1' 7$\frac{1}{2}$" 3$\frac{1}{2}$" x 1"</td> </tr> </table>	13 pieces 1' 7 $\frac{1}{2}$ "	1 piece 1' 7 $\frac{1}{2}$ " 3 $\frac{1}{2}$ " x 1"
3 pieces 7' 10 $\frac{1}{2}$ " hor.	}			guides for traps					
5 " 3' 3" upr.									
8 " 3' 3" 2" x 1"									
8 " 3' 3" 1" x 1"									
13 pieces 1' 7 $\frac{1}{2}$ "									
1 piece 1' 7 $\frac{1}{2}$ " 3 $\frac{1}{2}$ " x 1"									

Floor.

<table style="border-collapse: collapse;"> <tr> <td style="padding-right: 10px;">2 pieces 7' 8$\frac{1}{2}$"</td> </tr> <tr> <td>3 " 3' 9$\frac{3}{4}$"</td> </tr> </table>	2 pieces 7' 8 $\frac{1}{2}$ "	3 " 3' 9 $\frac{3}{4}$ "	<table style="border-collapse: collapse;"> <tr> <td style="padding-right: 10px;">6 pieces 7' 10$\frac{1}{2}$"</td> </tr> <tr> <td>1 piece 7' 10$\frac{1}{2}$" 5$\frac{1}{4}$" x 1"</td> </tr> </table>	6 pieces 7' 10 $\frac{1}{2}$ "	1 piece 7' 10 $\frac{1}{2}$ " 5 $\frac{1}{4}$ " x 1"
2 pieces 7' 8 $\frac{1}{2}$ "					
3 " 3' 9 $\frac{3}{4}$ "					
6 pieces 7' 10 $\frac{1}{2}$ "					
1 piece 7' 10 $\frac{1}{2}$ " 5 $\frac{1}{4}$ " x 1"					

Roof (Back).

<table style="border-collapse: collapse;"> <tr> <td style="padding-right: 10px;">2 pieces 8' 6"</td> </tr> <tr> <td>3 " 1' 11"</td> </tr> </table>	2 pieces 8' 6"	3 " 1' 11"	<table style="border-collapse: collapse;"> <tr> <td style="padding-right: 10px;">14 pieces 1' 11"</td> </tr> <tr> <td>1 piece 1' 11" 4" x 1"</td> </tr> </table>	14 pieces 1' 11"	1 piece 1' 11" 4" x 1"
2 pieces 8' 6"					
3 " 1' 11"					
14 pieces 1' 11"					
1 piece 1' 11" 4" x 1"					

Roof (Front).

<table style="border-collapse: collapse;"> <tr> <td style="padding-right: 10px;">2 pieces 8' 6"</td> </tr> <tr> <td>3 " 2' 11"</td> </tr> </table>	2 pieces 8' 6"	3 " 2' 11"	<table style="border-collapse: collapse;"> <tr> <td style="padding-right: 10px;">14 pieces 2' 11"</td> </tr> <tr> <td>1 piece 2' 11" 4" x 1"</td> </tr> </table>	14 pieces 2' 11"	1 piece 2' 11" 4" x 1"
2 pieces 8' 6"					
3 " 2' 11"					
14 pieces 2' 11"					
1 piece 2' 11" 4" x 1"					

Partitions.

<table style="border-collapse: collapse;"> <tr> <td style="padding-right: 10px;">1 piece 3' 3"</td> <td rowspan="2" style="font-size: 3em; padding: 0 10px;">}</td> <td rowspan="2" style="vertical-align: middle;">upr.</td> </tr> <tr> <td>1 " 3'</td> </tr> <tr> <td>1 " 3' 9$\frac{3}{4}$"</td> <td rowspan="4" style="font-size: 3em; padding: 0 10px;">}</td> <td rowspan="4" style="vertical-align: middle;">hor.</td> </tr> <tr> <td>1 " 2' 7"</td> </tr> <tr> <td>1 " 1' 7"</td> </tr> </table>	1 piece 3' 3"	}	upr.	1 " 3'	1 " 3' 9 $\frac{3}{4}$ "	}	hor.	1 " 2' 7"	1 " 1' 7"	<table style="border-collapse: collapse;"> <tr> <td style="padding-right: 10px;">6 pieces</td> <td rowspan="2" style="font-size: 3em; padding: 0 10px;">}</td> <td rowspan="2" style="vertical-align: middle;">3' to 3' 9$\frac{1}{4}$" to 3' 3"</td> </tr> <tr> <td>1 piece 4$\frac{1}{4}$" x 1"</td> </tr> </table>	6 pieces	}	3' to 3' 9 $\frac{1}{4}$ " to 3' 3"	1 piece 4 $\frac{1}{4}$ " x 1"
1 piece 3' 3"	}			upr.										
1 " 3'														
1 " 3' 9 $\frac{3}{4}$ "	}	hor.												
1 " 2' 7"														
1 " 1' 7"														
6 pieces			}	3' to 3' 9 $\frac{1}{4}$ " to 3' 3"										
1 piece 4 $\frac{1}{4}$ " x 1"														

Perches.

4 pieces 2'

Runs (Back).

3 pieces 3' 3" upr.
2 " 7' 10" hor.

Sides (2), each.

1 piece 3' 3"	} upr.	2 pieces 5' 11"
1 " 2' 10½"		
1 " 2' 6"	} hor.	
2 pieces 5' 11"		
1 piece 6' 1"		

Front.

5 pieces 2' 6"	upr.	12 pieces 1' doors
2 " 7' 10"	hor.	
8 " 2' 2"	} for	
12 " 1' 9"		doors

Roof.

2 pieces 7' 10½"	} back	14 pieces 6' 4"
3 " 1' 10"		1 piece 6' 4" 6" × 1"
2 " 7' 10½"	} front	
3 " 2' 10"		

Partitions (3), each.

1 piece 5' 10"	} hor.	2 pieces 5' 10"
1 " 5' 11"		
1 " 3' 1"	} upr.	
1 " 2' 4"		

Totals.	2" × 1"	..	475'
	1" × 1"	..	From matching
	7" × 1"	..	330 sq. ft.
	Netting	..	75 sq. ft.
	Bolts	..	72, 3" × ½"
	Hinges	..	8 prs. 8" T.
	Catches	..	8

A HALF-WAY HOUSE

A suitable house for partly grown chickens is shown in Figs. 27 and 28. It is 8 ft. by 5 ft., 5 ft. high in front and 4 ft. high at the back. It is somewhat similar to the open-fronted shed shown in Fig. 17, but in this case glass windows are fitted to the front. No perches or nests are required.

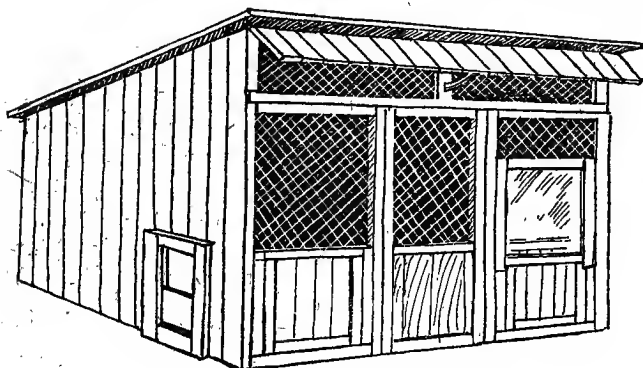

Fig. 27.

DETAILED QUANTITIES

FRAMING 2" x 2"	BOARDING 7" x 1"
<i>Back.</i>	
2 pieces 7' 8" hor.	14 pieces 4'
3 " 4' upr.	
<i>Ends (2), each.</i>	
1 piece 4' 1" } upr.	8 pieces
1 " 5' } upr.	1 piece 4" x 1" } 4' to 5'
1 " 5' } hor.	
1 " 5' 2" } hor.	
<i>Front.</i>	
2 pieces 5'	14 pieces 2'
2 " 4' upr.	
3 " 7' 8"	
2 " 5' 2" hor.	
2 " 4'	
3 " 2' 6" door	
<i>Windows (2), each.</i>	
2 pieces 2' 3"	2 pieces 4' 3" x 1" guides
2 " 2'	

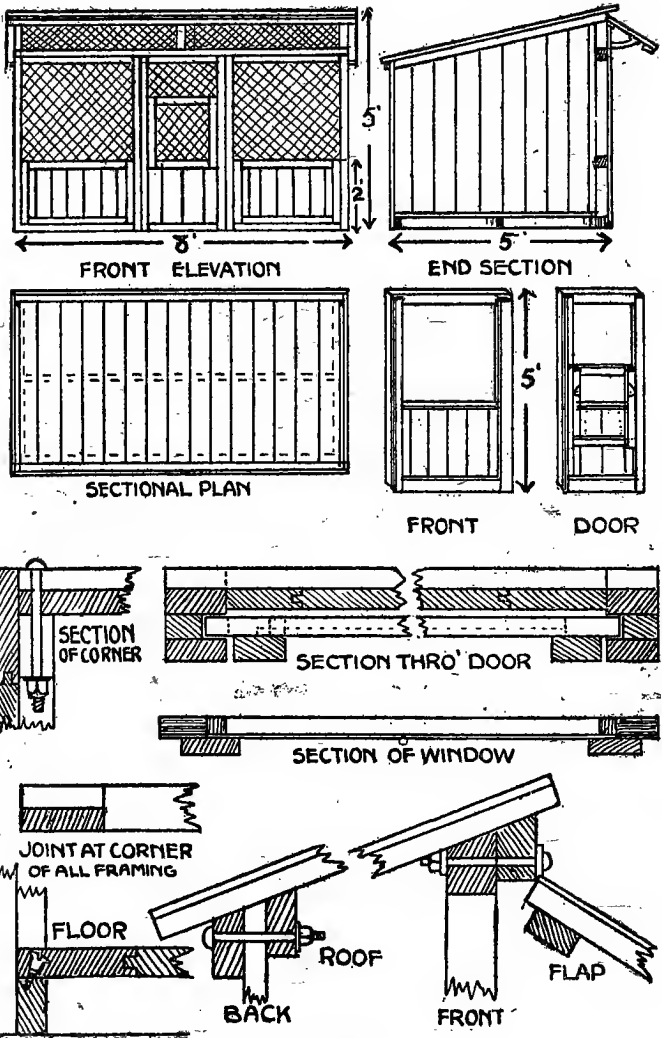

Fig. 28

Window (1), in door.

2 pieces 2' 2"	2 pieces 4' 3" × 1" guides
2 " 2'	

Floor.

1 piece 7' 8"	13 pieces 4'
	1 piece 4' 5" × 1"

Roof.

3 pieces 7' 8"	14 pieces 5' 8"
	1 piece 5' 8" 6" × 1"

Shutter.

2 pieces 8' 8"	14 pieces 1' 6"
	1 piece 1' 6" 6" × 1"

<i>Totals.</i>	2" × 2"	..	200'
	7" × 1"	..	220 sq. ft.
	Netting	..	30 sq. ft.
	Glass	..	2 pieces 1' 11" × 1' 8"
			1 piece 1' 10" × 1' 8"
	Bolts	..	14, 6" × 1/2"
	Hinges	..	1 pr. 4" butt, 2 prs. 8" T.
	Iron support for shutter		1

A BACKYARD HOUSE AND RUN

Fig. 29 illustrates a house and run which is eminently suited to the backyard poultry-keeper. It is 16 ft. long, 7 ft. wide, 6 ft. high in front and 3 ft. 6 in. high at the back. The roosting compartment is 4 ft. by 7 ft. The front is open; but that section belonging to the roosting chamber is partially covered by a movable shutter and the section of the run by two canvas blinds. Outside nests are fitted and there are two doors, one in the partition and one in the front. Two perches are fitted with dropping-board below,

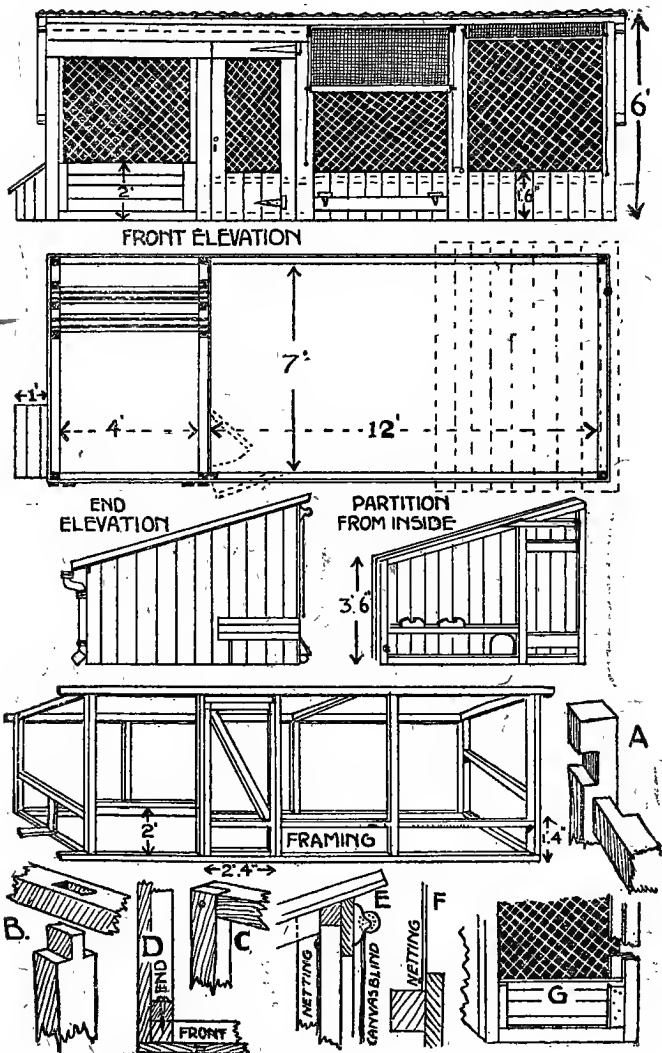

Fig. 29.

DETAILED QUANTITIES

FRAMING 2" X 2"
Back.

4 pieces 3' 6" upr.
2 " 16' 6" hor.

West End.

1 piece 3' 8" }
1 " 6' } upr.
1 " 1' 9" }
2 pieces 6' 8" }
1 piece 7' 1" } hor.
1 " 1' 2" nest

East End.

1 piece 3' 8" }
1 " 6' } upr.
2 pieces 6' 8" }
1 piece 7' 1" } hor.

Partition.

1 piece 3' 8" }
1 " 6' } upr.
1 " 5' }
1 " 6' 8" }
1 " 7' 1" }
1 " 4' 2" } hor.
1 " 2' 6" }

Front.

5 pieces 6' upr.
1 piece 16' 6" }
1 " 17' 3" } hor.
1 " 4' }
2 pieces 4' 7" }
2 " 5' 6" } door
3 " 2' 4" }
1 piece 4' 9" }

BOARDING 7" X 1"

27 pieces 3' 6"
1 piece 3' 6" 5" X 1"

7 pieces 4' 10" to 3' 6"

5 pieces 3' 1" to 4' 3"

12 pieces 3' 6" to 6'

11 pieces } 3' 6" to
1 piece 3" X 1" } 6'
2 pieces 2' 4" door

82 HOME-MADE POULTRY APPLIANCES

Shutter.

3 pieces 2' 11"
 1 piece 2' 11" 3" × 1"
 2 pieces 2'
 2 " 4' 1" × 1" } guides
 2 " 4' 2" × 1" }

Roof.

3 pieces 16' 6"

28 pieces 7' 11"

1 piece 7' 11" 4" × 1"

Perches.

2 pieces 4'

Dropping-board

5 pieces 4'

<i>Totals.</i>	2" × 2"	340'
	7" × 1"	360 sq. ft.
	Netting	75 sq. ft.
	Canvas	50 sq. ft.
	Bolts	25, 6" × ½"
	Hinges	2 prs. 8" T.

If felt is used for the roof, 136 sq. ft. will be required; 150 sq. ft. of sawn boards may be used instead of the same quantity of t. & g. boarding.

CHAPTER VIII

INSIDE THE POULTRY HOUSE

PERCHES

THE best material for perches is ordinary 2 in. by 2 in. batten, with the upper corners rounded off. There are many ways of fixing the perches, as illustrated in Figs. 30, 31 and 34. The principal thing is that all perches should be made movable, so that the sockets or supports may be thoroughly cleaned and disinfected.

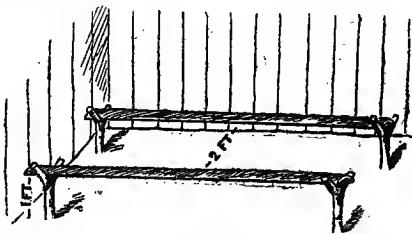

Fig. 30.

In order to save litter and to give extra floor space to the birds it is a good plan to build a dropping-board 5 in. below the perches. The manure collects on this and can be easily removed. This arrangement has the additional advantage of saving the manure in a pure state (see Fig. 34).

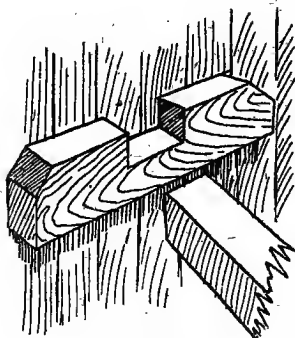

Fig. 31.

Perches for turkeys should be made from fir poles 2 in. in diameter. For these birds a roughly rounded perch is preferable.

NEST BOXES

Nest boxes should be made about 14 in. in width and, in the case of an ordinary nest, 15 in. from

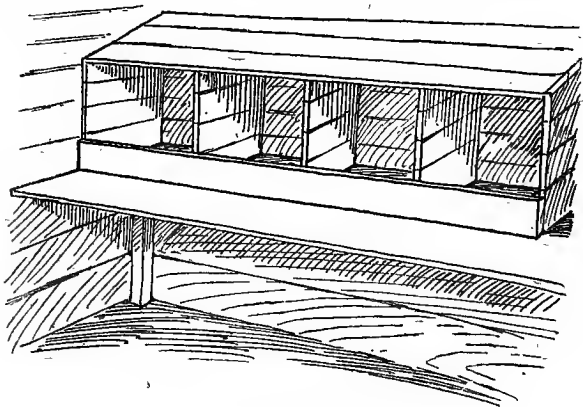

Fig. 32.

front to back, and 12 in. high in front and 18 in. high at the back. A simple form is illustrated in Fig. 32.

To prevent the birds from perching on the top of the nests the latter should be made with a sloping roof.

The construction of external nests is shown in Fig. 33. The diagrams explain themselves, and therefore no further reference is necessary.

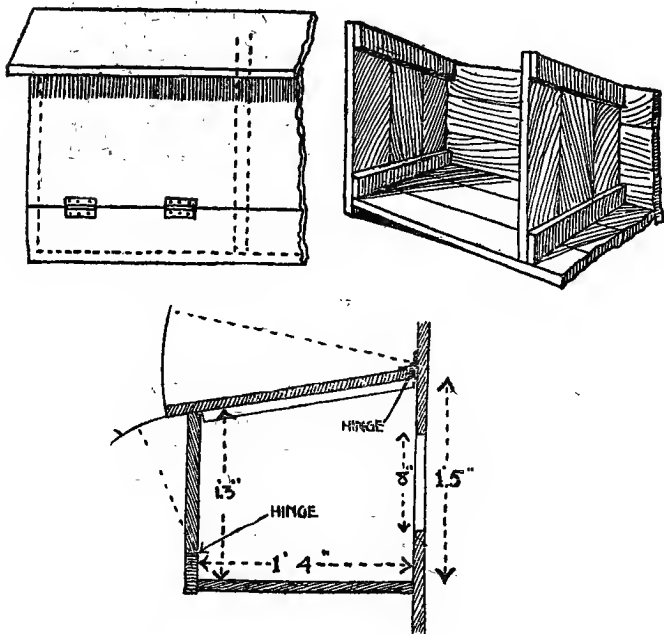

Fig. 33.

COMBINED PERCHES, DROPPING-BOARD AND NESTS

Fig. 34 illustrates one of the most practical arrangements for combining the perches, dropping-board and nests. The perch supports in the figure shown are made of iron and porcelain and are vermin proof. The advantage of this arrangement is that it can be adapted for the use of trap-nests.

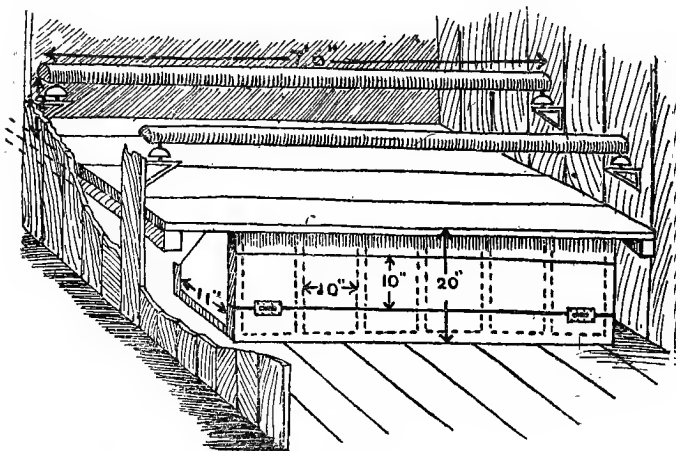

Fig. 34.

TRAP-NESTS

There is a very large number of forms of trap-nests in use to-day. It is impossible to illustrate and describe all, but the three dealt with below will be found practical and simple in use.

Fig. 35 shows a form in which the front is in the form of a lid—hinged at the top—which is held in

position by means of a strip of wood. The hen on entering knocks down this support and the door then closes.

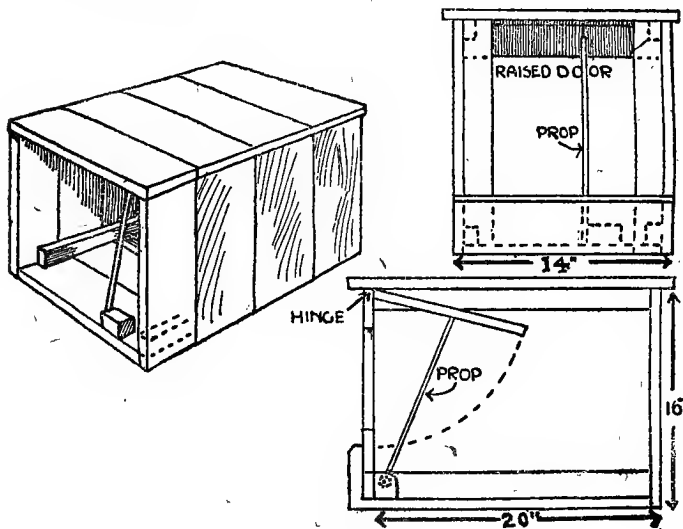

Fig. 35.

Fig. 36 depicts another form of trap-nest. In this case the floor is hinged in front in such a way that the weight of the bird releases the door by the movement of the support nailed to the floor.

The trap-nest illustrated in Fig. 37 is of American design. It is very simply constructed and, as shown in Fig. 38, it can be cut out of a board 10 ft. long, 12 in. wide and 1 in. thick. The materials required is the board mentioned, six screw eyes, a piece of round iron $\frac{3}{8}$ in. by 12 in., two pieces of rawhide 9 in. by $\frac{1}{2}$ in.

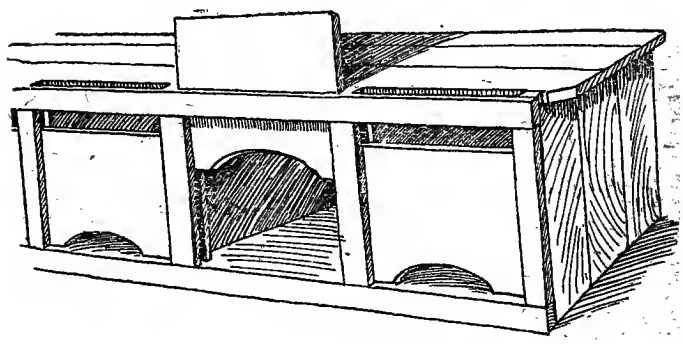

Fig. 36.

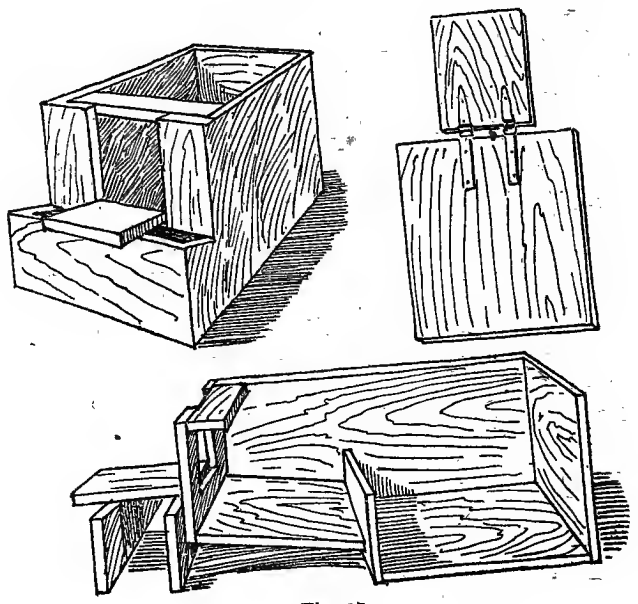

Fig. 37.

The method of construction is as follows: With a square lay off the board as shown in Fig. 38. The shaded portions are the waste pieces. The solid black lines show where the board is to be cut.

Nail the sides to the bottom so that the ends will be even. Stand the nest on end and nail on the back, then nail on the front. Next comes the front brace, which should be set at lines indicated by A and B. To the end of the bottom board nail the nest-end front. The two front pieces are nailed on either side of the door.

Put in the piece— $10\frac{1}{2}$ in. by $3\frac{3}{4}$ in.—on which the door is balanced; nail it in between the sides so that the inner side will be flush with the outer side of the front pieces. In this piece put a screw eye 4 in. from each side, the outer edge of the screw eye being flush with the inner side of the piece.

Bore the holes in the sides through which the $\frac{3}{8}$ in. iron passes. The holes are 1 in. from the bottom and $1\frac{1}{4}$ in. from the nest front. On the bottom of the trip-board put in a screw eye $\frac{7}{8}$ in. from end and 1 in. from each side. At the other end of the trip-board bore two $\frac{3}{8}$ in. holes 1 in. from the end and 3 in. from each side.

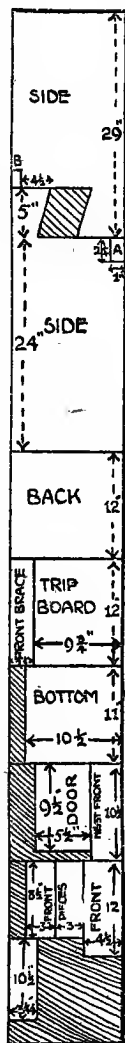

Fig. 38.

On the bottom and each side of the door put in a screw eye $1\frac{1}{2}$ in. from the end and $\frac{3}{4}$ in. from the sides. On the upper side put the two rawhide strips, using a small staple or nail for each. The strips are tacked on so that the end of the strap will be 2 in. from the end and $\frac{1}{2}$ in. from side of door.

Place the door in front of the trip-board, the screw eye down; push the rawhide strips through the holes in the trip-board; turn the boards over and draw the strips up tight; then bend the door back over the trip-board until there is a full $\frac{3}{4}$ in. between the board when laid flat; the strap should then be tacked to the lower side of the trip-board.

TROUGHS

A simple form of trough is shown in Fig. 39. The handle serves a dual purpose, namely, it is convenient for carrying and it prevents the birds from standing in the food. It can also be made V-shaped if desired.

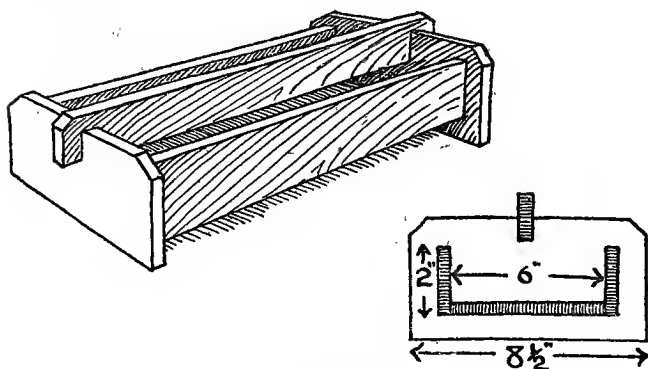

Fig. 39.

In the case of a scratching shed or backyard house it is a great convenience to construct the troughs in such a way that they can be filled from the outside. The trough is hinged at the bottom, as shown in Fig. 40.

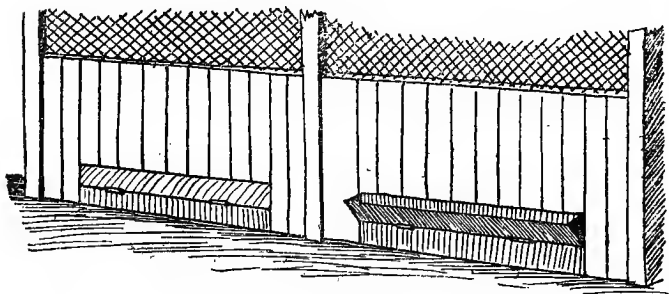

Fig. 40.

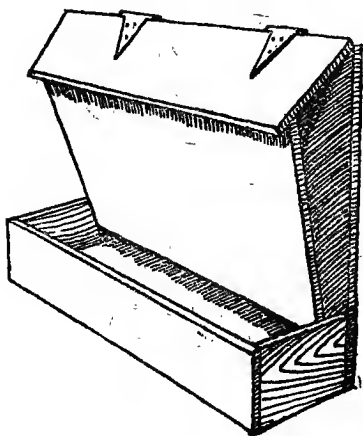

Fig. 41.



SELF-FEEDING HOPPERS

These are suitable for feeding grit, oyster shell, granulated meat and dry mash. The top is in the form of a lid. They can be made any size, but the front of the box should extend at least 1 in. below the sides of the trough.

A GREEN-FOOD RACK

A useful green-food rack, which fits into the wall of the house or run and from which the birds can feed at both sides, is illustrated in Fig. 42. Thick wire, $\frac{1}{8}$ in. in diameter, is used for the bars. They should be placed $1\frac{1}{2}$ in. to 2 in. apart.

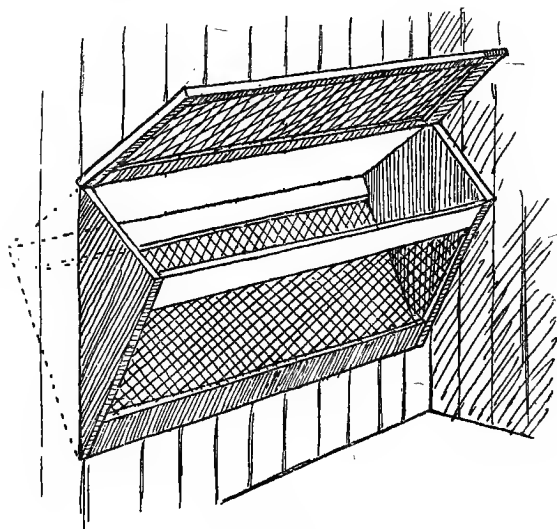

Fig. 42.

GUIDES FOR TRAP-DOORS AND SHUTTERS

The size of the guides depends on the thickness of the wood used for the door or shutter. If 1-in. wood is employed, the centre of the guide can be made of 1 in. by 1 in. and the outer strips of 2 in. by 1 in. The 1 in. by 1 in. and 2 in. by 1 in. can be cut from the matching, unless more of this wood is required for the construction of the house itself. The edge of the trap-door and shutter should be planed to make them fit easily.

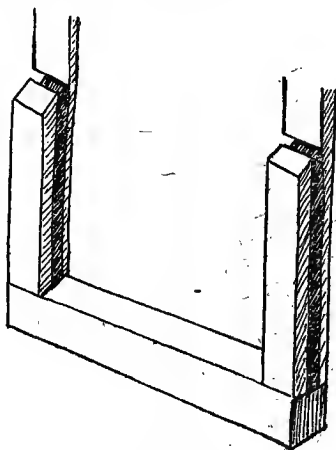

Fig. 43.

AUTOMATIC TRAP-DOOR RELEASE

An explanation of Fig. 44 is hardly necessary, as the sketch fully gives the details of construction. The object of the weight is to balance the false floor, which, by the way, should have an incline of $\frac{1}{4}$ in.

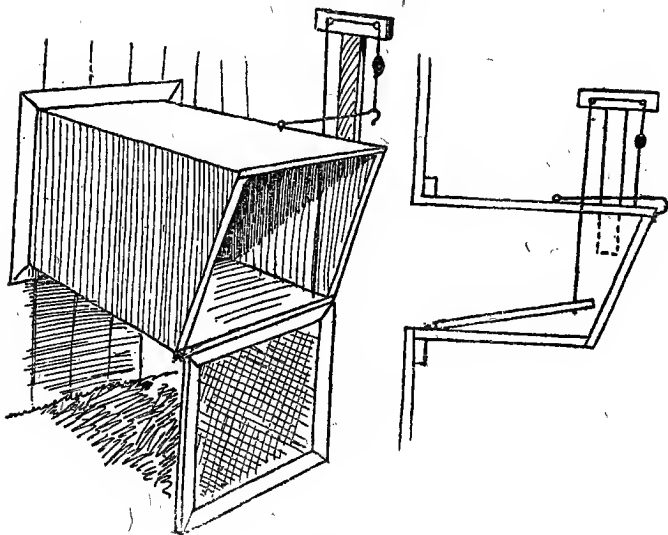

Fig. 44.

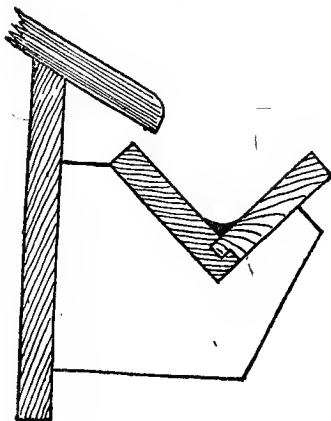

Fig. 45.

RAIN GUTTER

This is not an internal fitting, but it is an addition which it is advisable to make to all houses. Two pieces of 1-in. boarding, one piece 4 in. and one piece 5 in. wide, are fastened together at right angles, and the joint on the inside is rounded off with pitch. It is held in position by means of wooden brackets attached to the house. (Fig. 45).

CHAPTER IX

POULTRY RUNS

SIZE

It may be taken that the larger the run the better. At least a minimum of 13 sq. ft. should be allowed to each adult bird; less means a great danger of tainted soil. A square run is cheaper to construct than an oblong run, since less wire-netting and fewer posts are required. A long, narrow run, however, is better in that the greater part of the manure is deposited near the house. If this near area is laid down in gravel, all fear of tainted soil disappears. Long runs are necessary in the case of a range of houses.

DUAL RUNS

As has already been mentioned, it is an excellent plan to erect two runs to each house. The unoccupied run can be cropped, and thus any excess of manure used up. An arrangement of dual runs for a range of sheds is shown in Fig. 46.

In this instance a raised footpath is made in front of the houses, with a passage below for the birds. This renders it easy to enter any house direct.

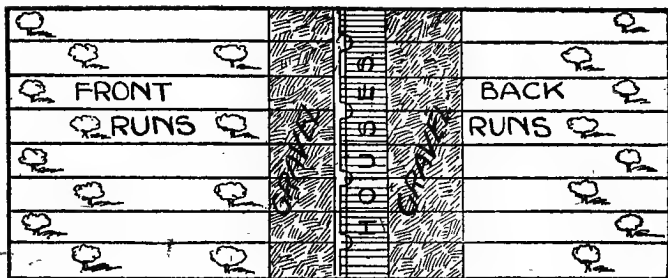

Fig. 46.

GRAVEL AREAS

The use of a gravel area can be adapted to any method of poultry-keeping, whether backyard, breeding pens or laying sheds. This gravel area should be sufficiently large to allow 2 sq. ft. to each bird.

The gravel area is shown in Fig. 46, but another arrangement, in which three gravel runs and one

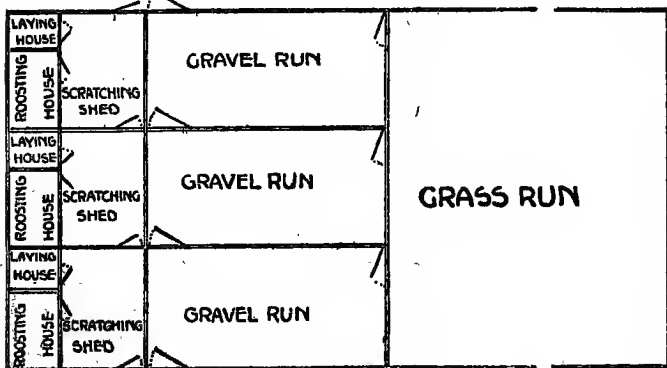

Fig. 47.

grass run are provided for three houses, is illustrated in Fig. 47. This is really a mixture of the intensive system and the scratching-shed run method of poultry-keeping. The birds in each house are allowed out for half a day alternately.

FENCES

It is a very expensive method of enclosing a run to use wire-netted hurdles. For backyards, where appearance goes for so much, or in the event of it being thought advisable to erect movable runs, hurdles as shown in Fig. 48 can be used.

POSTS AND NETTING

As a usual thing, posts made of 2-in. by 2-in. wood is employed for holding the netting. These are driven 18 in. into the ground, and, if 6-ft. netting is used, they should be 7 ft. 6 in. long. When obtainable, ash poles are excellent for this purpose. Frequently as many as 90% will take root and grow, thus providing, in a year or two, natural shade.

All wood which is driven into or comes in contact with the ground should be well tarred or creosoted.

The posts should be placed 4 yds. apart. Corner posts must be strutted to give additional strength, as shown in Fig. 49.

A strand of thick wire should be stretched from post to post. This is fastened to the top of each post by means of staples.

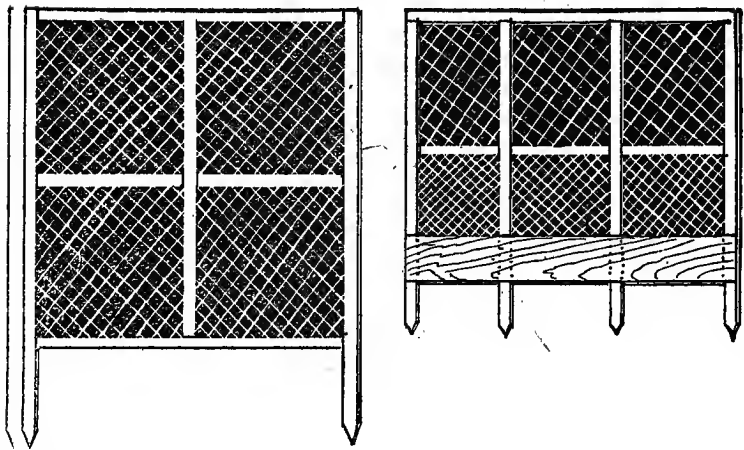

Fig. 48.

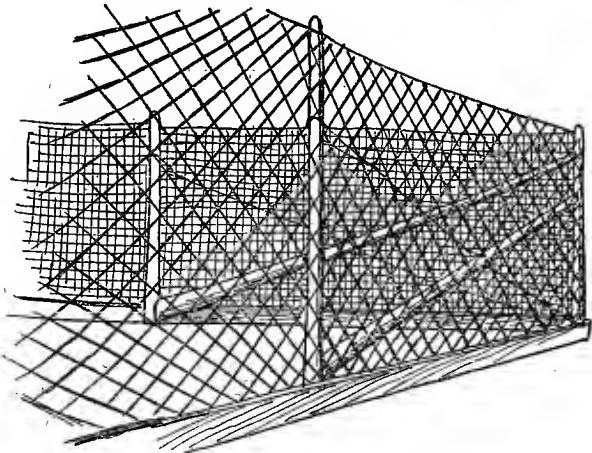

Fig. 49.

For ordinary birds 6-ft. netting is sufficiently high. With the light breeds it is advisable to bend over the top foot of netting inwards to prevent the birds climbing up. In this case spars of wood must be nailed on to the posts at an angle of 45 degrees above the horizontal.

When erecting netting care should be taken to get it well down into the ground; a shallow furrow should be dug and, after the netting has been placed therein, refilled. This prevents the birds from scratching underneath.

GATES

The framework of all gates should be tenon and mortised to give them solidity. Two suitable gates are shown in Fig. 50.

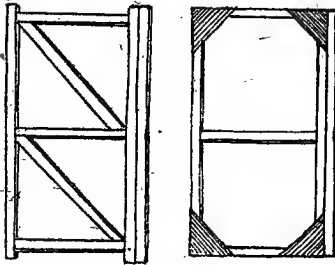

Fig. 50.

CATCHES

Many different forms of catches are employed for the gates. Five kinds are illustrated in Fig. 51. These explain themselves, and therefore need not be described.

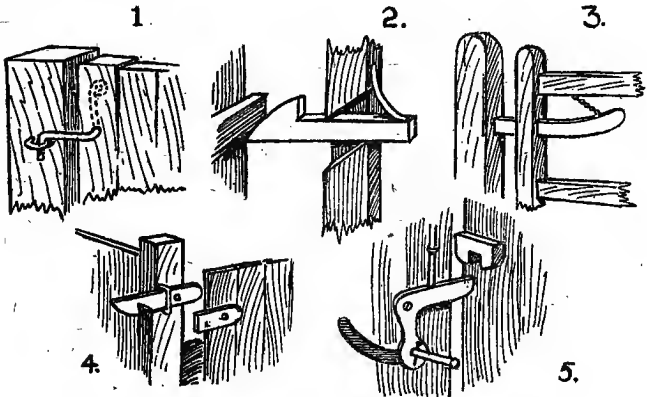

Fig. 51.

CHAPTER X

NATURAL HATCHING—SHEDS AND APPLIANCES

A SITTING-HEN HOUSE

THE best width for a broody hen house is 10 ft. This allows for a row of boxes down each side and a double row in the centre. The length depends on the number of birds to be accommodated. The one which is illustrated in Fig. 52 is 10 ft. in length, 6 ft. high at the back, 9 ft. high in front, and the annexe is 5 ft. wide and 6 ft. high at its lowest part. This house will hold thirty sitting hens, but if shelves are fitted as shown, double this number can be housed. Under the annexe are placed the feeding cages, of which there are twelve in a double row.

DETAILED QUANTITIES

FRAMING 2" × 2"	BOARDING 7" × 1" T. & G.
<i>Back.</i>	
3 pieces 6' upr.	17 pieces 6'
3 " 9' 8" hor.	1 piece 6' 3" × 1"
<i>Ends (2), each.</i>	
2 pieces 10' hor.	17 pieces
1 piece 10' 4" "	1 piece 1" × 1" } 6' to 9'

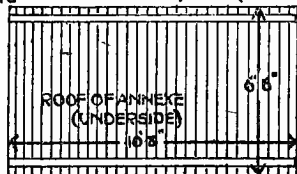
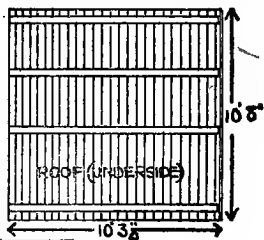
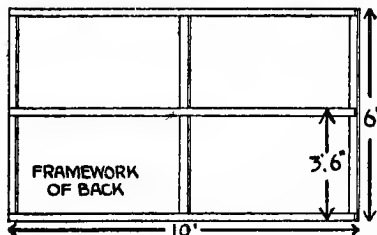
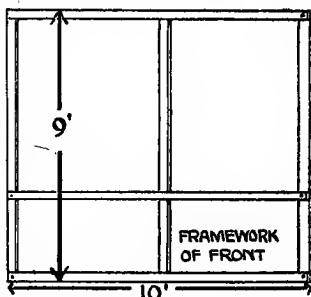
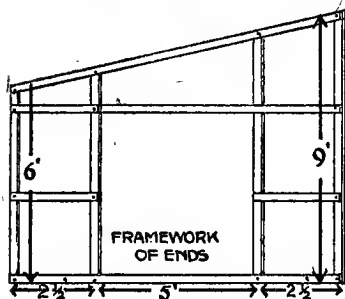
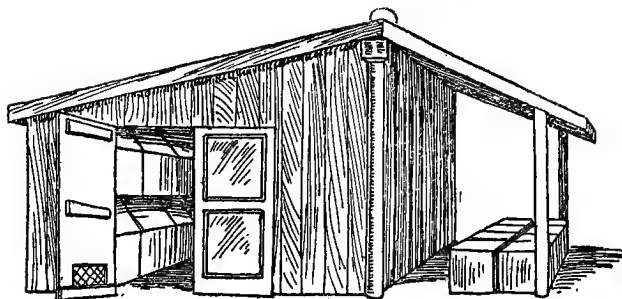

Fig. 52.

104 HOME-MADE POULTRY APPLIANCES

2 pieces	2' 6"	} upr.
1 piece	6'	
1 "	9'	
1 "	7'	
1 "	8'	
1 "	2' 2"	

Front.

3 pieces	9'	upr.	17 pieces	9'
3 "	9' 8"	hor.	1 piece	9' 3" × 1"
1 piece	10' 8"	annexe roof support		

Roof.

4 pieces	10' 8"	18 pieces	10' 5"
		1 piece	10' 5" 2" × 1"

Annexe.

2 pieces	1' 6"	upr.	18 pieces	6' 6"
3 "	10' 8"	roof	18 "	6' 6" 2" × 1"

Ridge.

2 pieces 10' 8"

Totals.	2" × 2"	300'
	7" × 1"	550 sq. ft.
	Felt	200 sq. ft.
	Bolts	18, 6" × $\frac{1}{2}$ "; 4, 7" × $\frac{3}{4}$ "
	Hinges	4 prs. of 8" T.

If felt is used, 220 sq. ft. of sawn boards can be used in place of the same quantity of t. & g.

INSIDE SITTING BOXES

A convenient size for a sitting box is 1 ft. sq. and 15 in. high. No bottom is used—small mesh netting can be employed as a guard against vermin—and the roof is made loose and rather larger and forms a lid. To remove the hen lift her out by one wing, in which case no eggs can get wedged between her legs and her body. Ventilation holes are bored

with a $\frac{1}{4}$ -in. bit at top and bottom. Fig. 53 shows a good example of this form of box.

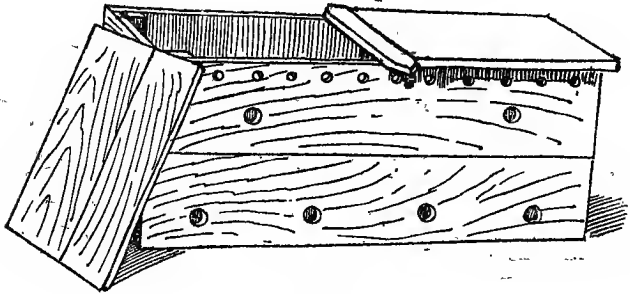

Fig. 53.

FEEDING CAGES

Feeding cages for sitting hens should be made 18 in. square and 18 in. high. If placed in the open the roof will have to be made sloping. Such a cage should be 15 in. high at the back and 21 in. high in front. The door is in the lid. Fig. 54 shows a set of four cages.

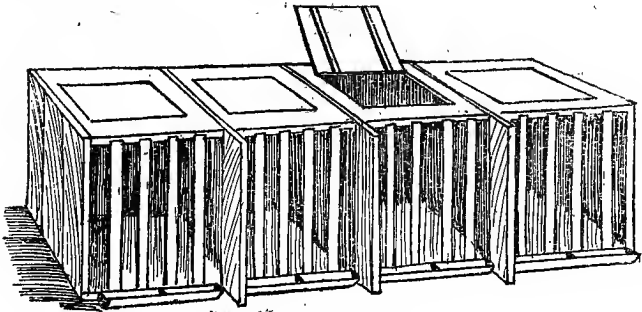

Fig. 54.

OUTSIDE SITTING BOXES

A convenient size for outside sitting boxes is 14 in. square, 16 in. high in front and 12 in. high at the back. The front of the box is made to fit into guides and acts as a door (Fig. 55). The run is 2 ft. long by 14 in. wide, made of 2-in. by 1-in. framing covered with wire-netting.

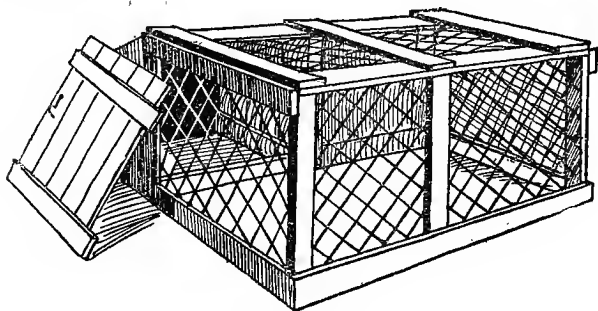

Fig. 55.

SINGLE COOPS

The number of forms of coops is legion. Four kinds are shown in Fig. 56. For early work a wooden floor, made movable, should be fitted. The diagrams will suffice for a description.

DOUBLE COOPS

A double coop, as its name implies, is made in two compartments. A useful size is 4 ft. long, 21 in. wide, 18 in. high in front and 15 in. high at the back. One compartment is 21 in. long; the other section is 2 ft. 3 in. long. The front of the smaller

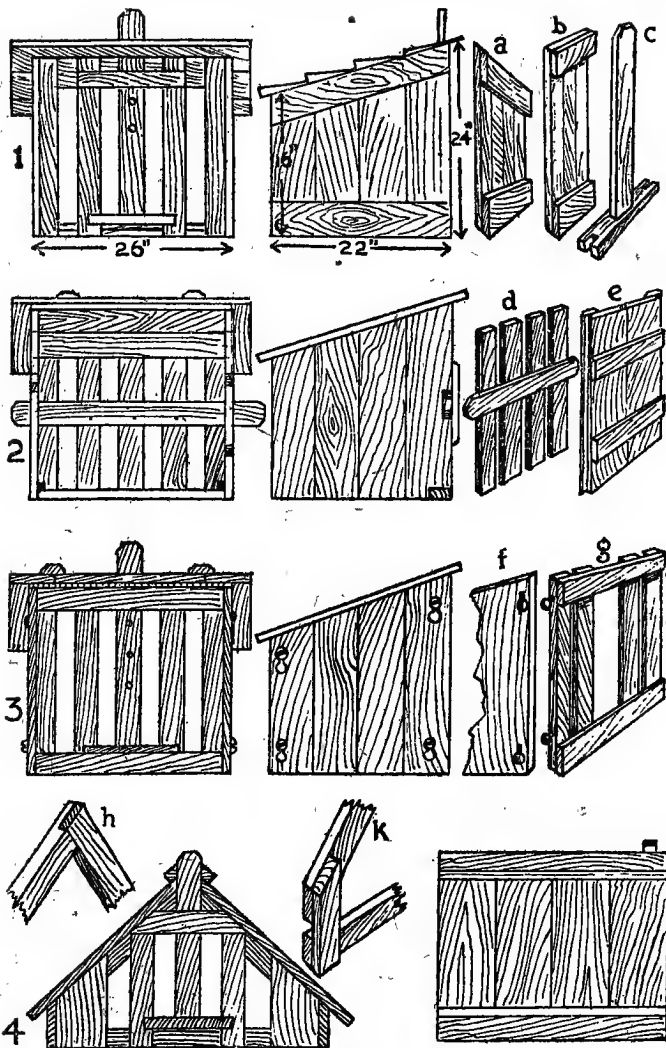

Fig. 56.

108 HOME-MADE POULTRY APPLIANCES

section is fitted with a solid door. The partition and the front of the larger compartment are made of laths of wood $1\frac{1}{2}$ in. by $\frac{1}{2}$ in., placed 2 in. apart. Fig. 57 shows a coop of this description.

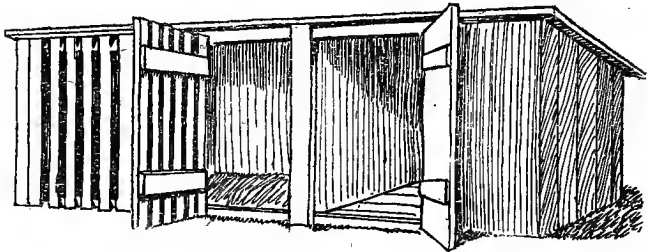

Fig. 57.

Fig. 58 illustrates a similar coop, but in this case the two sections are the same length. The roof, moreover, is hinged in two parts to facilitate cleaning.

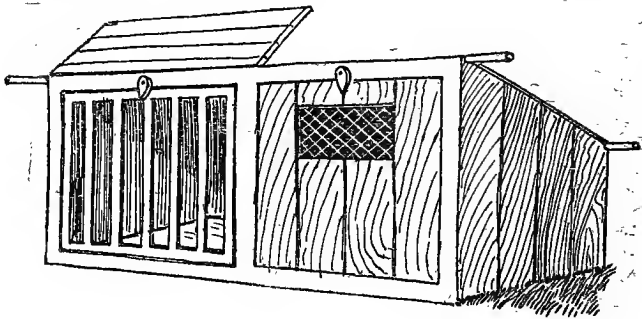

Fig. 58.

A rather elaborate form of coop is that shown in Figs. 59 and 60. It is a very good design, but the

labour involved in building it is considerable. It is 4 ft. long, 18 in. wide, 18 in. high in front and 15 in. high at the back. The two compartments are 21 in. and 2 ft. 3 in. respectively.

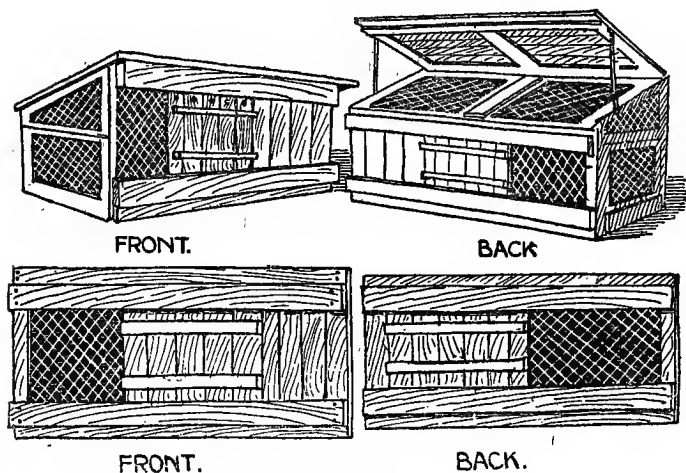

Fig. 59.

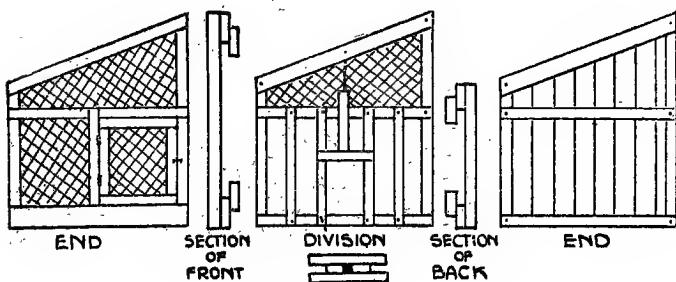

Fig. 60.

CHAPTER XI

INCUBATOR HOUSES & INCUBATORS

A PORTABLE INCUBATOR HOUSE

THE house illustrated in Fig. 61 is 14 ft. long, 8 ft. 6 in. wide, 7 ft. 3 in. high to the eaves and 12 ft. 6 in. high to the gable. There is a lobby 2 ft. 9 in. wide. The framework is 2 in. by 3 in., and the outer boarding is 1 in. thick and the inner $\frac{5}{8}$ in. thick. A false roof is also made resting on the rafters. As will be noticed from the diagram, the ventilation is very efficient.

DETAILED QUANTITIES

FRAMING 2" × 3"	BOARDING 7" × 1"
<i>Back.</i>	
5 pieces 7' 3" upr.	24 pieces 7' 3"
3 " 3' 6" hor.	1 piece 7' 3" 2" × 1"
2 " 8' 6" diag.	
<i>Front.</i>	
5 pieces 7' 3" upr.	17 pieces 7' 3"
2 " 13' 6" } hor.	1 piece 7' 3" 2" × 1"
1 piece 10' 9" }	7 pieces 3'
2 pieces 8' 6" diag.	7 " 5'
<i>End (2) and Partition, each.</i>	
3 pieces 7' 3" upr.	14 pieces { 7' 3" to 12' 6" to 7' 3"
3 " 8' 6" hor.	

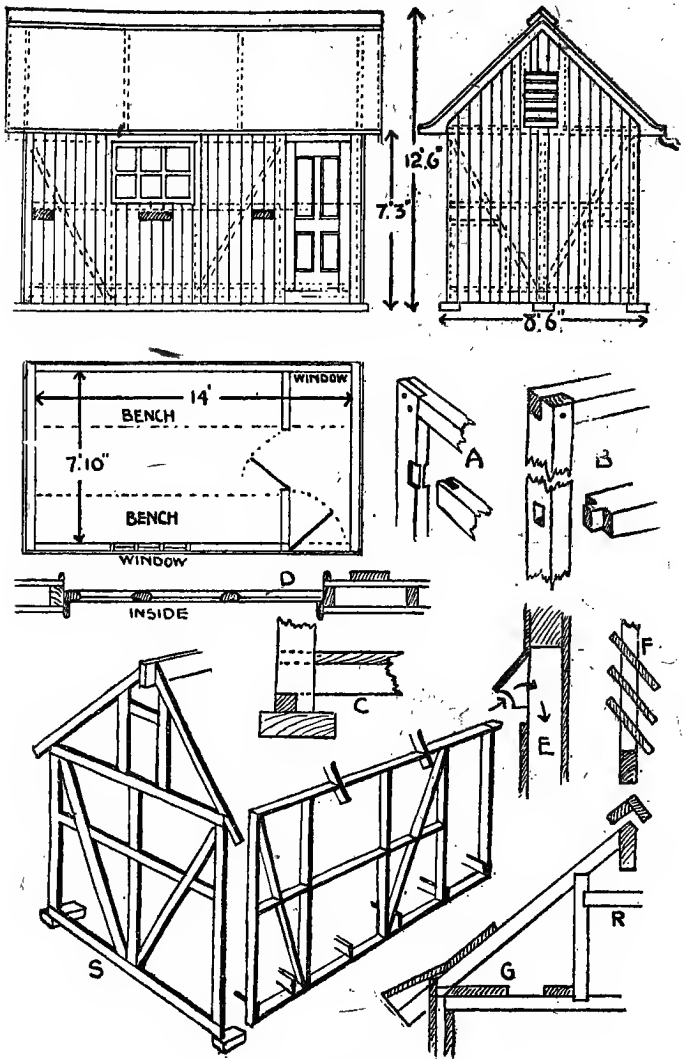

Fig. 61.

112 HOME-MADE POULTRY APPLIANCES

2 pieces 8' 6" diag.	} { louvre boards frames	} { 3/8" sawn boards for partition
2 ,, 7' rafters		
2 ,, 5' 9"		
1 piece 1' 6"		

Roof Rafters (2), each.

2 pieces 7'	50 pieces 7'
2 ,, 4' 9"	
1 piece 8' 6"	
1 ,, 2'	

False Roof.

14 pieces 11' 3"

Floor.

3 pieces 8' 6"	20 pieces 8' 6"
----------------	-----------------

Inside Lining.

91 pieces 7' 3" 7" x 5/8"

Totals.	2" x 3"	..	570'
	7" x 1"	..	1000 sq. ft.
	7" x 5/8"	..	540 sq. ft.
	Bolts	..	20, 8" x 3/4"
	Hinges	..	2 prs. 10" T.
	Window	..	1 4' 1" by 2', hinged at bottom to open inwards

LARGE INCUBATOR HOUSE

A larger incubator shed is that shown in Figs. 62 and 63. This house is 32 ft. long, 16 ft. wide, 8½ ft. to the eaves, 11 ft. to the gable. The lobby is 5 ft. wide. There are four windows, each 4 ft. by 3 ft. 6 in., the upper part of which opens outwards. Ventilation is by pipes and louvre boards in the far end. The house is double-walled, the outer wood being 1 in. thick, the inner 5/8 in. thick. The framing is 2 in. by 3 in. throughout.

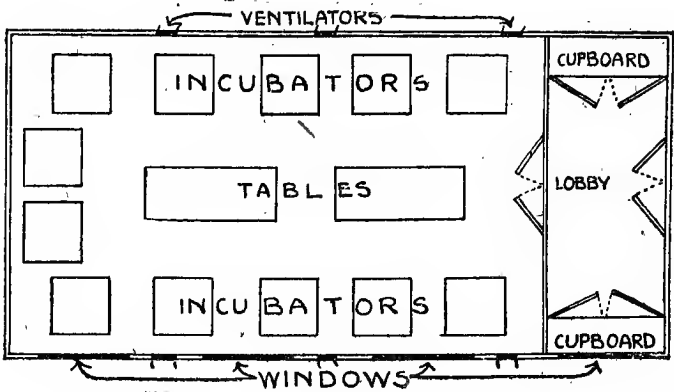
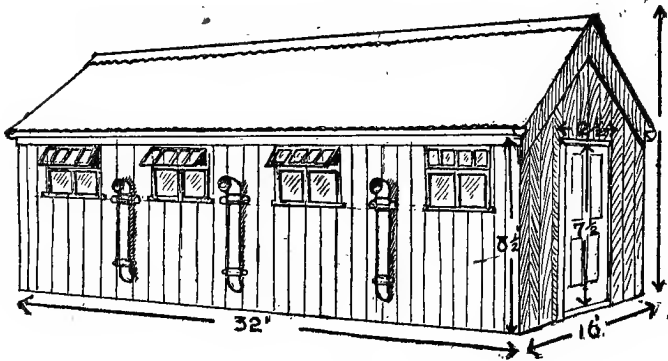

Fig. 62.

DETAILED QUANTITIES

FRAMING 2" x 3"

BOARDING 7" x 1"

Back.

7 pieces 8' 6" upr.
6 ,, 15' 9" hor.

55 pieces 8' 6"
1 piece 8' 6" 1" x 1"

H

114 HOME-MADE POULTRY APPLIANCES

Front.

6 pieces	8' 6" upr.	31 pieces	8' 6"
6 "	15' 9" hor.	1 piece	8' 6" 1" × 1"
9 "	4' 3"	20 pieces	1'
4 "	4' 6"	20 "	4' 6"

Ends (2) and Partition, each.

2 pieces	8' 6"	27 pieces	} { 8' 6" to 11' to 8' 6"
2 "	7' 9"	1 piece	
2 "	16'	12 pieces	} { for doors
(3 "	16' for 1 end)	8 "	
2 "	5' 6"		
2 "	2' 6"		
2 "	8' 5"		

Roof (2) Rafters, each.

1 piece	16'	140 pieces	16' 3"
2 pieces	8' 5"	750 sq. ft. for inside	
2 "	2' 6"	boarding	

Floor. Concrete. See Chapter II

Totals.	2" × 3"	..	800'
	7" × 1"	..	1750 sq. ft.
	7" × $\frac{5}{8}$ "	..	1850 sq. ft.
	Iron	..	36 sheets 9', 32½' ridging
	Felt	..	570 sq. ft.
	Bolts	..	24, 8" × $\frac{3}{4}$ "
	Hinges	..	4 prs. 10" T., 4 prs. 3" butt
	Windows	..	4, 4' × 3' 6"

A TANK INCUBATOR

When constructing an incubator at home it is advisable to purchase all metal parts from a recognised maker. The size of the machine must depend on the number of eggs it is to hold. A one-section machine should not have an egg capacity of more than 200 eggs.

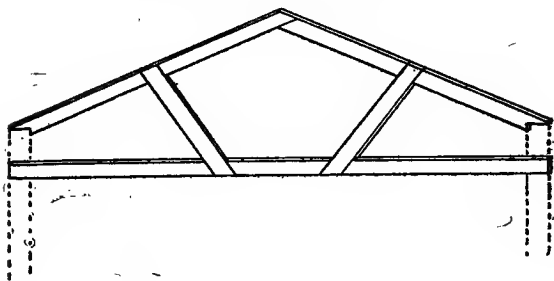
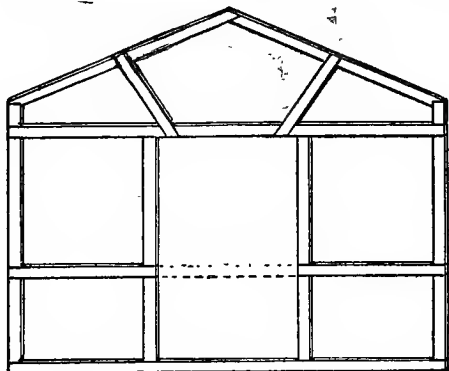
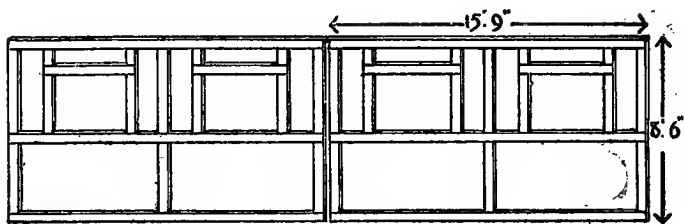

Fig. 63.

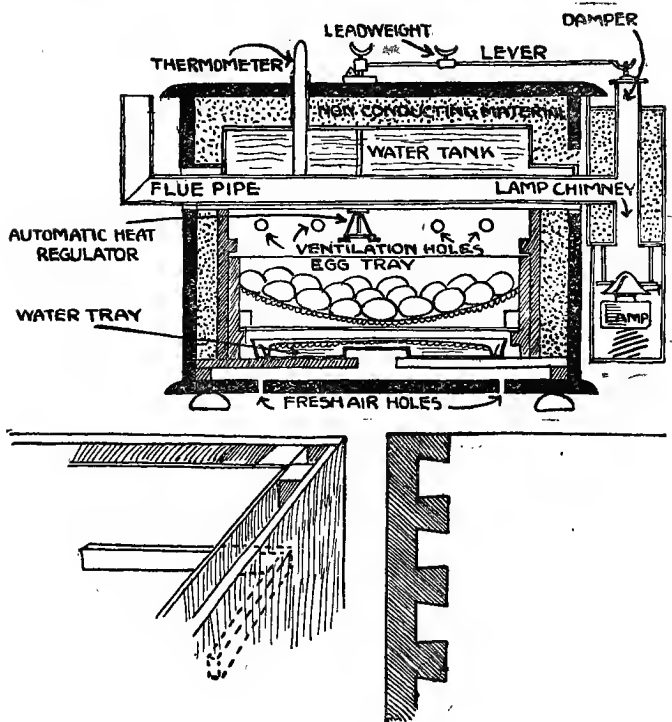

Fig. 64.

The shell of the incubator is made with double walls—the outer 1 in. thick and the inner $\frac{5}{8}$ in. thick—and the space between the two is filled with some non-conducting material. Wood-wool or fine shavings is excellent for this purpose. The corners of the outer casing should be jointed as shown. A space of 2 in. should be left at the top of the tank and filled in with the same material as the spaces

in the sides. The three diagrams given in Fig. 64 should enable anyone to build a good, workable machine.

A HOT-AIR MACHINE

The construction of a hot-air incubator, as shown in Fig. 65, is very similar as regards the shell as in the case of a tank machine. The only part not shown in the diagram is a V-shaped trough of cardboard over the hot-air flue in the upper part of the machine. A number of holes is also bored in the metal flue. The heat is consequently directed downwards.

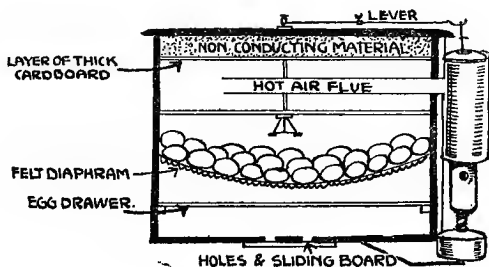

Fig. 65.

CHAPTER XII

BROODER HOUSES AND BROODERS

HOUSE FOR INDIVIDUAL BROODERS

AN excellent house for this purpose is shown in Figs. 66 and 67. It is 48 ft. long, 16 ft. wide, 11 ft. high in front and 8 ft. high at the back. There is a gangway 3 ft. wide for 36 ft. of the length. The arrangement of the house will be seen from the ground plan in Fig. 66. Four large windows are fitted in front. A wooden floor is fitted.

DETAILED QUANTITIES

FRAMING 2" × 3"	BOARDING 7" × 1"
<i>Back.</i>	
9 pieces 8' upr.	82 pieces 8'
6 " 15' 9" } hor.	1 piece 8' 4" × 1"
3 " 16' }	
<i>Front.</i>	
12 pieces 11' upr.	41 pieces 11'
4 " 11' 9" } hor.	1 piece 11' 3" × 1"
4 " 12' }	82 pieces 1' 6"
6 " 6' 2" }	2 " 1' 6" 1" × 1"
6 " 6' 0½" }	
<i>West End.</i>	
1 piece 16' } hor.	27 pieces
1 " 16' 5" }	1 piece 3" × 1" } 8' to 11'
1 " 13' }	

- | | | | |
|---|---|-------|--------|
| I | " | 8' | } upr. |
| I | " | 11' | |
| I | " | 8' 9" | |
| I | " | 9' 9" | |

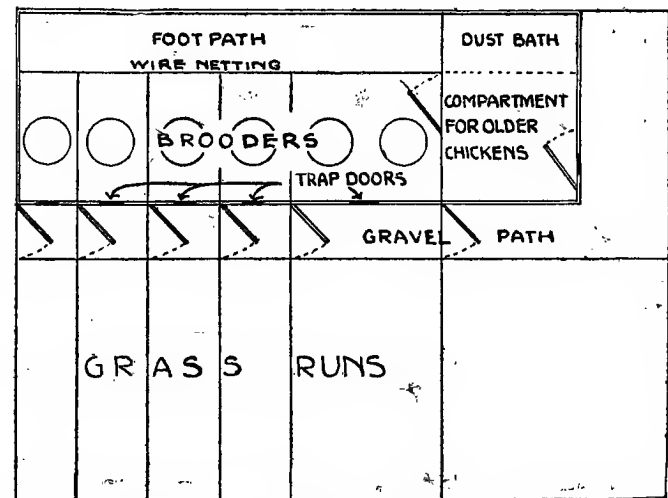
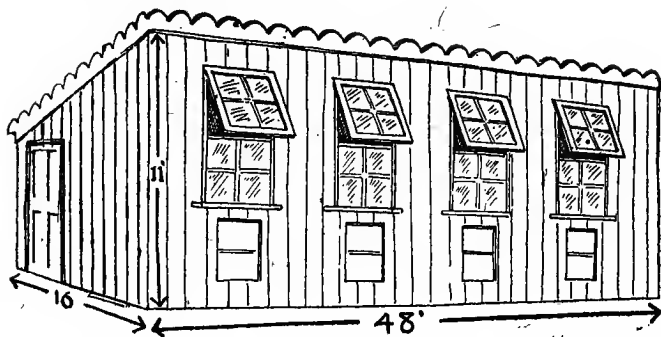

GROUND PLAN

120 HOME-MADE POULTRY APPLIANCES

East End.

1 piece 16'	} hor.
1 " 16' 5"	
1 " 13' 8"	
1 " 8'	} upr.
1 " 9' 6"	
1 " 10' 3"	
1 " 11'	

Same as West End

Roof (3 Sections), each.

3 pieces 17' 1"

29 pieces 16' 8" $7" \times \frac{5}{8}"$
 1 piece 16' 8" $2" \times \frac{5}{8}"$

Back Partition.

4 pieces 8' 8"	} $2" \times 1"$
4 " 4'	
5 " 3' 6"	
1 piece 6'	

Cross Partition.

1 piece 16'	} $2" \times 1"$
2 pieces 6' 6"	
1 piece 8' 8"	
1 " 9' 3"	
1 " 9' 10"	
1 " 10' 5"	

Small Partitions (4), each.

2 pieces 13'	} $2" \times 1"$
2 " 3' 6"	

Floor.

15 pieces 16'

82 pieces 16'
 1 piece 16' $2" \times 2"$

Totals.	$2" \times 3"$..	1200'
	$2" \times 1"$..	300'
	$7" \times 1"$..	1900 sq. ft.
	$7" \times \frac{5}{8}"$..	1000 sq. ft.
	Felt	..	840 sq. ft.
	Netting	..	74 ft. 3' 6", 16 ft. 5'
	Bolts	..	46, $8" \times \frac{3}{4}"$
	Hinges	..	2 prs. 10" T., 12 prs. 2" butt
	Windows	..	4, $5' 8" \times 6'$

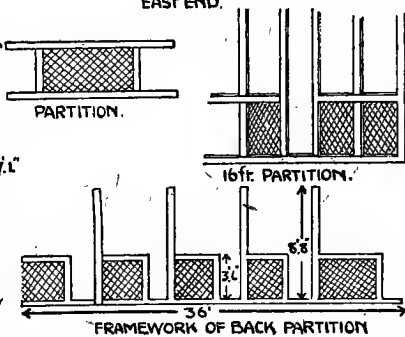
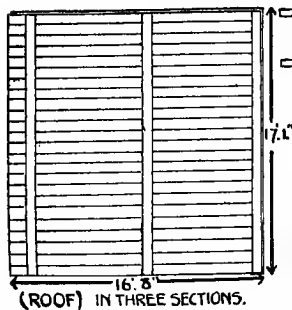
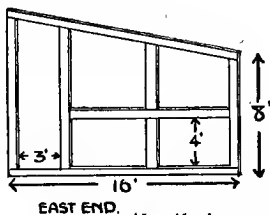
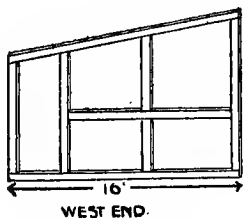
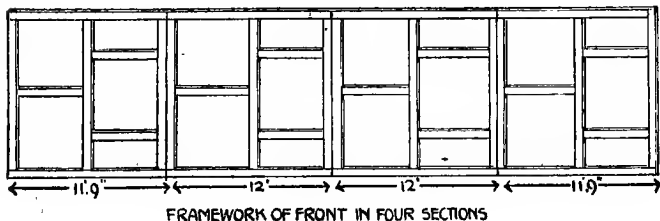
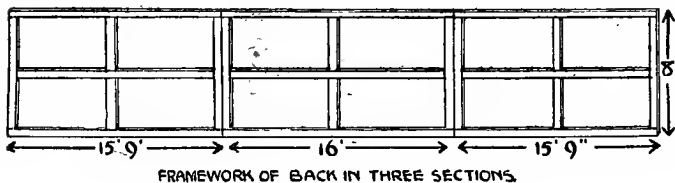

Fig. 67.

A PIPE BROODER HOUSE

In place of individual brooders it is possible to use hot-water pipes with hovers built over. This is a rather expensive system, but for a large house it is more convenient. The house illustrated in Figs. 68 and 69 is 22 ft. long, 16 ft. wide, 5 ft. high in front, 6 ft. high at the back and 9 ft. to the apex.

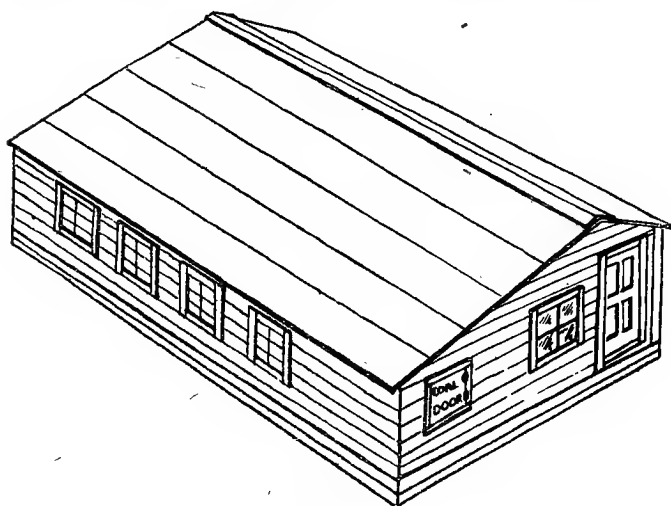

Fig. 68.

DETAILED QUANTITIES

FRAMING 2" x 3"		BOARDING 7" x 1"	
<i>Back.</i>			
7 pieces 6'	} upr.	38 pieces 6'	
3 " 11' 6"			
3 " 10'			

Front.

7 pieces	5'	upr.	} hor.	20 pieces	5'	
2 "	11'	6"		1 piece	5' 4" × 1"	
2 "	10'					
6 "	4'					
2 "	4'	4"		} 2" × 2"	16 pieces	1'
8 "	2'	10"			8 "	1' 2" × 1"
					16 "	1' 6"
					8 "	1' 6" 2" × 1"

East End.

1 piece	16'	} hor.	} 27 pieces 5' to 9' 1 piece 3" × 1" 6' less window
1 "	12'		
1 "	5'		
1 "	6'		
1 "	9'	} upr.	
1 "	7'		
2 pieces	6' 3"		
2 "	2' 6"	upr.	
3 "	4' 6"		
1 piece	4' 10"	} hor.	
1 "	14'		

West End and Partition, each.

1 piece	16'	} hor.
1 "	12'	
1 "	5'	
1 "	6'	
1 "	9'	
1 "	4'	
1 "	4' 10"	} hor.
1 "	14'	
1 "	7'	upr.

Same as East End

Side of Gangway.

3 pieces	9'	} Netting, 16 ft. 2'
32 "	2' 2" × 1" doors	

Partitions (3), each.

1 piece	7'	} 2" × 2"	} 2 pieces 12' Netting, 12 ft. 2'
2 pieces	12'		

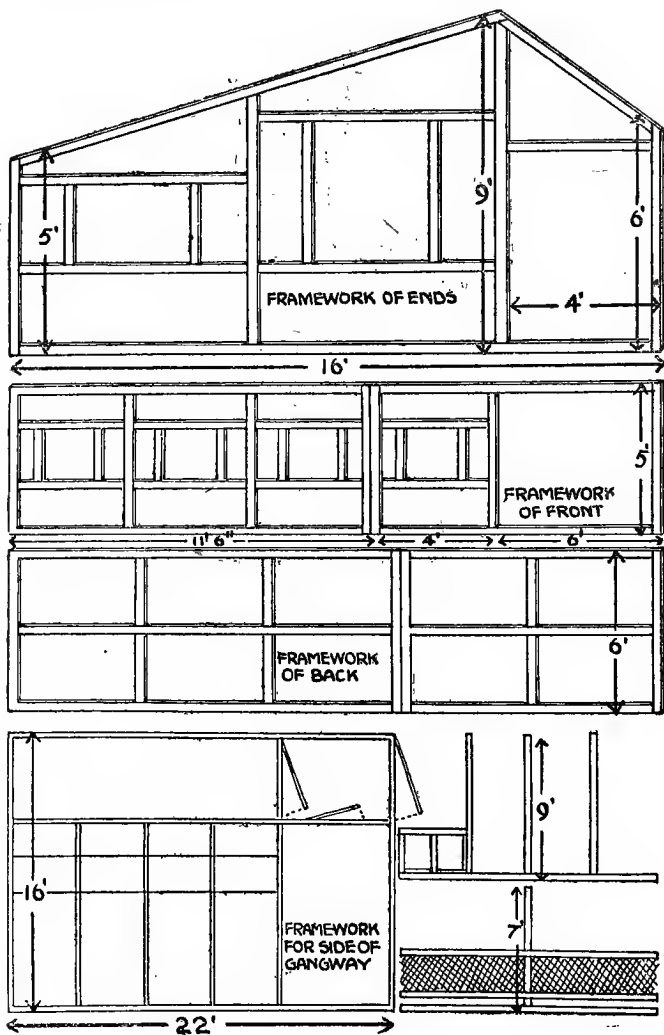

Fig. 69.

Roof (3), Rafters each.

1 piece 4' 10"
1 ,, 14'

30 pieces 11' 4"

Floor.

3 pieces 16'

54 pieces 8'
2 ,, 8' 3" x 1"

Totals. 2" x 2" .. 160'
2" x 3" .. 700'
7" x 1" .. 1250 sq. ft.
Felt .. 450 sq. ft.
Netting .. 52 ft. 2' wide
Bolts .. 27, 8" x 3/4"
Hinges .. 3 prs. 10" T., 5 prs. 3" butt,
8 prs. 2" butt
Windows .. 5 each 3' x 2 1/2'

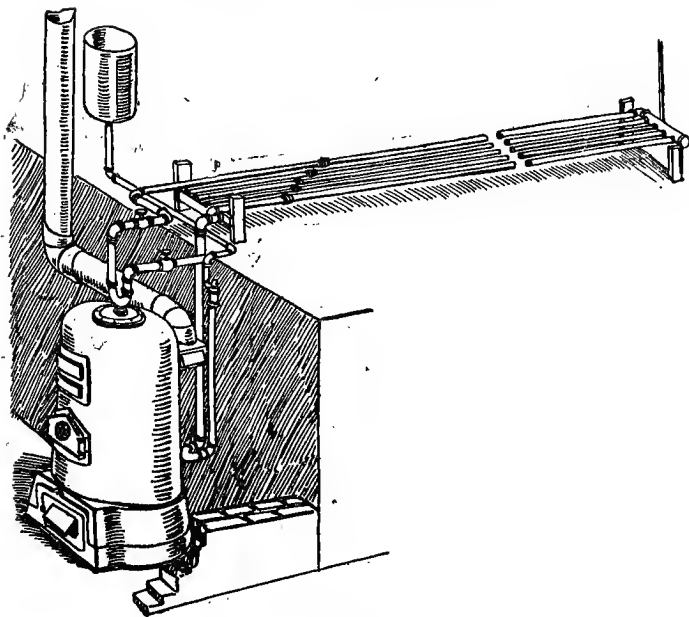

Fig. 70.

BROODER HOUSE RUNS

The wire-netting for the runs should be 3 ft. 6 in. high and 1 in. mesh. The erection of the runs is carried out in the same manner as suggested for poultry runs in Chapter IX.

PIPE AND STOVE INSTALLATIONS

Special precautions are necessary when the brooder house is to be heated by a system of hot-water pipes. A pit must be dug sufficiently deep to accommodate the stove, and this should be lined with brickwork (Chap. II). Fig. 70 shows the arrangement of the stove and pipes, and Fig. 71 illustrates the hovers which are placed over the pipes and in which the chickens sleep. The diagrams are self-explanatory.

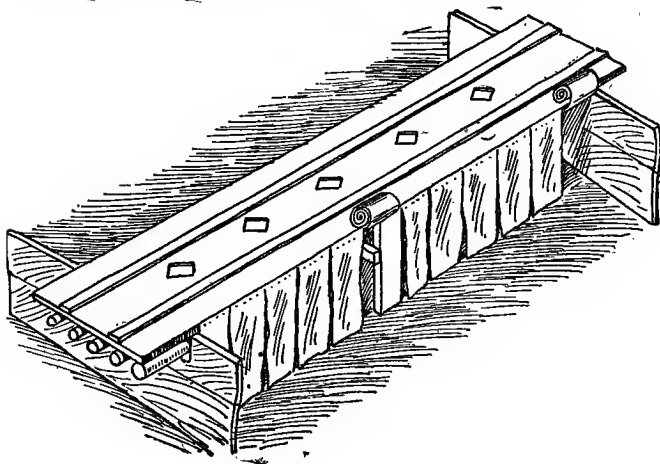

Fig. 71.

AN INDOOR BROODER

A useful form of individual indoor brooder is shown in Fig. 72. It is on the hot-air system. The brooder is $2\frac{1}{2}$ ft. by $2\frac{1}{2}$ ft., 18 in. high at the back and 21 in. high in front. The floor is raised and the lamp is placed underneath. By the arrangement of the heater the ingoing air is raised in temperature and this passes directly under the hover. The hover is circular, with a diameter of 21 in., and it rests on a support 7 in. in diameter, the side of which is made of small mesh netting.

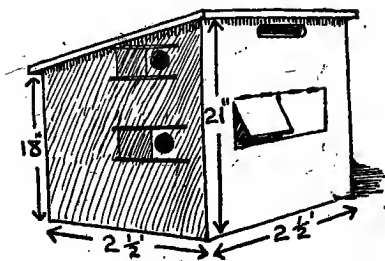

Fig. 72 (a).

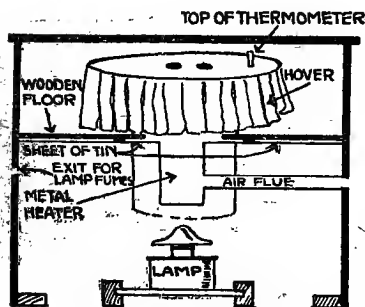

Fig. 72 (b).

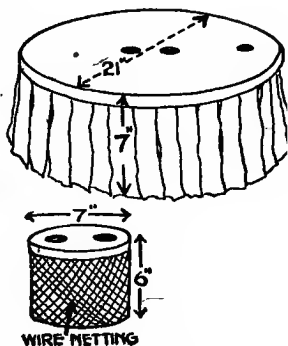

Fig. 72 (c).

The holes in the hover and top of hover support enables one to regulate the temperature. The sheet of tin below the wooden floor prevents any danger of fire, as also of floor heat. There is a small trap-door at the back for the lamp, which rests on a piece of wood running in grooves. A thermometer should be inserted in a hole in the hover. The flannel strips can be folded over the top of the hover in hot weather.

AN OUTDOOR BROODER

Fig. 73 shows the construction of a good form of outdoor brooder. It is made in three compartments,

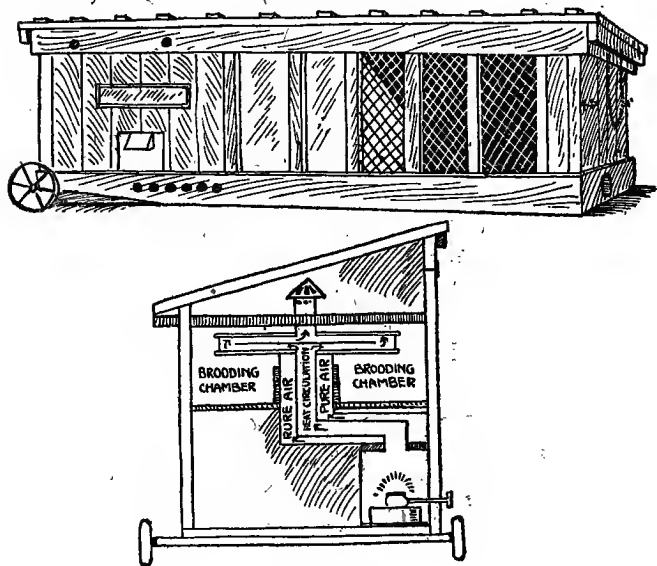

Fig. 73.

namely, a sleeping chamber, an enclosed run fitted with a glass front and a wire-netted run. The brooder is 7 ft. long and 2 ft. wide, with the sections 2 ft., 2 ft. and 3 ft. respectively. It is 2 ft. high in front and 21 in. high at the back. A false roof is fitted to the sleeping compartment, as shown. The object of this is to retain the heat. The brooder is constructed throughout of 1-in. t. & g. wood, and, if thought necessary, the sleeping chamber can be double-walled.

ANOTHER FORM OF OUTDOOR BROODER

Fig. 74 shows a similar brooder to that illustrated in Fig. 72, but in this case a covered run is added as shown. The arrangement of the sleeping compartment is identical with the indoor brooder already dealt with. The covered run is $2\frac{1}{2}$ ft. by $2\frac{1}{2}$ ft., and the floor is on a lower level with a sloping board—hinged to close at night—between the two compartments.

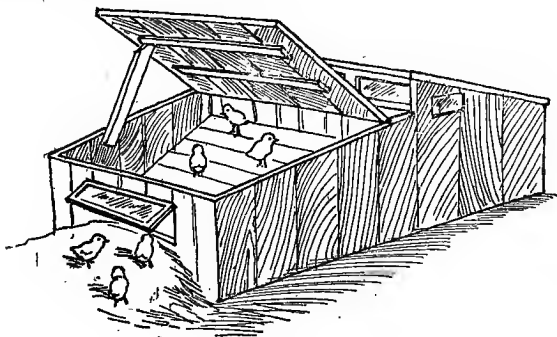

Fig. 74.

AN ADDITIONAL BROODER RUN

The run shown in Fig. 75 is 12 ft. long and $2\frac{1}{2}$ ft. wide. It is 1 ft. high at the eaves and 1 ft. 6 in. at the gable. The roof is in four parts, each one hinged to form a lid. The netting used is 1 ft. wide. A run of this description takes $125\frac{1}{2}$ ft. of 2 in. by 1 in., $38\frac{1}{4}$ sq. ft. of $\frac{5}{8}$ -in. matching and $26\frac{1}{2}$ ft. of 1-ft. netting.

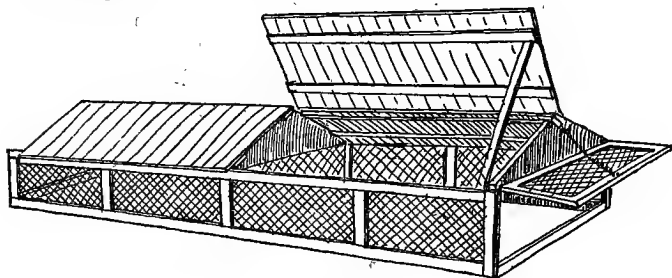

Fig. 75.

CHAPTER XIII

FATTENING SHED, CAGES, &c.

THE FATTENING SHED

A FATTENING shed must be well built of sound material, since warmth is an essential factor toward successful fattening. It must, moreover, be well ventilated. A large number of birds are kept in a confined space, and therefore an abundant supply of pure air is necessary. Semi-darkness is also needed, hence no windows are fitted. In a long shed, however, small windows may be built into the walls every 12 ft.

The most convenient width for a shed of this description is 14 ft. This allows for a row of cages down each side and a double row in the centre. The length depends on the number of birds to be fattened at the same time.

In the shed with which I am going to deal I have made it 12 ft. 4 in. in length. This means that the side frameworks are 12 ft. long, and therefore, by the addition of extra 12-ft. lengths to each side, the house can be lengthened at will. If the shed is to be lengthened 12 ft., two side sections, two roof supports and 12 ft. of roofing will be required. The rafters should be 6 ft. apart.

Figs. 76 and 77 show the framework for the different parts of the house. It will be noticed that two forms of roof framing are shown in Fig. 77. No. 1 takes rather more timber, but, since the pieces are bolted together, the labour involved is not nearly so much as is required for making No. 2. Strongly constructed rafters are necessary. The roof is made of sawn boards and corrugated iron. The ventilation is by means of louvre boards in each end. In a longer house ventilating shafts would have to be fitted in the roof as shown in Fig. 15. Double doors are fitted in each end.

DETAILED QUANTITIES

FRAMING 2"×3"	BOARDING 7"×1" T. & G.
<i>Sides (2), each.</i>	
3 pieces 8' upr.	2½ pieces 8'
3 " 12' hor.	1 piece 8' 3"×1"
<i>Ends (2), each.</i>	
2 pieces 8' upr.	20 pieces 7"×1" } 8' to 11'
2 " 9' 5" "	1 piece 4"×1" } to 8'
2 " 3' } louvre	
2 " 1' 6" } board	
2"×2" } frame	
2 " 14' hor.	
2 " 7' 7" "	
2 " 4' "	
<i>Roof. No. 1.</i>	
1 piece 14' hor.	26 pieces 13' sawn boards
2 pieces 11' struts	7"×½"
2 " 7' 7" roof	2 " 13' sawn boards
1 piece 13' 4"×1" ridge	4"×½"
3 pieces 13' 2"×1" for iron	

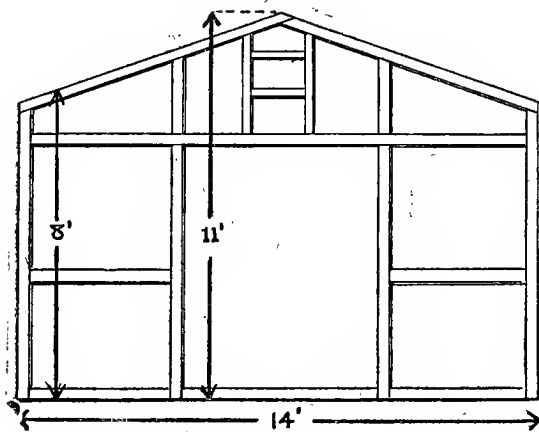
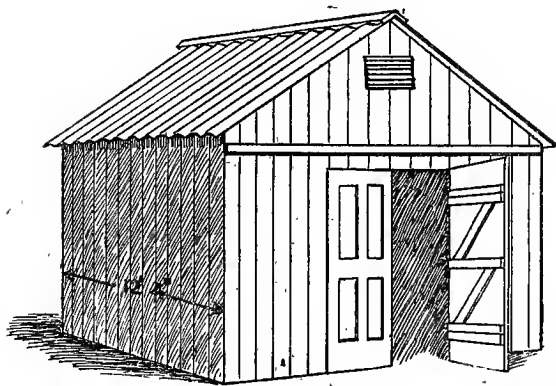

Fig. 76.

134 HOME-MADE POULTRY APPLIANCES

No. 2.

1 piece 14' As for No. 1
 2 pieces 7' 7"
 2 " 2' 4"

For each additional section of 12'

Sides (2).

6 pieces 8' 40 pieces 8'
 6 " 12' 2 " 8' 4" x 1"

Roof. No. 1.

2 pieces 14' 26 pieces 12' 4" } sawn
 4 " 11' } boards
 4 " 7' 7"
 1 piece 12' 4"
 6 pieces 12' 4" 2" x 1"

No. 2.

2 pieces 14' As for No. 1
 4 " 7' 7"
 4 " 2' 4"

Iron.

14 pieces 8' long

Totals, with No. 1 roof framing.

2" x 3"	450'	2" x 2"	20'
2" x 1"	Cut from 7" x 1" matching		
7" x 1"	t. & g., 500 sq. ft.		
7" x 5/8"	Sawn boards, 250 sq. ft.		
Iron	14 pieces 8' long		
Bolts	23, 6" x 1/2"; 2, 8" x 3/4"		
Hinges	4 pns. 9" T.		

INSIDE CAGES

One of the simplest forms of fattening cages to make is that shown in Fig. 78. It is 6 ft. long,

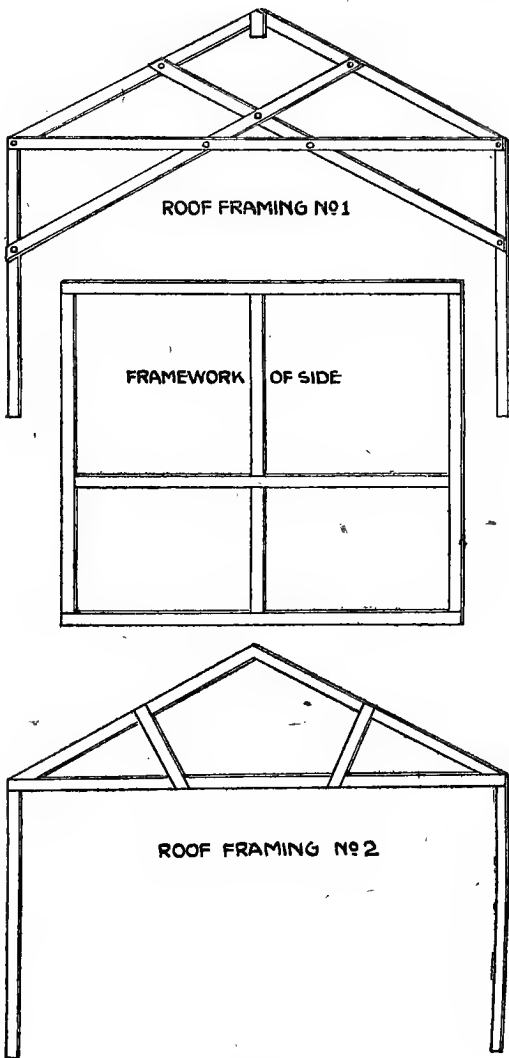

Fig. 77.

15 in. wide and 15 in. high. It is divided into three compartments. The front, back, ends and partitions are made from two pieces of 2 in. by 1 in. joined together by strips of wood 1 in. by $\frac{1}{2}$ in., placed 2 in. apart. The sections are then nailed together and similar strips of wood are used for the roof. The floor is made of spars of wood. The floor spars are nailed on to frames made by driving two 4-ft. posts 1 ft. into the ground and joining them at the top with a cross-piece 18 in. long. The object of making the floor separate is to facilitate the work of cleaning and whitewashing. The centre latch in the front of each compartment is made movable to form a door.

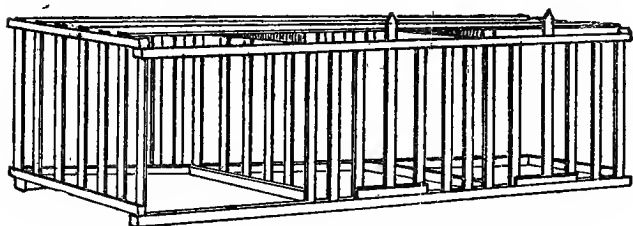

Fig. 78.

DETAILED QUANTITIES

FRAMING 2" \times 1"	SPARS 1" \times $\frac{1}{2}$ "
<i>Front.</i>	
2 pieces 6'	25 pieces 15"
	6 " 7" } for
	6 " 1 $\frac{3}{4}$ " } doors
<i>Back.</i>	
2 pieces 6'	25 pieces 15"

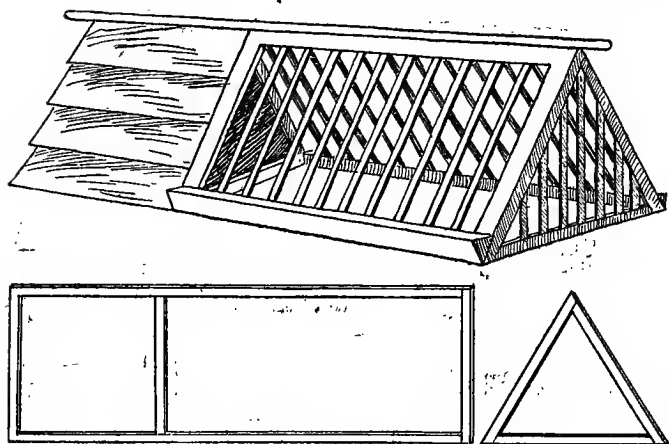

Fig. 80.

Ends (2).

6 pieces 3' 6 pieces 0 to 2' 10" to 0 6 pieces 6" to 3'

Totals, not allowing for waste.

2" × 1"	..	72'
2" × 3/4"	..	152' 6 1/2"
6" weather-boarding		82 1/2' or 41 1/4 sq. ft.

SHAPING BOARDS

Fig. 81 shows a shaping board built in three rows and capable of holding 30 to 36 birds. Each trough is made V-shaped, the front of which is rather narrower than the back. These troughs consist of only twelve pieces of wood, namely, two upright ends, 36 in. by 7 in.; three troughs; each made of two pieces at right angles, the back board 7 in. wide and the front 5 in., and 30 in. long; a

140 HOME-MADE POULTRY APPLIANCES

bottom stay ; three loose boards, $\frac{1}{2}$ in. shorter than the troughs and 4 in. wide.

<i>Totals.</i>	7" × 1"	16' 2"
	5" × 1"	7' 6"
	4" × 1"	7' 4½"

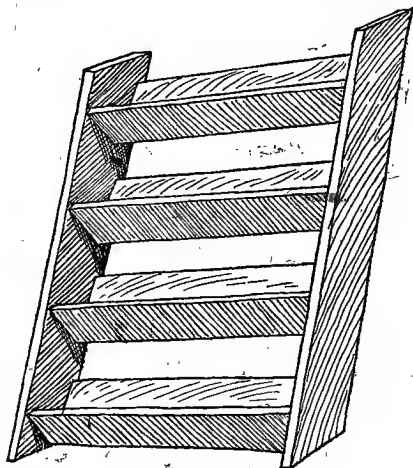

Fig. 81.

CHAPTER XIV

DUCK AND DUCKLING HOUSES

A PORTABLE DUCK HOUSE

A GOOD example of a small portable duck house is shown in Fig. 82. It is 6 ft. long, 3 ft. 6 in. wide, 4 ft. 6 in. high in front and 2 ft. 9 in. at the back. The floor is raised 9 in. off the ground. The various diagrams explain the arrangement of the house.

DETAILED QUANTITIES

FRAMING 2" × 2"	BOARDING 7" × 1"
<i>Back.</i>	
2 pieces 5' 8" hor.	2 pieces 2' 9"
2 " 2' 9" upr.	8 " 2"
2 " 4' 11" door 2" × 1"	1 piece 2' 4" × 1"
<i>Ends (2), each.</i>	
1 piece 2' } upr.	1 piece 3' 0½"
1 " 3' 9" } upr.	1 " 4' 6"
1 " 3' 8" } hor.	1 " 3' 4"
1 " 3' 6" } hor.	1 " 3' 7½"
	1 " 3' 11"
	1 " 4' 2½"
<i>Front.</i>	
2 pieces 3' 9" upr.	2 pieces 4' 6"
3 " 5' 8" hor.	2 " 3' 9"
	6 " 1' 6"
	1 piece 1' 6" 4" × 1"

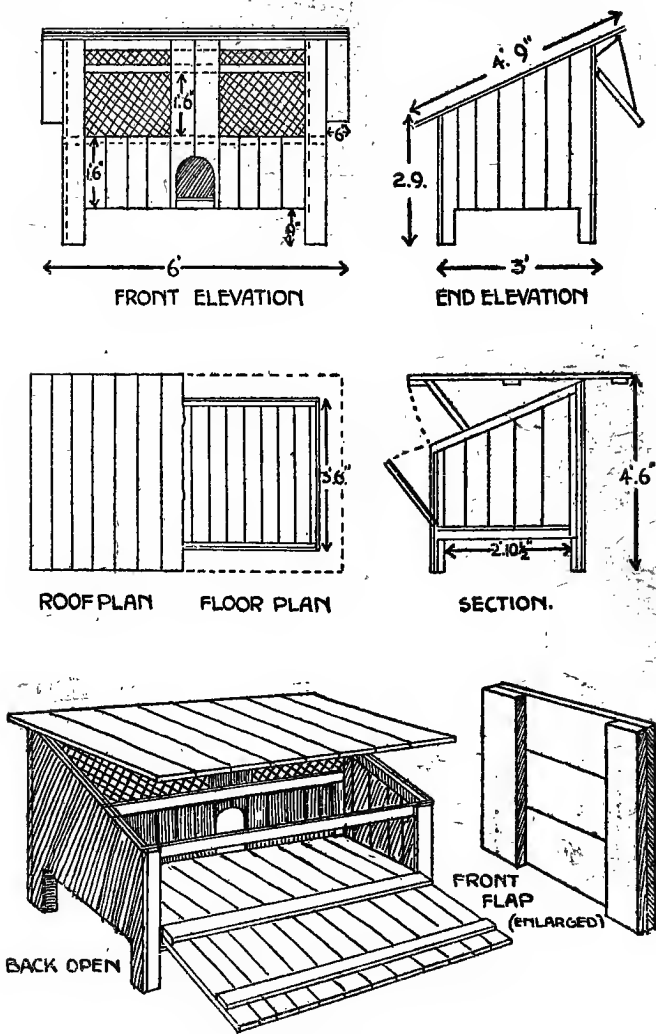

Fig. 82.

Roof.

3 pieces 6' 8"

11 pieces 4' 9"

1 piece 4' 9" 3" × 1"

Floor.

10 pieces 3' 6"

1 piece 3' 6" 2" × 1"

Runner.

2 pieces 2'

Totals. 2" × 2" 100'

7" × 1" 100 sq. ft.

Bolts 8, 6" × ½"

Hinges 2, 8" T.

Netting 10 sq. ft.

A BREEDING HOUSE FOR DUCKS

The house shown in Fig. 83 is 10 ft. long, 5 ft. wide, 5 ft. high in front and 4 ft. high at the back. The front is boarded up 4 ft. 3 in. high. The back is in the form of two doors, each 4 ft. 9 in. by 4 ft. The trap in front is 2 ft. by 18 in.

DETAILED QUANTITIES

FRAMING 2" × 2"

BOARDING 7" × 1"

Back.

3 pieces 4' upr.

3 " 9' 8" hor.

4 " 4' 8" doors

17 pieces 1'

1 piece 1' 3" × 1"

17 pieces 3'

1 piece 3' 3" × 1"

Ends (2), each.

1 piece 5' } upr.

1 " 4' 2" } upr.

2 pieces 5' } hor.

1 piece 5' 2½" } hor.

1 piece 4' 1½"

7 pieces 4' 3"

1 piece 4' 3" 4" × 1"

Front.

2 pieces 5' } upr.

1 piece 3' 6" } upr.

3 pieces 9' 8" hor.

17 pieces 4' 3"

1 piece 4' 3" 3" × 1"

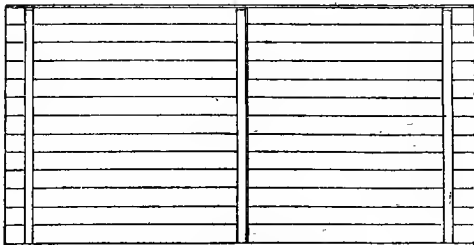
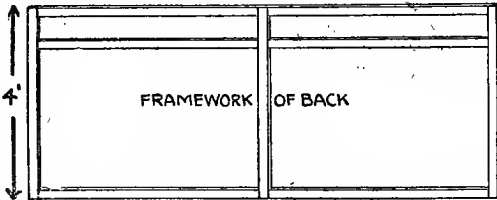
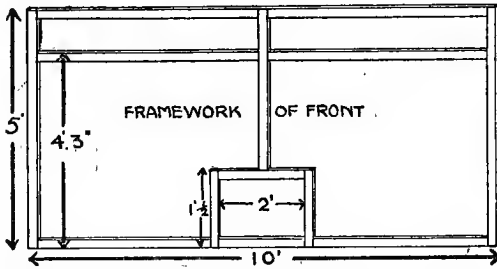
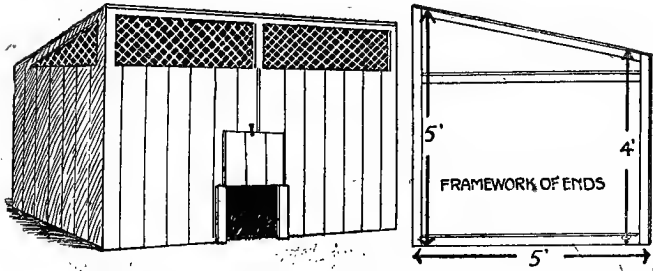

ROOF (UNDERSIDE)

Fig. 83

2 pieces 1' 6"	}	trap-door
1 piece 2'		
2" × 1"	}	frame
2 pieces 1' 10"		
2" × 1"	}	trap-door

Roof.

2 pieces 5' 11"	10 pieces 10' 8"
	1 piece 10' 8" 1" × 1"
<i>Totals.</i> 2" × 2"	220'
7" × 1"	220 sq. ft.
Wire	15 sq. ft.
Bolts	14, 6" × ½"

A DUCKLING HOUSE

The house illustrated in Figs. 84 and 85 can be used either as a brooder house—by the use of individual brooders—or for growing ducklings for market after they are two weeks to three weeks old. It is 20 ft. long, 13 ft. wide, 3½ ft. high in front and 7 ft. high at the back. There is a 3-ft. gangway inside, and the remainder of the house is divided into six compartments, each 10 ft. by 4 ft. It is ventilated by shafts, as shown in Fig. 15. The runs are 20 ft. long by 4 ft. wide, as shown in Fig. 84.

DETAILED QUANTITIES

FRAMING 2" × 2"

BOARDING 7" × 1"

Back.

5 pieces 7' upr.	41 pieces 7'
3 " 23' 8" hor.	1 piece 7' 3" × 1"

Front.

7 pieces 3' 6" upr.	41 pieces 3' 6"
3 " 23' 8" hor.	1 piece 3' 6" 3" × 1"
12 " 1' 5" trap-doors	

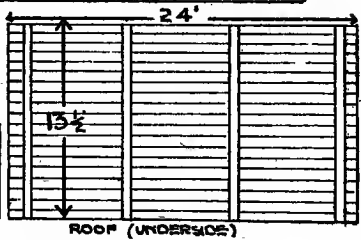
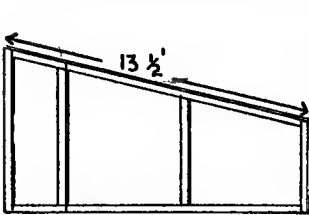
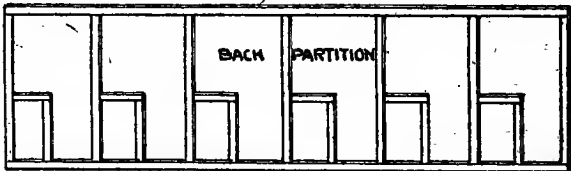
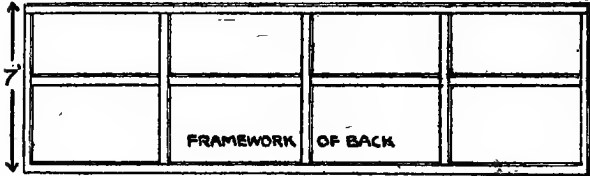
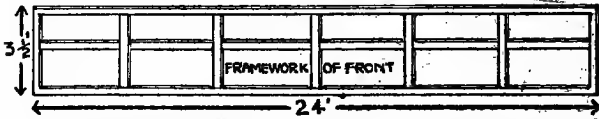
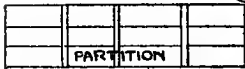
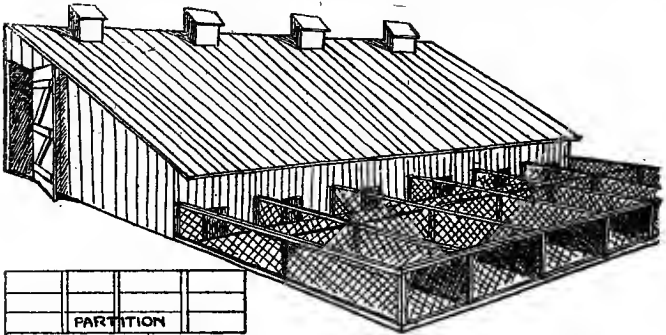

Fig. 84.

Ends (2), each.

1 piece 13'	} hor.	22 pieces 1 piece 2" x 1" }	} 3' 6" to 7'
1 " 13' 4½"			
1 " 3' 6"	} upr.		
1 " 4' 8"			
1 " 5' 11"			
1 " 7'			

Back Partition.

2 pieces 23' 8"	hor.	18 pieces 1' 9"	} for doors
7 " 7' 11"	upr.	18 " 1' 9"	
12 " 1' 9"	} for doors	6 " 1' 9" 4" x 1"	
12 " 2' 2"			

Partitions.

3 pieces 1' 9" 2" x 1" 3 pieces 10'

Roof.

4 pieces 14' 24 pieces 24' 8", or
48 " 12' 4"

Totals. 2" x 2" .. 600'
 7" x 1" .. 1000 sq. ft.
 Bolts .. 22, 6" x ¾"
 Hinges .. 12 prs. 2" butt, 2 prs. 8" T.

THE RUNS

The runs are made up of seven sides, each 20 ft. by 2 ft., and one end 24 ft. by 2 ft. In addition, a strip of 2-in. by 1-in. is placed along the top, mid-

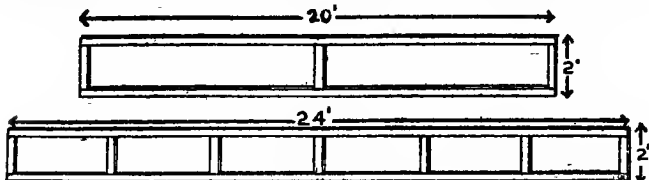

Fig. 85.

148 HOME-MADE POULTRY APPLIANCES

way down the sides of the run, to hold the sides together. The wood used is 2 in. by 1½ in.

DETAILED QUANTITIES

	FRAMING 2" × 1½"	NETTING 2' WIDE
<i>Front.</i>		
2 pieces 24'		1 piece 24'
<i>Sides (7), each.</i>		
2 pieces 20'		1 piece 20'
3 " 2'		
<i>Rafter.</i>		
1 piece 24'		
<i>Totals.</i>	2" × 1½" ..	528', without allowing for wastage
	Netting ..	164', 2' wide 1" mesh

CHAPTER XV

GOOSE AND TURKEY HOUSES

WHENEVER possible, a permanent building on the farm should be made use of for housing geese and turkeys. If a house must be erected, however, the same type of structure will answer for both kinds of birds.

An excellent form of house for this purpose is that shown in Fig. 86. This house is 40 ft. long, 15 ft. wide, 8 ft. to the eaves and 11 ft. to the gable. The front is fitted with two doors, each 5 ft. wide. The whole of the front is made with spars of wood 3 in. wide and 1 in. thick, placed 3 in. apart. Three additional framework rafters are used to support the roof.

DETAILED QUANTITIES

FRAMING 2" × 3"	BOARDING 7" × 1"
<i>Back.</i>	
5 pieces 8' upr.	68 pieces 8'
3 " 39' 8" hor., or	1 piece 8' 6" × 1"
(6 " 19' 10")	
<i>Ends (2), each.</i>	
2 pieces 8' 2" } upr.	25 pieces } 8' to 11'
1 piece 6' 6" } upr.	1 piece 5" × 1" } to 8'
2 pieces 4' 3" }	

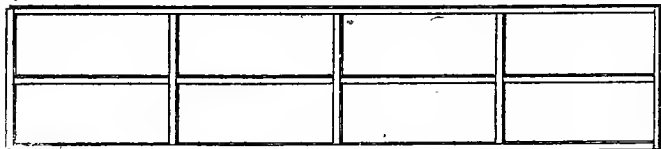
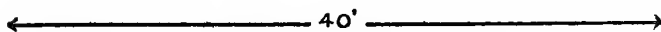
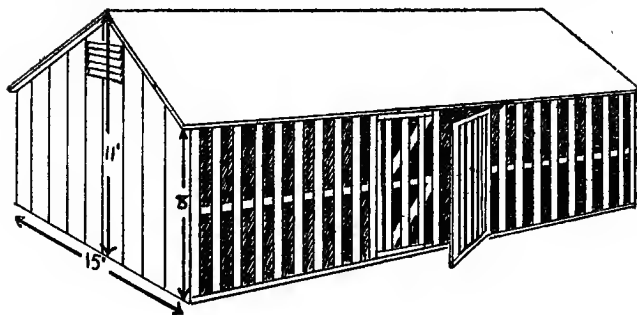

FRAMEWORK OF BACK

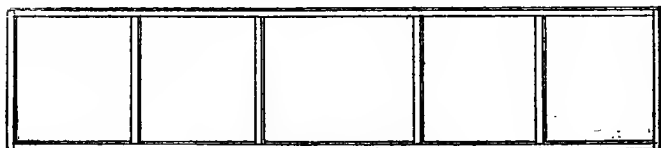

FRAMEWORK OF FRONT

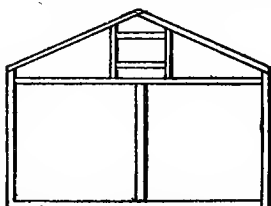

FRAMEWORK OF ENDS

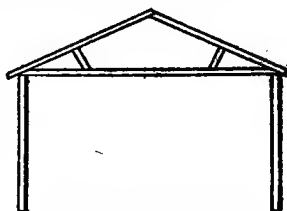

ROOF SUPPORTS

Fig. 86.

2 pieces 15'	} hor.
2 " 3'	
2 " 7' 4"	

Front.

3 pieces 39' 8", or	80 pieces 8' 3" x 1"
(6 " 19' 10")	
6 " 8' upr.	
6 " 5' } for doors	
4 " 8' }	
4 " 6' }	

Roof (3 Frames).

1 piece 15'	56 pieces 10' 4" } sawn boards
2 pieces 8' 1"	56 " 10' } 7" x 5/8"
2 " 2'	

<i>Totals.</i>	3" x 1"	..	700'
	2" x 2"	..	550'
	2" x 3"	..	120'
	7" x 1"	..	t. & g. 675 sq. ft.
	7" x 5/8"	..	Sawn boards, 725 sq. ft.
	Felt	..	675 sq. ft.
	Bolts	..	12, 6" x 1/2"; 6, 7" x 3/4"
	Hinges	..	2 prs. of 10" T.

PERCHES FOR TURKEYS

Reference was made to perches for turkeys in Chapter VIII. It was stated that 2-in. diameter

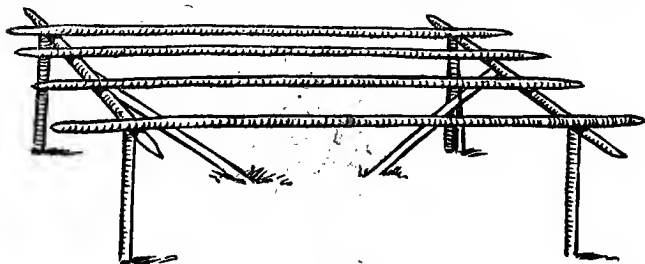

Fig 87.

fir poles is the best form. A suitable arrangement of perches is shown in Fig. 87. These can be used inside a turkey house or outside in the open during warm weather. The best height to have them is 1 ft. from the ground, and the spars should be 2 ft. 6 in. apart.

INDEX

- Backyard house and run, plans for, 79-82
- Backyard poultry plant plan, A, 45
- Bricks, facts about size and laying of, 21
- Brooder houses—
- Large, plans for, 118-121
 - Pipe and stove installations, 126
 - Pipe brooder house plan, 122-125
 - Runs for, 126
- Brooders—
- Additional run for, 130
 - Indoor, 127
 - Outdoor, plans for, 128-129
- Carpentry, knowledge of a great asset to poultry-keepers, 13
- Cement, components parts of, and how to mix, 21
- Cockerel house range, A, plans for, 73-76
- Coops, double, 106-109
- Duck house—
- Breeding house, A, 143-145
 - For growing ducklings, 145-147
 - Portable, 141-143
 - Runs to, 147
- Fattening cages in the open, plans for, 137
- Fattening coop, A, 138
- Fattening sheds—
- Inside cages for, 134
 - Plans for, 131-134
- Floors—
- Ashes and tar, 23
 - Concrete, 25
 - Earth, 23
 - Essential in making, 22
 - Gravel, 23
 - Wooden, 24
- Foundations for small poultry houses, 20
- Geese, house suitable for, 150
- Green-food rack, A, 92
- Guides for trap-doors and shutters, to make, 93
- Half-way house for chickens, plan for, 76-79
- Incubator house—
- Large, plan for, 112-114
 - Portable, plan for, 110-112
- Incubators—
- Hot-air machine, A, 117
 - Tank, 114-116
- Jerry-built appliances, the true meaning of, 15
- Joints, example of making, 35-37
- Large intensive house, plans for, 69-72
- Medium-sized intensive house, plans for, 66-69

154 HOME-MADE POULTRY APPLIANCES

- Nails and screws, what to buy, 38
- Nest boxes, various, 84, 85
- Open-fronted scratching shed house, plans for, 54-56
- Outside sitting-boxes, 106
- Perches—
 - Best type of, 83
 - Dropping-board and nests combined, 86
 - For turkeys, 151
- Plans—
 - Calculating the quantity of boarding, 31
 - Of the framing necessary for estimating materials, 30
 - Roof pitch and what to consider, 32
 - Work out before beginning to build, 29
 - Working out quantities required, 33
- Portable house, plans for, 60-65
- Poultry houses—
 - Cubic air space, 49
 - Floor space per adult bird, 47
 - General principles in building, 47
 - Head room essential, 48
 - Jerry-built v. expensive, 14
 - Lighting of, 50
 - Three main points for building your own, 16
 - Ventilation, 51
 - Why not build your own? 14
- Poultry plant on one acre, plan for, 43
- Poultry runs—
 - Dual runs, 96
 - Fences for, 98
 - Gates and catches in, 100, 101
 - Gravel areas, 97
 - Posts and netting for, 98, 99
 - Size for, 96

- Poultry yard, the—
 - Allow room for extension, 41
 - Footpaths advisable in, 43
 - Planning permanent buildings in, 41
 - Soils and sub-soils best for, 39
 - Special features in, 42
 - Things to consider in laying out a, 39
- Rain gutter for houses, 95
- Roofs—
 - Boards with corrugated iron, 26
 - Boards with roofing felt, 26
 - Boards with tarred brown paper, 27
- Roosting and scratching shed compartment house, plan for, 57-59
- Self-feeding hoppers, 92
- Shaping boards, to make, 139
- Sitting hen house—
 - Feeding cages, 105
 - Inside sitting-boxes, 104
 - Plan for, 102-104
- Trap-nests, various, 86-90
- Troughs, 90, 91
- Turkey house, plan for, 149-150
- Wheels for portable poultry houses, 27
- Wood, varieties required—
 - Framing wood, 20
 - Sawn boards, 18
- Suitable for building poultry houses, 17
- Three-ply, 19
- Varieties of boarding to employ for main building, 17
- Weather-boarding, 18
- What to buy in matching, 19

The "Smallholder" Library

In Stiff Paper Boards. Price 1/6 net. Post free 1/9 each.

A Series of Handbooks specially prepared for the use of Smallholders.

- No. 1. **PROFITABLE BEE-KEEPING.** By H. E. GEARY, F.E.S.,
Expert to the Leicestershire Bee-keepers' Association, etc. With
13 Illustrations from Photographs.
- No. 2. **PRACTICAL HINTS FOR THE HOLDING.** With 240
Illustrations. A Series of Prize Paragraphs from "The Smallholder,"
giving practical advice on the working of a Small Holding.
- No. 3. **PROFITABLE POULTRY KEEPING.** For Smallholders
and others. By E. T. BROWN, formerly Lecturer on Poultry Keeping
to the Royal Agricultural College, Cirencester, etc. etc. With
Photographs and many Diagrams.
- No. 4. **THE MARKET GARDEN: How to Start and Run it
Profitably.** With numerous Illustrations. By the Gardening Experts
of "The Smallholder."
- No. 6. **PIGS: How to Make them Pay.** Breeding, Feeding, and Hous-
ing. With numerous Illustrations and Photographs.
- No. 8. **MANURES AND MANURING.** By "FARMER GILES." This
volume explains in plain language the right methods of treating all kinds
of Crops.
- No. 9. **UTILITY RABBIT KEEPING.** With chapters on Fancy
Rabbits, Rabbits for Exhibition, etc.
- No. 10. **THE ALLOTMENT BOOK.** How to make the most of your
Land. By WALTER BRETT. Author of "War Time Gardening."
- No. 11. **THE POTATO BOOK.** All about the Potato. By J. C.
NEWSHAM, F.L.S. With 8 pages of Photographs and other Diagrams.
- No. 12. **PROFITABLE GOAT KEEPING.** By the Experts of "The
Smallholder." With numerous Illustrations.
- No. 13. **DUCKS, GEESE, AND TURKEYS.** By E. T. BROWN,
Instructor at the College Poultry Farm, Theale, Berks, etc.
- No. 14. **THE GARDEN FRAME FOR FOOD AND
FLOWERS.** By W. F. ROWLES. Author of "Greenhouses," etc.
- No. 15. **ONE THOUSAND ANSWERS TO ONE THOUSAND
QUESTIONS ON SMALLHOLDING SUBJECTS.**
Edited by E. T. BROWN.
A valuable compendium of information on all matters of interest to
workers on the Land.
- No. 16. **HOW TO MARKET YOUR PRODUCE; or, The
Selling Side of Smallholding.** By F. W. DYER.
A Handbook for all who would sell all they produce at a profit.
- No. 17. **STOCK FEEDING MADE EASY.** By E. T. BROWN.
A Useful Book for the Small Farmer or Smallholder.

*Any book in this list may be ordered through your Bookseller, or will be sent post paid on receipt
of the Price mentioned by*

**A. F. SOWTER, Publisher, "Smallholder and Small Owner" Offices,
16-18 HENRIETTA STREET, LONDON, W.C. 2.**

Books on Farming, etc.

Farming on Factory Lines, or Continuous Cropping for Large Farmers.

By PROFESSOR T. WIBBERLEY, N.D.A., N.D.D.

Third Edition. PRICE 6/- NET (Postage 4d. extra).

It forms the great authoritative textbook on the Wibberley Continuous Cropping System, and is a new and frankly revolutionary guide to ALL WEATHER Farming and to cheaper Milk, Corn and Beef Production.

Hardy Fruit Culture.

By J. C. NEWSHAM.

Crown 8vo. Cloth. PRICE 5/- NET (Postage 5d.).

Continuous Cropping and Tillage. Dairy Farming For Small Farmers, etc.

By PROFESSOR T. WIBBERLEY, N.D.A., N.D.D.

Third Edition. Crown 8vo. Cloth. PRICE 3/6 NET ; post free, 3/10.

Farm Tractors.

By E. T. BROWN.

Author of "Poultry for Profit," etc.

Fully Illustrated. Crown 8vo. Cloth. PRICE 3/6 NET (Postage 4d.).

A practical Handbook on the selection and management of a Tractor.

Dairy Farming.

By J. C. NEWSHAM, F.L.S.

Author of "Farming Made Easy," etc.

Crown 8vo. Cloth. PRICE 3/6 NET (Postage 5d.).

All about Cow-keeping, Milk, Butter, Cheese, etc.

Farming Made Easy.

An invaluable guide for all those commencing farming.

By J. C. NEWSHAM, F.L.S.

Author of "The Potato Book," etc.

Crown 8vo. Cloth. PRICE 3/6 NET (Postage 4d. extra).

*These Books can be obtained through any Bookseller, or post free on receipt of the
Prices named from*

C. ARTHUR PEARSON, Ltd., Henrietta Street, London, W.C. 2.

Books on Live Stock, etc.

The Horse. In Health, Accident and Disease.

By "DARLEY MATHESON," M.R.C.V.S.

Crown 8vo. Cloth. With Eight Photographs and other Illustrations.

PRICE 5/- NET (Postage 6d.).

Cattle and Sheep. By "DARLEY MATHESON."

Crown 8vo. Cloth. With Photographs and other Illustrations.

PRICE 5/- NET (Postage 6d.).

Home-made Poultry Appliances.

By E. T. BROWN.

Author of "Poultry for Profit," etc.

Crown 8vo. Cloth. Illustrated with 87 diagrams.

PRICE 3/6 NET (Postage 4d. extra).

A complete course of instruction for the poultry farmer, who wishes to become his own carpenter, on what to make and how to make it.

Poultry for Profit. By E. T. BROWN.

Crown 8vo. Cloth. With 15 full-page Illustrations.

PRICE 3/6 NET (Postage 4d.).

The Pig: Breeding, Rearing and Housing.

By SANDERS SPENCER.

Crown 8vo. Cloth. With 15 full-page Illustrations.

PRICE 3/6 NET (Postage 4d.).

Insect Pests and How to Beat Them.

By JAMES SARSFIELD.

Including Notes on Plant Diseases, Soils and Manures. Crown 8vo. Cloth. With Illustrations by the Author of every insect described in the Text.

PRICE 3/6 NET (Postage 4d.).

Roses and How to Grow Them.

By EDWIN BECKETT, V.M.H., F.R.H.S.

Crown 8vo. Cloth. With portrait frontispiece.

PRICE 2/6 NET (Postage 3d. extra).

*These books can be obtained through any Bookseller, or post free on receipt of the
Prices named from*

C. ARTHUR PEARSON, Ltd., Henrietta Street, London, W.C. 2.

