

The Edinburgh Medical Series

General Editor.—JOHN D. COMRIE

M.A., B.Sc., M.D., F.R.C.P.E.

**RADIOGRAPHY
AND RADIO-THERAPEUTICS
PART II.—RADIO-THERAPEUTICS**

IN PREPARATION.

By **ROBERT KNOX, M.D., M.R.C.S., L.R.C.P.**
RADIOGRAPHY OF THE THORAX

ROYAL 8VO. CLOTH. FULLY ILLUSTRATED.

**A STEREOSCOPIC ATLAS OF
RADIOGRAPHY**

SET I. GENERAL.

By **ALICE VANCE KNOX, M.B., B.Ch.**
X-RAYS IN GENERAL PRACTICE

A HANDBOOK FOR THE GENERAL PRACTITIONER
AND STUDENT

CROWN 8VO. CLOTH. FULLY ILLUSTRATED.

A. & C. BLACK, LTD., 4, 5 & 6 SOHO SQUARE, LONDON, W.1.

^e
RADIOGRAPHY
AND
RADIO-THERAPEUTICS

BY

ROBERT KNOX

M.D., C.M. (EDIN.), M.R.C.S. (ENG.), L.R.C.P. (LOND.)

CONSULTING RADIOLOGIST, GREAT NORTHERN CENTRAL HOSPITAL, LONDON

HON. RADIOGRAPHER, KING'S COLLEGE HOSPITAL, LONDON

DIRECTOR, ELECTRICAL AND RADIO-THERAPEUTIC DEPARTMENT, CANCER HOSPITAL, LONDON

CAPTAIN R.A.M.C. (T.) 4TH LONDON GENERAL HOSPITAL (IN CHARGE OF X-RAY DEPARTMENT)

PART II

RADIO-THERAPEUTICS

WITH FIFTEEN FULL-PAGE PLATES AND
ONE HUNDRED ILLUSTRATIONS IN THE TEXT



NEW YORK: THE MACMILLAN COMPANY

LONDON: A. & C. BLACK, LTD.

1919

HARVARD UNIVERSITY
SCHOOL OF MEDICINE AND PUBLIC HEALTH
LIBRARY

13 JUN 1936

By Exchange: Army Medical Library

A 22.W.1919.4

BOSTON MEDICAL LIBRARY
IN THE
FRANCIS A. COUNTWAY
LIBRARY OF MEDICINE

First Edition published in 1915 in one volume
Second Edition, revised and enlarged, published in 1917-1918 in two volumes—
Part I. Radiography. Part II. Radio-Therapeutics
Third Edition, January 1919

CONTENTS

PART II.—RADIO-THERAPEUTICS

	PAGE
INTRODUCTORY	387-405
Action of radiations upon tissues—Action of radiations on normal tissues and morbid growths—Dangers attendant on the use of X-rays and radium.	

A. X-RAY THERAPEUTICS

SPECIAL POINTS IN INSTRUMENTATION	406-443
Methods of protection—Arrangement of apparatus—Methods used in estimation of dosage—The use of filters—The choice of the X-ray therapeutic tube.	
THE TREATMENT OF DISEASES OF THE SKIN	444
THE TREATMENT OF ENLARGED LYMPHATIC GLANDS	454
THE TREATMENT OF RODENT ULCER	457-459
THE TREATMENT OF EPITHELIOMATA	459
THE TREATMENT OF SARCOMATA AND CARCINOMATA	460-465
THE TREATMENT OF ENLARGEMENT OF THE PROSTATE GLAND	465
THE TREATMENT OF EXOPHTHALMIC GOITRE	467
THE TREATMENT OF UTERINE FIBROMATA	469-474
THE TREATMENT OF DISEASES OF THE BLOOD	474-478
THE TREATMENT OF DISEASES OF THE LUNGS AND MEDIASTINUM	478

B. RADIUM THERAPY

PHYSICS OF RADIUM. By C. E. S. PHILLIPS, F.R.S.E.	481-496
Ionisation and recombination—Radium emanation—Measurement—Physiological action.	
THE PRACTICAL APPLICATION OF RADIUM TO DISEASE	497-511
Methods of using radium—A good method of utilising a limited quantity of radium—Filtration of radium rays—Radium tubes in the substance of a tumour—Treatment of deep-seated tumours by external applications.	

	PAGE
DOSAGE IN RADIUM THERAPY	511
Relation between the value of radium and its activity.	
RADIUM IN GENERAL DISEASES	514
RADIUM IN DISEASES OF THE EYE	516
RADIUM IN DISEASES OF THE EAR, NOSE, AND THROAT	517
RADIUM IN THE TREATMENT OF EXOPHTHALMIC GOITRE	517
MALIGNANT DISEASE OF THE THYROID GLAND	518
RADIUM IN THE TREATMENT OF DISEASES OF THE SKIN	519
RADIUM IN GYNÆCOLOGICAL PRACTICE	523
RADIUM IN SUPERFICIAL EPITHELIOMA AND RODENT ULCER	526
RADIUM IN INFILTRATING EPITHELIOMA	530
RADIUM IN SARCOMATA AND CARCINOMATA	531
RADIUM IN CANCER OF THE TONGUE AND MOUTH	534
RADIUM IN CANCER OF THE ŒSOPHAGUS	534
RADIUM IN CANCER OF THE RECTUM, THE PROSTATE GLAND, AND THE BLADDER	536

C. THE COMBINED USE OF RADIUM AND X-RAYS

IN THE TREATMENT OF MALIGNANT DISEASE	538-545
IN THE TREATMENT OF INJURIES AND DISEASES MET WITH IN MILITARY PRACTICE	546-561
Equipment of a radio-therapeutic department—Description of types of cases met with in military practice, with special points in technique—Treatment of chronic sinuses and septic wounds by combined X-ray and ultra-violet radiations.	
THE VALUE OF RADIATIONS IN PLASTIC SURGERY OF THE FACE AND JAWS. By PERCIVAL P. COLE, M.B., F.R.C.S.	562-574
Special points in the technique employed in the treatment of cases dealt with by Mr. Cole.	
GENERAL DISEASES MET WITH IN MILITARY PRACTICE	575-591
Exophthalmic goitre—Graves', Basedow's, or Parry's disease—Enlargement of the thymus gland alone or associated with hyperthyroidism—Radium in the treatment of hyperthyroidism.	
GLOSSARY	593
INDEX	597

LIST OF ILLUSTRATIONS

FULL-PAGE PLATES

	FACING PAGE
LXXXIX. Changes produced in Normal Tissues by Radiations	396
LXXX. Changes observed in Tumours which have been treated by Radiations	397
LXXXI. Changes observed in Tumours which have been treated by Radiations	400
LXXXII. Changes observed in Tumours which have been treated by Radiations	401
LXXXIII. Rodent Ulcers treated with Radium, X-Rays, and CO ₂	456
LXXXIV. Cases of Rodent Ulcers treated with Radium	457
LXXXV. Carcinomata treated by X-Rays	464
LXXXVI. Stages in the Treatment of an Atrophic Scirrhus Cancer of the Breast	465
LXXXVII. Rodent Ulcers treated with Radium and X-Rays	528
LXXXVIII. Rodent Ulcer of Upper Lip, treated with Radium	529
LXXXIX. Recurrent Carcinoma after removal of Breast	532
xc. Cheloid Scars of Upper Lip and Left Side of Face	566
xci. Appearance of scars improved and suppleness restored to a large Pectoro-cervical flap by consistent treatment with Radium and X-Rays	567
xcii. Depilation of Hair-bearing flap to make good a defect in Hairless area of Face	570
xciii. Depilation of Hair-bearing flap similar to above	571

ILLUSTRATIONS IN THE TEXT

FIG.		PAGE
323.	X-ray treatment cubicle	407
324.	Milliamperemeter	409
325.	Bauer qualimeter	409
326.	Therapeutic outfit suitable for deep therapy	410
327.	Mercury interrupter with gas di-electric	411
328.	Mercury interrupter, showing details	412
329.	Dipping interrupter, with revolution counter, or tachymeter	413
330.	Morton rectifier fitted to a coil outfit, with control table	414
331.	Diagram of connections for Morton rectifier	415
332.	Triple valve tube	415

FIG.		PAGE
333.	Method of connecting coil to valve tube and X-ray tube. Valve tube on positive pole	417
334.	Method of connecting coil to tube. Valve tube on negative pole	417
335.	Tube stand for deep therapeutic work	417
336.	Pillar tube stand suitable for therapeutic work	418
337.	Rotating tube stand	419
338.	A convenient arrangement of apparatus for therapeutic work	421
339.	Apparatus arranged on an upright cabinet	422
341.	Complete Kienböck quantimeter	428
342.	Arrangement of apparatus and paper when using Kienböck's method of estimating dosage	428
343.	Developing the strips	430
344.	Comparing the wet strip with the standard scale, using the slide	430
345.	Comparison of the dry strip without the slide	430
346.	Plain strips, exposed and developed	431
347.	Strips exposed with 1 mm. aluminium and developed	431
348.	Strips exposed with aluminium ladder and developed	431
349.	Chart of X-ray exposures, to show method used in recording dosage by Kienböck's method	432
350.	Lovibond's tintometer, adapted and standardised	434
351.	Curves showing colour developed by Sabouraud's pastille when exposed to unfiltered X-rays in measured doses	435
352.	Chromo radiometer	436
353.	Hampson's radiometer	437
354.	Diagram to illustrate a method of circulating water to the anti-cathode of a tube	440
355.	Macalaster Wiggin X-ray tube	441
356.	Penetrans tube	442
357.	Ringworm treatment. Diagram illustrating Dr. Adamson's method	449
358.	Diagram showing centres of areas to be rayed	449
359.	Chronic ulcer of hand of several years' duration, showing improvement under X-ray treatment	453
360.	Showing the projection of rays into a deep part by means of the rotating tube	466
	Diagram to illustrate the Freiburg treatment for uterine fibroids	473
361.	Arrangement of the tube and filters (Kienböck method)	474
362.	Special form of gold leaf electroscope	484
363.	Apparatus for pumping off and collecting radium emanation	485
364.	Combined pump and apparatus for concentration of radium emanation by liquid air	485
365.	Apparatus for charging glass or other applicators with radium emanation after sparking	486
366.	Curve showing decay of radium emanation with time	487

LIST OF ILLUSTRATIONS

FIG.	PAGE
367. Arrangement for the preparation of water impregnated with radium emanation	490
368. Various forms of radium applicators	492
369. Friction device for charging electroscope	494
370. Apparatus for inhalation of radium emanation and oxygen	499
371. Glass applicators for radium emanation	500
372. Outer and inner tubes for salts of radium	501
373. A fine radium tube	503
374. A flat applicator for radium	503
375. A circular radium applicator	504
376. A concave circular applicator	504
377. Arrangement of several separate radium tubes over an extensive area	505
378. Oesophageal tubes containing tubes of radium in tiers	505
379. Palatal surface of special applicator made for the mouth	506
380. Two or more tubes in an applicator for treatment of the cervix uteri	507
381. A number of single tubes of radium inserted in and around the cervix uteri	507
382. Trocar and cannula for insertion of radium emanation tubes	507
383. Flat metal applicator	508
384. Showing method of arranging tubes with filters	508
385. Silver screen adapted to contain two tubes	508
386. Radium in a flat metal tube showing, by dotted lines, area of active surface	509
387. Radium tube contained in rubber tubing	509
388. A radiogene	515
389. Application of radium to the eyelid	516
390. Circular applicator suitable for the treatment of superficial skin lesions	519
391. Applicator in box	519
392. Uterine sound with radium tube at extremity	524
393. Radium tube arranged for the treatment of the floor of the mouth	533
394. Radium tube in an oesophageal tube, arranged for the treatment of an oesophageal growth	534
395. Tube arranged on a length of pliable silver wire	534
396. Shows radium tube <i>in situ</i> , for the treatment of tumour of the oesophagus, situated close to the cricoid cartilage	535
397. Diagram to illustrate method of introducing radium tubes into lower bowel	536
398. Portable outfit for use in wards. Back view, showing controls	548
399. Portable outfit for use in wards. Front view, showing induction coil, valve tubes, and protected tube-holder	549
400. X-ray treatment at the bedside by means of a portable outfit	551
401. Combined X-ray and ultra-violet radiation treatment	551
402. Protective screen and arrangement of control apparatus	552
403. Apparatus arranged for therapeutic work, showing protective screen in position	553
404. High frequency treatment	554

FIG.	PAGE
405. Ground plan of a radiographic and radio-therapeutic department	555
406. A case of <i>tinea barbæ</i> treated by ultra-violet radiations and a vaccine	557
407. Cheloid scars treated by radiations	563
408. Restoration of suppleness to post-operative scars	564
410. Same case, after completion of treatment	565
409. Soft parts radiated preparatory to a bone graft	564
411. Same case, after completion of treatment	565
412. Nutrition of soft parts improved by radiations, and bone graft inserted	566
413. Cheloid scars of cheek and lips treated by radiations	567
414. Same case, showing final result	567
415. Scars softened and soft parts radiated preparatory to the insertion of a bone graft	568
416. Depilation to permit inversion of skin to replace mucous membrane	568
417. Same case, after completion of treatment	569
418. Depilation of hairy surface similar to above	570
419. Same case, after completion of treatment	570
420. Parotid fistula healed by operation aided by radiations	572
421. Lupus of hand treated by X-rays	575

PART II
RADIO-THERAPEUTICS

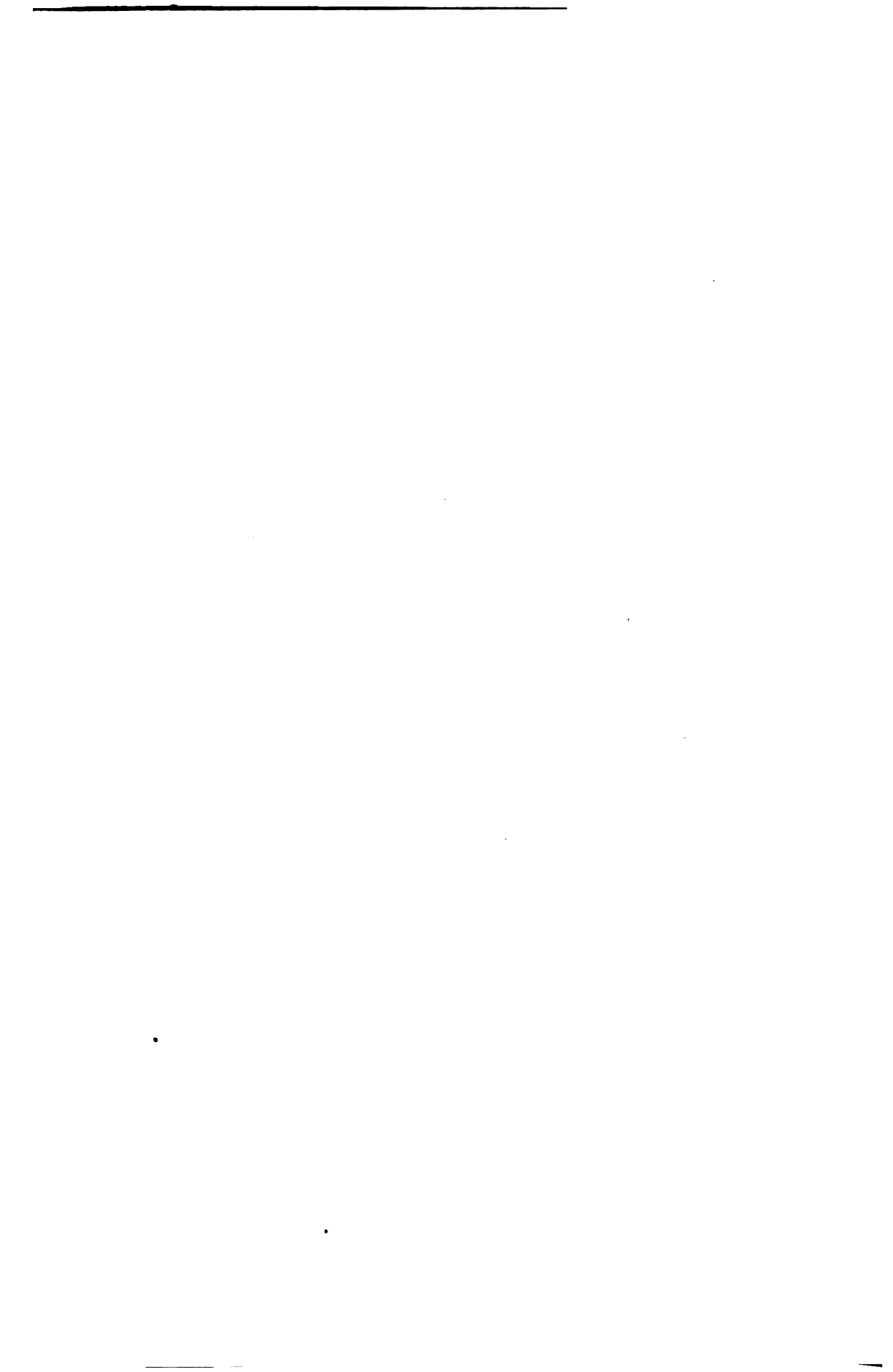

INTRODUCTORY

The treatment of disease by radiation, so far as the scope of this book is concerned, naturally divides itself into :

- (1) Treatment by X-rays ;
- (2) Treatment by Radium.

The physics of radium is briefly described in a separate section, and the production of X-rays is dealt with in the part devoted to radiography. A separate section of the book is devoted to the consideration of practical points in the use of X-rays and radium, but it will be well here to give a brief summary of the general effects of radiations on tissues.

It is assumed that the action is being produced by the radiations from whichever agent is being used, and that the particular effect is dependent upon the quality of the radiation, so that it is immaterial from which source it is derived.

The work of Wickham in the early days of radium therapy, particularly in the treatment of superficial lesions, indicated a large field of usefulness. Dominici, working almost exclusively with the Gamma ray, demonstrated that far-reaching effects could be produced by filtering the radiations, so as to exclude all but the Gamma ray, and for a time this method was largely employed in the treatment of malignant disease. Finzi has further contributed to the literature on radium therapy, dealing particularly with the Gamma radiation. It has been found, however, that excellent therapeutic results can be obtained when the filtration is not nearly so great. These effects must be due to Beta and Gamma radiations. A filter of .3 mm. of platinum cuts off a fairly large proportion of Beta rays, but allows 25 to 30 per cent of these rays to pass through, and exercise an effect upon the tissues. There is therefore a tendency now to cut down the filtration in order that the therapeutic action of both rays may be employed. This is particularly so when radium tubes are buried in the substance of tumours.

The biological reaction of tissues to radiations is another factor which must always be taken into consideration, and this will always remain the deciding factor in the choice of the quality and quantity of rays to be employed. That is to say, it will decide the question of filtration and the time of exposure. It is this factor which makes radiation therapy so difficult, and largely explains the diversity of results obtained by many workers. It is, for instance, a common experience to find two growths of apparently similar

nature responding differently to, as far as can be judged, precisely similar conditions of ray and dosage.

Colwell and Russ deal exhaustively with the action of radiations upon the normal tissues and upon the cells of a new growth. Bergonié and Tribondeau have also extensively studied the subject and arrived at a broad generalisation known as the Law of Bergonié and Tribondeau. "Immature cells and cells in an active state of division are more sensitive to the X-rays than are cells which have already acquired their fixed adult morphological or physiological characters." The normal tissues vary greatly in their response to radiations. The age of the patient is also another factor which exercises an influence on the progress of a morbid growth. Atrophic scirrhus cancer in an elderly patient is generally much less malignant than a similar type of growth in a young and vigorous subject. It is easy, therefore, to understand the complexity of the problem which confronts the radiotherapist in dealing with morbid growths. All of these factors have to be given due consideration. In the course of a number of years of observation in the treatment of disease, the author in particular calls attention to the response of enlarged lymphatic glands to radiation¹ as follows :

It may be stated as an established fact that enlarged glands respond to radiations in the following order :

(1) *Simple Inflammatory Glands*—quickly influenced by a few exposures. This is not applicable to enlarged glands in which the inflammatory process has passed on to the formation of pus.

(2) *Lymphadenomatous Glands*—less quickly acted upon, but almost invariably diminished in size, quickly, after a number of exposures to hard radiations.

(3) *Tuberculous Glands*—not readily affected. It requires a large number of exposures at short intervals to induce retrogressive changes, but ultimately these also slowly respond to radiation treatment.

(4) *Malignant Glands*—these are also influenced favourably. Sarcomata are much readier in their response than carcinomata ; they may disappear, but are apt to recur. Carcinomatous glands are the slowest of all to be influenced, and rarely disappear under treatment ; they may, however, diminish considerably in size.

Taking this response of enlarged glands to radiation treatment, the following table may be constructed :

(1) *Inflammatory Enlarged Glands*—very rapid response.

(2) *Lymphadenomatous Glands*—rapid response.

(3) *Sarcomatous Glands*—rapid response, sometimes almost as rapid a diminution in size as in the case of simple inflammatory glands, but the effect is rarely permanent, there is a tendency to recurrence, and an ultimate refusal to respond to further treatment.

(4) *Tuberculous Glands*—slow response. As a rule, they slowly subside and become quiescent, but very rarely entirely disappear ; they tend to become active again after longer or shorter intervals. From the point of

¹ *Archives of Radiology and Electrotherapy*, June 1916.

view of treatment it is well to remove the glands after they have become quiescent.

(5) *Carcinomatous Glands*—very slow response. They hardly ever disappear or become quiescent; it is better, therefore, to remove them whenever possible, even after prolonged radiation treatment.

(6) *Enlarged Glands due to a Mixed Infection*.—Enlarged lymphatic glands are met with in various parts of the body, and are usually due to one of the foregoing causes; but it must be clearly realised that the predominant cause need not necessarily be the only one; cases occur in which there is a mixed infection, and these cases will, at times, behave in a manner which is disconcerting when an attempt is made to classify the type of gland according to the response to treatment, either by drugs or radiations.

The two groups where this disturbance is likely to occur are (1) the tuberculous, and (2) the malignant.

In the former it may be that only a percentage of the glands are infected with tubercle, the others being enlarged in consequence of some other infective process, or the tuberculous infection may be implanted on glands which are already enlarged from a septic focus somewhere in the area drained by the same lymphatics; the response to treatment may then be irregular, a number of the glands subsiding rapidly, whilst others respond very slowly.

In the case of malignant glands it is not at all uncommon to find a number of glands enlarged where no trace of malignancy can be detected histologically; here again, a mixed response will follow on treatment, the non-malignant glands responding rapidly, while the malignant ones show scarcely any change after many doses of radiations.

In the purely malignant glands the degree of involvement of the gland by malignant cells will also influence the result of treatment—such a gland may have only a very small focus of tumour cells, the greater bulk of the enlargement being composed of inflammatory products, which are reactive in nature to the invading malignant cells—here radiation treatment will aid the reactive process, and lead to the arrest of the extension of the malignant cell area, and ultimately cause their disappearance in fibrous tissue.

Gaarenstroom (*Archives of Radiology and Electrotherapy*) concludes an interesting paper on sarcoma and Röntgen rays with the statement: "Altogether we are of opinion that at present the best criterion for determining the sensibility of sarcomata to radiation is the histological structure of the tumour." A number of other workers have made similar observations. It is therefore obvious that we are slowly arriving at a stage which, when finally established, should aid us greatly in the treatment of malignant disease. The conflicting element in all of these cases is the fact that we have to deal, not only with the malignant growth, but also with the normal tissues which surround it and make up its structural basis. Data obtained from experimental work on the normal tissues may be extremely useful, but the difficulties are accentuated when we have to take into account the response of the abnormal as well as the normal. It is conceivable that certain types of growth are more resistant to the radiations than the normal

structures, and if any good is likely to result from treatment, the dosage will have to be so far in excess of what the normal structures can successfully resist that, instead of benefiting the patient, harmful results may follow. The above briefly puts forward a few of the difficulties which confront the radiotherapist.

The employment of the hardest X-ray it is possible to produce at the present time is sometimes followed by marked results in the treatment of various forms of carcinoma. This hard X-ray has not nearly the penetrating power of the Gamma ray of radium, yet in some cases its therapeutic action is quite as marked. It would appear, therefore, that a wide range of choice in radiation exists in the field of practical therapeutics. It is sound policy, in the present state of our knowledge, to combine the two agents whenever possible. For example, a case of carcinoma of the breast may receive thorough X-ray treatment as a preliminary to the introduction of radium tubes into the substance of the growth. The advantage of using X-rays lies in the fact that treatment may be quickly administered over a wide area, including the growth and its lymphatic distribution. The resulting reaction may lead to a limitation of the growth, and in some instances to a rapid diminution in size. The radium tubes may be introduced into the substance of the growth, and continue or supplement the action of the X-rays at a deeper level. Subsequently the X-rays may be applied at regular intervals as long as is necessary. Patients so treated undoubtedly receive great benefit, both locally and constitutionally.

Action of Radiations upon Tissues

The action of radium and X-rays upon the normal tissues and on morbid growths is not as simple as it appears. It is not purely a caustic action, though caustic effects can readily be produced if the exposure is overdone, or the filtration is not sufficient. In some growths this action is deliberately made use of in order to produce necrosis of the mass, in the hope that when the slough separates normal tissues will fill in the resulting ulcer. On the other hand, enlarged glands sometimes disappear with hardly any skin reaction. One case of recurrent sarcoma of the neck completely cleared up, with merely a slight reaction of the skin surface, and no permanent damage. A case of epithelioma of the tonsil, involving the uvula and soft palate, practically disappeared, leaving a healthy soft palate and uvula. The patient two years later developed a deep ulcer at the site of the original growth, which did not respond to further radium treatment. The surrounding tissue seemed to lack vitality and the ulcer extended deeply. The patient ultimately died from hæmorrhage, the result of an extension of the ulcer into a deep vessel. The ulcer had none of the appearances of malignancy, the suggestion being that it may have been due to a late reaction to the radiation treatment, which had for a time led to a disappearance of the growth.

In addition to the direct evidence of a local action of radiations upon

the cell of a new growth and its surrounding tissues, there is reason to believe that a general effect is produced upon the whole body. This is indicated by the fact that patients undergoing treatment by X-rays or radium occasionally improve markedly in general health. They gain weight, improve in colour, and when the blood is examined an improvement is seen. As an illustration of this beneficial effect, a case may be mentioned where treatment of an ulcerated carcinoma of the breast was followed by a marked improvement in a foul vaginal discharge from which the patient suffered. While growths of the breast are being treated it is not uncommon to find glands in the axilla and other parts diminish in size. This is also observed when cases of sarcoma, lymphadenoma, and other diseases are treated. Whether this is the result of a general stimulation or an auto-vaccination is a point which has yet to be determined. Experimental evidence is forthcoming which goes to show that cancer which has been treated with X-rays or radium does not grow so rapidly when injected into mice as growth which has not had such treatment. It is extremely probable that radiations of X-rays, radium, and similar agents, do exercise a general as well as a local effect upon living organisms. The general effect may be quite as useful as the local, and if it has any value at all, it would be extremely useful to bear in mind, because one need not then limit the area of exposure. After local treatment has been pushed to its limit the treatment may be continued in other parts of the body.

The following observations made on patients undergoing treatment for malignant disease may throw some light on the problem which has been engaging our attention for so long. In the course of treatment of cases of leukæmia the fact has been observed that marked changes, *e.g.* a diminution in the number of white blood corpuscles, relative and absolute, can be induced in the blood by radiations. These changes are obtained when the splenic area is irradiated, as has most generally been the method of treating this disease. The same changes may be brought about when other parts of the body are subjected to treatment; thus the irradiation of the ends of the long bones or areas of the abdomen results in a change in the percentage of blood cells and a reduction in the size of the spleen. Observations such as these lead us to infer that the beneficial effects of X-rays on certain cases of this disease may be due to a general as well as to a local action. Further, it has been observed during the local treatment of carcinoma of the breast, that glands at a distance which have not received any direct treatment have slowly diminished in size. It has also been noticed during the treatment of such diseases as tuberculosis, lymphadenoma, and sarcoma, that, while the local condition has improved as a result of direct treatment, the more distant glands have also diminished.

The writer has for several years been making observations on blood changes induced in patients undergoing treatment by radiations. At the commencement of these observations the whole attention was directed to the white blood cells, which were observed to vary considerably at different stages of the disease according to the accompanying infection, and also as a

result of destructive changes occurring in the tumour and surrounding tissues. During the period of treatment a careful watch should be kept on the white corpuscles, and a rapid diminution in number should indicate a suspension of treatment; in cases with a low white cell count vigorous treatment should be avoided.

More recently attention has been directed to the behaviour of the red blood corpuscles under similar conditions. As an outcome of these observations it can be stated that in the cases where the percentage of red blood cells is normal or over and the hæmoglobin is 100 per cent, or almost so, the response to treatment is more rapid and lasting than when, as is so frequently the case in advanced stages of malignant disease, the percentage of red cells is much below the normal. In several patients whose response to X-ray and radium treatment has been rapid and marked, the percentage of red cells has been well over the normal. One case recorded well over 8,000,000, and the hæmoglobin colour index stood at 100 per cent. Nearly every case which showed a normal or plus normal condition of the red cells responded well to X-ray treatment.

In view of the excellent work done on secondary radiations of metals by Barkla, Sadler, and others, and the valuable work done by Hernaman-Johnson in the application of metals to produce the secondary radiations in the tissues of patients treated by X-rays, the most likely explanation of this remarkable response in these cases is that in the blood stream there exist materials which, when bombarded by the radiations of X-rays or radium, throw off secondary radiations which in some way act on the normal and abnormal tissue, stimulating the former, and in some instances damaging the latter, and leading to a diminution in the size of the tumour. The most likely material to give off secondary rays is the hæmoglobin of the red cells, which is a compound of iron. The latter metal is known to give off secondary radiations when exposed to X-rays. It is interesting to note that iron stands high in the list of metals which give off radiations when struck by X-rays. These radiations are independent of the chemical combination of the metals, and only depend on the quantity of the metal present. It must be borne in mind that metals require a particular hardness of X-ray to enable them to emit the characteristic secondary radiations peculiar to them. This may in part account for the marked degree of action produced in cases which have a high percentage of hæmoglobin. It also throws some light on the cases which have failed to respond; possibly the particular quality of X-radiation employed has not been the right one, or the exposure has not been long enough. There are other elements which alone or in various combinations, when injected into the tissues, are circulated in the blood and lymph streams, which, when acted upon by X-rays or radium rays give off secondary radiations. As will be shown later, salvarsan, when used in combination with X-rays, often leads to striking improvements in the conditions treated. In the writer's own experience the best results have, in a number of cases, been obtained when using the hardest X-ray possible, combined with the use of aluminium filters. In this relationship it is important to remember

that the blood is a rapidly moving fluid, which, as it passes through the tissues, absorbs a considerable percentage of the radiation. The exact quantity absorbed will depend upon whether the wave-length is one which is likely to be absorbed by the blood. Consequently in very vascular parts or areas of inflamed tissue it may be necessary to take this factor into account in the estimation of dosage. The direct effect of the radiations upon the blood must be taken into account. This may possess a particular value in the treatment of blood diseases, it being assumed that the radiation is absorbed by the blood corpuscles as soon as the primary beam impinges on a substance which gives off its characteristic radiation. The effects produced in the blood thereafter must be largely those of tissue change. Chemical changes may be induced, or the particular element affected may be at once killed; when physiological processes are stimulated, or, as may happen, inhibited, far-reaching changes may result. This blood stream, travelling to distant parts of the body, may produce results either beneficial or harmful.

The special part played by the blood stream in the absorption of radiations is at present the subject of experimental investigation.

The hard Beta rays and the Gamma rays from radium appear to exercise a marked influence upon some cases of cancer. The duration and frequency of the exposures also play an important part in the results. At present experience alone can show us how and when to repeat the radiations. When the secondary radiation values of the constituents of a malignant growth and of the blood and lymph and the substances they contain are known, and when improvements in X-ray tubes and control apparatus enable us to select the ray which will cause it to emit its secondary radiation when it strikes upon, say, the iron in the blood, we may hope to produce a reaction in and around the growth which should materially help us in treatment. Then we may hope for marked improvement in results.

It is probable that we have here also an explanation of the changes which may be induced in the more distant parts; the blood which receives local treatment in its passage through the growth and surrounding tissues is acted upon by these radiations, and the effects produced on the cells in the local growth are carried on to the other parts of the body, and exercise a stimulating effect on tissue metabolism, which may result in changes in these parts. The suggestion is one well worth careful consideration and investigation, for here we possess an excellent vehicle by means of which we can obtain secondary effects from direct radiations upon particular parts. The use of copper and other metals in colloidal solution has been employed as an adjunct to radiation treatment; theoretically the combination of the two is perfect and should be employed whenever possible.

The obvious inference is that in all cases of malignant disease we should endeavour to keep the red blood corpuscles up to or above normal and increase the colour value by giving the patient iron and other drugs which are known to exercise a tonic effect while we bombard the local condition with regular doses of radiations. Recently some cases undergoing radiation treatment have also received injections of salvarsan; the response to this

combined treatment has been very marked, the improvement being greater and more rapid than when either is used separately. It is necessary, however, to watch carefully the action of both agents, and especially that of the radiations, care being taken not to press the dosage too rapidly, in order to avoid the danger of too sudden and far-reaching changes in the blood and tissues. The radiation employed should be of a quality which is known to produce the secondary effects upon the iron and other substances capable of producing secondary radiations in the blood. The treatment of malignant growths must therefore be general as well as local. The general treatment consists of a suitable diet, plenty of fresh air, and iron tonics—the latter in excess if the patient is tolerant.

In the treatment of a number of diseases, for example, lymphadenoma, lymphosarcoma, enlargement of the lymphatic glands, due to tubercle leukæmia, and the enlarged thyroid in exophthalmic goitre, rest is most important. The patients are frequently very ill, yet it is not at all uncommon for them to come regularly for treatment to the X-ray room. Too much attention is paid to the radiation side of the treatment, while the other and equally important one of rest, fresh air, and drugs is neglected. Such patients should be treated on the same lines as those suffering from active tuberculosis. When radiations are considered necessary they should be administered at the bedside, with as little disturbance as possible. For the efficient treatment of these cases a sanatorium régime is the most practical, for then the patient will receive other and equally important treatment. A further point of the utmost importance in dealing with cases which have responded well to radiations, and in which the disease for the time being has been arrested, is the after-treatment of the patient. Prolonged rest under favourable conditions, coupled with occasional radiation treatment, will greatly aid in the firm establishment of good health. The disease may in these cases be one of disturbed metabolic balance. Radiation treatment may only be the factor which aids in the temporary restoration of the balance. Nature alone can ensure the maintenance of the balance after it has been restored. Given suitable conditions, she may in the long run restore the patient to permanent good health. It is therefore sound policy to insist on as long a period of convalescence as possible, under an ideal régime, in the hope that by so doing the cure may become a permanent one.

General Treatment of Malignant Disease.—Rest in bed during treatment should in some cases be insisted upon. The local treatment should consist of such measures as will induce a liberal flow of blood to the part, *e.g.* :

(a) Brush high-frequency discharges, which are very useful for this purpose, and should be given just before or at the same time as the X-ray treatment.

(b) The mercury vapour lamp, which also induces an increased superficial blood flow.

(c) Diathermy. This form of high-frequency current is said to increase the sensibility of tissues to the action of radiation. Previous to radiation

treatment the parts may be thoroughly exposed between two electrodes, and radiation treatment then applied.

(d) The application of cold to the surface during the treatment is believed to increase the local radio-sensibility of the tissues.

Superficial Reaction occurring in the Course of Treatment by Radiations.—It has been observed in treating superficial carcinoma that improvement hardly ever takes place until a degree of reaction is produced. Also, the X-ray or radium exposures should be of sufficient duration to induce and keep up in the tissues a moderate degree of reaction. In severe cases, in which the disease is superficial, the reaction may require to be marked. Under treatment of this kind recurrent nodules and primary growths of considerable size frequently diminish considerably, and larger tumours become smaller, and in some cases are rendered operable. Recurrent nodules and small primary growths sometimes entirely disappear. It is also possible that the blood serum may contain substances which give off secondary radiations which alter the composition of the serum. A great deal of work has been done in this direction. Future research in the investigation of physical phenomena should be directed on lines which are likely to throw light on the action of secondary radiations in the tissues themselves. By a combined attack from the physical and clinical aspects, we may hope in the near future to produce a marked improvement in our methods of treatment by radiations, which should result in material benefit to patients suffering from malignant disease.

Action of Radiations on Normal Tissues and Morbid Growths

That the radiations from radium and X-rays exercise a marked influence upon tissues and tissue metabolism is an admitted fact, but the nature of this influence is still imperfectly understood, and must necessarily remain so until we know more about the biological effects induced in the tissues by these radiations.

All the early work was carried out under conditions of partial knowledge. The results varied as a consequence, and hence conflicting opinions were promulgated, in many cases hastily, on the value of radium in therapeutics.

It may be stated at the outset that all living tissues are affected by the various rays from radium or other bodies—Alpha, Beta, and Gamma—to an unequal extent, varying with the particular rays which predominate in the exposure. In the case of radium (when this is used) the predominance of any particular radiation effect depends upon the quantity of radium used, the filtration, the distance of the applicator from the tissues in question, and the length of exposure. Radium is taken as an example for convenience of description. The action is similar when radiations from other sources are used.

Action on Normal Tissues.—Radium acts as a stimulant to normal

tissues, causing congestion of the areas exposed to its radiations ; congestion is followed after an interval of time by an increased formation of fibrous tissue. If the exposure is prolonged, or the filtration insufficient, the action of the rays becomes a caustic one, and an acute inflammatory process is set up, which may go on to necrosis and sloughing of the tissues exposed.

When the exposure has been accurately calculated, the inflammation slowly subsides after a given time, the deeper tissues participating in the reaction in a diminishing ratio, according to their depth from the surface. There is in all the tissues an inflammatory condition, with a leucocyte migration and an invasion of small round cells. When this subsides fibrous tissue formation begins, and the newly formed connective tissue with its capillary blood-vessels may surround individual cells or areas of cells, and by subsequent contraction cut off the blood-supply to these areas ; then will occur changes of a varying degree, according to the rate at which the blood-supply is restricted : if rapid occlusion of a blood-vessel takes place, local necrosis will quickly follow ; if it is more gradual, atrophic changes may ensue. When a section from the tissue is examined all these changes may be found taking place at the same time in various parts of the section.

Action on the Skin.—A section from a portion of skin adjacent to a new growth which has been treated with radium shows a well-marked leucocyte infiltration in the cornual layer of the epidermis. The squamous cells are degenerated and have lost their nuclei. These changes are noticed when the skin has been subjected to prolonged exposures, the atrophy of the skin bearing a direct relation to the duration of the exposure. Skin so treated recovers its normal condition if the exposure has not been too great. The atrophic changes will increase as the dose increases. The degenerative changes occur in all the structures forming the cuticle, hair-bulbs being damaged or destroyed.

Action on Hair.—Hair in the neighbourhood of an area treated by radiation will lose its vitality and fall out ; a permanent alopecia may follow.

Nerve Tissue.—Nerve fibres may become influenced, and a condition of neuritis or perineuritis be set up. This may give rise to a considerable degree of pain.

Action on Sweat Glands.—These are readily affected by radium rays or X-rays. The preliminary change will be a stage of engorgement of the surrounding vessels, and the atrophy, which may be marked, may follow at a later date. Complete destruction of the gland will be the result of over-exposure, the gland becoming involved in fibrous tissue. This action on sweat glands may be employed in therapeutics, when radium may be used instead of X-rays.

Muscle Fibres undergo a degree of degeneration. A loss of striation is seen, and a form of hyaline degeneration follows. The muscle bundles are invaded by small round cells, and fibrosis of the bundle can often be observed in sections. These changes are seen in Figs. C and D, Plate LXXIX. Fig. C shows a transverse section of bundles of muscle fibres which were removed from a patient who was treated with radium. The section shows bundles

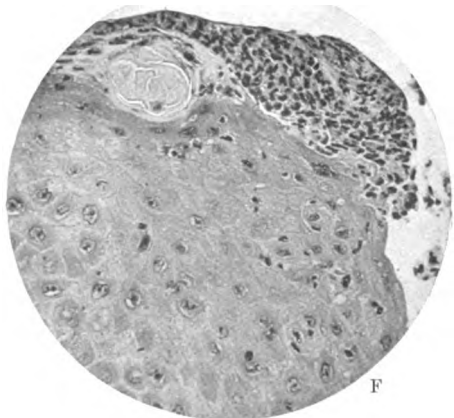
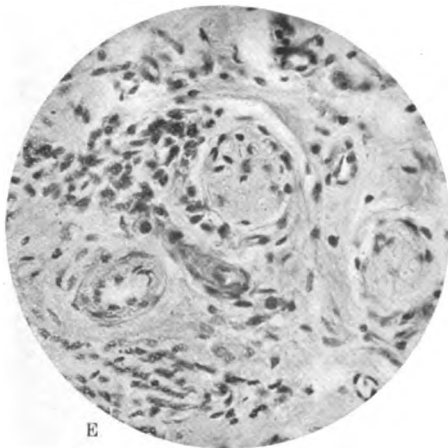
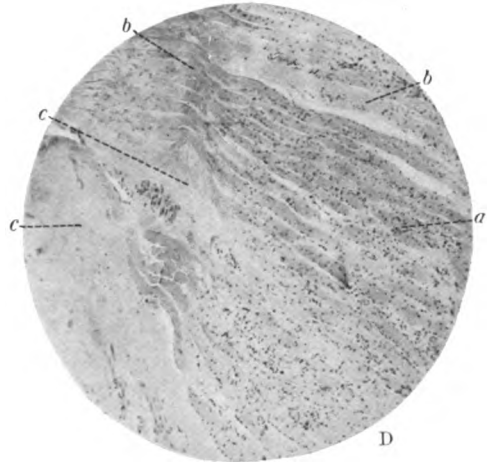
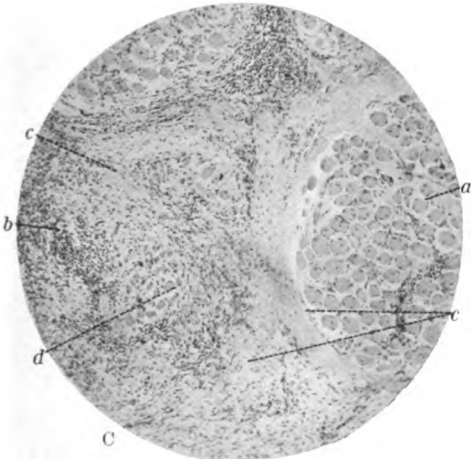
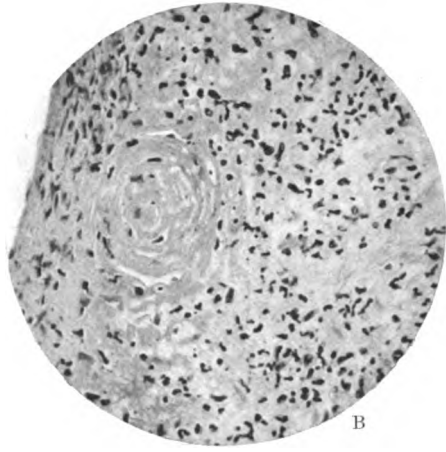
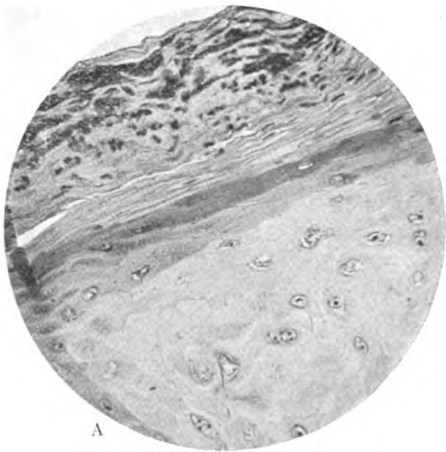

PLATE LXXIX.—CHANGES PRODUCED IN NORMAL TISSUES BY RADIATIONS.

- A, High-power magnification. Leucocytes in corneal layer of epithelium, squamous cells degenerated, changes in nuclei.
- B, High-power magnification. Leucocyte infiltration of an ulcerated surface, obliterated blood-vessel in a mass of degenerated squamous cells.
- C, Section showing changes in bundles of muscle fibres, partial destruction of two small bundles (*a*), small round-celled invasion (*b*), increase of fibrous tissue between the muscle fibres (*c*), and atrophy of fibres (*d*).
- D, Groups of muscle fibres in longitudinal section. (*a*) Small round-cell infiltration; (*b*) loss of striation of muscle fibres; (*c*) replacement of muscle fibres by fibrous tissue.
- E, High-power magnification, showing two small nerves and a blood-vessel surrounded by well-formed fibrous tissue; also many young connective-tissue cells. There are a few fibro-blasts in the large nerve trunk.
- F, High-power magnification. Squamous epithelioma with patches of round-celled inflammatory exudation on surface. The squamous cells next to this are large and irregular and a few leucocytes have penetrated between the cells.

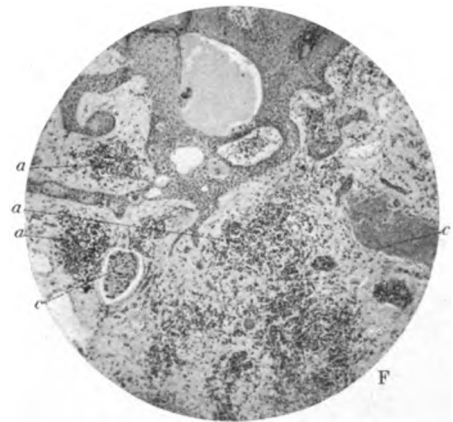
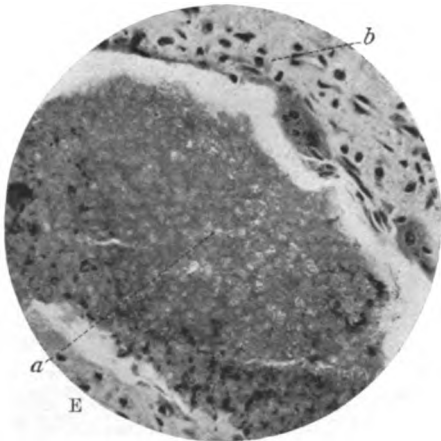
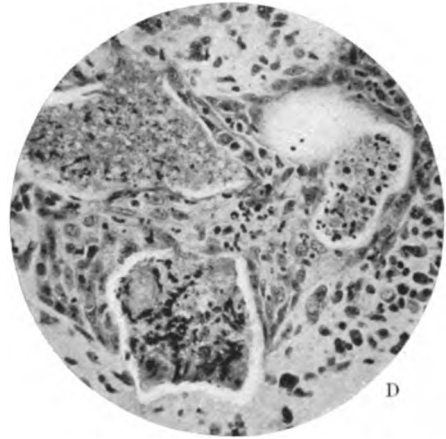
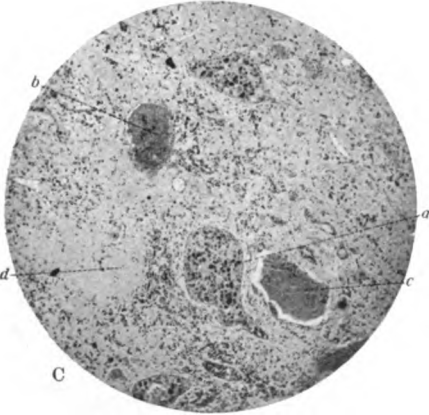
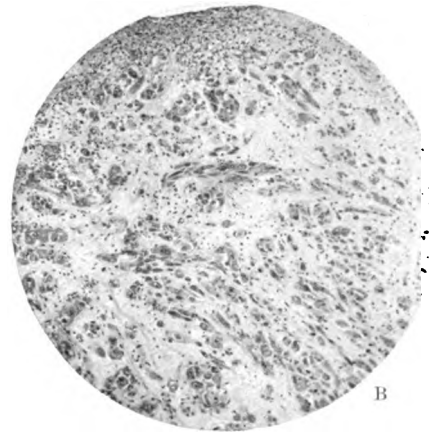
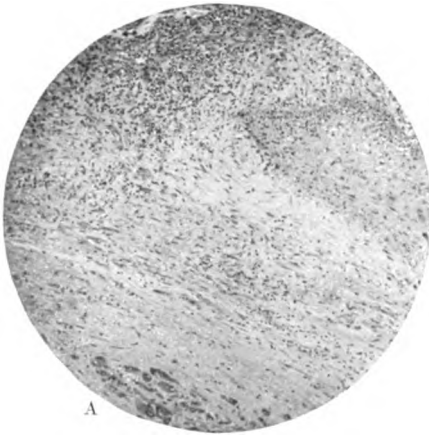

PLATE LXXX.—CHANGES OBSERVED IN TUMOURS WHICH HAVE BEEN TREATED BY RADIATIONS.

A, Low-power magnification, showing increase of fibrous tissue with many young connective-tissue cells and a large number of black dots representing small round inflammatory cells. An interpapillary process of squamous cells is seen on the upper right side. Below are seen numerous large cells in small clusters surrounded by fibrous tissue.

B, Collection of large irregular cells embedded in hyaline tissue (fibrous); many of the cells are of the typical squamous type. There are many small round inflammatory cells scattered throughout the section in the connective-tissue stroma. The upper part represents the ulcerated surface of the tumour and is composed of a layer of fibrin and leucocytes.

C, Low-power magnification from a case of carcinoma of the breast, treated with X-rays and radium, showing groups of cancer cells undergoing degenerative changes. (*a*) Fairly active group, (*b*) more advanced degeneration, (*c*) hyaline degeneration, (*d*) a mass of fibrous tissue.

D, High-power magnification of several groups of cancer cells showing various stages of degeneration.

E, High-power magnification of portion marked *c* in *C*; the mass is filled up by granular debris *a*; *b*, round-celled infiltration.

F, A section from a case of carcinoma treated with radium, showing (*a*) excessive fibrous-tissue formation; (*c*) groups of cancer cells undergoing degeneration.

of muscle surrounded by well-formed fibrous tissue which has invaded and partly destroyed two of the smaller bundles. There are many small round inflammatory cells occupying the fibrous tissue and in parts lying between the muscle fibres. The general appearance is suggestive of the changes seen in cirrhosis of the liver. The longitudinal section seen in Fig. D shows at (a) the small round cell infiltration, at (b) muscle fibre which has lost its striated appearance, and at (c) the dense fibrous tissue.

Blood-Vessels.—The vessels are involved in the general inflammatory process. There is a proliferation of the endothelium of the small capillaries, which leads to occlusion of the lumen, and consequent arrest of the circulation. The large vessels show a proliferation of the intima, and occasionally a vessel may be seen with the lumen occluded.

Fig. B, Plate LXXIX., illustrates a blood-vessel in a section which shows leucocyte infiltration of an ulcerated surface. An oval patch to the left of the section represents a blood-vessel which has become occluded and is situated in a mass of degenerated squamous cells. Fig. E of same Plate is a high-power view of a section showing two small nerves and a blood-vessel surrounded by well-formed fibrous tissue.

Action of Radium on Vascular Connective Tissues.—The disappearance of inflammatory conditions and tumours on which radium exercises an action eventually depend upon two phenomena, which are as follows:

- (1) The destruction by radiations of the anatomical elements modified by inflammation and by the progress of the tumour.
- (2) The absorption of degenerated tissue by the phagocytes, and its replacement by sclerotic tissue.

Wickham and Degrais admit that these phenomena may account for changes which occur in some affections treated by radium, but point out that this is not the only result of the process when radium is employed on inflammatory conditions, on tumours of the connective tissue, and on epithelioid tumours. Instead of hastening the degeneration of connective tissue cells injured by inflammation or by the progress of the tumour, the radium rays revive the vitality of these elements, and subject them to an evolution differing from that which the pathogenic influences were producing. The special action of the Becquerel ray is then substituted for that of the pathogenic process. Their effects are manifested either by the arrest of the inflammatory process or by the resolution of the tumour, and by a change of structure in the connective tissue. The above argument is open to criticism in that it presupposes a selective action of radiations upon pathogenic processes and connective tissue elements. The question is fully dealt with later on, but it may be said here that the difficulty can be explained by the theory that as radium acts on all tissues in varying degree according to the susceptibility of the cell, different results are obtained when the tissues are more resistant than when they are less so. If the tumour elements were stimulated as well as the connective tissue cells, their increase in activity would lead to an increase in the size of the tumour, and thus the pathogenic processes referred to above would predominate and lead to a further destruc-

tion of the normal histological elements. On the other hand, should the connective tissue cells receive the more powerful stimulation, their increase would be the dominant factor. It is thus possible to explain all the changes induced in the tissues without claiming a selective action for radium. Wickham and Degrais, however, further argue: "This change consists (a) in a metamorphosis of the vascular connective tissue into angiomatous embryonic tissue; (b) in transformation of this embryonic tissue into connective fibrous tissue of regular texture. In such a case the healing of inflammatory conditions or of tumours is the function of a special cellular evolution produced by the Becquerel rays. The healthy connective tissue itself undergoes this evolution."

Action of Radiations upon Tumour Cells.—Occasionally enlarged glands are reduced in size with hardly any skin reaction; nothing more than a slight erythema may be produced even after repeated exposures to the same area of skin, yet the enlarged glands situated at a much deeper level slowly diminish in size. It is quite possible to produce deep-seated and far-reaching effects upon tissue irradiated from the surface with no appearance of skin reaction, or only reaction of a slight temporary nature. This is particularly evident when using filtered rays if care is taken to ensure adequate protection of the skin by the use of thick secondary filters, *i.e.* filters consisting of thick paper, felt, or chamois leather.

Malignant indurated ulcers will rapidly break down and at a later date heal under the action of radium.

The degree of action induced is dependent to some extent upon the method of application. The various degrees of tissue change depend upon the filtration employed and the length of the exposure. Thus, if necrosis of the growth is necessary, a thin filter would be used and a long exposure given. Here we are making use of the Beta ray almost entirely. Should it be necessary to act on a deeper structure and at the same time protect the skin from such action, a thick filter of platinum or lead is used. Two millimetres of platinum or four of lead are sufficient to cut off all but the hardest of the Beta rays, while the Gamma ray is unaltered. The filters containing the radium are enclosed in a rubber tube to prevent the secondary radiation induced in the platinum by the radium rays from damaging the superficial structures. If the exposure be long, further protection can be secured by using lint or gamgee tissue an inch or more in thickness. In this way we can control the exposure so that we get nearly the pure Gamma-ray effect. This enables us to get an action upon the deep-seated parts.

It has been claimed that radium possesses a "selective action" on cancer cells. While admitting that it undoubtedly appears to act on such cells, the word "selective" is badly used. Colwell and Russ particularly direct attention to the selective absorption of radiations by the tissues. This is applicable to all forms of radiation, and has no special reference to radium. The term appears to be a more rational one than that of "selective action," as in using the latter we are definitely claiming that radium possesses a selective action upon cellular structure, and particularly upon the cancer

cell. Radium exercises an action on all living cells in a varying degree according to the resistance of the particular cell in question. Thus, young actively growing cells are more readily influenced than mature cells. The cells of a new growth approximate in structure and power of resistance to the actively growing cells of a tissue. In this way it is conceivable that the cancer cell is influenced should it at the time of exposure be comparatively early in its life-cycle. Should the cancer cells be of a stronger or more vigorous type, it is conceivable that the action of the radium may be stimulating, and instead of a decrease in vigour of a particular cell we may find an increase in activity, and a consequent increase in the size of a tumour. It is a fact that some cases of cancer increase in size at a quicker rate after radium has been applied. Some types of cancer are more amenable to radium treatment than others.

The action of radiations upon tumour cells can be seen from a number of photomicrographs from sections obtained during the treatment with radium of malignant growths. These sections are from a number of cases, but some are from the same case at different periods of treatment. They show in some parts marked retrogressive changes.

Fig. F, Plate LXXIX.—A section of tissue adjacent to a carcinoma of the arm which received prolonged radium treatment. There is a marked degree of exudation on the surface. The squamous cells adjoining this are large and irregular, and a few leucocytes have penetrated between the cells.

Fig. A, Plate LXXX.—A low-power view of another section from the same patient. There is a considerable increase of fibrous tissue cells, and a large number of black specks represent small round inflammatory cells. An interpapillary process of squamous cells is seen on the upper left side. To the right below are seen numerous large cells in small clusters separated by fibrous tissue. These cells represent all the new growth present in the field.

Fig. B, Plate LXXX., shows a small collection of large irregular-shaped cells embedded in hyaline tissue (fibrous). Many of the cells are of the typical squamous type, and are separated by clear intervals, there being an absence of intercellular substance. The upper part represents the ulcerated surface of the tumour, and is composed of a layer of fibrin and leucocytes.

Fig. C, Plate LXXX.—A low-power view of a portion of tumour removed from an atrophic cancer of the breast after repeated X-ray exposures, followed by one exposure to radium, applied directly over the portion of growth removed for examination. It shows groups of cancer cells undergoing degenerative changes. (a) A group of cells which are fairly active. The group is well defined at its edge, and is surrounded by fibrous tissue. (b) A group of cells which have undergone marked degeneration. There are a number of small round cells in the group. (c) A mass of cancer tissue which shows more marked degenerative changes. (d) Area showing excessive fibrous tissue formation.

Fig. E, Plate LXXX.—A high-power view from section C shows a large mass of cancer cells which have undergone degeneration, the place of the

cells being filled by granular debris. At the edges, small round-cell infiltration is seen.

Fig. D.—A high-power view of a portion of tissue from the same case, showing stages of degenerative process.

Fig. F.—A section from a case of carcinoma of the breast, showing (1) excessive fibrous tissue formation; (2) malignant cells in various stages of degeneration.

Fig. A, Plate LXXXI., is a higher magnification of a portion of Fig. F in Plate LXXX., a group of cells which still retain their activity. Several of the cells appear to have degenerated, and there is evidence of nuclear changes.

Fig. B.—A more advanced stage of change in cells than in preceding figure. The cells are large and very irregular in shape. Vacuolation is marked in one group. Other cells show division of nuclei.

Fig. C.—A group of cells embedded in a fibrous matrix. There is marked leucocyte infiltration.

Fig. D shows a similar condition and a more advanced stage of degeneration in several of the cells.

Fig. E.—A mass of cellular growth with practically no fibrous tissue. The cells are large and generally elongated in shape. The space between the nuclei is irregular and the nucleoli are well marked. This is a condition of the cells frequently seen in these cases. Presumably an active group of cells has been stimulated to increased growth, and some of the cells have been damaged by the radiations.

Fig. F.—A high-power view from a section of growth showing leucocytes at surface with fibrous tissue formation. Large irregular cells lie in a loose cellular tissue. They are pale, and suggest an early stage of degeneration.

Fig. A, Plate LXXXII.—A section similar to the last, showing leucocytes in long narrow vessels running between the cells of the growth.

Fig. B.—Another section near the surface of a growth, showing much round-cell infiltration between the cells of the growth.

Fig. C.—A group of large cancer cells in the midst of loose fibrous tissue, with a few round cells interspersed.

Fig. D.—A high-power view from a section showing the surface of the growth. A group of large irregular cells in alveoli separated by loose connective tissue. These cells stain well and have large nuclei, and there are many leucocytes in the stroma. The tissue is denser towards the surface, and certain concentric bodies, the remains of cells of the new growth, are present. The fibrous tissue of the walls of the alveoli of growth collapse as the growth cells are destroyed. The blood-vessels have been obliterated. The surface layers of the tissue are denser than those at a deeper level, probably the results of the action of the radiations.

Fig. E.—A section from a squamous-celled carcinoma removed from a tonsil before treatment by radium. This patient completely recovered after thorough treatment. The section shows irregular masses of squamous cells divided by scanty stroma of fibrous tissue, in which there are many small round inflammatory cells. A few of these inflammatory

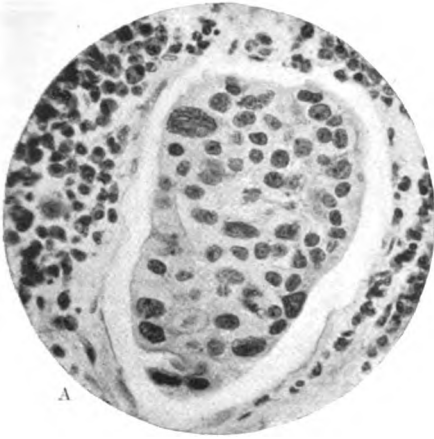

A

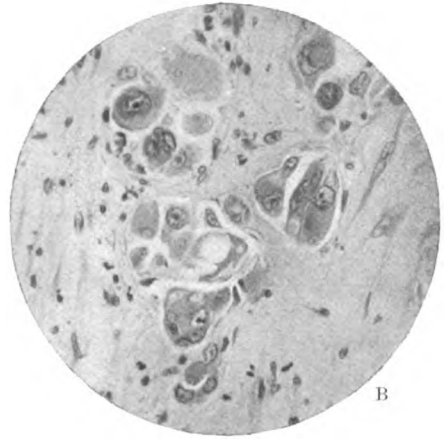

B



C

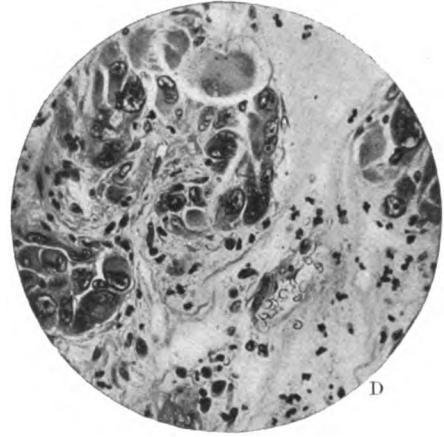

D

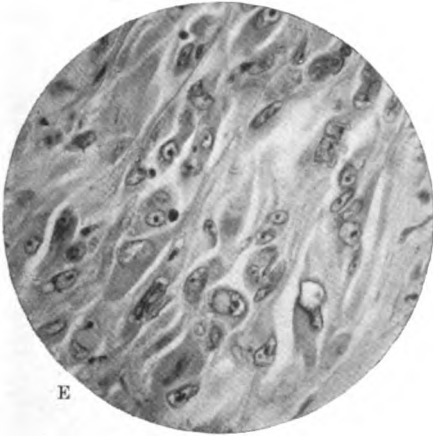

E

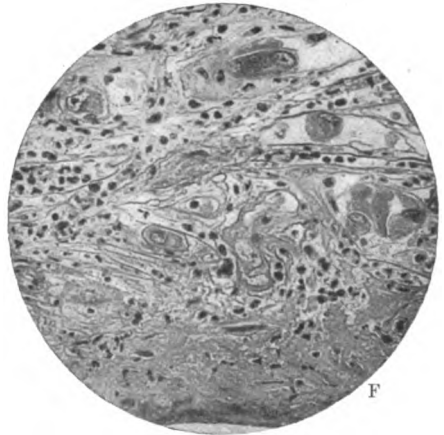

F

PLATE LXXXI.—CHANGES OBSERVED IN TUMOURS WHICH HAVE BEEN TREATED BY RADIATIONS.

- A, High-power magnification from portion of Plate LXXX, F, marked c.
 B, High magnification of groups of cancer cells. Cells large and very irregular in shape, exudation is marked in one group of cells, other cells show division of nuclei.
 C, High magnification of groups of cancer cells embedded in fibrous matrix, leucocyte infiltration.
 D, High magnification. Another field from same section showing somewhat more advanced changes of a like nature.
 E, High magnification, showing a mass of cellular growth, with very little fibrous tissue, cells large and elongated, nuclei irregular and nucleoli well shown.
 F, High magnification showing fibrous tissue and leucocytes at surface with hyaline changes; large irregular cells lie in loose tissue, they are pale and suggest degenerative changes.

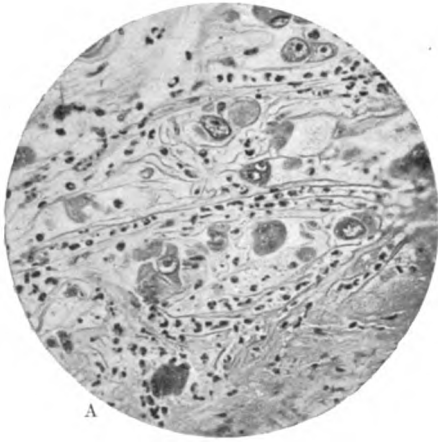

A

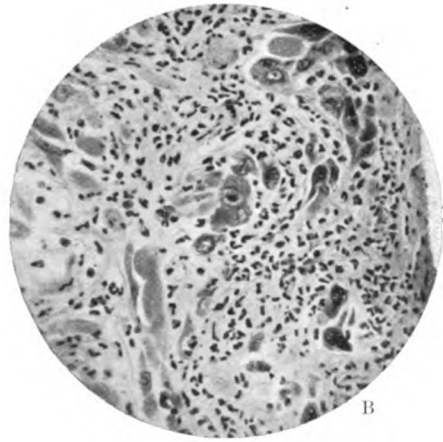

B

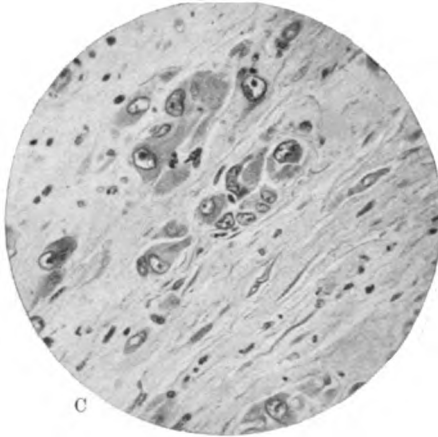

C

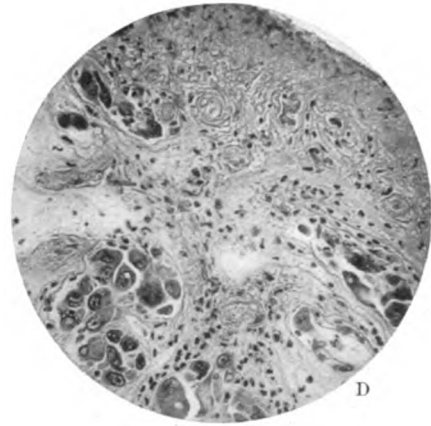

D



E

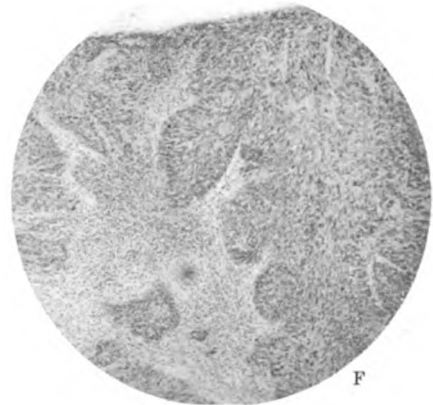

F

PLATE LXXXII.—A TO D, CHANGES OBSERVED IN TUMOURS WHICH HAVE BEEN TREATED BY RADIATIONS.

A, Another view from same section of tissue as **F** in preceding plate. Leucocytes in long narrow vessels running between the cells of a growth.

B, Section near the surface of a growth showing considerable round-cell infiltration between the cells.

C, Group of large cells in the midst of loose fibrous tissue; there are very few round cells in the fibrous tissue.

D, High-power magnification of surface and underlying growth; group of large irregular cells in alveoli separated by loose connective tissue; nuclei are large; tissue denser towards the surface; and connective bodies are seen (remains of tumour cells?), blood-vessels obliterated.

E AND F, SECTIONS FROM A TUMOUR BEFORE TREATMENT.

E, A section from a squamous-celled carcinoma before treatment with radium, showing irregular masses of squamous cells divided by scanty stroma of fibrous tissue, many round inflammatory cells; cell nests.

F, Another section from the same case; tumour cells irregular in shape with a tendency to cornification towards the centre.

cells also invade the groups of cancer cells. The central cells of several of the masses are large, cornified, and form typical cell nests.

Fig. F.—Another section from the same case. A large mass of growth on right, with several offshoots towards the centre. The cells are irregular in shape with a tendency to cornification in the centre. Smaller masses of cells on the left also show a tendency to cornification towards the centre. These are thickly studded with small round inflammatory cells. A few of these round cells are also seen among the squamous cells of the growth.

In addition to the action upon the cancer cell itself, radium acts upon all the tissues composing the growth and surrounding structures unequally. There is a general stimulation of the healthy tissues as a result of radium treatment so long as the exposure is not excessive. If it should be excessive the action is apt to produce a caustic and ulcerative effect, which leads to local death of the tumour and a portion of the tissues around it. This may sometimes be desirable.

When the effect upon the healthy tissues is confined to stimulation, we expect to find an increase of fibrous tissue formation, which shuts off the cancer tissue from its blood-supply and causes the atrophy of such cells. The reparative power of the normal tissues is strengthened, enabling them to cope with the invading cells and lead to their destruction. These changes can be seen in sections removed from cases undergoing treatment.

The changes induced in malignant growths by the action of radium and similar agents are, so far as we can see, indistinguishable from the degenerative changes seen in cases of growth which have received no treatment; but this important point must be insisted upon, that the percentage of cases in which we see these changes is much larger in the group of cases treated by radiations than in the group which has received no treatment.

It must be admitted that occasionally we see a case of untreated cancer diminish in size and, in a very small percentage, ultimately disappear. During the treatment of cancer by radiations it is by no means uncommon in a fairly large percentage of our cases to see a marked diminution in size produced. In a smaller percentage we do see the growth disappear—at all events for a time.

The local disappearance of a growth is not a cure. The disease may have, and in the majority of cases undoubtedly has, extended to other parts of the body. Consequently no case can be said to have been cured until we have given the deeper ramifications of the growth sufficient time to develop and manifest their presence. It is, therefore, important that before we treat the local condition a search be made for secondary deposits. From the point of view of prognosis, this is a most important matter.

Factors influencing the Result of Treatment.—In routine treatment by radium, the following factors should always be kept in mind, as a full consideration of all in each case will help us to foretell the degree of action and the result likely to follow from treatment :

- (a) Type of growth and condition of patient.
- (b) Situation of the tumour, and size.
- (c) The quantity of radium used.
- (d) The filtration employed.
- (e) The duration of the exposure.

An improvement in the results at present obtainable by radium in the treatment of malignant disease may be obtained :

(a) Larger quantities of radium may be used. Up to the present the largest quantity used has been about 1 gram of pure radium salt. Far-reaching effects may be produced by such treatment, especially if the filtration is great and the exposure prolonged ; yet, even with such a dose, the result in several cases has been temporary benefit only. The type of case so treated has been a deep-seated growth, which could only be acted on by the very penetrating rays. For surface lesions the increased dosage may have a speedier effect, which should help to prevent the spread of the growth to deeper structures if it can be efficiently checked.

(b) A more thorough knowledge of the physical properties of radium may enable us to select for particular cases the quality of radiations likely to influence the cell metabolism. This statement applies chiefly to the medical man who is generally responsible for the administration of the treatment. The physical properties of radium have been exhaustively dealt with in several works on the subject. Recently a work by Colwell and Russ has appeared which deals exhaustively with many of the problems which have a direct bearing upon the practical application of radiations.

(c) It must be admitted that the technique has hitherto been more or less faulty. A fuller knowledge of the influence of the various thicknesses of filters may help us to get speedier results. It may be that the use of the Beta-rays in some cases would lead to better results. Similarly the Alpha-rays, which up to the present have been little used, may in the future be found to exercise an inhibitory effect upon morbid processes when they are brought into contact with the cells of a growth. The difficulty has been to apply them at all. The radio-active waters at present in use do not appear to have any influence on cancer cells.

It may be possible to deposit the active principles of the radium emanations in such a way that we can utilise them either by direct application or by ionisation with the aid of a galvanic current, or a combination of radiations may be helpful. In several cases radium and X-rays together appear to have hastened reparative processes. It is possible that some of the effects noticed may be due to secondary radiations, produced in the structures composing the growth, which exercise a physiological action. Some such general action appears to take place, because it is quite a common occurrence for patients so treated to improve in general health.

The employment of radiations in any form leads to a constitutional disturbance which we designate as reaction. This varies in time of onset according to the dosage. After a time a period of depression sets in, most probably due to a change set up in the growth which leads to the liberation

of toxins into the circulation. If they are excessive, the condition of the patient may be rendered serious. This form of toxæmia is met with when large rectal growths are treated. It is possible to make the condition of the patient much worse if care is not taken to regulate the dose.

Up to the present the treatment of malignant disease by radium and other radio-active bodies has been purely local. Consequently it cannot be regarded as a specific method of treatment. The conditions under which it may become so are being investigated. The endeavour must be to procure a substance, radio-active or not, which, when introduced into the general circulation, will influence morbid processes in the tissues. It may be possible to use a substance which, when treated locally by radium, X-rays, or other agents capable of exciting the secondary radiations of such substances, will benefit the tissues. Salvarsan and colloidal preparations of particular metals are used in this way.

The best we have yet been able to do has been by local stimulation to produce secondary radiations from the tissues, blood, and lymph in the deposits of cancer. When the secondary radiation value of these tissues is better known, and when we know which particular radiation acting upon them will give us their maximum value, then we may hope to improve our results.

Dangers attendant on the use of X-Rays and Radium

In the routine treatment of disease by radiations, even when the greatest care is exercised as to dosage and frequency of application, it is inevitable that cases should occur in which in spite of all precautions serious damage is done. It is therefore necessary to consider briefly the ill-effects which may accompany the use of radiations. These are :

- (1) Acute Dermatitis.
- (2) Chronic Dermatitis.
- (3) Late Manifestations, appearing a long time after cessation of treatment.
- (4) Sterility.

Acute Dermatitis.—A properly judged dose of X-rays or radium, when applied to the skin surface after a given time, produces a definite erythema, which causes a slight reddening of the surface. This lasts a few days and then slowly subsides. When such a dose has been applied to a surface covered with hair, complete epilation follows ; the follicles, however, are not destroyed, and the hair reappears later. Should the reaction be excessive, and the skin surface ulcerate, more or less permanent alopecia may result. All degrees of reaction, from a slight erythema to deep ulceration, may follow a single exposure to either X-rays or radium. Acute dermatitis is frequently met with in the treatment of malignant disease where the dosage has been energetically pushed. This may lead to large superficial ulcers, which are extremely painful and very difficult to heal. Deep sloughs may form and separate, leaving large ulcers.

Chronic Dermatitis.—The acute dermatitis may only partially subside, and give rise to a subacute or chronic condition which may be very intractable, persist for years, and finally take on a malignant character. This form is commonly met with among X-ray operators who were injured in the early days of X-ray work. The degree of damage caused to the tissues may be reckoned by the period of incubation, *i.e.* the time between the exposure and the first appearance of redness. Irritation is more marked in the subacute and chronic forms than in the acute, desquamation being more marked in the acute. X-ray warts are a late manifestation of chronic dermatitis, and may become malignant.

Late Manifestations.—A frequent sequel to X-ray and radium treatment is the occurrence of telangiectasis many months after the cessation of treatment. The length of time which may elapse between the cessation of treatment and the appearance of telangiectasis is much greater than was formerly supposed. A case was seen recently occurring in the hands where the treatment with filtered rays had been carried out for hyperidrosis. Three years afterwards the palms of both hands were covered with patches of telangiectasis, with, in addition, a certain degree of pain and irritation. This condition is somewhat unsightly and is difficult to treat; it is more likely to appear when unfiltered rays have been used. Late ulceration is a condition which has been described by several writers as coming on many months, or even a year or two, after the cessation of treatment. It is extremely painful and intractable.

In view of the results to the superficial tissues that have followed over-exposure to radiations, the persistent nature of the lesions so induced, and the intractable pain which is so often a sequel to dermatitis, it is well to consider carefully the late manifestations, which may occur at long intervals after the suspension of active treatment. Without going into the histological changes induced in the normal and in the pathological conditions, or speculating on the metabolic changes which accompany the direct effects upon tissues exposed to radiations, it will be well to briefly mention a few of the later manifestations which have been recorded by a number of observers.

Speder was the first to point out that lesions occurred in patients who had been treated by X-rays, and he has described numerous cases in which he attributed these changes to a late reaction on the part of the tissues. Finzi later, in a paper read before the Röntgen Society, described two cases which showed intractable ulceration occurring after a lengthy interval between the last exposure and the appearance of the reaction. The writer has seen several cases in which reactions have occurred, after a very long period of apparent cure. Of the late changes telangiectasis is the most common and, as quoted above, may occur as long as three years after the cessation of treatment.

These late manifestations are more likely to be met with in the superficial structures since it is these which are most likely to suffer from over-exposure. It is assumed that if no reaction occurs in the superficial structures.

during treatment, or in a short time after suspension of treatment, no untoward result will follow. The deeper structures rarely receive an overdose, because of the difficulty of administering a large dose at any great depth of tissue. Care must always be exercised to avoid over-dosage of the skin, when treating deep-seated lesions. It is conceivable that, in our efforts by means of cross fire to obtain a maximum effect on deep structures, at one point radiations may be so concentrated that the tissues at that spot may receive an overdose.

Cases treated by radiations sometimes show evidence of neuritis. This is especially liable to occur in the treatment of cases of carcinoma of the breast in the axillary and supraclavicular regions, owing to the presence of large nerve trunks in these parts. The condition is often very painful, but generally subsides on the cessation of treatment. When very painful, relief may be obtained by the use of the galvanic current along the course of the nerves. It is quite possible that, where deep-seated organs are subjected to heavy dosage in the intensive treatment by X-rays, organs other than those treated may be seriously damaged. A considerable time must elapse before we can definitely state that this intensive treatment cannot produce effects other than those aimed at. In estimating the value of X-ray treatment in Fibro-myoma uteri, the above possibility must be borne in mind before we can admit the successes claimed for it by enthusiastic advocates. The occurrence of late manifestations on the skin surface after prolonged radiation treatment leads to the inference that deep-seated changes may also occur.

Sterility.—X-ray workers may become sterile. If great care is taken to keep out of the direct line of the radiations, and the tube is properly enclosed in X-ray-proof glass or lead rubber, and the operator takes care to protect the exposed parts of the body, this undesirable result need not follow. It is when a large amount of screen work has to be done that any danger arises. Properly constructed couches and screening stands should be efficiently protected. It is safer to shut in the radiations from the tube and to rely upon the efficiency of the protection, than to pay no attention to these details while the operator garbs himself in a complete suit of lead-lined armour. In the latter case he is quite as likely to be damaged by secondary radiations from the lead in his protective screen. It is a good practice to do the minimum of screening consistent with efficient work, and to use the smallest possible opening in the diaphragm of the tube-box. The fluorescent screen must be efficiently protected by lead-glass and metal handles. When therapeutic work has to be done the operator should always be protected by lead-lined screens. Distance from the active tube is also another safeguard. The maximum distance possible from the tube should be a definite rule for all operators. The protection of the patient must also be rigorously carried out, and no radiation other than that intended for therapeutic effect should be allowed to reach the patient.

A. X-RAY THERAPEUTICS

Special Points in Instrumentation

Before proceeding to a detailed description of the methods of treatment, apparatus, and dosage, there are several factors of a preliminary nature which must be discussed at some length.

The general principle of radio-therapeutics is as yet imperfectly understood. The action of X-rays on tissues has been too well demonstrated by the unfortunate effects upon many of the early workers. An agent so capable of harmful effect must necessarily be treated with a considerable amount of respect when used for therapeutic purposes.

There is still a large field for experimental work in the perfection of apparatus, the standardisation of tubes and dosage and therapeutic technique. The early work was chiefly confined to superficial areas of the body, and it was the observation of the effect upon these structures and diseases which encouraged workers to develop and elaborate the technique of the present day. Great improvements in superficial lesions of the skin through the use of X-rays led to the employment of the rays in the treatment of deep-seated diseases. The employment of filters for the protection of the superficial structures from the action of the soft X-rays enabled the experimenters to evolve a technique for the treatment of such diseases as uterine myomata and cancer. The action of the Gamma-ray of radium upon cancer led X-ray therapists to use harder tubes and increased filtration with longer exposures. More accurate measures for estimation of dosage increased the value of these experiments, while the improvement in apparatus, particularly in the focus tube, ensured the administration of larger doses of more penetrating rays.

Methods of Protection

The first care of all workers should be to ensure the complete protection of the operator and attendants in an X-ray department, and there can be no doubt that at present too little attention is paid in most clinics in this country to the important question of X-ray protection.

It is not sufficient to enclose the X-ray tube in a lead-glass shield, closed only on one-half of its diameter. X-rays escape from behind the tube, and in addition there are the rays of which we yet know little, which may have an injurious effect upon the workers. The Coolidge tube is particularly

liable to give off rays all round the tube. Also, high-tension currents are allowed to escape through the room, and there is at present no accurate knowledge of the ill-effects which may be produced by frequent and prolonged exposure to their influence.

Complete protection can be obtained by enclosing the X-ray tube, together with the patient and the auxiliary apparatus, within a lead-lined cubicle. Lead of the thickness of 1 mm. or more should be let in between the layers of wood, the wood covering serving to absorb secondary radiations given off from the lead when struck by X-rays. The upper portion of the cubicle may have lead-glass windows in order that the operator may observe the action of the tube and the patient during the treatment. These cubicles should have an efficient system of ventilation. Indeed, too great stress cannot be laid upon this point. All X-ray rooms, cubicles, and dark rooms should be efficiently ventilated, and in hospitals they should also be easy to disinfect. The control apparatus should be on the outside of the cubicle. In some institutions an arrangement is added whereby the current can be automatically cut off when the door of the cubicle is opened.

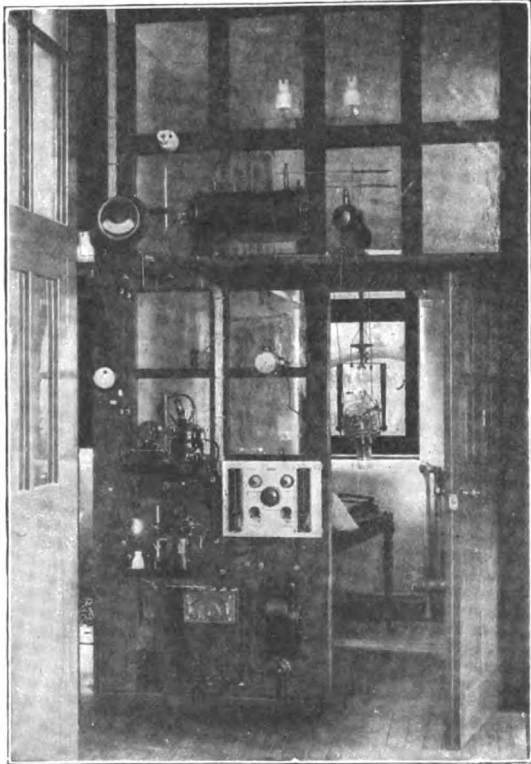

FIG. 323.—X-ray treatment cubicle. (*Archives of Radiology and Electrotherapy.*) Control apparatus arranged outside the cubicle.

When such elaborate precautionary measures are not available, it should be the duty of those responsible for the X-ray department to see that efficient protection is provided by other means.

The X-ray tube should be completely enclosed in a lead-lined box, or a lead-glass shield of sufficient size should be provided, so that no stray X-rays are allowed to fall outside the area it is desired to treat. Gloves should be used whenever the operator comes within the range of the rays. The most convenient manner in which to protect the operator is to have a lead-lined screen at a considerable distance from the X-ray bulb. Behind this screen all the control apparatus may be manipulated. This should have a lead-glass window for purposes of observation on patient and tube.

Protection of the patient must be carefully attended to, especially when administering the heavy doses of more recent days. Thick lead-rubber shields should cover the parts of the body in close proximity to the tube-box. A window is cut in the middle of the lead rubber to allow of the rays passing to the part under treatment. The protection of the patient from all radiations other than those intended to reach the part undergoing treatment can be attained by metal diaphragms upon the under-aspect of the tube-box. This may be of the rectangular or iris type. When the metal is thick enough to cut off practically all the radiations from the tube, it may be used to protect the skin around the part treated. Patients object to the excessive weight of the lead shields placed upon them, and these are not necessary when a properly constructed diaphragm is fitted to the tube-box. The efficiency of the protective measures employed may be tested by means of an electroscope. This, when placed in the vicinity of an active X-ray tube, quickly becomes discharged, thus enabling the ionisation effect to be estimated. All protective devices should be tested in this manner before it is assumed that they are efficient.

Arrangement of Apparatus

In the early days it was sufficient to have a coil, control apparatus, and a tube, the dose being calculated in minutes, in many instances quite irrespective of the condition of the tube. Even with this crude technique results were obtained which served to call attention to the great potentiality behind the new remedy. Increasing complexity of apparatus accompanied each succeeding development, so that the equipment for an X-ray therapeutic department has now become exceedingly complicated.

The control of the X-ray tube is a matter of ease when precautions are taken and sufficient auxiliary apparatus is provided.

A Switchboard on the wall or on a trolley table is essential. It should have an ammeter to measure the primary current, a resistance to control the current in the primary, a resistance for the control of the break, and switches to control these parts.

Valve Tubes should be provided wherever there is a suspicion of reverse current. It is a good plan to have valve tubes and oscilloscope tubes arranged so that they may be cut off from the current when not required. By means of a simple arrangement of cords and pulleys they may be introduced occasionally to see if there is any reverse current present. This is all that is necessary when small currents are used.

A milliamperemeter measuring approximately the quantity of current passing through the tube is an essential if reliable work is to be expected. It should be of the very best **D'Arsonval moving-coil dead-beat precision type**, which is provided with two readings, viz., 0-5 and 0-50 m.a. On the lower reading each one-fifth part of a milliampere is clearly registered, while on the higher reading each division of the scale represents two milliamperes. In all ordinary work only one or two milliamperes are utilised

through the focus tube, so that the lower reading serves admirably, while for very heavy discharges the higher reading is called into use. The milliamperemeter enables the operator to estimate approximately the hardness of the tube, as the variations may be detected by the fluctuations of the recording needle. As the tube hardens the amount of current passing through diminishes and *vice versa*. In treatment it may be used as a guide to the length of the exposure if care has been taken to note the condition of the tube in regard to hardness and quantity of current when a particular dose is being given.

The **Qualimeter** is a useful adjunct to a treatment outfit, enabling one at a glance to estimate approximately the degree of hardness of the tube.

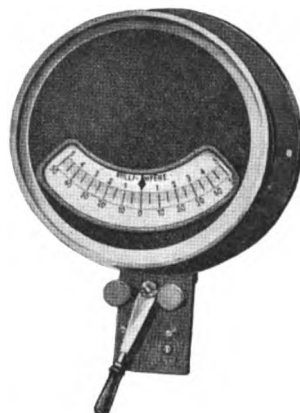

FIG. 324.—Milliamperemeter.
(Siemens.)



FIG. 325.—Bauer Qualimeter.

Bauer's Qualimeter.—The instrument is suspended from the wall of the protective house or protective screen, and indicates the hardness of the focus tube on a scale. It does not depend, as in other scales, on the comparison of different tints.

This instrument is connected by a wire to the negative terminal of the coil or the cathode of the tube. It is a static electrometer and condenser which indicates automatically the potential of the cathode, and hence the quality or hardness of the X-rays. The apparatus consists of two wings, which swing between two fixed plates. Both wings and plates are equally charged so that a repulsion takes place between them. The intensity of this repulsion is in exact proportion to the electrical tension in the secondary circuit, and is indicated by the deviation of a pointer over a suitably divided scale.

As is well known, the penetration of the X-rays is a function of the electrical potential in the secondary circuit, so that a simple measurement of this potential between the anode and cathode will give us an indication of the hardness of the tube. The scale is gauged according to the absorption of the X-rays by sheets of lead of different thickness, increasing regularly from $\frac{1}{10}$ of a millimetre to 1 millimetre.

No. 1 on the scale denotes X-rays of such a hardness as to be totally absorbed by $\frac{1}{10}$ millimetre of lead. When the index is at No. 10 we know that the tube is giving out rays which will penetrate 0.9 millimetres of lead, but will be totally absorbed by 1 millimetre of lead.

As already explained, the instrument is unipolar, being joined up by a single wire to some point in electrical connection with the cathode. The instrument is contained in an ebonite case, which swings freely from a bracket on the wall or a

stand, so as to be always in a vertical position. It should be within view of the operator, to enable him to estimate the hardness of his tube throughout the whole of the exposure, without danger to himself.

COMPARATIVE SCALE OF THE USUAL INSTRUMENTS FOR MEASURING THE HARDNESS OF TUBES

	soft			medium				hard			
Bauer	1	2	3	4	5	6	7	8	9	10	
Wehnelt	1.5	3	4.5	6	7.5	9	10.5	12	13.5	15	
Walter	1	1.2	2.3	3.4	4.5	5.6	6.7	7.8			
Benoist	1	2	3	4	5	6	7	8	9	10	

It is well to have all these instruments—valve tubes, milliamperemeter, and oscilloscope tube—in the circuit, especially when a great deal of work has to be done, as they facilitate speed in working, and enable the operator to see that the conditions under which his work is being carried out are correct. A qualimeter should also be connected.

The Therapeutic Coil should be at least twelve inches spark-gap, and

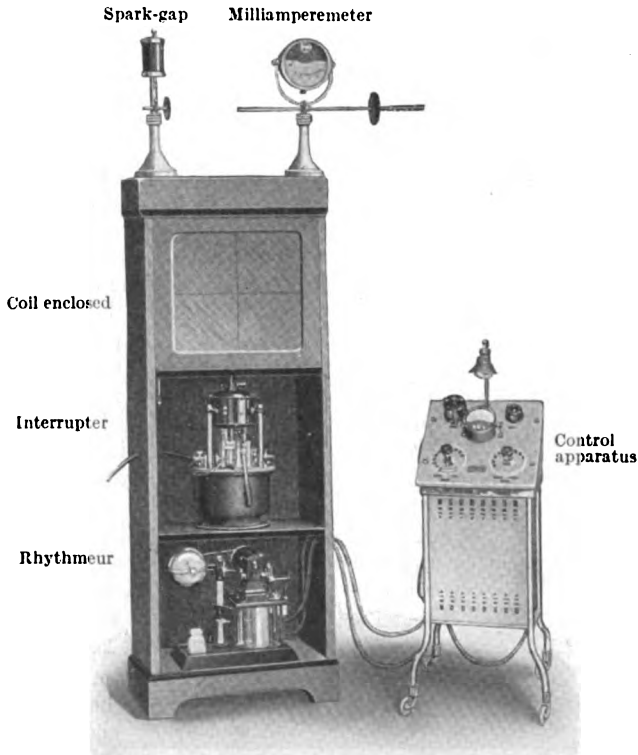

FIG. 326.—Therapeutic outfit suitable for deep therapy. (Schall.)

The interrupter is arranged for the passage of heavy currents. At the top of the motor a small fan is arranged to drive a current of air through the primary of the coil for cooling purposes. A rhythmeur is arranged below the mercury interrupter.

where more than one is possible a 16-inch coil should be installed. Any modern coil is adequate, but the type likely to give the best results is one of the so-called intensive coils; that is, one giving a high secondary output with a moderate primary current. When possible, the coil should be mounted well away from the control apparatus, and the terminals connecting the high-tension cables should be separated as widely as possible, in order to prevent a leak to earth or sparking between the terminals. With the larger coil it should be possible to pass heavy discharges through the hardest X-ray tube. The Coolidge tube requires, when very hard rays are used, a heavy discharge from the secondary. This may be obtained from the larger coils now in use. When these very hard tubes are used the high-tension transformer, such as the Snook machine, will be found extremely useful. The control of the tubes when using the unidirectional current obtained from this type of transformer is a matter of comparative ease.

The high-tension transformer is displacing the induction coil in many places, particularly in America, the reason for this being that when it is used valve tubes are unnecessary, and the current output is consistently uniform, particularly when used in combination with the Coolidge tube. Experimental work carried out with a transformer and a coil outfit, at least in the experience of the writer, points to a slightly greater efficiency of the coil for therapeutic work, even when a Coolidge tube is used. Transformers for deep therapeutic work should be constructed to give a long spark length with a minimum of primary and secondary current. It will then be possible to minimise the risk of overheating the tube, which results from a large secondary current, when long treatments are necessary.

The Interrupter.—A condenser is necessary when the interrupter is of the mercury-jet type, as is also a condenser battery when the apparatus is used for many hours daily. The battery should be arranged so that it is convenient to quickly change from one set of condensers to another.

The *mercury jet interrupter* has already been described in Vol. I. (p. 24), and little more need be added here. The best di-electric to employ is coal gas. The supply of gas

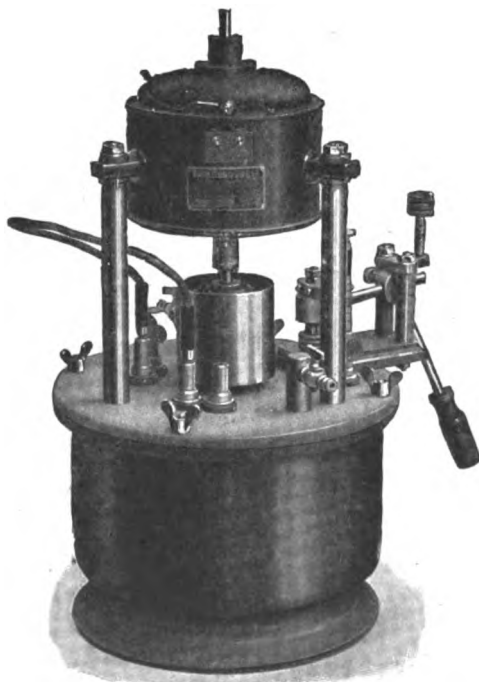

FIG. 327.—Mercury interrupter with gas di-electric.
(Schall.)

should be obtained direct from the main, in order to ensure a sufficient pressure. A rubber tube connects the tap from the main with the inlet tap of the interrupter. Before turning on the main switch to the apparatus, the gas should be allowed to flow freely through the interrupter. It is a good practice to apply a light to the outlet tap, and allow the gas to burn for a few minutes in order to expel all air from the interior. The flame burns bluish at first, and shows some intermission until all the air has been expelled. Then the flame steadies itself and assumes a yellowish colour. It is important to see that the interior of the interrupter is kept clean, and when a considerable amount of work has to be done it is well to thoroughly inspect the break at least twice a week and clean out the jets.

Some makers claim for their interrupter that cleaning is only necessary once in six months, but this is quite a mistake. Careful cleaning at short intervals facilitates harmonious working of apparatus.

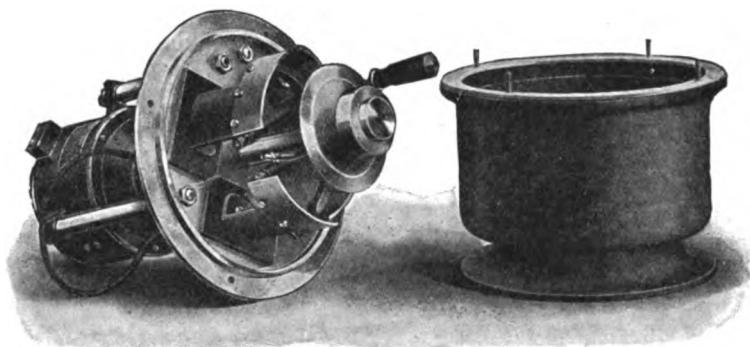

FIG. 328.—Mercury interrupter, showing details.

Other forms of interrupters may be used, of these the best being the *electrolytic*. This break, if properly adjusted, will be found useful. It is the easiest of all interrupters to work with, requires very little cleaning, and hardly any attention beyond an occasional adjustment; it has the further advantage that the variations are greater. With an adjustable primary and two or more points in the interrupter, it gives a wide range of usefulness. When using very hard tubes it is necessary to get a relatively large current in the primary. This it is possible to obtain by using a thick platinum point.

Dipping Interrupter with Counter, for Regulating Therapeutic Doses.—The interrupter illustrated on p. 413 is designed chiefly for the treatment of ringworm, but may be used for other therapeutic purposes; it is arranged to give a dose measured by a definite number of interruptions in the primary circuit. For this purpose a dipper mercury interrupter is employed, the turbine forms not being sufficiently definite, it being difficult to accurately register every interruption on the counter. The axle of the motor is directly connected with the counter, which is provided with an indicator and dial. The indicator is set to the number of interruptions

the exposure is to consist of, and the current to the interrupter switched on. When the indicator reaches zero the exposure is automatically terminated by the current being cut off by a relay switch. There is a timepiece in the circuit, and the exposures can be calculated by time, allowing for so many interruptions per minute.

The important thing in the management of all interrupters is to obtain the maximum of current through a tube at a particular spark-gap with the

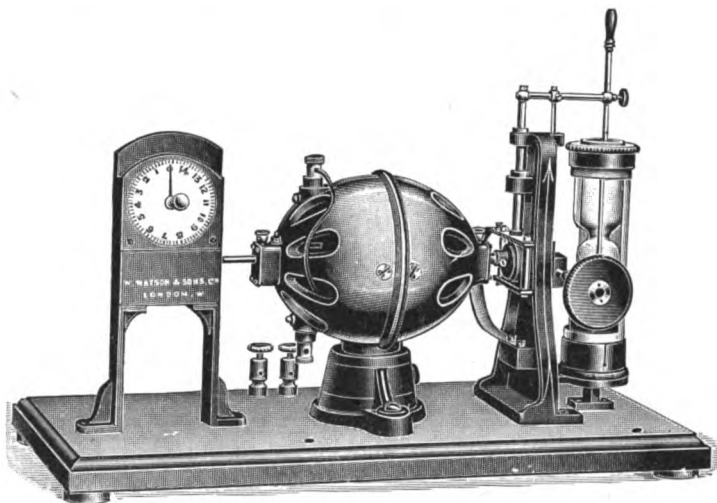

FIG. 329.—Dipping interrupter, with revolution counter, or tachymeter.

minimum of primary current. A little practice will soon enable the worker to adjust the points and primary to suit the particular tube in use.

Valve Tubes.—The employment of an electrolytic interrupter involves the use of valve tubes to cut out the inverse current, which is always present with this interrupter. The valve tube is also necessary when using a mercury interrupter. Dr. Reginald Morton has called attention to an ingenious method of checking inverse current, described below.

The Morton Rectifier.—This apparatus enables the operator to dispense with valve tubes. It may be used with currents up to 10 milliamperes. It should prove to be extremely useful in therapeutic work.

The aim of the apparatus is to provide a satisfactory means of eliminating inverse current without the use of valve tubes. The essential feature of the apparatus is a switch, which is mounted upon the shaft of the interrupter. It is in this connection similar to the mica disc valve designed by Mr. Leslie Miller, but in the Morton apparatus a rotary conductor is made use of on the same principle as the rectifier on a Snook machine. The amount of current which can be passed through the high-tension switch is practically unlimited, the only factor at present limiting the output being the amount of energy which can be dealt with efficiently by a mercury break. The arrangement of the high-tension switch in relation to the mercury break is shown in Fig. 331, the respective parts by similar letters

on the three figures. P P are the contacts through which the primary current passes to the coil when they are connected together by the revolving mercury jet. S S are the high-tension contacts connected in series with the X-ray tube circuit, the conductor C being so set, in relation to the interrupter, that the whole of the high-tension current passes through it. The latter is produced by the break of the primary current. When the primary current is made, a long air-gap is interposed in the secondary circuit, which prevents

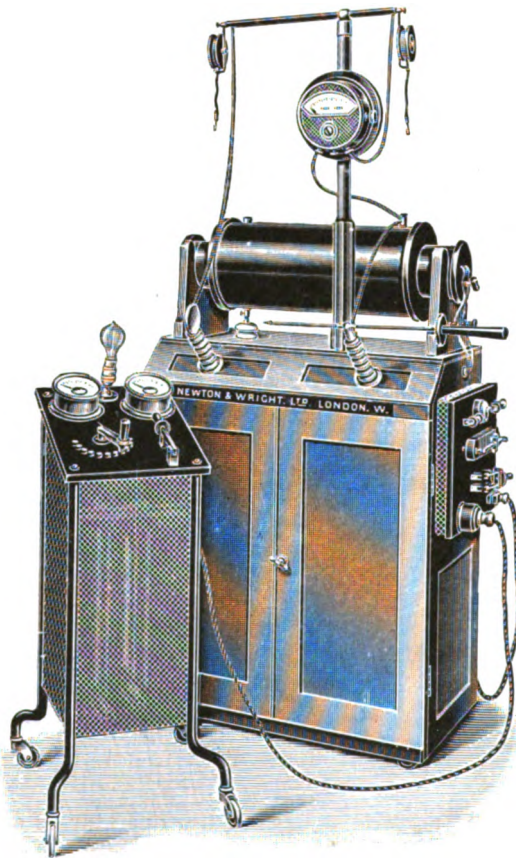

FIG. 330.—Morton rectifier fitted to a coil outfit, with control table.

the passage of the inverse discharge. The apparatus can be arranged to give quick or slow interruptions, the latter being particularly efficacious when used in therapeutic work, adjustments being provided to facilitate the use of either type of interruption. This arrangement appears to render the apparatus particularly applicable to therapeutic work of the intensive form, and the absence of all inverse current makes it possible to work without valve tubes. If this is borne out in practice the Morton apparatus should prove itself to be of the greatest possible value to the radio-therapist. With most mercury breaks this inverse current is present; so if a rectifying device is not used it is well, whichever type of break is employed, to have two or more valve

tubes attached to the apparatus. An osmosis regulator attached to the valve tube, with a gas jet which can be regulated from a distance, is very useful.

A triple valve tube will be sufficient to check a moderate amount of inverse current. This should have a regulating device attached to it. A good one, which is now being attached to a great many X-ray bulbs and valve tubes, is that introduced by Bauer (see Fig. 62, page 78, Vol. I.). These tubes are capable of regulation from a distance, a length of rubber tubing being attached to the air valve, while at the other end is a small hand-pump. By compressing the latter, a small quantity of air is allowed to pass into the interior of the tube. This increases the pressure of gas within the tube and

lowers the vacuum. This is a good method for the regulation of X-ray and valve tubes, but requires careful manipulation to ensure efficient working.

A result of considerable experience in the use of this regulator is the conviction that it is probably the best in use. It however requires great care in its manipulation. Too great a use of the regulator in the early days of the valve tube may hopelessly ruin the vacuum. The chief point to remember in the regulation of the valve tube is not to be too ready to pump air into it. The tube should be allowed to balance itself by varying the primary current. By careful use of the Bauer valve the tube is aided in the establishment of a balance. One triple valve tube which was treated in this way has been in daily use

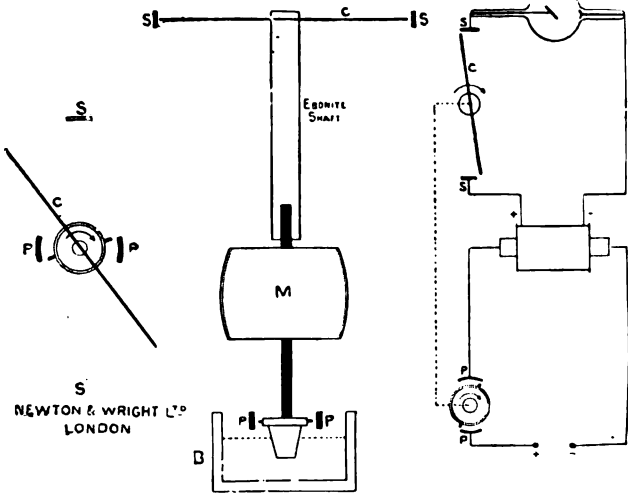

FIG. 331.—Diagram of connections for Morton rectifier.

for over three years. It rarely requires regulating now. The primary current used for this period of time has been fairly constant, never exceeding 6-8 amperes.

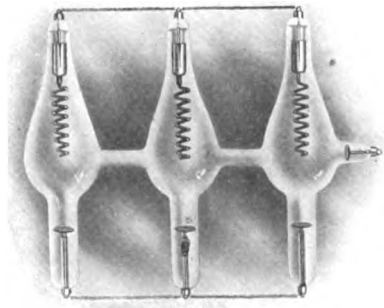

FIG. 332.—Triple valve tube. (C. Andrews.)

The construction of a valve tube and the method of arranging one or more in the circuit has been described in the section on radiography. What has been said there applies equally to the therapeutic outfit. With this as with all forms of regulators it is important that it should not be used too frequently or too vigorously. The vacuum is easily disturbed and the valve tube then becomes too variable for easy control.

The disturbing influence, resulting from the passage at one time of large currents and at another of small currents, upon the stability of a valve tube is not so much felt in therapeutics as in radiographic work. In the former the discharge is consistently moderate. The valve tubes therefore tend to acquire an equilibrium which is in favour of steady continuous output of current in the right direction.

The most convenient mercury interrupter is probably a mercury jet interrupter. There are several which are all equally good. It should be possible to control the speed; a resistance should, therefore, be added for the control of the motor. Another resistance is necessary to regulate the amount of current passing through the primary.

Figs. 338 and 339 represent convenient arrangements of apparatus for therapeutic work. The coil, spintermeter, valve tube, and milliamperemeter are placed on the top of an upright cabinet. The leads from the secondary may be carried to a pair of insulated high-tension steel cables, from which the current is carried by means of spring cables to the terminals of the tube.

On a suitable switchboard, the regulating devices are conveniently arranged. A mercury jet break is mounted on the base of the cabinet, while above it, if desired, a dipper break with an automatic tachymeter may be added to the outfit, this latter instrument being useful when it is necessary to record accurately the number of interruptions in a given exposure. It cannot, however, be relied on as an absolute measure of the dose; other methods must always be used as well, in order to get a check observation.

The Rhythmeur Interrupter.—This is a useful addition to the therapeutic outfit; it is very valuable for the deep treatment of tumours, when heavy currents require to be passed through hard tubes of the ordinary type. It is a mechanical device by means of which the current is automatically cut off for a fixed period of time, varying from one to four or more seconds. This allows the tube time to cool between the periods of activity.

On the Use of Valve Tubes.—This has been fully entered into in the radiographic section, but a brief reminder of the methods of connecting up the valve tubes will be useful here. Figs. 333 and 334 illustrate two methods of connecting the tubes. Sometimes, when a considerable amount of reverse current is present it may be necessary to put two or more valve tubes in a circuit. They can then be arranged on both negative and positive poles.

The tube used in X-ray therapy should be under the complete control of the operator. Any type of tube may be used, but it is important to have such control of it that the type of ray best suited to a particular case may be produced. It is not sufficient simply to turn on a switch with any tube and give a few minutes' exposure to the rays. That method sufficed in the days when little was known of the technique of X-ray treatment, but now we must be able so to manipulate the apparatus that results may be obtained with a degree of certainty.

The elaboration of the installation has been a gradual process, brought about by the requirements of individual workers as experience has widened; in consequence, at the present time we are still far removed from a standardisation of apparatus, tubes, and dosage. Before uniform results can be turned out this standardisation must become an established fact. It has been the aim of the writer to reduce, so far as is possible, all the installations under his care to a uniform standard.

The Therapeutic Tube Stand.—Any simple stand will suffice for therapeutic work, but it must have good mechanical movements. One of the best is made by Gaiffé of Paris. The tube may be adjusted readily to any angle, and the movements are as perfect as mechanical ingenuity can make them. The only drawback to the stand is that only half of the tube is is

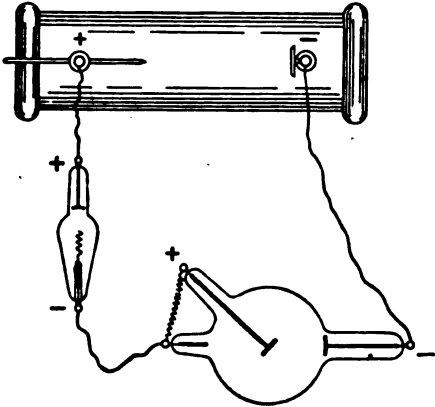

FIG. 333.—Method of connecting coil to valve tube and X-ray tube. Valve tube on positive pole. (Siemens.)

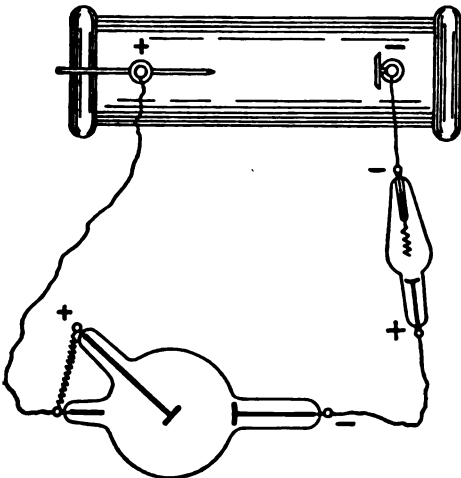

FIG. 334.—Method of connecting coil to tube. Valve tube on negative pole.

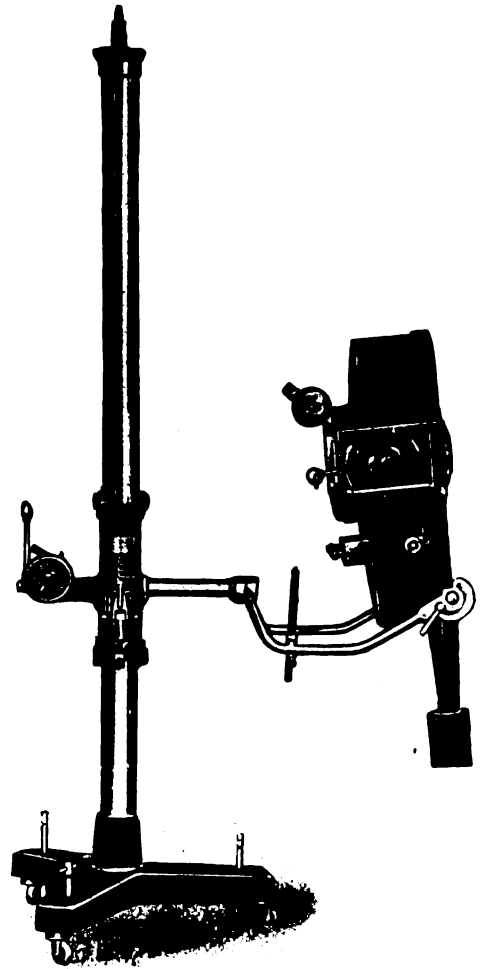

FIG. 335.—Tube stand for deep therapeutic work. (Schall.)

enclosed, and the lead glass is frequently not thick enough to ensure complete protection. The stand should have a number of extension tubes of various sizes, and should have also a tripod arranged on a circular diaphragm, which is fixed on the outlet of the tube box, for ringworm treatment. The under aspect of the tube box should have a slot into which the filters can easily be placed, and a complete set of filters should go with each stand. The aluminium filters should range from $\frac{1}{2}$ up to 3 mm. or more in thickness.

In hospitals, especially, these parts should be easily sterilisable. The tube stand should also have a holder for the pastille. The pastille should be placed on the distal side of the filters. In actual practice the pastille or photographic test slip may be placed on the skin beneath the secondary filter.

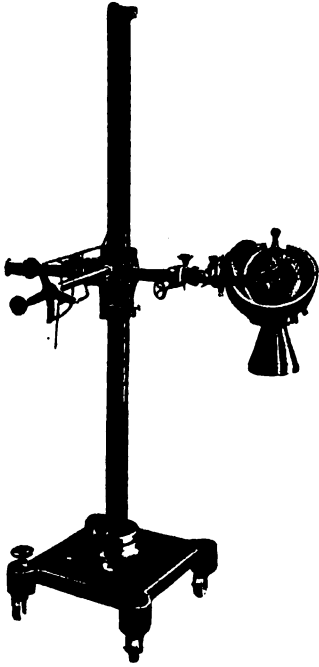

FIG. 336.—Pillar tube stand suitable for therapeutic work. (A. Gaiffé.)

Dr. Gauss of Freiburg has introduced a stand (Fig. 335) designed for tubes which are to be used with a very heavy current. It is so arranged that the distance of the tube from the surface of the body can readily be regulated and measured. In addition to this it has a number of good mechanical movements, which render its use a great acquisition to the operator. The tube box is protected by thick lead glass and lead rubber. This is necessary on account of the very hard tubes required for the treatment of diseases of deep-seated organs.

The Rotating Tube Stand.—

The modern X-ray generators have placed in our hands apparatus capable of stimulating the most modern tube, and the fine adjustment of the latter enables us to vary the hardness and penetration of the ray. These improvements in apparatus are of great value, but if we are to utilise them to the full we must have more accurate accessory apparatus in the shape of tube stands. The more modern tube stands are constructed on sound principles, but their sphere of usefulness is nevertheless limited—in superficial therapy they are of great use, but when we attempt deep therapy we are greatly handicapped. The various attempts made to overcome this difficulty have been real steps in advance—the elaboration of the technique for the treatment of fibroids is a striking instance—in most of these cases the tube box is fixed but is capable of several adjustments to meet the needs of particular cases. The moving tube has been attempted on several occasions and complicated apparatus devised to attain this object. From suggestions and observations on this form of apparatus, the writer, in collaboration with Mr. C. E. S. Phillips and Mr. St. George Caulfield, was led to apply the principle of the moving tube to the treatment of deep-seated diseases. The aim of the radiologist has been to direct the X-rays into the interior of the body and to produce a maximum effect below the surface, while the skin area over the tumour receives the minimum dose. The most complicated technique is that produced at Freiburg, where the skin surface is divided into a number of areas, each area receiving a definite

dose, the aim being to produce a maximum effect upon deep-lying structures.

The employment of X-rays for the localisation of foreign bodies directed our thoughts to the practicability of employing the central ray of the focus tube in therapeutics, the object being to direct the ray to a definite spot in the interior of the body. The principles employed in localisation are quite applicable to the perfection of a technique for therapy, and rules found to be of value in the former are equally applicable to the latter.

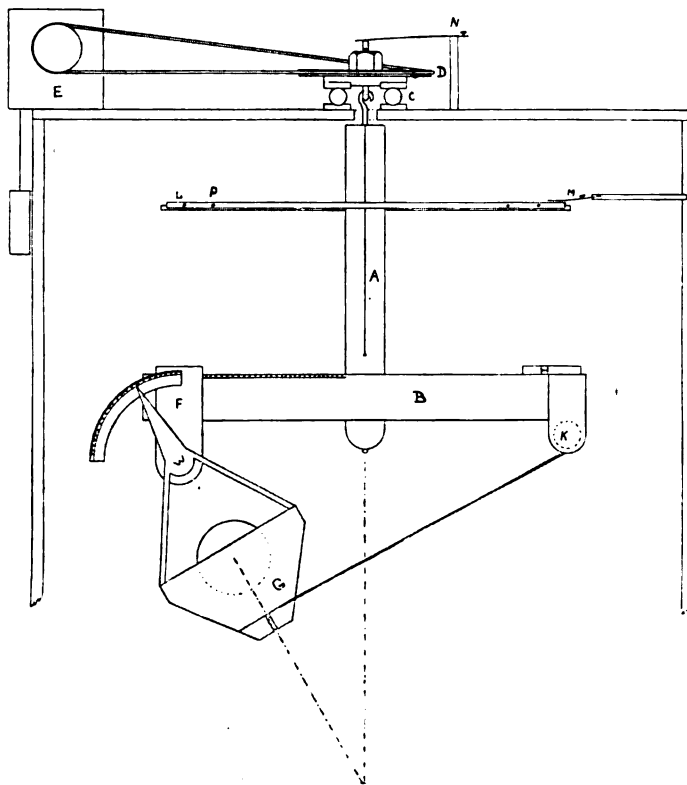

FIG. 337.—Rotating tube stand.

The central ray is ascertained, the tube fixed to the stand, and by mechanical adjustments the rays may be projected into the interior of the body with an accuracy which is as surprising as its projection is simple. Moreover, the rays can be centred at any point and at any depth from the surface.

The principle employed is that of the rotating tube, making a circle upon the surface and focusing the sheaf of rays upon a point in the interior whose depth is determined by the angle at which the tube box is fixed.

The machine consists of a vertical bar, with a bar (B) bolted horizontally across its lower end, forming an inverted \perp . This \perp is slung by a hook from the ball bearing (C), through which passes the shank of the eye into which

the hook fits. The shank carries the pulley D, which is rotated by a belt from the clock E.

A carrier (F) slides along one end of the arm B. This carries the tube box (G) slung from the axis W. A weight (H) slides along the other end of the arm B in order to balance the weight of the tube box at any angle or distance from the centre (A). A winch (K) raises or lowers the tube box.

The carrier has a scale of degrees showing the angle to which G is tilted. The bar (B) is scaled to show the distance the axis W is from the centre A.

An insulated brass circle (L) is carried on the bar A, and serves to collect the high-tension current from the spring (M), which is attached to the frame of the apparatus. When using a Coolidge tube another brass circle is fitted at P.

L is connected to one end of the tube. The other high-tension terminal is at N, a spring which makes contact with the shank of the main eye bolt which is connected electrically to the other end of the tube.

An apparatus for finding the direction of the ray is provided, with equivalent scales, to enable the main apparatus to be set to any required angle.

The above description fully explains the mechanical features of the apparatus. These are capable of several improvements, which will be added as experience in its use teaches their necessity. The advantages claimed for this therapeutic localiser are: (1) Accuracy of application. (2) The possibility of repeating at subsequent exposures the dose primarily given. (3) The radiations can be varied in depth and latitude in order to influence all portions of a growth. If desired, the focus point can be fixed in front of, or behind, or at the centre of the growth. (4) By changing the size of the circle two or more doses can be directed to the centre of the growth. A centrally situated growth can be approached from all aspects of the body, and the maximum dose administered on a point selected beforehand. Thus, a tumour of the mediastinum may be treated from four aspects with accuracy, at any depth from the skin surface.

By changing the focus point the whole area of the tumour can be irradiated to the necessary extent, the surrounding tissues receiving also an estimated dose.

By this method it is also approximately possible to estimate the dosage received by the tumour. The dose on the skin is estimated in the usual way, by pastille or paper, and the total dose received by the tumour is calculated by allowing for the absorption of the rays by the tissues and the absorption by distance.

The objects aimed at by the established technique, namely, protection of the skin area with the maximum irradiation of the deep parts, are obtained by the use of this apparatus with none of the attendant disadvantages. It is unnecessary to protect the surrounding skin with heavy lead rubber, consequently fatigue of the patient is obviated. The accuracy of the localisation will render it possible to obtain therapeutic results with much smaller doses.

The tube box can be adjusted to irradiate a large area of skin surface by changing the angle; and by using a larger diaphragm the advantages of an ordinary tube box are easily obtained. While using the apparatus for deep therapy the ordinary filters are inserted between the tube and the skin surface, while the secondary filters are applied to the skin surface.

The new apparatus will find its largest field of usefulness in the treatment of deep-seated diseases: fibromyomata uteri, deep-seated cancers of the



FIG. 338.—A convenient arrangement of apparatus for therapeutic work.

breast, cancer of the uterus, mediastinum, and other new growths, and also for the irradiation of the spleen and long bones in diseases of the blood.

This instrument is still in the experimental stage, but when it is completed, and all details carefully worked out and proved, there is no doubt that it will be found extremely useful for deep therapeutic work.

Signor Baese has introduced an apparatus, designed primarily for localisation of foreign bodies, which should be extremely useful in therapeutics; with some modifications it could readily become an ideal therapeutic localiser. The chief advantage it offers is that with the assistance of

the fluorescent screen it is possible to accurately project the rays to the desired area, and several doses can be administered from different angles.

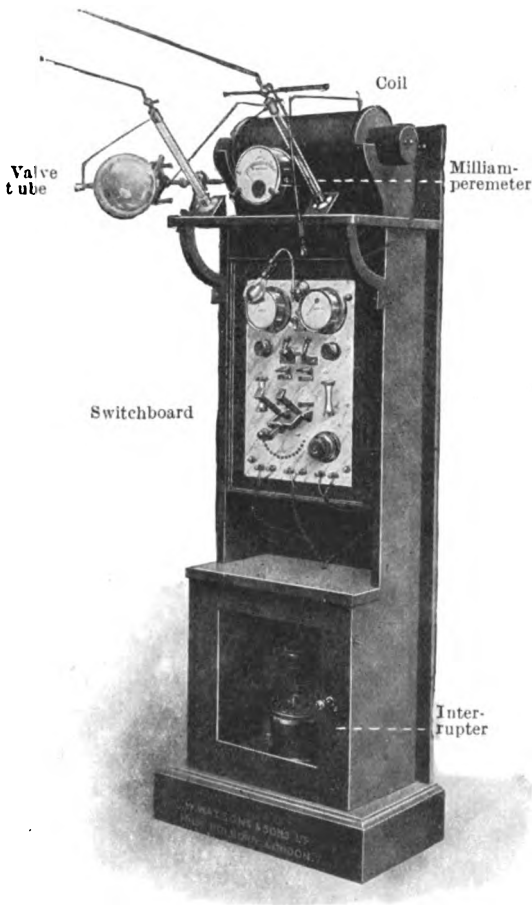

FIG. 339.—Apparatus arranged on an upright cabinet.
(Watson & Sons.)

side-clips for fixing the head. It will be found most useful where children are being treated, as the head may be fixed without discomfort to the patient.

Further Hints on the Arrangement of Apparatus.—It will be found to be a convenience to have all the parts of the apparatus which are likely to get out of order in an accessible position in the room; and all parts subject to variations should be readily controlled. It should be possible to darken the room if desired. This is not essential for therapeutic work, though it is a distinct advantage to be able to darken the room so as to observe how the tube is running.

Patients who are undergoing treatment extending over several hours frequently complain of the immediate effects produced by the inhalation of

A treatment couch should move easily, and the top should be covered with leather or some sterilisable material. A hinged top on the couch is an advantage. When the treatment takes several hours to complete, it is essential that a comfortable couch be provided. Patients complain of the inconvenience caused by the hard couches in use. A couch with good springs and upholstered in some warm material has been found to be extremely useful. A plentiful supply of cushions will also be found to add greatly to the comfort of the patient. These are small matters of detail which have a bearing on the ultimate effect of treatment. The patient who is made comfortable soon learns to forget the initial dread of the new treatment. **A treatment chair** is a valuable addition to the therapeutic department, and should have a movable head-rest, with

ionised air, *e.g.* headache, giddiness, and in some cases nausea. These are described as immediate in contradistinction to the well-known after-effects produced by intensive treatment. To obviate as far as possible these unpleasant effects, the room should be well ventilated; a large fan operating in the vicinity of the tube will serve to change the air rapidly and carry off a percentage of the ionised air. It may be well in some cases to "freshen" the air of the room by a supply of oxygen when the patient complains of faintness.

The leads from the terminals of the coil may be connected to the tube by means of insulated spring cables. It is convenient to have two steel wires carried across the room at a convenient height. These should be insulated at the points of insertion into the walls. Two spring cables on trolley wheels carry the current to the X-ray tube. The leads from the terminals of the coil are connected to the overhead wires. This arrangement facilitates the adjustments of the tube stand and allows of a rapid change from one apparatus to another. Most of the newer tube stands are provided with an efficiently protected tube box. The tube is placed in the tube box or holder, and connected up to the coil and valve tubes. The anode of the coil is connected to the anode of the tube, and cathode to cathode (see Fig. 333). Valve tubes should be provided in all installations when a coil is used, and it will be an advantage to have an oscilloscope tube in the circuit. This should be placed at some distance from the coil if reliable observations are to be made. An oscilloscope in the near vicinity of a large coil often acts inefficiently owing to its proximity to the magnetic field of the coil.

Testing the Apparatus before Use.—The main switch should be turned on with a minimum current at first, and the tube observed as to style of running and colour; then the current may be gradually increased. The penetration of the tube is tested by a radiometer, or by the alternative spark-gap—a rough but very useful indication of the hardness of a tube. The qualimeter of Bauer may also be used for this purpose, and is to be preferred when many observations require to be made. The Coolidge tube does not fluoresce; the only way in which to observe its behaviour is to watch the meter in the heating circuit and the milliamperemeter to estimate the current passing through the tube.

A note of the amperage in the primary should be made and of the current passing through the milliamperemeter. These are most important points on which the calculation of the exposure is based. There are, however, other factors which must be considered in detail.

Methods used in Estimation of Dosage

At the very outset we are met with the difficulty of estimating even approximately the dosage. Many methods are employed, none of them perfect. Tubes vary from day to day in spite of the great improvements which have taken place in recent years. The various systems of measuring

the X-ray dosage will be described in detail. At present there is no standardisation of dosage, and until this is obtained, it is best for an operator to understand thoroughly one good method and to work steadily with it. A knowledge of the others is useful, but it is hopeless to try to combine several different methods.

An erythema dose is one which causes slight erythema to appear within fifteen to twenty-one days. Four-fifths of an erythema dose will, in the majority of cases, cause the hair to fall out. This dose has been found to cause a change in the colour of certain chemical substances.

Two methods may be described: (1) The indirect, and (2) the direct. These two should always be used together, the indirect being a good check on the direct.

In the **Indirect Method** the milliamperemeter is used to measure, not the rays, but the quantity of current passing through the tube; and the number of milliamperes multiplied by the volts used gives the quantity of X-rays generated in the tube.

The quantity of X-rays received by the object depends on (a) the quantity of X-rays generated; (b) the distance between the tube and the object; (c) the time of the exposure; (d) the absorption equivalent of the tissues; (e) the thickness of the filter.

The reading of the milliamperemeter must therefore be supplemented by those other factors before we can estimate the dose received.

The distance has a great influence, because the intensity of the X-rays diminishes, like that of ordinary light, as the square of the distance increases. A strip exposed 40 cms. from the anti-cathode requires four times as many milliamperere seconds to assume tint $5 \times$ as a strip exposed at a distance of 20 cm.

Reverse Current.—The presence of reverse current may cause an under-exposure, because milliamperemeters of the d'Arsonval type do not indicate alternating currents if both phases are of equal strength.

If one phase preponderates, as will be the case if the reverse current from the spark-coil becomes so strong that it can discharge through the tubes, the milliamperemeter indicates only the difference between the breaking and the closing current; the stronger the reverse current the greater will be the error. With good modern coils there should be practically no reverse current with the weak or moderate currents, say up to 6 milliamperes, which are employed in the majority of exposures, but when currents of 10 milliamperes and more are employed, some reverse current begins to appear even with the best of coils.

If the coils are old or badly constructed, or if interrupters with high-frequencies are used, reverse currents may be present even when 1 milliampere only is used. The oscilloscope tubes, which indicate the presence and intensity of reverse currents, are not expensive, and can easily be inserted in the circuit with a milliamperemeter. They should be used if there is any doubt about the presence of reverse current, and if it exists it should

be suppressed by means of a spark-gap, or by means of a valve tube, as otherwise the milliamperemeter method will be misleading.

Another error may arise if the glass of the tube is unusually thick. It is not likely that this will cause much difference, because the glass bulb absorbs the softest ray only. Another error may arise if the penetrating power of the tube changes during the exposure. The milliamperemeter is, however, the best and most convenient indicator of any such change. The Bauer qualimeter also indicates these variations.

The Direct Method.—The total quantity of X-rays received by an object can be measured by various methods introduced by Holzknicht, Sabouraud, Kienböck, Bordier, Hampson, and others. The method most used in this country is that introduced by **Sabouraud and Noiré**. The principle is the same as that of several others, and depends upon the action of X-rays and similar agents upon a disc of barium platino cyanide, the same material that is used for the fluorescent screen. These discs and similar agents are known as chromo-radiometers, because of the change of colour which occurs when they are exposed to the action of rays.

The discs should be exposed on a thin sheet of metal or other supporting medium at a distance from the anti-cathode equal to half the distance between the anti-cathode and the skin of the patient; and they should be protected from the action of daylight. The change of colour takes place gradually under the action of X-rays, the green colour changing to a brown. The discs discolour in the same way whether exposed to an X-ray tube, an incandescent electric lamp, or to sunshine, or when heated in a flame from a spirit lamp.

When the pastilles are exposed to the X-rays, the apple-green colour changes gradually to red and red-brown, and by experiment the exact tint was found which the pastilles assumed after exposure to a dose which caused the hair to fall out. This is called tint B, and a tablet showing this colour is supplied with every booklet of Sabouraud pastilles. The tint B supplied with the booklet is only reliable when used with the pastilles standardised to it. It should never be used for comparison with pastilles which have not been standardised to it. If an exposure of eight minutes caused the pastille to assume tint B, another two minutes' exposure should be sufficient to cause an erythema to appear after an interval. Where the dose is judged by the pastille alone the tint B in the booklet should always be used for pastilles used from the particular booklet. This is not necessary when Hampson's or Lovibond's radiometers are used.

These pastilles are not very sensitive, and to obtain a sufficiently great change in colour they have to be exposed at half the distance existing between the anti-cathode and the object, so that they receive four times the quantity of X-rays which the object receives. Nevertheless, quite large errors are often made by different observers in comparing these small shades of colour. The pastilles are sensitive to heat, so there should be a distance of at least 2 cm. between the surface of the tube and the pastille, or the

heat from the glass may prematurely discolour the pastille. Daylight restores the colour to the pastilles. They must, therefore, be protected from bright light during the exposure, and should be compared with the standard tint in a light weak in actinic rays, *e.g.* the light of an incandescent lamp.

Great care must be exercised in estimating the degree of change in the colour, and it must be noted that a marked difference exists between the shade of colour of the disc when it is examined in daylight and when it is examined in artificial light. A serious error in dosage may easily be made if this difference is overlooked.

These pastilles have proved very useful in the estimation of dosage in the treatment of ringworm and superficial skin lesions, and they are almost universally used in the treatment of this first disease.

When examining Sabouraud pastilles after exposure to the X-rays, a weak daylight is recommended, and for Holz knecht and Bordier pastilles the light of an incandescent lamp. When using these pastilles to measure dosage, a definite system of examination should be carried out in all cases. The time taken to change a pastille from the A to the B tint by the tube in use should be ascertained. Then during an exposure of, say, ten minutes, the pastille should be examined at least three times.

The first examination should be at the end of four minutes. This will show whether the rays from the tube are acting on the pastille. If by any chance the tube is acting too quickly, a full dose may be given in less than half the time usually required, but this early examination makes it possible to avoid serious damage to the patient. Towards the end of the exposure the inspections should be more frequently made. Stress is laid upon this point here because recently in the experience of several workers vagaries of the tube undetected at the time have led to the administration of excessive doses in less than half the time usually taken by the tube to colour the pastille. These untoward results have also been obtained when to all appearances the tube was working properly and the pastille was under- rather than over-done. No system of measuring X-ray dosage is perfect, and whichever one is employed should always be checked by the indirect method. A Bauer qualimeter on the negative pole gives an approximate idea of the hardness of the tube. It is not absolute, but as a guide to the steadiness of the tube it is very valuable. The milliamperemeter records the current in the secondary circuit and approximately the amount of current passing through or around the tube. The alternate spark-gap also gives an indication of the hardness of the tube, and should be tested from time to time. Lastly, there is the tube itself. A careful watch kept upon it should enable the operator to judge of its condition. Experienced workers can tell the variations in hardness by the sound a tube makes when running. Some can tell approximately the exposure by the same means, *i.e.* appearances of the tube, sound, etc., but for an X-ray dosage, strict attention to detail and the careful watching of all the conditions should be insisted upon.

The pastille should be compared with the standard tint immediately

the exposure has been terminated. The colour should indicate that the correct dosage has been given ; if left for comparison till some time after, the pastille may be found to have faded. The same pastille should not be used more frequently than three or four times. Sabouraud pastilles record accurately when used with medium tubes, but with hard tubes there is a tendency to under-exposure, tint B being reached a little too early, and with soft tubes there is a tendency to over-expose, as tint B is reached a little too late.

In the booklet supplied by Sabouraud and Noiré with the pastilles tint A represents the pastille before it is exposed to the X-rays. Tint B represents the same pastille after it has received exposure to the X-rays, corresponding to the maximum dosage which the human skin is able to receive without producing erythema, radiodermatitis, or a permanent alopecia.

Holzkecht's Quantimeter.—For this instrument, barium platino cyanide pastilles are also used, but they are compared with unexposed pastilles of the same material arranged under a celluloid film of red-brown colour, increasing gradually in intensity. By moving the exposed pastille along this film, the discoloration caused by $\frac{1}{2}$, $\frac{3}{4}$, etc., of an erythema dose can be measured.

Dr. Bordier's Chromo-radiometer.—This chromo-radiometer depends, like Sabouraud's, on the discoloration of pastilles of barium platino cyanide, but the scale shows five different tints for comparison, instead of the single one of Sabouraud's instrument. Bordier's pastilles have to be attached to the skin of the patient. The pastilles should be compared with the scale or "Teinte B" by the light of a match, a candle, a benzine lamp, or other artificial light of slight actinic power. The distance between the pastilles and the glass wall of the tube should never be less than 2 cm., to prevent their being discoloured by the heat of the tube. The pastilles are most accurate when used with tubes of medium penetrating power. With soft tubes they tend to indicate a smaller dose, with hard tubes a larger dose than is actually given.

The Kienböck Quantimeter.—This method is based on the discoloration of bromide of silver under the influence of X-rays. Compared with the chromo-radiometer of Holzkecht or Sabouraud, it has the advantage that it is more sensitive, gives more subdivisions, leaves a permanent record, and is cheaper. Its only disadvantage is that the results can only be read off after a strip of sensitive paper has been developed, a process which occupies about one minute. There is no need to resort to a dark room, for with the help of a small light-tight box the development can be done in the treatment room.

The apparatus consists of :

1. Strips of bromide of silver paper measuring $\frac{1}{2}$ inch by $2\frac{1}{2}$ inches, enclosed in small light-tight envelopes. The envelopes bear a label to be filled up with the name of the patient, date, and duration of the exposure. Envelope and strip bear identical numbers.

2. A standard scale in wooden case, containing eight different tints of the colours which the bromide of silver will assume gradually under the prolonged influence of the X-rays. A runner with glass window slides along the scale, and the developed strips are inserted in this frame.

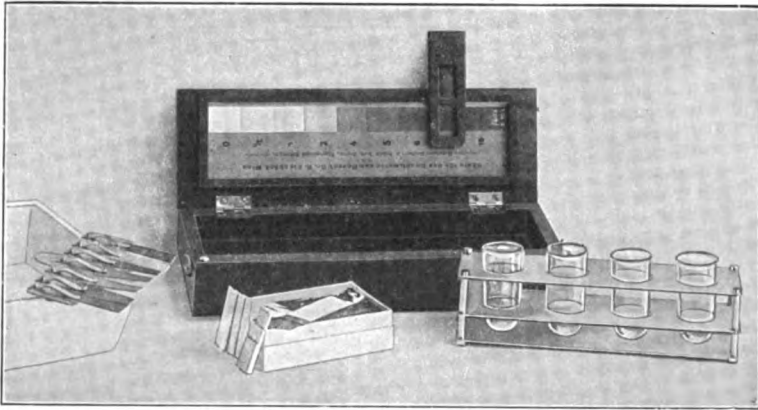

FIG. 341.—Complete Kienböck quantimeter. (Schall.)

3. A set of four test tubes of 2 inches diameter and 2 inches length, in a small metal stand.

A convenient addition, when a dark room is not available, is a dark box, which enables the operator to develop the strips in the room. This box accommodates the stand holding the test tubes, in which development, washing, and fixing take place. It is, however, much better to develop the strips in a dark room.

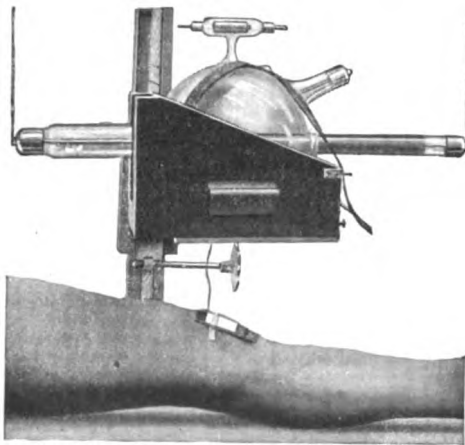

FIG. 342.—Arrangement of apparatus and paper when using Kienböck's method of estimating dosage.

Arrangements for Exposure.
—One or several strips of the sensitive paper are placed on the part to be treated; they absorb practically no X-rays. The side of the envelope bearing the label must face the patient's skin. If the total dose is to be administered in several sittings, the same strip is always exposed again, so that the sum total of the rays reaching the portion of skin of the patient will also reach

the strip. If many sittings with short exposures are to be given, it is convenient to use more than one strip; one is left to record the total sum, and of the other, parts are cut off from time to time to make test developments.

The number of the strip (and other data) should be immediately

entered into the case book or chart, where also the strip is attached when it has been washed and dried. This provides a permanent record of the dose given.

Development.—In order to find out the quantity of X-rays which has been administered, the strip has to be developed.

The developer consists of two stock solutions, A and B, mixed in proper proportions with distilled water, and made up as follows :

A		B	
Distilled water . . .	1000 c.c.	Distilled water . . .	1000 c.c.
Sulphite of soda . . .	150 grammes	Potassium carbonate . .	110 grammes
Metol (Hauff) . . .	15 „		

Owing to the difficulty, at the present time, of obtaining metol, substitutes have to be used.

When the developer is changed it is necessary to ascertain the time factor for each set of strips; this should be done experimentally.

FIXING SOLUTION

Distilled water	1000 c.c.
Sulphite of soda	20 grammes
Tartaric acid	10 „
Hyposulphite of soda	200 „

Great care must be taken in preparing the solutions; it is essential that the bottles shall be absolutely clean, and that distilled water shall be used throughout. The developer should never be used when it has become stale.

An alternative developer consists of a stock solution, made up as follows :

Metol	1 gramme
Hydroquinone	4 grammes
Sodii sulphite	50 „
Carbonate	50 „
10 per cent solution of potassium bromide	4 c.c.
Distilled water	500 c.c.

The fixing solution is made up as follows :

Hypo	400 grammes
Water	1000 c.c.
Potassium meta-bisulphite	25 grammes

Each box of strips is furnished with a set of instructions regarding the duration of development, and these must be carefully observed.

It is not always possible to make succeeding batches of strips of exactly the same degree of sensitiveness; therefore each new batch should be carefully tested, and if necessary a new scale of tints be prepared. Each strip is marked with a letter, and must only be compared with a scale bearing the same letter.

The first of the four test tubes is filled with the developer mentioned above, the second is filled with water, the third with fixing solution, and the fourth again with water. The strips are taken out of the envelope either in the dark room or in the dark box mentioned above, and are immersed in the

developer for a certain time, which is stated on the instructions given with the strips. The strip must be kept in motion while in the developer. The same developer can be used for several strips, but it deteriorates gradually in contact with air, and should therefore not be used for more than three or four strips in succession if accuracy in estimating the dose is to be ensured.

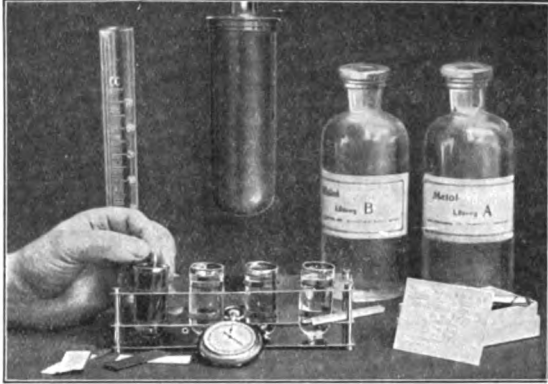

FIG. 343.—Developing the strips.

As in photography, great care must be taken that the developer is not contaminated with hypo, and it must be at the temperature stated on the instructions (18° C.), because too cold a developer produces far too light a tint. After development, the strip is washed for a few seconds in the second glass, and transferred into the third glass containing the fixing solution. It ought to remain in this not less than a minute, but if it remains longer no harm is done. Then it is rinsed in the fourth glass, and is ready for comparison with the standard scale. (It need not be dry for this purpose.) To leave a permanent record, the strip has to be washed like any print for about half



FIG. 344.—Comparing the wet strip with the standard scale, using the slide.

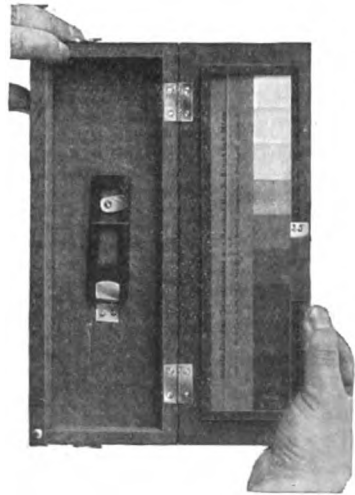

FIG. 345.—Comparison of the dry strip without the slide.

an hour in several changes of water or in running water. Several strips may be developed or fixed simultaneously by using a large enough vessel.

The Standard Scale consists of nine different tints, marked 0, $\frac{1}{2}$, 1, 2, 3, 4, 5, 7, 10. The tint marked 1 is to be considered the unit, and is denoted by 1 *x*. It is half the value of the dose required to produce one unit in

the Holz knecht Chromo-radiometer, and one-tenth of the Sabouraud-Noiré Tint B dose.

We therefore have :

$$10 x (\text{Kienböck}) = 5 \text{ H (Holzknecht)} = 1 \text{ B (Sabouraud-Noiré)}.$$

If it is intended to administer the maximum dose in one sitting, it will be a convenience to expose two strips of paper simultaneously. When, measuring the current passing through the tubes with a suitable milliamperemeter or judging the degree of fluorescence by experience, it is found that the maximum dose desired has been nearly reached, the exposure is interrupted for a few minutes to develop one strip and compare it with the standard scale.

If it took ten minutes to produce tint No. 5, then it will require another two minutes to bring it to tint No. 6; or if it took nine minutes to impart to the strip the colour of tint No. 6, it will take another six minutes' exposure to bring it to a colour similar to tint No. 10 (provided that the condition of the tube has not altered materially).

As it is not possible to read the value of the dose directly from the quantimeter strip during

the irradiation, it is advisable to measure the dose at the same time by observing the milliamperemeter, and timing the duration with a watch, or it may be checked by using at the half-distance a Sabouraud pastille. A second pastille may be placed on the skin and checked by means of a Hampson or Lovibond radiometer.

If it is desired to ascertain the quantity of X-rays which have reached a certain depth, a piece of aluminium 1 mm. thick is laid on part of the strip. It has been found that this absorbs as much of the X-rays as a layer 1 cm. thick of skin, fat, and muscles will absorb. In such a case the developed strip will show two different tints: the darker one indicates the quantity of rays received by the surface of the skin; the lighter tint records



FIG. 346.—Plain strips, exposed and developed.

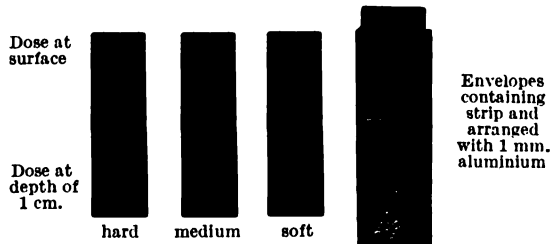

FIG. 347.—Strips exposed with 1 mm. aluminium and developed.

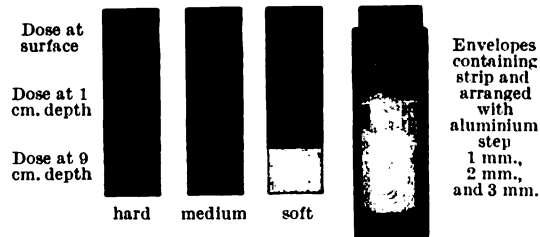

FIG. 348.—Strips exposed with aluminium ladder and developed.

the quantity of rays which have penetrated to a depth of 1 cm. below the skin. Strips of aluminium are supplied also which aid in the determination of the effect produced at 1, 2, or 3 cm. depth. If the effect is desired on the skin only, it is advisable to use medium tubes, No. 8 Wehnelt; if deeper lying parts have to be treated, it is necessary to take tubes No. 10 or 11 Wehnelt.

Name J. B. Very Medical Attendant Mr. Medico
 Address City Exchange 1, Hospital Place.

Record of X Ray Exposures.

Date	Hardness of Tube	Exposure Min. Sec.	Amp.	M.a.	Filter.	Area.	Paper and Value on Scale	Remarks
9.3.14	7½	10	5	3½	3m.	1	10+	
	8½	10	5	2	.	2	10+	
12.3.14	9	15	4	1½	2	3	No paper	
12.3.14	"	"	"	"	2	4	No paper.	
18.3.14	8	"	5	3	2	1	10	
"	9	"	4	1	2	2	8	
25.3.14	9	15	5	2½	3	5	5	
"	9	15	5	2	3	6	4	
30.3.14	9	15	5	2	3	3	4	
"	9	15	5	3	3	4	4	
6.4.14	9	"	4	2	"	1 back.	5	
"	9	"	2	1½	"	2 back.	4	Brush not working well.
15.4.14	7-8	10	4-4½	2-2½	"	1	5	
	7	10	4½	2½	"	2	5	
	9	15	5	2	Dev. wrong.	5	2	Improving.
			6	3	"	6	2	
6.5.14	9	15	5	2½	3m.	5	6	
	6½	20	4½	2	"	6	6	
19.5.14	9	15	6	3½	"	3	8	
"	"	"	"	"	"	4	8	
Total								

FIG. 349.—Chart of X-ray exposures, to show method used in recording dosage by Kienböck's method.

It is, however, often necessary nowadays to give doses far larger than 10 x in a single sitting for the treatment of fibroids or malignant disease. As the strips would become far too dark for comparative readings to be made under these circumstances, a second scale has been prepared, in which tints are shown which are obtained on strips exposed under a block of

aluminium 10 mm. thick. In this way the action on the strip is lessened and the latter does not become so dark, although large doses are given. Quantities up to 30 or 40 x can be conveniently estimated. The comparison, development, etc., of the strips is exactly the same as if the 10 mm. aluminium were not used. The dose which the strip then shows, when compared with the scale prepared specially for the purpose, may be taken as an indication of the dose on the skin surface. The strips should be compared with the standard scale and a record kept of all exposures given, with the total dose for each complete treatment. The method of recording such data will necessarily vary with each operator. A record sheet should be reserved for each patient, and all particulars of treatment entered on it. A portion of the developed paper may be arranged opposite each dose, and its numerical value placed alongside. This enables the operator to calculate rapidly the total of the exposures. All the other data of exposure should also be recorded. Fig. 349 illustrates a good method used for recording the dosage.

The Lonto Quantimeter.—This instrument has been designed by Dr. Szillard of Paris. An electrometer and a small static machine to charge it are enclosed in a small case, and a needle moving over a scale indicates the degree of the charge. A flexible rubber tube, which encloses a conductor, leads from the electrometer to a small ionising chamber, which contains one electrode connected with the electrometer, and a second one connected to earth.

It is necessary that the insulation should be perfect, so that surface leakage owing to dampness cannot take place. When the X-rays reach this ionising chamber the electrometer begins to discharge, and the index of the needle moves from 0 towards 10.

The division of the scale has been calibrated to agree with the Kienböck quantimeter. When the needle reaches 10, the ionising chamber, which can be exposed on the skin of the patient, has received a full erythema dose. The instrument is so sensitive that half an x , *i.e.* the twentieth part of an erythema dose, can be measured. The degree of ionisation varies with the penetrating power, and the instrument can be calibrated for various degrees of it by placing diaphragms of lead over the ionisation chamber, so that the area exposed to the influence of the X-rays can be made larger or smaller. The instrument is new, and its practical value has yet to be proved. In theory it is certainly good.

Lovibond's Tintometer (adapted by Dr. Dudley Corbett) provides a very accurate method of estimating the degree of coloration of the Sabouraud-Noiré pastille. The apparatus consists of a tube or oblong viewing box, divided into two by a vertical partition, so that on looking through the eye-piece against the background two small white circles are seen. At the distant end of the box are frames provided for the insertion of the glass standards; on the right for the colour tints, and on the left for a neutral tint if required. The use of the latter will be explained below. The background is composed of pure white standard paper. In the background support is

cut a shallow groove or a hole for the pastille holder, depending on the type used, so that the pastille can be examined without removal from its holder. The tint of the pastille is thus compared with the standard inserted. It is possible to get such an exact match in tint that it is impossible to say on which side the pastille was situated. The advantages of this radiometer over others, where the Sabouraud pastille is employed, are :

(1) The colour standards are kept constant and invariable in tint, are easily kept clean, and do not fade. The smaller differences between the fractional doses are readily appreciated.

(2) They have all been verified experimentally in tinea work, and any fractional or multiple dose can be standardised.

(3) There is provision of a separate series for daylight and standard

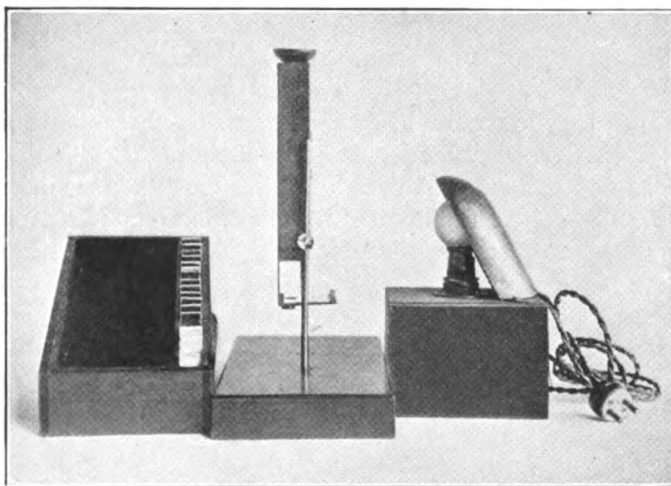

FIG. 350.—Lovibond's tintometer, adapted and standardised for the accurate measurement of the colour changes in the Sabouraud-Noiré pastille by Dr. Dudley Corbett. (The Tintometer, Ltd.)

artificial light. A series could be worked out for any constant source of light if required.

The standards are composed of tinted glass and can be supplied for any fractional dose, from the unexposed pastille, or Tint A of Sabouraud, up to 2 B ; in other words, the standard for any dose up to 10 H, or 20 X, can be supplied in an absolutely accurate and permanent form. It has been thought desirable to retain the symbol B to represent the erythema dose, for doses in therapeutic work are usually spoken of in terms of "B" in this country.

The doses in common use are those for :

A	$\frac{1}{2}$ B	$1\frac{1}{2}$ B
$\frac{1}{4}$ B	$\frac{3}{4}$ B	2 B
$\frac{1}{8}$ B	$\frac{1}{4}$ B	

But standards for any intermediate dose can be made to suit the convenience of the user.

There are also neutral-tint glasses for use when measuring the unexposed pastille and the $\frac{1}{4}$ and $\frac{1}{3}$ B in *daylight*. Parts of a set can be obtained if desired.

This instrument is the result of an enquiry into the colour changes occurring in the Sabouraud-Noiré pastille when exposed to X-rays. The standards are invariable and do not fade. Equal accuracy can be obtained by white daylight or by electric light. The standard electric light is that from an 8 c.p. carbon filament lamp, with frosted glass and in good condition. Failing a carbon filament lamp, a low-power metal filament lamp with frosted glass may be used, but the results are better and more accurate with the carbon filament lamp which was used for the experimental work.

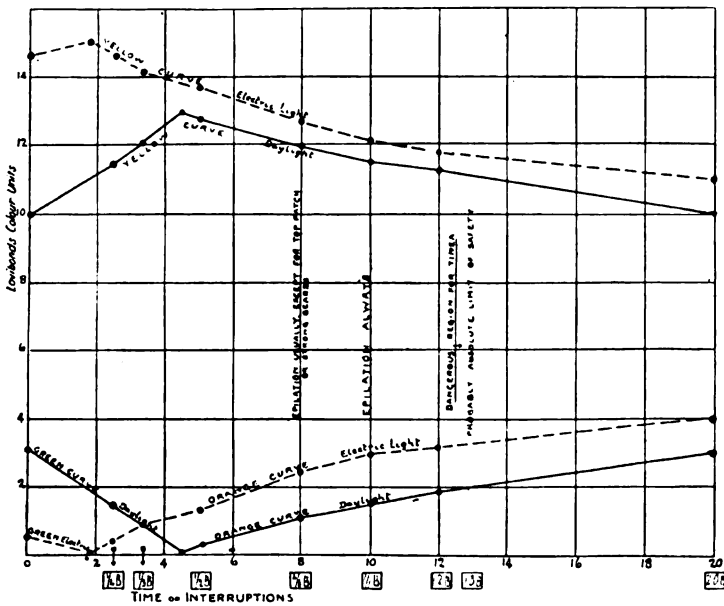

FIG. 351.—Curves showing colour developed by Sabouraud's pastille when exposed to unfiltered X-rays in measured doses.

The pastille should be about 6 inches away from the lamp ; care should be taken that no shadows are thrown upon it. The pastille should be examined in its holder. The exact dimensions of the holder, as well as that of the pastille in use, should be given when ordering the instrument. The area of pastille exposed to the action of the rays should be of such a size that on looking down the instrument *none of the unchanged green colour* should be visible. Therefore those holders that only expose half of the pastille should not be used. The actual aperture which controls the amount of pastille exposed to view can be varied to suit requirements.

The examination should be made rapidly, as the pastille fades even in electric light.

The Depilation Dose.—When new pastilles are used, the standard for 1 B allows a 20 per cent margin of error on either side, *i.e.* $\frac{4}{5}$ nearly always depilates

and $1\frac{1}{5}$ B is nearly the absolute limit of safety for unfiltered rays. *For quite accurate work new pastilles should always be used.* The tint of a used and bleached pastille can always be compared with the standard; if it is definitely more yellow than this it should be discarded. The *daylight* standards for the unexposed pastille and for $\frac{1}{4}$ and $\frac{1}{3}$ B require the additional use of neutral-tint glasses if the colours are to be matched exactly, otherwise they are brighter than standard, due to the white light reflected. This brightness is dulled by the interposition of a standard neutral-tint glass. The grade of neutral-tint varies very slightly with the amount of varnish on the pastille. On an average the neutral tints required are 1.5 for the unexposed pastille, 0.4 for $\frac{1}{4}$ B, and 0.2 for $\frac{1}{3}$ B. For higher doses no neutral tints are necessary. When measuring by electric light a neutral tint is only required for the unexposed pastille standard, and this is usually about .50.

Cox's Chromo Radiometer.—A later model has been introduced by Messrs. Cox, which is a novel and convenient arrangement for measuring

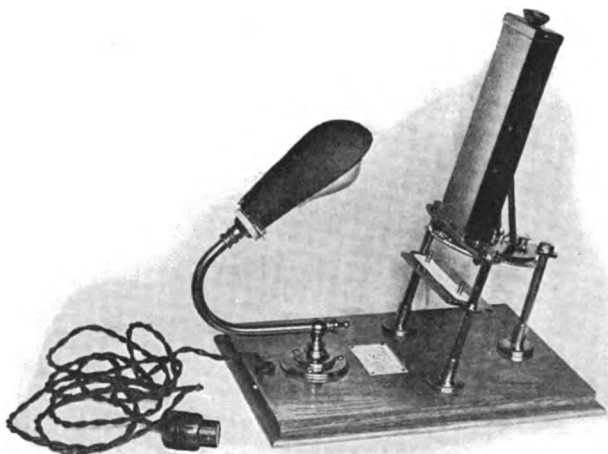

FIG. 352.—Chromo radiometer. (H. W. Cox & Co., Ltd.)

fractional and erythema doses. It embodies the well-known and useful features of Lovibond's tintometer for colour measurement, and the instrument is so arranged that a measurement of the colour change, and hence of the dosage, can be made at any time in a few seconds. The colour standards are composed of permanent tinted glasses, and are mounted on the circumference of a circle, so that any one of them can be brought into position by simply turning a milled disc. The instrument is provided with eight colour standards for measuring the doses of X-rays.

Hampson's Radiometer.—This is a new radiometer designed for the purpose of reducing the length of time which is necessary before the full dose may be given when employing the Sabouraud-Noiré pastilles.

It consists of a series of twenty-five very carefully graded tints, which represent the shades of colour assumed by a pastille of barium platino-cyanide under the action of X-rays.

The initial or zero tint is the colour of the unexposed salt, and the sixteenth change represents the brown shade of colour equivalent to the maximum or B tint of a pastille.

The radiometer consists of these tints arranged upon a circular card, the latter being enclosed in an outer case. This has a small aperture cut in it, through which the tints can be successively viewed one at a time, and the aperture is so shaped that the sensitive pastille can be placed in close proximity to the tint, the latter being rotated by the thumb until an exact match in colour has been obtained.

Another small opening exposes to view a series of numbers, ranging from 0 to 24, whereby the tints can be identified. The whole is covered in black cloth.

Tints are so arranged that for exact matching they shall be viewed by artificial light obtained from an ordinary incandescent carbon lamp. In hospital practice this is found to be the most convenient, as artificial light is frequently employed, and there is nearly always a pilot lamp on the switchboard by which the tints may be accurately gauged.

The radiometer is so sensitive that it is possible to measure with accuracy the pastille tint when it has not become nearly such a dark colour as in the case of the Sabouraud method, and Dr. Hampson reduces by half the exposure time for an epilation dose, by placing the patient nearer to the X-ray tube than was hitherto permissible in view of the danger which might result from inaccurate judgment of the colours.

When employing this method it is necessary to place the pastille on the patient's skin, and a full depilation dose is obtained when the pastille has turned four divisions of the scale. When the sensitive pastilles are exposed to daylight, it is known that they return, to a great extent (although not absolutely), to their initial colour, and this radiometer provides a means of using a pastille safely in this condition, as it is only necessary to place it in the radiometer before use and find the number which indicates its colour, and the full dose will then be obtained when the pastille has turned to another tint nearly four stages darker.

It should be noted that, since the changes of colour in the darker shades are more difficult to observe than in the earlier stages, it is not advisable to use the same pastille more than four times in succession. Also that the colour-change of the pastille during the exposure is not exactly even, the



FIG. 353.—Hampson's radiometer.
(Newton & Wright.)

earlier stages being slower in proportion to the X-rays received ; therefore in each exposure of a fresh pastille it is better to stop a little short of the four-stage tint.

Further, the delicate gradations of tint available in this instrument have made manifest the widely different interpretations put by different observers on the same shade of colour. It is, therefore, wise for operators who have not worked long enough with the new instrument to be sure of their own interpretation of the finer shades, to stop short of what appear to be the four complete grades in giving the depilation dose.

The Use of Filters

The question of filtration is an important one, and a diversity of opinion exists as to the value of filters. So important is this question that a great deal of discussion has taken place on the matter, but as yet no standard filter has been agreed upon. Some authorities are content to filter through boiler felt, tungstate of calcium on lint, etc. Others use aluminium or leather. The valuable work done on this question by Gauss and Lembcke of Freiburg has seemed to prove that aluminium, when properly used, is undoubtedly the best of all the filters ; it is certainly the most convenient. Boiler felt, if used of sufficient thickness, is an excellent filter, and in the hands of some may be sufficient.

The position of the metallic filter in relation to the patient and the X-ray tube is a point of the greatest importance. If it is close to the skin it must be earthed. A layer of some material, such as lint, leather, or paper, must be placed between the filter and the skin in order to absorb the secondary radiations which are largely given off when aluminium is struck by X-rays. It is a better plan to place the filter at the half distance between the anti-cathode and the surface of the body, and even at this distance the skin should be protected by felt or wash leather. A number of filters of varying thicknesses should be provided—from $\frac{1}{2}$ mm. to 2 or 3 mm. form a good set. The tendency is growing to use filters of 4 or even 6 millimetres thickness in the treatment of deep-seated lesions. These are used according to the object aimed at and the frequency of the exposures.

After an extensive use of these filters the opinion has been arrived at that no ill effects directly attributable to the secondary radiations from aluminium have ever been obtained. Reactions have occurred, but they have readily been traced to the frequency and length of the exposures, and not to secondary radiations.

In the treatment of cancer by X-rays the writer is convinced that the results obtained when using aluminium filters have been better than when boiler felt or other materials were used. By gradually increasing the thickness of the filter, it has been possible to give larger doses, and those more frequently, than would have been possible without their use. He attributes this improvement in results unreservedly to the help afforded by these

filters and to the employment of very hard tubes, which are so generally used when filters are employed.

It is remarkable to note how often the same area may be treated without producing any marked reaction. When the reaction is not very great, treatment can be steadily continued with an increasing thickness of filters, whereas without their use it would have to be suspended for weeks and valuable time would be lost.

The treatment may be continued even in the presence of marked reaction if the healthy skin can be protected by thick layers of lead or lead rubber, leaving only the diseased areas exposed to the treatment.

Filter Equivalents.—Dr. R. W. A. Salmond, working in the Research Laboratory of the Cancer Hospital, conducted an exhaustive investigation into the value of the various substances used for filtration of X-rays. His results show a remarkable uniformity, and will be of the greatest use to the radiotherapist. A tabulated list of his conclusions is given below :

FILTRATION EQUIVALENTS FOR HARD THERAPEUTIC X-RAY TUBES

Aluminium.	Pure Com-pressed Paper. ¹	Tanned Leather. ²	Chamois Leather.	Boiler Felt.	Tungsten Lint. ³	Lead Acetate Lint. ⁴
·5 mm.	3 mm.	3 mm.	10 mm.	13 mm.	2 layers	1 layer
·1 "	7 "	7 "	18 "	30 "	4 "	2 layers
·2 "	13 "	13 "	35 "	67 "	8 "	4 "
·3 "	17 "	16 "	59 "	97 "	12 "	6 "

The Selection of the Filter.—This largely depends upon the object of the treatment. In superficial lesions a $\frac{1}{2}$ mm. filter of aluminium may suffice. When treatment has to be continued over a long period, at frequent intervals, then it is well to use a filter 1 mm. thick for several weeks, and gradually increase up to 3 mm. The choice of filter in malignant disease is fully discussed in the chapter on the treatment of malignant disease. In the treatment of myoma uteri by the Freiburg technique the filter is 3 mm. thick. This was found by Gauss to be the most useful one, and it affords ample protection when many ports of entry are employed. In these cases great care must be exercised to prevent overlapping of the areas.

Additional Filters.—In addition to the metal filters, a number of thick felt pads and a good supply of chamois leather will be found useful. A supply of thick lead sheets should be at hand. Lead rubber is also very useful for protecting the skin surrounding the area to be treated ; pieces can be cut to the desired shape and size, and as they are easily sterilised they may be used again for the same patient.

¹ Known as London board.

² As used for repairing boots.

³ Average hospital quality of lint thoroughly soaked in a saturated solution of sodium tungstate, and allowed to dry in the air.

⁴ Same similarly treated with lead acetate.

The Choice of the X-Ray Therapeutic Tube

This is a most important matter. A great variety of tubes are in use, and each type of tube has its enthusiastic advocates. The earlier therapeutic tubes were of small diameter, and were exhausted to work with a small

amount of current in the secondary, the resistance of the tube being kept low in order to ensure a large percentage of soft rays discharging from the tube. The bulb of the tube was made very thin with the intention of allowing as many of the soft rays to pass as possible. Special glass windows were introduced opposite the anti-cathode to allow still further the softest rays to pass.

A gradual tendency has asserted itself of late to use the larger tubes, and a harder quality of ray has taken the place of the very soft one. The latter was found to produce a considerable degree of reaction, and even dermatitis, without in any way increasing the therapeutic action on the deeper tissues. Even in the treatment of ringworm it has been found that satisfactory results are obtained when a hard tube is used, and the reaction obtained

is much less than that from a soft tube. And in this disease the use of $\frac{1}{2}$ mm. filter of aluminium gives quite good results, with hardly

FIG. 354.—Diagram to illustrate a method of circulating water to the anti-cathode of a tube. (Schall.)

The tube is shown unprotected. This would not occur in actual practice.

any reaction and only slight delay in the depilation. So that, even for the most superficial conditions we may have to treat, a hard ray can be employed and a filter used.

The Coolidge tube has been shown to be of proved utility in radiography,

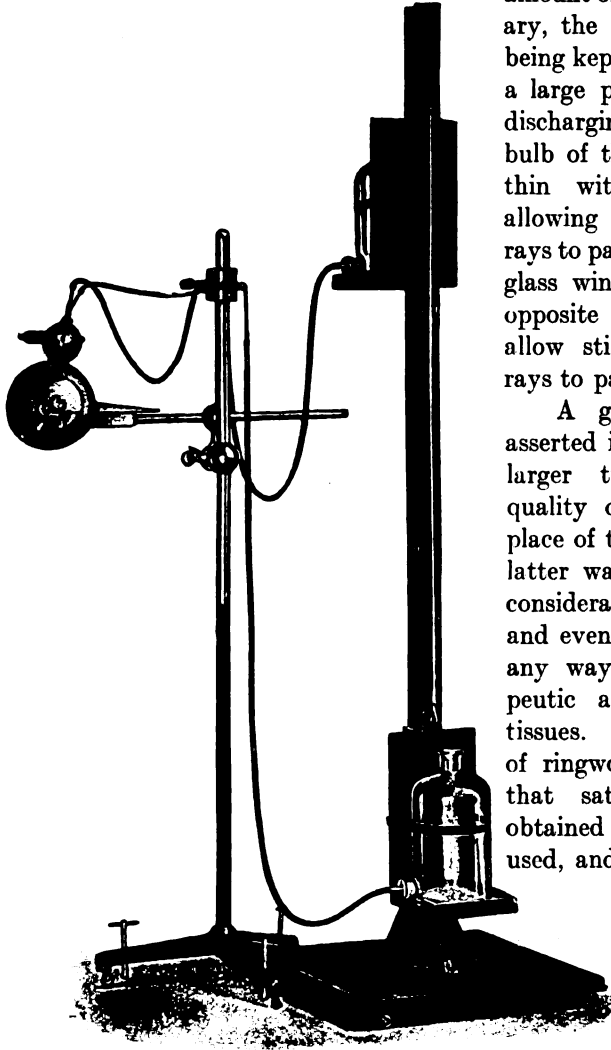

and if its reputation depended on that alone it would have amply substantiated the claims made for it, but it possesses still greater advantages when used in therapeutic work. To those who have been engaged in this work practically from its infancy, it is hardly too much to say that the Coolidge tube is by far the most efficient tube we have yet had the opportunity of using, and it would be difficult to conceive of any improvements which would be likely to make it more efficient. Within reasonable limits of safety, so far as the tube is concerned, it may be used for many hours daily, and at the end of the day still be able to continue its output of uniform radiations.

With its ready adjustment of quality of ray emitted it should be possible to select the proper degree of hardness at will and arrange the tube to

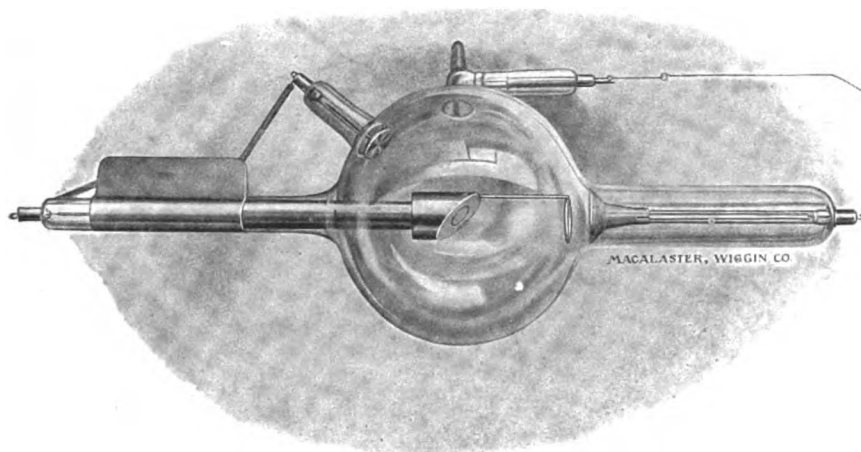

FIG. 355.—Macalaster Wiggin X-ray tube.

produce it for an unlimited time. This tube makes the reproduction of precisely similar rays at a subsequent exposure possible.¹

For superficial work, such as treatment of skin diseases and particularly ringworm, a small tube will do excellent work. It must be kept for such work, and should never be allowed to pass more than 1 milliamperes of current. When carefully used it is possible to get a great deal of work from these small tubes. For all deep work, where great penetration is required, the larger tubes are absolutely necessary. These may be of any type so long as they meet the requirements of the cases treated. The water-cooled is a good example of the tube suitable for deep therapy. There are two varieties of this tube :

(1) The Penetrans, a tube with a small bulb. Attached to it is a larger accessory bulb, which favours the maintenance of the vacuum (see Fig. 356).

¹ For experiences and experiments with the Coolidge tube, see *Proceedings of the Royal Society of Medicine* for March 1916.

This tube makes it possible to get closer to the skin surface with the anti-cathode. The tube is fitted with an osmosis regulator.

(2) The ordinary water-cooled tube is also very useful. Both of these tubes may be fitted with a circulating flow of cold water by means of a special apparatus.

Of the later types of tubes which are made to stand heavy currents for long periods, the radiator tube of Cossar or Andrews and the Macalaster Wiggin are most useful (Fig. 355). Tubes of the latter type are very useful for deep treatment; when well balanced they will run for long periods and show remarkably slight variations in vacuum. But in all probability the Coolidge tube will be the main stand-by of the radiotherapist in the future.

The use of the Coolidge tube in therapeutic work has shown that it

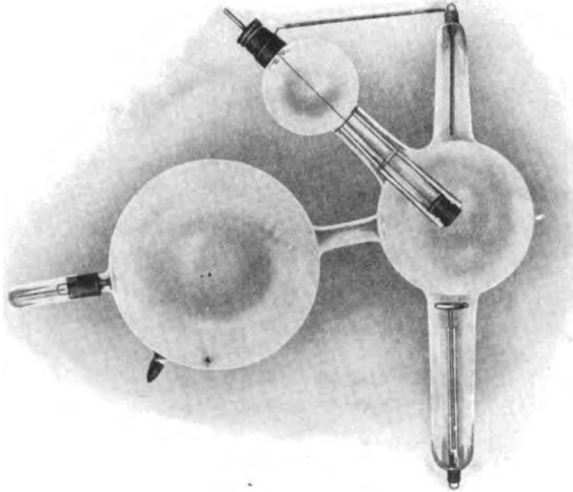

FIG. 356.—Penetrans tube. (C. Andrews.)

is necessary to have very complete protection for the operator and for the patient. This may be achieved by completely enclosing the tube in a tested lead glass shield or one protected with sheets of lead rubber; an aperture is left at the under surface of the tube shield, and a small electric fan is arranged to create a current of air around the tube. A useful form of shield and cooler is now available.

The routine practice of the writer, when a Coolidge tube is not available, is to employ large tubes for practically all therapeutic purposes. The advantages claimed for these tubes of greater diameter are:

(1) The tube maintains its vacuum much longer than the smaller one, and is not so easily thrown out of adjustment.

(2) It may be used with much heavier currents and for a longer time. When thoroughly seasoned, a large tube may be run for hours without showing any appreciable variation in hardness. This is most important

when large areas require treatment or when deep-seated tissues have to be radiated.

Methods used for cooling the X-ray Tube.—In view of the increasing importance of X-ray therapeutics, and the increased calls that are consequently made upon the X-ray tube, all accessory methods of regulation and cooling must be carefully considered. Of the cooling devices the two methods most likely to be employed are :

(1) The water-cooled tube, with a constant circulation of water to the anti-cathode.

(2) The air-cooled tube, where both the cathode and the anti-cathode are cooled by a supply of air obtained from a motor-driven pump.

By means of these cooling devices and the use of a rhythmic interrupter, it is possible to get therapeutic effects upon deep-seated tissues by means of greatly increased dosage, both of time and hardness of ray. Five and six milliamperes may be passed through a hard tube for a considerable period.

The water-cooled tube is one of the most useful. With care in usage, this tube will answer to all the requirements of present-day therapeutics. It is very important that the tube should be gradually seasoned before it is subjected to a severe test. If this is done, large currents may be passed through it for long periods and the hardness of the tube be maintained. Air-cooled tubes are useful in places where a large amount of work has to be done. These, again, must be seasoned before they are severely tested. Of radiator tubes, the Cyclop is one of the best for therapeutic work ; it answers all the tests which can be applied to it.

Sometimes a new tube is hopelessly reduced in its first few runs with the apparatus. Such a tube, if re-exhausted, frequently recovers and works well for long periods. The chief point to remember when using an X-ray tube is to work it carefully up to its highest degree of stability, this being its best possible condition for heavy and prolonged work.

The appearance presented by the tube in action has been described in the text in Vol. I. and illustrated in the coloured plate ; the pictures shown were coloured from tubes made of glass prepared in Germany. Tubes made in England show a different picture, the colour being blue instead of apple-green. The difference in the fluorescence is due to the composition of the glass. It is therefore necessary, when using tubes made of English glass, to remember the difference in the appearance of the active tube.

THE TREATMENT OF DISEASES OF THE SKIN

No greater testimony to the value of X-rays in the treatment of diseases of the skin could be given than the fact that all skin hospitals have an X-ray department, and that nearly every specialist includes a more or less perfect installation in his armamentarium.

To get uniformly good results the technique must be thorough, and the operator able to reproduce at will definite conditions of the X-ray tube. Careful data must be kept in order to facilitate the reproduction of conditions known to have been useful in previous similar cases.

It may be laid down as an axiom that it is the chronic conditions of skin disease which receive most benefit from X-ray treatment, and that no case of acute disease should be treated by radiation before time has been allowed for the inflammatory processes to subside. An exception may be made if malignant disease is present, as there the inflammatory processes, if carefully helped by treatment, may lead to improvement.

Further, all previous treatment must be considered before X-ray treatment is commenced, and preliminary treatment by iodine, mercurials, and ointments containing metallic bases must be discontinued. The X-ray treatment should not be started at once in these cases; time must be allowed for these substances to be removed from the skin. Internal treatment by drugs need not necessarily be discontinued, though if it is desired to determine the value of X-rays unaided by these remedies they should be discontinued. In some cases the iron and arsenic of tonics may, by circulating in the blood, aid in the curative effects by their secondary radiations. This point has been discussed elsewhere.

Subsequent to X-ray treatment, soothing lotions and ointments may be employed, but care must be exercised in their selection and use. In some cases the judicious use of a stimulating lotion or ointment may be necessary, but as a general rule all that is required is the dusting of the part with a powder containing starch and a little zinc oxide.

All crusts must, if possible, be gently removed from the surface to be treated; if a discharge is present the surface should be gently rubbed over with a pad of cotton wool. The exposures necessary are purely a question of experience, and the degree of filtration to be employed is determined in the same way.

The important point is to obtain the maximum of benefit with the minimum of harm, and it is well to bear in mind that serious harm may be done by the injudicious use of X-rays.

Eczemata.—Subacute and chronic eczema will often clear up under X-rays when all other methods fail. The first dose should be unfiltered with the tube fairly soft and a 3- to 4-inch spark-gap. A Sabouraud pastille should be coloured to the B tint, its distance from the skin being the half distance of the skin from the anti-cathode. It should be noted that dermatologists who use X-rays in treatment advise $\frac{1}{2}$ pastille dose or less in some cases. These minimum doses can be administered at frequent intervals. In this connection it may be observed that Hampson, Batten, and others employ the method by which the tube is brought nearer to the skin, and the pastille used on the skin instead of at the half distance; when using this method the dose should be estimated by Hampson's radiometer. But beginners are advised to adhere to the preceding method. Should the distance be greater than usual the dose requires to be longer. It is important that the pastille should always be at the half distance. Later doses should be given through an aluminium screen of .5 mm. thickness.

This allows of more frequent exposures, and also of a harder ray being used when deeper than superficial effects are necessary. When the cure begins to progress the action may be continued by a dose once in three weeks. After the disease has disappeared it is well to give a few exposures at longer intervals to keep up the effect and prevent the recurrence.

Psoriasis.—This very persistent disease will frequently clear up under X-ray treatment. The technique is the same as that for eczema, except that in most cases .5 mm. filter may be used from the commencement of treatment. The effect of the filter appears to be that the superficial reaction is avoided, and the doses may be given more frequently. Large areas of psoriasis may be treated once a week for three or four weeks. When those frequent doses are administered great care must be exercised in the estimation of the dose. One-third or half pastille dose will often be sufficient to keep up the reaction necessary to obtain the desired result. Later, once in three weeks is sufficient. When large or numerous small areas are treated it may be well to give one or more doses to several areas consecutively, then treat fresh portions at subsequent seances. In this way it is possible to keep up a continuous action over a large area. A general as well as a local effect is often observed, patches at a distance from the area treated slowly clearing up. From his experience of X-ray treatment of psoriasis, the writer has arrived at the conclusion that cases thoroughly treated by X-rays clear up fairly rapidly, and do not show such a marked tendency to recur as they do when treated by other methods.

Prurigo.—Some forms of prurigo benefit by X-ray treatment. The technique employed should be similar to that for eczema.

In the treatment of this disease the dosage has to be carefully regulated. When the symptoms are severe it may be necessary to give large doses for the first one or two exposures, then to administer fractional doses at subsequent seances, giving just sufficient to keep the irritation under control. Later treatments should be administered through a filter of 1 mm. or more. Cases of senile prurigo, attended by hardly any change in the skin, are

particularly amenable to X-radiations. Filters should be employed, but the dosage need not be large; $\frac{1}{3}$ or $\frac{1}{2}$ pastille dose administered through a filter once a week will be sufficient to relieve the symptoms. Under these conditions the treatment may be continued for long periods of time, and no reaction is observed on the skin. For a day or two after each treatment the irritation is greater, but this generally subsides within a week, and the patient is then free from it for several weeks or longer.

Lichen.—Chronic forms are likely to improve under treatment similar to the above.

Leucoplakia.—Many cases of this disease have been treated by X-rays. The writer is inclined to favour radium in these conditions, but good results may be obtained by X-ray treatment. A filter should be employed. It is well to remember that in many of these cases there is a syphilitic taint, and that in others the condition is complicated by a cancerous tendency. When the latter is present the case is likely to be very obstinate in its resistance to treatment. Cases which show no evidence of improvement are probably cancerous. The employment of hard tubes and adequate filtration, combined with frequent dosage, may lead to a rapid improvement in cases where no improvement had taken place under the lighter doses.

Trichophytia or Ringworm.—A number of diseases are due to the presence in the horny structure of the skin of hypomycetes. The treatment, where the scalp is involved, is specially dealt with. When situated in other parts of the body characteristic chronic lesions are found. When situated in hairy parts of the body X-rays are useful. The rays act by producing depilation and the parasite is removed along with the affected hairs. When the condition involves the nails and other parts, a few X-ray exposures should be tried, filtration and a hard tube being likely to prove useful.

The X-ray treatment of ringworm has been in general use since 1904. A very large number of cases have been treated since that time, and it is now generally recognised to be the most satisfactory treatment yet used for this very intractable disease.

The technique employed has been carefully elaborated by Kienböck. Dr. Adamson, who drew attention to this method in an article published in the *Lancet* in 1909, has simplified the technique, and in this country his is the one generally employed. It aims at the complete depilation of the scalp in all cases treated. There are exceptions to this, however. When the area of disease is localised to a small patch, it is well in some cases to treat the patch, and trust to preventive measures so far as the rest of the scalp is concerned. As a rule, however, it is well to treat the whole scalp even in cases where only a small area is involved. Experience has shown that a number of cases where one area has been treated show fresh infection in other parts. The exceptions to this rule are :

(1) In very young or delicate children, where it is unadvisable to treat the whole scalp.

(2) In cases where it is possible to ensure thorough treatment of the scalp by other means.

In all cases where a single area is treated the rest of the scalp should be shaved and the hair kept short until the area treated has been depilated. Antiseptic ointment should be applied to the whole scalp in these cases.

If the whole scalp is shaved at regular and short intervals until all the affected hairs have fallen out, the disease may be effectually checked. This is a good method to employ in young and delicate children, or in subjects who are suspected of being very susceptible to the action of X-rays. That such a susceptibility does exist in a very small percentage of individuals the writer is absolutely convinced. Every now and then, in spite of the most careful technique, a case is noticed which gives a violent reaction to minimum doses. Permanent alopecia may result in these cases. [This exceptional sensibility to rays has been met with in adults, where there could have been no question of an overdose of X-rays, yet where a most violent dermatitis was set up by a single dose which was much less than usual, the pastille being barely turned to the half tint, and the other factors, viz. spark-gap constant and the time well under what was known to turn a pastille with the particular tube, confirmed this. There have been variations in the X-ray tube, which could not be recognised by the ordinary methods; in such cases the pastille has changed in normal time to the B tint, but the subsequent reaction has been very great.] In spite of such evidence the writer has not the slightest doubt that very rarely will a case of extreme susceptibility be met with, and, so far as we know, there is no method by which we can determine beforehand the existence of such a susceptibility. Such individuals may be known to respond to other forms of skin stimulation. Thus there may be a history of reaction to sunlight or to counter-irritants or to antiseptic lotions, etc. Cases which show these characteristics should either be treated with extreme care or left alone. Recognising that such cases must be met with in the practice of all operators, and taking all possible care to exclude them from active treatment, it must be admitted that X-rays give us the best method we have for dealing with ringworm.

There are other points which must be taken note of before we treat a case with X-rays.

A careful enquiry must be made as to all previous treatment, particularly in cases of long standing. Such cases have been frequently treated with counter-irritants, and no patient should be treated until all reaction from such treatment has subsided.

A septic condition of the scalp, when present, must be treated with caution, otherwise violent dermatitis may result.

It must be borne in mind that the tendency of the disease, if of long standing, is to produce a degree of alopecia which may be more or less permanent. Such cases will often give rise to trouble and anxiety in the after treatment.

Children who possess fair hair respond more readily to X-ray treatment than those with dark hair, consequently the dosage must in the former case be rather less than in the latter. Tuberculous conditions of the scalp are

met with in children suffering from ringworm. These local patches may be stimulated and a degree of dermatitis set up quite independently of the X-ray treatment. Such conditions, however, generally subside and heal naturally.

The technique modified by Dr. H. G. Adamson is so complete and practical that we quote it as a guide for the treatment of all cases, with the exceptions mentioned above :

Depilation by means of the X-rays is now fully established as the most satisfactory method of treatment for ringworm of the scalp. By the introduction of Sabouraud's pastilles as a means of measurement of dosage, in trained hands the dangers of the treatment have disappeared. By Sabouraud and Noiré's method, with circular localisers, ten to twelve exposures are necessary in order to X-ray the whole scalp, and reckoning fifteen minutes for each exposure, the time occupied in X-raying the whole scalp is from $3\frac{1}{2}$ to 4 hours. By the method to be described the number of exposures necessary to depilate the whole scalp is reduced to five, so that it is possible to irradiate the whole scalp in $1\frac{1}{2}$ hours.¹

The essential features are that no cylindrical or lead foil localisers are used, but that adjacent X-ray applications are made in such a manner that at those parts where overlapping does occur, the incidence of the rays is so oblique, and so much further from the source, that no excessive dose is given.

I have used this 5-exposure method with perfect results, every part of the scalp has received an even radiation, and the hair has fallen out completely, without any sign of overlapping margins or areas with non-fallen hairs as evidence of insufficient exposure. There is no sign of erythema ; the regrowth of the hair has been normal over the whole scalp.

The details of the method, as Dr. Adamson employed it, are as follows :

1. The hair is clipped short over the whole head to facilitate operations.
2. Five points are marked out on the scalp with a blue skin pencil, as follows (see Figs. 357, 358) :

In the middle line.	{	Point A, $1\frac{1}{2}$ to 2 inches behind the frontal margin of the hairy scalp.
		Point B, 1 to $1\frac{1}{2}$ inches above the centre of the flat area which forms the upper part of the occiput.
		Point C, just above the lower border of the scalp at the lower part of the occiput.

At the sides of the scalp. { Point D, on the left side, just above and in front of the ear.
Point E, on the right side, just above and in front of the ear.

Measured with a tape measure, the distance between any two of the five points should be exactly 5 inches.

3. The five points are joined up by lines made with a skin pencil. These lines should meet one another at right angles. The mapping out of these points and lines need not occupy more than one or two minutes.

4. A Sabouraud pastille dose, with the anti-cathode at $6\frac{1}{2}$ inches from the nearest point of the scalp, is given to the vertex, occiput, lower occiput, right side, and left side in succession, taking the points A, B, C, D, and E as the centre of each area to be rayed, and placing the tube so that the line joining the anti-cathode and the nearest part on the scalp is at right angles to a similar line

¹ With the introduction of larger outfits and the use of a Coolidge tube it is possible to greatly shorten the time of each exposure. This may be reduced to 1 or 2 minutes. But the shorter exposures necessitate very accurate estimation of colour-change, and the beginner is therefore advised to adhere to the longer exposures if untoward results are to be avoided.

joining the anti-cathode with each of the central points of the adjacent areas. The lines which have been drawn on the scalp connecting the five points give an indication of the direction in which the dose is to be aimed, *i.e.* of the position of the tube in relation to the head. The applications to the vertex, upper occiput, and the two sides are best made with the patient lying on a couch. The forehead and eyes must be shielded by a piece of lead or protective rubber during the exposure to the front of the vertex, and the ears and sides of the face when the sides of the head are exposed. The fifth application, that to the lower occiput, is best given with

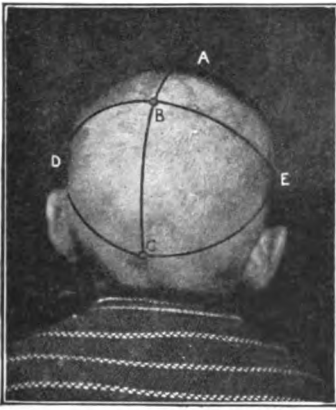

FIG. 357.—Diagram illustrating Dr. Adamson's method. (Schall.)

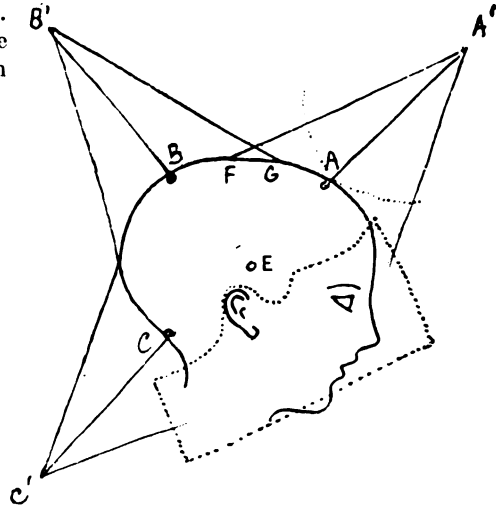

FIG. 358.—Diagram showing centres of areas to be rayed. (Schall.)

the patient sitting down and resting the forehead on a low table. A shield must be used to protect the neck.

In order to ensure fixing the anti-cathode at the correct distance from the scalp during the exposure, three slender wooden pegs are fitted to the box which encloses the tube. The pegs converge at their extremities to within $\frac{1}{4}$ inch of each other, and are of such a length that the part of the scalp which rests against them is just $6\frac{1}{2}$ inches from the anti-cathode of the tube. The pegs are made of soft wood, so as not to obstruct the passage of the rays through them. The pegs rest against the scalp just over the blue marks A, B, C, D, and E, according to the area to be rayed. The aperture in the box through which the rays pass is 3 inches in diameter and $3\frac{1}{4}$ inches from the anti-cathode, so that at the level of the points of the pegs the rays diverge to a circle of 6 inches diameter, and in this way one avoids the escape of rays into the room or towards the operator or on to the patient's shoulders, for a circle of this diameter is blocked by the patient's head. At the same time this circle of irradiation allows a sufficient margin for the necessary overlapping of the doses.

The essential points in this method are to direct each irradiation *at right angles* to the direction of the irradiation of adjacent areas, and to aim, not at a point in the centre of the vertex, of the lower occiput, or of the sides of the scalp, but towards the outer margin of these areas, so that half the dose goes on to the scalp and half on to the shield protecting the face and neck. If these precautions be taken there is no risk of over-exposure at the overlapping margins of the rayed areas. In practice the dosage works out so nicely that every part receives an equal amount, and depilation is total and complete, without any-

where a sign of over- or under-exposure. In theory, according to the well-known laws that the quantity of rays received at any point exposed varies (1) inversely with the square of the distance from the source; and (2) directly with the size of the angle of incidence, the dose received by any part of the scalp is found to be, with mathematical accuracy, one pastille dose.

In a case which has received a sufficient irradiation the hair begins to fall out about the fourteenth day, and depilation should be complete in from three to four weeks, a slight general erythema of the scalp, which soon subsides, being frequently noticed.

The regrowth of the hair is a matter of time, and varies in different subjects. It commences soon after the hair has fallen, and may be seen in the form of a fine down all over the scalp, the complete regrowth being generally well under way in three months from the time of treatment.

The variations may, however, be very great, *e.g.* the growth may be unequal, this depending upon the vitality of the hair follicles. The previous treatment may have devitalised the follicles to a more or less marked degree.

Careful attention must be paid to the following points in all cases:

(1) The scalp must be shaved before the treatment is undertaken. This enables the extent of the mischief to be determined, and facilitates the marking of the scalp. It also allows the rays to penetrate freely, thick hair acting as a filter, and preventing the thorough treatment.

(2) The scalp must be kept clean after the exposures; the head should be washed with soap and warm water two or three times a week. Until all the hair has fallen out the case is still infectious; it is, therefore, well to use a simple ointment, such as boracic acid (weak), or even vaseline, to prevent the spores from spreading, and possibly infecting other children. A skull cap of linen is useful for this purpose and also serves to keep the head warm. In some cases stronger antiseptic ointments may be used.

Folliculitis Barbae.—Satisfactory results may be expected if the proper technique is carried out. Care must be taken to regulate the dose so that no permanent damage to the hair follicles results. It must be insisted upon that no active local treatment be carried on simultaneously with the X-ray treatment. An erythema dose should be given unfiltered, and three weeks allowed to elapse before a repetition is given. The affected hairs fall out, and the condition rapidly improves. Subsequent treatments should be given at three or four weeks' intervals. Generally one thorough dose is sufficient to cure the condition.¹

Hypertrichosis (Superfluous hair).—This condition often requires treatment, and it is a difficult matter to decide by which method this may best be carried out. Electrolysis offers certain advantages over X-rays in so far that, apart from slight scarring, no after effects are likely to result. The treatment by X-rays is successful if precautions are taken in regard to dosage and the employment of filters. The untoward result likely to ensue from over dosage is reaction in the part treated, and later the occurrence of telangiectasis; from an under dose the hair is likely to return with more-

¹ For combined X-ray and ultra-violet ray treatment see p. 557.

or less vigour. The tendency is therefore likely to err on the side of under dosage. Success in treatment will follow if accurate dosage has been employed. The object of treatment is twofold—(1) to remove the hair, and (2) to so damage the hair follicle that it ceases to produce new hair. It is easy to administer a dose of sufficient strength to cause the falling out of the hair, but it is quite another matter to so gauge the first dose that it will effect the double object. It seems a rational plan to give the first dose of sufficient strength to ensure the depilation. This should be given through a filter of .5 mm. aluminium, and if the dose is properly estimated, the hair should come out readily by the end of a fortnight. A second dose, administered at the end of the fortnight, also given through a .5 mm. filter, should be sufficient to prevent the regrowth of the hair. It may be necessary to give several doses afterwards for the removal of isolated hairs whose follicles have escaped complete destruction. Patients treated for this condition by X-rays should be warned of the danger of possible after effects. Telangiectasis may appear as long as three years after treatment has been suspended. It may be assumed, however, that if there has been no reaction of the skin to the radiations, such untoward effects need not be anticipated.

Lupus Vulgaris.—This condition readily responds to X-ray treatment. Sometimes in remote situations of the body it will be necessary to resort to radium because of the greater facility this remedy offers in application. When the disease is situated on an accessible part of the body, X-rays should be the remedy employed.

Finsen light treatment has been extensively used for lupus, but X-rays will do all that the light can do, and they are more easily employed. The treatment is much shorter, and not nearly so tedious, and the results are obtained in shorter time and are quite as good and lasting. Several cases which did not respond to Finsen light treatment have cleared up after a short course of X-rays. To select the proper degree of hardness of the ray is the essential point, and filters should be used. After the lesion has healed, several thorough doses should be given at intervals of several weeks, and the patient should be kept under observation for a considerable length of time in order that any recurrence may be detected at the earliest possible date and be promptly treated. The results obtained by X-ray treatment are excellent, and the degree of reparative change which the tissues show is often remarkable.

Epithelioma.—Undoubted cases have been recorded by several observers, where epithelioma has followed upon prolonged X-ray treatment of lupus. In view of what has occurred in X-ray operators who have been subjected to repeated small doses, the occurrence of this condition cannot be disputed.

Lupus Erythematosus is another condition which responds to radiation treatment. It is, however, a very chronic condition, and is correspondingly difficult to treat successfully and it tends to spread after treatment has ceased. The occurrence of telangiectasis after prolonged X-ray treatment is not uncommon in a percentage of cases treated.

Acne Vulgaris.—When widely spread this condition is difficult to treat, but several exposures given at intervals, covering the whole of the affected area, will tend to a considerable improvement in the condition. The technique is similar to that for eczema.

Verrucae Vulgari or Warts.—This condition is particularly amenable to X-rays, but there are other remedies which are quite as efficacious. Carbonic acid snow and radium act well. Two or three exposures to X-rays lead to a rapid disappearance of the warts, but there is apt to be recurrence if the treatment has not been thorough.

Cheloid.—This condition is rapidly and permanently influenced by X-ray treatment. As it occurs so frequently after operations for cancer and other conditions, the radiotherapist has many opportunities of observing its progress after treatment. The transformation of a thick fleshy cheloid condition into a soft flexible scar is one of the most remarkable instances of the reparative change which can be induced by radiations. The relief obtained is also great, the scar becoming flexible, and the movements of the limb rapidly improving. The treatment requires to be thorough, and the whole of the cheloid must be treated equally and regularly. A full pastille dose may be given without a filter, and at the end of fourteen days a second dose, with .5 mm. of aluminium as a filter, will induce the necessary degree of reaction. This must be kept up by subsequent doses at regular intervals, until the whole scar approximates to the normal. The results obtained in extensive cheloid after burns are highly satisfactory, the irritation which is so common a symptom in these cases being quickly relieved, often permanently. A soft pliable scar takes the place of the thickened and unsightly one found before treatment. The treatment may have to be continued over long periods of time in large cheloids.

Chronic Syphilitic Lesions of the Skin are often sent for X-ray treatment, either with or without an established diagnosis. When very obstinate, a few X-ray exposures will serve to stimulate the tissue changes and tend to improvement, especially if antisyphilitic remedies are employed at the same time. It should be noted that these cases frequently respond actively to minimum doses, so care must be taken not to push the treatment too far or too rapidly. Time must be allowed to observe how the condition is likely to react before further doses are administered.

Simple Ulcers.—These readily respond to X-ray treatment. Unhealthy sores will assume under treatment a healthy granulating appearance, and in time will heal completely. The resulting cicatrix is generally a good one, and will in all probability give no further trouble.

Fissures in the skin and mucous membrane and fissured ulcers of the tongue are frequently greatly improved by adequate treatment.

Chronic Ulcers which fail to improve under other remedies will show a marked improvement when treated by a few pastille doses or fractional doses at frequent intervals; where granulations are present, but flabby, the stimulating effect of the rays greatly helps to an improvement in the general condition of the ulcer. Many cases heal slowly with prolonged treatment.

Malignant Invasions of the Skin will be dealt with in the section on the Treatment of Malignant Diseases.

Hyperidrosis.—Excessive sweating in various situations of the body is a condition which up to the time of treatment by X-rays was the despair of the skin specialist. Whatever its situation, it is a most unpleasant condition to deal with, and a source of great annoyance to the patient. The common

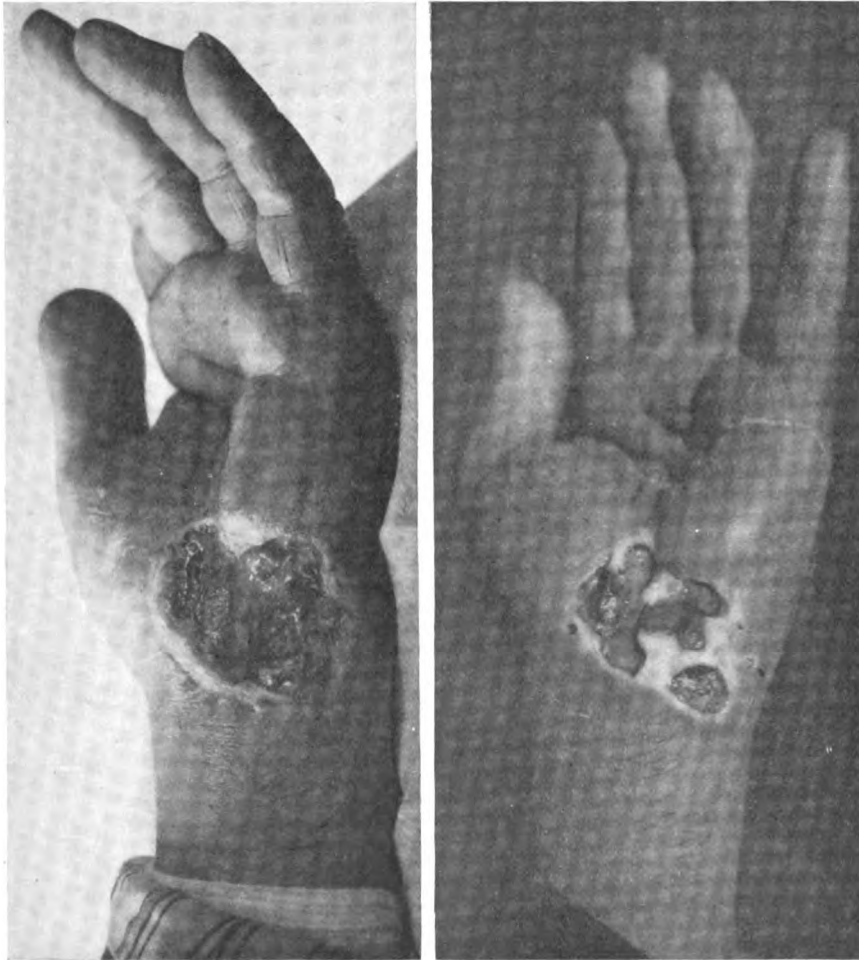

FIG. 359.—Chronic ulcer of hand of several years' duration, showing improvement under X-ray treatment. Later, the ulcer extended rapidly and the hand was amputated.

situations are the axillæ, the hands, the feet, and the head. Wherever it occurs, it may be readily and permanently cured by X-ray treatment. Howard Pirie drew attention to this method of treatment, and published a number of cases which demonstrated the great value of X-rays in this disease. No more striking testimony to the efficacy of X-rays in therapeutics could be obtained than the results of treatment of this condition.

The writer has treated a number of cases with invariably excellent

results. The marked improvement in the condition after a few exposures is very gratifying.

Technique in the Axilla.—The arm is extended and placed over the head, the axilla being fully exposed. A circular aperture is made in a piece of lead rubber protective, and then a piece of lint is laid over the axilla, exposing the whole of the apex and the axillary hair. The tube-box with the tripod already described is brought close down to the skin, the apex of the tripod being on a level with the apex of the axilla. A full pastille dose is given, and at the end of fourteen days another exposure is given, a .5 mm. filter being employed for this and subsequent exposures. No improvement is noticed until after the second or third administration, when a slight reddening of the skin results, there being also slight irritation at this stage. The sweating slowly diminishes from this stage until a complete cure is obtained, four applications being usually sufficient to cure the condition. It is better to obtain the result gradually by the above method, though occasionally, when the dose has been heavier, a marked improvement may follow the first exposure. It is also well to aim at a partial effect only; a slight degree of sweating is practically a normal condition, and is what should be attained. If the sweating is completely stopped, a dry condition of the skin may follow, which may be troublesome. It is frequently noticed that the axillary hair is not completely depilated, which rather suggests that less than a full erythema dose is sufficient to destroy a large percentage of the sweat glands. The hands and feet may be treated in exactly the same way. The head requires to be dealt with carefully, otherwise a troublesome alopecia may result. Telangiectasis is an after effect in cases of hyperhidrosis treated by X-rays. This is almost certain to follow a severe reaction.

THE TREATMENT OF ENLARGED LYMPHATIC GLANDS

Enlarged Glands may be described as (a) simple inflammatory; (b) tuberculous; (c) lymphadenomatous; (d) lympho-sarcomatous; (e) carcinomatous; the two latter being generally secondary to a lesion elsewhere.

Inflammatory Glands which come for treatment are generally chronic; they readily respond to the X-rays and diminish rapidly in size.

As these glands are frequently secondary to septic conditions elsewhere, a search should be made for the primary lesion, and this should be treated as well as the glands. If treated early, before suppuration has occurred, these glands will sometimes subside. If suppuration is present, the abscess should be opened, and afterwards a number of X-ray exposures will greatly facilitate the repair of the parts. This is particularly appreciable where an intractable sinus exists. It may be injected with bismuth emulsion, and a thorough irradiation given.

The treatment of **Tuberculous Glands** by X-rays offers a good alternative to that of removal by operation, and when operation is recommended a

few preliminary exposures should be given in order to induce inflammatory changes around the glands.

A group of enlarged glands which, either because of the wide distribution of the swelling or on account of suppuration already well advanced, render operation a serious matter, may be treated vigorously by weekly doses. In some cases treatment may be administered twice a week, then the dose at each sitting is reduced to $\frac{1}{3}$ or $\frac{1}{2}$ pastille dose. In the absence of more operative treatment suppuration should not be a contra-indication to X-ray treatment; such treatment should rather be pushed vigorously. When pus has formed it should be evacuated and the treatment continued. It is remarkable how some of the cases improve from the commencement of X-ray treatment. The action is undoubtedly a general and local one, the former appearing to exert a tonic effect upon the tissue metabolism.

Lymphadenomatous Glands are frequently treated by X-rays, and behave in much the same manner as tuberculous glands, sometimes disappearing rapidly or diminishing to a very small size. Their peculiar characteristic is that they tend to reappear, or rather, a group of glands will diminish in size, and after treatment is discontinued for a time the lumps become evident again, but whether they are the same glands or others which have become involved is a matter of conjecture. The practical point is that this type of gland is particularly amenable to X-ray treatment, but the treatment cannot be definitely described as a curative one until months or years have elapsed without recurrence. The experience of most workers is that ultimately recurrence takes place, and the patient dies from the disease. The probability is that a percentage of the cases which are cured may have been of the simple inflammatory type.

The treatment must be thorough; areas in which glands are evident should be treated. It is a good plan to treat all the areas involved in rotation, taking care to cover as wide an area as possible at each treatment. In this way it is possible to secure a rapid response to treatment. The irradiation should be continued long after the patient appears to have recovered. It is possible that in a number of the cases where there has been recurrence, efficient after-treatment has not been carried out. A dose once a month for many months will not harm the patient, and it may possibly keep up the beneficial action of radiations.

Recently, by using hard rays and aluminium filters, 1 mm. to 2 mm. thick, it has been possible to give more frequent doses, and a marked improvement in results has been obtained.

Enlarged Sarcomatous Glands may be a manifestation of lymphosarcoma or secondary to a primary sarcoma in an adjacent part of the body. In the former, the treatment of the local condition must be pursued as well as of the deposits in the mediastinum. Frequent dosage with hard rays is indicated. The glands slowly diminish in size, but hardly ever return to the normal condition; sooner or later the glandular enlargement increases, and in spite of treatment the patient succumbs to the disease.

Secondary deposits of sarcoma in the glands yield to treatment for a

time. Several cases which have been treated by X-rays and radium have remained well for several years. The latter agent appears to have a decidedly beneficial action upon sarcoma. Several cases of recurrent sarcoma of the neck which appeared after operations for local removal of growth have been treated successfully with combined X-rays and radium. One case of such a nature recurred in the neck after three operations. The patient was treated with long exposures to radium, and the result was satisfactory; the recurrence disappeared. When last seen, four years after treatment, the patient was quite well.

Enlarged Carcinomatous Glands are generally secondary to a primary lesion in another part of the body, and may occur in any part of the lymphatic system. The primary lesion will be found in some adjacent part or organ. They differ from the preceding types of gland in that the growth is slower, they are generally not numerous, and may be confined to one particular chain of lymphatic distribution, corresponding to the site of the primary lesion. They do not tend to suppurate. The skin may at a later stage become involved, and ulceration follow. The response to treatment is slow, marked inflammatory surface reaction being often necessary before an appreciable effect is noticed upon the size of the glands. In these cases it must be recognised that if benefit is to be received the possibility of damage to the skin must be partially disregarded, though all precautions must be taken to avoid it or to reduce it to a minimum.

But several cases have remained stationary until a degree of ulceration of the skin surface has been brought about. This will gradually heal, and at the same time the glands slowly subside. They seldom disappear entirely, but appear to become quiescent. In several patients, where such a change has been induced, it has been possible to remove the glands surgically, and continue the X-ray treatment afterwards. Several patients have been treated by radiations and large glands which did not respond have been surgically removed and the treatment continued. One striking case had three operations for the removal of recurrences, but the radiation treatment was continued, and this resulted in a complete recovery. The patient is still under observation nearly two years after the last operation.

The condition of a patient so treated is infinitely better than when the glands are allowed to enlarge slowly, involve the skin, and ulcerate. Once a carcinomatous gland arrives at the stage where it breaks down all barriers and reaches the surface, no amount of X-ray or other treatment has any effect. The technique is somewhat similar to that for tuberculous glands. Weekly doses with filtered rays may be employed, taking care to cover a wide area, and changing the area as frequently as possible. In advanced cases, with groups of greatly enlarged glands, it will be necessary to administer heavy doses at short intervals of time. This may be safely done when the rays are filtered through three or more millimetres of aluminium. Doses of 20 or 30 X Kienböck may be given to numerous small areas of skin covering the enlarged glands. In this way large aggregate doses of 200 to 400 X may be given to a group of glands at one sitting. After a suitable

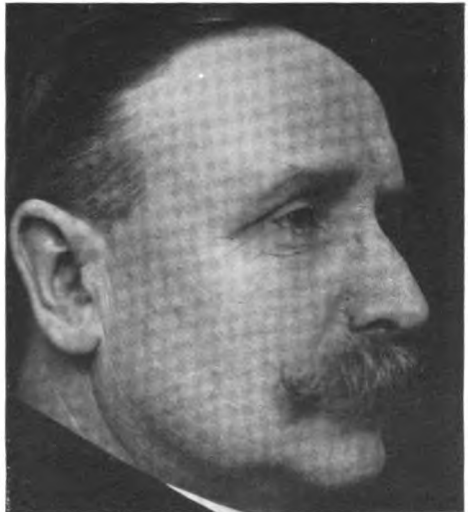

PLATE LXXXIII.—RODENT ULCERS TREATED WITH RADIUM, X-RAYS, AND CO₂.

α, Rodent ulcers on left side of face; these rapidly healed after radium exposures and remained healed. This patient has not returned for treatment in the interval which has elapsed since publication of first edition. There is therefore reason to believe that the ulcers continue to remain healed.

β, Small rodent ulcer of right side of nose, healed all but a small area at the lower edge of the ulcer; this has been most intractable to X-rays, radium, and CO₂. The condition ultimately healed, and the patient has not returned for further treatment.

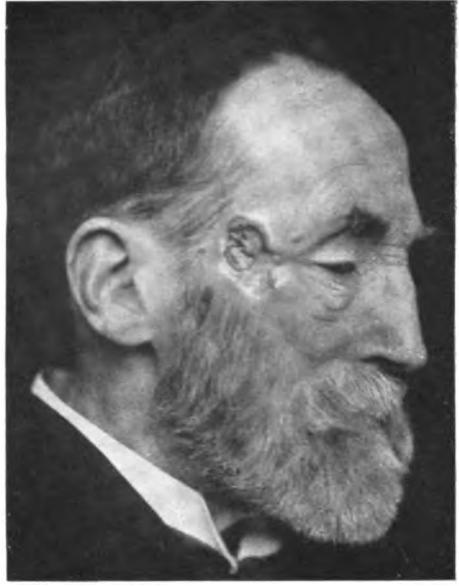
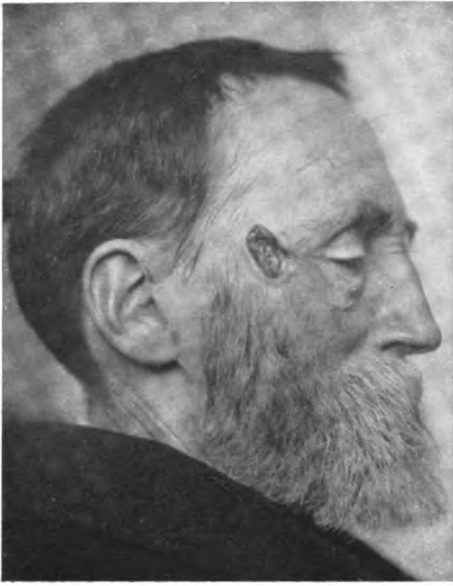

PLATE LXXXIV.—CASES OF RODENT ULCERS TREATED WITH RADIUM.

a, b, Illustrates a case which has resisted all forms of treatment, including X-rays, radium, CO₂, and ultra violet radiations from a mercury vapour lamp; several intensive doses of X-rays appeared to induce healing of the ulcer for a time. Recurrence took place at the lower edge; this rapidly extended until the lower half became ulcerated. This patient has been under observation for over three years. The progress of the disease has been steadily downwards notwithstanding all variations of treatment. The disease extended deeply, involving the bone, which subsequently separated, and the patient died from exhaustion.

c, d, A case which yielded to treatment. *c*, Before treatment. *d*, Towards the end of treatment the ulcer completely healed; recurrence after many months quickly responded to further treatment. The patient has had several recurrences, each of which quickly heals after radium has been applied. When last seen the condition had practically healed under frequent small doses of X-rays— $\frac{1}{8}$ p.d. weekly—extending over several months.

interval, depending upon the degree of reaction and the urgency of the symptoms, the dose may be repeated.

THE TREATMENT OF RODENT ULCER

The treatment of rodent ulcer by X-rays has yielded many good results. When the disease is superficial a marked improvement is quickly obtained. The tendency in all cases is for recurrence to show itself, and adequate steps must be taken to endeavour to prevent this recurrence. This can best be done by thorough prophylactic treatment after the ulcer has disappeared, though even then disappointment will occasionally be met with. In some cases, in spite of most thorough prophylactic treatment, the scar breaks down and the resulting ulcer spreads.

When bone or cartilage becomes involved the difficulty of healing the condition is great. Sometimes the ulcer heals and remains well for long periods. This indicates that in the particular case adequate treatment has been carried out. The exact rationale of the treatment is somewhat difficult to follow. Why some cases do well and others do not is not yet understood.

Two cases may be quoted to illustrate this point.

Rodent Ulcer on Left Side of Face.—Mrs. E., 57 years of age. From December 1908 to March 1910 she received about fifty radiation treatments. The condition gradually improved, but as soon as treatment was stopped the growth resumed an active form. On March 11, 1910, she had a short exposure with radium. The part treated improved greatly for a time. The ulcer was ultimately excised. This is a type of slow-growing rodent ulcer which does not respond readily to any form of treatment.

A Small Rodent Ulcer on the Right Side of the Face in line with the Orbit.—R.M., 41 years of age. The growth had been noticed for twelve months prior to treatment. It had been cauterised on three occasions without any apparent benefit. From September to December 1909, sixteen radiation treatments. The surface healed over and had a depressed appearance in the centre of the cicatrix. The edges remained smooth. It remained well until April 1910, when the anterior edge resumed activity, and slowly spread. Several radiations resulted in a cure for a time at least. The last treatment given resulted in a fairly active dermatitis, which seemed to have the effect of healing the active portion of the growth. This case responded remarkably well to X-rays, and affords a great contrast to the preceding one. It illustrates the point that the earlier these ulcers are subjected to X-ray treatment, the better is the prospect of a cure.

Very superficial ulcers heal readily and remain healed for long periods. The position of the ulcer appears to determine the result in some cases; when situated on the cheek, away from the orbit and clear of mucous membrane, the ulcer will readily yield to treatment; when situated near an angle at the junction of skin and mucous membrane, such as the angle of the mouth or orbit, the difficulty of equal and adequate treatment becomes greater. It is often impossible to get the rays equally spread over the whole of the ulcer, and if there is inequality of the surface the same appears to apply. It is also possible that many of the cases which do not heal under

treatment have been treated with the wrong quality of ray. We must remember that the X-ray beam is heterogeneous. Consisting as it does of a bundle of rays of unequal penetration, the beam from any given tube may contain rays of from, say, 5 to 12 Bauer. The preponderance of value 4 may be sufficient for the stimulation of the tissues of a particular ulcer while it would have no effect upon another. It appears reasonable to assume that in some instances we accidentally use the ray of the greatest value for the case under treatment, while on another occasion, using the same tube in the same condition on another case, the result will be quite different. It would appear that up to the present the bulk of the therapeutic work done with X-rays has been more or less haphazard. This no doubt explains the varied results obtained. An effort must be constantly made by each operator to standardise his apparatus in such a way that he may be able to produce at a given time, approximately at least, a particular quality of ray for a special purpose.

The frequency of the applications must also have a direct influence on the result, some operators preferring to wait three or four weeks before repeating an exposure, while others do so at the end of a week. The obvious course to pursue is to observe carefully the condition requiring the treatment. If the ulcer is growing rapidly extreme measures must be adopted. The dose should be the maximum possible and should be repeated at the earliest convenient date. The edges of the ulcer may be given an excessive dose by protecting the less active part with lead rubber; the healthy skin, all but that close to the edge of the growth, must also be guarded. The degree of reaction induced will depend upon several factors, (a) the duration of the exposure, (b) the hardness of the X-ray bulb, (c) the filtration employed; each of these factors must receive special consideration.

In superficial conditions the first dose should be given unfiltered, and a full pastille dose given. If possible, it is well to wait for fourteen days before repeating the exposure. This allows the operator to determine the degree of reaction the tissues possess. If, however, the growth threatens to spread more rapidly, a further exposure must be given at once, and this one should be filtered. In these cases, when further doses are required at short intervals, the thickness of the filter should be increased for the later exposures. It is well to bear in mind that it is possible to stimulate a growth by X-rays and to get a harmful rather than a beneficial influence exerted upon it.

If, in spite of ordinary full doses of X-rays, the ulcer goes on steadily increasing, what more can be done? The obvious course is to increase the dosage further. In special cases where time appears to be of value two or more pastille doses may be given at once, the healthy parts being well guarded. The case illustrated shows the value of this method (Plate LXXXIV., Fig. a). A rodent ulcer on the right side of the forehead resisted all forms of treatment by X-rays, radium, carbonic acid, and high frequency. It gradually extended, especially at its lower border. Two unfiltered doses were given, and at the end of a week two more were administered, treatment being then

suspended for several weeks. The ulcer healed over the whole of its surface, a thick crust forming at the lower angle. The patient imagined he was cured and did not return for more than three months ; at that time the crust formed at the lower edge of the ulcer had led to ulceration below its surface, which was slowly spreading. Further treatment led to a marked improvement in the condition, but completely failed to heal the ulcer.

After an ulcer has been healed it is necessary to continue treatment. Repeated doses may be administered at intervals of several weeks, filters being employed and a harder tube used. By these means it may be hoped to obtain an effect upon the deeper structures which may contain remnants of growth. The fibrosis induced by treatment should arrest the growth of these remnants.

In obstinate cases it is wise to vary the remedy employed. Thus radium may be used or a pencil of carbon dioxide snow applied to parts of the ulcer. The high-frequency current will sometimes give the necessary stimulus to parts of the ulcer. A preliminary exposure to the mercury vapour light, followed by X-ray dosage, sometimes aids the process of healing. The light appears to increase the superficial circulation, by congesting the parts ; the secondary radiations may be induced by the direct action of the X-rays on the fluids circulating in the vessels of the growth.

The distinction drawn between rodent ulcer and epithelioma is more or less an arbitrary one, many of the ulcers which we call rodents really being from the beginning epitheliomata, this difference, no doubt, in part accounting for the wide variations in the result of treatment, the epitheliomata being more resistant to treatment by radiations. The latter growths tend to spread to the deeper parts and involve the tissues below the skin. When cartilage and bone become affected the difficulty in inducing healing is greater. Much more penetrating rays should be employed, and longer and more frequent exposures given. In some cases it is well to combine surgical measures with the X-ray treatment. When possible, the more or less complete eradication of the ulcer, followed by thorough X-ray treatment, appears to be the most rational method that can be employed.

The Treatment of Epitheliomata

These tumours, when seen early, and more especially when they involve mucous membrane, should be promptly excised. After-treatment by X-rays should be employed, and should cover a wide area to include the lymphatic distribution of the affected part. Should the patient refuse operation, radium should be the next choice, and failing the possibility of treating by this remedy, X-rays should be used, or radium and X-rays together or alternately. It is important to keep the patient under observation for a lengthy period. (See Radium in the Treatment of Epithelioma, page 526.)

Epithelioma involving the skin only is more amenable to X-rays and radium. A few exposures should be given previous to operation, if this be decided upon, and continued after the removal of the active growth.

THE TREATMENT OF SARCOMATA AND CARCINOMATA

Sarcomata, other than glandular, may require to be treated. Such, particularly the round-celled variety, when situated in the soft parts of a limb or in bone, respond readily to treatment, and diminish in size or may to all outward observation disappear. The tendency is for recurrence within a year or so, and often in the deeper structures, particularly in the mediastinum or lungs. The after-history of these cases is very little, if any, worse than in the operative cases, where recurrence is almost certain to take place within two years.

The advantage of the operative method over treatment by radiations is that the patient is saved from the local discomfort of a growth which in the end breaks down and forms a sloughing ulcerated sore. Two cases may be quoted to illustrate this point, one that of a girl who had a primary sarcoma of the humerus which practically cleared up under X-ray treatment. Recurrence took place in the left hip-joint, but before the patient died the primary tumour reasserted itself and formed a large sloughing sore.

In the second case a primary sarcoma of the right humerus was removed by operation, together with the shoulder girdle and upper limb. Recurrence took place after two years in the mediastinum and lungs.

Carcinomata.—The majority of the cases of malignant disease treated by X-rays belong to this group. Marked improvements have taken place in results in recent years. This has been largely due to two factors: (a) a better technique, and (b) the earlier treatment of many of the patients.

The improvement in X-ray technique has been very great of late years, the use of larger tubes of great penetrative power, together with an improvement in the construction of coils, transformers, and accessory apparatus, having made it possible to greatly increase the dose given. The use of filters of a thickness of $\frac{1}{2}$ to 3 mm. of aluminium, or its equivalent in other materials, led to the use of a penetrating ray which could be used to give large doses with practically no effect upon the skin surface. These large doses have been extensively used in the treatment of carcinoma, with very marked improvement in the results obtained. The beneficial effects of X-rays upon uterine myomata encouraged workers to try similar methods in the treatment of all kinds of carcinoma, both superficial and deep. If the skin surface is divided up into small areas, the dosage in a particular case may be increased to a marked extent; 1000 X Kienböck may be administered in a short time to a tumour. In deep-seated carcinoma of the uterus the treatment employed should be administered by two routes—the perineal and the abdominal.

The methods of treatment may be divided for practical purposes into four main groups:

- (a) Prophylactic, before and after operation;

(b) Curative efforts in primary growths, which should consist of thorough irradiation of the growth, enlarged glands and the adjacent lymphatic area ;

(c) Treatment of recurrences of all degree ;

(d) Palliative treatment of cases where all hope of cure has gone.

These groups require lengthy discussion.

Before Operation.—In all cases where time permits a number of X-ray exposures should be given. The first exposure may be given unfiltered and later ones should be passed through .5 mm. of aluminium.

There should be no delay in performing the operation, but, usually, a few days elapse between diagnosis and operation, and during these one dose at least may be administered. The whole area of the growth should be well irradiated and then the area of lymphatic distribution spreading from the growth should be fully exposed to the rays. Thus in carcinoma of the breast the whole breast may be treated with one dose, or, if the tumour is large, the breast may be divided into four areas and four exposures given. This method will be described later. The axilla should get a full dose. This exposure will have the effect of epilating the axillary hair and will exert an action upon the sweat glands, causing a diminution of the secretion of sweat, an effect advantageous in keeping the axilla clean after the operation. When time permits a second filtered dose may be given over the whole of the areas previously treated.

At the Time of Operation.—The wound, after removal of the growth, may be irradiated before the sutures are introduced. This method of treatment has been tried by a number of workers, notably by several well-known American radiologists. It has been allowed to lapse, because in the experience of these workers it offers no advantage over treatment soon after the operation, when the first dose may be administered while the patient is still under the anæsthetic, but the wound has been closed and the dressings fixed. The obvious disadvantages of the open-wound treatment are : (1) Prolongation of the anæsthesia ; (2) exposure of an open wound to the rays by means of an active bulb, which attracts dust, and with it microbes which may be in the atmosphere of the room ; the negative pole of any electrically excited machine tends to attract dust particles and deposit them in its vicinity, thereby increasing the danger of sepsis. When the open method is used, care should be taken to protect the wound by sterile dressings.

Post-Operative Treatment.—In cases which have had the preliminary exposures this should be continued as soon after operation as possible. In cases which have not had the preliminary treatment, the same routine should be employed. The following description therefore applies to both cases.

As soon as possible after the operation the patient should be irradiated over the whole of the areas already described. It is of extreme importance that a thorough routine method should be employed. The difficulty lies in the fact that unless great care is exercised to irradiate the whole area equally, portions of the surface may not get a full dose. In the experience of the writer recurrence has taken place in areas which have escaped treatment. An attempt must be made to elaborate a technique which will give

an equally distributed dose all over the breast area, axilla, supra-clavicular region, and well down below the costal margin. A method similar to that used in the treatment of the scalp for ringworm might be employed. The whole of the area to be treated should be mapped out and central points selected which will get the maximum dose. Spreading from these points to the periphery of the area the rays diminish in a definite proportion. The peripheral areas of each exposure should overlap so that that part of the skin receives a half dose from each adjoining exposure.

Points should be selected at equal distances in the mid-mammary line, extending from the costal margin to the clavicle and upwards, to take in the supra-clavicular region. A number of corresponding points should be marked out in the mid-axillary line, and, each point being taken as the centre of the exposure, it is possible to give an equally distributed dose over the whole area. The axilla should in addition have a dose from its posterior aspect.

The first series of doses may be given unfiltered. The object of giving the first dose unfiltered is to produce as early as possible a degree of reaction in the line of the scar, or in the raw surfaces of the wound if the treatment is commenced before the wound has healed. It is then possible to treat with a "softer tube" than when the filtered ray is used. It is quite possible to produce an effect by using filtered rays from the commencement of treatment, but then larger doses must be given to induce the same effect on the superficial structures. Russ has shown experimentally with radium rays, filtered and unfiltered, that the same effect may be induced upon the skin with Beta rays and Gamma rays if the incident dose on the skin is the same. In view of this result there is some ground for the contention of some radiologists that prophylactic treatment should be carried out from the beginning with rays filtered through 3.5 mm. of aluminium. This method has the advantage that the deeper structures receive from the outset maximum doses of penetrating radiations. In so far as the chief object of such treatment is, if possible, to check the spread of the disease in outlying parts, there is much to be said in favour of a technique of this nature. It has been found by the author, Kempster, and others that when treating superficial epitheliomata better results are obtained when what has been described by Kempster as progressive filtration is employed than when filtered rays are employed with a uniform thickness of filter. In these cases the first one or two doses are given without a filter, while succeeding doses are given through filters progressing in thickness. In the light of this experience it would appear that a combination of the two methods might be employed, namely, the first dose along the line of the scar unfiltered, succeeding doses being given through aluminium filters, the regions remote from the scar, axilla, supra-clavicular areas, anterior and posterior, receiving doses through 2 or 3 mm. of aluminium.

In extensive cases, where the operation has not been so complete as could be wished, the whole area should be heavily treated with hard rays. The area covered by the radiations should be very wide, to include all possible

lymphatic distribution. The thorax should also be irradiated with hard rays in the hope that extension to the deep glands may be prevented.

In cases occurring in young patients where the growth has been removed by an extensive operation, it has been found that recurrence is almost sure to take place even after very thorough X-radiation. Intensive dosage should be employed in such cases in the hope that the disease may be arrested. This intensive treatment means heavy dosage with hard rays over as large an area of tissue as possible; when patients are in the hospital daily treatments may be given for 3 or 4 weeks. The regions to be treated should be carefully marked out until as many as 20 or 30 of these are ready for exposure. Two or three of these are exposed daily, changing to new areas each day. By the time the whole region has had a thorough dose, it is possible to recommence at the first area treated, and so continue until sufficient has been done to produce some constitutional disturbance. In those young subjects the ovarian regions may profitably be included in the areas treated. It is possible that by inducing a temporary artificial menopause the functional activity of the glandular structures may be so altered as to favour the formation of fibrous tissue and subsequent atrophy of the active cells of cancer which may be lying dormant in these structures. Several cases treated in this way appear to have derived considerable benefit.

In the average run of cases at the end of two weeks or more a second series of doses may be given, using a .5 mm. aluminium filter. Later doses should be administered according to the degree of reaction which results. In all, twelve exposures to the whole area should be given, the later irradiations being given at longer intervals. Towards the end of the series the interval should be about three weeks, and for the later doses thicker filters should be employed.

At the end of a series consisting of a dozen visits the patient should be allowed to cease coming for treatment, but should be kept under observation for several months or even years in order that the earliest appearance of recurrence may be promptly dealt with.

A useful routine for the use of filters is to give the first dose unfiltered, the second, third, and fourth with .5 mm. filter, and then to proceed to 2 mm. for three or four doses, and 3 mm. for the later exposures, the object of the filter being to protect the skin as much as possible, and to exercise an action on the deeper structures by penetrating to the deeper layers of the skin and the deep tissues.

The results of prophylactic treatment by X-rays are encouraging. The effect is marked from the first. The patient has less pain, the movements of the parts are facilitated, and the scars are more pliable at an earlier date than when no treatment is carried out. The general tonic action of X-rays upon the metabolic processes is noticed, patients feel well and the general health is improved by the treatment. That recurrence may be prevented is fairly well established, especially in view of what we know to occur when early recurrences are treated. These undoubtedly disappear after treatment, and it is logical to assume that remnants of cancer left in the wound may

disappear in the reparative changes set up in the surrounding tissues by X-ray treatment when the treatment has been efficiently carried out.

Treatment of Inoperable Carcinoma.—The technique in the treatment of primary growths, unsuitable for operation, being similar, the description under (a) applies to both groups. A classification is necessary in order to describe fully the methods employed.

(a) *Large inoperable cancer* of the breast without ulceration is fairly common. An attempt should be made to reduce the tumour by treatment to an operable condition. When the tumour in the breast is very large a system of treatment may be used which will give the dosage on a limited area. The breast is divided into four or more areas by means of a lead-rubber screen marked out as follows: A square of thin material is cut to cover the whole breast and a margin of tissue beyond; this is divided into four equal parts, and one segment is cut out. Two points are marked on the skin at the upper aspect, and the upper limits of the screen are placed on these points. An exposure is given through the segment which has been removed. The screen is then moved round one segment and the exposure repeated. This is done until the four areas have been treated, the tube in each instance being directed towards the centre of the breast. This method has been successful in several cases, the tumour rapidly diminishing in size.

The gratifying results obtained in the treatment of uterine fibromyomata by the intensive method of dosage have led to marked improvements in the technique of the treatment of carcinomata. A filter of 3 mm. is used, a secondary filter consisting of two or more layers of loofah sponge enclosed in several layers of lint being used to protect the skin. The area to be treated is marked out into a number of small squares. Lead is used to protect the adjacent areas during the exposure. As many as twenty areas may be mapped out to cover the region requiring treatment, each area receiving from 10 to 20 X on the Kienböck scale. It is safer, however, to keep to the minimum skin dose over each area, and to trust to the production of a large deep effect by using as many areas as possible, each being pointed towards a common centre. In this way a relatively large dose is administered to the affected area. The tube used is of the hardest possible penetration, 10-12 Wehnelt. The patient should be kept at rest for a day or two after the administration of the rays. The dosage may be repeated in from two to three weeks, or at shorter intervals if there are no untoward symptoms shown. These large doses of X-rays appear to exercise a marked influence over the diseased tissues. Continental workers claim marked improvement in cases treated by the intensive method. It is possible that with further improvement in X-ray tubes, the results produced may be still greater.

Exposures through thick filters may be given twice a week in serious cases. Several layers of chamois leather should be laid upon the skin in order to prevent secondary radiations damaging the skin.

(b) *Ulcerated growths* should be treated by a modified method. An ulcerated surface will stand more treatment than the unbroken skin, and there is no need to attempt to protect it. The healthy skin around the

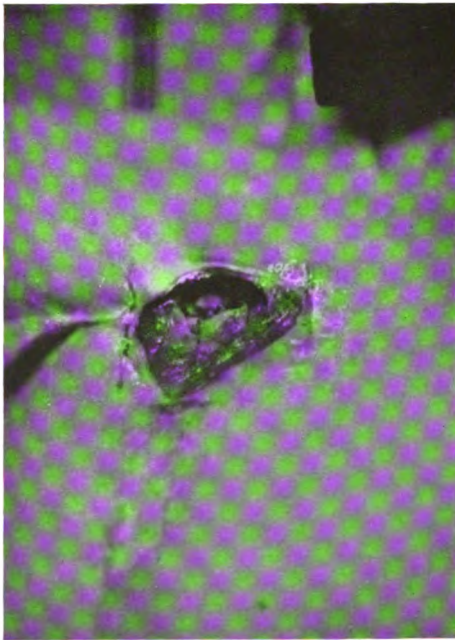
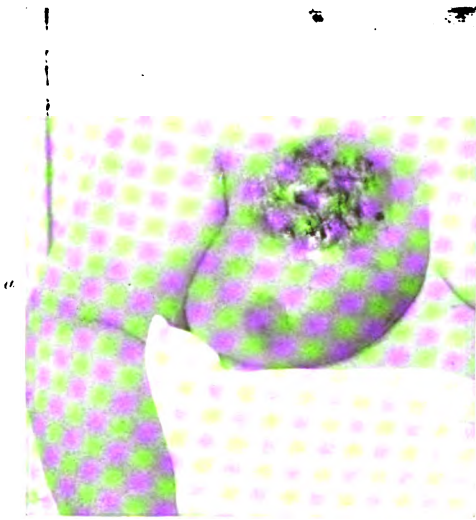

PLATE LXXXV.—CARCINOMATA TREATED BY X-RAYS.

a, b, Primary growth, a large ulcerated carcinoma of right breast which improved for a time after being treated by a prolonged series of X-ray exposures.

c, d, Recurrent growth in scar after operation for removal of carcinoma of right breast. Successful treatment by X-rays.

This is one of the very early cases treated at the Cancer Hospital, when small unmeasured doses were given at frequent intervals over a long period of time.



PLATE LXXXVI.—STAGES IN THE TREATMENT OF AN ATROPHIC SCIRRHOUS CANCER OF THE BREAST.

a, Before treatment. *b*, Growth commencing to ulcerate. *c*, Growth nearly all gone. *d*, Healed. Recurrence took place at the lower end of the scar, and the disease in the end spread rapidly. The patient has since been lost sight of. The above is one of the most successful of the large number of cases treated, and it illustrates the value and limitations of radiation treatment when dealing with cancer.

ulcerated surfaces, all but a narrow margin surrounding the ulcer, should be protected.

Frequent irradiations are given to this area until it shows signs of breaking down. In the end the cancer mass sloughs and leaves healthy tissue behind, this closing up and occasionally healing.

The illustrations shown are from two cases treated in this manner. Figs. *a*, *b*, *c*, and *d* in Plate LXXXVI. are from a case treated on the lines indicated above. They show the progressive changes induced, viz. sloughing and gradual repair of the resulting ulcer. At one stage this tumour received radium treatment.

Fig. *a* in Plate LXXXV. is from another case which is showing marked improvement under X-ray treatment of the intensive type.

The treatment of recurrent cancer when the growth has reached a large size may be carried out on precisely the same lines as that for primary cancer. Many cases could be quoted where undoubted benefit has resulted from thorough X-ray treatment.

(*c*) *Recurrent Cancer*.—These cases form a large percentage of the patients one is called upon to treat. The condition varies from the melon-seed variety to large nodules of cancer. All cases do not respond equally to treatment, a number going steadily from bad to worse. As a general rule, the instances which occur in young women under 35 years of age do not respond well to treatment; after that age, if treated early, the chance of a good result is much greater.

In this class of case the treatment should be pushed vigorously until a marked reaction is obtained all over the affected surface and well beyond it. When the reaction shows itself the seed-like bodies slowly subside. Repeated crops may require to be treated in the same patient. Several cases of this type have been undergoing X-ray treatment for two or three years at regular intervals.

THE TREATMENT OF ENLARGEMENT OF THE PROSTATE GLAND

Of late years this condition has been treated by X-rays and radium. The enlargement, if simple, is an hyperplasia of the glandular elements, a condition which should be amenable to therapeutics. It must not be overlooked, however, that in some of these cases there is a large fibrous element in the growth, and this may be fairly dense in structure. Further, these conditions may be complicated by the presence of stones or calcified matter in the substance of the gland. The presence of a commencing new growth has also been shown in what was otherwise to all appearances a simple enlargement of the gland. Cases for X-ray treatment must therefore be carefully selected in order to avoid bringing discredit upon the method of treatment. No doubt can exist as to the brilliant results obtained in this condition by operative measures, and the writer is convinced that

X-ray or any other palliative form of treatment will never take the place of early operation.

With the reservation indicated, good results have been obtained by both X-rays and radium. It is a matter of general observation that when so treated the condition of patients is ameliorated, the control of micturition is re-established in some cases, and prolonged treatment results in a marked diminution in the size of the gland. Large prostates may by this line of treatment be reduced to an operable size. Even in the cases which are operable, circumstances may exist which indicate a palliative line of treatment rather than the radical one of removal. The patient may refuse to take the risk of an operation, or his condition may be such that an operation would be extremely hazardous.

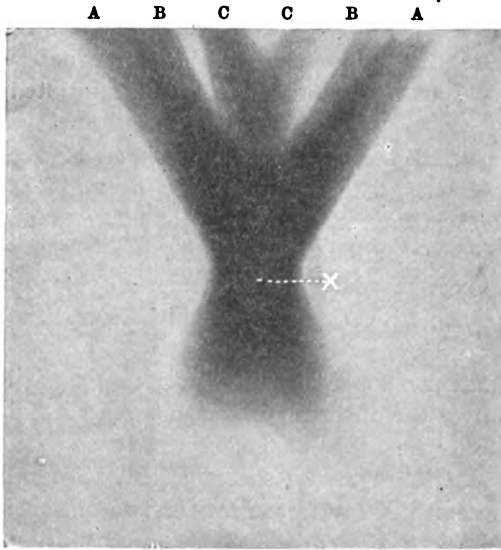

FIG. 360.—Showing the projection of rays into a deep part by means of the rotating tube.

A, B, C. Three circles upon the skin surface, one within the other, showing the rays focused upon the point X.

fore, receives a full dose at each sitting. After three or four doses with this thickness of filter it will be found necessary to increase the thickness to 3 mm. and later to 4 mm. or more.

The skin must be carefully watched for reaction. Should this be excessive the treatment must be suspended for a time by that route, and the suprapubic route may then be utilised. A compressor should be employed and the tube brought well down towards the pubis, a cylinder compressor being a good one to use. The gland can thus be irradiated from above for several doses, and then the perineal route can be tried. In this way it is possible to keep on with treatment for a considerable length of time. Improvements generally begin to show after three or four doses, and as a result of the increase of comfort the general health of the patient improves greatly.

The technique is similar to that for other deeply-seated structures; two routes are available, both of which may be employed in the one case. The perineal route is preferable. Hard tubes should be employed and filters used from the commencement of treatment. It is important to prevent the occurrence of even slight reaction as long as possible in order to get a sufficient dosage into the deep structures.

Commencing with a 2 mm. filter, a pastille dose at the half distance may be given weekly. The pastille is used on the distal side of the filter, and the patient, there-

An alternative method of treatment, and one likely to take its place, is the following: a large amount of current, 4 to 5 milliamperes, is passed through a hard tube, 10 Bauer, a 3 mm. aluminium filter being employed, and the dose measured by Kienböck paper. At least 10 X on the skin surface is given, the perineal and suprapubic routes being employed with as many ports of entry as possible, so as to get in the maximum dose to the gland.

The rotating tube (p. 419) suggests itself as the best method for the treatment of the prostate gland. The "focus point" of the rays may, by its use, be centred on the gland.

THE TREATMENT OF EXOPHTHALMIC GOITRE

See also page 576.

The routine medical treatment by drugs has proved to be merely palliative, and operative treatment has not been marked by any striking successes. X-rays appear to offer a chance of better results than either of the two older methods. The rationale of the treatment by X-rays is difficult to understand. A purely local effect can easily be produced, but there must be a deeper and further-reaching influence induced by the rays to explain the undoubted improvement which takes place in these cases. In a disease which, grave in itself, is frequently accompanied by other conditions, such as rheumatoid changes in the joints and conditions associated with rheumatism, it is unwise to claim too much for X-ray treatment, yet in suitably selected cases good results may be confidently expected. The technique employed must be thorough. The gland when greatly enlarged offers a good field for the preliminary exposures, which should be given once a week and continued steadily until marked improvement results. Should reaction lead to a suspension of the local treatment, the radiations may be continued on the surrounding areas, particularly on the region of the cervical sympathetic. The action is apparently general rather than local, and therefore the area of exposure need not be limited.

Does treatment by radiations lead to changes in the gland secretion or in the blood serum, thus producing an amelioration of the distressing symptoms, or does the treatment restore the function of the gland to a normal condition? Whatever happens there is no doubt that many of the cases treated by X-rays are restored to a normal state of health.

The aim of treatment should be to slowly induce a return to the normal, consequently it will be found advantageous to proceed slowly with the treatment; in cases which are not very acute a dose once a week to one side of the neck will suffice. Alternate doses should be given to either side of the neck. It will be an advantage to employ filters, commencing at 1 mm. thick and increasing as the occasion indicates. Should the symptoms be very acute the dosage may be increased both in frequency and strength. A hard ray is employed, and this should be filtered through 3 mm. of aluminium. Three areas may be marked out over the enlarged gland, and each is given

10 X Kienböck. This may be followed in a week or ten days by another application. In more severe cases, which are confined to bed, it is a good plan to use radium rather than X-rays.

From experience of X-ray treatment in other diseases it would appear that, in order to maintain the improvement, it will be necessary to give regular doses of X-rays at intervals for a long period of time. Dr. Florence Stoney¹ in an interesting paper quotes results which are encouraging. She advocates X-ray treatment in preference to operation. "In 47 cases, 7 gave up treatment too soon, 14 were completely cured, and 22 derived great benefit. Under treatment which is pushed to the point of dermatitis, the pulse comes down to normal, the goitre in many cases, and the exophthalmos nearly always, disappearing. Tremor and perspiration are slow to yield but do so eventually."

The writer is strongly of opinion that this form of treatment should have a trial in all cases, even when operation is contemplated.

Since the above was written for the first edition a large number of new cases have been treated, and the results obtained are distinctly encouraging. In acute cases it has been found that treatment by radiations must be supplemented by (1) rest in bed, (2) dietetic treatment, and (3) treatment by drugs. The combined treatment is always more efficacious than either alone. Care must be also exercised to ensure the removal of all sources of infection, *e.g.* defective teeth. The best results have been obtained by the frequent administration of small doses of X-rays over a long period of time.

One-third pastille dose, estimated by the use of a Lovibond tintometer, through 3 mm. of aluminium, three times a week, may be safely given for many weeks in succession, care being taken to use thick secondary filters on the skin.

The improved results are obtained with practically no reaction on the skin surface, and in the treatment of such conditions, where the skin of the neck is receiving repeated doses, this is a most important matter. Should a moderate degree of reaction appear on the skin it will almost invariably be followed at a later period (after several years in a number of cases) by telangiectasis. No such misfortune has been observed when there has been no skin reaction.

The precautionary measures to be taken in the treatment of all conditions are, therefore :

- (a) Careful estimation of the dosage on each occasion.
- (b) Small doses given frequently.
- (c) Adequate filtration.
- (d) The use of a penetrating ray.
- (e) The use of secondary filters of leather, loofah sponge, or any material which will absorb soft rays.

(For treatment with radium see page 579.)

¹ "Results of treating Exophthalmic Goitre by X-rays," *British Medical Journal*, 1912

THE TREATMENT OF UTERINE FIBROMATA

The value of radio-therapeutic measures in diseased conditions is clearly demonstrated by the success which has been achieved in the treatment of uterine fibroids. These conditions would appear to offer an ideal field for the action of radiations, as from our knowledge of their action on superficial structures we find that hæmorrhage may be checked and fibrous and cellular structures readily reduced in size. The difficulty up to recent times has been to act on deep-seated structures in such a way that reduction in size of tumours may be induced without causing permanent damage to the skin which has to be traversed by the rays before the underlying organs can be reached. The credit of having successfully worked out a technique which enables us to attain that end is wholly due to Continental operators. Albers Schönberg, Haenisch, Bordier, the members of the Freiburg school, and others have elaborated techniques which may be safely used.

Whichever method we employ, and this point is so important that the principal of these will be described in detail, it is essential that the work should be done by a skilled radiologist in conjunction with a gynecologist, and not entrusted to inexperienced workers. Routine detail work must be done in every case if success is to be attained. All cases must not be treated indiscriminately, but a careful selection should always be the rule.

Indications for Treatment in Fibroma Uteri.—The indications for radio-therapeutic treatment depend upon the following factors :

(1) *Age of the Patient.*—All authorities agree that patients under 40 years of age should not be treated by X-rays, because before that age the treatment for obtaining an artificial menopause would be too long and tedious. Other factors to be considered at that age are obvious. There are exceptions to this rule, and patients below the age of 40 have been successfully treated. The menopause may be temporarily induced, the functional activity of the ovaries returning after an interval of time. During the interval the patient has the opportunity of restoring her health, and a marked improvement results. In cases of menorrhagia, arising from morbid conditions apart from fibroids, the treatment may be very beneficial. The upward age-limit is difficult to fix. The patient should be of such an age that her monthly periods still persist, or at all events these should not have ceased longer than a year. It is therefore between the ages of 40 and 52, or at most 55, that radio-therapeutic measures are indicated, though it must be noted that patients beyond these limits have been successfully treated.

(2) *Nature of the Fibroma.*—The interstitial form is the one most amenable to radio-therapeutic treatment, the pediculated or sub-peritoneal variety being better treated by operation.

(3) *Hæmorrhage.*—According to Bordier the most suitable are the fibromata with marked hæmorrhage, *i.e.* cases where the periods have been very copious, with abundant clots, or replaced by veritable hæmorrhage. As a rule, after the second cycle of irradiation marked improvement is

observed, the discharge diminishes in volume, and later may completely and permanently disappear.

(4) *Size of the Fibroma*.—Fibromata of moderate volume are more easily influenced than those of larger size, but larger tumours, reaching even to the umbilicus, may be considerably reduced in size. Very large tumours are, however, better suited for operation.

(5) *Hæmorrhage at the Menopause*. with or without fibroids is easily cured or relieved by radio-therapy.

Contra Indications.—Bordier is of opinion that radio-therapeutic treatment is not applicable :

(1) When the fibroma is calcified or presents necrobiotic degeneration. A radiograph of the pelvis should always be taken when there is reason to suspect that the former condition exists.

(2) When myomata are malignant, infected by septic organisms, or gangrenous.

(3) When complications exist such as suppurating salpingitis or pelvic peritonitis.

He also quotes the following results :

“After the second or third cycle of irradiation the patient entirely loses all discharge, the hæmorrhage as well as any colourless discharge from which she may have suffered. In the same time the volume of the fibroma will have begun to be reduced ; this may occur as early as the commencement of the second cycle. This diminution of volume steadily continues, and after the third and fourth cycle it is often found that the uterus has regained its normal size. It is not at all rare to see a fibromatous uterus, of the size of a fist, atrophy after three or four cycles of irradiation to such an extent that it can no longer be palpated through the abdominal wall.”

A large number of cases have been treated on the Continent and in America, and a more limited number have received treatment in this country. From a consideration of the results it would appear that a large percentage of cases received marked benefit, symptoms being relieved, and in many cases the tumour was so reduced that the uterus appeared to return nearly to the normal. How lasting the benefit may be has yet to be determined. At present the patient may be assured that she will receive no damage of the skin, at all events of a serious nature. Superficial reaction may occur in spite of all the care that may be taken. When using the large doses of the Freiburg school, it is possible that deep-seated changes may be induced over which we can have no control. Care must therefore be exercised not only in the choice of case for treatment but in the choice of technique we employ. It is well for the operator to master thoroughly one technique and confine his attention to it.

Technique for Uterine Myomata and Climacteric Troubles (*Albers Schönberg*).—(1) The tube must be maintained at a hardness of 6 to 8 Walter, or 8 to 9 Bauer, with a current of 2 to 3 milliamperes.

(2) The focus skin distance should be not less than 38 cm., and a compression diaphragm should always be used.

(3) A cycle of irradiations should be given consisting of a separate exposure on three areas—the centre and each side of the lower abdomen. This is best carried out by giving an irradiation, each of about six minutes, on three consecutive days. The whole cycle of irradiation must never exceed eighteen minutes.

(4) There should be an interval of at least fourteen days between each cycle of irradiation.

(5) A subsequent irradiation must be given only if the skin is quite pale and shows no sign of reaction.

(6) The skin of the abdomen should always be guarded by a thick leather filter.

Six minutes' exposure under the above condition is equivalent to 2 to 2.5 X. This would give 6 to 7.5 X for the three days' cycle, an amount well under the erythema dose of 10 X Kienböck.

Technique for Uterine Fibroids (*Haenisch*).—Wehnelt break. Penetration of tube 6 to 8 Walter or 7 to 9 Bauer, and a current of $1\frac{1}{2}$ to 2 milliamperes. Filter of thick sole leather or 1 mm. aluminium, with an addition of one to two layers of chamois leather.

Each series comprises four sittings, which are given on four consecutive days, preferably beginning just after the menses, a sitting lasting for from five to six minutes. The skin focus distance is 36 cm. Slight compression is used by means of the compression cylinder and a loofah pad.

During each series a total dose of 5 to 10 X Kienböck is reached. In the latter stages of the treatment the series often consist of three instead of four sittings. Between the series from fourteen to twenty-one days elapse.

When the tumours are very large, or in special cases when rapid effect is necessary, treat in several directions, *i.e.* on both sides, the centre, and also through the back.

Comparison of various units of measurement :

X = unit of Kienböck Quantimeter.

10 X = Sabouraud tint " B " or 5 H.

Technique for Uterine Fibroids (*Bordier*).—The X-ray irradiation is carried out in a series of cycles, each cycle comprising nine separate irradiations of the median region of the abdomen and the iliac regions. There are thus three ports of entry for the X-rays, one median and two lateral, the cycle of nine irradiations being given each month in the interval between the menstrual periods.

The two most important factors are, firstly, the dose of X-rays, and secondly, the filtration of the rays. Bordier's technique has at last been perfected so that the incident dose—that is the dose falling on the aluminium filter—shall be always the same, and easily measurable. All that remains, then, is to choose the appropriate filter according to the order of series and the precise number of the cycle.

As regards the median area, or port of entry, Bordier adds, always employ the same thickness for the aluminium filter, *viz.* 3.5 millimetres.

This region should always be carefully protected, so that the skin may not be injured in case a subsequent operation should be required.

As regards the lateral ports of entry at the flanks, the thickness of the filter will vary from $\frac{1}{2}$ millimetre to 3 millimetres. The aluminium filter, placed on the abdomen, is connected to the earth by means of a flexible metallic wire. The dose of the incident rays may be measured with great facility by means of Bordier's radiometer. The pastille is stuck on to the filter itself, and the dose to be given corresponds to the tint of Bordier, which is exactly equivalent to 5 H. The pastille should be compared with the scale by the light of a match, a candle, a benzine lamp, or other artificial light of slight actinic power.

The Röntgen bulb should always be placed at the same distance from the filter; a convenient distance is the breadth of the hand, the four fingers being interposed between the bulb and the filter. Bordier employs a water-cooled Müller tube 16 centimetres in diameter, regulated so as to emit rays of penetration 8° to 10° Benoist.

Filtration.—The following table shows Bordier's formula of filtration for each lateral port of entry of the X-rays on their way to the ovary :

INCIDENT DOSE ON THE FLANK 5 H

	Irradiation.		
	First.	Second.	Third.
	mm.	mm.	mm.
First cycle . . .	0.5	0.5	1.0
Second cycle . . .	0.5	1.0	1.5
Third cycle . . .	1.0	1.5	2.0
Fourth cycle . . .	2.0	2.5	3.0
Fifth cycle . . .	2.5	3.0	3.5

The dose incident on the filter being 5 H, and the absorbent power of the filter being known, it is easy to calculate the total quantities received by the right and left flanks respectively during each cycle. The time required to obtain the dose 5 H should not exceed five or six minutes.

During the irradiation of the lateral regions the median region of the abdomen is protected by a strip of lead, the edges of which should extend at least the breadth of two fingers to either side of the middle line.

The séances are to be given one each day. There should be an interval of at least three weeks between each cycle. As regards injury to the skin, even at the end of the fourth cycle of irradiations there is only a slight brown coloration; Bordier has in no case seen the slightest sign of radio-dermatitis.

Freiburg Technique for Uterine Fibroids.—Gauss and Lembeke of Freiburg employ a different technique; a summary of this is quoted below.

The methods employed consist briefly of a series of exposures given at one sitting, which lasts from two to three hours. These are repeated at intervals of three weeks. Three or four séances are sufficient to end in a

complete cure (it is claimed) in a large percentage of cases treated. The chief points are :

(1) The treatment of the abdominal wall. Great care must be exercised so as not to damage the skin.

(2) Many points of entrance are considered necessary. These are arranged so that a maximum effect is obtained on the deeper structures while the skin is not damaged.

The points taken are the umbilicus and the brim of the pelvis. A line drawn across the abdomen at the level of the umbilicus forms the upper limit of irradiation.

The mid-areas are treated with the tube at right angles to the body, the lateral areas with the patient turned on the side, and the tube pointed obliquely inwards.

Six areas are marked out on the back and the patient placed on the abdomen, the tube operating from above.

The skin is protected by means of T-shaped pieces of lead 2 mm. thick. These should be covered with lint to prevent secondary radiation effects upon the skin.

Several layers of satrap paper¹ are arranged on the surface of two or more layers of loofah sponge, and the whole is embedded in lint or paper. The Kienböck slip is placed on the skin underneath the above filters. The filter is laid over the area of exposure, and the tube is placed in a specially constructed efficiently protected tube-box, fitted with good mechanical movements. The distance between the anti-cathode and the skin should be 20 cm.

Ten to twelve areas may be treated from the front and six from the posterior aspect. An aluminium filter of 3 mm. thickness is used. The dose to each area should be 10 to 20 X. Taking 18 areas at say 15 X this gives 270 X at one sitting. After-effects must be looked for when using these large doses. The patient should be kept in bed for a day or two after the treatment.

The time taken to obtain 10 to 20 X on the skin will depend upon the hardness of the tube used and the quantity of current passing through it.

At Freiburg the usual method employed is to give five minutes to each area, 5 to 6 milliamperes being passed through a tube of a hardness of 7 to 9 Bauer.

It is not necessary in the treatment of fibroids to adhere rigidly to the Freiburg technique, and as the treatment of very small areas entails a

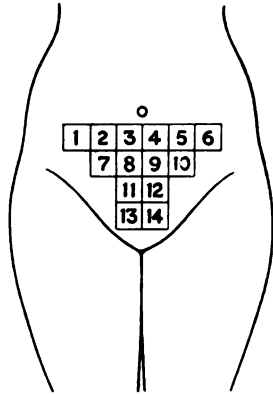

¹ Satrap paper is a photographic paper which has been exposed to radiation and developed. It is mentioned here because Gauss and Lembcke used it in their preliminary experiments, and later in the therapeutic work. Any pure paper is quite good enough for the purpose. It is not necessary to use paper if an efficient substitute is employed. Chamois leather in several layers is quite sufficient when used with the loofah sponge (see Filter Equivalents, p. 439).

considerable expenditure of energy and time, the areas may be made larger; six instead of twelve to the anterior aspect will in a number of cases be sufficient. Cases will vary in the rapidity of response according to the size of the tumour, the age of the patient, and the biological effect produced upon the tissues. A number appear to improve from the commencement of treatment, while others are to all appearances worse for a time. The hæmorrhage may be aggravated for a period or two, but, if the treatment is continued, the improvement sets in after the third or fourth series of exposures. Some of the cases show a comparatively rapid diminution in the size of the tumour, while others show hardly any diminution for a considerable time.

It is not necessary to develop the paper for each dose. The total

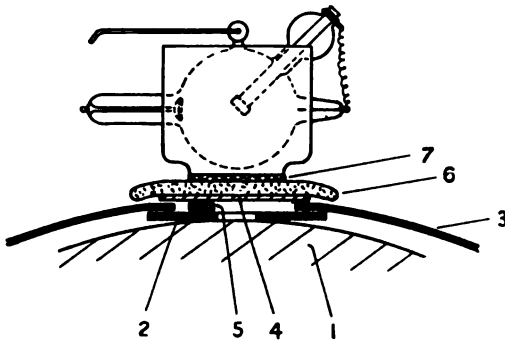

FIG. 361.—Arrangement of the tube and filters.

- | | |
|------------------------|----------------------|
| 1. Body of patient. | 4. Satrap paper. |
| 2. Lead square. | 5. Kienböck strip. |
| 3. Lead rubber screen. | 6. Loofah sponge. |
| | 7. Aluminium filter. |

number exposed should be developed at the end of the sitting, and the total dose can be easily ascertained at a later period. The method of Kienböck gives us a means of obtaining a permanent record of the total dose given. When employing this method of measuring the total dose, it would be well to check the dosage by the use of a Sabouraud pastille, either on the skin or at the half distance.

Specially selected tubes are necessary, and a good supply of tubes must be at hand. These may require to be changed frequently, especially in the early stages of their use. Later on one tube may give several doses in succession. A thorough system of cooling must be employed.

THE TREATMENT OF DISEASES OF THE BLOOD

Radiations either of X-rays or radium are used in the treatment of diseases of the blood, with in some cases a marked improvement in the condition. It is impossible to deal at any length with all the conditions of alteration in the blood and the associated changes in the spleen and bone marrow. A short résumé of some of the conditions calling for radiation treatment will suffice for the present, particular attention being paid to those which are known to respond to these radiations. The technique used will vary in individual cases. Hard tubes should be employed, and if repeated radiations are necessary, filters should be used.

In the treatment of a condition which is general in its effects and of which the pathology is obscure, or where the morbid changes originate in the spleen, glands, and bone marrow, the rational plan is to treat large

areas of the body rather than to centre upon one particular organ such as the spleen.

This plan allows of much larger doses being administered and prevents the occurrence of any local damage, which may easily be caused when one organ or area alone receives the irradiations. In these cases the skin is apt to be seriously damaged and treatment has to be suspended.

On general principles, therefore, it is well to give the splenic area a thorough irradiation and then proceed to deal with other regions. When the spleen is greatly enlarged the skin area over it may be divided into several sections, and each receive a dose in turn. The ends of the long bones may be treated through the surface by using hard tubes and filters. The glands of the axilla, groin, and neck may also be thoroughly irradiated.

Duration of Treatment.—At the commencement of treatment a dose may be given twice a week for about six weeks. Care should be taken to change the areas as frequently as possible. Treatment is then suspended for two or three weeks. At the end of that time one or several doses may be given, and the patient kept under observation for another three weeks.

In treating leukæmia, etc., a careful watch should be kept upon the blood, counts being made at regular intervals. A differential count should always be made. Cases which respond well to treatment should be carefully watched over long periods of time, and on no account should treatment be entirely suspended for any length of time. These cases relapse even when regular treatment is carried out, but are less likely to do so when the action is kept up by giving regular doses at intervals of a month or six weeks.

It would appear that when the tissues have received benefit from radiation treatment, they require a regular repetition to maintain the improvement. Patients appear to miss the stimulating effects when treatment is suspended.

Pernicious Anæmia.—In this disease the effects of X-rays upon the blood-forming organs, *i.e.* the spleen and the marrow of the long bones, may sometimes be of great benefit. Great care must, however, be exercised in these cases. Stimulating doses are required. Small doses of a penetrating ray at frequent intervals may be beneficial by acting as a stimulant to the blood-forming organs.

Careful and frequent blood counts must be the rule, and if no marked improvement results from a few exposures treatment must be suspended. The fact must be well borne in mind that large doses may precipitate a fatal termination by inducing a toxæmia.

Hodgkin's Disease.—This is an affection characterised by a progressive enlargement of the lymphatic glands (beginning usually on one side of the neck) and spleen, with the formation in the liver, spleen, lungs, and other organs of nodular growths associated with a secondary anæmia without leukæmia.

This disease is very responsive to X-ray treatment, and if radiated sufficiently early in the course of the disease, marked improvement, arrest of progress for a lengthy period, and, in a percentage of cases, cure may result.

The beneficial effect of the X-rays is due to a direct action upon

lymphatic tissue and to an effect upon the lymph which circulates within the glands. In addition it is conceivable that an action is exercised upon the blood circulating in and around the glands; consequently in this disease it is well to treat large areas of the body surface as well as the particular group of enlarged glands. A marked diminution in the size of enlarged glands may be induced when only remote regions of the body are treated.

In all these cases it is well to begin treatment by giving frequent small doses, in order to ascertain the degree of response to the radiations before proceeding to give large filtered doses. Should the response be favourable, the more penetrating ray may then be employed in various situations. A dose once a week should be sufficient, several large areas being treated at one time. In most cases a filter should be employed, $\frac{1}{2}$ mm. to 1 mm. thick.

After a sufficient number of doses have been administered, treatment should be suspended for a time (two or three weeks). After this, treatment should be continuous, a dose being given once a fortnight for several months so long as the disease appears to be quiescent. Should a relapse occur it will be necessary to resume the same or more frequent and larger dosage. In very acute cases, when the patient is confined to bed, a daily dose may be given, taking care to change the surface area treated as often as possible.

Leukæmia.—An affection characterised by a persistent increase in the number of white blood corpuscles, associated with changes, either alone or together, in the spleen, lymphatic glands, or bone marrow. There are two main types, though combinations and variations may occur:

(1) **Spleno-Medullary Leukæmia.**—In this form the changes are specially localised in the spleen and the bone marrow, while the blood shows a great increase in elements which are derived especially from the latter tissue, a condition which Müller has termed "myelæmia." Ehrlich calls this type of the disease "myelogenous leukæmia."

(2) **Lymphatic Leukæmia.**—Here the changes are chiefly localised in the lymphatic apparatus, the blood showing an increase in those elements derived from the lymph glands.

In the spleno-medullary form the spleen is greatly enlarged, the organ being in a condition of chronic hyperplasia. There is also marked hyperplasia of the bone marrow.

In the lymphatic form there is a general lymphatic enlargement, which is usually associated with a certain amount of enlargement of the spleen.

It is necessary to describe the blood changes in this disease, but it must be clearly understood that remarkable fluctuations occur both in the relative percentage of cells in the blood, and in the size of the spleen, in cases which receive no treatment. Caution must therefore be exercised in attributing improvements to radiation treatment which may represent only the normal fluctuations of the disease. When thorough radiation treatment is carried out, marked improvement may sometimes be induced, and the spleen often diminishes in size. Bearing in mind the analogy between this disease and sarcoma, it would appear that leukæmia is really a malignant disease of the blood.

This fact, no doubt, accounts for the ultimate failure to cure in nearly all the cases treated. Relapses occur from time to time which may respond again and again to further treatment, but in the end the disease baffles the remedy.

During the course of treatment by radiations, differential blood counts should always be made, and a rapid fall to normal should be an indication for the suspension of treatment. It is also important to compare the differential blood counts with the normal, which in its turn may show fluctuations. The following table gives the differential normal blood counts:

Normal.	Per cubic millimetre.
White blood corpuscles	7,000
Red blood corpuscles	5,000,000
Hæmoglobin	100
Colour Index	1.0

DIFFERENTIAL COUNT OF WHITE CELLS

	Per cent.	Per cubic millimetre.
Lymphocytes	22 to 25	1500 to 1700
Large mononuclear leucocytes	1	70 70
Transitional cells	3 to 5	210 to 350
Polynuclear (Polymorphonuclear neutrophilic leucocytes)	70 to 72	4900 to 5040
Eosinophilic cells	2 to 4	140 to 280
Mast cells	0.5	35 35
		<hr/>
		6855 7475

The Nature of the Action of X-rays in Blood Diseases.—Krauss and Zeigler explain the action as being a destruction by the radiations of the pathological lymphoid tissue. Edouel attributes the effect to an action upon the tissue ferments.

The analogy between this action upon blood cells and that upon the cells of a new growth is striking. In both instances the new cells are being produced at an abnormally rapid rate, and presumably their power of resistance to radiations is much lower than it is when cells are produced at a lower rate, and therefore they are more easily destroyed. Melchener and Wolff found that a spleen, which, after removal from the living body, was exposed to radiations, yielded a leukotoxin, which, injected into a healthy animal, produced a marked reduction in the number of leucocytes, while a similar injection from a spleen which had not been irradiated produced a leucocytosis, increasing the number of white blood cells.

Beclere emphasises the necessity for the continuance of treatment over long periods of time, in spite of an early apparent disappearance of symptoms. He found that under X-ray treatment the blood condition improved, the general health markedly improved, colour was regained, there was a rise in the number of the red cells, and the nucleated red cells disappeared.

Megaloblasts and young cells disappear early, the normoblasts being a little more tenacious. The presence of the solitary myelocytes should

correct the hasty impression that the disease has been vanquished, but he has seen cases which had been treated for six years and remained well. Although there are relapses these are frequently ameliorated by further treatment.

Panton and Tidy have made some observations on the results of treatment which are of great value. Treatment by arsenic and X-rays produced in some cases: (1) no alteration in the condition; (2) a remarkable though temporary improvement. The treatment occasionally precipitated the fatal issue. The most interesting blood change observed was the replacement of the typical granular cells by non-granular myeloblasts shortly before death.

In those cases in which marked effects were produced by treatment it is open to doubt whether that effect was beneficial. In some cases treatment was followed by effects the reverse of beneficial. Panton and Tidy emphasise the point that a diminution in the number of leucocytes and size of the spleen is not necessarily evidence of improvement, but may be the reverse.

A drop in the total number of leucocytes with a relative increase in the myeloblasts suggests a fatal termination in the near future, and such an event may result from treatment in a case apparently progressing favourably.

The blood change aimed at is a reduction in the number of leucocytes to a number approximately equal to but not less than the normal, the relative percentage of cells being unaltered. A rapid diminution in the number of white cells, with an increase in the percentage of non-granular, and particularly in the percentage of myeloblasts is an indication that treatment must be suspended. This need only be temporary, for after a time the white cells increase again. Treatment repeated at intervals will help to keep the disease under control. Patients may go on having regular doses at long intervals and maintain fairly good health for years. In all cases the dosage should be controlled by the clinical condition, and blood counts should be made at regular intervals during the course of treatment. This enables a check to be kept on the radiation dose and indicates whether a long or short exposure is advisable. It may suggest that treatment be suspended for a time. Patients who are taking arsenic internally, or who have recently had salvarsan, should be carefully watched while undergoing radiation treatment. Rapid changes may be induced in the blood of these patients.

THE TREATMENT OF DISEASES OF THE LUNGS AND MEDIASTINUM

Up to recent times the radiation treatment of diseases of the thoracic and abdominal cavities has received little attention, but a recognition of the marked improvement in the general condition of patients receiving X-ray treatment for deep-seated cancer, fibromata, and other conditions has led to the systematic treatment of all deep-seated disease by X-rays.

The Enlargement of the Mediastinal Glands met with in lymph-

adenoma and primary and secondary sarcoma yields, at all events to a partial degree, to deep radiations.

All conditions of tumour should be treated for a time with X-rays, a thorough technique being used and large doses with hard tubes being given. Marked relief may often be obtained, and the patient's condition much improved.

The thoracic area should be mapped out into divisions of a convenient size, and lead screens employed to protect the surrounding skin. A filter of 3 mm. of aluminium is used, and the tube brought as near as possible to the skin surface. It is best to employ a hard tube, a 10 Bauer if possible, through which a current of 4 to 5 milliamperes is run. Kienböck paper should always be used, or other method of measuring the dose, and a careful record kept of all exposures for future use.

Ten or twelve exposures may be given at one sitting on one day, followed on the succeeding days with as many exposures as it is possible to fit into the thoracic area without overlapping.

When the front of the chest is treated, the areas are marked out so as to include the intercostal spaces in the longitudinal aspect of the aperture. By this method a percentage of the rays get in through the intercostal spaces. The supra-clavicular areas, anteriorly and posteriorly, may be treated in the same way, and the axillæ should also be irradiated. The posterior thoracic wall should be mapped out and treated in a similar manner.

By using this technique it is possible to get in a comparatively large dose up to or exceeding 100 X on the skin surface in one or two days. The patient should be confined to bed for a day or two after each series of radiations, and a watch kept on the pulse and temperature. A marked reaction may follow, and hæmorrhage may even occur as the result of the reaction to the stimulation, but this slowly subsides.

In the intervals of treatment the patient should, if possible, be in the country, living an open-air life, and tonics and a generous diet should be insisted upon. The result of treatment on these lines is frequently a marked improvement in general health, with a sense of well-being and an improvement in spirits; often there is also relief of pain, and in some cases a gain in weight, and a reduction in the size of the tumour.

An alternative plan of treatment may be employed when the patient is treated at a home or hospital. Daily doses to different areas may be given for several weeks on end. Cases so treated appear to make steady progress, possibly as a result of the continuous action kept up by the frequent dosage, and also to some extent from the enforced rest in bed.

Sub-acute or Chronic Tuberculosis may benefit from a course of radiation treatment combined with open-air treatment.

Lymphadenoma often responds to this treatment to a marked extent, and **sarcomata** are occasionally arrested in their progress for a time at least.

Endotheliomata of the lung or pleura are the most likely tumours to benefit from radiations, and secondary carcinoma of a slow growth also appear to improve.

In the future, when it may be possible to use still harder tubes and give longer exposures with a more penetrating ray than has hitherto been done, it may be hoped that greatly improved results may be obtained. This belief is supported by the great improvement which has recently taken place in the treatment of malignant disease generally. It is now possible to influence favourably by X-rays the progress of many cases of carcinomata which a few years ago did not seem to improve at all. This improvement in results is undoubtedly due to the following improved factors in therapy: (1) The employment of very hard X-ray tubes; (2) the employment of fairly thick filters; (3) a considerable increase in the dose of radiations; (4) the employment of many ports of entry; (5) the increased frequency of treatment.

In many cases the results obtained are quite as good as those obtained by the use of radium.

B. RADIUM THERAPY

PHYSICS OF RADIUM

By C. E. S. PHILLIPS, F.R.S.E.

When a radium atom has become unstable, most probably through the gradual radiation of undetectable energy by the electrons which it contains, the new condition requires a rearrangement of its constituent parts, accompanied by the sudden expulsion of an electrified atom of helium.

The spinthariscopes of Crookes, as well as the more recent methods of Rutherford and Geiger, enable these individual atoms of electrified helium to be counted; they may even be caused to make a record upon a moving photographic film. In this way it is seen that they are not expelled by the radium atoms with perfect regularity. During any given interval of time, however, their number is very nearly constant.

Thus, from a definite quantity of radium there come streams of electrified matter, the particles of which move at about 12,000 miles per second, carrying a positive charge, and constituting the well-known positive or Alpha rays.

It may be pointed out at once that it is the writer's intention to include in this section only data which seems essential for the purpose of describing the broad principles underlying the application of radium to medical work. For greater detail, reference should be made to standard works on radioactivity. It is, therefore, thought unnecessary to dwell at length upon the behaviour of the products of radioactive change which give no rays of therapeutic use, nor has it been considered advisable to attempt any elaborate summary of the various physical properties and actions of radioactive bodies generally.

There is every probability, however, that some better way will be found in the future for utilising medically the great kinetic energy of the Alpha particle, and in view of that possibility, it is proposed to refer more in detail to the properties of this radiation than would otherwise have been necessary.

In any mass of radium some of the atoms are extremely stable, while others are approaching in various degrees the condition which ends in their disruption. The "average life," therefore, of a radium atom means the average of a number of different values, ranging from seconds to thousands of years. It is curious to notice that, in spite of violent atomic disturbances taking place around them, some of the radium atoms should remain so stable, and especially that always the same fraction of them disintegrates at any given period. Experiment has shown this proportion to be characteristic for each radioactive substance, and holds independently of whether the atoms are compact (as in a solid) or widely distributed throughout a solution.

Further, no means has yet been found whereby the rate of disintegration can be modified in the least degree. Reference will again be made to this question when the meaning of the "half-period" and other radioactive constants is considered.

The atoms of all forms of matter may be regarded as minute clusters of still more minute bodies which carry electric charges, some being negatively and others positively electrified.

It is one of the most striking facts in science that the mass of these negatively electrified bodies, as well as the charge they carry, is the same wherever they occur, for they can be driven out of the atoms of many substances and their properties studied. On the other hand, since the residue of an atom which has lost a negative body or electron is no longer neutral, but contains positive electricity in excess, the positive ions are associated with groups of particles and have never been successfully isolated. In general, therefore, their mass is far greater than that of the electrons, and their movements under the same forces are proportionately slower. The electron being only about $\frac{1}{1836}$ th the size of an atom of hydrogen, it can be realised that since some atoms contain but a few electrons, there must be plenty of room for the movements which modern atomic theory requires in interpreting the results of experiments. When electrons escape from a radium atom they move at a great speed—approaching the velocity of light (3×10^{10} cm. per second)—and therefore penetrate not only the spaces between the atoms of other substances, but even traverse the atoms themselves. Their course may, however, be bent by a magnet, since they have magnetic fields surrounding them in virtue of their motion and electric charge. And, in addition, they can be coaxed to a greater or less extent from almost any substance by heating or beating down upon it waves of short length, such as those of ultra-violet light or X-rays. It therefore appears from many experiments of this character that all bodies contain electrons. We must point out, however, that the term "radioactivity" does not apply to those substances which require an external stimulus to bring forth a radiation from them. Its use should be exclusively limited to cases where an atom disintegrates *spontaneously*, whether accompanied by the emission of a radiation or not.

It would therefore be inaccurate to describe as radioactive the phenomena of tribo-luminescence, or thermo-luminescence, or the light given out by materials which have previously been strongly illuminated; nor can it be strictly applied to the electrodes of a vacuum bulb in which X-rays are generated.

The deviation of a ray by a magnetic or electric field forms a direct experimental proof as to whether we are dealing with ether pulses or streams of electrified matter. Radiations in the nature of light are unaffected by these means so far as deviation is concerned. The path of Alpha particles, however, is modified very slightly by a magnet, because, owing to the comparatively large mass, the velocity of the positive ions is far less than that of the electrons.

A magnetic field of great strength is therefore necessary for the deviation of Alpha rays. On the other hand, a small magnet will suffice to appreciably affect a stream of Beta particles, and in addition, in the case of Beta rays from radium salts, owing to their heterogeneous nature (different velocities), a stream of electrons may be sorted out into a kind of spectrum by this means. It also follows that the Alpha and Beta rays are deflected oppositely by a magnet, and tend always to travel in a direction at right angles to the lines of magnetic force.

In virtue of their electric charges, both Alpha and Beta rays are also deviated by an electric field. The methods by which a direct experimental measurement of the velocity of the particles comprising both kinds of rays is made depends, in fact, upon the foregoing reactions.

Ionisation and Recombination

Now we have seen that the radium atom expels another atom (of helium), and it is important to consider the effect of this positively electrified particle when projected at a velocity of 12,000 miles per second amongst the neutral clusters of other electrified bodies constituting a gas. A gas is chosen because its atoms or molecules can so freely move relatively to one another that if their constituents are split asunder by the inrush of the Alpha particles their regrouping will not occur too quickly to enable the new condition to be in some way detected. As a crude analogy we may picture a bullet fired into a space hung with bags of flour. After the passage of the shot fine dust would fill the air. Some such commotion is certainly produced when an Alpha particle strikes against the atoms of a gas; the latter are split into numerous minute fragments—the electrified dust of atoms—and, in the case of air at normal pressure and temperature, 153,000 electrified bodies, electrons, and positive ions are liberated to move actively in all directions. Many questions of great interest centre round the mechanism by which bodies are detached from neutral atoms through the impact or close proximity of other charged particles. Above all, it has provided a direct experimental method of attack upon the hitherto obscure problem of the constitution of matter.

Ionisation occurs similarly when the electrons or Beta particles traverse a gas, and it may also be produced (only in less degree) by the passage of short-wave ether pulses. But it only takes place then if the waves of the radiation are so short that the electrons within the atom can gather energy from them, and thus augment their movements to such an extent that ultimately they become detached, and fly off at enormous velocities in all directions.

The Alpha particles from radium are completely absorbed by 3.5 cm. of air. In other words, beyond this range they are incapable of detection by their electrical effects, since no ionisation of the gas occurs. The range of the Alpha particles expelled by various products of the radium series depends in each case upon the rate at which the product disintegrates.

It must be kept in mind that, during the process of ionisation, the numerous electrified particles set free are, in virtue of their mutual attractions and repulsions, continually *recombining* to form neutral groups again. It is evident, however, that the action of a radiation may be to so disturb the normal arrangement of the constituents of atoms that, while the influence is operative, their usual properties are modified. If, in fact, the density of the radiated substance is relatively great, as in the case of a solid, while the number of atoms breaking up per second is also far more than with a gas, the rate of recombination is also enormously increased owing to the much closer proximity of the molecules. But, on the other hand, some of the changes produced by the radiations are permanent, since the new groupings that arise become comparatively fixed owing to limited molecular movement.

It is therefore interesting to notice, for instance, the change in colour of glasses and other substances under the influence of certain radiations, and to find that after a thorough shaking of the molecules, sufficient to increase appreciably their mean free path, obtained by the application of heat, the original grouping is regained and the colour disappears. Although this refers chiefly to alterations in the physical nature of a substance, many chemical changes are also produced, presumably by upsetting the arrangements of the bonds which unite atoms into definite molecular groups.

It should now be clear from the nature of ionisation that an electrified wire brought into a mass of ionised gas will be diselectrified by attracting

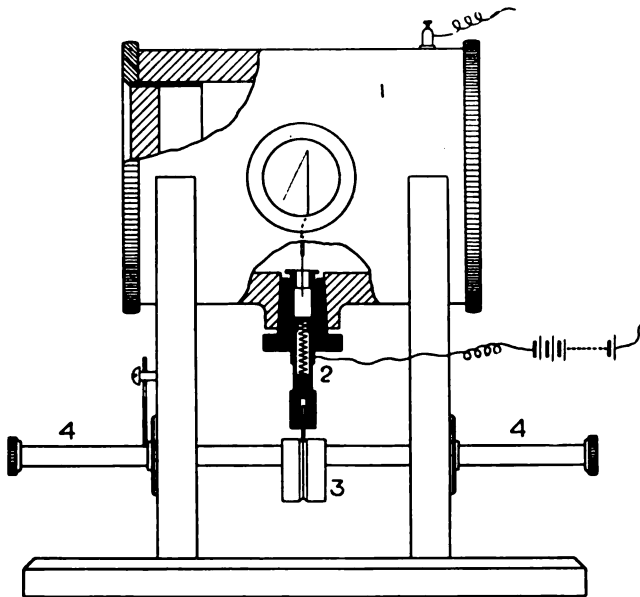

FIG. 362.—Special form of gold leaf electroscope.
(For description see p. 493.)

to it ions of the opposite charge, and will repel the others. Thus, negatively charged initially the wire will attract positive ions, and gradually become neutral. A strip of gold or aluminium leaf attached by one end to such a wire will stand out from it when the wire is electrified, and therefore a very simple method of detecting the presence of ions in a

gas consists in observing the movement of the free end of the gold leaf when a radioactive body approaches the wire. It is, in fact, the basis of all measurements of radioactivity, and the electroscope shown in Fig. 362 is

an instrument embodying this principle. Its detailed description must, however, be deferred till later.

Radium Emanation

The residue that remains when a radium atom has expelled an Alpha particle is no longer radium. It is an atom of a new substance. The property whereby it clung originally to adjacent atoms and in the aggregate

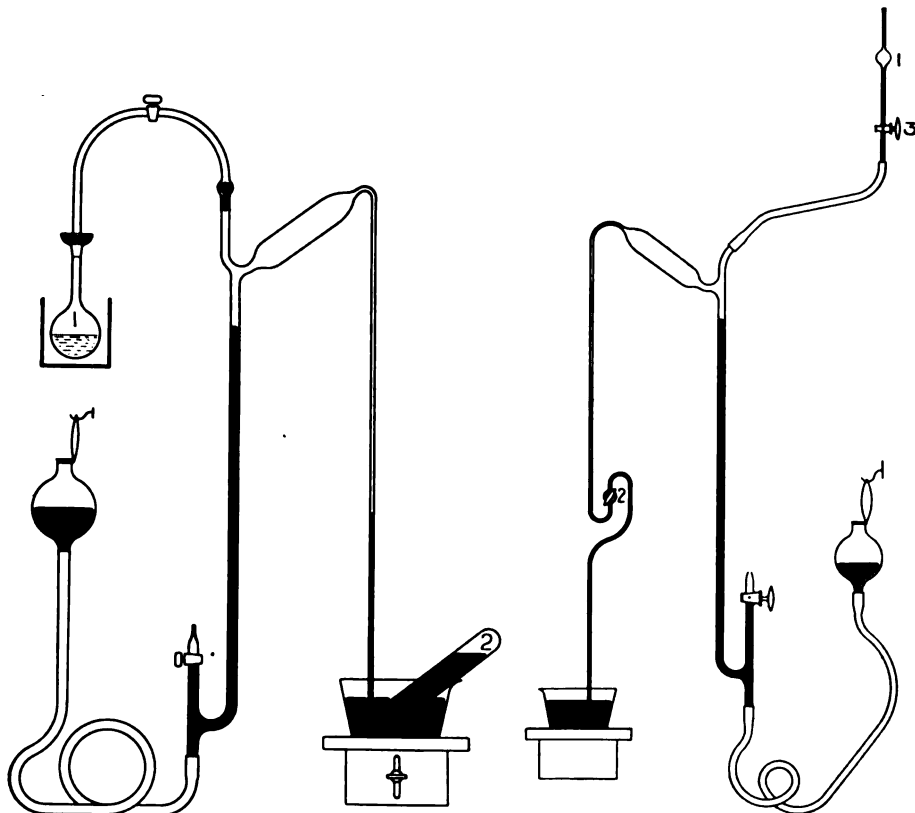

FIG. 363.—Apparatus for pumping off and collecting radium emanation.

FIG. 364.—Combined pump and apparatus for concentration of radium emanation by liquid air.

constituted a solid substance is absent now, with the result that the new atom wanders off and exhibits the characteristics of a gas. It is lighter than Ra, but still very heavy. The atomic weight of the lost helium being four units and that of radium 226.4, the new substance has an atomic weight of $226.4 - 4$ or 222.4. It has been called "the emanation," and is itself radioactive. Radium emanation can be collected, transferred, and generally manipulated like any other gas, and the apparatus for this purpose is shown in Figs. 363 and 364.

The most convenient way of liberating emanation from a radium salt

is to dissolve it in water strongly acidulated with hydrochloric acid. The solution placed in the bulb 1 (Fig. 363) gradually develops a supply of the gas, which may be pumped off from time to time, and collected by displacement in the tube 2, before removal to the sparking apparatus represented in Fig. 365. Here the mixed gases, hydrogen and oxygen, produced by the decomposing action of the emanation upon the solution are recombined to

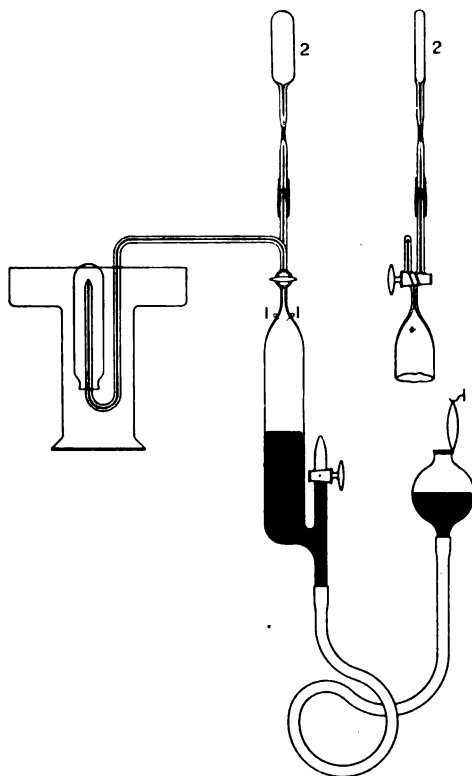

FIG. 365.—Apparatus for charging glass or other applicators with radium emanation after sparking.

water by the passage of a small electric spark between the platinum points 1, 1, and the volume of gas to be dealt with thereby reduced to about one-fifth its original amount. The residue consists mainly of hydrogen, which always occurs in excess, a little water vapour, and the emanation. If we wish, the three-way stop-cock can be turned, and the gas driven up into the flat glass tube 2, also shown in the diagram, which has been previously exhausted by an air-pump.¹

Another method of collecting the emanation consists in condensing it by liquid air upon the inner surface of a small bulb (1 in Fig. 364). When the bulb shows by its strong luminosity that the emanation is condensed (an operation that only takes a few moments), the pump can be started, and the whole apparatus evacuated. Tap 2 should then be turned off while

tap 3 is left open, and the bulb is withdrawn from the liquid air and held vertically. The emanation will rapidly thaw off the glass, and it may be driven by a rising mercury column into the very small glass tube above the bulb 1, which is then sealed by a flame and removed for use.

The emanation expels Alpha particles, but they cannot penetrate the glass of these tubes, except in very special cases. The expulsion of an Alpha particle, however, causes the residue to coalesce into a further new body called Radium A, which by further consecutive changes rapidly gives rise to the series RaB, RaC₁, and RaC₂.

¹ Always lower the reservoir when the mixture has passed over into the sparking tube, so that the gas is rarefied before sparking. In this way all risk of dangerous explosion is avoided.

Now RaC (*i.e.* RaC₁ and RaC₂ taken together) emits not only Alpha particles but also electrons (β rays) and a highly penetrating radiation (γ rays), consisting of ether pulses of extremely short length. On this account Radium C is of the greatest importance therapeutically. The streams of electrons from it can easily penetrate the thin glass of the tube, but they are stopped by 1.6 cm. of aluminium or .4 cm. of lead. The γ rays, on the other hand, are about a hundred times more penetrating. The above series of changes requires three hours for its completion, and at the end of that time the quantity of RaC has reached its equilibrium value. But from the moment of separation from the parent radium, the emanation itself decays by a process of disintegration till in 3.8 days only half of it is left.

After a further 3.8 days half of what remained is gone, and so forth. It will be noticed that the actual amount which decays is proportional to the quantity present. For instance, if we have two volumes of emanation, one being twice the other, since both must become reduced to half their initial values by the end of 3.8 days, the amount of emanation which disappears from the former is twice what the other loses in the same time. The same *fraction*, however, of the initial quantity decays in both

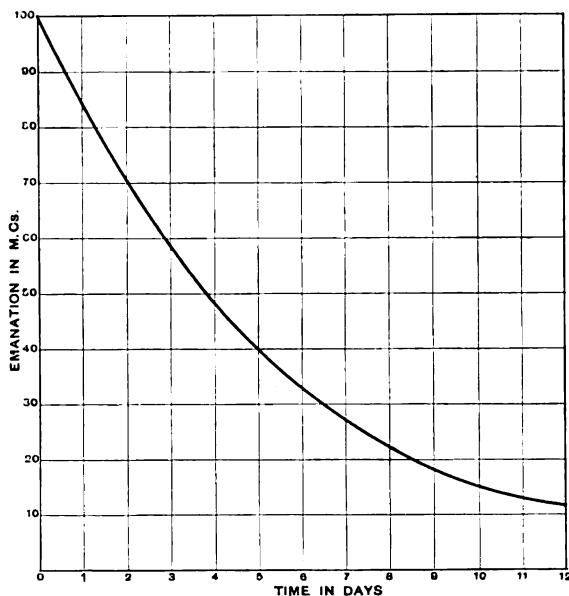

FIG. 366.—Curve showing decay of radium emanation with time.

cases. An exact analogy exists in the lending of money at compound interest if we can imagine the capital decreased instead of being added to in proportion to the amount at the moment. Thus, £100 lent at 10 per cent interest payable yearly, on this plan, would mean that at the end of the first year £10 must be deducted from the capital, leaving £90 to pay interest on for the next year. At the beginning of the third year the capital would be reduced to £81 after the deduction of 10 per cent on the £90, and so on, the amount deducted being always proportional to the capital. If we plot a curve showing a gradual dying away of the capital in this case, it would be a curve similar in character to that in Fig. 366, which really represents the decay of emanation with time, the quantity disappearing being always proportional to the amount present. This relationship is of fundamental importance in the study of radioactivity. It may be put in another way.

Inverting (2) and substituting values, we have :

$$2 = e^{\lambda \times 3.8}$$

$$\therefore \log_e 2 = \lambda \times 3.8$$

$$\text{or, } .69 = \lambda \times 3.8$$

$$\therefore \lambda = .18.$$

λ represents the fraction of the emanation decaying per day, and the above result is of great importance because it is applicable to the whole range of radioactive substances, each having a characteristic value of λ by which it may be identified.

The equation also represents the law governing the absorption of a radiation in its passage through the tissues or other media, and forms in fact the only criterion by which it can be determined whether a radiation is strictly homogeneous or not. If, for example, by interposing a series of layers of aluminium the rays are not cut down according to the above law, the original beam must have contained a mixture of rays of different penetrabilities.

So far we have only considered the emanation which has been collected and separated from its parent radium. It is evident, however, from the foregoing considerations that the quantity of emanation associated with a given amount of radium will for all practical purposes reach a maximum value within a definite time.

Beginning with the case where all the emanation has been initially driven from the salt by heat or solution, at first the gas will accumulate rapidly, for we have seen that the rate at which it disintegrates is dependent upon the quantity present. If a very small quantity is present the number of atoms disintegrating will be insignificant. Meanwhile the radium is producing the gas at a rate which for all practical purposes may be regarded as uniform ; and as it slowly accumulates, the quantity of it which disintegrates in any given time also increases (the fraction of the whole which thus breaks up remaining constant), until a point is reached when a state of equilibrium is maintained, and the quantity of emanation disintegrating per second is equal to the quantity formed by the radium in the same time.

It does not matter of course whether the salt is confined in a large or a small tube, in each case six weeks must elapse before the radium and emanation are in "radioactive" equilibrium.

It is therefore usual to wait for that time before measuring the contents of a tube of radium salt by means of the Gamma rays from the product RaC_2 , which, by the way, only requires three hours to reach its equilibrium value with the emanation producing it. We are in any case dealing here with very small quantities of material. The quantity of radium emanation in equilibrium with 1 gramme of radium element is only .58 cubic millimetre. But very few institutions can make use of so much radium as this. An operator would be considered fortunate to possess 100 mgrs.

of radium salt for emanation work, and the maximum quantity of radioactive gas that could be obtained from that each month would be $\cdot 033 \text{ cm.}^3$ at normal pressure and temperature; yet this incredibly small volume of material, which would go into a pin's head, is equivalent for a short while as regards Gamma radiation to 100 mgrs. RaBr_2 .

It is seen, therefore, that where it is desired to irradiate diseased tissue from within, the emanation may be confined in small glass tubes encased in a thin pointed platinum cover buried in the growth. The radiation close to such a tube is, however, very intense, and in cases where there is danger of injuring normal tissue, and for external work generally, larger tubes are found very effective. A set of suitable forms is shown in Fig. 371 (page 500). They can be rapidly made at the glass bench to suit special cases, and have the additional advantage of being cleanly and light.

After the emanation has decayed to a value too low to serve any useful purpose, the tubes may be opened and the remaining gas collected, so that when added together sufficient may be obtained to charge a useful applicator.

If it is desired to prepare "radium water" (*i.e.* water which has absorbed radium emanation) for administration in accurate doses, the apparatus represented in Fig. 367 has been found serviceable.

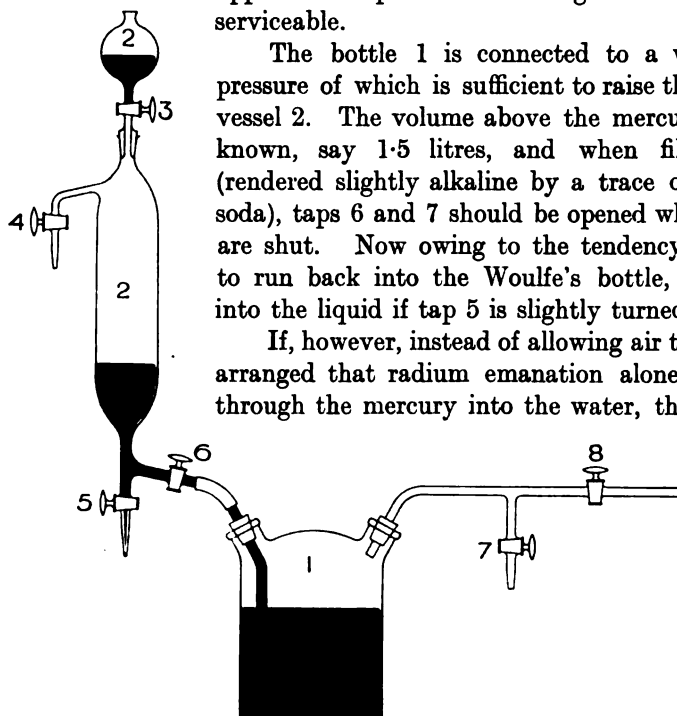

FIG. 367.—Arrangement for the preparation of water impregnated with radium emanation.

taps 3, 6, and 7 with tap 8 closed. It will be noticed that during this very perfect mixing the volume of water does not vary, nor is it exposed to the

The bottle 1 is connected to a water-supply, the pressure of which is sufficient to raise the mercury in the vessel 2. The volume above the mercury in 2 must be known, say 1.5 litres, and when filled with water (rendered slightly alkaline by a trace of bicarbonate of soda), taps 6 and 7 should be opened while all the others are shut. Now owing to the tendency of the mercury to run back into the Woulfe's bottle, air will rush up into the liquid if tap 5 is slightly turned on.

If, however, instead of allowing air to enter here, it is arranged that radium emanation alone shall bubble up through the mercury into the water, the taps may then

be closed, and time allowed for the gas to be absorbed. This process can be greatly facilitated by means of a spray of mercury coming from the funnel on opening

air. The only gas in contact with it is the small bubble of hydrogen containing the emanation.

The solution is thus soon ready to be drawn off from the side tube 4, the water pressure from the main supply forcing up the mercury in 2 and by that means preventing all exposure of the contained liquid to the air, except during the few seconds necessary for the process of bottling.

The bottles used to hold the prepared water are made in sets of graduating size, the volumes increasing in the same proportion as the rate at which the emanation decays. The result of this is that a regular dose may be given twice or so a day for perhaps a week with one set of bottles. (For strength of radium water see p. 495.) The radium solution from which the emanation was pumped is ever giving a fresh supply; the curve showing the rate of growth is the complement of the one just discussed. We can say, therefore, that after 3·8 days half the maximum supply is available; it is evidently more economical to pump the gas off every four days, provided that will give sufficient for our purpose, than to wait a month till the maximum is reached.

In practice, only about 75 to 80 per cent of the emanation may be obtained from a solution in the manner already described. By boiling the liquid more would be obtained, but the risk is too great. The coefficient of solution of emanation is about the same for water and for the blood; salt water takes up less than fresh water, but oils, paraffins, charcoal, and colloid bodies absorb the emanation to a high degree.

It may be well to give here a brief account of the salts of radium now in use, their mode of packing in tubes, and their relative advantages. The element forms an insoluble sulphate. The carbonate is also practically insoluble. To convert the sulphate into a soluble form it may be boiled with carbonate of soda, dissolved in HCl, and crystallised. This gives the very soluble salt $\text{RaCl}_2\cdot 2\text{H}_2\text{O}$. Then there is the bromide, RaBr_2 , which is difficult to obtain free from water of crystallisation; in calculations, therefore, use the formula $\text{RaBr}_2\cdot 2\text{H}_2\text{O}$.

The following are the values for the weight of radium element in 1 mgr. of the various salts:

Name.	Formula.	Weight of Radium element in Mgrs.
Radium bromide . . .	$\text{RaBr}_2\cdot 2\text{H}_2\text{O}$	·535
Radium chloride . . .	$\text{RaCl}_2\cdot 2\text{H}_2\text{O}$	·679
Radium carbonate . . .	RaCO_3	·790
Radium sulphate . . .	RaSO_4	·702

The salts are generally prepared of 50 per cent purity. It is, however, desirable to reduce the volume of the crystals as much as possible, and the purification should, in the writer's opinion, be carried further. This practice (rarely adopted) results in the radium preparation occupying the minimum volume.

The platinum tubes used to contain the salt are generally ·5 mm. thick

in the wall, but .3 mm. will just carry a screw thread, and if made from drawn tube, will be stiff enough for most purposes. The size of the tube should be such that it is quite filled with the powder, the screw plug being then inserted and gold-soldered in position. It is essential to "tin" the thread with gold before screwing in the plug. If this sealing is not perfectly made, emanation will escape; this may be detected by leaving the tube shut into a box for a few days, and then testing to see whether the interior has become radioactive. When, however, for any reason it is required to place a quantity of radium salt in a somewhat long narrow tube (metal), it may be kept in position by a plug of gold leaf, such as that used by dentists for tooth-stopping. Or, if a flat applicator is needed, Fig. 368 (A), it is a good plan to mix the salt with coco-nut charcoal before filling, for by absorbing the emanation this ensures a uniform radiation from the faces of the tube. For insertion into deep-seated regions lengths of "fine" silver rod should be screwed into the applicator or tubes. "Standard" silver is far too stiff.

A tube of platinum, whose wall is .5 mm., cuts off 75 per cent of the Beta rays and 4 per cent of the Gamma. Four mm. of lead absorb all the Beta, and 2 mm. are generally safe for a twenty-four hour exposure, where little or no skin reaction is required. Two mm. of rubber, or five layers of lint, seem sufficiently effective in suppressing the secondary rays from the lead. One mm. of lead reduces the Gamma rays by 4.5 per cent.

Unlike X-rays, the Gamma radiation, being practically homogeneous, follows the density law of absorption, so that lead and silver absorb very nearly the same amounts for equal thicknesses. The coefficient of absorption of Gamma rays from RaC_2 by lead = .51, while that for the Beta rays

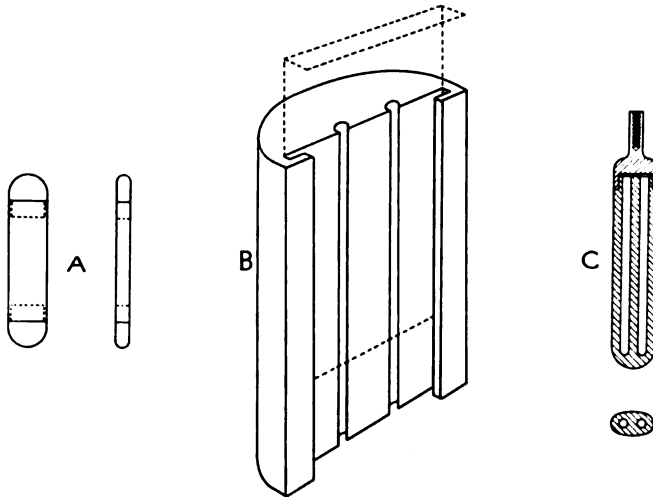

FIG. 368.—Various forms of radium applicators.

varies in the case of aluminium between 13 and 53 (the Beta rays being heterogeneous).

A filter and screen in use at King's College Hospital, and designed by

the writer, is represented in Fig. 368 (B). It consists of a block of silver, cut as shown, and bored out to take two fine tubes of radium salt. The thickness behind the tubes is 1 cm., and each of ten platinum shutters (one is shown dotted on the diagram) can be slid down to screen the radium effectively. An oval section filter, Fig. 368 (C), to carry two tubes is also found to be useful at the same Institution. In order to ascertain the quantity of radium contained in tubes or applicators, it has become necessary to devise methods which may be applied without in any way disturbing the radioactive salts to be tested.

Measurement

The electroscope shown in Fig. 362 may now be described in detail. It consists essentially of a lead barrel 1 cm. thick (1), provided with lead windows at each end, and glass windows at the sides. A fine rod stands erect within, carrying a piece of glass fibre rendered electrically conducting (or, of course, a gold leaf). This stem is supported by a plug of sulphur, and projects downwards a little, so that the piston (2) can be moved up by rotating the cam (3), and thus connect the leaf stem with batteries. On lowering the stem this connection is broken, the brass guard tube, however, remaining charged.

It is seen that no electricity can leak away from the stem except by ionisation taking place within the instrument, owing to radiation entering by the lead windows. There will, of course, be a natural leak (N_-), due to slight radioactivity of the air and inner surface of the lead. But if old lead be used, this leak may be reduced to a very small value. The cam is operated by twisting the rod (4) between two stops. The movement of the leaf is read by a microscope. Great care should be taken to see that the air of the room is still when the electroscope is used, or otherwise differences of temperature upon different sides of the instrument will set up air currents within, which vitiate the results. And it is essential to leave the leaf charged for a few hours before making a test. Owing to the curious tendency of insulators to soak up electric charges, time must be allowed for the sulphur to become saturated before beginning work.

The lead barrel being connected to earth, readings are taken when each of the two quantities of radium to be compared stand at some definite distance from one of the lead windows, and a comparison of these results, if one of the radium tubes has been standardised against a known quantity of pure radium salt, will enable the quantity in the other tube to be determined. It would be scarcely appropriate to go into great detail here as to this matter, but it must be pointed out that several precautions have to be taken. The avoidance of air currents, the allowance for "soakage," the correction for the N_- must all be attended to. The charge upon the "guard tube" should remain constant, and for that purpose a set of 200 Leclanché batteries answers well (No. 3 size).

The most important condition of all, however, is that we charge the

leaf stem to a sufficient potential to enable it to attract all the ions of opposite sign as quickly as they form in the gas within the apparatus. A good way to test this consists in measuring the ratio of the ionisation produced by Gamma rays from two specimens of radium salt, one of which weighs about twice as much as the other.

When brought close to the electroscope the ionisation due to the rays from the larger quantity may be so great that all the ions are not caught before appreciable recombination occurs, whereas the lesser tube will give fewer ions, all of which may be attracted to the leaf stem.

It is obvious that the readings then will not give the true value for the ratio of the quantities of radium present. At a greater distance, however, the correct result is obtained, and beyond that point no further change in the ratio should be observed.

By this means experience will show at what rate the leaf should fall to ensure working within a safe margin. When all the ions are caught, the current which traverses the gas in the electroscope is called the "saturation current," and exactly what value it must have in each particular case depends simply upon the potential gradient between the charged leaf stem and the walls of the electroscope. If the stem is charged to 300 volts, the case being always connected to earth and standing with its walls 3 cm. from the stem, the potential gradient is 100 volts per cm., and sufficient for most purposes.

It is not always convenient to use a battery for charging the electroscope, and the device shown in Fig. 369 may often serve instead. It is a

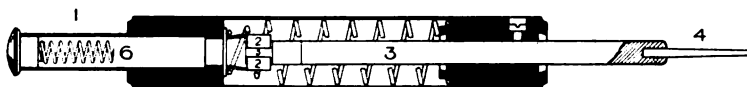

FIG. 369.—Friction device for charging electroscope.

miniature frictional machine, and produces its charge of electricity by the action of depressing the plunger, 1, to which two small flannel rubbers, 2, 2, are attached. The close contact of these as they slide up the celluloid rod, 3, electrifies it negatively, the charge being taken off at the aluminium point, 4, as the rubbers return to their initial position, and are automatically connected to a metal block, 5, previously earthed by contact with the spring, 6. An instrument of this kind is in very general use in a radio-physics laboratory because of its compactness and reliability.

Units.—For the measurement of radium salts it is sufficient to express the result in terms of units of weight. But in the case of emanation, since the actual quantities are so small, it has been decided by international agreement to establish a new unit.

We have explained what is meant by the equilibrium value of the emanation. The new unit is based on this principle and is appropriately named after Professor and Madame Curie. The amount of radium emanation in equilibrium with 1 gramme of radium element is called 1 curie. From this the milli-curie and micro-curie follow naturally. But in the case of certain natural "radioactive waters," where the quantities of emanation

are extremely small, another plan is followed upon the continent. Professor Mache has suggested that, if the saturation current produced by the emanation from 1 litre of water amounts to 1 electrostatic unit of electricity per second in a standardised apparatus, the quantity of emanation present shall be called 1000 units. The initiation of a new unit in science certainly calls for courage in these days, when such long lists of them already fill the books of reference. It is in any case desirable to be able to express readily the value of one unit in terms of another, and to adhere as far as possible to the C.G.S. system.

To base any system of measurement upon the arbitrary choice of a special apparatus will appear to many to have its drawbacks, and it is still questionable whether it would not be more advantageous on the whole to adopt the curie and its fractions for the complete range of emanation measurement.

Some confusion appears to have crept into the interpretation of the relationship between the curie and the mache unit of emanation. One authority tells us that 1 curie = 3,000,000 mache units, while another gives it as being equal to about 2,000,000 mache units. Taking Professor Mache's own value of 3.7×10^{-10} curie, the correct relationship is 1 milli-curie = 2,702,702.7 M.Es. or 2.7 million mache units.

The usual strength to prepare radium emanation water for internal use is 1 milli-curie per litre, but water containing 6 milli-curies per litre has been used in certain cases. The final products of radium, viz. RaD, RaE₁, RaE₂, and RaF, are of little or no use therapeutically, and so they need not be referred to here.

It will be remembered, however, that at the outset we expressed the opinion that Alpha rays would be employed to a greater extent if only some effective way of introducing them into a tissue could be devised. The subcutaneous injection of substances holding the emanation, such as refined petroleum, appears to be the most hopeful. Great care must, however, be taken to employ it only in very small doses. A diffusion applicator has also been devised by which radium emanation is allowed to pass into the tissue, either by absorption through the skin or by a process of imbedding. But so far all methods of using Alpha rays are in a highly experimental stage.

Physiological Action

We have already pointed out that the action of a radiation may so far disturb the normal arrangement of the constituents of atoms that while the influence lasts their usual properties are modified. Now there is no doubt that those who have to do with the application of radiations for medical use are beginning to feel more and more acutely the need of some working hypothesis which will guide their efforts and lead to the accumulation of evidence along definite lines. The practical utility of the far-reaching discovery of radioactivity is certainly held in check at the moment for want of some systematic attempt to work in accordance with a scheme.

The cells of organic bodies consist of complex molecular aggregates, whose ultimate constituents, as far as we know, are the electrified bodies that build up their atoms. We know, further, that when a suitable radiation falls upon these bodies there will be an absorption of energy and an exchange of electrons.

It is, therefore, by action upon the atoms themselves that the radiation primarily exerts its influence. By disturbing the bonds which hold together the intramolecular groups, however, chemical changes will also result. Many physiological actions of the rays seem to be out of all proportion to the energy conveyed to the tissues, and, moreover, a change once begun appears to continue for weeks after the cessation of the radiation. The action is more pronounced, too, in the case of immature and rapidly growing cells than in others. We suggest that the chief cause for these effects is the temporary suspension of the normal function of the cells during the time of radiation, and that if the radiation is not intense enough to bring this about, it may, nevertheless, serve to produce, by physico-chemical change, a product which stimulates the growth of the very cell we desire to kill (as well as possibly that of normal tissue).

According to this view, then, there are two distinct actions, viz. the suppression of the normal function of the cells, due possibly to the ionisation of the nuclei, and the indirect effect of the secretion of a product, in the nature of an anti-body, which tends to stimulate growth against the irritating presence of the radiation. If, in the case of a malignant growth, the former can be maintained for a sufficiently long time, the cells die from want of their normal functions, and even the production of the anti-body in excess is harmless, or even beneficial, if it stimulate the normal cells to proliferate. The dead cells are then slowly absorbed, while the normal tissue takes its place.

With the accumulation of careful observation at our disposal, the time cannot be far distant when a broad generalisation will become possible, and the medical use of radiations thereby greatly extended. The comparison of the action of rays upon nucleated and non-nucleated cells, the possibility of producing immunisation by radiations, and many other experiments, should ultimately give important results, and lead to still wider use for radioactive substances in the cure or alleviation of disease.

C. E. S. P.

THE PRACTICAL APPLICATION OF RADIUM TO DISEASE

In this section of the book it will be sufficient to mention the conditions where radium has been found to possess advantages over X-rays or other forms of treatment.

It should be stated at the outset that radium will produce effects in all the conditions in which X-rays are used, the effect being due to the action of radiations from whatever source they are derived. In the following pages a number of conditions will be described where radium has undoubted advantages over any other form of treatment. When this is not the case, radium should not be employed as long as the price of this element is so prohibitive as it now is. When the two agents are of equal therapeutic value, another factor sometimes influences the choice, namely, the ease with which one or the other may be applied.

The chief points which influence the choice of radium in therapeutics are :

- (1) The greater penetration of the Beta and Gamma rays, more particularly the latter.
- (2) The convenience with which radium may be applied to several of the internal organs.
- (3) The ease with which it can be applied to the interior of a tumour mass, in cases where it would be very difficult for X-rays to produce the same therapeutic effect without great destruction of the intervening tissue.
- (4) The fact that when dealing with highly nervous patients the application is not nearly so alarming as that of X-rays.
- (5) The fact that patients may not be in a condition to be moved to an X-ray department.

Methods of using Radium

Radium therapy has been practised for several years, and during that time the methods of application have been gradually improved. At first its use was confined to external applications, and these still hold an important place in treatment; the radium was frequently of unknown strength, and also often in percentages much under the stated activity.

More accurate measurements and a higher percentage of purity of the radium salts have led to a great improvement in the technique of radium therapy.

Assuming that we have at our disposal a certain quantity of radium, how is it going to be used to the best advantage? The answer is largely governed by the type of cases to be treated.

The chapter on physics will have acquainted the reader with the active properties of radium. This element is constantly giving off a gas, the emanation, which possesses the active properties of radium, the only difference being that the decay curve of the emanation is fairly rapid (see curve, p. 487, in section on physics of radium).

Bearing in mind this decay and its time factor, it is possible to utilise the emanation in therapeutics in a variety of ways which will be presently described. For all practical purposes the emanation may take the place of the radium in metal tubes now so frequently used. In order to obtain the maximum value from the supply of radium, it is obvious that a portion at least of the salt should be kept in solution in order that there may be a constant supply of emanation at stated intervals.

The method of drawing off the emanation, already described, may be utilised in therapeutics. The emanation may be used in the following ways :

1. **As an inhalation**, alone or combined with oxygen. Great claims are made in favour of this method, especially in Germany, where regular inhalation institutes are in full work. It is most important when using any of the complicated machines now employed, to ascertain that they actually do contain radium in a proportion strong enough to exercise a therapeutic effect. There can be no doubt that this means of using the inhalation is valuable, but careful calculations must be made in order to get a percentage of emanation of sufficient strength to be of use. The action of radium emanation by inhalation is primarily upon the lungs, and if care is not exercised an injurious effect may be produced. The emanation is absorbed and finds its way into the blood, by which it is circulated freely throughout the body. Its action may therefore be far-reaching, and possibly a great field of usefulness exists in the future for this method.

It is claimed that the beneficial effects produced by radium water baths are obtained through the respiratory organs, the emanation given off from the radium in the bath being inhaled by the patient ; it is quite likely that this explanation is a correct one, for it is difficult to imagine any action taking place by way of the skin surface.

2. The emanation may be **forced into water**, and the patient be given a stated dose of this at regular times.

Here, again, a large margin of error must be allowed for, because the emanation slowly decays, so that if it is not at full strength when the water is first dispensed it will be practically valueless in less than a week ; water impregnated with emanation of radium must, therefore, be given at first only in small quantities at stated times, and in gradually increasing quantity

in order to compensate for the gradual loss of activity, which is the result of the decay of the emanation.

The emanation is absorbed by oil, water, and other liquids in definite relative proportions, and any of these may be used as a means of getting the emanations into the system, or it may be injected into the substance of or around a growth.

3. The emanation may be passed into glass or metal tubes, or flat **gas-tight applicators** may be made to receive the emanation under pressure. These may be employed in exactly the same way as the radium tube, bearing always in mind the decay curve of the emanation. Tubes containing emanation may be inserted into a tumour mass, and left for days if desirable.

4. By using a special electrical device the emanation can be **deposited upon**

metal points or flat surfaces of metal; these deposits retain the same activity as the parent radium, but the duration of the activity is much less than that of the emanation itself. The deposit of radioactive bodies on flat applicators may be used in many ways, as, for instance, for ionisation, a powerful galvanic current being employed to drive them into the tissue. Haret reports a number of cases which have received great benefit by this method of treatment.

Of the many methods of using radium emanation, the one which commends itself most forcibly is that by which the emanation is placed in receptacles, which can be used in a great variety of ways according to the particular case requiring treatment. The other methods will be referred to again in the section dealing with the treatment of particular diseases. By using a large quantity of radium salt in solution and drawing off the emanation, it is possible to treat a large number of patients by means

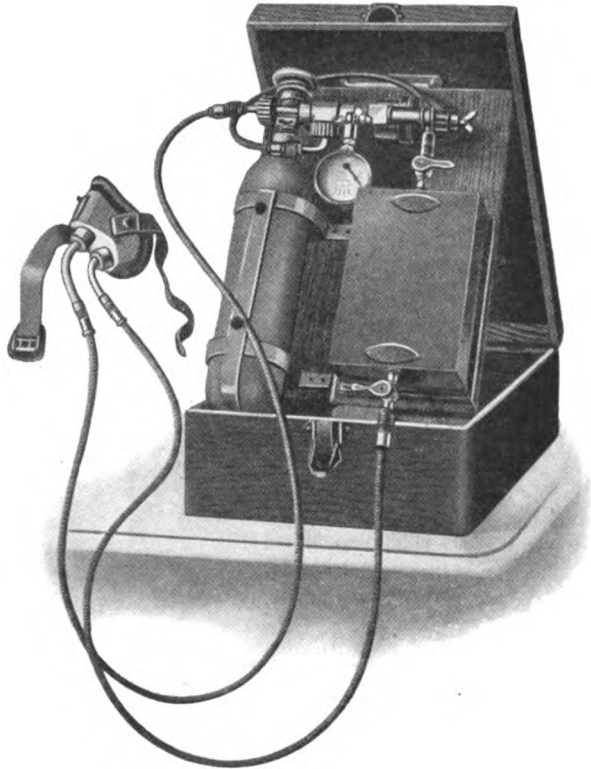

FIG. 370.—Apparatus for inhalation of radium emanation and oxygen. (Radium, Limited.)

of specially designed tubes, which can be constructed to suit each particular case. Patients at a distance may receive treatment by means of these applicators, and patients at hospitals may be allowed to go home with the radium emanation applicator, an advantage which is not possible when using the actual radium, on account of its financial value.

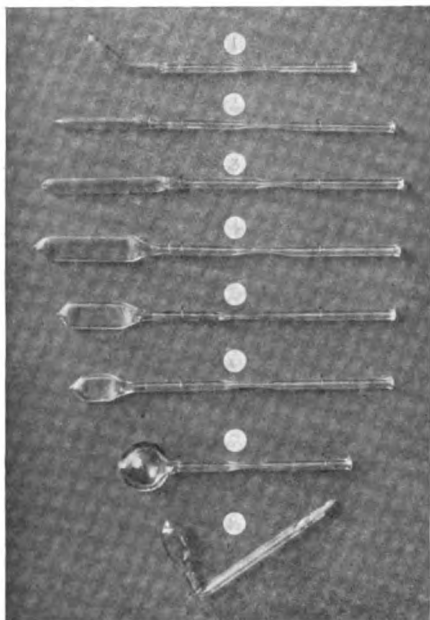

FIG. 371.—Glass applicators for radium emanation.

5. By means of a liquid-air plant, the emanation can be forced into small glass or platinum tubes, which may be inserted into the substance of a tumour.

The parent radium does not depreciate at all noticeably, and is ready to yield up its growth of emanation at stated intervals, 200 to 500 mgrms. of radium in solution yielding emanation in sufficient quantity to treat a large number of patients.

The additional advantage of being able to make a special applicator for the treatment of each case is of great importance. The applicator may be of a suitable shape to allow of the maximum effect being obtained, and being of glass or cheap metal may be destroyed after each application.

It is in the treatment of out-patients that this method is found most useful. The applicator is placed in position, and the patient is given definite instructions as to the time at which it should be removed.

6. **The Radium Salts.**—This, up to the present, is the manner in which radium has been most frequently or most generally employed. It will be necessary to go into the preparation of these applicators at some length, for it is on a correct assessment of the activity of these applicators and the quantity of the radium they contain that successful treatment is based.

Bearing in mind the great value of radium at present market prices, it is obvious that no clinique can afford to run great risks of loss of radium by faulty applicators. The French method of putting radium upon linen to form *toiles* is useful and easy of application, but as these *toiles* cannot be regarded as in any degree antiseptic or aseptic, they consequently cannot be used in cases where care in this respect is necessary. The most useful form of applicator for superficial conditions is the flat one, which may be of any desired size and shape, the radium being incorporated in a varnish and spread over the metal surface of the applicator (see Figs. 390 and

391). The dimensions most frequently employed for these forms of applicators are :

Square applicators : 2, 3, and 4 cm. square. •

Oblong applicators : 2 cm. × 3 cm. ; 3 cm. × 4 cm.

The amount of radium salt used is generally 1 centigramme per square centimetre. The activity of the radium salt must also be taken into account. As the strength may vary from 10,000 to 2,000,000 activity, it is obvious that widely diversified effects will be obtained by using the applicator charged with salts at any of the gradations between these two limits.

A convenient form of flat applicator is illustrated in Fig. 383.

The special varnish employed in the manufacture of applicators with fixed salts is made to resist various physical and chemical actions for periods more or less long ; it may be subjected without damage to a temperature of 300° C. or thereabouts ; it resists the action of the following, cold or hot liquids and solutions for long or short periods : water, permanganate of potassium of 1 per cent, oxygenised water of 12 volumes, bisulphate of soda of 1 per cent, glycerine, vaseline, bichloride of mercury of 1 per cent.

The use of absolute or 90 per cent alcohol, or of ether, must be avoided ; but a short application of cold alcohol does not appear to have any serious detrimental effect.

Screens of nickel, aluminium, lead, silver, or platinum may be employed.

Tubes with Free Salts of Radium.—A salt of radium, by choice the sulphate, is enclosed in a platinum tube, the walls of which are of a known thickness, generally $\frac{5}{10}$ of a millimetre, the external diameter of the tube being at least 2 millimetres. The length and the diameter vary in accordance with the quantity of the salt contained in the tube. For instance, a tube containing 1 centigramme of salts of radium may have an exterior diameter of 2 millimetres and a total length of 18 millimetres. Tubes used more recently are much less in diameter. These narrow tubes, which are generally made with a pointed end to facilitate introduction into the tissues, are very useful for insertion into the substance of a growth. The length of the tube is determined by the diameter and the smallest space the radium can be packed into.

The object of the thick silver screen at the back shown in Fig. 384 is to protect the skin surface not receiving treatment. This is used in situations, such as the axilla, where the skin on the inner side of the area comes in contact with the applicator.

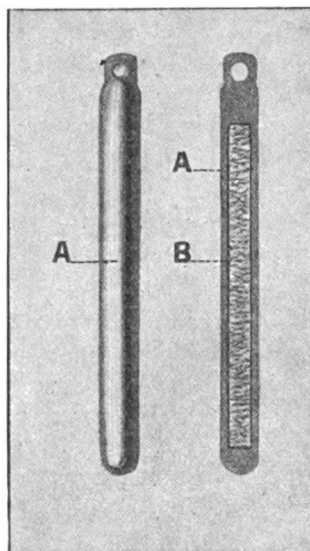

FIG. 372.—The length of the tube is determined by the diameter and the smallest space the salts of radium can be packed into.

A, Outer tube.

B, Space containing salts of radium.

A tube may have an outer case (acting as a screen) fitted to it with a screw cap. The screw is provided in order that the applicator may have a length of silver wire joined up to it for applications in the œsophagus.

In some instances a pointed screw terminal is added to the distal end to facilitate the introduction of the tube into a growth. When using this applicator for insertion into the substance of a growth, it is only necessary to use a local anæsthetic.

The radium in a metal tube is the most useful form in which it is employed and it is capable of being used for application :

- (1) Externally.
- (2) To the interior of the body in such situations as the mouth, nose, throat, œsophagus, rectum, vagina, etc.
- (3) Into the substance of a tumour by making incisions, and inserting the radium tubes into the centre of the mass.

The special methods of preparation of these radium tubes will be described in the section devoted to treatment of diseases suitable for radium therapy.

A Good Method of utilising a Limited Quantity of Radium

One of the questions which frequently arises in radium therapy is that of administrative technique. With radium at so high a price it is necessary to make the utmost use of often a very limited supply of the element either alone or in the form of a salt. The arrangement of institutes which possess a large quantity of radium, in various forms, and have many combinations of apparatus, is not one which concerns the average radium worker. In such large institutes the practical arrangements resolve themselves into the division of the radium and its use : (1) in the form of flat applicators, or radium in glass or metal tubes, when all forms of combinations may be employed in practical work, and (2) the employment of the emanation (under pressure from liquid air) in tubes of glass or metal in order to reduce the bulk of the applicator to practical dimensions. There can be no question at all that the use of radium, either as "element" or a salt, is much the better method because of the constancy of the radiations. It is true that the rate of decay of emanation can be estimated and the dosage adjusted to correspond, but for practical purposes the radium is better, and at the same time possesses all the advantages of the emanation tubes, with none of the disadvantages.

A further advantage of this over the emanation method is that it does not involve the worker in the employment of mechanical arrangements for filling the emanation tubes, and it obviates the necessity for measuring the activity of each tube before it can be used for accurate dosage. The services of a physicist are then only required for the initial testing and an occasional check observation to make sure that the radium is acting up to full strength. When only a limited supply—say 100 mgrms.—of radium is available, a

suitable division would be 10 mgrms. of radium element enclosed in each of ten small tubes (2 cm. long by 3 mm. in diameter), either of glass or of fine platinum; the former is better, as it allows a larger percentage of the Beta radiation to pass through its walls, and this may offer a considerable advantage in the treatment of some lesions. It is also possible to adapt filters of varying thickness to the glass applicator, and this allows of a wide range of radiation, but glass has the serious disadvantage of fragility.

Consequently, when arranging a scheme for the utilisation of a limited quantity of radium, it would be well to base it on the use of the radium or its salts, and to leave out of our calculations the use of emanation. Particularly is this so when we realise that there is no therapeutic effect to be obtained from the emanation that cannot be produced with the radium alone.

The fine calibre tube of glass or platinum should have fitted to it a silver tube to act as a filter, the distal end should have an iridium point to it to facilitate insertion into the tissues, and at the other end a screw cap should have attached to it a ring, to which can be fixed a silver or silk suture when the tube is introduced into the tissues.

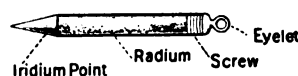

FIG. 373.—A fine radium tube.

Several workers in America have adopted this method, the radium being placed in a small steel tube, which has a needle point at one end. The steel tube is plated with gold. Platinum is a better metal to employ, as it does not change in character when radium is placed in contact with it. The platinum tube should have an iridium point on the free end.

The employment of emanation in very small tubes has been largely practised at the Radium Institute, and by Dr. Stevenson of Dublin. In

the method employed by the latter, the radium emanation is contained in small glass tubes which are placed in hypodermic needles for embedding in the tissues. This method involves a calculation of the rate of decay and of dosage which has been tabulated by Dr. Stevenson.

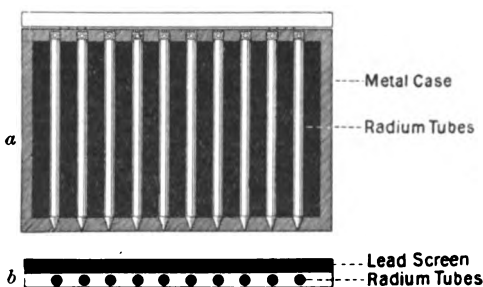

FIG. 374.—A flat applicator for radium. *a*, Front view. *b*, Sectional view.

Applicators of different shapes should be provided, by means of which the tubes may

be applied to any part of the body. These are subject to endless variations according to the needs of the case and the ingenuity of the worker. Many new combinations will suggest themselves in the course of routine work.

It will be necessary therefore only to suggest a skeleton arrangement of applicators for the use of the beginner.

(a) Flat applicators can readily be devised by using ten tubes laid upon the surface of the applicator, as illustrated in Fig. 374.

The back of this flat applicator should consist of lead several

mm. thick for the protection of adjacent parts not actually undergoing treatment.

The front of the applicator is adapted for the reception of filters of silver, aluminium, or lead, varying from $\frac{1}{16}$ to 3 or more mm.

The use of an arrangement of this kind gives a wide range of wave lengths for therapeutic purposes, and it also ensures a uniform distribution of radiations over a large area.

A circular flat applicator may be required in some cases; this can readily be constructed.

In an applicator of this kind the activity of the radiation will be greater at the centre than at the periphery, because of the closer approximation of the radium tubes at the centre. This greater intensity of radiation may be desirable in some cases, but if a more equal distribution of radiation is required, the applicator could be made concave, so as to get the advantage

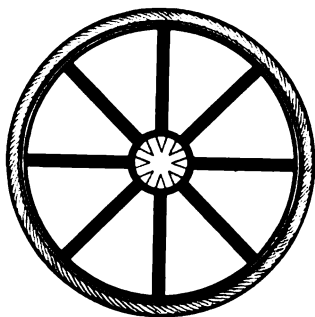

FIG. 375.—A circular radium applicator.



FIG. 376.—A concave circular applicator.

of distance to balance somewhat the greater central intensity.

It will be readily seen that 100 mgrms. of

radium element thus enclosed in small tubes may be used to the greatest possible advantage—100 mgrms. of the element is equal to about 200 of radium bromide, varying with the form of salt and its radium element equivalent.

The exact figures are as follows :

				Content of radium element in the pure radium salt.
Radium	Bromide	$\text{RaBr}_2 \cdot 2\text{H}_2\text{O}$	Soluble in water. Crystals.	53.6 per cent
„	Chloride	$\text{RaCl}_2 \cdot 2\text{H}_2\text{O}$	Soluble in water. Crystals.	67.9 „
„	Sulphate	RaSO_4	Insoluble in water and acids	70.2 „
„	Chloride	RaCl_2	Powder, soluble in water	76.1 „
„	Carbonate	RaCO_3	Insoluble in water, soluble in acids	79.0 „

The possible combinations of small applicators similar to the above are so numerous, and they are so adaptable to treatment in any situation that the radiologist may be strongly advised to have the radium put up in this way.

For embedding in the substance of a tumour the tubes should be specially rendered sterile by immersion in an antiseptic solution before use. When not in use they should be kept in a specially arranged box or tube in formalin vapour. Care should be taken when treating a tumour to place each tube at an equal distance from any adjoining tube (see Fig. 377) so as to ensure an approximately equal distribution of the radiation.

The actual distribution of the radiation at any particular point can be

ascertained experimentally by measurement with an electroscope, and it should be clearly understood that all tubes and arrangement of tubes in combination should be carefully tested for Beta and Gamma radiation whenever possible. The services of an experienced physicist are absolutely necessary for the testing and subsequent retesting.

In actual work with the radium tubes in position, the activity may be ascertained by the use of an electroscope placed near to the part undergoing treatment.

Radium tubes in position in internal situations of the body may be localised by X-ray examination.

The small tubes may be arranged for treatment of the pharynx or œsophagus by employing a method similar to that illustrated in Fig. 378. The number of tubes employed will depend upon the diameter of the largest bougie it is possible to pass into the stricture, and also upon the length of the œsophagus which is involved. It may be that only two or three at the most can be applied to a tube of the necessary diameter. It should then be possible to employ the tubes in several tiers, one above the other, as shown in Fig. 378. When short exposures are given, it will be possible to cut down the filtration to practically that offered by the glass tube, plus the very thin metal case and that of the rubber tube. The percentage of Beta radiation will then be larger than when the thicker filters are used. In all cases an endeavour should be made to get in the greatest number of tubes, in order to obtain a maximum effect in the shortest possible time. The employment of a tube in the œsophagus, however perfect the technique, cannot be regarded as a pleasant experience for the patient; it is therefore better to shorten the duration of the exposure as much as possible compatible with thorough irradiation of the diseased areas.

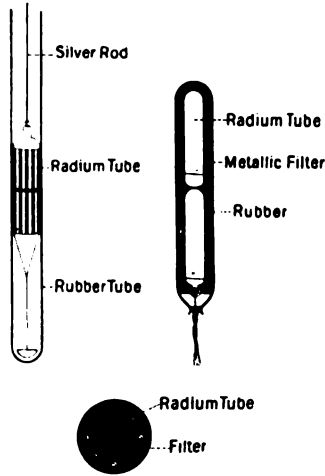

FIG. 378.—Œsophageal tubes containing tubes of radium in tiers.

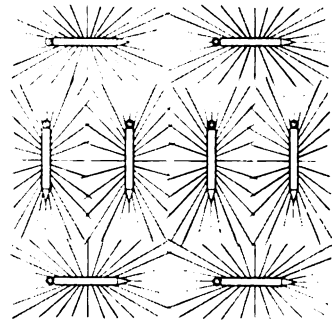

FIG. 377.—Arrangement of several separate radium tubes over an extensive area.

There are special regions of the body which require to have applicators adapted to their requirements in treatment. These situations are numerous and varied, and will often tax the ingenuity of the radiotherapist. In a number of these cases the small tubes may readily be fixed together in such a way as to allow of a thorough treatment. In others, and particularly in the mouth and pharynx, it may be necessary to devise a special applicator

to suit the case. Then the services of a good mechanical dentist will be extremely useful, for he may, by making a special denture, be able to help in the application. Fig. 379 illustrates the value of this collaboration.¹ In this case great help was afforded by the use of the special plate-applicator made for the treatment of a growth in the region of the right tonsil. It was arranged so that either a flat applicator or a number of small tubes could be employed. It would not have been possible to apply the radium if the usual large tubes had been used.

For the treatment of rectal conditions an arrangement of tubes similar to that employed for the treatment of the œsophagus may be used. Here it may be necessary to treat longer strictures and larger growths, then several tiers of tubes should be arranged around the central rod at suitable intervals of space to correspond with the areas requiring treatment (see Figs. 378, 397).

At the distal end of the tube a considerable length should be left free from the radium tubes to act as a fixing agent, then come the tubes, and when possible at the proximate end a distensible rubber bag should be fixed,

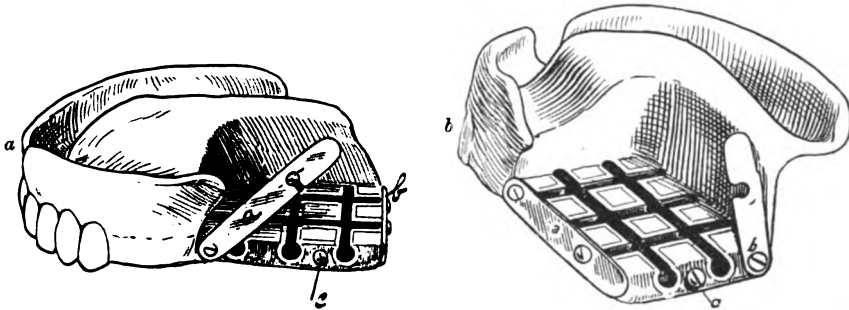

FIG. 379.—Palatal surface of special applicator made for the mouth.
a, Lateral view. b, Postero-lateral view.

which should lie in the part outside the stricture. This may be gently inflated with air from a hand pump until sufficiently distended, so as to engage the surrounding parts. It should act as a steadying factor for the tubes above, and help to retain them in correct apposition with the diseased areas.

In diseases of the uterus a similar arrangement will be found suitable. For carcinoma of the cervix several tubes arranged on a short rod may be introduced into the canal, or actually introduced into the substance of the growth, others may be placed in the fornices around the growth, and the whole should be carefully packed with thick gauze, so that perfect apposition may be obtained, and that no displacement of the tubes occurs during the treatment.

Each tube should have a silk suture attached to it, and this should be fixed to the skin outside.

The examples of possible combinations of these small tubes could be

¹ "Description of two Radium Applicators for Malignant Disease of the Mouth and Pharynx," by Chas. H. Butt, L.D.S., Hon. Dental Surgeon, King George's Hospital. (*Archives of Radiology and Electrotherapy*, February 1917.)

multiplied indefinitely, there being hardly any part of the body which cannot be reached in some way or other by the radiations from radium in small tubes suitably placed.

The principal point it has been desirable to emphasise is that when the supply of radium is limited, as it is in nearly all cases except that of large institutes with large quantities of radium at their disposal, it is more economical and useful to place the radium in many small tubes than in one

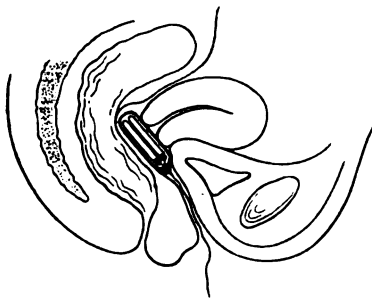

FIG. 380.—Two or more tubes in an applicator for treatment of the cervix uteri.

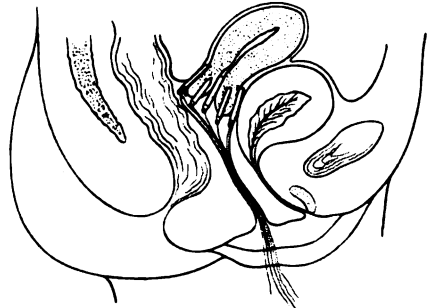

FIG. 381.—A number of single tubes of radium inserted in and around the cervix uteri.

or two large ones, for it has been proved that it is possible, by suitable combinations of these, to treat practically any condition which is at all amenable to radiations. On no account should it be attempted to put such a small quantity of radium into solution for emanation purposes.

Even when a larger supply of radium is available it should still be a more economical plan to put the additional radium into tubes and extend the form of applicators, rather than to put a portion of it into solution. The only possible advantage that the emanation method offers over the radium in tubes is when it is desirable to treat patients at other places than hospitals or nursing homes, or when it is necessary to send the radium emanation to medical men at a distance. Under these circumstances the loss of an emanation tube is not a serious matter.

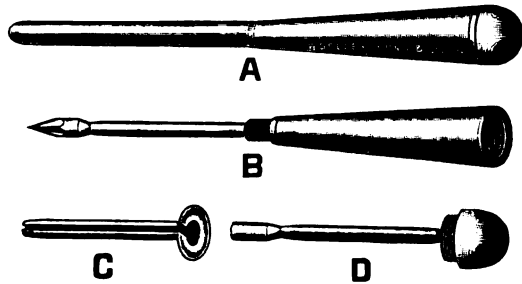

FIG. 382.—Trocar and cannula for insertion of radium emanation tubes. (Woolley, Sons, & Co., Ltd.)

- A, Introducer complete.
- B, Sharp trocar in position.
- C, Cannula.
- D, Blunt trocar.

Dr. Arthur Burrows (Manchester) has devised an instrument for introducing radium and radium emanation tubes into tumours when there is no danger of perforating important structures. It consists of a sharp trocar, a cannula with a slot running its whole length, and a blunt trocar. The sharp trocar and the cannula are thrust into the growth to the required

depth, and the trocar is withdrawn in the usual manner. The radium tube is then inserted in the cannula, and its silk attachment for withdrawal is slipped into the slot. Next the blunt trocar pushes the tube home. The cannula is then pulled up along the trocar, and its lower end and the silk are thus completely disengaged; then the trocar and cannula are withdrawn, leaving the tube in position. The process is speedy, and practically no scar remains. The component parts of the introducer screw together into a compact whole. The internal diameter of the cannula is 3 mm.

Filtration of Radium Rays

The effects produced by a radium application depend upon the quantity

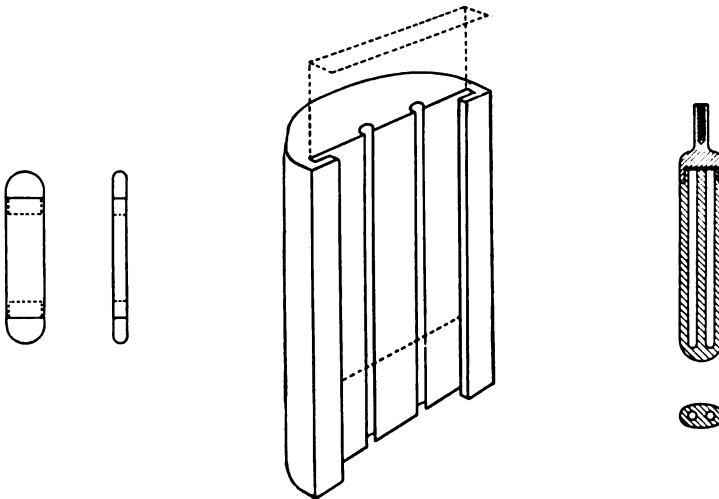

FIG. 383.—Flat metal applicator. Radium is packed in area represented by dotted lines.

FIG. 384.—Showing method of arranging tubes with filters.

A thick silver screen with grooves to take two radium tubes. In front is a groove for platinum filters. Ten of these may be used; each is $\frac{1}{10}$ mm. thick. The holder has a thick backing of 1 cm. silver, to protect the adjacent skin surface from the rays when in use.

FIG. 385.—Silver screen 1 mm. thick adapted to contain two tubes side by side and fitted with screw terminal.

of radium used, its strength, and the duration of the exposure. The effect is further influenced by the presence or absence of a filter.

These filters are most important, and a number should always be at hand. For the flat applicators it is necessary to have filters from $\frac{1}{10}$ of a millimetre to 2 mm., according to the result we desire to obtain. Using 20 mgrms. of a radium salt of 500,000 activity on an applicator 2 cm. square, a marked reaction may be produced on the skin by one hour's exposure. (A thin sheet of rubber or gutta-percha tissue should always be used to protect the radium.) A half mm. of aluminium acting as a screen will delay the appearance of the reaction; therefore, to get a similar degree of

reaction the exposure would require to be longer. When the activity of the radium is greater the effect will be proportionately increased.

The metallic tubes containing free radium require to be used with screens of known thickness; these may be larger tubes of silver or platinum, of a thickness of one to two millimetres of platinum or two to four mm. of silver. When these tubes are not available an efficient filter may be made by rolling a portion of sheet lead around the platinum tube containing the radium. Silver and lead have equal powers of obstructing the passage of the rays from the radium, platinum possessing twice the absorption value of lead or silver.

The thickness of the filter to be employed is estimated beforehand according to the effect desired, the quantity of the radium employed, and the tissues to be treated.

Secondary Radiations from Tubes containing Radium.—It is not sufficient simply to use a filter for the absorption of the radium rays. It must be borne in mind that the filters also give off rays which are known as secondary radiations; these are injurious to the tissues with which they come in contact, and must therefore be filtered if damage to the tissues is to be prevented. Rubber tubing of a thickness of $\frac{1}{2}$ to 4 mm. is sufficient for this purpose.

The Influence of Air-space in Filtration of Radium Rays.—The distance of the radium from the surface of the body also prevents the injurious effects, in other words, air space acts as a filter by preventing radiations of a particular length from reaching the surface. In long exposures twenty or thirty layers of lint should be interposed between the radium tubes and the surface of the body.

Radium Tubes in the Substance of a Tumour

Attention must be paid to the following points :

- (a) The tube must be surrounded by the growth.
- (b) When more than one tube is used, the tubes should be at equal distances, so that an equal action be obtained throughout the growth.
- (c) The radium tube inside its filter should be enclosed in rubber tubing and closed at each end.

Radium contained in glass tubes should not be subjected to great heat.

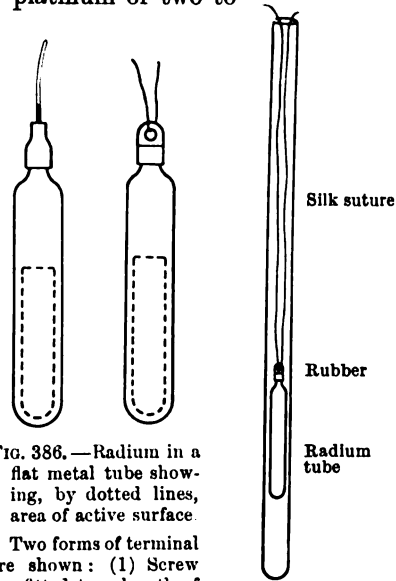

FIG. 386.—Radium in a flat metal tube showing, by dotted lines, area of active surface.

Two forms of terminal are shown: (1) Screw top fitted to a length of silver wire; (2) screw top perforated for silk thread or fine silver wire.

FIG. 387.—Radium tube contained in rubber tubing.

The glass tube should therefore not be sterilised by heat. It may, however, be placed in a solution of carbolic acid for a short time before use. The metal filter may be boiled, and rubber tubing should be sterilised before use. It is important that these measures should be carried out prior to the insertion of the radium tube into the substance of a growth.

Treatment of Deep-seated Tumours by external Applications

When treating deep-seated tumours it is often necessary to give several exposures to the exterior of the growth, in such a manner that a fairly equal dose is given all over the surface of the mass. If a large quantity of radium is available this could be done by one application; but the majority of operators have only a very limited supply at their disposal, and in such cases it is necessary to give several exposures to cover the surface. The following method will be found useful, a malignant enlargement of the thyroid requiring treatment being taken as an illustration, and 200 mgrms. of radium sulphate in three tubes being available.

The surface of the tumour is mapped out with a skin pencil, each section being numbered. A piece of lead 1 cm. thick is moulded to the surface of the tumour, windows being cut out in this corresponding to the areas already marked. The radium is arranged on the filter to be employed, say 3 mm. of lead, this cutting out practically all of the Beta rays.

The filter is fixed over the window above the area to be treated. The tubes are attached to the surface of the filter by adhesive plaster.

The tubes are so arranged that the maximum of the radiations go through the centre of the filter. The tubes are enclosed in rubber tubing, and thirty layers of lint are placed under the thick lead which has been moulded to the surface of the tumour. Each area receives a portion of radiation from the exposure of the adjoining one; the maximum of each area is obtained with the radium directly over its centre, but each periphery gets nearly a half from the exposure of the adjoining area. Thus a certain degree of overlapping must occur, but if the exposures are arranged as above, each area should have a centre of maximum radiation, and the periphery of each receives approximately a full dose from the two adjoining applications. In this way it is possible to get the maximum of exposure all over the surface of a tumour with a fair degree of certainty.

Using 200 mgrms. of radium, and dividing the tumour into, say 10 areas, and giving twenty-four hours' exposure to each, it is possible to administer a relatively large dose, amounting in all to $24 \times 10 \times 200 = 48,000$ mgrm.-hours. The exposure of the whole tumour would take ten days.

There are **several cautions** to be observed when treating with large quantities of radium.

1. The effect of the earlier exposures should be carefully watched, because if a marked reaction should come on rapidly the subsequent exposures should be postponed.

2. Short of a severe reaction in serious cases the treatment should be persisted in. The beneficial effect may be secured, if an adequate dose is given, with practically no skin reaction, but the appearance of a slight reaction is an indication that the maximum skin dose has been given. An interval of time should be allowed to elapse before repeating the exposure over the same area. This should not, however, prevent the treatment from being carried on over other areas in the proximity.

DOSAGE IN RADIUM THERAPY

The most difficult question in radium treatment is that of dosage. There are many points which require to be considered.

The activity of a preparation of radium is evidenced by the photographic, chemical, electrical, and physiological effects of its radiation. Thus, if one salt is more active than another, it has a stronger effect upon the substance or tissue with which it is brought in contact; if, for example, a photographic plate is used, the action will vary immensely with the strength and quantity of radium used. Pure salts of radium, dried and prepared for several months, have a constant radiation, by which they are always identified, and the number of rays produced by a quantity of pure radium salt are actually proportional to its weight. Generally speaking, for equal weight, the salt which is the richest in radium will have the most intense radiation, and its value can be expressed in salts of pure radium.

Unit of Radiation.—For the time being the measure which was introduced early in the history of radium therapy has been maintained. Instead of measuring the value in pure salts of radium, it is compared with the standard of activity.

Standard of Activity.—In France and other countries metallic uranium is taken as the standard. Equal weights of radioactive salts and metallic uranium, or the corresponding quantity of uranium oxide spread on the same equivalent surface, are compared. The radiation of uranium is taken as unity when the activity of the pure bromide of radium is equal to about 2,000,000 times that of an equal weight of uranium.

Relation between the Value of Radium and its Activity

As an example, a table is appended of a few values of pure salts of radium and their corresponding activities:

Value of Pure Bromide of Radium.	Activity.	Value of Pure Bromide of Radium.	Activity.
Per cent.		Per cent.	
0.0025	50	1	20,000
0.005	100	2.5	50,000
0.025	500	5	100,000
0.05	1,000	25	500,000
0.25	5,000	50	1,000,000
0.5	10,000	100	2,000,000

The percentage of pure radium salt in a particular quantity of a mixture of salt and inert matter determines the activity of the particular preparation. When several radium preparations are in use, it is well to test one tube, of say 50 mgrms., and, having ascertained its percentage of activity, to regard it as the standard by which the other preparations are estimated. The activity of the radium is estimated by means of the electroscope, and it is customary to base the calculations on the Gamma ray effect upon the gold leaf of the electroscope. For this purpose it is necessary to absorb all the Beta rays before the Gamma rays can be dealt with. This is easily done by interposing a layer of lead 1 cm. thick between the electroscope and the tube of radium. Placing the radium at a given distance, the rate of fall of the gold leaf is watched and timed. Another tube containing more radium is then placed on exactly the same spot as the first tube. The reading of the scale indicating the fall of the leaf is again taken, and it is a matter of calculation to estimate the activity of the second tube of radium.

When it is necessary to estimate the activity of emanation, an emanation electroscope must be employed. This is also useful when dealing with substances and fluids which have become radioactive, such as water or urine.

Age of the Salts.—Immediately they have been prepared, salts of radium give out only a slight radiation, which consists entirely of the Alpha rays, the radiation increasing gradually, until its maximum constant value is attained at the end of about six weeks. This is a point which should always be kept in view when dealing with salts of radium which have been freshly prepared. These preparations may be used, but the calculation of the dosage must be carried out for each preparation. It is useless to compare these preparations with matured ones, from the point of view of therapeutic effect.

Variation of Activity.—If salts of radium are enclosed in carefully sealed receptacles, they attain a radiation value which always remains constant.

There are various causes, however, which may modify the constancy of the radiation :

- (1) Exposure of the salts to the atmosphere.
- (2) Absorption of moisture.
- (3) Dissolution.
- (4) Increase of the temperature of the atmosphere.

In order, therefore, to maintain a constant radiation, these several factors must be taken into account.

Radium enclosed in metal tubes must be carefully sealed in order to obtain the maximum effect. Each tube should be carefully tested to detect any emanation leak, which may lower the activity of the preparation, and in practical therapeutics lead to serious errors in dosage and effect upon tissues.

Dosage of Emanation in Solution.—The solution most frequently used is water, the emanation being mixed with it in a definite proportion. In mixtures prepared in the laboratory, 1 milli-curie to a litre of water is a usual strength. This preparation is used for drinking. In special cases the strength may be greatly increased.

If the solution cannot be measured in electrostatic units, the testing of small quantities of emanation—as, for example, in mineral springs—results in very small fractions. In order to obviate this, Professor Maché of Vienna proposed to multiply this fraction by 1000.

Maché Unit.—This unit is so convenient that it is made use of at all the well-known spas (where the activity of the water is very low), and by many specialists of radium therapy upon the Continent, who all use the Maché unit for the dosage of emanation.

Dosage when using Flat Applicators.—This will vary with the tissue to be treated and the quantity of radium present in the applicator.

The physiological effect produced upon the tissue will become a practical factor in the calculation of the dose. It is well to determine beforehand the degree of activity by means of the electroscope, and then to apply the applicator for a given time to the surface of the skin in a healthy subject; or, for experimental purposes, an animal may be used. The effect may take some time to appear, so the exposure must not be repeated until time has been allowed for reaction to manifest itself. Having ascertained the reaction time for healthy tissue, it is easy so to regulate the exposure in diseased conditions as to produce the degree of action required. Thus, in simple conditions such as cheloid, nævi, etc., it is only necessary to produce a mild degree of reaction, and keep it up by repeated exposures at stated intervals to get a cure, while for rodent ulcer, epithelioma of the skin, etc., it is sometimes necessary to produce a degree of necrosis of the tumour mass before a beneficial result can be looked for.

Practical experience in the use of these applicators is therefore a *sine qua non* for every radium therapist.

Dosage when the Free Radium is contained in Metal Tubes.—Practically all the effects produced by the flat applicator may be obtained when radium tubes are used. Each tube has a number of filters fitted to it, ranging from $\frac{1}{2}$ mm. to 3 mm.; these filters may be of silver, lead, or platinum, the latter being the best, because it has a greater density than the others, and consequently occupies less space. This is very important when tight strictures of the œsophagus or diseases of the bladder or urethra require treatment.

The small tube in which the radium is sealed is generally $\frac{1}{16}$ to $\frac{1}{8}$ of a millimetre thick, so if superficial areas require treatment, a short exposure of from a half to one hour, with the radium tube enclosed in a thin rubber one, without any additional filter, should suffice to produce a mild degree of reaction. Should a deeper effect or a surface effect free from reaction be desirable, then a thicker filter may be employed, and the exposure prolonged. In all these instances it is the Beta rays (all but the softest) and all the Gamma rays which are used. In some chronic conditions, or in cases of widespread disease, if it is necessary to get deeper effects, the greater quantity of Beta rays are cut off, so that only the Gamma rays are employed. In such cases thicker filters are necessary, 2 mm. of platinum or 4 of lead or silver cutting off practically all the Beta rays.

When using the Gamma rays entirely, the exposure must be greatly

increased, because the percentage of Gamma rays given off from a quantity of radium is very small (about 3 per cent).

In order to get an appreciable effect upon the tissues, long exposures are required, and these will vary with the quantity of radium present and its distance from the tissue requiring treatment. The Gamma ray effect upon the skin is practically negligible when proper precautions are taken within normal limits of exposure. Exposures, with large quantities of radium in well-filtered doses, may be given up to twenty-four hours without damaging the skin. In some instances, where there is ulceration of the surface of a growth, the skin factor in exposure ceases to exist, and then much longer exposure to the surface of the growth can be given, because this surface will bear much longer radiation, and in many instances it is desirable to hasten the ulcerative process. The expression of the radium dose in accurate terms is a matter of considerable difficulty.

We have already dealt with the two methods of expressing the dose in the case of emanation, namely, the milli-curie and the Maché unit.

Unit of Milligram-Hours.—Dawson Turner has introduced an expression of dosage which is thoroughly practical for ordinary use, with certain reservations. He takes the quantity of radium used, and multiplies it by the number of hours representing the time factor of exposure. Thus, 24 hours multiplied by 200 mgrms. represents an exposure of 4800 mgrm.-hours. This takes no account of the activity of the radium used, which may vary from 500 to 2,000,000 activity, nor does it take into consideration the distance of the applicator from the surface undergoing treatment.

It would be better to include the activity (a note being taken of it in all exposures), the time of exposure and the quantity of radium, the thickness of the filter and the distance from the periphery. Thus a record of all exposures should include :

- (1) Time, say, 24 hours.
- (2) Quantity of radium, 200 mgrms.
- (3) Activity of radium, 2,000,000.
- (4) Thickness of filter, 2 mm. platinum.
- (5) Distance from periphery, 5 centimetres.
- (6) Known physiological effect upon healthy skin.

RADIUM IN GENERAL DISEASES

While great claims are made by many authorities of standing as to the efficacy of radium emanation in the treatment of many intractable diseases, it should be pointed out that a great deal of thorough investigation is necessary before these claims can be recognised as of value in a number of these diseases. The chief benefit obtained by patients after taking emanation in solution appears to be a feeling of well-being, and a gradual improvement in the general health.

The blood-pressure appears to be reduced, though, when careful observations are made on the blood-pressure of patients taking radium

emanation, a permanent reduction in it is not easily detected. The patients so treated are generally visitors to well-known health resorts, and while residing there are under dietetic and hygienic conditions which are not so faithfully carried out under other conditions. It is possible that the wholesome *régime* of these resorts, early hours, and restrictions in food and drink are contributing factors to the general improvement; nevertheless there are cases which have benefited from emanation treatment in their homes, while conversely there are many others which do not seem to improve at all.

FIG. 388.—Radiogene. (Siemens.)

The apparatus consists of two vessels, *B* and *F*. Insoluble sulphate of radium is placed in the small receptacle *C* in the vessel *F*.

In order to use the apparatus, the stopper *b*₁, with the vessel *B*, is raised. The vessel *F* is then filled with the water or other liquid which is required to be rendered radioactive. The cork *b*₂ is replaced, and after having removed *b*₁, the vessel *B* is filled with the same liquid, and *b*₁ is replaced.

The emanation, which is given off slowly from the salts of radium, is absorbed little by little by the liquid in the vessel *F*, and as this is drawn off by the tap *R*, it is replaced by a corresponding quantity of liquid from *B*, which runs through the tube *T*₂ and emerges under the receptacle *C* by a little hole provided for this purpose. The air can enter *B* by the water tube *T*₁, but it cannot come out.

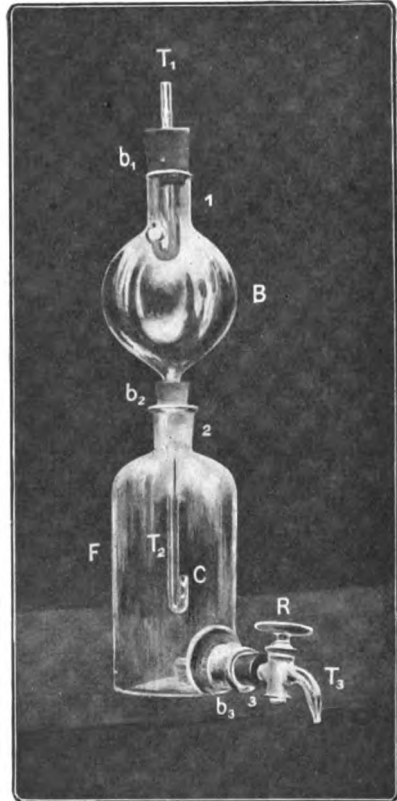

While patients suffering from general diseases, such as gout, diabetes, and arteriosclerosis, are perhaps best treated at a recognised spa, it is possible to treat such cases in hospital or in their homes. Hospital treatment is the better method, because then it is possible to have the patient under control, all contributing factors may be considered, and experimental investigations carried out. These observations should be carried out on a large scale, and an opinion on the value of radium emanation in these diseases reserved until it is possible to compare a large number of statistics.

The strength of the emanation employed must be known, and the daily quantity given measured. Such observations can only be carried out in a hospital or institution which has the necessary accommodation, and a fully

equipped laboratory, where physical data may be standardised, clinical observations made, chemical and bacteriological investigations carried out, and the whole correlated in order to give the information needed. It is satisfactory to know that these conditions are now existent in several institutions, and that a great deal of research work is going on, which when published should go far towards establishing radium as a therapeutic agent of known and proved value.

The administration of radium emanation solution of a strength of not less than 1 milli-curie per litre to patients suffering from chronic arthritis, from whatever cause it may be due, is often followed by marked improvement in the condition of the patient. Cases treated comparatively early in the course of the disease benefit more readily. The condition of the joints is also of importance. The periarthritic variety is the most likely to respond. When there are marked cartilaginous and osseous changes present, little permanent improvement need be looked for. When limitation of movement is due to changes around the joint, and these are not at an advanced stage, some improvement is almost certain to follow. Pain is lessened, the grating in the joint on movement is not so marked, and the muscular and the general tone improve.

RADIUM IN DISEASES OF THE EYE

Mackenzie Davidson has called attention to the marked effect of radium in diseases of the eye, trachoma, conjunctivitis, and catarrhal folliculitis.

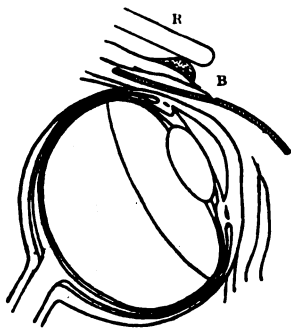

FIG. 389.—Application of radium to the eyelid.

- R. Radium tube.
- B. Growth on upper eyelid.
- C. Lead rubber placed under eyelid to protect the eyeball.

Short exposures are recommended, and the radium should not be screened to any extent. The radium enclosed in a glass tube, or very thin metal filter, is the best form of application, and a few minutes' exposure is all that is necessary. Each case must, however, be treated on its merits, and if short exposures do not produce the effect wished for the time of exposure must be increased.

Rodent ulcers in the neighbourhood of the orbit require special treatment. When situated on the eyelids, the eyeball must be protected when a long exposure is contemplated. A sheet of lead, rubber, or lead enclosed in gutta-percha tissue is moulded to the surface of the eyeball, and placed under the lid to be treated. The applicator is strapped in position for the necessary time. It will be found that comparatively long exposures may be given when these precautions are taken.

The application of the protecting lead rubber to the eyeball will cause pain; this may be lessened by the use of a drop or two of a weak solution of cocaine.

RADIUM IN DISEASES OF THE EAR, NOSE, AND THROAT

In these regions, owing to the scarcity of the supply of radium, and the consequent difficulty of obtaining sufficiently large quantities, its use has been restricted to malignant disease. But it is probable that in the future a large field of usefulness will be found in the treatment of simple inflammatory lesions. In the region of the ear, nose, and throat it will be found extremely useful as a therapeutic agent of great potency, and probably when radium has found its level in the treatment of malignant disease, some of its therapeutic properties will be directed towards the cure of these simpler diseases.

Granulation tissue readily yields to radiation treatment. Hæmorrhage can be controlled, and when a suppurative condition exists, the discharge may be greatly lessened, and eventually dried up. Chronic inflammatory thickenings will slowly subside under properly estimated radiation dosage. Tubes of emanation can be readily moulded to a suitable size for introduction into the ear, nose, and throat.

Papillomata of the vocal chords have been successfully treated. Chronic suppurative conditions of the ear with extensive formation of granulation tissue will slowly subside, and a return to the normal follows.

A good deal has been written on the treatment of deafness by radium. A considerable experience of the action of both X-rays and radium leads one to state that the percentage of cases which show any definite improvement is remarkably small. This is not surprising when we consider the condition of the parts in the majority of the cases of chronic deafness. Now and again a case which is suitable may show a good deal of improvement, but any permanent good result must not be expected. In the majority of cases of chronic deafness the hope of improvement through the use of radium should not be held out to the patient. The treatment of such cases can only bring discredit upon the agent employed.

RADIUM IN THE TREATMENT OF EXOPHTHALMIC GOITRE

It is to be expected that radium should exercise a beneficial influence over this disease. The undoubted success of X-ray treatment led workers to experiment with the radiations from radium. When X-rays alone are used the hard filtered ray appears to be the most useful. Radium may be combined with this either together or alternately. When a patient is too ill to be moved daily to the X-ray room, radium may be applied while he is resting quietly in bed. A prolonged exposure is necessary, extending into several hours, according to the quantity of radium used. Using 100 mgrms. with 3 mm. of lead filter, twelve hours to each side of the enlarged thyroid

gland should suffice to produce marked improvement. The exposures may be repeated in from three to four weeks. After one or two applications a marked diminution of the pulse rate is obtained, this being followed by an improvement in the general condition of the patient. Several exposures at long intervals should be given after the symptoms have improved. Radium may be used when all other remedies have failed. Dawson Turner has recorded the results obtained in the treatment of a number of cases by radium, which are encouraging.

MALIGNANT DISEASE OF THE THYROID GLAND

(See also page 579.)

Radium also plays an important part in the treatment of enlarged thyroid; malignant disease, especially sarcoma, may yield to radium; apparently inoperable cases may be rendered operable, while an improvement in the condition of the patient is almost invariable. The gland diminishes in size, distressing symptoms are relieved, and in some instances the growth diminishes greatly in size. The technique in these serious cases is different from that in cases of simple enlargement. Large quantities of radium must be used, long exposures should be given, and the whole area of the growth and the lymphatic distribution carefully treated. In one case successfully treated, 250 mgrms. of radium bromide filtered through 3 mm. of lead at a distance of 3 inches from the skin were left in position for seventy-two hours, spread over three areas, taking in all the enlargement. The enlarged gland slowly subsided. There was no superficial reaction at all. In three months nothing could be felt of the tumour, except a slight thickening on the right side of the gland. The patient has been examined quite recently, four years after cessation of treatment; the gland is normal, and there are no symptoms of disease in any of the deep organs. In the early history of the case an eminent surgeon had no hesitation in pronouncing the condition malignant and inoperable. Half way through the treatment, when the tumour had diminished in size and the symptoms had abated, he still adhered to the original diagnosis, and expressed the opinion that an operation should be performed. The patient refused to have this done, and treatment was continued, with the result described. In the opinion of all who afterwards saw the patient it was agreed that the condition could not have been malignant, but was probably due to a chronic inflammatory process. Clinically, when treatment was commenced, it was, so far as the effects on the patient were concerned, extremely malignant, *i.e.* causing pressure symptoms which threatened to cause death by asphyxiation, and the gland for a time increased rapidly. From a consideration of the results obtained in a large number of cases of enlarged thyroid with constitutional disturbances, the conclusion has been arrived at that radium offers a prospect of greater and quicker benefit than when X-rays are used. It is, moreover, easier to apply, and the dosage may be given at longer intervals.

RADIUM IN THE TREATMENT OF DISEASES OF THE SKIN

Many of the diseases of the integument respond to radium treatment when other remedies have failed. When the lesion is superficial, it is best to employ the flat applicators. When deeper effects are required, it is necessary to use the Gamma ray with filters. The conditions which are peculiarly responsive to radium are occasionally those which do not give good results with any of the other agents used. Vascular nævi, hairy moles, warts, and rodent ulcer respond well in most cases. Chronic eczema, psoriasis, and other diseases of a like nature readily respond to radium treatment. In place of the flat applicators prepared in varnish, a glass applicator of the requisite shape may be used. This is charged with emanation, and may be applied directly to the skin without a filter, or simply wrapped in a piece of gauze or lint. The advantage of this form of applicator lies in the fact that it can readily be disinfected, and can be repeatedly recharged when required. These glass applicators may be made in a variety of shapes to suit particular cases.

The exposure varies with the quantity of radium used, its degree of activity, and the filters employed. Consequently the estimation of the exposure is always a matter of difficulty.

When large areas have to be treated, it is necessary to continue the exposure over the whole surface by moving the applicator after the adequate exposure has been given. A certain degree of overlapping occurs, but if



FIG. 390.—Circular applicator suitable for the treatment of superficial skin lesions. (Armbrecht, Nelson & Co.)

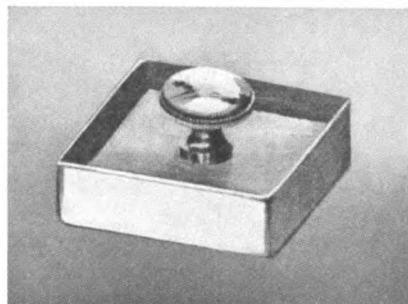
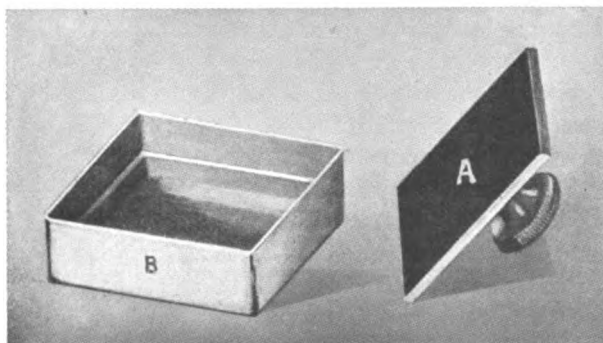

FIG. 391.—Applicator in box. (Siemens.)

This form is particularly useful in the treatment of superficial skin lesions.

the applicator is kept at a distance from the skin by means of several layers of lint, the danger of an overdose to a particular area is greatly diminished.

Psoriasis.—Other methods, notably X-rays filtered, give good results. The technique is similar to that employed in chronic eczema. When the radium is enclosed in platinum tubes, the same procedure is necessary, but it must be remembered that in this case a hard ray is being employed, because $\frac{1}{3}$ to $\frac{1}{2}$ mm. of platinum (the average thickness of the tubes used to hold the radium) is known to cut off a large percentage of the Beta rays as well as the Alpha rays. To obtain the same area of action as when the flat applicators are used, two or more of the small tubes may be employed, longer exposures being necessary. When using unscreened applicators the exposures will be short, and given at frequent intervals on several successive days. Then an interval of two or three weeks is allowed to elapse before treatment is resumed. This disease is apt to recur at long intervals of time, and several series of treatment may be required.

Eczema.—The use of radium in the treatment of these conditions must necessarily be limited to cases which are circumscribed, *e.g.* chronic cases which have resisted all other forms of treatment may receive the stimulus necessary to start the healing process. Flat applicators or tubes may be employed, the exposures varying with the filtration. A flat applicator containing 5 mgrms. of radium, spread over a surface of 2 by 1 cm., will give a marked reaction in from forty to sixty minutes. One application may lead to a marked improvement, though several will be necessary in most cases. Shorter exposures will frequently give real improvement, and these should be repeated at intervals of several days, until a slight superficial reaction appears. When this subsides the condition gradually improves. Treatment should be repeated in a fortnight to three weeks' time, and the case should be kept under observation for several months, in order to check the earliest appearance of a recurrence.

Nævus.—Radium possesses a great advantage over other methods of treatment in that its use is painless, and that there are no distracting noises from active apparatus. In children this is important. Nævi may be treated in young infants, the applicator being strapped in position and left for the required time. Further, applicators may be made to fit angles or may be inserted into the cavities of the body or into the interior of an ulcerated cavity or the substance of a growth.

In treating nævi it is necessary to give frequent exposures to the part. After a time, usually a week or ten days, reaction of the surface appears. This may be all that is required, the resulting changes from the inflammatory processes induced in the tissues leading to a disappearance of the vascularity. Should the application not be sufficient to induce these changes it must be repeated. The results obtained cannot be surpassed by any other remedy, and the process is quite painless, a most important point where young children require to be treated. The resulting scars are soft and flexible, and in time the skin takes on quite a normal appearance. The time required for thorough treatment is sometimes a drawback, but if the treatment is carefully carried out the result amply repays the trouble taken.

It is a good routine method to begin treatment in these cases with

unscreened applicators, and give short exposures. Time should be allowed between the exposures to determine the degree of reaction. It is most important not to overdo the exposure, because if this occurs troublesome telangiectasis will follow. If this happens it may be necessary to treat the condition with electrolysis, or better still, the point where the dilated vessels appear may be treated with a diathermy needle. Very good results will follow these applications. In some cases it is better to treat these conditions at once with electro-coagulation.

Nævi may be classified clinically as follows :

1. *Flat Superficial Nævi*.—These respond well to radium treatment. In selecting cases, the deciding factor is the degree of vascularity. If the parts blanch well when pressure is applied, the probability is that the response to treatment will be good.

2. *Capillary Nævi*.—These also respond well, but before beginning treatment with radium other methods should be carefully considered, for carbon dioxide snow, electrolysis, or diathermy are all very efficacious.

3. *Port Wine Stains*.—This variety is not at all easily treated. The stains respond slowly, and require repeated treatment, and often in the end the result is not good. These remarks apply, however, to any other line of treatment.

4. *Cavernous Nævi*.—As a rule, these respond very well. Filtered rays should be employed, and the exposure may be given at one sitting, or if more convenient it may be divided into several of two hours' duration on successive days. Reaction on the surface is not desirable, and can be avoided by adequate filtration.

Superficial Papillomata (Warts).—These may be successfully treated in nearly every case if the dose is accurately estimated. They tend to reappear if treatment is discontinued too soon. An exposure of one-half to one hour with an unscreened apparatus will cause reaction and lead to a gradual disappearance of the wart. The tendency is for recurrence, and the radium exposures may be repeated when necessary.

Lupus Erythematosus.—An improvement in this condition may follow radium treatment, but the exposures require to be continued for long periods and at frequent intervals. X-rays and the mercury-vapour lamp often give quite as good results.

Lupus Vulgaris.—This is a condition where many methods of treatment may require to be used. There are cases where radium appears to be the best of all; others respond to X-rays, and others again to the mercury-vapour lamp. When the disease is situated in the neighbourhood of the nose, radium is the most useful agent, because it can so conveniently be applied to the interior. The screened rays appear to act best, but in some cases an emanation tube with a rubber tube over it gives excellent results when long exposures are given.

Cheloid.—Extensive cheloid is a condition which slowly responds to radium treatment. The exact line of treatment must be determined for each individual case. Radium of low-grade activity is used on flat applicators

without other filtration than that of the varnish and a thin layer of gutta-percha tissue, the latter being employed mainly to protect the surface of the plaque. The whole of the scar tissue should receive an equal amount of radiation, and care should be taken that the edges of the cheloid and the adjoining healthy tissue are also treated. Until the operator knows the activity of the applicator, it is well to give a preliminary exposure over a part of the cheloid for, say, an hour, and then to wait until reaction shows itself. Having thus ascertained the necessary degree of reaction, the whole of the scar tissue can be radiated, an equal exposure being given to every part. A moderate degree of reaction is necessary, and treatment should be suspended until this has subsided. The exposure should then be repeated, the duration of time being increased or diminished according to the results obtained from the preliminary exposure.

When the radium is enclosed in platinum tubes the procedure is the same, but in this case it must be remembered that a harder ray is being employed, because $\frac{1}{3}$ to $\frac{1}{2}$ mm. of platinum (the average thickness of the tubes used to hold the radium) is known to cut off a large percentage of the Beta rays as well as all the Alpha rays.

To obtain the same area of action as when using a flat applicator, two or more of the small tubes may be enclosed in a larger applicator, thicker on one side than on the other; such an applicator is shown in Figs. 374 and 384. The time of exposure must be proportionately lengthened according to the thickness of the radium tubes, and the external filter employed.

With applicators having tubes of a thickness of $\frac{1}{2}$ mm., the exposure may safely run into four to six hours. With a filter of 1 mm. the time might be extended to six or eight hours, and with a filter of 2 mm. or more the exposures may be up to twenty hours.

In all these instances the employment of two or more layers of surgical lint is recommended, this also serving the purpose of preventing damage from secondary radiations produced in the filter. Gratifying results have been obtained in the treatment by radium of cheloid scars resulting from gun-shot wounds of the face and neck in soldiers.

Leucoplakia.—This condition responds readily to radium. In situations such as the mouth, tongue, etc., radium is probably the best therapeutic agent which can be employed, largely on account of the ease with which it can be applied to the leucoplakial patch. This condition is frequently a forerunner or an accompaniment of cancer. When the latter disease has established itself, it renders the prognosis more grave, though very early cancer may be healed for a time at least.

Prolonged treatment is necessary, and the radium application has to be well screened to avoid damage to the healthy tissues. When large areas require to be treated it is advantageous to combine X-rays with the radium, thus enabling the area to be more rapidly treated. Special portions may be subjected to a longer radium exposure.

Pruritis.—In the treatment of this disease advantage is taken of the well-known analgesic powers of radium. The condition is accompanied by

a degree of chronic infiltration of the skin, and the object of treatment is, therefore, to restore the skin to a normal condition before a permanent benefit is obtained. In chronic cases this is extremely difficult. A marked degree of reaction is necessary, and this may lead to an aggravation of the symptoms for a time. Patients are consequently discouraged, and it is difficult to induce them to continue a treatment which appears to be doing more harm than good. If treatment is persevered with, marked benefit will follow in a large percentage of cases. Filtered rays and long exposures are necessary; 1 mm. of silver or lead should be employed, and several layers of lint interposed between the tube and the skin. In other cases it may be necessary to use filters of platinum up to 2 mm. Twelve to fifteen hours' exposure of 50 mgrms. of RaBr_2 may be given, and this dose repeated in three to four weeks, care being taken not to overdo the exposures.

RADIUM IN GYNÆCOLOGICAL PRACTICE

The diseases in which radium will be found most useful are :

- (1) Chronic endocervicitis.
- (2) Chronic endometritis.
- (3) Leucoplakia vulvæ.
- (4) Cancer.
- (5) Fibro-myomata.

A short description of the technique in each of these diseases is necessary, with an approximate estimation of the results and degree of benefit received.

Chronic Inflammatory Conditions of the Cervix.—These may be treated by two methods :

1. The introduction of a metal tube containing radium into the cervical canal, with additional tubes arranged in the fornices, around the lips of the cervix, when disease is situated here. The metal tube can be firmly fixed to a sound, to facilitate its introduction.

2. An emanation tube can be made to suit the particular case requiring treatment. It is charged with the emanation, so as to allow of full activity at the time of application. It is possible to have the applicator so made as to contain emanation equal to 100 mgrms. of radium or more in a very small cubic space, or if it is desirable to weaken the action, the applicator may be made larger, and the gas allowed to diffuse itself over the larger space.

The size and shape of the applicator and the quantity of radium or emanation to be used being thus arranged, the next matter is the exposure. This is largely a matter of experience, and each case must be judged on its own merits.

Chronic Endometritis.—When there has been considerable hæmorrhage which cannot be controlled by other methods, a radium tube may be introduced into the body of the uterus. The rays will often check the hæmorrhage, and also the seropurulent discharge which accompanies the

condition. The exposures should be long, and filtration is necessary if it is desired to influence changes in the deeper layers of the endometrium. The treatment should be continued at intervals of three to four weeks, until the condition has returned to a normal state.

Leucoplakia Vulvæ.—This condition, which causes much discomfort both mentally and physically, is frequently greatly relieved, and often occasionally quite cured by thorough radiation treatment. In



FIG. 392. — Uterine sound with radium tube at extremity. A suitable applicator for introduction into cavity of uterus. (Suggested by Mr. Lionel Provis.)

some cases X-rays are found to be more useful than radium, while in others radium acts like a charm. Sometimes it is well to apply a radium tube to those portions of the affected area where the disease seems most active, and to treat the more widely but less deeply affected skin areas with X-rays. By combining the agents it is often possible to get much better results than when either is used separately. The exposures should be frequent, once or twice a week for several weeks. When frequent doses are given, filtration is necessary, and it should be increased in proportion to the frequency of the dosage. The radium should be applied in large quantities, filters of 1 to 2 mm. of platinum enabling exposures of up to twenty-four hours to each area to be given. In the early stages of treatment, however, it is better to give divided doses with light filtration, and wait for a reaction on the skin. If this relieves the irritation (it occasionally increases it) it is best to wait till this reaction subsides, and then give another dose, filtered this time, and then repeat, increasing the filtration and duration of the exposure. When all irritation has subsided, it is advisable to continue treatment for several months, in order to carry on the beneficial action of the rays.

Cancer of the Cervix Uteri.—Radium treatment may also benefit this condition. Hæmorrhage and discharge are lessened, and great relief from pain is a frequent result of treatment. Active treatment by radium in cancer of the cervix has yielded encouraging results. When possible, several tubes should be used. One is introduced into the cervical canal, and the others placed around the cervix, these being packed in position with tampons. When a preliminary partial excision has been performed, the radium tubes are introduced while

the patient is under the anæsthetic. In all cases requiring treatment the use of an anæsthetic allows of the placing of the radium in correct position, and greatly favours the prospect of improvement. Several cases of early carcinoma so treated have done remarkably well. Continental writers who have been using radium and mesothorium, claim that the operative treatment of cancer of the cervix is no longer necessary. No

doubt time and a larger experience will lead them to considerably modify this opinion, but the results obtained by radium treatment may compare very favourably with those obtained by operation. The tendency to recurrence exists when either mode of treatment is followed. Time alone will show in which group of cases the larger percentage of cures occurs. Further, radium and mesothorium technique may improve, and so lead to improvement in the results obtained. Up to now the hard ray only has been most largely employed. The softer Alpha and soft Beta rays have all been excluded by filtration. It is possible that by using emanation in properly shaped and suitably sized glass tubes, which will allow the softer rays to get through, a more favourable action may be induced. The small sharp-pointed tubes described on page 503 will be found most useful in the treatment of these conditions.

Exposures of Radium in treatment of Cancer of the Cervix.—This is always a matter of difficulty, the duration depending upon the object to be attained. In all cases a filter of at least 1 mm. thick is necessary. An exposure of six hours will lead to considerable reaction. This should slowly subside, and cicatricial changes set in. When 2 mm. of platinum are used the exposure will be proportionately longer, twelve to fifteen hours or longer being necessary. In advanced cases, where there is a considerable amount of ulceration, and the radium tube can be placed in position completely surrounded by growth, much longer exposures may be made (see page 507); twenty-four hours or more will result in the breaking down of the ulcerated surfaces and the replacement of the tumour tissue by fibrous tissue. In early cases it is well to proceed with caution, giving short exposures at frequent intervals, and carefully watching for reaction and improvement. When the latter sets in it should be continued by judiciously administered doses until the whole of the growth has disappeared. When such a fortunate result is obtained, it is still necessary to continue treatment with thicker filters, in order to reach the outlying portions of growth. In the experience of several workers an apparent cure of the local condition has been followed in a short period of time by involvement of the deep pelvic glands, and a rapid development of these has led to the death of the patient.

While radium does not appear to exercise any specific influence over these growths, it is probable that if the radiations could be applied in sufficient intensity the growth might be mitigated. It is possible that the doses given for the local condition may have exercised a stimulating effect upon the more distant portions of the growth. In all exposures the ruling factor is the quantity of radium used. The doses suggested above are taken as for 100 mgrms. in $\frac{1}{2}$ mm. platinum tubes, and at least 1 mm. of silver. When the $\frac{1}{2}$ mm. tube alone is used, the exposures are proportionately less.

Treatment of Fibromata.—The technique described in the treatment of these conditions by X-rays shows the type of case likely to derive benefit from the treatment. The same types can be successfully treated by radium, and the technique will depend upon the quantity of radium used. The exposures may be made in four directions :

- (1) Through the anterior abdominal wall.
- (2) From the perineal aspect.
- (3) Tubes can be introduced into the interior of the uterus and vagina.
- (4) From the back.

The two agents may be combined : X-ray exposure should be made in the usual way, and a radium tube or tubes introduced into the vagina and left there for the necessary time. Mesothorium can be used instead of radium, or to supplement its action when the quantity of the latter available is not sufficient.

RADIUM IN SUPERFICIAL EPITHELIOMA AND RODENT ULCER

These are numerous, and occur in many situations in the body. Superficial, mildly-malignant epitheliomata yield readily to radium treatment, a few exposures of several hours' duration to a case of this kind ending in a healing of the surface. Such cases, however, yield quite as readily to X-ray treatment. The vegetating cutaneous epithelioma comes under this heading, and it is well also to include the most common of all superficial lesions—the rodent ulcer.

Early cases are readily influenced by treatment. They quickly heal, but prophylactic doses should be given after the ulcer has healed. If the condition is quite superficial the filtration need not be great. The Beta rays appear to exercise a profound change in these cases. After healing has taken place filtered doses should be used to reach the deeper parts. Even after thorough prophylactic treatment recurrences are apt to follow at longer or shorter intervals, but frequently respond to further treatment. All cases treated should be kept under observation for a considerable time in order that an early stage of the recurrence may be observed and promptly treated.

When the ulcer is large and involves bone and cartilage the prospect of a cure is not so good. Most complete and powerful dosage may fail to check the progress of the disease. These cases may even be stimulated by radium treatment, and increase rapidly in size. In such cases it is better to combine surgical measures, such as scraping or excision, with radium treatment. Several cases so treated have healed and remained well. These occur in many situations, but most commonly on the face, at the angle of the mouth, and on the outer or inner margin of the orbit. Many of these heal readily, and remain healed ; others heal, only to break down after a more or less lengthy interval. Recurrences may be treated as they occur.

There are several methods of treatment for this condition :

- (1) Short exposure to radium, with practically no screening. A marked reaction may be induced, which may end in ulceration if the exposure has been unduly prolonged. When this subsides, the ulcer heals and a healthy scar results.

(2) Long exposures with thick filters of 2 or more millimetres of lead. The Gamma ray is almost exclusively employed in this manner.

(3) Combined X-ray and radium exposures.

It has been observed that a case which fails to respond to radium may respond to X-rays of a hard type, and *vice versa*. This is contrary to the opinion expressed by several authorities, who maintain that a case which has failed to improve under radium treatment will fail to do so under X-rays. Some assert that a case which has not benefited from X-rays, and which has had prolonged X-ray treatment, fails to show improvement when treated by radium. Others say that radium invariably heals such cases.

In the experience of the writer, cases respond to X-rays and radium according to the state of activity of the ulcer at the time of treatment. The ulcer which has failed to improve with radium will sometimes clear up in a remarkable manner when subjected to a long exposure of hard, well-filtered X-rays.

The explanation of the conflicting opinions probably lies in the fact that it is a particular type of hardness of radiation which is necessary for the therapeutic effect, and when this type is available, it matters not whether it is produced by X-rays, radium, or any other radio-active body. In many of the cases treated which do not improve, or which get rapidly worse, we have not been using the correct quality of ray or the exposure has been too short to produce the effect which should result in healing. This is probably the explanation of the conflicting results obtained by many workers.

Since the foregoing matter was written nearly two years have elapsed, and a number of the cases described and illustrated in these pages have been under observation. The after history of each case has been appended to the illustrations, in order that readers may form an opinion of the effects and value of radium in the treatment of rodent ulcer and epithelioma. In the interval a large number of new cases have been treated; these, when the disease has not been advanced, have nearly all responded promptly to treatment, and have healed up. So far as is known they have remained healed. In the last four years a number of early cases of rodent ulcer have been successfully treated. The readier response to treatment in the later cases has been very marked, and the percentage of cures proportionately larger than in the earlier days when the estimation of the dosage was more or less guess-work.

The conclusion arrived at in an attempt to explain the improved results is that, as the result of observation and experience in dosage, a better understanding of the manipulation of the radium has been arrived at.

In the initial experiments, in an endeavour to ascertain the best working conditions of radium dosage, a flat applicator was used. On this the radium was spread and then varnished over to prevent damage; merely a sheet or two of gutta-percha tissue was used between the surface of the applicator and the skin.

In a number of cases of well-defined rodent ulcer and epithelioma the response to one exposure, or at the most two exposures, has been really

remarkable. If the dose had been worked out accurately, the ulcer cleared up practically after one application.

A more recent group of cases, treated with two radium tubes, yielded quite as good results.

In order to explain as nearly as possible the technique, it is necessary to enter at some length into the exact conditions under which the radium was used. Two small tubes of platinum about 2 cm. long by 2 mm. broad were used, each containing 30 mgrms. of radium bromide; the thickness of the wall of each tube was $\frac{1}{2}$ mm. These tubes were placed side by side, and an additional filter of $\frac{1}{2}$ mm. of lead was used in the majority of the cases. The exposures varied from one to four hours to any particular area, and when a large growth or ulcer was treated, it was divided into areas each receiving the same dose. A most successful case is shown in Plate LXXXVIII., where a fairly large rodent ulcer was divided into four areas, each receiving three hours' exposure under the above-mentioned conditions.

The reaction following upon this exposure was fairly well marked; the response to the treatment, as will be seen from the photographs, was extremely gratifying. Several exposures were given at intervals with thicker filters as a precautionary measure, but the belief is that the one dose was sufficient to bring about the healing of the ulcer. It was realised at the outset that if a result could not be promptly achieved, the probability was that harm would result; under-dosage would have meant stimulation of the growth and possibly a rapid increase of the ulcer. It was felt that a maximum dose for this particular growth would give the best chance of a good result.

The important point in this case, and, indeed, in all cases, is that *to be successful in the treatment of any diseased condition by radium the dose must be accurately estimated, and the maximum dose given at the first treatment.* Many cases receive no benefit at all, because the dose is either too strong or too weak. In either case most untoward results may follow.

The difficulty is to estimate the correct dose in each case, for however well we may know the activity of the radium and the conditions under which it will give the best results, we must also be able to estimate the activity of the new growth and the likelihood of its response to radiation treatment. A number of cases may be quite unsuitable for radium or X-ray treatment. The ability to recognise this characteristic of a tumour must be more or less guess-work until further experience gives us some definite data to go upon.

Experiences such as those described give us food for thought, and no doubt as knowledge accumulates it will be easier to obtain the results desired. In the meantime let us go steadily on, patiently observing and recording facts which may be of general use at a later date.

The recognition of our failures and the causes which led to them may help us to understand our successes, and by analysing both we may be able to arrive at some more definite principles for our future guidance.

It is not out of place here to enter a strong protest against the indiscrimi-

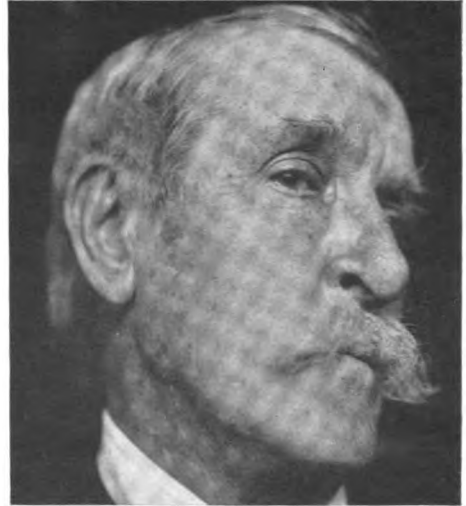
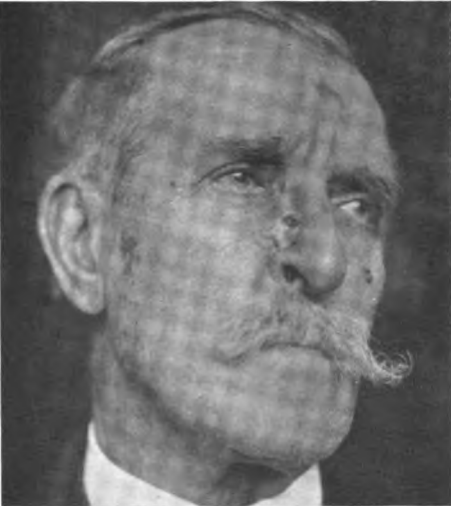
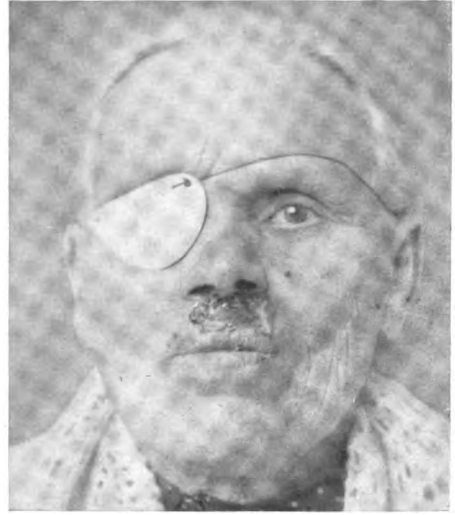

PLATE LXXXVII.—RODENT ULCERS TREATED WITH RADIUM AND X-RAYS.

a, Rodent ulcer of upper lip, showing rapid improvement under combined X-rays and radium treatment. The disease progressed in spite of all treatment.

b, Rodent ulcer of side of nose which rapidly healed after radium had been applied. The ulcer re-appeared after about nine months, but again quickly healed after further treatment. The scar broke down and the ulcer extended, repeated recurrences healing under treatment. The patient has been under observation for about five years and is still receiving small doses of X-rays ($\frac{1}{4}$ p.d.) at short intervals.

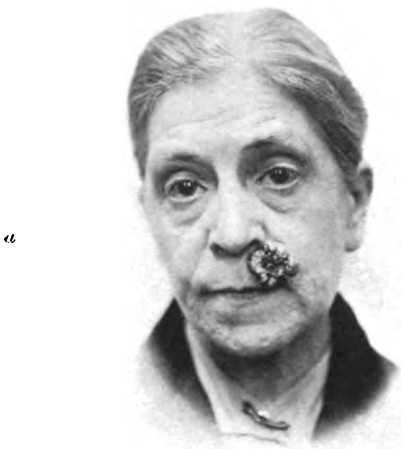

PLATE LXXXVIII.—RODENT ULCER OF UPPER LIP, TREATED WITH RADIUM.

History of the case: duration of ulcer, 10 years, growing more rapidly in last few months.

The technique was as follows:—Two small tubes of platinum $\frac{1}{2}$ of a mm. thick, each containing 30 mgrms. of Radium Bromide; additional filter $\frac{1}{2}$ mm. of lead, with 2 layers of lint. The ulcer was treated in 4 areas, each receiving three hours' exposure—that is, twelve hours in all to the whole of the surface of the ulcer.

Photograph (a) shows the condition when treatment was commenced, June 8, 1916. (b) July 7, 1916, showing marked improvement in the condition. A further exposure of two hours was given to the upper edge of the ulcer. (c) July 30, showing a slight increase of the ulceration at upper border of the ulcer. On August 23, 1916, a further exposure was given to the lower and outer edges of the ulcer. (d) September 4, 1916. Ulcer completely healed. This case illustrates the importance of an accurate estimation of the initial dose. From the commencement the progress was uninterrupted.

nate use of radium by experts and non-experts, the practice of which has only resulted in bringing discredit upon the experimenters, and has greatly hindered a proper appreciation of radium as a curative agent. The time has long passed when this practice was excusable. In the interests of the public, which is largely guided by its medical men on these matters, it should be clearly understood that radium has distinct limitations in the treatment of disease, and particularly in the treatment of cancer, where it has been so liberally exploited. No treatment by radium should be undertaken unless the matter has been thoroughly gone into in consultation with surgical and radium experts; the possibilities of relief or cure should be thoroughly discussed. It is not sufficient to undertake the treatment of a growth by making an incision into it and inserting a tube of radium or emanation; more than that is required, and a thorough knowledge of the action of the particular quantity of radium used is necessary. In the light of the experiences quoted, it would appear that if the action is understood, the dose may be approximately calculated for each case.

The technique which should be employed will have a bearing on the result. In one case 50 mgrms. may be sufficient, while in another 300 or 400 mgrms. may be necessary, and the duration of the exposure may vary proportionately. In one case one tube may be all that is necessary, while in a second case the radium may require to be distributed over a large area in ten or more tubes in order to obtain a uniform distribution of radiation.

One application may lead to a good result, and in another case it may require a large number of treatments to obtain the same result.

Considerations such as these ought to restrain the inexperienced from venturing upon treatment of which he knows nothing.

Ulcers situated near the orbit, nasal cavities, or angle of the mouth require modifications in the treatment. Near the orbit, care must be exercised that the eyeball and conjunctiva are not injured. When it has become involved by the growth, it is better to remove it and thoroughly scrape the surrounding tissues. The following types of rodent ulcer have been treated with more or less success:

Superficial epitheliomata of the side of the face, a thin widespread superficial growth without ulceration. This type readily responds. Some of these cases are surrounded by nodules, which generally disappear slowly but surely. The common situation is in the malar area. The lateral aspect of the nose is another area which is often affected, the ulcer tending to spread into the orbit. For both these types the flat applicators with very light screen are advocated at the commencement of treatment; later the thicker filters should be employed. Ulcers which tend to extend downwards into the tissues and spread locally are more difficult to deal with. Such ulcers are very apt to recur after treatment is stopped; deep filtration should be employed in these cases. When cartilage and bone are involved, the cases do not yield so easily. Prophylactic treatment should be carried out for some time after an apparent cure, in the hope that a recurrence may be prevented.

In regard to the practical application of radium to this latter type of case,

it may be claimed that when the growth is not very malignant, radium should be given a good trial ; the percentage of cures obtained compares favourably with the percentage obtained in cases which are operated upon. The results are better than those obtained by operation, in that the scar is soft and pliant. The convenience of application and the freedom from pain and discomfort are also factors in favour of radium treatment. When time is of value and æsthetic considerations of no great moment, the operative method gives a speedier result. Surgical measures may be profitably combined with radium treatment. Excision or scraping of the actual growth and after treatment by radium will often give a better result than when radium alone is used. Diathermy is useful in cases of this kind and it may be used as a preparatory measure to radium application.

RADIUM IN INFILTRATING EPITHELIOMA

These conditions occur in the preauricular and other regions. They show peripheral inflammatory changes with a thickened edge. They tend to heal spontaneously in parts of the surface. The treatment in these cases must be rigorous. Deep penetrating rays should be tried after superficial healing has taken place, and a number of prophylactic doses should be given. An obstinate variety of this class is found in or round the auricle, and frequently inside the meatus. Radium tubes may be introduced into the auricle and left there, marked inflammatory reaction being necessary before any improvement can be expected.

Epithelioma are also met with inside the nose and on the temple. A form very difficult to deal with successfully is the type met with at the junction of skin and mucous membrane. Because of the mixed character of the cutaneous surfaces the growth presents two aspects for treatment, that involving the skin on one side and the mucous membrane on the other.

The eyelid is occasionally the seat of these growths. Care must be taken to protect the organ of sight. Screens of lead with lint underneath are required, and great care must be taken to ensure correct apposition of the radium to the ulcer. Epithelioma of the nasal mucous membrane is a form commonly met with, and one in which it is extremely difficult to secure healing which will be permanent.

A complete excision of the spreading edge and subsequent thorough prophylactic treatment are measures which commend themselves to the rational-minded radium therapist. A large percentage of these cases go from bad to worse, in spite of the most vigorous radium treatment. They may, however, heal up for a time, but only to break down again. It is only proper, however, to point out that a number of these cases have been operated on, and repeated recurrences developed. Operative measures to be successful must be thorough.

Glandular enlargement when present must be very thoroughly treated. Such enlarged glands yield very slowly to treatment when they are undoubtedly malignant. Some cases of undoubted carcinoma of the tonsil or

breast, with many enlarged glands, have been successfully treated. It must be borne in mind that, when glands appear and rapidly enlarge in cases where the primary growth is in a situation where a mixed infection is possible, a part of the enlargement may be due to an inflammatory process super-added to the malignant. Such cases rapidly yield to radium treatment.

After a growth has disappeared under radium, it is important to continue the applications for a considerable time, at regular intervals, in the hope that recurrence may be prevented. The area immediately surrounding the growth should receive thorough irradiation, and also the area of lymphatic drainage.

RADIUM IN SARCOMATA AND CARCINOMATA

These on account of their greater extent, deeper infiltration, and more rapid growth are classed among the actively malignant group. The growth may begin in the same situations as the preceding, and are often at the commencement indistinguishable from the less malignant. It is on this account that the need for early operation as an alternative to radium therapy must be well borne in mind. Such cases frequently fail to respond favourably to radium, and a percentage take on a more rapid growth as a consequence of the stimulating effect of the treatment. Treatment must be pushed rapidly to the extreme limit, and if the response is not equally rapid and successful then the question of operative measures must be at once considered.

Sarcomata.—The round-celled variety seems to be the type of growth most readily influenced by radium. Large tumours may gradually diminish in size, smaller growths disappear, while secondary glands also clear up. The spindle-celled variety is not so readily dealt with, possibly because it is a more active type of growth. When the mediastinum is involved, exposures may be made over the sternum and ribs in the hope that the disease may be checked. The insertion of tubes containing radium into the tumour mass is the most practical method of treatment. Several tubes may be inserted at points equidistant, in order that the radiations may be equally distributed throughout the growth. The exposure depends upon the quantity of radium used, the size and type of the growth, and the filtration employed. In a large tumour, a tube containing 50 mgrms. with .5 mm. filter may be left *in situ* for twenty-four hours.

When the growth is very large, several tubes introduced at equal distances from one another may be left for the same time. In any particular case when, after the first exposure, no marked necrotic changes have resulted, the treatment should be repeated, and, if necessary, the exposure may be considerably prolonged until the desired result is obtained. When the exposure has been accurately estimated, the tumour slowly subsides without any necrosis. This is the ideal method of treatment, but it frequently happens that the correct exposure has not been given, and either no favourable change is induced and the growth increases in size, or it becomes necrotic, and sloughing takes place. An attempt should always be made to treat the

outlying edges of the growth and the surrounding healthy tissues. Prophylactic treatment should be continued for several months after healing has resulted.

Recurrent sarcoma may be treated by external applications of radium, several cases so treated having cleared up and these still remain well. The quantity of radium used should be as large as possible, 200 or 300 mgrms. in platinum tubes, with 2 to 3 mm. filter of lead and about twelve layers of lint between the radium and the skin surface. The area to be treated may be divided into several portions, and an exposure of twenty-four hours given to each.

Cancer of the Breast.—This class of cases forms a large percentage of those sent for radium treatment.

Secondary deposits may be met with in the glands of the axillary and supraclavicular regions. These may be treated at the same time as the primary growth. Secondary deposits in the cartilage of the ribs or sternum may also require treatment. Prolonged exposures to large quantities of well-filtered radium have in several instances led to a diminution in the size of the growth.

The rapidly growing columnar-celled carcinoma may be treated with a measure of success. Tubes containing radium should be buried in the growth, and left for long periods. A diminution of the growth may be looked for, but the prospect of a cure is extremely remote. Less rapidly growing cases are more amenable to treatment. The atrophic scirrhous cancer is the most favourable type for treatment. In some cases a necrotic action can be induced, and the subsequent ulcer gradually heals. Glands should be treated at the same time, and after healing has taken place, prophylactic treatment should be carried out for a considerable time.

Cancer en Cuirasse.—This variety often responds well, for a time at least. Enlarged glands, which may be inflammatory in character, are a frequent seat of late involvement. This is probably the result of direct spread by means of the lymphatic stream. An inflamed gland offers a suitable soil for the development of cancerous cells. Radium, by inducing fibrosis, tends to seal up the new growth, and so prevent its spread.

Partial success in dealing with these conditions may lead to a prolonged quiescent stage, which may resume active growth later. The object of the prophylactic treatment is to prevent this late recurrence.

Recurrent Cancer.—Secondary growths involving cartilage and bone appear after amputation of the breast. Several cases of this class have been treated with marked success, with radium applied in large quantities for long periods, care being taken to protect the skin. One patient has been under observation for about four years. The secondary deposit was well advanced, and involved bone and cartilage close to the sternum. Long exposure to radium at regular intervals led to an arrest of the growth. The patient is still having treatment at longer intervals of time. A fairly-marked skin reaction may be obtained after long exposure to filtered radium, this slowly subsiding and resulting in no permanent damage.



PLATE LXXXIX.—RECURRENT CARCINOMA AFTER REMOVAL OF BREAST.

a, Recurrence in scar after operation for carcinoma of the breast, treated wholly by X-rays.
b, Recurrence in scar involving sternum and ribs after operation for removal of carcinoma, treated with radium, prolonged exposures with 200 mgrms. of radium filtered through 3 mm. of lead. Patient remained well for a considerable time; small recurrences appeared at the periphery of the scar. When last seen the patient was moderately well.

Recurrence after operation frequently requires treatment. Small nodules readily respond, and often entirely disappear. Enlarged glands are reduced in size. Radium applicators may be used directly over particular glands or groups of glands with a fair measure of success. In a number of cases, where there is a possibility of doing good, radium tubes may be inserted into the recurrent mass.

Radium, in the treatment of diseases of the breast, should be strictly confined to cases which for some reason are unsuitable for operation. Early cases might be treated, were it possible to place complete reliance upon radium as a curative agent. Cases have been treated, and have done well,

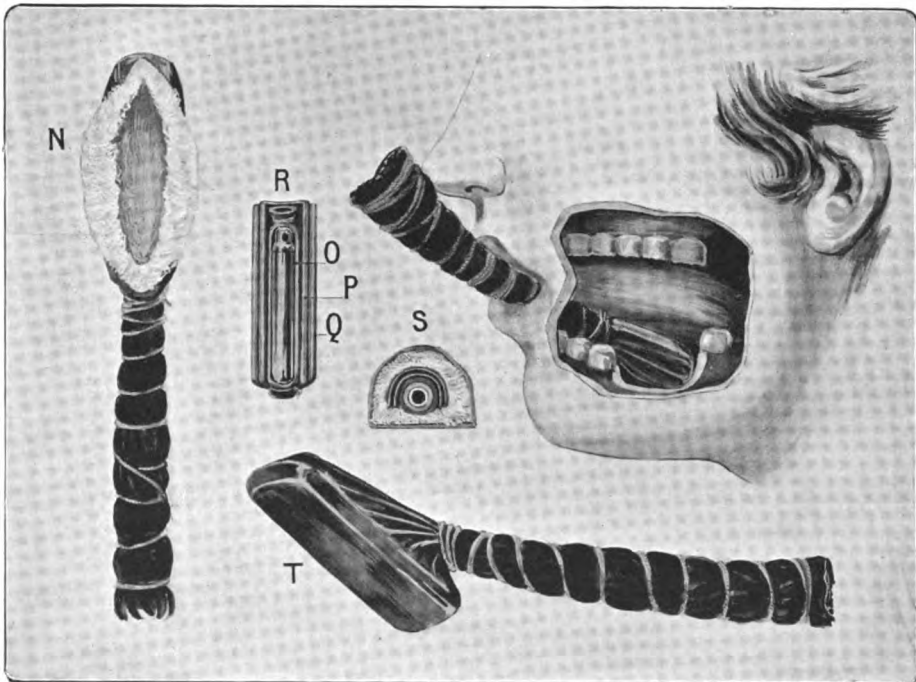

FIG. 393.—Radium tube arranged for the treatment of the floor of the mouth. (Siemens.)

N shows applicator in protective material with handle. *O*, radium tube. *P*, rubber filter. *Q*, protective material. *S*, cross section. *T*, flat applicator arranged in a similar manner.

but in the present state of our knowledge it is impossible to give radium the first place in the choice of a remedy. In all cases of early cancer the operative method is undoubtedly the best; it is quicker, safer, and offers the best prospect of a cure. It must, however, be stated that X-rays are, in selected cases, quite as useful as radium. In patients who refuse operation, or are for other reasons not suitable for operation, radium is a useful remedy. In inoperable cases radium may help to render the case operable, and failing that it is undoubtedly useful as a palliative measure.

When a large tumour of the inoperable type has to be treated, it is useful to combine X-rays with radium. The former can be used to irradiate

rapidly the tumour area and the lymphatics draining it, and after a time, when the tumour has subsided, radium tubes may be introduced into the substance of the growth and left *in situ* for two days, or longer if necessary. The treatment results in considerable shrinkage in the size of the tumour, and it is quite possible to render an inoperable case operable.

The classification of cases for radium treatment is similar to that given under X-ray therapeutics.

RADIUM IN CANCER OF THE TONGUE AND MOUTH

This condition is frequently sent for radium treatment. Tubes may be buried in the growth, and benefit is occasionally obtained, though in this class of case, as in many others, operative measures should come first. Temporary benefit may follow, but sooner or later recurrence shows itself, and this may take on a very active form. Cancer of the floor of the mouth is a condition which does not respond favourably in a large number of cases treated. Radium needles will be found useful in these conditions since they offer a most convenient method of treatment. When possible, tubes should be buried in the growth. When this is not done, a useful form of applicator may be used (see Fig. 393). A window can be cut in the lead tube surrounding the radium tube, the rays passing through the window directly on to the growth, while the surrounding tissues are protected to some extent by the thick lead.

RADIUM IN CANCER OF THE ŒSOPHAGUS

A number of cases have been treated with a beneficial result for a time. Some of the patients have gained weight, and retained the use of the



FIG. 394.—Radium tube in an œsophageal tube, arranged for the treatment of an œsophageal growth.

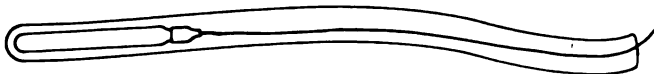

FIG. 395.—Tube arranged on a length of pliable silver wire. This is a convenient form of applicator for the treatment of growths in the lower half of the œsophagus. The wire keeps the radium tube in position, and it is fixed outside the mouth with adhesive plaster.

œsophagus up to the time they died of secondary growth in the mediastinum. It is important that the stricture should be definitely located before the radium tube is introduced. A radiographic examination with a bismuth cachet or semi-liquid bismuth is used to enable us to recognise the position of the stricture. A radium tube in a platinum filter, 2 mm., is attached to a

length of pliable silver wire, which is enclosed in a rubber tube of 2 mm. thick to cut off the secondary radiations. When it is desirable to produce a superficial reaction a thinner filter may be used, a $\frac{1}{3}$ -mm. platinum tube in a rubber tube being used. The exposure is proportionately shorter, a larger percentage of the Beta rays being employed. The tube is passed into position either with or without an anæsthetic (in most cases it is better to give an anæsthetic), and then with a Brunning apparatus the stricture can be examined, and if necessary dilated to allow of the passage of the radium tube. The silver wire is brought out at the mouth and fixed to the side of the face. When the exposure is finished a special tube may be introduced through the stricture, this securing the double purpose of keeping the channel open for a time, and of allowing the patient to be fed through the tube. The duration of the exposure is determined by the quantity of radium used and the amount of growth present. A radiograph may

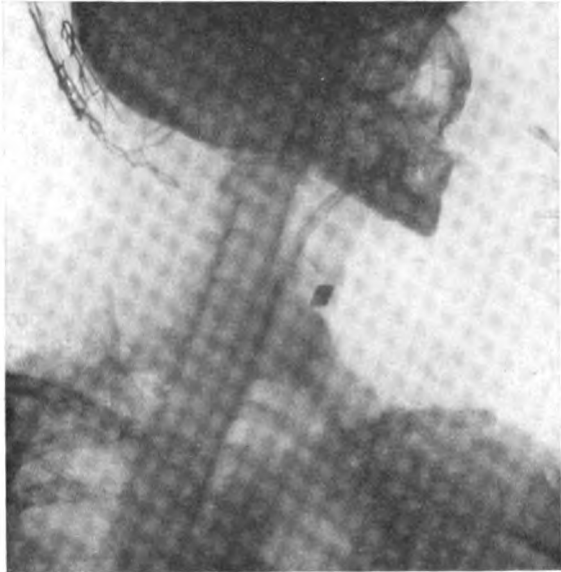

FIG. 396.—Shows radium tube *in situ*, for the treatment of tumour of the oesophagus, situated close to the cricoid cartilage.

be taken later to determine if the radium tube has been accurately placed in the stricture. Reaction follows the exposure, and the stricture may for a time become narrower from this inflammatory reaction. Sloughing of the surface in contact with the radium tubes may occur, though if the filtration is adequate, and the exposure accurately gauged, this need not occur. A resolution of the growth on the surface of the oesophagus may be induced with little or no sloughing. When marked sloughing has occurred, the healing process which follows may lead to a cicatricial narrowing of the oesophagus, which will in effect be as harmful as the original stricture due to the presence of the growth. This cicatricial stricture can, however, be treated by the passage of bougies, and dilated from time to time. The dilatation may be brought about by passing a Brunning tube past the stricture. This can be done in the course of the repeated examinations, which should always follow after healing has been brought about.

RADIUM IN CANCER OF THE RECTUM, THE PROSTATE GLAND, AND THE BLADDER

In Cancer of the Rectum

Symptoms may be relieved for a time. The tube containing the radium must be passed into the stricture, otherwise it may act as an irritant to the healthy mucous membrane and increase the distressing symptoms so common in this situation. Emphasis must be laid on the point that it is

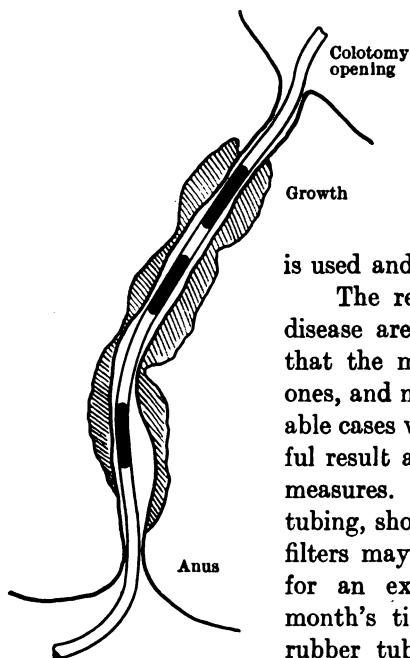

FIG. 397.—Diagram to illustrate method of introducing radium tubes into lower bowel.

The dark lines represent the radium tubes, the shaded areas the growth. The radium tubes are enclosed in a long rubber tube.

absolutely essential that the tubes be placed in the midst of the growth. This can only be done when the lumen of the bowel is still patent and the growth involves the whole bowel. The growth shrinks, and the function of the bowel may be restored for a time if a sufficient quantity of radium is used and a long enough exposure is given.

The results obtained in the treatment of this disease are disappointing, largely due to the fact that the majority of cases treated are advanced ones, and not likely to improve, whilst the favourable cases which offer the better chance of a successful result are rightly submitted to early operative measures. Filters of 2 mm. of platinum, and rubber tubing, should be employed; 100 mgrms. in these filters may be left *in situ* for about fifteen hours for an exposure. This may be repeated in a month's time. The radium tube is enclosed in rubber tubing 2 mm. thick. This is introduced into the lumen of the bowel, and the length of rubber is strapped outside, serving to hold the radium tube in position. A soft rubber catheter will be found an excellent holder for the radium tube. A thin rubber tube placed over this one and sealed at one end serves the double purpose of a filter and of keeping the radium tube clean. In

a number of cases it will be possible to pass a long flexible tube from the rectum through the lower opening of a colotomy wound, when several tubes may be introduced and applied to the whole of the canal affected by the growth. In this way a thorough exposure may be obtained at one treatment. During the exposure the tube containing the radium tube can be moved several times upwards and downwards, so as to ensure an equal distribution of the radiation over the entire surface of the growth.

In Cancer of the Prostate Gland

This may be treated by four methods :

- (1) By the rectum.
- (2) By tubes introduced into the bladder. The tube is enclosed in a catheter.
- (3) By a number of tubes introduced into the substance of the gland. The perineal route may be employed.
- (4) Post-operative treatment. Tubes can readily be introduced into the bladder after operation.

When treating by method No. 1 radium should be filtered through 2 mm. of platinum. Comparatively long exposures may be given, up to twelve to fifteen hours, using 100 mgrms. of radium.

No. 2.—This does not allow of very thick filters, therefore the exposures must be reduced proportionately.

By method No. 3, provided the tubes can be quite surrounded by the growth, comparatively long exposures may be given.

After complete removal of the prostate gland radium tubes should be left in the tissues at the base of the bladder for several hours, with thick filters, the object of treatment in this case being prophylactic.

In Cancer of the Bladder

If a tube can be introduced into the bladder and brought into contact with the growth, relief may be obtained, and hæmorrhage and discharge are lessened. In some instances a marked improvement in the condition of the patient ensues, and the tumour may diminish greatly in size. Simple conditions of the bladder may also benefit from radium treatment, papilloma will be checked in growth, and hæmorrhage is stopped for a time at least. In bad cases it is good practice to combine X-rays with radium. The former may be employed through the abdominal walls and the perineum.

The results obtained by radium treatment in these conditions are disappointing. Practically no case of cure has been published. Improvements may occur, but they are generally only temporary.

In all cases of malignant disease of the bladder treated by radium, the bladder should be opened superpubically and radium tubes or needles introduced into the tumour mass. Several small tubes are more useful than one or two larger tubes containing more radium.

C. THE COMBINED USE OF RADIUM AND X-RAYS IN THE TREATMENT OF MALIGNANT DISEASE

In the preceding pages on radiation therapeutics the strictly practical aspects of the methods have been rigidly adhered to. Reference to cases where success has attended the treatment are given as occasion indicates, but an expression of opinion as to the value of radium or X-rays as a curative or specific agent has been omitted, the aim of the book being to give a practical insight into the methods of usage rather than a speculative one of value in relation to curative effect.

A brief review of the general experience of workers in the new field of therapy would seem to be necessary, with particular reference to that aspect of the remedies on which an opinion is so often demanded.

The results obtained in the earlier days of trial of these agents led to the expectation of enhanced results as experience grew, and methods of technique were improved. These expectations have been realised to some extent, and there is reason to hope that, with accumulating experience and a more complete knowledge of the action of radiations upon cell processes, further improvements may be looked for.

There has been a marked advance in the technique of X-ray therapy, which bids fair soon to place X-rays upon the same footing as radium in the treatment of malignant diseases. Indeed, in the opinion of many workers, including the writer, it is probable that X-rays may soon prove to be more useful than radium as it is at present used. The factors which have led to this improvement are : (1) A great advance in the manufacture of the X-ray tube, enabling much larger doses of a more penetrating ray to be employed ; (2) the employment of much more powerful apparatus which the use of the new tube facilitates ; (3) the use of thick filters ; (4) the administration of more powerful doses at more frequent intervals.

A further factor which has led to improvement has been the employment of both agents together or alternately, radium being used for the more strictly local applications, and X-rays for the treatment of the more distant parts which may already be involved by new growth, or may be likely to become invaded as a result of the extension of the disease by natural channels or as a direct result of the local stimulation if dosage is not correctly gauged.

In the treatment of non-malignant neoplasms such as fibromata, the treatment by X-rays alone has been attended with a considerable degree of success. The early work of Continental investigators has stimulated work in the same direction in this country, and results are now being obtained in

both simple and malignant neoplasms which are of very striking significance in view of what can be done by the older and better recognised methods of treatment. In many instances of fibromyomata marked improvement follows the initial series, and after four or five courses of treatment the condition is relieved and the patient restored to good health. Results obtained in these cases by radiation treatment compare very favourably with the results attending operative measures, even when the most favourable cases for operative treatment are included in the cases analysed.

For malignant disease of the pelvic organs, when at all advanced, radiation therapy holds out as good a prospect as operative measures, especially when the latter have to be, as necessarily they must be, extremely radical if a prospect of cure or temporary amelioration is to be held out. It must not be assumed, however, that radiation treatment holds out a better prospect of cure. Recurrences can and do occur, with about the same frequency as after operation, and the result will be in both groups of cases the same in the end ; but when comparing the results consideration must be given to the condition of affairs existing in the interval between the treatment and the recurrence. The treatment by radiations is painless, does not subject the patient to any marked degree of shock, and the immediate effect is apparent in an improvement in health, a diminution or cessation of discharge, and a degree of local comfort.

It is not intended to convey the impression that treatment by X-rays or radium should displace the operative in all cases ; far from it. The ideal method is to employ radiations in all cases before operation, and again after operation ; prophylactic treatment should be adopted in every case when it is possible. Operations when performed should be as radical as possible, care being taken to exclude from operation advanced cases where the surgeon knows that no good can accrue. In these cases X-rays should be employed as a palliative measure.

All cases of cancer of the breast should receive prophylactic treatment immediately after operation, and this should be continued at intervals for at least a year.

The results obtained in this class are encouraging ; a number of cases have been under observation for several years, and these patients still remain free from recurrence. Others, however, showed a recurrence of the disease soon after radiation treatment was commenced. This is no doubt due to a focus of infection that has escaped removal at the surgical operation, or it may be due to reinfection at that time. Some have had recurrence at varying times since the cessation of treatment. In view of the very extensive operations of modern surgery for the removal of malignant disease of the breast and the influence these exercise over the probability of recurrence, it is difficult to claim that the immunity of a number of cases treated by X-rays after operation is really due to the effect of the treatment ; but the fact remains that patients so treated make a quicker recovery and have much less trouble in the scar area. The local recurrence of the growth appears to be checked. Patients who sooner or later succumb to the disease more

generally die from the deeper manifestations, *i.e.* mediastinal growth or involvement of the liver. Treatment so far does not appear to have exercised much influence upon these deeper manifestations. In all cases it should be our endeavour, by means of intensive treatment, to exercise an influence upon the mediastinal and other glands.

A matter of some importance from a therapist's point of view in these cases is that no case, however advanced, should be refused the trial of X-rays or radium. Some of the most unfavourable cases respond to treatment in a marked manner, while others, which appeared most favourable subjects, respond hardly at all. One case may be quoted. A large superficial ulcerated carcinoma of the breast of over a year's duration completely healed up after about six thorough radiations. The growth still exists, but it is shrinking rapidly, and in the interval the patient enjoys good health and a fair prospect of cure. This case appeared to be most unsuitable because of the large area involved.

The reason why one case responds and another fails to do so is one of the profound problems which the radio-therapist is striving to fathom, and when the solution is arrived at it will go a long way to establish radiation treatment on a sound, intelligible basis. In all probability the explanation is a biological one, a condition of cell, physical or other, which responds to a particular type of ray, producing far-reaching metabolic changes in cells and sera which act on tissues near and distant proportionately. The biological factor is one which, in the absence of convincing experimental evidence, had better be for the present left alone, as only speculative conjecture fittingly describes any attempt to explain it. Future attempts to clear up this point will no doubt be confined to physical experiments in the direction of producing effects on the deep tissues, and to the interpretation of biological effects by experiments in immunity conferred on tissues by the use of irradiated tumours and sera transplanted or injected. These experiments are being actively carried out by many workers.

The important point from the practical radio-therapeutic point of view is to determine the depth at which a tissue can be influenced, and the dose it is possible to convey at a particular depth of tissue. When these points are ascertained it should be possible to produce changes in deep tissues. Much experimental work has already been done, and an attempt is now made to summarise some of these experiments.

Professors Bumm and Wernekros of Berlin have published a number of experiments which in the aggregate confirm the observations of the writer, who has been experimenting on similar lines for several years. Up to quite recently it has been held that X-rays penetrated successfully to a depth of about 1 centimetre or less, and anything deeper than that has been left alone. The use of radio-active bodies led to the belief that when employing the Gamma ray a much greater depth could be reached, and effects produced by its use which were unattainable by X-rays. Increasing experience leads in the opposite direction, for, by using hard tubes and long exposures of X-rays, effects can be produced as deep as 10 cm., and those of quite a

marked degree. The same results may be obtained from the use of radioactive bodies if the quantities are large and the time of exposure is prolonged enormously, too long for safety so far as the tissues in immediate contact with the source of irradiation are concerned.

The X-ray tube produces many thousand times more rays than any available quantity of radium, while it is possible to work at a greater distance from the skin or mucous surfaces (a measure of safety being thus introduced), and at the same time produce an effect on the deeper tissues which is beyond all possible comparison with that of the radio-active bodies even when the Gamma ray of radium alone is used.

Wernekers and others have conducted experiments which appear to prove this contention beyond any doubt. With a Kienböck strip placed in tissues or organs at a depth of several centimetres and the surface of the body radiated with an X-ray bulb, in ten minutes' exposure 10 X have been recorded on the paper. With a long radiation of 200 mgrms. of mesothorium applied to the skin no effect was recorded on the paper, while in time the skin surface shows marked reaction. These points have been experimentally proved by using an electroscope and the ionto quantimeter of Szillard, and have been confirmed on the living tissues.

It has been suggested that radium and mesothorium possess a qualitative difference over the hard Röntgen rays, and that the Gamma ray has not only a greater penetration but also a more intense biological action, also that the Gamma ray possesses a selective action upon cancer cells; but this has never been proved conclusively, and in another part of the book the writer calls attention to the point that in many cases it may be a less penetrating ray which is required to produce a biological effect on a particular type of cell. In fact, the whole range of rays may be useful from the soft Röntgen ray to the Gamma ray of radium, and each of these rays may be required when a number of cases are treated. "A" may suit one case, while "Z" may be necessary for another, and so on.

The penetrating power of the ray is only one factor. The quantity of radiation administered is probably more important. It would appear that in all cases of cancer which are likely to benefit from X-rays, it is more a question of the quantity of rays which can be administered, while with the present apparatus at our command the quality of the ray may be kept at a fairly constant value.

It is now possible to state in a number of cases, according to depth of tissue, what quantity of radiation may be required to produce a favourable result; thus, at a depth of 2 cm. of growth 300 to 500 X may be necessary to cause a retrogressive change in the cancer cells. The maximum depth in any part of the body may be taken as 10 cm. or at the most 15 cm., for if a tumour exists in a deep part of the body it can be and is radiated from two or more aspects. In order to induce a therapeutic effect at, say, 10 cm., the intensity diminishing inversely to the square of the distance, the deeper parts receive about $\frac{1}{4}$ of the total exposure, so that to obtain a dose of, say, 500 X at 10 cm., 3500 X is required on the skin surface. It is necessary

therefore to exercise great care in the administration of these large doses. Specially hard rays must be employed at a sufficiently great distance from the skin to avoid doing harm to that structure. To produce such effects some risk must be taken, and in the experience of many workers on these lines, radio-dermatitis has been produced and must be acknowledged. At the present time, so far as we know, these risks have been minimised, and the difficulties which lead to their occurrence have been overcome.

To obviate the risk of damage to the skin surface, the author had a number of experiments carried out with a rotating tube. The results obtained were very striking, and showed conclusively that a large dose could be administered at a depth of 4 inches of tissue, with a fractional dose upon the skin surface (see pp. 111 to 113, Vol. I.).

The points therefore to observe in order to get in these heavy doses of penetrating rays are: (1) employment of thick filters, (2) the distance from the skin and the use of accessory filters of various substances, (3) many ports of entry, (4) sufficiently long intervals between the exposures.

So far we have been able to demonstrate that radiations exercise an influence on tissue change, and that it is often a matter of selection of ray; so we may assume that in the treatment of deep-seated growths X-rays and radium should be combined because of the wider area which can be treated, and the ease with which radium can be applied to regions where X-rays are not easily applied; thus, a rectal cancer can be treated locally by radium, while from the skin surface it may be attacked by X-rays from the anterior abdominal, the posterior, and the perineal route. Using a good quantity of radium and a penetrating X-ray, the resulting influence over the growth and glands must be enormously enhanced. The X-ray exposures may be carried on in the intervals between the radium exposures.

Similarly in carcinoma of the uterus, whether of the cervix or fundus, the cancer may be vigorously treated after the technique of Freiburg by X-rays and radium introduced into the uterus. In these tumours frequent séances of heavy doses lead to marked effects. Many cases might be quoted where improvement to a marked degree has resulted. Tissue changes can be studied in sections removed during the course of treatment, and all show the typical degenerative processes seen in such cases, which are described and illustrated in pages 395-401.

Carcinoma of the Mammæ.—The result of very heavy dosage in nearly all forms of this disease is beneficial. Growths diminish in size, ulcerated surfaces heal, and the general health improves. It is necessary to push the treatment. The skin is divided into squares, and doses given at regular intervals. Each square may receive 300 to 800 X or more altogether during the treatment, which is spread over several months.

There may be some skin reaction, but when dealing with bad cases this must not be regarded as a deterrent. Bumm quotes several cases which derived great benefit. From an extensive experience in the treatment of this form of cancer the writer feels convinced that in the later cases treated, where very heavy doses have been administered, the results show a marked

improvement on the earlier cases, where the treatment was not so thorough. Large primary growths slowly diminish in size, recurrences clear up, and the patient receives great benefit. In these cases the X-ray treatment is to be preferred to radium for reasons already stated. It is, however, important that a thorough technique be undertaken.

In the treatment of cancer of the breast in comparatively young subjects from thirty to thirty-five years of age, it is often noticed that, however early and radical the operation may have been, recurrence takes place early, and very little success attends whatever form of treatment is employed. X-rays and radium are no exceptions to this rule.

The explanation of this marked degree of virulence is obscure, and it is difficult to suggest measures which may control the progress of the disease. Such radical operations as double oöphorectomy have been employed, but without any great measure of success. Nevertheless the activity of the ovaries may affect the morbid process, as presumably at this early age all the tissues are in a state of full activity, and no doubt the new growth participates to a varying degree in this, and quickly spreads to the adjacent lymph and other structures. It is also well recognised that the most favourable cases for any form of treatment occur in patients at or after the menopause, when atrophic cancer is often met with.

Instead of oöphorectomy a method of treatment by radiations is here suggested. In addition to the local post-operative treatment the ovarian areas should be thoroughly treated by several series of exposures until a temporary menopause is produced, following the Freiburg technique

Mediastinal Cancer.—In this condition, which is frequently met with, a large field exists for the use of X-rays. This also applies to cases of sarcoma, lympho-sarcoma, and recurrent cancer of the lungs and pleura. The chest is mapped out in squares, anteriorly, posteriorly, and laterally, and each area is treated to the maximum extent at regular intervals. In this way it is possible to get in doses of several thousand X in a comparatively short time. There is every hope that with such thorough treatment a marked advance in the treatment of cancer will ensue. Certainly all patients should be given the opportunity of benefiting by this advanced method.

The administration of these intensive doses involves a great deal of time. Many cases will take six to eight hours for each series of exposures, and this entails a heavy wear and tear on apparatus. Such efficient treatment can only be carried out successfully in hospitals and nursing-homes where the patients can be kept for hours under close observation.

From the study of a number of sections removed at different stages in the treatment of cases of cancer, it may be recorded that marked changes are induced in the tumour cells. These include: (1) enlargement of the nucleus, with increased subdivision; (2) increase of fibrous tissue; (3) gradual disappearance of the cancer cells in the fibrous tissue matrix. Constitutional symptoms are also induced by this heavy radiation treatment. These are similar to those produced by radium treatment, and include a period of marked depression, lassitude, etc. Sickness may come on a few

days after the treatment. The patient should be kept quietly in bed for a few days on a generous diet.

The accumulation of experience in the treatment of malignant disease serves to demonstrate that in these comparatively new agents we possess a therapeutic factor which has great influence on cell growth, morbid or normal. The exact degree of influence is difficult to estimate because of the remarkable inequality of the action upon various tissues, and particularly upon the products of tumour invasion. The administration of a large dose of radiations upon the products of inflammation often leads to a diminution of the process and in time to a return of the tissues to normal. The same intensity and quantity of radiation applied to a tissue growth of mildly malignant character may lead to a diminution of the growth and of the malignant process, and a return to the normal or to the formation of a mass of fibrous tissue which no longer exhibits the characteristics of a new growth. Histological investigation of such a mass will, however, frequently show cancer cell remnants in parts of the fibrous tissue. These remnants are still capable of recrudescence, and are liable to resume activity at a later date. The existence of these remnants is therefore a source of danger to the patient, and with such patients, when all has been accomplished that radiations can achieve, the question of operation must be kept well to the fore. The danger of "lighting up" a cancerous process by operation in these cases is lessened when the patient has been thoroughly treated by rays, because of the obvious fact that a marked degree of fibrous tissue formed in and around the new growth diminishes the danger of a rapid spread if an operation is performed. This is also a strong argument in favour of treatment before operation, because, if it is thorough, the probability is that the formation of fibrous tissue wide of the growth will tend to prevent the spread of the infected cells at the time of the operation. Should such cells exist at the time of treatment it is probable that they are damaged by the radiations, and are no longer actively infective. Similarly, after operation, should any infected tissue remain, the reactive processes set up in the tissues may lead to the surrounding of these by fibrous tissue, and the subsequent degeneration of the cells lead to a lessening of their activity.

The subsequent course of patients so treated is being watched with great interest. Is it possible to prevent recurrence and confer upon the patient a period of comparative immunity? The early recurrence of a neoplasm after radiation treatment does not necessarily prove that the treatment taken as a whole is of no value. It merely demonstrates that we have not given a dose sufficient to check the particular malignant process in activity in the case. It must also be borne in mind that there are growths which cannot be influenced by any radiations at present at our command. It would appear that these cases are quite as irresponsive to any other form of treatment. Complete radical excision of a comparatively early growth, with apparently no involvement of glands, is followed by what seems a complete recovery. Later, but in these cases comparatively soon after operation, recurrence shows itself in the scar or neighbouring lymphatic glands. No subsequent

treatment appears to do any good. Radiation treatment in a case of this type would, however early and thorough the treatment might be, achieve no better result.

It is the less virulent case which is more amenable to both methods of treatment. The choice of treatment in these cases raises a wide and difficult question. Which of the two methods promises the better result? In the present state of our knowledge of radiation therapeutics, in the great uncertainty of action upon particular types of tumours, the preference must be given to early operation, which should be as thorough as possible and should be followed by X-ray treatment.

The following conclusions on the value of X-rays and radium in the treatment of malignant disease can be drawn :

(1) These agents are most valuable aids to the treatment of these conditions in so far as by their use we can induce changes in tumours which are unattainable by any other agent at present in use.

(2) X-rays and radium may be used separately or combined in the same case, and in some instances it is advantageous to alternate the use of the two.

(3) In so far as it is possible to demonstrate profound changes in inoperable growths of large size, it is a logical conclusion to arrive at that cancer tissue of small size left at the time of operation may by post-operative treatment be rendered inert, and recrudescence of growth be prevented.

It is therefore sound policy to insist on post-operative treatment in all cases submitted to operation. The post-operative treatment must be carried out with as complete thoroughness as when we are attempting to induce the resolution of a growth of considerable size.

When a thorough course of treatment has been applied the patient should be instructed to come at intervals for inspection, and if necessary for more treatment for two or three years after the operation.

(4) Other methods of treatment must not be neglected when the radiations are being used. Thus, it may be advisable to remove growths which appear to be arrested or which are not yielding to treatment. This will greatly aid in the administration of radiations and lead to an improvement in results. Drugs which are known to aid the action of radiations should be used. Thyroid extract is known to exercise a far-reaching effect upon tissue metabolism. Pfahler of Philadelphia recommends the administration of thyroid extract in nearly all cases submitted to radiations. Iron, arsenic, and in some cases salvarsan may be used as aids to treatment by radiations. In several cases which have had the latter drug administered, rapid changes have been induced in the blood and tissues by radiations administered subsequent to the drug.

In conclusion, it may be stated that in all probability the treatment of malignant disease by radiations is not nearly so efficient as it may be in the future. With advancing knowledge, improvements in apparatus and technique, and a more perfect understanding of the tissue reaction to radiations, there is every hope that in the near future a great advance in results will be attained.

X-RAYS AND RADIUM IN THE TREATMENT OF INJURIES AND DISEASES MET WITH IN MILITARY PRACTICE

THE value of X-rays in the diagnosis of injuries and disease has been amply proved, and full use of the radiographic method of diagnosis is now taken, particularly in the case of fractures, diseases of bones, and the localisation of foreign bodies, while on the medical side the value of radiographic diagnosis is being daily proved in the examination of diseases of the alimentary system by means of the opaque meal, and in the location of diseases of the thorax. The X-ray examination of recruits for the detection of latent disease in reference to their fitness to serve in the Army is daily increasing, and as time elapses it will be found that by a careful examination of doubtful cases a great saving of time and money will result.

The value of radiology in diagnosis is thus established, but there is still another field where the radiations from X-rays and radium may be profitably employed. Less penetrating rays, *i.e.* ultra-violet, may also be utilised in combination with those from the more penetrating agents. That is in therapeutics. In civil practice the therapeutic use of radium is being extended, and it is already established beyond any question that the use of radiations in diseases and injuries met with in military practice is of the greatest possible value. It therefore remains for us briefly to indicate the conditions in which radiations will be found to be of advantage, the best conditions under which they may be used, and to describe special points in technique.

The descriptions of apparatus, general technique, and the diseases already dealt with in preceding sections of this work apply in all details to the cases met with in military practice, but in view of the increasing importance of the subject and its undoubted value in therapy, it has been considered advisable to conclude the work with a section specially devoted to the treatment of military cases, in the hope that it may be found useful by the large number of radiologists already engaged in the diagnostic work. Up to the present hardly any provision has been made in X-ray departments connected with military hospitals for therapeutic work, though a great amount of therapeutic work is being done at a number of the base hospitals.

It would appear that to provide already existing radiographic departments with a complete therapeutic outfit would involve the authorities in

a very large expenditure of capital, which can ill be spared at the present time, and would lead to a needless multiplication of outfits which, in a number of small centres, could not be profitably employed. The proper course to pursue would be to equip a limited number of efficient departments at centres to which all cases requiring treatment could be transferred. It might even be a good plan to institute one or more special hospitals with ample accommodation for a large number of patients, where the cases could be treated by experts, who would control the special and general treatment. The system at present in operation is not in practice a model one, for while the patient is sent to the X-ray department for special treatment, he remains under the care of a surgeon or physician who controls the case. Often the value of special treatment is minimised by other lines of treatment employed, and there is practically no collaboration between the surgeon or physician and the radiologist. Cases are often discharged by the former before the special treatment has had a full trial.

To ensure the full value of the radiation treatment, it appears, therefore, that if a special hospital or department were provided and the patients placed definitely under the charge of the radiologist, much greater value might result from the treatment employed. When the patient has received the full benefit of this treatment, he could be referred again to the surgeon or physician, who would then be in a position to estimate the value of the treatment and the fitness of the man to return to duty.

In large military hospitals a fully equipped department, under the charge of an experienced radiologist, with assistants and nurses, could be supplemented by the allocation of a number of wards with suitable laboratory accommodation and facilities for the auxiliary treatment required. Patients admitted to these wards would be visited and examined daily by the medical man in charge. The arrangement of these wards would in no way differ from that ordinarily employed, so we need not concern ourselves with this matter further. Valuable data would soon accumulate, which should be useful in assisting us to arrive at an accurate estimation of the value of the treatment employed.

Equipment of a Radio-Therapeutic Department

The equipment of the radio-therapeutic department is, however, of some importance, since, if efficient measures are to be employed, we must see that the arrangements are complete.

The department should be in close proximity to the wards, so that patients may be readily taken to the department for treatment. In cases too ill to be moved, it would be an advantage to have facilities for treatment while the patient remains in bed. In the case of radium this is an easy matter, but when X-rays are employed it is somewhat more difficult. The wards would require to be provided with electrical current from the mains. A number of plugs connected with the power current could be arranged in the

ward ; from these the current could be led to a portable X-ray outfit. This would ensure the possibility of giving the patient adequate treatment.

The portable outfit would require to be of sufficient capacity to ensure the maximum necessary in any case. The apparatus required for radiography and X-ray therapeutic work consists of the following :

The coil and control apparatus are grouped together on a trolley which runs on rubber-tyred wheels on castors ; these facilitate movement of the whole, and the size is such that the outfit can readily be pushed into a lift for transit to the wards on various floors of the hospital. The outfit can be readily taken to the operating theatre.

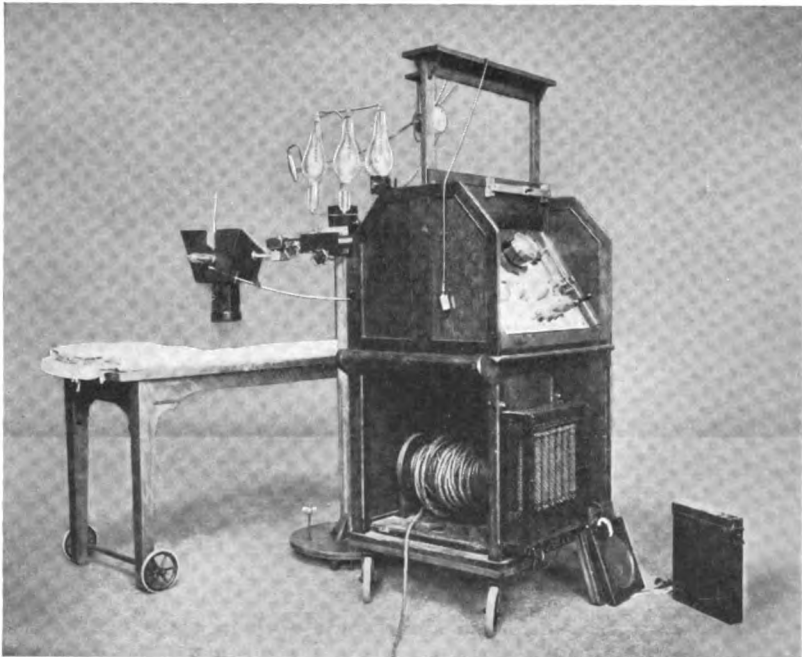

FIG. 398.—Portable outfit for use in wards. Back view, showing control switch-board with resistance, protective front, and cable coiled on reel.

The current is derived from the mains of the building, as described above, and is conveyed to the coil and interrupter by means of a long, heavily insulated cable which winds up over a reel placed at the base of the stand on which the apparatus is grouped (see Fig. 398), and a suitable resistance is included in the circuit. The interrupter is of the Dreadnought type, suitable for the passage of heavy currents ; the dielectric employed is coal-gas, of which a supply is carried in a cylinder fitted with suitable valves for regulating the pressure of the gas. The interrupter is placed in the base of the cabinet.

On the back of the cabinet is placed a marble switchboard on which are grouped the control switches, amperemeter, fuses, and other accessories. At the top of the stand is a large sheet of lead glass, through which the

operator watches the behaviour of the tube when in action. The wood-work of the stand is lined with sheet-lead for the protection of the operator.

A triple valve tube is in the circuit; this is regulated by means of a Bauer air-valve. An adjustable automatic spark-gap is also provided for the purpose of controlling the penetration of the X-ray tube.

The induction coil is of the intensive type—a 16-inch spark-gap with a variable primary. It is arranged, for convenience, in the vertical position,

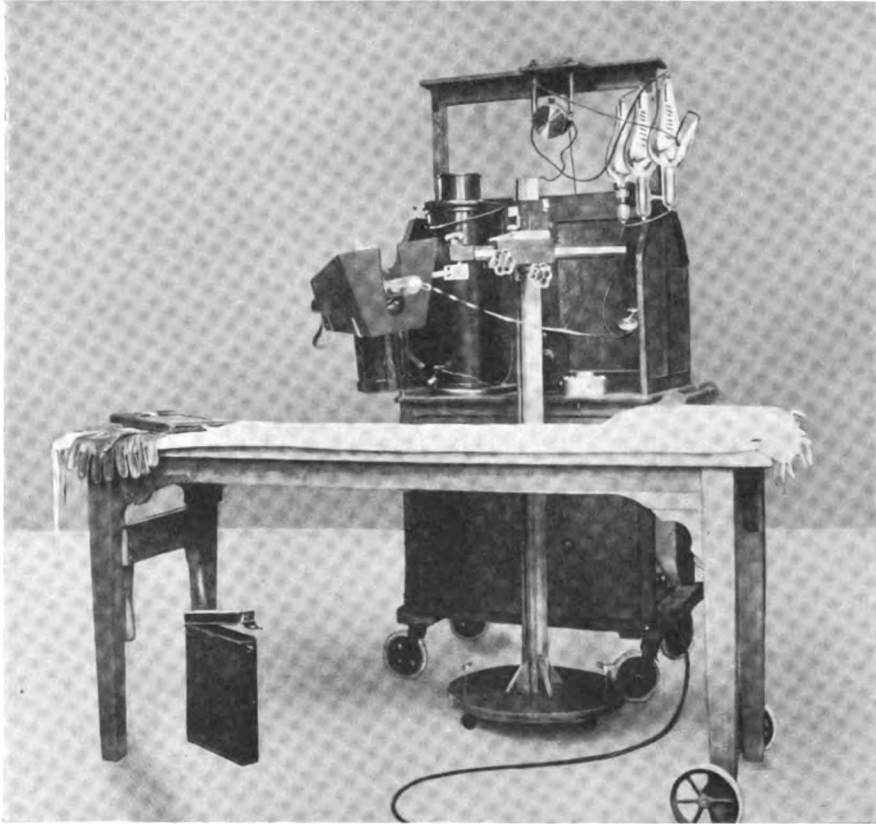

FIG. 399.—Portable X-ray outfit for use in wards. Front view, showing induction coil, valve tubes, and protected tube-holder.

and a milliamperemeter is placed in a position convenient for ready observation of the current passing through the tube when in action.

The tube-stand was originally fitted to the trolley-table but it was found that this was not a convenient arrangement, on account of vibration from the interrupter when in action; to overcome this difficulty it was decided to use a separate tube-stand. For ordinary work a light tube-stand is used; this allows of ready movement and is fitted with adjustable parts for stereoscopic radiography and for treatment. A supply of extension tubes and filters is also included in the set.

With an apparatus of this kind it is possible to do practically all kinds

of radiography, and the outfit is admirably adapted for therapeutic work. For radiography a simple couch on castors is provided. For therapeutic work the couch is also useful, though in ward work it is often necessary to treat the patient in bed or lying upon an ordinary couch. The apparatus can also be used in localisation work and in conjunction with the Bruce director couch when the latter is used for operation in the theatre.

When a current supply from the main is not available, accumulators may be used for the supply of the necessary current. When a Coolidge tube is used it is necessary to have an additional accumulator set for the control of the heating current.

The supply of high-tension current for the stimulation of the X-ray bulb is generally derived from an induction coil, which up to the present has been the most convenient method to employ for portable work, but recently in America the high-tension transformer has been adapted to this form of work even to the extent of its being used for field work; such an apparatus has been put together for the use of units of the American Army in the field. In this country similar steps are being taken, and Messrs. Newton & Wright are at present preparing a small model of their well-known Snook apparatus which, from experimental work already done by its aid, promises to meet all the requirements of field radiography. The apparatus can readily be adapted for therapeutic work. The whole set may be mounted upon a trolley and moved from place to place quickly. The advantages which this type of apparatus possesses over the coil outfit are too well known to need description here.

The small high-tension transformer will be fitted in a motor-waggon with all the auxiliary apparatus. This should be of great service in the field and for the use of outlying hospitals or homes which do not possess an X-ray outfit. To overcome the difficulties of a varying power supply it has been decided to equip the outfit with its own generating plant; the power for the working of the dynamo will be derived from the engine of the waggon. The transformer will be so constructed that it may be taken into the hospital or home and, by means of a cable connecting it with the generating apparatus, it will be possible to do work inside the room in which the patient is placed.

With an outfit of this kind it should be possible to do all kinds of radiographic and therapeutic work at the bedside. The advantages of such work from the patient's point of view are obvious.

It is necessary to emphasise the need for a thoroughly efficient equipment of the therapeutic department, since an impression prevails in many places that any X-ray outfit is sufficient for therapeutic purposes, and it is not uncommon to find a case sent to a department which is solely equipped for radiography, with a request for X-ray treatment. No greater mistake could be made. The failure of radiation treatment to achieve a result can often be traced to a request of this kind. Treatment is often administered by an operator who has no special knowledge of therapeutics, and who has

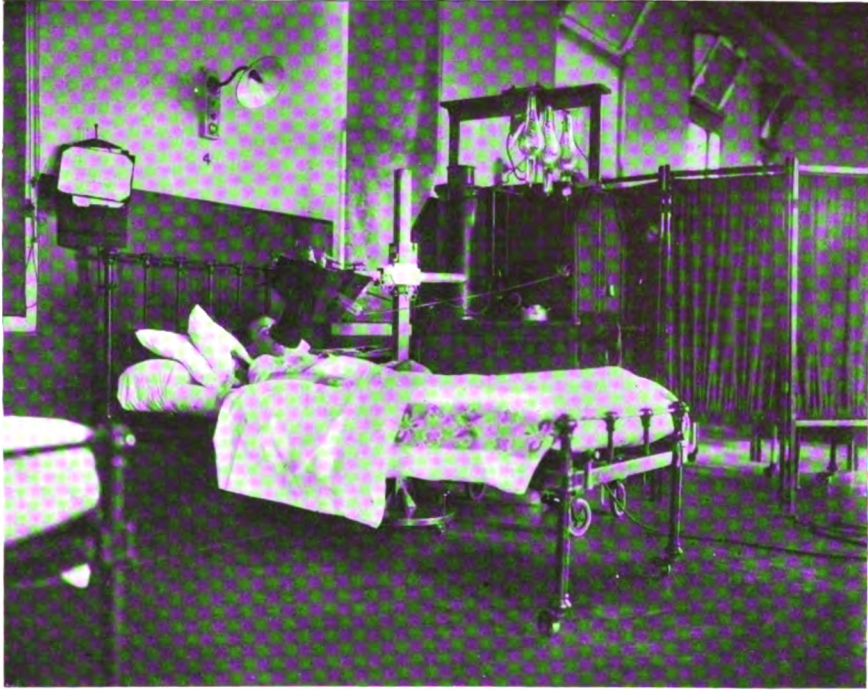

FIG. 400.—X-ray treatment at the bedside by means of a portable outfit.

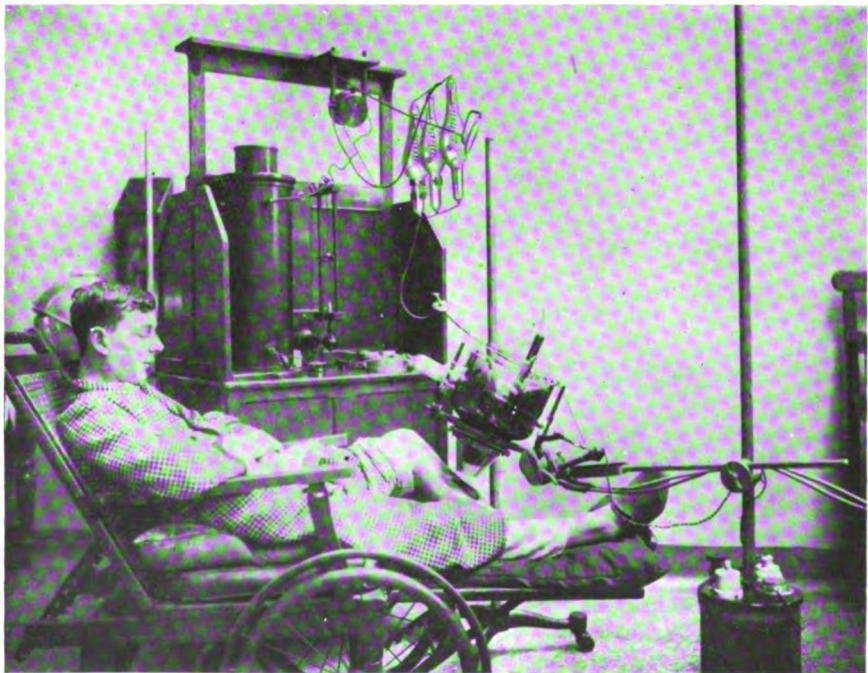

FIG. 401.—Combined X-ray and ultra-violet radiation treatment.

not the proper apparatus at his command to administer the treatment necessary.

In view of these facts it is necessary to insist on all therapeutic work being done under the supervision of an expert, who has at his command the equipment suitable for his needs.

Consideration of the necessary Apparatus.—The first essential in the radio-therapeutic department is a large and well-aired room or rooms, where the apparatus may be arranged to advantage. Suitable rooms for waiting patients and dressing-rooms are also necessary.

The X-ray apparatus must be suitable for the production of radiations of high penetrating power, hence it must be of the most powerful description

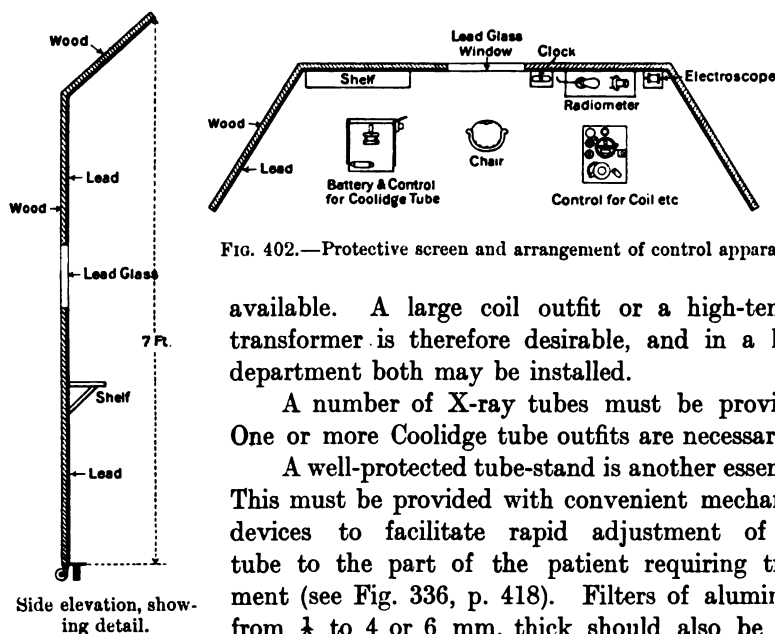

FIG. 402.—Protective screen and arrangement of control apparatus.

available. A large coil outfit or a high-tension transformer is therefore desirable, and in a large department both may be installed.

A number of X-ray tubes must be provided. One or more Coolidge tube outfits are necessary.

A well-protected tube-stand is another essential. This must be provided with convenient mechanical devices to facilitate rapid adjustment of the tube to the part of the patient requiring treatment (see Fig. 336, p. 418). Filters of aluminium from $\frac{1}{2}$ to 4 or 6 mm. thick should also be provided. Secondary filters of leather, loofah sponge, chamois leather, etc., must also be at hand.

In therapeutic work of this kind, necessitating the employment of highly penetrative radiations, the *protection of the operators* is a matter of supreme importance. This may be assured by employing the cubicle system, where the patient and the X-ray tube are enclosed in a room, the outer wall of which is protected by lead glass in lead-lined wood frames. This completely protects the operator and assistants from radiations given off by the active tube. On the outside of this cubicle all control apparatus is placed conveniently for the operator, who may watch the action of the tube from a point of safety to himself (see Fig. 323, p. 407).

Where this is not possible a protective shield should be provided behind which the operator can have all the apparatus under his control and at the same time be able to observe, through the lead glass window, the behaviour

of the tube.¹ Fig. 402 shows in detail the construction of the screen and a convenient arrangement of the necessary apparatus, while in Fig. 403 the same screen is shown in position in the radiographic department with an X-ray tube arranged for use.

The estimation of the dosage is another matter of great importance. The methods employed for this purpose have been fully dealt with in another section of this work, but it might be well to state that the method generally employed at present is that of the pastille of Sabouraud and Noiré or modifications (see pp. 425 to 438). A Lovibond or Cox tintometer will be found useful when the pastille method of measurement is used.

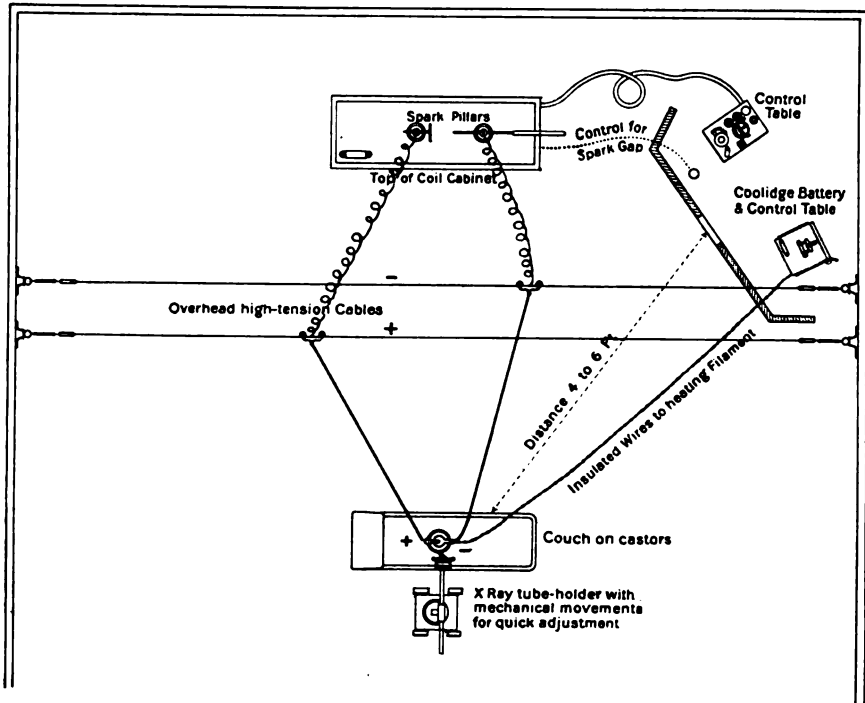

FIG. 403.—Apparatus arranged for therapeutic work, showing protective screen in position.

In addition to X-ray generating apparatus, it might be well to provide accessory apparatus such as diathermy or high-frequency outfits, since these are often valuable adjuncts to X-ray and radium applications. Similarly, a multostat, for the production of continuous and alternating currents, and an attachment for vibratory massage, will be found useful.

Ultra-violet radiations are often used in conjunction with other more penetrating rays, so some source of these radiations should be provided.

The radium equipment will vary according to the amount of work which has to be carried on. The quantity of radium required will depend upon the same factor.

¹ When the Coolidge tube is used, the operator watches the behaviour of the ammeter in the heating circuit and the milliamperemeter in the secondary circuit.

In view of the undoubted value to be derived from radium in the treatment of cheloid condition of scars after the healing of wounds, and particularly in those of the face after plastic operations, it would be well to provide a large supply of radium, either in the form of flat applicators, plaques, or radium (or radium emanation) tubes. The suitable combination of radium tubes has already been dealt with fully (see pages 503-506).

In the case of large base hospitals situated in cities where radium institutes already exist, it would be an economical measure for the radiologist

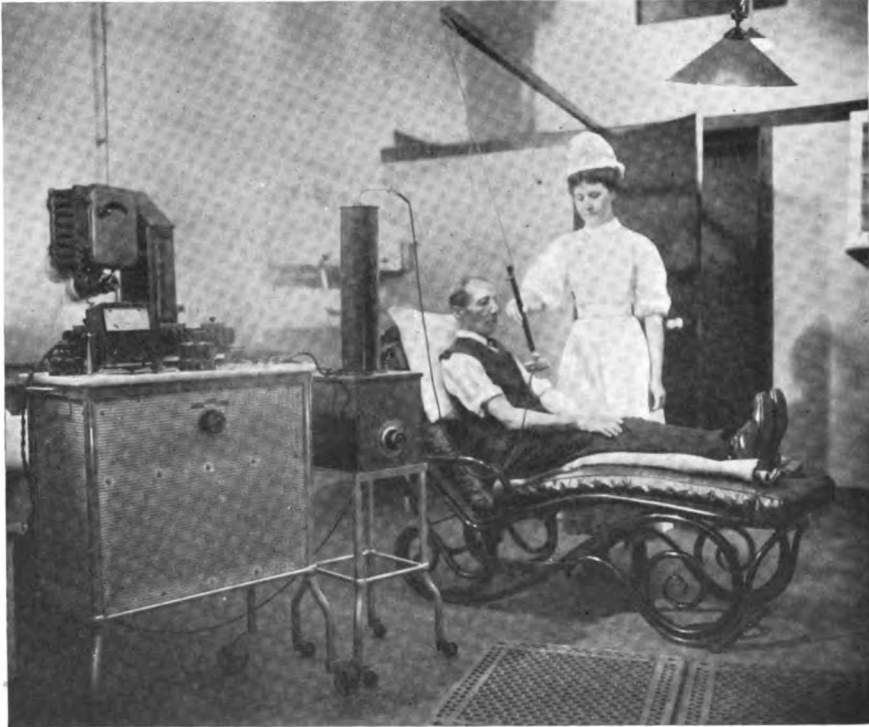

FIG. 404.—High-frequency treatment.

to collaborate with the director of the institute in the treatment. Emanation applicators could then be quickly provided of the required strength, and need not involve the authorities in great expense. It would be a very economical means to the end.

The provision (in whatever form it is available) of a large quantity of radium placed in suitable applicators would be a most valuable adjunct to the radio-therapeutic department of a military hospital. The cases in which radium will be found suitable will be dealt with later.

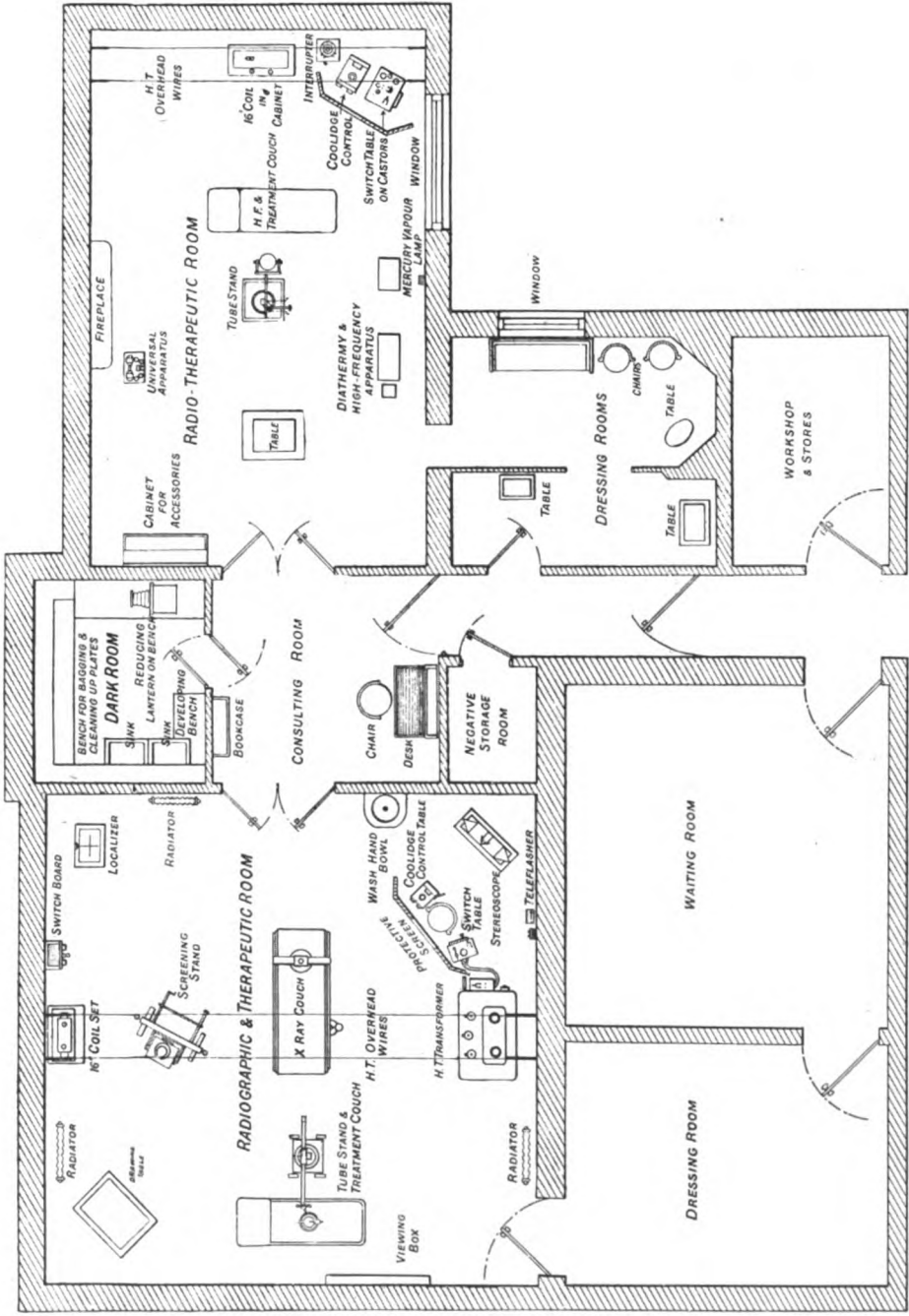

FIG. 405.—Ground plan of a radiographic and radio-therapeutic department. (Plan prepared by Watson & Son.)

Description of Types of Cases met with in Military Practice, with Special Points in Technique

During an experience of radiographic and therapeutic work at a base military hospital, extending over three years, a great deal of work has been carried out. In the early days of the war these cases were not numerous, consisting as they did of conditions met with in patients who had been called up for military service. They necessarily approximated to the run of case met with in civil practice, and consequently called for no special attention. As the war progressed and the men were submitted to periods of great strain and anxiety, types began to alter somewhat, though they could still be recognised as belonging to well-known groups of disease. Thus, hyperthyroidism began to receive recognition. Soldier's heart, in so far as it was associated with hyperthyroidism and enlargement of the thyroid gland, began to attract notice and to receive radiation treatment. Lymphadenomatous enlargement of the glands of the neck and mediastinum became evident, and received appropriate treatment.

Leukæmia and other blood conditions showed their presence earlier in soldiers engaged in strenuous work than would have been the case had they remained in civil life. These also began to find their way to the X-ray department as a last resort before discharge from the Army.

Rodent ulcer is another condition which appears with fair regularity in the Army. Several cases have been successfully treated, and the men have returned to active service.

Cases of **malignant disease** have been brought for treatment which may or may not have been due to injury; these may have been existent for some time, but were quiescent until the gunshot or other injury caused them to manifest themselves. A change has been observed in these cases, a marked departure from type. Several have been met with which, from quite a trivial injury, have developed rapidly into a most malignant growth, whose progress has been unusually rapid, and which has resisted all forms of radiation treatment. Several of this type have occurred in the face, close to, and including the orbit. Probably the strenuous life of the soldier has led to a debility which has favoured the rapid development of a very malignant type of growth, or it may be that a secondary infection, which is almost invariably present in these cases, has added to the virulence of the growth. These cases defy all forms of treatment and go rapidly downhill.

Treatment of Sycosis Menti (Tinea Barbæ).— This infective condition is at any time most troublesome to deal with. In the experience of the writer it is extremely difficult to treat when met with in soldiers. A large number of cases come for treatment. An interesting point in the history of a number of these patients is the statement that the disease has been evident for months or years before the man joined the Army. It was apparently kept in check by appropriate treatment until the man was engaged in active fighting; then, probably as the result of lack of

treatment and the inability to shave and keep the parts clean, the disease spread rapidly. Several of the worst cases seen appeared to break out with great virulence during the retreat at the commencement of the war. The disease renders the man quite unfit for service, and he is a constant source of danger to his fellow-soldiers.

Combined treatment is most useful. Vaccines appear to exercise a beneficial action to a certain point, but they do not appear to cure the disease. Disinfectants in the form of lotions and ointments act only in the direction of checking the septic process; they rarely cure the disease. On account of the *acute inflammatory septic poisoning* which is nearly always present in these cases, radiations have to be used at first with caution; yet unless a full



FIG. 406.—A case of tinea barbæ treated by ultra-violet radiations and a vaccine.

dose is given there is very little chance of depilating the hair, and unless this is done thoroughly there is small chance of doing any permanent good.

In severe cases of this character it has been found that a few preliminary exposures to ultra-violet radiations are extremely useful; when the inflammatory process has subsided a full pastille dose is given to all the hair-covered areas of skin. The ultra-violet radiations are continued at intervals of two or three days until the hair is completely depilated; then the condition is watched carefully for some time after. Vaccines may be given concurrently with the radiation treatment, but the hair must first be completely removed if a cure is looked for. The ultra-violet radiation may be given daily in severe cases, the duration of the exposure depending upon the intensity of the radiation, and this is governed by the source from which the rays are derived. Experience in the use of particular lamps is therefore necessary before a statement on dosage can be made.

The Kroymeyer mercury vapour lamp is a useful source for these radiations. The radiation from a tungsten arc lamp, such as the Forbes lamp, is more powerful than that from the Kroymeyer, consequently the exposure is proportionately less.

A striking case of this kind is shown in Fig. 405. The patient had been suffering from this disease for two or three years when he was sent for treatment. Ultra-violet radiations were administered as a preliminary treatment, and in a month's time the disease had almost entirely cleared up. This patient was at the same time treated with vaccines by Captain Spitta.

The X-rays and ultra-violet radiation can be given simultaneously (see Fig. 401).

Other diseases of the skin are also very difficult to treat when they have become well established. No doubt in such cases the life of a soldier on active service precludes careful attention to cleanliness, and the possibility of a mixed infection may account in part for the difficulty. (See also *Folliculitis Barbae* at p. 450.)

Diseases associated with **enlargement of the spleen** have also been dealt with in a number of cases with a degree of benefit, though it is too early to make any special claim in these diseases. A number of patients suffering from malaria with enlarged spleen have been dealt with.

Ringworm of the scalp is occasionally met with, and only requires the ordinary treatment, there being no circumstances of special note in military cases.

Lichen is another condition which has called for treatment.

Prurigo is a fairly common disease of the skin, either alone or complicated by other conditions such as eczema.

Leucoplakia, in so far as it complicates other diseases, has been met with.

Pruritis ani is a troublesome condition when met with in soldiers; if untreated it is apt to become very troublesome, especially when men are on duty for long periods and have not the opportunity to avail themselves of hygienic measures and local treatment by ointments, lotions, etc.

These cases should be thoroughly cleaned and treated by soothing lotions and ointments. The X-ray treatment is similar to that already described. Pastille doses through a $\frac{1}{2}$ or 1 mm. aluminium filter for two or three weeks in succession will lead to a marked relief, and often a permanent cure, of this most troublesome condition.

Treatment of Chronic Sinuses and Septic Wounds by Combined X-ray and Ultra-Violet Radiations

Of the more general conditions which are amenable to radiation treatment, that of septic wounds, with chronic and purulent sinuses, will be found most responsive to treatment. The combination of ultra-violet radiation with X-rays will be found useful, either applied together or alternately. The use of the combined radiations will be helpful in cases where

the infected area varies in the depth of the tissue involved. For large superficial areas with unhealthy granulations, the ultra-violet radiation will aid by reducing the sepsis, and will promote healing; while for the case where the infective organisms have penetrated deeply into the tissues, the more penetrating X-radiation will be the more effective. Even when bone is involved and sequestra are present, the X-radiation will penetrate to any depth, and act beneficially upon the pathological process. When long narrow sinuses exist, a suitably shaped radium, or radium emanation, tube may be inserted into the channel, and so influence the healing process. The treatment of narrow sinuses by radium tubes inserted into the channel is one of the most satisfactory of the uses to which radium can be put.

In other cases, where the sinus is very chronic and resists all other forms of treatment, it may be injected with bismuth paste and afterwards irradiated, advantage being taken of the well-known secondary radiation effect. In other cases, ionisation with various solutions may be employed alone or in conjunction with ultra-violet or X-ray radiations. A useful field and an ever-increasing one exists in the treatment of these very chronic septic wounds, where the judicious employment of radiation treatment, in one or other of its forms, will lead to the attainment of satisfactory results which may be far in advance of any obtainable by the better known and more widely used methods of the present day.

Yet another and a rapidly increasing field for radiations exists in the treatment of cheloid conditions of the skin resulting from gunshot wounds, where there is a great amount of laceration of the tissues, and where a secondary sepsis has led to the formation of elevated scars. These, when treated with X-ray or radium, slowly subside, and a healthy pliant scar takes the place of the often very irritable cheloid scar. Half-pastille doses distributed equally over the area involved may be given once a week for several weeks. The result is slowly obtained with no reaction of the tissue, and a healthy, non-irritable scar results. This form of treatment is particularly applicable to wounds of the face and head, where plastic operations have been carried out in an attempt to remodel the face when portions of it have been shot away. Brilliant surgical results are obtained by surgeons in such cases, where if nothing is done the patient is doomed to a life of misery; by such operations he is restored to a semblance of his former self, and mental and physical comfort results. When cheloid scars follow upon such operations, which is not uncommon, the work of the surgeon can be completed by the application of radium or X-rays. The former sometimes gives splendid results when skilfully used. Two hundred milligrams of radium bromide, or its equivalent in emanation, in suitable applicators may be applied to the surface of the skin for four to six hours every fourteen days or so for two or three months. A filter of 1 to 2 mm. of lead should be employed in these cases, supplemented by several layers of lint.

Mr. Percival P. Cole has operated on a number of cases with great success, and the writer has been able to assist him in his work by the application of X-rays and radium rays. In several of these cases the results obtained

have been very satisfactory and well worth any trouble that may have been taken. It is in the treatment of such cases that radiations have found a new and extremely interesting field of usefulness. The experience gained in the treatment of these cases may go a long way towards aiding us in our estimation of the value of radiations in treatment of diseased conditions.

In the technique of these plastic operations it is often necessary to obtain the skin flaps from parts adjacent to the seat of injury. These flaps are often covered with hair, which, when transplanted, may continue to grow in undesirable luxuriance in unsuitable regions. X-rays can be employed to depilate the hair, destroy the hair follicles, and lead to the production of a hairless skin area.

In other cases, the flap may be employed to restore mucous membrane destroyed by the injury. It may be necessary to turn in flaps to form mucous membrane for the mouth. When the flap is hairy the result is hardly conducive to the comfort of the patient. The flap, while in position prior to insertion, may be depilated by X-rays, then when the surgeon rebuilds the tissue the hair will no longer grow, and a great deal of later trouble may be prevented.

In injuries to the face involving the salivary glands a salivary fistula may result. This is often a very troublesome condition to deal with. Radiations may be combined with surgical measures for the amelioration of this decidedly inconvenient complication. Several of these cases have been treated in collaboration with Mr. Cole by radium. The results have been most satisfactory, leading after a few exposures to a closure of the fistula.

Cheloid scars are frequently the seat of great pain, particularly when nerve terminals are included in the scar tissues. Radium rays applied to the cheloid will often lead to diminution of and ultimate cessation of the pain, if by reducing the hardness and tension of the cheloid structure we are enabled to diminish the pressure upon the painful nerve endings.

Cases will be met with where the treatment fails; these must be returned to the surgeon, who will consider what can be done surgically to relieve the pain. Wounds of the skin and subcutaneous tissues may for a considerable time remain very painful, long after healing has taken place. The pain may be caused by a secondary neuritis, the result of pressure upon nerves contained in the scar tissue. This may be relieved by exposure to X-rays or radium, applied over an area to include as much of the nerve distribution as possible. All cases of nerve pain following upon injuries to adjacent tissues should, in addition to the purely local treatment, receive general routine treatment, rest, fresh air, good food, and various forms of electrical treatment, *i.e.* Galvanism, Faradism, High-frequency, Diathermy, Radiant heat. All or a number of these may be required for a single case. These cases are often highly resistant to all forms of local treatment. It is necessary to exercise the utmost care and patience before deciding that a patient suffering from obscure pain is a malingerer.

The electric treatment and methods of diagnosis may also be used to determine whether a man is shamming pain, and if he is doing so, the extent of the deception he is practising. A carefully applied local stimulus of sufficient strength and frequency is often the determining factor in the cure of a particular case. These are all extremely interesting points, but they depart somewhat from our thesis, *i.e.* the treatment of war injuries and diseases by radiations.

Acting on the suggestion of Mr. Cole, the writer has recently been using small frequent doses of X-rays to cases where bone grafts have been used in the restorative operations he has conducted upon soldiers who have lost portions of their bones from gunshot wounds, the idea being to stimulate the healing of the wounds, and, if possible, to hasten the reparative process necessary for the consolidation of the "graft." These cases are limited in number, and it is at present too early to form an opinion of the value of this method of treatment.

THE VALUE OF RADIATIONS IN PLASTIC SURGERY OF THE FACE AND JAWS

By PERCIVAL P. COLE, M.B., F.R.C.S. (Eng.)

Hunterian Professor of Surgery, Royal College of Surgeons, England

In the treatment of war wounds the surgeon has been called upon to deal with many conditions rarely or never met with in ordinary civil practice. Previous surgical experience is a valuable but essentially foundational asset. The fundamental principles of surgery remain unchanged. Their application demands versatility, clearness of thought, and power of adaptation. In no department of military surgery is this more true than in that concerned with facial and jaw injuries. Plastic surgery is no new art. Radiation therapy is no new discovery. The systematic employment of radiations as an auxiliary factor in plastic surgery was first suggested by the known reaction thereto of certain lesions met with in routine practice. The lesions referred to were particularly those associated with local malnutrition and chronic sepsis, such as persistent sinuses, cheloid, and indolent ulcers. The brief description of the conditions in which radiations have proved valuable is based entirely on the writer's personal experience. No reference will be made to the technique adopted, as this question is dealt with fully elsewhere. No description of operative procedure will be essayed beyond that necessary for elucidation.

Cheloid scars are more liable to occur on the face and neck than any other part of the body. Especially is this so when the element of chronic or subacute sepsis is introduced, as is frequently the case when the tissues have been extensively damaged by shell, shot, or shrapnel. This is unfortunate, because the condition is particularly unsightly. Apart from cheloid, cicatricial tissue formed under the above-mentioned conditions is only too often dense and resistant. In cases exhibiting extensive loss of the soft tissues of the face, it becomes necessary to utilise neck-flaps to replace the deficiency. It is obvious that the pliancy of the resulting scars, both on neck and face, will contribute, in no small measure, to functional and cosmetic success. Ionisation and radiant heat have been tried to combat cheloid and soften cicatrices. They are in this respect greatly inferior to radiation, which has produced eminently satisfactory results.

The response of cheloid to systematic radiations is illustrated by *Case I.*

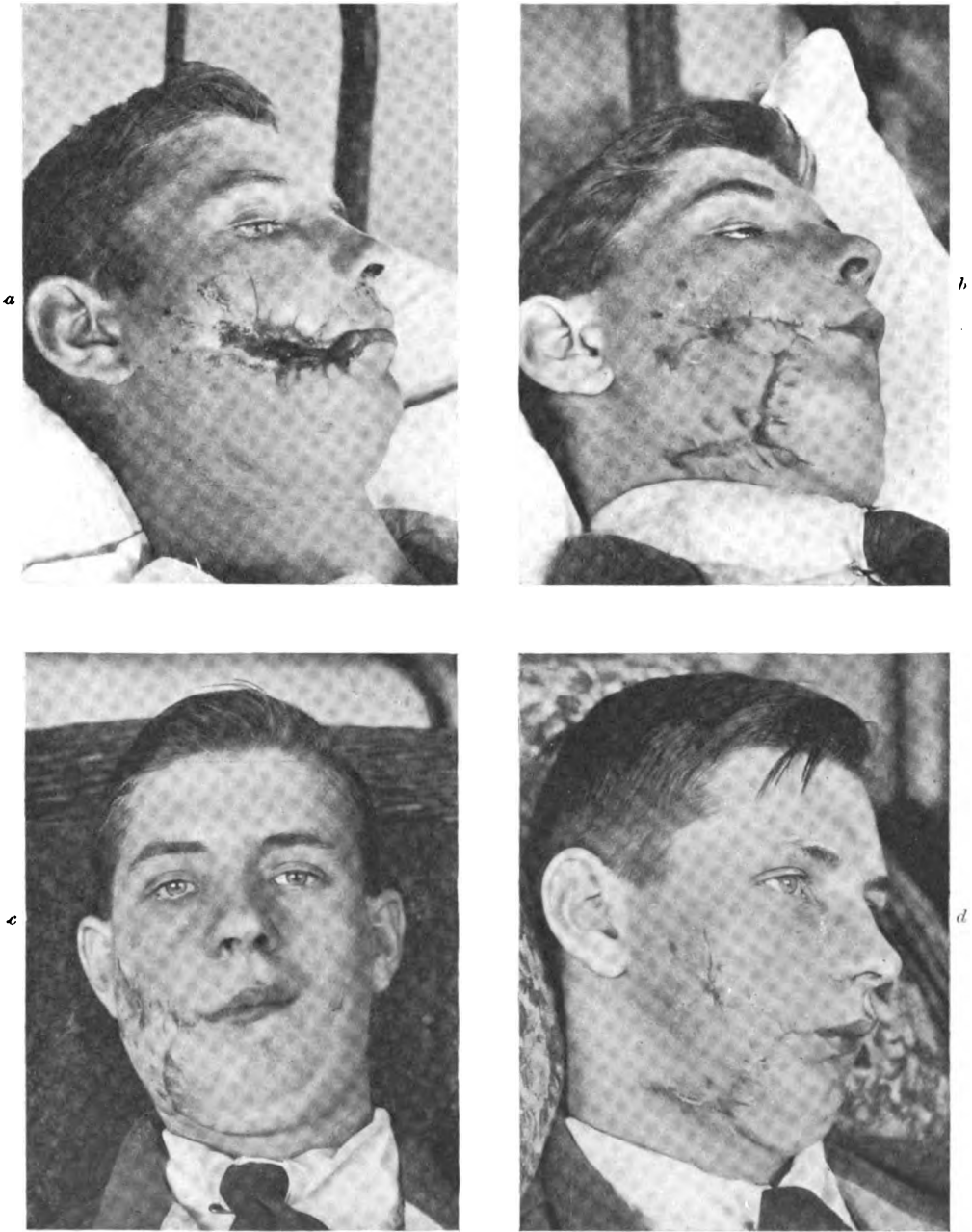

FIG. 407 (Case I.).—Cheloid scars treated by radiations.

This case was treated by radium (200 mgrms. in small platinum tubes), a flat applicator being used with a filter of lead 3 mm. in thickness, several layers of lint being placed between this and the skin. The cheloid area was mapped out into squares, so as to ensure uniform distribution of radiation, and each area received 4 hours' exposure. Then an interval of one month was allowed to elapse before another application, and the treatment was continued for about three months.



FIG. 408 (Case III).—Restoration of suppleness to post-operative scars.

This case was treated by radium in order to reduce the cheloid condition caused by the contraction of tissues, and the technique was similar to that adopted in Case II. (Plate XC.).



FIG. 409 (Case IV.).—Soft parts radiated preparatory to a bone graft.

This case was treated by X-rays only, several $\frac{1}{2}$ pastille doses being given through 1 mm. filter of aluminium at intervals of a week. A Coolidge tube was used with a 15-inch coil and a mercury interrupter, the primary current 4 amps. and the secondary 4 m.-amps., with a 9-inch equivalent spark-gap.



FIG. 410 (Case III.).

After completion of treatment.

It is noteworthy that this patient developed a salivary fistula a few days after his operation. When referred to

The patient was admitted under my care as in Fig. 407 *a*. There was extensive loss of the tissues of the cheek, involving both skin and mucous membrane. With this was associated a compound comminuted fracture of the lower jaw. Fig. *b* shows the condition some three weeks after the operation, the cheloid condition not only affecting the scar, but presenting a raised, prominent, button-like mass at each stitch-hole. As the condition resisted other forms of treatment, the case was referred to Dr. Knox for radiation treatment. In Fig. *c* some definite improvement can be noted. In Fig. *d* the improvement, graphically, is very considerable. Clinically, the scars had lost their lividity, and had become supple.

the radio-therapeutic department, it was felt that other operative measures would be necessary to effect its closure. The fistula, however, rapidly healed, and has given no further trouble.



FIG. 411 (Case IV.).

After completion of treatment, showing normal lip line restored by muscular action.

Case II. illustrates a similar, but less marked, condition. This patient had sustained extensive injury to the soft tissues of the left cheek and the right side of the upper lip. An attempt at primary suture had been made, but without success. On admission the stitches had to be cut out and his condition is depicted in the first photograph (Plate XC. Fig. *a*). Healing rapidly took place, contraction being controlled by an intrabuccal splint, and at the stage shown in the second photograph (Fig. *b*) an operation was undertaken to restore the cheek and lip. The third photograph was taken

undertaken to restore the cheek and lip.

shortly after the operation. In Fig. *d* is shown the final result after radiation treatment.

Cosmetic improvement and restoration of suppleness in scars are illustrated by the following cases :

Case III.—Fig. 408 *a* shows the condition on admission. The wound in this case involved the right cheek and lip. There was associated with it considerable loss of bone affecting the right upper jaw. The upper lip was restored by a flap taken from the cheek, the loss of bone being made good by a suitable denture. Fig. 408 *b* was taken after the operation scars had been treated. Fig. 410 indicates the final result.

Case IV.—In this case the patient was very ill and operation had, of



FIG. 412 (Case V.).—On admission.

After treatment.

Nutrition of soft parts improved by radiations, and bone graft inserted.

necessity, to be postponed until his general condition had improved. The margins of the wound were rolled over and adherent to the ends of the fractured mandible. The parts were freely raised, the bone ends exposed, and, with a view to a future bone graft, decalcified bone was inserted to elevate the scar and maintain an adequate thickness of tissue between the skin and the mouth cavity. Fig. 409 *a* shows the condition of the soft parts before operation. There was, in addition, a considerable loss of bone in the lower jaw.

Fig. 409 *b* was taken a fortnight after operation.

Fig. 411 shows the result attained by systematic treatment. It is to be remarked that the normal lip line herein depicted has been determined entirely by muscular action brought to bear on a pliant scar.

Case V.—Fig. 412 *a* shows the condition on admission. Dead com-

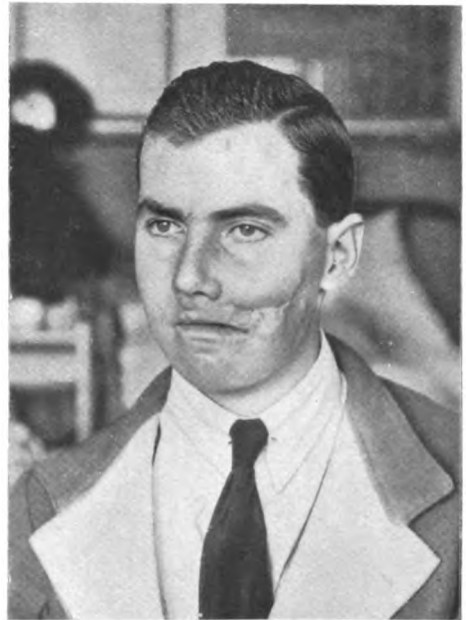
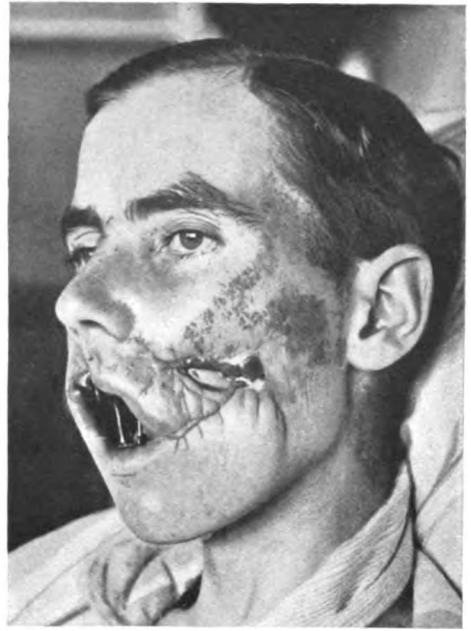

PLATE XC. (CASE II).—CHELOID SCARS OF UPPER LIP AND LEFT SIDE OF FACE.

Treated by radium (200 mgrms.) with a lead filter 3 mm. in thickness and 4 layers of lint inserted between the applicator and skin. The region was divided into four areas and an exposure of 4 hours was given to each area at each sitting.

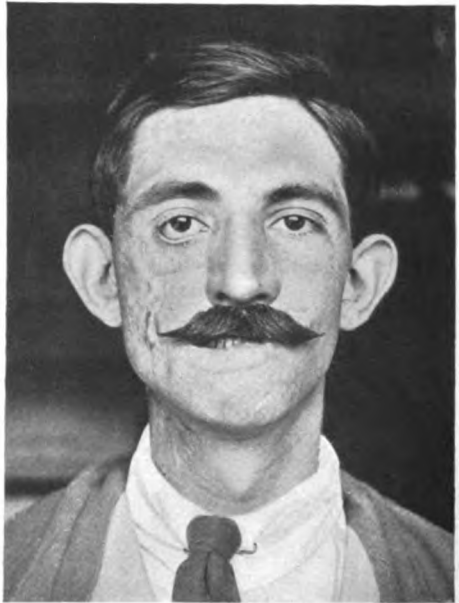
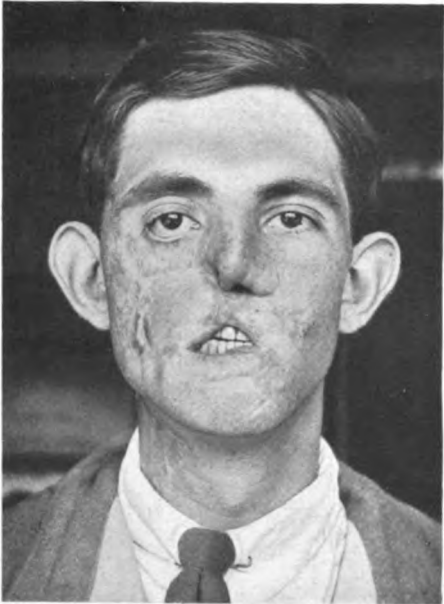

PLATE XCI. (CASE VII.)—APPEARANCE OF SCARS IMPROVED AND SUPPLENESS RESTORED TO A LARGE PECTORO-CERVICAL FLAP BY PERSISTENT TREATMENT WITH RADIUM AND X-RAYS.

Treatment extended from January to June, the face and neck being mapped out into a number of areas which were treated with exposures of from 2 to 4 hours each; 200 mgrms. of radium were used with a lead filter of 2 mm. and 4 layers of lint. When areas near the eye were treated the eyeball was protected by an additional lead filter. The radium applications were repeated at intervals of about a month. In addition, the patient received several small doses of X-rays.



FIG. 413 (Case VI.).—Cheloid scars of cheek and lips treated by radiations. Treated by radium (200 mgrms.) with 1 mm. lead filter and 4 layers of lint (three areas).

minuted bone was exposed at the bottom of the wound. A number of sequestra were exfoliated, the resulting loss of bone being considerable. The second photograph, Fig. 412 *b*, shows the result after operation on, and treatment of, the soft parts. The bony gap has since been dealt with by means of a bone graft taken from the patient's tibia.

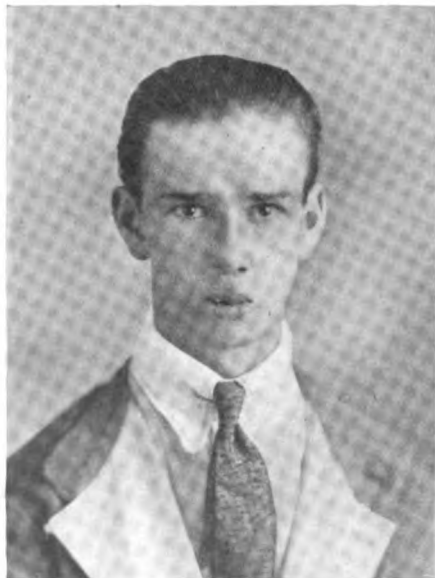

FIG. 414 (Case VI.).
Showing final result.

Case VI.—In Fig. 413 *a* it will be seen that the mouth cavity has been converted into a gaping chasm by destruction of and injury to the soft parts of the left cheek and upper lip. There was also an extensive comminuted fracture of the right side of the lower jaw. The lost mucous membrane was replaced by skin taken from the neck, the immediate result being shown in the second photograph, Fig. 413 *b*.

Fig. 414 was taken after his discharge, and forwarded to me by the patient himself. He has now returned to duty in the Army.

Case VII.—Plate XCI. Fig. *a* shows the condition on admission,



FIG. 415 (Case VIII).—Scars softened and soft parts radiated preparatory to the insertion of a bone graft.

The treatment here consisted of radium and X-rays combined. The technique employed was similar to that of Case VII. (Plate XCI.), except that a lead filter of only 1 mm. was used. After the bone graft was inserted the patient received small doses of X-rays during May and June at intervals of about a week.



FIG. 416 (Case IX).—Depilation to permit inversion of skin to replace mucous membrane.

The preparatory treatment was carried on from July 4, 1917, to August 20, 1917. On July 4 the patient received 1 p.d. without a filter; from July 13 to 20 the hair was reported as coming out satisfactorily, and on August 3 a second dose was given with $\frac{1}{2}$ mm. aluminium filter. After the operation the patient received one or two doses of X-rays in order to make the scar more supple. On these occasions a filter of 2 mm. aluminium was used.

and it will be observed that all the soft tissues of the right cheek had been destroyed.

Fig. *b* shows a pectoro-cervical flap in position.

Fig. *c* shows the result obtained after several operations. Treatment has been begun, but is not yet completed. The facial scars are becoming less noticeable. The neck and chest scars are as supple and pliant as normal skin.

Fig. *d*.—The same patient with artificial teeth, nose, and moustache. His functional capacity as regards mastication, control of saliva, and nasal breathing has been completely restored.

Case VIII.—Fig. 415 *a* shows the condition on admission. Dotted along and still adherent to the lower lip of the wound are scattered necrotic fragments of the shattered lower jaw. The tongue can be seen protruding into the wound, while above it the metal bar of an intrabuccal splint is visible.

Fig. 415 *b* was taken after a neck-flap had been fashioned and utilised to make good the loss of soft parts. The facial and neck scars have been systematically treated. Normal pliancy has everywhere been restored, and disfigurement is, as can be seen, very slight.

The depilating power of radiations has proved of great value in the technique of plastic surgery of the face. Ability to destroy hair follicles has made it possible to utilise a hair-growing flap to remedy a defect in a hairless area of the face. The restoration of lost mucous membrane is at once one of the most difficult and one of the most important problems

that confront the plastic surgeon. Experience shows that skin is an efficient substitute. Such skin must, however, be hairless to ensure comfort and cleanliness to the patient. In suitable cases the skin immediately surrounding the defect has been inverted to make good the mucous membrane lost. As such defects necessarily occur on the hair-growing area of the face, this cannot be done till the selected area has been subjected to a radiation dosage sufficient to determine the death of the hair follicles and the production of a smooth, hairless surface of skin. The raw surface thus exposed by the skin inversion is immediately filled in by a superimposed flap taken from the neck.



FIG. 417 (Case IX.).

After completion of treatment.

The depilating properties of radiations have thus been pressed into the service of the surgeon in what



FIG. 418 (Case X).—Depilation of hair-bearing surface similar to Case IX.

is, I believe, an entirely novel manner. Depilation, preparatory to inversion, can best be considered in connection with a concrete case.

Case IX.—Fig. 416 *a* illustrates the condition of a patient after re-incision of a primarily sutured wound. This drastic step was rendered necessary

owing to the fact that the patient was unable to open his mouth, being prevented therefrom by the unyielding scar which involved all the thickness of the cheek. Quick access was essential to deal adequately with the extensive fracture which complicated the lesion of the soft parts.



FIG. 419 (Case X).

A later stage, showing improvement already effected.

Fig. 416 *b*, taken a fortnight later, shows healing in progress. In the gap can be seen a portion of a vulcanite shield, adapted to the splint with a view to preserving the normal contour. As soon as skin and mucous membrane had merged round the margins of the gap, the case was handed over for depilation. Over an area surrounding the gap and measuring $\frac{3}{4}$ of an inch in width

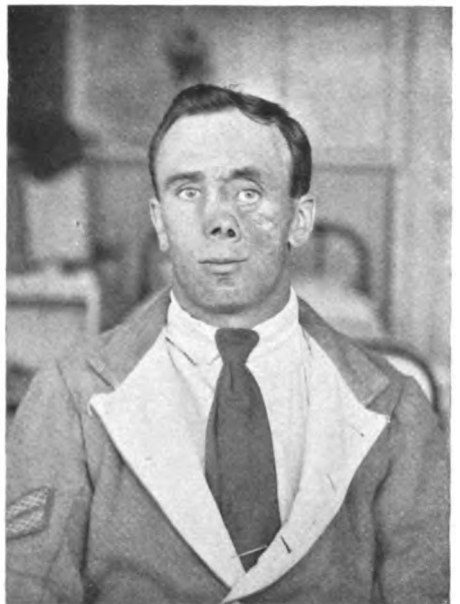

PLATE XCII. (CASE XI.)--DEPILATION OF HAIR-BEARING FLAP TO MAKE GOOD A DEFECT IN HAIRLESS AREA OF FACE.

This case had X-ray treatment extending from April to July. On April 20, one pastille dose was given without a filter; on April 27 a second similar dose was given with $\frac{1}{2}$ mm. filter, and by May 14 all hair was reported as depilated except at a small angular area near the nose. On June 6 $\frac{1}{2}$ p.d. was given with 2 mm. filter, and on July 27 1 p.d. without filter was given in order to complete the depilation of a few hairs. A reaction was reported shortly after the final dose, but this cleared up and the result was satisfactory.



PLATE XCIII. (CASE XII.).—DEPILATION OF HAIR-BEARING FLAP SIMILAR TO CASE XI.

This case presents an interesting feature, owing to the fact that only the extreme end of the hairy flap had to be depilated, the other portion having to be restored to the scalp after the necessary portion near the nose had united. It was therefore necessary to protect adequately the portion of the flap between the eye and ear so as to avoid injury to the hair follicles. This was effected by a thick lead screen covering all except the portion to be irradiated. Fig. *c* shows the depilated portion near the nose, the other part having been shaved. The treatment consisted of 1 p.d. without a filter, and 14 days later $\frac{3}{4}$ p.d. was given with $\frac{1}{4}$ mm. filter.

the hair follicles were destroyed by carefully administered radiations. As soon as the process was completed, operation was undertaken. Two flaps, one from the upper, the other from the lower lip of the wound, were reflected down and up respectively. They included the whole depilated area, and were hinged on the margins of the gap. These flaps were then united, thus inverting the depilated muco-cutaneous area to make good the loss of mucous membrane. The large fresh raw surface thus exposed was then covered by a superimposed transposed skin-flap taken from the neck. Fig. 417 shows the result obtained a month after operation. Union of the fractured lower jaw has taken place in good position.

Another case, treated on similar lines, is illustrated by *Case X*. This patient had been wounded by a fragment of shell. The lower jaw had been fractured and the injury to the overlying soft parts had been extensive (Fig. 418 *a*). In the second photograph, Fig. 418 *b*, healing has progressed, contraction being controlled by an intrabuccal splint. The operative measures were similar to those detailed in the description of the preceding case, and the result is depicted in the third photograph, Fig. 419. Further considerable improvement will certainly ensue.

Injuries of the face of the type herein depicted are relatively common. The "depilation-inversion" method, as it may be designated, is, in my opinion, at once one of the easiest and most satisfactory methods of making good the defect.

The value of depilating a transferred flap will best be estimated by a consideration of the photographs illustrating *Case XI*. (Plate XCII.).

The patient was referred to me in the condition shown in Fig. *a*. The nasal septum and floor of the nose were fully displayed.

In Fig. *b* a pedicled flap taken from the scalp is in position.

In Fig. *c* the pedicle has been cut and the redundant portion turned back to fill the lower part of the scalp defect. The transferred flap grew hair abundantly, and was shaved daily by the Sister-in-charge. The extremity of the flap was then subjected to radiations and successfully depilated.

The final result is depicted in Fig. *d*. The skin of the flap is perfectly supple, smooth, and hairless. The scalp scar can barely be detected.

In *Case XII*, a similar defect is illustrated. Figs. *a*, *b*, and *c* in Plate XCIII. are self-explanatory. The final result is shown in Fig. *d*.

Some interesting cases of salivary fistula, resulting from war wounds, have come under my care. In one already mentioned (*Case I.*) radiations alone sufficed to determine a permanent cure. Another patient was sent to me for an intractable fistula connected with the lower portion of the parotid gland. Operation had previously failed to relieve the condition. I excised the fistulous tract together with the involved gland lobule, but some leakage began about a week after operation. After treatment by radiations the leakage entirely ceased, and has not recurred. Another patient was referred to me for a salivary fistula, obviously connected with Stenson's duct. Several operations for its cure had been undertaken without success. The region of

the original orifice in the mouth was a mass of scar tissue, and the whole of the secretion of the parotid escaped from the fistula, so that the patient was constantly wet, and especially so at meal times. Radiations alone



FIG. 420 (Case XIII).—Parotid fistula healed by operation aided by radiations.

failed to give any relief, and I decided to help matters by an open operation. The duct was exposed through a curved incision (*Case XIII.*, Fig. 420). Its end was completely stenosed. An aperture in its wall was discovered a full $\frac{1}{4}$ -inch from its sealed termination. This sealed portion was cut away, and the duct transplanted to open into the mouth well behind its normal position. The reconstructed channel into the mouth remained patent, but after a week some leakage again took place from the cheek. This condition was effectually dealt with by radiations. All leakage ceased, and the patient was discharged quite cured.

The utility of radiations as an auxiliary measure in bone-grafting has been decided by a

process of deductive observation. A formidable difficulty in the worst cases is the poor nutrition of the tissues in the neighbourhood of the ununited ends of the bone. Where loss of bone is considerable, damage to the overlying soft tissues has frequently been extensive. Cicatricial tissue forms a poor bed for the inserted graft. Failure to appreciate the importance of this fact is to be held responsible for many operative failures. Several cases submitted to radiation treatment for other reasons have subsequently needed to be grafted. I have, at the operation, been struck by the yielding nature and vascular condition of the scarred tissues. So firmly convinced am I of the benefit of radiations as a preparatory procedure to bone-grafting, that it is my custom to refer to Dr. Knox all such cases as exhibit the presence of ill-nourished cicatricial tissue surrounding the site of fracture. Cases IV., V., and VIII. are specific instances in which the above statements held good.

The marked nutritional improvement resulting from the effect of radiations is such as naturally to suggest that treatment might beneficially be continued after the grafting operation has been performed. This plan has now been adopted, but it would be premature to make any definite statements as to its value in hastening or promoting success.

Special Points in the Technique employed in the Treatment of Cases dealt with by Mr. Cole

The majority of the cases received radium treatment ; a small number were treated by X-rays. In nearly all of the cases massage was employed as an auxiliary agent ; the massage was given by a trained masseur ; a limited number were treated by vibro-massage. One case which required a plastic operation after excision of a rodent ulcer was treated by X-rays and vibro-massage. This gave a most satisfactory result.

The radium (200 mgrms.) was used in three platinum tubes of $\frac{1}{2}$ to 1 mm. thick, 2-3 mm. of lead added to this, and several layers of lint interposed between the lead screen and the skin surface. In all of these exposures the Gamma radiation was employed. The areas to be treated were marked out, and each received an exposure of four hours.

The exposures were repeated after a sufficient interval of time had been allowed to elapse in order that superficial skin reaction might be avoided. In one or two cases the skin showed reaction after a week or two, but the majority failed to show any, or at most a very slight, reddening of the skin.

The occurrence of reaction might be attributed to some overlapping of the exposures to adjacent areas, whereby portions of skin received a double dose. In nearly all cases the dose was estimated to be well within the limits required in order to produce an erythema of the skin with the quantity of radium used. In dealing with these cheloid conditions of scar it was realised that the tissues were in all probability liable to react quickly to over-dosage ; accordingly, as far as possible this was avoided.

The estimation of the dosage under new and therefore unknown conditions was arrived at by a knowledge of the activity of the radium when used in civil practice ; this seems to indicate that work of this kind should only be undertaken by experts whose knowledge of the technique of radium-therapy is fairly extensive.

The particulars of dosage are given under each case. It is hoped that these details may be helpful to others who may wish to employ this most valuable aid to plastic surgery. The response of the tissues to radiation was most marked, probably because the treatment was commenced soon after the cheloid had formed, and as soon after operation as possible. Cheloid scars formerly treated in civil practice had not responded so rapidly, no doubt because they had not been subjected to treatment early enough. In all cases requiring treatment it would appear to be rational to treat as soon as possible after the operative measures are completed.

All cases operated upon for gunshot injuries of the face and scalp should be subjected to radiation treatment in the hope that cheloid formation may be prevented. Septic cases would receive benefit from the ultra-violet radiation.

The X-ray technique is similar to that employed in ordinary civil work.

For depilation an unfiltered dose is administered, and the case watched for reaction and the falling out of the hair ; at a fortnight after the first dose another full dose is given. Two or three doses are generally sufficient to determine the destruction of the hair follicles.

In the treatment of cheloid conditions and indurated tissues it has been found that small doses administered frequently give better results than large doses at longer intervals : $\frac{1}{3}$ to $\frac{1}{2}$ p.d. through $\frac{1}{2}$ to 2 mm. of aluminium twice a week is generally sufficient to obtain the desired result. The same applies to those cases referred to by Mr. Cole, where the radiations are employed as an auxiliary measure to bone-grafting. Carefully administered small doses at frequent intervals have been employed in the treatment of all these cases.

In the treatment of sepsis associated with these conditions the ultra-violet radiations have been combined with X-rays and radium rays.

From a consideration of the results obtained by the combined operative and radiation treatment and the experience acquired in technique, the conviction is arrived at that much better results could be obtained more speedily if from the outset radiation treatment could be employed. Thus if, when the patient is first dealt with (when the wound is healing), ultra-violet rays were employed the septic process could be checked and healing promoted. A few exposures to X-rays would be helpful at this stage ; then when operative measures are employed the radiations could be resumed at intervals throughout the progress of the case. Many indurated scars and cheloid conditions would be avoided, the time taken to obtain a satisfactory result would be greatly shortened, the work of the surgeon would be facilitated, and the ultimate result greatly improved.

GENERAL DISEASES MET WITH IN MILITARY PRACTICE

Chronic sciatica and neuralgic conditions are frequently met with. These must be very carefully treated by radiations and various forms of electrical treatment. A judicious combination of electrical treatment, massage, and radiations will often give surprising results in cases which have for long resisted treatment by either agent alone. The X-ray technique is simple—a radiograph of the hip-joint, sacro-iliac articulation, and the adjacent pelvic bones. This determines or excludes the presence of abnormalities likely to give rise to pressure upon the sciatic nerve. If a negative result is obtained, it will strengthen our opinion regarding the need for systematic treatment in other directions. The sciatic nerve should be irradiated from the posterior aspect. A large area is exposed to the radiations from a hard X-ray bulb, 8-10 Bauer or harder; a filter of 1 mm. aluminium is used. The whole nerve from the hip to the knee should be thoroughly irradiated. In other cases it will be found that $\frac{1}{2}$ p.d. given three times a week will have a most beneficial action upon the painful condition. It is necessary to persevere with treatment over a considerable period of time, and to insist on massage and passive movements in cases which are not responding well to the radiations.

In addition to the condition already referred to, there is a class of case, to whose numbers additions are being made, which may be described under the generic term general diseases, meaning those cases which, while exhibiting well-marked local signs, are due to a general disturbance of the metabolism or to an infected condition acting upon a number of the tissues of the body.

This class includes tuberculosis of the lymphatic glands (tubercular adenitis), lymphadenoma (Hodgkin's disease), exophthalmic goitre, hyperthyroidism (soldier's heart), leukæmia, with or without enlargement of the spleen and lymphatic glands, enlargement of the spleen in various diseases, particularly in malaria. Actinomycosis of the face and neck have been met with where the combined treatment by operation, potassium iodide, and radiations resulted in a complete cure and the return of the patient to active service.

The majority of these conditions have been dealt with in other sections of the work, but in order to illustrate the usefulness of radiations in cases met with in military practice, it has been thought advisable to deal particu-

larly with the more common of these morbid processes, in the hope that other radiologists may be induced to give a thorough trial to a method of treatment which already has given encouraging results at the hands of the few who have had the opportunity of testing it.

Of these the most interesting and striking is the condition known as exophthalmic goitre, and its associated conditions of hyperthyroidism and soldier's heart, the latter in so far as its etiology associates it with a morbid condition of the thyroid gland. In order to follow the course of these conditions and to note their bearings one to the other, it will be necessary to consider briefly the classical description of exophthalmic goitre, also the

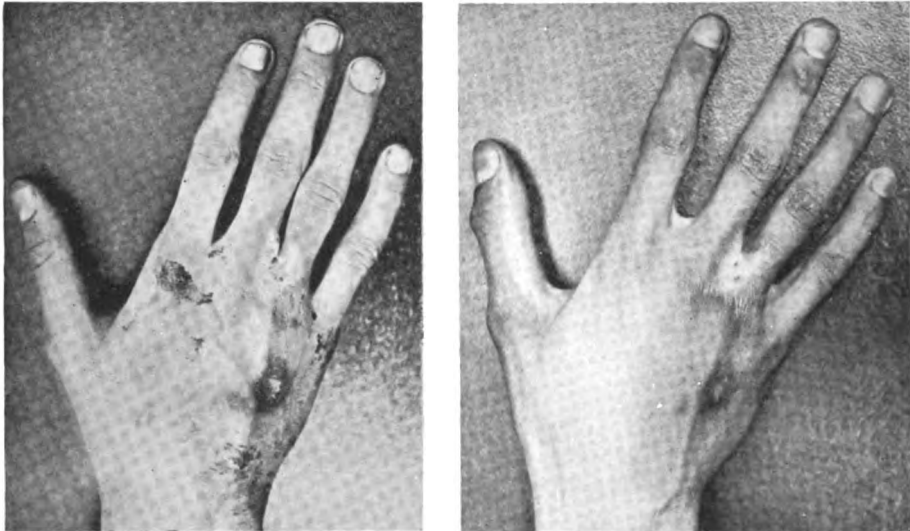

FIG. 421.—Lupus of hand treated by X-rays.
a, Before treatment. *b*, After treatment.

recent literature on the subject so far as radiation therapy is concerned, and to give a description of the technique employed.

Exophthalmic Goitre—Graves, Basedow, or Parry's Disease

A disease characterised by exophthalmos, enlargement of the thyroid gland, and functional disturbance of the vascular system. It is very possibly caused by disturbed function of the thyroid gland (hyperthyroidism).

Caleb Hillier Parry (1825) gives a description of eight cases of enlargement of the thyroid gland in connection with enlargement or palpitation of the heart. He describes the first case seen in 1786. He describes also the exophthalmos. The eyes were protruding from their sockets, and the countenances exhibited an appearance of agitation and distress, especially in any muscular movement.

Graves described the disease in 1835, and Bazedow in 1840.

Etiology.—In civil practice the disease is more frequent in women than in men. Of 200 cases tabulated by Esbner, 161 occurred in females. The age of onset is generally from the twentieth to the thirtieth year. It is sometimes seen in several members of the same family. Worry, fright, or depressing emotions precede the development of the disease in a number of cases. The explanation of the connection between the emotions and the pathological conditions underlying the symptoms is not an easy one. The disease is regarded by some as a pure neurosis, in support of which view may be considered the onset after a profound emotion, the absence of lesions, and the cure which has followed upon operations on the nose or adjacent organs. It is interesting in this connection to comment on the large number of cases met with in military practice of undoubted hyperthyroidism, where the environment of the patients has been undoubtedly such as would favour emotional disturbances in individuals predisposed to such manifestations, strain over long periods of time, want of sleep and food, constant nerve-racking, leading in the end to a development of the classical symptoms; and these, occurring in men who up to the time they were subjected to these conditions were presumably normal subjects, lead us to the conclusion that the nervous system plays a most important rôle in the development of the disease.

Others believe that it is due to a central lesion of the medulla oblongata. In support of this there is a certain amount of experimental evidence, and in a number of autopsies changes have been found in the medulla.

A view has been put forward by Moebius and by Greenfield that exophthalmic goitre is primarily a disease of the thyroid gland (hyperthyroidism) in contradistinction to myxœdema (athyrea). The clinical contrast between these two diseases is suggestive: the increased excitability of the nervous system, the flushed moist skin, the vascular erythism in the one; the dull apathy, the low temperature, slow pulse, and dry skin of the other.

The changes in the thyroid gland in exophthalmic goitre are, as shown by Greenfield, those of an organ in active evolution, viz. increased proliferation, with the production of newly-formed tubular spaces and absorption of the colloid material, which is replaced by a more mucinous fluid.

Thyroid extract given in excess produces symptoms not unlike those of exophthalmic goitre, viz. tachycardia, tremor, headache, sweating, and prostration.

Thyroid extract, when administered to cases of exophthalmic goitre, usually aggravates the symptoms, while the most successful line of treatment has been directed to reduce the bulk of the enlarged gland. (Of all the measures hitherto employed to attain this end, none have been so successful as carefully applied doses of radiations from an X-ray bulb or from radium.)

These are a few of the considerations which favour the view that the symptoms are due to disturbed function of the thyroid gland, probably to hypersecretion of certain materials, which induce a state of chronic intoxication.

Myxœdema may develop in the last stages, and there are transient

œdema and a few cases of scleroderma, which indicate that the nutrition of the skin is involved. The occurrence of myxœdema in a small number of cases of exophthalmic goitre treated successfully by X-rays must not be overlooked.

Persistence of the thymus is almost the rule, but its significance is unknown (Hector Mackenzie).

Symptoms.—There are four characteristic symptoms of the disease: exophthalmos, tachycardia, enlargement of the thyroid, and tremor.

Tachycardia.—Rapid action of the heart is one of a series of remarkable vascular phenomena. The pulse-rate may beat at first not more than 95-100, but when the disease is established it may be from 140 to 160, or even higher. Irregularity of action is not common, except towards the close. It may, however, be an untoward result of treatment, as in a case treated by radium, where the pulse-rate fell to the normal in frequency, but was accompanied by a most persistent and disturbing irregularity.

Exophthalmos.—This may be unilateral, and usually follows the vascular disturbance. It is recognised by the protrusion of the eyeballs and partly by the fact that the lids do not close completely over the sclerotics, so that a rim of white is seen above and below the cornea. The eye may in severe cases be dislocated from the socket, or both eyes may be destroyed by panophthalmitis. The vision is normal.

Graefe noticed that when the eyeball is moved downwards the upper lid does not follow it as in health. This is known as Graefe's sign.

Stelling's sign: the palpebral aperture is wider than in health, owing to spasmodic retraction of the upper lid. Moebius has called attention to the lack of convergence of the two eyes.

Enlargement of the thyroid commonly occurs with the exophthalmos. It may be general or only one lobe may be involved, and is rarely as large as an ordinary goitre. A thrill is felt on pulsation, and an auscultation or loud systolic murmur, or more commonly a *bruit de diable*. A double murmur is common and is pathognomonic.

Tremor is the fourth cardinal symptom, and was first described by Bazedow. It is involuntary, at the rate of five to eight to the second. It is of great importance in the early diagnosis of the disease.

Other symptoms may be met with: anæmia, emaciation, and slight fever; attacks of vomiting and diarrhœa may also occur.

Erythematous flushing is common. Pruritis may occur; a myxœdematous state may supervene. Pigmentary changes are common. Multiple telangiectasis has been described as occurring. Mental disturbances of various degrees are not uncommon.

The course of the disease is usually chronic, lasting several years. A very small proportion of the cases may get well, but when the disease is well advanced recovery is rare. These are interesting in view of the occurrence of pigmentation and telangiectasis after prolonged radiation treatment.

In the preceding paragraphs I have availed myself of the data relating to this disease given in Osler's *System of Medicine*.

The irregular cases which exhibit only one or other of the cardinal symptoms will give rise to doubt as to the exact nature of the disease. When met with in military practice hyperthyroidism may, in patients subjected to unusual strain, give rise to symptoms which might not have been noticed in civil life. The earlier symptoms may assume undue proportions as a result of severe strain. The tremor so often noticed in these cases may quite well be an early symptom thrown into prominence by nerve strain; so also may the tachycardia of a moderate degree, so far as the effect of over-secretion is concerned, be aggravated by heart strain or over-smoking. It may be that a moderate degree of over-secretion, occurring periodically in apparently normal subjects, may give rise to no pronounced symptoms when under normal conditions, while a similar degree of over-secretion occurring in a patient subjected to great mental and physical strain will be sufficient to call attention to symptoms. Patients who have a predisposition to disease of this type will more readily develop symptoms while living in the present abnormal times. The general surroundings of a soldier engaged in warfare predispose to the development of disease for which he may have a hereditary or other tendency.

The association of hyperthyroidism (soldier's heart) and exophthalmic goitre is a most interesting one, and worthy of close analytical survey of all the factors entering into their connection.

A review of the recent literature on the subject is most instructive, particularly when it deals with treatment. There is a remarkable unanimity on the value of radiations in diseases of the thyroid gland, particularly in regard to the efficacy of X-ray treatment. Radium has been tried by a limited number of workers, but as yet it has hardly received the recognition it deserves in the treatment of these conditions. The great majority of observers have used X-rays exclusively with great benefit, and when such results as are recorded can be obtained, it appears that there is hardly any need to look further afield for a more potent remedy. From a considerable experience in the use of both agents, the writer has no hesitation in stating that equally good results may be obtained by the use of radium if a sufficiently large quantity is available and the proper technique is employed. Radium may succeed where X-rays fail, and *vice versa*. The technique may be faultily applied in both instances. The importance of treating each case on its merits and varying the technique employed to meet the needs of the particular case must not be overlooked. There are no hard-and-fast rules which can be definitely laid down to suit all cases when either agent is employed. Circumstances may exist in a particular case which call for the use of radium rather than X-rays. Thus, in the very acute cases, if X-rays cannot be administered at the bedside, radium must be the agent of choice, because it *can* be readily applied. It is not likely to disturb a nervous patient, and it needs no great skill in its application. The duration of the exposure is determined by the quantity of radium available; the filtration can be arranged, and the areas to be treated marked out on the skin; the duration of the exposure can be fixed. Under these conditions a

competent nurse can change the applicator at stated times, and the radium can be used throughout the whole day and night. This means a considerable saving in time.

When necessary an X-ray apparatus can be brought to the bedside and treatment administered. Modern outfits are moderately silent, but even the most silent makes some noise. The tube requires to be adjusted to the area, and treatment can only be carried out by a skilled assistant. In hospitals where a large number of cases require treatment, both agents should be available, and the choice left to the radiologist.

The question of dosage is a most important one, and must always be left to the skilled radiologist, whose duty it is to see that each case is treated according to its needs. It may be necessary to vary the treatment considerably, while if one agent is not apparently securing the proper action, recourse can be had to the other. The radiation from radium may be required to produce an effect which is beyond the reach of the hardest X-ray obtainable.

The acute case has to be very carefully handled. Other measures than radiation are necessary, viz. rest in bed in a quiet room with plenty of fresh air, proper food, and the administration of drugs. Such a case may require to get daily dosage for a week or two, varying the area of irradiation as much as possible in order to avoid over-action on the skin.

Other cases can be successfully treated by small doses administered three times a week— $\frac{1}{3}$ of a pastille dose given to three areas, viz. one to the left side of the thyroid gland, one to the right side, and a dose to the centre area of the root of the neck to include the thymus gland.

Filtered radiations should be employed, 1, 2, or 3 mm. of aluminium being used according to the needs of the case. Secondary filters of chamois leather, loofah sponge, or other material are necessary to absorb the "softer" radiations and the secondary ones given off from the aluminium filter.

Great care should always be exercised in order to avoid over-action of the skin. Excellent therapeutic effects can be produced with no vestige of skin reaction in these cases. Dermatitis after X-radiation in these cases is without doubt evidence of faulty technique, and should be avoided at all costs.

The employment of a very hard radiation, practically homogeneous, such as may be obtained from the Coolidge tube, is a means towards the avoidance of skin reaction. Thick secondary filters are used as a precautionary measure. Radium, when employed properly, gives rise to no reaction, yet the therapeutic effects are most excellent. It can, however, if improperly used, either through over-exposure or under-filtration, produce marked dermatitis. The occurrence of reaction is detrimental in other ways. It is then necessary to suspend treatment in order to allow the skin to recover before another treatment is given. This is a strong argument in favour of avoiding over-action, because valuable time is thus lost.

The less acute case requires to be treated on the same general lines, though greater latitude in regard to rest in bed may be allowed. Such

cases are able to come to the X-ray department for treatment. The dosage should vary with the acuteness of the symptoms. Two or three doses a week may be given consisting of $\frac{1}{3}$ pastille dose, estimated by Sabouraud and Noiré's pastilles, to one or more areas. The treatment should be continued for some time after symptoms have been relieved or have disappeared. The earliest signs of improvement are a feeling of well-being after a few exposures. This is most probably the result of a tonic action due to the radiations. Tremor diminishes, the pulse slows down, and then there is a gradual reduction in the size of the thyroid gland. The exophthalmos is generally very slowly reduced. Patients complain of feeling "nervous" for a considerable time after a symptomatic cure has been obtained. There exists for many months a feeling of apprehension and a lack of "grip" on the part of the patient. It is well in all cases to give an occasional dose at long intervals. Patients are in this way reassured, and feel the tonic effect for some time after each irradiation.

The more chronic cases require to be most persistently treated. Several months may elapse before this type of patient admits improvement.

Weekly doses of $\frac{2}{3}$ pastille dose will often succeed where the more frequent dose has failed to produce an effect.

Massive doses do not appear to have more effect than the small dose administered at short intervals. It would appear that if we are to succeed in controlling the hypersecretion we must give the treatment frequently in order to exercise a practically continuous action upon the secretory function of the gland.

The ultimate aim of all treatment in these cases should be to control the secretion rather than to abolish it. Proper control will result in a symptomatic cure. Suppression of the activity of the gland will lead to a condition similar to myxœdema. The latter is not a condition to be aimed at, though in a limited number of cases it may be necessary to approach nearly to that point before symptoms are relieved. The action of the deeper radiation in these cases can be supplemented by exposure to ultra-violet radiations, or, if practicable, to direct sunlight, where the whole body surface may be exposed to the radiations.

The improvements induced by radiation treatment should be supplemented by those of rational hygiene, proper feeding and an environment which provides a plentiful supply of fresh air. If these measures are employed for several months after cessation of radiation treatment, the patient has a much better chance of consolidating the improvement in health and has a fair hope of ultimate recovery. Relapses will occur in a large number of cases. These can be treated on the first appearance of symptoms. Patients who have been cured should be cautioned against returning to the conditions which in the first instance precipitated the onset of the disease. It is open to question if men who have once developed the disease while engaged in warfare will ever be strong enough to again engage in the strenuous duties of an active combatant. Light duty should in all cases be tried before the man is again subjected to the strain of full active service.

The following are a number of extracts from papers dealing with radiation treatment of exophthalmic goitre, hyperthyroidism, etc. :

GRIER¹ divides cases of hyperthyroidism into four groups : (1) Simple hyperthyroidism, (2) acute exophthalmic goitre, (3) chronic exophthalmic goitre, (4) hyperthyroidism developing on an old goitre. In the first group operation is contra-indicated, and the author claims 100 per cent of cures in this type of hyperthyroidism by X-ray treatment. In the second group the author includes the classical cases of exophthalmic goitre, which, if untreated, either die or merge into the third group, where the cases continue in the same general condition for a long time. The fourth group is rather uncommon. The hyperthyroidism is readily amenable to X-ray treatment, although the goitre itself remains unaffected, especially if cystic. The proper treatment for these last cases is surgical. Of sixty-three cases of all kinds treated during the last four years, forty-five have been cured, six improved, and nine are still under treatment. Hyperthyroid cases respond to X-ray treatment according to the length of time the disease has been present, and not according to the severity of the symptoms. The acute exophthalmic cases improve almost miraculously, and within limits it is true to say that the more severe the symptoms the more prompt is the recovery. Soft goitres which have only been present about a year usually recover in two or three months. Hard goitres of long standing seldom show much improvement inside of six months. This author believes the massive dose type of treatment, especially in the acute type, to be dangerous. In the early stages of the exophthalmos, when it is due to engorgement of the blood-vessels, this will disappear under treatment. Later exophthalmos, due to a deposition of fat in the orbit, will not be influenced by X-ray treatment. All the treatment work referred to here has been done with the Coolidge tube since that made its appearance, but there is little or no difference in the final result as between the Coolidge and ordinary tubes. Four cases were treated after a ligation operation was done, the operation bringing about no improvement. Two of these cases recovered under X-ray treatment, and the other two, still under treatment, are on the way to recovery. An X-ray examination of all thyroid cases is made previous to treatment. In one case a mass was detected in the mediastinum, which was irradiated by the cross-fire method, and after a surprisingly small number of treatments the case completely recovered. The method recommended in the four groups above mentioned is, in the first, medical or X-ray treatment ; in the second, X-ray treatment is the most satisfactory, medical treatment is inadequate, and surgery unnecessary ; in the third, the choice lies between X-ray treatment and operation, depending on individual circumstances ; in the fourth, X-ray treatment is only palliative. The danger of producing myxœdema is also greater here, and the proper treatment is surgical.

FISCHER² believes X-rays to be far more effectual than all other measures

¹ *Amer. Journ. of Roentgenology*, June 1917.

² *Ugeskrift for Læger*, Copenhagen, Oct. 5, 1916.

combined, with the exception of the operative, in treatment of exophthalmic goitre. His figures of cases treated by X-rays show 80 per cent cured or materially improved. The number of cases treated was ninety-four suffering from exophthalmic goitre and thirty-seven simple goitre. Only two of the first group were men. Fully 20 per cent in this group were unable to be out of bed, except when they came for treatment. The affection was from one to four years' standing as a rule. A complete subsidence of all objective and subjective signs and symptoms of the exophthalmic goitre was realised in fifteen cases. In the other cases showing improvement, some of the symptoms subsided while others persisted. The enlarged thyroid subsided to normal size in twenty-two, and in fully two-thirds of the cases it became much reduced in size. The exophthalmos was the most refractory symptom. Ten X-ray sittings were usually given, and then an interval of three months was allowed before the treatment was resumed. The entire course took from six to twelve months. The therapeutic effect was never so prompt as in those cases where operative measures alone were adopted. Fischer thinks a trial is justified even in the operable cases.

HECTOR MACKENZIE¹ has not only tried the effect of X-ray exposures over the thyroid gland, but also over the thymus gland, being led to treat the thymus because he was not satisfied with the results of X-ray treatment to the thyroid alone. In 1909 he treated a number of cases in this way. Whether the treatment was employed for too short a time, or whether the dosage was too small, he does not state, but he says that he obtained no very conclusive results up to that time. He gives a number of illustrative examples, showing sometimes improvement, at other times no obvious effect, and one case in which X-rays converted exophthalmic goitre into myxœdema, which was subsequently cured by thyroid treatment. The total number of treatments in this last case was thirty-six, extending over a period of four years. Mackenzie thinks that the reason why X-rays have not yielded better results is because they have not been persevered with sufficiently long. He had never seen such a complete disappearance of the signs and symptoms of exophthalmic goitre as in this instance. He believes the X-ray treatment may prove to be by far the best means of treatment at command. But it must be applied in no half-hearted way. It must be persevered with, and in many cases continued for a long time. It is most likely to be beneficial in a case where the thyroid enlargement is moderate and the patient is not so seriously ill as to necessitate confinement to bed. It may prove valuable in bringing about a retrogression of the remaining portion of the thyroid after a hemithyroidectomy. Of radium treatment he has had no practical experience.

PFAHLER AND ZULICK² consider it justifiable to try X-ray treatment temporarily in all cases of exophthalmic goitre. The thymus should always be included in the area of irradiation. Whilst symptomatically improvement is shown, the goitre and the exophthalmos are the last to show any change,

¹ Bradshaw Lecture, delivered before Royal College of Physicians, November 2, 1916.

² *Amer. Journ. Roentgenology*, 1916, p. 63.

and in many cases show no change. A warning is given by the authors not to prolong the treatment over too great a period lest hypothyroidism (myxœdema) is produced.

MANNABERG,¹ in treating exophthalmic goitre, has exposed the ovaries instead of the thyroid gland in ten cases, and claims to have obtained good results. Whilst there was gain in weight and diminished tachycardia, it was particularly in the subjective state of the patients that the X-rays seemed to exert a remarkable effect. The combined effect of radiation of the thyroid and the ovaries at the same time was tried in three cases, but was not found to be successful, two of the cases becoming distinctly worse.

HALSTEAD,² in a number of cases in which he had removed the thyroid gland without any marked amelioration in the symptoms, was led to a trial of irradiation of the thymus gland. He arrived at the conclusion that some benefit was obtained by this method of treatment. It would be interesting to have the later records of these cases in view of the known production of myxœdema by total removal of the thyroid.

CASE³ states that in exophthalmic goitre X-rays administered by the present intensive methods gave results almost unbelievably good. The treatment was not merely symptomatic, but by virtue of the profound depression of the secretory function, it assumed the character of an etiologic therapy, since the treatment was aimed at the cause of a disease whose essential pathologic feature was hyperactivity, or aberration of the thyroid secretory function. He further states, in reference to the treatment of the thymus gland, that X-radiations had become well established as a routine measure, particularly in young patients. Very young patients responded more rapidly than those of more advanced age.

MALCOLM SEYMOUR⁴ gives the method of treatment followed in dealing with 144 cases of exophthalmic goitre at Massachusetts General Hospital. The neck is divided into three areas, right, left, and middle or suprasternal, and the treatment directed to these areas. A Coolidge tube is used. The average dose has amounted to about 4 H, which equals 5 Holzknacht, or 10 X Kienböck, or 1 B Sabouraud-Noiré. This is the dose necessary to produce a slight erythema. Some writers state that an erythema dose is too severe, but the author has not found this to be so. It seems advisable, however, to keep just below the erythema dose, so as not to cause any skin irritation, inasmuch as it seems evident that repeated erythematous doses may cause vessel changes in the skin covering the tumour or the tumour itself. In all cases the target of the tube was at a distance of 10 inches from the skin, and a filter of 4 mm. of aluminium and one thickness of sole leather was interposed. The dose has not been repeated inside of three or four weeks. While undergoing this treatment most of the patients have not changed their modes of living, except variation of the diet, which has been increased or favourably rearranged, and treatment

¹ *Arch. Rad. and Electr.*, 1915, i 333.

² *Johns Hopkins Hosp. Bull.* xxvi. 55.

³ *Proc. Chicago Medical Society*, March 1915.

⁴ *Boston Medical and Surgical Journal*, Oct. 19, 1916.

has been directed towards remedying the anæmia, which has been present in a considerable number of cases. This writer comes to the conclusion, in common with others, that in the X-ray treatment of hyperthyroidism the pulse-rate is nearly always reduced, and this almost at once. The tremor and nervous symptoms improve from the start. The gland rapidly diminishes in size in some cases, remains unaffected in others, but if hard, tense, and throbbing, the throbbing diminishes and the gland becomes softer. The body-weight practically always immediately increases. The advantages of the treatment are: (1) That there are no fatalities; (2) that there is no resulting scar, as after operation; (3) that it does not interfere with the patient's occupation; (4) that it is painless and causes very little inconvenience to the patient; (5) that if unsuccessful an operation may still be performed with less risk because of the favourable action of the X-rays on the thymus gland.

CHILDS¹ states that for exophthalmic goitre we have a remedy in Röntgen therapy which can relieve comparatively early the alarming symptoms in many cases, and if an operation is later deemed necessary, the patient will be in a better condition to withstand it successfully.

SIMPSON,² after giving the history of the application of X-rays to exophthalmic goitre, states that in every one of his own cases which has had three or more exposures a decided slowing of the pulse and a lessening of the nervousness and tremor have been apparent. Along with these results the size of the tumour has decreased in some cases, while the patients always gain in weight, look and feel better, and are better able to attend to their social and business duties. Very often the slowing of the pulse is noticeable after the second exposure, but after the third or fourth exposure the effects are more lasting. The author's method is first to cover the entire area with a layer of chamois leather to protect the skin from secondary rays given off from aluminium filters above. Over these a heavy lead protector 3 mm. thick is placed, a hole having previously been cut large enough to allow the tumour to be palpated and located. A Hampson's pastille is placed in a black envelope, which rests upon the skin of the patient and projects beyond the opening in the lead and chamois so as to ensure the pastille being in the field of irradiation. To increase the safety, brass discs are also used. These are kept $1\frac{1}{2}$ inches above the pastille and patient. The discs are $2\frac{1}{2}$ inches deep and are surmounted by an aluminium filter 1 mm. thick. The filter is 1 inch below the wall of the tube, which is 7 inches in diameter. This makes a distance of 5 inches from the wall of the tube, not anode, to the patient, and $8\frac{1}{2}$ inches from the anode to the patient. He gives between three and four points on a Hampson's radiometer, but never more than four for fear of a reaction in isolated cases. Treatments are never given oftener than once in two weeks, which allows the skin effects of one application to wear off before another is given. His general conclusions are: (1) Many cases of exophthalmic goitre are associated with

¹ Colorado State Medical Soc., Sept. 5-7, 1916.

² *Medical Record*, Sept. 4, 1915.

enlarged thymus glands, and this association often causes serious post-operative symptoms, and even death. (2) While such an association will seriously complicate and prolong a surgical operation, it offers no such added difficulties for the Röntgen therapist. (3) Not only such ductless glands as the ovaries and testicles but also the enlarged thyroid and thymus glands are very sensitive, and may be atrophied by the Röntgen ray. (4) This theory has been amply proved by laboratory experiments and clinical results in many cases of hyperactivity of the thymus gland, seen in cases of status lymphaticus, and hyperactivity of the thyroid gland, *i.e.* exophthalmic goitre. (5) If in cases of status lymphaticus and exophthalmic goitre the Röntgen ray is given a fair and impartial trial, the majority will be relieved of all troublesome symptoms, and a disfiguring, dangerous, and often fatal operation rendered unnecessary. (6) The above findings include the results of several hundred cases of exophthalmic goitre that have been successfully treated by the Röntgen ray. The author also gives the details of an experiment on guinea-pigs to demonstrate the action of X-rays on the thymus gland. To the unaided eye the amount of thymic tissue in the treated pigs was little more than half of that found in an untreated control case, and microscopically the findings were even more marked and could be divided into a capsular and interstitial hyperplasia, both increasing in a marked degree, leading to a distinct sclerosis and reduction in the amount of gland tissue proper.

HERNAMAN-JOHNSON¹ states that the action of X-rays in small doses in glandular affections appears to be—what may be termed for want of a better expression—a regulating one. If the gland is over-active, its hormone production is reduced, and should the secretion be vitiated, the treatment tends to restore it to the normal quality. Clinically, the most definite and striking effects are obtained in cases of Graves' disease. An acute case will often show less tremor and a diminution in the pulse-rate within three weeks. To obtain the quickest results, the sittings must be given three times weekly at least, comparatively small doses being used. A concentration of three small doses in the one application, made every week or ten days, has not the same effect. In acute cases threatening life, the X-ray apparatus should be set up in the patient's room, and daily treatments be administered for at least a week. With modern equipment there is no difficulty in setting up a silent running apparatus in a private house. The result is to cause the disappearance of the visible pulsation in the neck and the diminution of the gland, if this is enlarged, but often not to any great extent. The exophthalmos is but little reduced by the time a symptomatic cure is effected. The author adds that many patients with so-called shell-shock and soldier's heart are suffering from hyperthyroidism. When there is reasonable ground to believe that the thyroid is over-active, it should be treated with X-rays. All other appropriate measures should be used. Some cases do well, but the results are not so good as in civil practice. In some cases the hyperthyroidism seems to be part of what has been called "defensive reaction of the sub-

¹ *Practitioner*, July 1917.

conscious," that is, of a symptom complex, which prevents the man from again being sent into dangerous surroundings. Such cases are unlikely to be benefited unless they are assured that a cure will not mean return to the front. These men are not malingerers in any ordinary sense of the word; indeed, prior to the illness, they have often displayed gallantry in action.

ZIMMERN AND COTTENOT¹ state that signs of hyperthyroidism have been observed after irradiations of the cervical region. Experimentally, Zimmern and Battez have found similar results in the dog, and the histological examination has shown distinctive lesions of the gland. Applied to the treatment of exophthalmic goitre, this atrophying action has given very valuable results. In all cases, it is true, the glandular hypersecretion should not be induced; the syndrome of Basedow may be provoked by other causes. Radiotherapy is the treatment of choice in hypertrophy of the thymus.

SNOW² stated that in treating hyperthyroidism he employed the combined use of static wave-current, X-rays, and mechanical vibration. The first reduced the gland by forcing out accumulated colloid or effete matter; the second inhibited or lessened the excessive secretion of the thyroid gland; the third, applied over the proper intervertebral spaces, aided by contracting the arteries, thereby to a degree diminishing the excess secretion. This author claimed for the method uniform success, even in extreme cases, without danger or inconvenience to the patient.

[The author can corroborate these results to a certain extent. Combined X-rays and vibratory massage applied to the neck on both sides and over the enlarged gland has led to a marked improvement in several cases which did not respond to X-rays alone. The cases which responded favourably were the more chronic ones. Several cases of parenchymatous goitre improved under the combined treatment.]

DR. FLORENCE STONEY³ points out the very close connection there is between hyperactivity of the thyroid gland and the tachycardia and breathlessness seen in cases of irritable heart. She thinks that pyorrhœa is a common source for the causal germs, though not the only one. She is convinced that X-rays, when properly and vigorously applied, are a specific for exophthalmic goitre. The treatment she pursues is to apply the X-rays as vigorously as is compatible with safety of the skin. At first she did not filter, and got much mild dermatitis; now she gives much bigger doses filtered. One Sabouraud dose through 1 or 2 mm. of aluminium as a filter to each side of the thyroid weekly requires about twenty minutes. The results are in some cases slow, in others very rapid. The heart is one of the earliest organs to respond. Throbbing in the carotids disappears. The goitre first becomes softer and then diminishes in size till the neck becomes normal. The only risk is of temporary pigmentation of the skin, which may even go on to slight dermatitis, and later, in a few cases, to telangiectasis.

SEEUWEN,⁴ dealing with sixty cases of heart troubles in the Army,

¹ *Presse med.*, Feb. 18, 1914.

² Amer. Electrotherapeutic Association, *Proc. of Ann. Meeting*, 1915.

³ *Lancet*, i, 777, 1916.

⁴ *Lancet*, ii, 433.

states that deep applications of X-rays to the thyroid gland are very useful, especially on those men who have hypertrophied thyroid (25 per cent of the total). The application of X-rays is certainly one of the best methods of treatment now available for exophthalmic goitre.

OSLER,¹ under the section, Hyperthyroidism: Exophthalmic Goitre, states that marked benefit has followed the use of X-rays in a few cases.

SCHUTZINGER² relates a case of the sudden onset of exophthalmic goitre in a subject suffering from hyperthyroidism. The condition was the result of being badly shaken by the explosion of a shell. The symptoms gradually improved, the tremor in particular diminishing and finally ceasing under treatment with thyroidin tablets and X-rays.

WHEELER³ states that a moderate case of hyperthyroidism will be cured in three months if rigidly confined to bed in a private hospital for one month and treated by X-rays; for the second month the patient is allowed to return home to follow a strict invalid regime without X-rays, and for the third month resumption of the ordinary avocations is permitted, in conjunction with a second course of X-ray treatment.

WHITE AND HERNAMAN-JOHNSON⁴ relate three cases showing the connection between irritable heart of soldiers and Graves' disease. Many cases of irritable heart may be explained by a condition of hyperthyroidism—a sort of pre-Graves condition. Rapid pulse, sleeplessness, and tremor were the only signs present. In civil practice a few cases had shown in a fortnight definite benefit from X-rays, but a month was generally necessary for any effect to be seen. There was no sort of *a priori* certainty that the excellent results obtainable by X-rays in ordinary cases could be duplicated in the "military" form of the disease; but so far as the authors' experience has gone, this treatment appears beneficial. One of the patients was practically cured, and another very much improved in two months. The authors are of opinion that in all such cases of irritable heart, if there is the slightest suspicion of hyperthyroidism, the X-rays should be added to the other suitable measures of treatment.

AIKINS⁵ speaks favourably of radium applied locally over the thyroid gland in cases of exophthalmic goitre.

BARR⁶ had used X-rays in many cases of hyperthyroidism with some benefit ten years or more ago, but latterly he had not done so, as all his cases had done very well without the rays. He had no objection to their use, but he thought that caution should be exercised for fear of overshooting the mark.

The difference between the treatment employed ten years ago and that of the present day should be carefully considered. There can be no doubt that better results are obtained by modern technique.

WILSON,⁷ speaking in a discussion on soldier's heart, said that he had

¹ *The Principles and Practice of Medicine*, 1916.

² *Muench. med. Woch.*, 1916.

³ *Med. Ann.*, 1916, 575.

⁴ *Lancet*, 1916, i. 78.

⁵ *New York Med. Journ.*, July 1916, p. 49.

⁶ *Brit. Med. Journ.*, April 15, 1916.

⁷ *Disc. in Roy. Soc. Med.*, Jan. 18, 1916.

observed in some eighteen of his cases that the thyroid gland was definitely enlarged, and that the administration of thyroid extract seemed to exacerbate the symptoms. The application of X-rays to the thyroid gland was said to have effected improvement in some cases, but he had seen cases presenting very much the same clinical picture in which the administration of X-rays did not help matters at all.

Enlargement of the Thymus Gland alone or associated with Hyperthyroidism

LANGE¹ makes the following deductions :

(1) Röntgen irradiation of the thymus produces artificial involution of the gland.

(2) X-ray therapy is the method of choice in cases of enlarged thymus in children, whether the symptoms be mild or urgent.

(3) Urgent cases should receive repeated massive doses.

(4) Recurrences due to regeneration of the gland are to be watched for and controlled by further treatment.

(5) Children whose physical or mental development is retarded should, if suspicion is directed towards the thymus, receive tentative X-ray treatment even though a positive diagnosis cannot be established.

(6) X-ray therapy as a precautionary measure or pre-operative treatment may enable children of the so-called lymphatic type to withstand intercurrent disease or anæsthetics which would otherwise prove fatal.

(7) Pre-operative exposure of older children and adults, where there is a suspicion of enlarged thymus, may lessen operative mortality.

(8) Routine pre-operative X-ray treatment in cases of hyperthyroidism should be resorted to with a view to lessening operative mortality.

(9) X-ray exposure of the thymus gland has been proven harmless, whether in normal or abnormal individuals. A therapeutic test with the X-rays is, therefore, always permissible.

COOK² reports several cases of affections of the thymus treated with X-rays. He thinks that the possibilities of this method of treatment will increase as our experience of it grows. It is believed by many that there is a connection between enlargement of the thymus, adenoids, and hypertrophied tonsils, and the thymus condition may well be as common as the other two. The irradiation of all suspicious cases might save them from death under an anæsthetic or intercurrent affection occurring before the third year, at which time spontaneous relief usually occurs. The thymus is always a potential source of danger and possible cause of death. The inter-relation of enlarged thymus and hyperthyroidism is now pretty generally recognised. *Autopsies on cases of exophthalmic goitre show enlarged thymus in 75 per cent, and in the cases dying after operation the proportion*

¹ *Amer. Journ. Roentgenol.*, Dec. 1913.

² *Boston Medical and Surgical Journal*, Oct. 5, 1916.

was found at Munich to be even higher. As to X-ray technique, this author says that dosage varies so much that discussion of the subject is purposely omitted. It should be begun lightly, and increased if results do not follow. His average has been from two to three minutes with a hard ray filtered through aluminium.

Radium in the Treatment of Hyperthyroidism

AIKINS has found radium of decided benefit in the treatment of exophthalmic goitre. In his Presidential Address to the American Radium Society,¹ he states that Abbe was the first to use radium successfully in exophthalmic goitre, and his favourable experience of its results has been confirmed by others. The experiments of Horsley and Finzi showed that the most constant changes after radium were those affecting the blood-vessels. In refractory cases of exophthalmic goitre Aikins has found the treatment to be of decided benefit, and his clinical experience showed that when applied over the thyroid the more penetrating rays of radium diminish the vascularity and reduce the secretion of the gland. He had had seven successful cases in which the application of radium was followed by relief of the symptoms and by reduction in the size of the thyroid.

DAWSON TURNER,² in a Report on radium treatment at the Royal Infirmary, Edinburgh, during the year 1915, states that nine cases of exophthalmic goitre received radium treatment. The action of radium consists in producing a sclerosis of the thyroid gland, following upon an obliterative endarteritis. Diminution in the exophthalmos and tachycardia were amongst the first results observed. The cases benefited both in general health and in the special symptoms, even though there might be no actual reduction in the size of the affected gland. In one case the gland had even extended after radium treatment, but the patient was better, and the tachycardia had diminished. To avoid injury to the skin, small doses should be given to different areas and the softer rays should be cut off, but in hospital practice, when time has to be considered, only very penetrating rays filtered through silver 1.4 mm. thick, and with the radium salt maintained at a distance of 2 cm. from the skin, should be used. Twenty milligrammes of pure radium bromide can under such conditions be applied for twelve hours without damaging the skin, and the patient can be sent home for two or three months before making a fresh application.

A Report issued by the Manchester and District Radium Institute for 1915 gives details of seven cases of exophthalmic goitre which were treated by radium, and each of them showed improvement.

WEIL,³ dealing with the use of X-rays in cases of hypertrophy of the thymus, states that the sensibility of the thymus and its regression with small doses permit of obtaining constantly a cure in a very short time with doses of 5 to 6 Holzknacht units of heavily filtered rays.

¹ Pres. Add. Second Ann. Meeting of American Radium Society, June 4, 1917.

² *Edin. Med. Journ.*, March 1916.

³ *Paris med.*, May 16, 1914.

HERBERT FRENCH¹ states that in his experience of exophthalmic goitre a cure is not obtained by radium treatment, but only decided alleviation of symptoms. If operative measures are adopted, a preceding treatment by radium seems to make the operation itself secure and the results better. Treatment by X-rays has the disadvantage that applications have to be made two or even three times a week for a period measured in months. Radium treatment has the great advantage of being periodic—one to five days at a time, with an interval of six weeks or two months before a second series is required. Enough cases are not yet recorded to say whether radium results are as good as those from X-rays.

¹ *Med. Ann.*, 1916, p. 250.



GLOSSARY

- Accumulator.** A secondary or storage battery.
- Actinic Ray.** A ray of light or other form of radiant energy capable of producing chemical action.
- "Alive."** A wire is said to be alive when an electric current is passing along it.
- Alternating Current.** Currents whose directions are periodically reversed.
- Ammeter or Amperemeter.** Any form of galvanometer which is capable of measuring current strength in amperes.
- Ampere.** Unit of strength of the electric current, exerted by an electromotive force of one volt through a resistance of one ohm.
- Anode.** The positive pole of an electric battery or the electrode connected with it.
- Anti-cathode of X-Ray Tube.** A plate of platinum or other metal, supported inside an X-ray tube upon which the cathodic stream impinges.
- Aperiodic Galvanometer.** A galvanometer whose needle comes to rest without oscillations.
- Armature.** A coil of wire made to cut the lines of force from the field magnets.
- Automatic Cut-Out or Switch.** A device for automatically cutting off the current at any predetermined period of time by means of a time relay.
- Battery.** Apparatus for the production of an electromotive force.
- Blowing a Fuse.** The melting of a wire by the passage of an electric current through it.
- Break** (noun). (a) An instrument for periodically interrupting a circuit; (b) any interruption in an electric wire.
- Break** (to—verb). To interrupt an electric circuit as opposed to closing the circuit.
- B.T.U.** Board of Trade unit = 1000 watt-hours.
- Buckling.** The disintegration of the surface of the plates of a storage battery.
- Calibrate.** To determine the absolute values of scale divisions of an electrical instrument such as a galvanometer, voltmeter, wattmeter, etc.
- Candle-Power.** The intensity of light emitted by a luminous body estimated in standard candles.
- Capacity of Condenser.** The quantity of electricity a condenser is capable of holding in coulombs when charged to a pressure of one volt.
- Cathode.** The negative pole of an electric battery, or the electrode connected with it.
- Cathode Rays.** Rays originating in a vacuum tube at the negative terminal, when a discharge of electricity is passed through the tube. They are not identical with the Röntgen rays, since they are deviable by a magnet and by refracting media, and are rapidly absorbed by opaque bodies and by the atmosphere.
- Circuit.** A term employed to denote the total electrical path of an installation.
- Commutator, Current Reverser.** An apparatus for reversing the direction of the current.
- Condenser.** An apparatus for storing a large amount of electricity.
- Conductor.** Any substance which conducts or possesses the power of conducting electricity.
- Continuous Current** (also called Direct). A current whose direction is constant, as distinguished from alternating current.
- Coulomb.** Is that amount of electricity which is carried by an ampere flowing for one second past any given point in the circuit. There are 3600 coulombs in one ampere-hour.
- Current Strength.** In a direct-current circuit the quotient of the total electromotive force divided by the total resistance, or $C = \frac{E}{R}$

Current Transformer. (a) An instrument for changing an alternating into a direct current, or *vice versa*; (b) a device for altering the pressure of a current, which may be either a step-up, i.e. raises the pressure, or a step-down transformer, i.e. lowers the pressure.

Dead-Beat Galvanometer. A galvanometer whose needle comes quickly to rest instead of repeatedly swinging to and fro, through being heavily damped.

Dielectric. Any material which offers high resistance to the passage of an electric current.

Difference of Potential. When electricity moves, or tends to move, from one point to another, there is said to be a difference of potential between them.

Discharge. The disruptive passage of electric current when opposite polarities approximate, or a sudden equalisation of potentials.

Dynamo. A machine for the conversion of mechanical energy into electrical currents by means of electro-magnetic induction.

Dyne. The unit of force, i.e. the force which, if it acted for 1 second on a mass of 1 gramme, would, if the mass were previously at rest, give it a velocity of 1 centimetre per second.

Electric Efficiency. The ratio between the amount of current generated and the expenditure required to produce it.

Electroscope. An apparatus for detecting the presence of an electric charge or determining its polarity.

E.M.F. Electromotive force. The force exerted by an electrical charge.

Erg (*ergon*, work). The unit of work. It is that which is effected in raising 1.981 gm. to the height of 1 centimetre.

Farad. The practical unit of electric capacity.

Fault. Any defect in the proper working of a circuit.

Field (Magnetic). The space about a magnet through which its influence is active.

Filtration of X-Rays. Placing in the path of the rays some medium such as aluminium or felt, in order to absorb some of the softer radiation.

Fluorescent (fluoroscopic) Screen. A screen covered with fluorescent material, which permits the visual examination of the human body by means of X-rays.

Fuse (Safety). A soft metal wire interposed in a circuit, which will melt if a current too strong for safety passes through it.

Gap-Spark. The space between the terminals of two conductors.

Hard. Hard and soft are terms applied to X-ray and other vacuum tubes; they refer to the relative completeness of the exhaustion therein of the retained air or residual gas. A hard tube has a higher resistance than a low or soft tube.

Henry. An electrical unit of inductance equal to the inductance of a circuit when the electromotive force induced in it equals 1 volt when the exciting circuit varies at the rate of 1 ampere per second.

Hot-Wire Meter. A meter whose readings are based on the expansion of a wire, due to an increase of temperature, by the passage through it of the current that is to be measured.

Hysteresis. A term applied to residual effects in the rapid magnetisation and demagnetisation of a soft iron core lying within a coil of insulated wire, through which an interrupted constant current is flowing.

Induced Current. That secondary current produced by induction. It flows in the opposite direction to the primary or inducing current when the latter is made, but in the same direction when it is broken.

Induction Coil. An apparatus consisting of two associated coils of insulated wire employed for the production of currents by mutual induction.

Insulator. A non-conductor or a bad conductor, e.g. glass, rubber, shellac.

Intensifying Screen. A surface coated with some fluorescing material, such as tungstate of calcium, placed in contact with the film side of the X-ray plate; the time necessary for exposure is materially shortened.

Inverse Current. The current produced in the secondary of an induction coil on the making or completion of the circuit of the primary. Inverse currents flow in the opposite direction to the original current.

Joule. The amount of energy employed in maintaining a current of 1 ampere for 1 second against a resistance of 1 ohm—10,000,000 ergs.

Kilowatt. 1000 watts.

Micro-Farad. Practical unit of capacity.

Milliampere. $\frac{1}{1000}$ of an ampere.

Milliamperemeter. An instrument for recording the strength of a current passing in fractions of an ampere.

Ohm. Practical unit of electrical resistance. It was decided (Paris Congress, 1884)

that the legal ohm is the resistance offered by a column of mercury 106 cm. high, 1 square mm. in cross-section, having about the resistance of 100 metres of telegraph wire.

Ohm's Law. The strength of the current varies directly as the E.M.F. and inversely as the resistance of the circuit, or the current expressed in amperes is equal to the E.M.F. expressed in volts divided by the resistance expressed in ohms :

$$C = \frac{E}{R}$$

The law was enunciated by Dr. G. S. Ohm, and is used for showing the relation between Electromotive Force, Resistance, and Current.

Oscilloscope. A vacuum tube, constructed so as to show whether a current is unidirectional or oscillatory, and in the latter case roughly in which direction the greater quantity of current is flowing.

Parallel. Cells are said to be parallel when the positive elements are all connected to each other, and the negative are similarly connected. The E.M.F. is only equal to the E.M.F. of one cell, but its internal resistance is diminished in proportion to the number of cells thus joined. See *Series*.

Pole Tester. Any device for readily determining the polarity of the current, e.g. wet blue litmus paper will turn red in contact with the positive pole from a galvanic battery; the red spot will become blue again on the application of the negative pole; or when the end tips are placed in water and a galvanic current is turned on, bubbles of hydrogen will rise from the negative side, while the positive tip will become blackened.

Potential = *potentia*, power, ready to act, but not yet acting. It is the condition of electrical tension of a body. This term holds the same relation to electricity that the term level does to gravity; just as water at a higher level tends to move to a point of lower level, so does the accumulation of electric energy, at that point in the circuit at which it is present in excess over any other point in the circuit, tend to seek that point in the circuit at which it is lowest, so that electrical equilibrium may be restored.

Radium Definitions :

1 *Curie*, quantity of radium emanation (0.60 cubic millimetres at 0° C. and 760 mm. pressure) in equilibrium, with 1 gramme of radium element.

This quantity gives a saturation current in an ionisation chamber of indefinite dimensions, of 2.67 million electrostatic units (0.89 milliampere). One curie of emanation per litre would equal a concentration of 2670 million Maché units.

1 *Millicurie*, quantity of radium emanation in equilibrium with 1 milligramme (one-thousandth of a gramme) of radium element.

1 *Microcurie*, quantity of radium emanation in equilibrium with 1 microgramme (one-millionth of a gramme) of radium element. One microcurie per litre equals a concentration of about 2700 Maché units.

1 *Milligramme-minute*, quantity of radium emanation produced in 1 minute by 1 milligramme of pure anhydrous radium bromide. This quantity is 0.073 microcurie, and would give per litre a concentration of about 180 Maché units.

1 *Electrostatic unit* (E.S.U.), current measure 3.33×10^{-10} (0.000000000333) ampere.

1 *Maché unit* (M.U.), saturation ionisation current, due to radium emanation from a litre of solution of gas expressed in electrostatic units multiplied by 1000.

Ray, Röntgen or X. Rays emitted from the source of radiant energy excited by a discharge of electricity within a vacuum tube, not deviable by a magnet or refracting medium; they pass through opaque bodies, cause certain substances to fluoresce, affect a photographic plate like light rays, and they have peculiar effects upon living tissue, normal and pathological.

Rectifier. An apparatus which is used to transform an alternating current into what is practically a unidirectional current. There are several kinds of rectifiers, the simplest of which is the "aluminium cell."

Resistance. (a) That which opposes the current flow. (b) The ratio of E.M.F. to the current strength :

$$C = \frac{E}{R}$$

Rheostat. An instrument for regulating the resistance of an electric current.

Rotary Converter. A machine similar in design to an ordinary continuous current generator, but provided with slip rings, connected to suitable points in the armature winding.

Sabouraud's Pastilles. Pastilles of light-green colour, called by Sabouraud tint A, which turned to an orange colour, called by Sabouraud tint B, on being exposed to X-rays, thus measuring the dose.

Self-Induction. Induction produced in a circuit by the induction of a current on itself at the make or break of the current therein.

Series. Cells are said to be in series when the positive element of one cell is connected with the negative element of the next cell, and so on. The electromotive force of the

combination, measured from the positive pole of the first to the negative pole of the last, is thus increased, *e.g.* in a battery with three cells, each having an E.M.F. of 1.5, the total E.M.F. will be volt 4.5.

Supply, Unit of. Board of Trade unit.

Unit Megohm. 1,000,000 ohms.

Unit Micro-Farad. $\frac{1}{1000000}$ farad.

Unit Micro-Volt. $\frac{1}{1000000}$ volt.

Unit Milliampere. $\frac{1}{1000}$ ampere.

Vacuum Tube. Glass tubes or bulbs from which nearly all traces of gas have been removed.

Volt. The practical unit of E.M.F. An E.M.F. which would cause a current of 1 ampere to flow through a resistance of 1 ohm.

Voltmeter. An instrument for measuring difference of potential.

Watt. Is a volt-ampere, or unit of electrical force.

Zero Potential. The earth's potential.

INDEX

Numerals in clarendon indicate that there are illustrations on those pages. A full-page plate is indicated by the letter *P.* followed by the number of page at which it appears.

- Accumulators for portable outfit, 550
 Acne vulgaris, treatment by X-rays, 452
 Adamson's (Dr. H. G.) method of treatment for ringworm, 446
 description of, 448-450
 After-treatment, importance of, 394
 Age of patient a factor, 388
 Aikins, on exophthalmic goitre, 588
 on hyperthyroidism, 590
 Air-cooled tubes, 443
 Albers Schönberg (*see* Schönberg)
 Aluminium filters, 392
 American Army, portable X-ray apparatus, 550
 American Electrotherapeutic Association, 587
American Journal of Roentgenology, 581, 582, 589
 American Radium Society, Presidential Address by Aikins, 590
 Anæmia, pernicious, treatment by X-rays, 475
 Andrews tube, 442
 Apparatus (*see* X-ray apparatus)
Archives of Radiology and Electrotherapy, 388, 389, 584
 Arsenic and X-rays, in treatment of blood diseases, 477
 Axillæ, hyperidrosis in, treatment by X-rays, 454
- Baese, Signor, localiser, 421
 Barkla and others, work regarding secondary radiations, 392
 Batten's method of treatment for eczemata, 445
 Bauer qualimeter, 409
 for estimating hardness of rays, 426
 valve tube, 414
 Bazedow's disease (*see* Exophthalmic goitre)
 Beclere, on action of X-rays in blood diseases, 477
 Bequerel ray (radium), special action of, 397
 Bergonié and Tribondeau, on the action of radiations upon normal tissues, 388
 Beta rays (radium), thick filters to cut off, 513
 Biological reaction of tissues to radiations, 387, 388
 Bladder, cancer of, treatment with radium, 537
- Blood**, red corpuscles should be kept up to normal, 393
 cells, change in the percentage of, 391
 corpuscles, white, diminution in number of, 391
 counts, differential normal, 477
 should be made when treating leukæmia by X-rays, 475
 diseases of, action of X-rays upon, 477
 duration of treatment by X-rays, 475
 treatment by arsenic and X-rays, 477
 by X-rays, 474
 Blood stream, its effect upon radiation treatment, 393
 Bordier chromo-radiometer, 427, 471
 method of estimating dosage, 425
 on treatment of uterine fibromata by X-rays, 469
 technique for treatment of uterine fibroids by X-rays, 471
Boston Medical and Surgical Journal, 583, 589
 Bowel, lower, radium tubes in, 536
 Bradshaw Lecture, 583
Breast, cancer of, Freiburg treatment, 543
 treatment by X-rays, 464, *P.* 464, *P.* 465
 diseases of, radium treatment, 533
British Medical Journal, 588
 Bruce director couch, 550
 Brush high-frequency discharges, 394
 (*see also* High-frequency treatment)
 Bumm (Professor), on depth at which radiations affect tissues, 540
 on treatment of carcinoma mammæ, 542
 Burrows (Dr. A.), trocar and cannula for insertion of radium emanation tubes, 507
- Cabinet, apparatus arranged on a, 422
 Cancer cells and Gamma rays, 541
 action of radium upon, 398
Cancer, mediastinal, value of X-ray treatment, 543
 effect of hard rays of radium upon, 393
 en cuirasse, 532
 large inoperable, treatment by radiations, 464
 of the bladder, radium treatment, 537
 Freiburg technique, 542
 of the breast, radium treatment, 532

- Cancer** of the breast, treated by X-rays, *P.* 464, *P.* 465
 of the cervix uteri, radium treatment, 524
 exposure for, 525
 of the mouth, radium treatment, 534
 of the œsophagus, radium treatment, 534
 of the prostate gland, radium treatment, 537
 of the rectum, radium treatment, 536, 542
 of the tongue, radium treatment, 534
 recurrent, 465
 radium treatment, 532
 scirrhous, 388
 (*see also* Carcinoma)
- Carbonic acid snow, for *Verrucæ vulgaris*, 452
- Carcinoma, inoperable, treatment by X-rays, 464
 of the breast, 390
 beneficial effects of radiations, 391
 of the mamma, combined use of radium and X-rays in treatment, 542
 Professor Bumm's experience, 542
 recurrences after operation, 543
 of the uterus, treatment by X-rays and radium, 542
 recurrent (after removal of breast), treated by X-rays, *P.* 532
 squamous-celled, 400
- Carcinomata, 388
 in young patients, recurrences after operation, 463
 post-operative treatment by X-rays, 461
 results of prophylactic treatment, 463
 Russ' experiments with radium rays, 462
 treated by X-rays, *P.* 464
 treatment by radium, 531
 by X-rays, 460-465
 X-ray treatment before operation, 461
 at the time of operation, 461
- Carcinomatous glands (*see* Glands)
- Case, J. T., on exophthalmic goitre, 584
- Cell metabolism, quality of radiations likely to influence, 402
- Cells, radium action upon, 398
- Cervix, chronic inflammatory conditions of, treatment by radium, 523
 uteri, cancer of, radium treatment, 524
 radium tubes in, 507
- Chair for X-ray treatment, 422
- Chart showing record of X-ray exposures by Kienböck method, 432
- Cheloid**, treatment by X-rays, 452
 by radium, 521
 condition of scars, radium treatment, 553, 559, 562-572
 scars treated by radiations, 563, *P.* 566, *P.* 567, 568
- Childs, on exophthalmic goitre, 584
- Chromo-radiometer (*see* Radiometer)
- Climacteric troubles, technique for treatment by X-rays, 470
- Coils (*see* Induction coil)
- Cole (Percival P.), operations on cheloid conditions, 559-561
- Cole (Percival P.), special points in the technique employed in the treatment of cases dealt with by, 573
 the value of radiations in plastic surgery of the face and jaws, 562-572
- Colloidal preparations used in conjunction with radiations, 403
- Colorado State Med. Soc., 585
- Colwell and Russ, on action of radiations upon normal tissues, 388
 on the selective absorption of radiations by the tissues, 398
- Compressor, should be employed in treatment of enlargement of the prostate gland, 466
 for uterine myomata, 470
- Connections for X-ray tube, coil and valve tube, 417
- Cook, on enlargement of the thymus gland, 589
- Coolidge tube (*see* X-ray tubes)
- Corbett (Dr. Dudley), adaptation of Lovibond's tintometer, 433
- Cossar tube, 442
- Cottenot, on exophthalmic goitre, 587
- Couch, a treatment, should be comfortable, 422
- Couches should be efficiently protected, 404
- Cox's chromo-radiometer, 436
- Cubicle system for protection of operator, 552
- Curie (Professor and Madame), unit of measurement for radium, 494
- Current**, reverse (inverse), may cause errors in dosage, 424
 method of checking, 413
 should be practically absent if modern coils are used, 424
- Cyclop tube for therapeutic work, 443
- Dangers attendant on the use of X-rays and radium, 403
- D'Arsonval milliamperemeter, 408
- Deafness, radium treatment, 517
- Depilating power of radiations, 569
- Depilation** by radiations to permit inversion of skin in plastic surgery, 568, 570
 dose, 435
 for ringworm, 446, 448
 details of Dr. Adamson's method, 448-450
 of hair-bearing flap, *P.* 570, *P.* 571
- Dermatitis caused by radiations, 403
- Diathermy, 394
- Diseases**, deep-seated, treatment with help of rotating tube stand, 418, 421
 general, met with in military practice, 575
 met with in military practice, 546-591
 of the blood (*see* Blood)
 of the skin, treatment of, 444-454
- Dominici, early work in radium therapy, 387
- Dosage**, comparison of various units of measurement, 471
 depilation dose, 435
 effect of presence of reverse current upon, 424
 errors arising from unusual thickness of glass in tube, 425
 importance of estimation of, 553

- Dosage**, in radium therapy, 511
 unit of milligram-hours, 514
 methods of measuring, 425
 methods used in estimation of, 423
 modifying effect of blood stream upon, 393
 must not be pressed too rapidly, 393
 strict attention to detail necessary, and careful watching of all the conditions, 426
 the direct method of estimating, 424
 the indirect method of estimating, 425
- Dose**, an erythema, 424
- Ear**, diseases of, radium treatment, 516
- Eczema**, treatment by radium, 520
- Eczemata** treated by X-rays, 445
- Edinburgh Medical Journal*, 590
- Edinburgh Royal Infirmary**, treatment of hyperthyroidism, 590
- Edouel**, on action of X-rays in blood diseases, 477
- Ehrlich**, diagnosis of myelogenous leukæmia, 476
- Electroscope**, experiments conducted with, 541
 special gold leaf, for radium, 484
 friction device for charging, 494
- Endometritis**, chronic, treatment with radium, 523
- Endothelioma**, treatment by X-rays, 479
- Enlarged glands**, carcinomatous and sarcomatous (*see* Glands)
- Epithelioma**, infiltrating, radium treatment, 530
 of the tonsil, 390
 treatment by X-rays, 451, 459
 Kempster's experience, 462
 superficial, prophylactic treatment, 526
 technique for radium treatment, 528, 529
 treatment by radium, 528-530
 results of, 527
- Erythema** dose, 424
- Erythematous flushing** in exophthalmic goitre, 578
- Eshner**, cases of exophthalmic goitre tabulated by, 577
- Exophthalmic goitre**, aggravated by administration of thyroid extract, 577
 etiology of, 577
 literature of the subject, 582-591
 met with in military practice, 576-588
 treatment by radium, 468, 517
 by X-rays, 467
 by X-rays and radium, 577, 579
 should be supplemented by rational hygiene, proper feeding, and fresh air, 581
- Exophthalmic goitre**, hyperthyroidism, and soldier's heart, 579
- Exophthalmos**, 578
 Graefe's sign, 578
 Stelling's sign, 578
- Eye**, diseases of, radium treatment, 516
- Eyelid**, application of radium to, 516
- Fibroma uteri**, hæmorrhage in, 469
 indications against treatment by X-rays, 470
 indications for treatment, 469
- Fibromata**, treatment with radium, 525
- Fibromyoma uteri**, treatment by X-rays, 404
- Fibromyomata**, treatment by radium and X-rays, 539
- Filter** equivalents, 439
- Filters**, additional, 439
 aluminium, 392
 complete set should be provided with each tube stand, 417
 for radium tubes, importance of, 508
 position of, 438
 selection of, 439
 value of, 387
 various, 398, 468
- Filtration**, Bordier's formula, 472
 experiments with, in treatment of epitheliomata, 462
 of radium rays, 507
 importance of air space, 508
- Finsen** light, for Lupus vulgaris, 451
- Finzi**, contribution to radium therapy, 387
 experiments with radium on hyperthyroidism, 590
 on late manifestations, 404
- Fischer**, on exophthalmic goitre, 582
- Fissures**, treated by X-rays, 462
- Fistula**, parotid, healed by operation aided by radiations, 572
 salivary, treated by radiations, 565
- Fluorescent screen** must be efficiently protected, 404
- Folliculitis barbæ**, treatment by X-rays, 450
- Freiburg technique**, 418, 439
 for treatment of cancer of the breast, 543
 of the uterus, 542
 for X-ray treatment of fibroma uteri, 470
 of uterine fibroids, 472
 arrangement of the tube and filters, 474
 diagram to illustrate ports of entry, 473
- French** (Herbert), on hyperthyroidism, 591
- Gaarenstroom**, on sarcoma and Röntgen rays, 389
- Gamma rays** and cancer cells, 541
 depth reached by, 540
 early work with, 387
 when used alone, 513
- Gauss** (*see* Freiburg technique for uterine fibroids)
- Gland**, prostate, cancer in, radium treatment, 537
 thymus, enlargement of, 589
 thyroid, malignant disease of, treated by radium, 518
- Glands**, carcinomatous, 388, 389
 enlarged, due to a mixed infection, 389
 carcinomatous, treated by X-rays, 456
 surgical removal after improvement under X-ray treatment, 456
 inflammatory, 388

- Glands, enlarged lymphatic, response to radiations, 388, 389
 treatment by X-rays, 454
 sarcomatous, treatment by X-rays, 455
 inflammatory, treatment by X-rays, 454
 lymphadenomatous, 388
 treatment by X-rays, 455
 malignant, 388
 prostate, enlargement of, treatment by X-rays, 465
 success of operative treatment, 465
 technique of X-ray treatment, 466
 sarcomatous, 388
 simple inflammatory, 388
 tuberculous, 388
 treatment by X-rays, 454
 Goitre (*see* Exophthalmic goitre)
 Graefe, on exophthalmic goitre, 578
 Graves' disease (*see* Exophthalmic goitre)
 Greenfield, view of exophthalmic goitre, 577
 Grier, on hyperthyroidism and exophthalmic goitre, 582
 Gynæcological practice, radium treatment, 523
- Hæmorrhage in fibroma uteri, 469
 Hæmisch, technique for treatment of uterine fibroids by X-rays, 471
 Hair, superfluous (*see* Hypertrichosis)
 Halstead, on exophthalmic goitre, 584
Hampson's method of estimating dosage, treatment for eczematata, 445
 radiometer, 425, 431, 436, 437, 445
 Hand, ulcer of, treated by X-rays, 453
 Haret, on radium ionisation, 499
 Hernaman-Johnson, application of metals to produce secondary radiations, 392
 on exophthalmic goitre, 586, 588
 High-frequency treatment, 554
 Hodgkin's disease, treatment by X-rays, 475
 Holz knecht method of estimating dosage, 425
 quantimeter, 427
 Horsley, experiments with radium on hyperthyroidism, 590
 Humerus, sarcoma of, treated by X-rays, 460
 Hyperidrosis, caused by radiations, 404
 in the axillæ, treatment by X-rays, 454
 treatment by X-rays, 453
 Hyperthyroidism, 556, 577, 579
 associated with enlargement of the thymus gland, 589
 Hypertrichosis, treatment by X-rays, 450
- Induction coil** and transformer, comparison of results obtained, 411
 being displaced by transformers, 411
 old, or badly constructed, will give rise to reverse current, 424
 therapeutic, 410
 Infection, mixed, 389
 Inflammatory conditions of the corvix, treatment with radium, 523
 glands (*see* Glands)
- Injuries met with in military practice, 546-574
 Interrupter, dipping, 413
 mercury, 411, 412
 Rhythmeur, 416
 Ionto quantimeter, 433
 experiments conducted with, 541
- Johns Hopkins Hosp. Bull.*, 584
- Kempster, treatment of epitheliomata by radiations, 462
Kienbock method of estimating dosage, 425, 428
 chart showing record of X-ray exposures, 432
 quantimeter, 427, 428
 arrangements for exposure, 428
 development of strips, 429, 430, 431
 the standard scale, 430
 strip in tissues, estimate of depth of penetration of rays, 541
 technique for ringworm, 446
 King's College Hospital, filter and screen for radium in use at, 492
 Krauss, on action of X-rays in blood diseases, 477
 Kroymeyer mercury vapour lamp, 558
- Lancet*, 587, 588
 Lange, on enlargement of the thymus gland, 589
 Law of Bergonié and Tribondeau, 388
 Lembcke (*see* Freiburg treatment of uterine fibroids)
 Leucocytes (*see* Blood, diseases of)
 Leucoplakia, met with in military practice, 558
 treatment by X-rays, 446
 by radium, 522
 vulvæ, treatment with radium, 524
 Leukæmia, 391
 in military practice, 556
 lymphatic, treatment by X-rays, 476
 myelogenous (*see* Spleno medullary)
 spleno-medullary, treatment by X-rays, 476
 treatment by X-rays, 476
 blood counts should be taken, 475
 Lichen met with in military practice, 558
 treatment by X-rays, 446
 Lotions, soothing, may be used subsequent to X-ray treatment, 444
 Lovibond's radiometer, 425, 431
 tintometer, 433, 434
 Lungs and mediastinum, diseases of, treatment by X-rays, 478-480
 Lupus erythematosus, treatment by radium, 521
 by X-rays, 451
 vulgaris, treatment by Finsen light, 451
 by radium, 521
 by X-rays, 451
 Lymphadenoma, treatment by X-rays, 479
 Lymphadenomatous glands (*see* Glands)

- Macalaster-Wiggin tube, 441, 442
- Maché (Professor) unit of measurement for radium, 495
- Mackenzie (Hector), on exophthalmic goitre, 578, 583
- Malignant disease**, accumulation of experience in the treatment by radiations, 544
- combined use of radium and X-rays in treatment of, 538
 - consideration of choice of treatment, 545
 - general treatment of, 394
 - in military practice, 556
 - no case should be refused radiation treatment, 540
 - other methods of treatment must not be neglected, 545
 - post-operative treatment should be insisted upon, 545
 - prophylactic treatment, 539
 - growths, treatment must be general as well as local, 394
 - invasions of the skin, treatment by X-rays, 453
- Manchester and District Radium Institute, Report on treatment of exophthalmic goitre, 590
- Mannaborg, on exophthalmic goitre, 584
- Massachusetts General Hospital, treatment of exophthalmic goitre, 584
- Mediastinal cancer (*see* Cancer)
- glands, enlargement of, treatment by X-rays, 478
 - a careful record of all exposures should be kept, 479
 - tonics and a generous diet should accompany treatment, 479
- Mediastinum, diseases of, treatment by X-rays, 478-480
- Medical Annual*, 588, 591
- Record*, 585
- Megaloblasts, action of X-rays upon, 477
- Melchens, on action of X-rays in blood diseases, 477
- Menopause, may be temporarily induced by X-rays, 469
- Menorrhagia, treatment by X-rays, 469
- Mercury interrupter, 411, 412
- vapour lamp, 394
 - for ultra-violet radiations, 558
- Mesothorium and radium in treatment of cancer of the cervix uteri, 524
- in treatment of malignant disease, 541
- Metabolic balance, disturbance of, 394
- Metabolism (*see* Cell metabolism and Tissue metabolism)
- Metals, secondary radiations from, 392
- Military hospitals**, equipment of radio-therapeutic department, 547-554
- Military practice, description of types of cases met with and special points in technique, 556
- general diseases met with in, 575
 - X-rays and radium in the treatment of injuries and diseases met with, 546-591
- Miller (Leslie), mica disc valve for eliminating reverse current, 413
- Milliamperometer, 408
- Moebius, view of exophthalmic goitre, 577
- Morton (Dr. R.), method of checking reverse current, 413
- rectifier, 413, 414
 - diagram of connections for, 415
 - value of, for therapeutic work, 414
- Mouth, cancer in, radium treatment, 534
- radium applicator for, 506, 533
 - radium tube arranged for treatment of, 533
- Muench. med. Woch.*, 588
- Müller, diagnosis of myelæmia, 476
- X-ray tube (*see* X-ray tubes)
- Myelæmia (*see* Leukæmia, spleno-medullary)
- Myelocytes, in blood diseases, 477
- Myoma uteri, treatment of, by Freiburg technique, 430
- (*see also* Uterine myomata)
- Myxædema, 576
- Nævus, treatment with radium, 520, 521
- Neuritis, caused by radiations, 404
- New York Med. Journ.*, 588
- Normoblasts, action of X-rays upon, 477
- Nose, diseases of, radium treatment, 517
- Edema, 578
- Esophageal tube, radium tube in, 534
- tubes containing radium, 505
- Esophagus, cancer of, radium treatment, 534
- tumour of, radium tube *in situ* for treatment, 535
- Ointments, antiseptic, in treatment of ring-worm, 447, 450
- may be used subsequent to X-ray treatment, 444
- Operator, protection of, 406, 407, 552
- Osler, on exophthalmic goitre, 588
- Osler's *System of Medicine*, 578
- Over-exposure, dangers of, 404
- Oxygen and radium emanation, apparatus for inhalation, 499
- Panton, on action of X-rays in blood diseases, 477
- Papillomata, superficial (warts), treatment by radium, 521
- Parenchymatous goitre, treatment by X-rays and vibratory massage, 587
- Parotid fistula healed by operation aided by radiations, 572
- Parry (Caleb H.), description of cases of exophthalmic goitre, 576
- Parry's disease (*see* Exophthalmic goitre)
- Pastille (*see* Sabouraud and Noiré pastille)
- Patient, age of, a factor to be considered, 388
- protection from radiations beyond those intended for therapeutic effect, 405
- Patients, occasional unpleasant first effects of therapeutic treatment upon, 423

- Pelvic organs, malignant disease of, treated by radium and X-rays, 539
- Penetrans tube, 441, 442
- Pfahler (of Philadelphia) on exophthalmic goitre, 583
on the value of thyroid extract in radiation treatment, 545
- Pirie (Dr. Howard), treatment of hyperidrosis by X-rays, 453
- Plastic surgery, nutrition of soft parts improved by radiations, 566
value of radiations in, 562
- Portable outfit, for use in wards, 548, 549
(see also Radio-therapeutic department)
- Practitioner, 586
- Principles and Practice of Medicine* (Osler), 588
- Proc. Chicago Medical Society*, 584
- Proceedings of the Royal Society of Medicine*, 441
- Prostate gland (see Glands)
- Protection of operator, methods of, 406, 407, 552
of the patient, 408
- Protective screen and arrangement of control apparatus, 552
in position, 553
- Prurigo in military practice, 558
treatment by X-rays, 445
- Pruritis, treatment with radium, 522
ani, in military practice, 558
- Psoriasis, treatment by radium, 520
by X-rays, 445
- Qualimeter, 409, 433
for measuring hardness of rays, 426
- Quantimeter, for measuring dosage, 427
- Radiation, depth of body penetrated by, 541
of cheloid scars and conditions of skin, 564-572
of soft parts preparatory to the insertion of a bone graft, 564, 568
treatment, superficial reaction occurring in course of, 394
treatment for exophthalmic goitre, 579
- Radiations, action upon blood-vessels, 397
upon normal tissues and morbid growths, 394
the skin, hair, nerve tissue, sweat glands, and muscle fibres, 396
tumour cells, 398
vascular connective tissue, 397
assisted by Salvarsan or colloidal preparations, 403
- Barkla and Sadler's work regarding secondary, 392
beneficial effects of, 391
changes observed in tumours treated by, P. 397, P. 400, P. 401
constitutional disturbance caused by, 402
degree of action induced is dependent upon method of application, 398
depilating powers of, 569
- Radiations, effect upon the blood and thus upon distant parts, 393
normal tissues, P. 396
selective absorption by the tissues, 398
special action of Becquerel ray, 397
points in the technique employed in the cases treated by Mr. Cole, 573
toxæmia caused by, 402
value of, in plastic surgery, 562
- Radiodermatitis, risk of, 542
- Radiogene for obtaining radium emanation, 515
- Radiographic and radio-therapeutic department, ground plan of, 555
- Radiometer**, Bordier's chromo-, 427, 472
chromo- (Cox's), 436
Hampson's, 425, 436, 437, 585
exposure time reduced by half, 437
Holzknecht's chromo-, 431
Lovibond's, 425
(see also Tintometer)
- Radio-therapeutic department, consideration of necessary apparatus, 552
current supply, 550
equipment of, 547
portable outfit, 548-551
at bedside, 551
thoroughly efficient equipment necessary, 550
- Radium**, activity of a preparation of, 511
a good method of utilising a limited quantity of, 502
apparatus for charging glass applicators, 486
obtaining radium emanation, 485
preparation of water impregnated with radium, 490
application to eyelid, 516
applicator, circular, 504
concave circular, 504
flat, 503
flat metal, 508
for diseases of the skin, 519
for mouth, 506
applicators, various forms of, 492
beneficial action upon sarcoma, 456
Beta and Gamma rays, 287
effect upon cancer, 393
chief points which influence the choice of, 497
comparison of values, in different forms, 504
curve showing decay of radium emanation, 487
dangers attendant on use of, 403
later manifestations, 404
effect of Alpha and Beta rays, 402
electroscope, special form of gold leaf, 484
emanation, 485
applicators, 499, 500
dosage of, 512
when using flat applicators, 513
maché unit, 513
rate of decay of, 503

- Radium emanation**, Dr. Stevenson's (Dublin)
 method of using, 503
 tubes, trocar and cannula for insertion of, 507
 various forms of application, 498
 equipment for military hospital, 553
 forms of application, 504
 free, dosage when in metal tubes, 513
 friction device for charging electroscopes, 494
- Gamma rays** used alone, 513, 514
 effect upon the skin negligible, 514
 illustration showing method of arranging tubes with filters, 508
 importance of using filters, 508
 in cancer of the bladder, 536
 of the œsophagus, 534
 of the prostate gland, 536
 of the rectum, 536
 of the tongue and mouth, 534
 in carcinomata, 531
 in diseases of the ear, nose, and throat, 517
 of the eye, 516
 in general disease, 514
 in gynœcological practice, 523
 in infiltrating epithelioma, 530
 in sarcomata, 531
 Institute, employment of emanation at, 503
 ionisation and recombination, 483
 measurement, 493
 methods of using, 497
 physical properties of, 402
 physiological action, 495
 practical application to disease, 497-537
 rays, filtration of, 508
 influence of air-space in filtration of, 509
 relation between the value of and its activity, 511
 salts, 500
 age of, 512
 applicators for, 501
 variation of activity, 512
 silver filter containing two tubes, 508
 standard of activity, 511
 technique employed in treatment of tumours, 402
 therapy, dosage in, 511
 early work of Wickham and Dominici, 387
 in general disease, hospital treatment recommended, 515
 treatment of carcinomata, Russ' experiments with, 462
 of deep-seated tumours by external applications, 510
 of diseases of the skin, 519
 exposures for, 519
 of exophthalmic goitre, 517
 of hyperthyroidism, 590
 of malignant disease of the thyroid gland, 518
 of rodent ulcer, 526
 of superficial epithelioma, 526
- Radium treatment of tumours**, 401
 factors influencing the result, 401
 large quantities may be used, 402
 prophylactic, 526
 with large quantities, cautions to be observed, 510
- Radium tube**, a fine, 503
 arranged for treatment of the floor of the mouth, 533
 arranged on a length of pliable silver wire, 534
 at extremity of uterine sound, 524
 contained in rubber tubing, 508
 flat metal, showing area of active surface, 508
 in an œsophageal tube, 534
 in position for treatment of tumour of the œsophagus, 535
 œsophageal, 505
 secondary radiations from, 508
- Radium tubes arranged in groups for treatment of extensive areas**, 505
 for treatment of rectal conditions, 506
 in lower bowel, diagram to illustrate method, 536
 in the substance of a tumour, 509
 introduced into growths, 390, 537
 with free salts of radium, 501
 unit of measurement, 494
 of milligram hours, 514
 of radiation, 511
 values for the weight of radium element in salts, 491
 various forms of applicators, 492
- Radium and mesothorium** in treatment of cancer of the cervix uteri, 524
 in treatment of malignant disease, 541
and X-rays combined in the treatment of injuries and diseases met with in military practice, 546-591
 combined use in the treatment of malignant disease, 538
 treatment of tumours by combined rays, 402
- Radium emanation and oxygen**, apparatus for inhalation, 499
- Rectal conditions**, radium tubes for treatment of, 506
- Rectifier**, the Morton, 413, 414, 415
 (*see also* Morton rectifier)
- Rectum**, cancer of, radium treatment, 536
 treated with X-rays and radium, 542
- Regulator**, ill-effects on valve-tubes from too frequent use, 415
- Rest during treatment**, importance of, 394
- Rhythmeur interrupter**, 416
- Ringworm**, Dr. Adamson's method, 446, 448-450
 antiseptic ointment for, 447
 consideration of previous treatment before using X-rays, 447
 diagrams illustrating Dr. Adamson's method, 449
 dipping interrupter used for treatment of, 413

- Ringworm**, in subjects who are very susceptible to X-rays, 447
 Kienböck technique, 446
 of the scalp, in military practice, 558
 treatment by X-rays, 446
 tripod attachment for circular diaphragm, 417
 X-ray tube for, 441
- Rodent ulcer (*see* Ulcer)
- Röntgen rays and sarcoma, 389
- Rotating tube, projection of rays into deep parts, 466
 stand (*see* X-ray tube stands)
- Royal College of Physicians, 583
- Royal Society of Medicine, 588
- Russ, experiments with radium rays on carcinomata, 462
- Sabouraud and Noiré pastilles**, curve showing colour developed by, 435
 dosage measured by, 425, 581
 examining, 426
 instructions how to use, 425
 ionto quantimeter used with, 433
 Lovibond's tintometer used with, 433
 tint B compared with other methods, 431
- Sadler and others, work regarding secondary radiations, 392
- Salivary fistula treated by radiations, 565
- Salvian, effect upon radiation treatment, 478
 used in conjunction with X-rays, 392, 393, 403
- Sarcoma, beneficial action of radium upon, 456
 of the humerus, treatment by X-rays, 460
 recurrent, treated by radium, 532
- Sarcomata, 388
 radium treatment, 531
 treated by X-rays, 460, 478
- Scars, cheloid, treated by radiations, 563
 post-operative, suppleness restored by radiations, 564
- Schönberg, Albers, technique for X-ray treatment, 470
- Schutzinger, on exophthalmic goitre, 588
- Scleroderma, 578
- Screening stands, should be efficiently protected, 404
- Screens, lead lined, for protection of operator, 405, 407, 552, 553
- Secondary radiations from metals, 392
- Seeuwen, on exophthalmic goitre, 587
- Septic wounds (*see* Wounds)
- Seymour (Malcolm), on exophthalmic goitre, 584
- Simpson, on exophthalmic goitre, 585
- Sinuses, chronic, treatment by X-rays and ultra-violet radiations, 558
- Skin**, adequate protection necessary, 398
 cheloid conditions of, treated by radiations, 559
 chronic syphilitic lesions of, treatment by X-rays, 452
 diseases of, conditions which are peculiarly responsive to radium, 519
 exposure for, 519
- Skin**, diseases of, treated by radium, 519
 X-ray treatment, 444, 454
 malignant invasions of, treatment by X-rays, 453
 surface, avoidance of injury to, 542
- Snook apparatus, small, for portable X-ray outfit, 550
 transformer, 411
- Snow, on exophthalmic goitre, 587
- Soldier's heart, 556, 579
- Speder, on late manifestations, 404
- Spieen, enlargement of, X-ray treatment, 558
 size of, in diseases of the blood, 477, 478
- Stelling, on exophthalmic goitre, 578
- Sterility caused by radiations, 403, 405
- Stevenson (Dr., of Dublin), method of using radium emanation, 503
- Stoney (Dr. Florence), on exophthalmic goitre, 587
 on X-ray treatment of exophthalmic goitre, 468
- Sycosis menti, combined treatment, 556
 vaccines have a beneficial effect upon, 557
- Syphilitic lesions of the skin, chronic, treated by X-rays, 452
- Szillard (Dr.), the ionto quantimeter, 433, 541
- Tachycardia, 578
- Tachymeter, 413
- Telangiectasis, after treatment of exophthalmic goitre by X-rays, 468
 caused by radiations, 404
 occurrences after treatment of hyperidrosis by X-rays, 454
- Therapeutic coil**, 410
 treatment, unpleasant immediate effects upon patients, 423
 work, slow interruptions most efficacious for, 414
 tube stand for, 417, 418
- Throat, diseases of, radium treatment, 517
- Thyrus gland (*see* Glands)
- Thyroid**, enlargement of, 578
 extract, effect upon exophthalmic goitre, 577
 effect upon tissue metabolism, 545
 symptoms produced by, 577
 gland, enlargement of, 556
 inoperable cases may be rendered operable, 518
 malignant disease of, radium treatment, 518
- Tidy, on action of X-rays in blood diseases, 477
- Tinea larbæ, a case treated with ultra-violet radiations and a vaccine, 557
 combined treatment for, 556
 vaccines have a beneficial effect upon, 557
- Tintometer, Lovibond's, 433, 434
 advantages of, 434
- Tissue metabolism**, effect of thyroid extract upon, 545
 stimulating effect of radiations upon, 393, 395

- Tissues, biological reaction to radiations, 387
 changes produced by radiations, *P.* 396
 normal, action of radiations upon, 395, 396, 401
- Tongue, cancer of, radium treatment, 534
- Tonsil, epithelioma of, 390
- Transformer and coil outfit, comparison of results obtained, 411
 high-tension, displacing the induction coil, 411
 the Snook, 411
- Treatment chair, 422
 couches should be comfortable, 422
- Tremor (in exophthalmic goitre), 578
- Trichophytia (*see* Ringworm)
- Tube stands (*see* X-ray tube stands)
- Tuberculosis, subacute or chronic, treatment by X-rays, 479
- Tuberculous glands (*see* Glands)
- Tumour** cells, action of radiations upon, 398
 treatment by radium, factors influencing the result, 401
 deep-seated, treatment by external applications of radium, 510
 inoperable, treatment by radium, 533
 of the œsophagus, radium tube *in situ* for treatment of, 535
 radium tubes in the substance of, 509
- Tumours, treated by radiations, changes observed in *P.* 397, *P.* 400, *P.* 401
 treatment by combined radium and X-rays, 402
- Turner (Dawson), dosage in radium therapy, 514
 on hyperthyroidism, 590
- Ugeskrift for Læger*, 582
- Ulcer of the hand, treated by X-rays, 453
- Ulcer**, rodent, 556
 technique for radium treatment, 528, 529
 treated by radium, *P.* 457, *P.* 529
 by radium, X-rays, and CO₂, *P.* 456
 and X-rays, *P.* 528
 treatment with radium, 526
 results from, 527
- Ulcerated carcinoma of the breast, 391
 growths, treatment by X-rays, 464
- Ulcers, chronic, treated by X-rays, 452
 rodent, treated by radium, *P.* 457
 by radium, X-rays, and CO₂, *P.* 456
 by X-rays, 457-459
 and surgical measures, 459
 simple, treated by X-rays, 452
- Ultra-violet radiation and X-ray treatment, 551
 for equipment of military hospital, 553
- Ultra-violet radiations, value of, in diseases met with in military practice, 547
 and X-rays in treatment of chronic sinuses and septic wounds, 558
- Uterine fibroids**, Bordier's technique for treatment by X-rays, 471
 Freiburg technique for treatment by X-rays, 472
- Uterine fibroids**, Haenisch technique for treatment by X-rays, 471
 fibromata, treatment by X-rays, 469
 (*see also* Fibroma uteri)
 myomata, technique for treatment by X-rays, 460, 470
 sound, with radium tube at extremity, 524
- Uterus, cancer of, treated by X-rays and radium, 542
 carcinoma of, treatment by X-rays, 460
 radium tubes for, 506, 507
- Vaccines, beneficial effect upon tinea barbæ, 557
- Valve tubes**, 408
 Bauer, 414
 caution against too frequent use of regulator, 415
 disturbing influence of large and small currents, 415
 should be provided in all installations where a coil is used, 423
 the use of, 416
 triple, 415
- Vascular connective tissue, action of radium upon, 397
- Ventilation of X-ray treatment cubicle, 407
- Verrucæ vulgaris, treatment by X-rays, 452
- Warts (*see* Verrucæ vulgaris and Papillomata)
- Water-cooled Müller tube, 472
 -cooling of X-ray tubes, 440, 443
- Weil, on hyperthyroidism, 590
- Wernekros (Professor), on depth at which radiations affect tissues, 540
- Wheeler, on exophthalmic goitre, 588
- White, on exophthalmic goitre, 588
- Wickham, work of, in radium therapy, 387
 and Degrais, experience with radium in inflammatory conditions, 397
- Wilson, on exophthalmic goitre, 588
- Wolff, on action of X-rays in blood diseases, 477
- Wounds, healing stimulated by X-rays, 561
 septic, treated by combined X-rays and ultra-violet radiations, 558
- X-ray apparatus**, arranged on a cabinet, 422
 arranged for therapeutic work, with protective screen, 553
 arrangement of, 408, 416, 421
 when using Kienböck quantimeter, 428
 further points in arrangement of, 422
 testing before use, 423
- X-ray couch**, Bruce director, 550
 exposures, record of, 432
 portable outfit, 548-551
 at bedside, 551
 high-tension transformer for, 550
 suitable for all kinds of radiographic and therapeutic work, 550
 protective screen and arrangement of control apparatus, 552
 in position, 553

- X-Ray therapeutics, 406-480**
 methods of protection, 406
 special points in instrumentation, 406
 tube, choice of, 440
treatment, after-effects must be looked
 for when using large doses, 473
 cubicle, 407
 for ringworm, 446-450
 (*see also* Ringworm)
 of diseases of the lungs and mediastinum,
 478
 previous treatment must be taken into
 account, 444
 use of soothing lotions and ointments,
 444
- tubes, Andrews, 442**
 appearance of, in action, 443
 Coolidge, 406
 advantages of, in therapeutic work,
 440
 for therapeutic work, complete pro-
 tection required, 442
 for treatment of exophthalmic goitre,
 580, 582
 for treatment of ringworm, 448 (foot-
 note)
 heavy discharge required when hard
 rays are used, 411
 radiations from, 407
 with portable outfit, 550
- Cossar, 442
 Cyclop, 443
 diagram to illustrate method of water-
 cooling, 440
 effect of unusually thick glass upon
 dosage, 425
 for superficial work, 441
 instruments for measuring the hardness
 of, 409, 410
 large tubes, advantages of, 442
 required for deep therapeutic work, 441
 Macalaster Wiggin, 441, 442
 method of connecting, 417
 methods of cooling, 443
 Müller water-cooled, 472
 Penetrans, 441, 442
 re-exhausting, 443
 rotating, experiments with, in relation
 to protection of skin surface, 542
- X-ray tubes, rotating, for treatment of the**
 prostate gland, 466, 467
 should be completely enclosed, 740
 should be gradually seasoned, 443
 used in therapy should be under com-
 plete control, 416
- X-ray tube stands, 417**
 complete set of filters required, 417
 for deep therapeutic work, 417, 418
 Gaiffe, 417
 rotating, 418, 419
 advantages of, 430
 for deep-seated diseases, 418
 principle of, 419
 tripod attachment for treatment of ring-
 worm, 417
- X-rays, action upon blood diseases, 477**
 advantages of use of, 390
 dangers attendant on use of, 403
 late manifestations, 403
 effect upon pastilles, 425, 426
 employment of hardest, 390
 measuring the quantity of, 431
 technique employed in military practice,
 556
 used to depilate hairy flap to permit of
 inversion of skin in plastic surgery,
 568, 570
 used to stimulate healing of wounds, 561
- X-rays and arsenic, treatment of blood
 diseases, 477
- X-rays and radium, combined use in treat-
 ment of malignant disease, 538
 in the treatment of injuries and diseases
 met with in military practice, 546-591
 treatment of tumours by combined rays,
 402
 and Salvarsan used in conjunction, 392
 and ultra-violet radiation treatment,
 551
 in treatment of chronic sinuses and
 septic wounds, 558
 and vibratory massage, in treatment of
 exophthalmic goitre, 587
- Zeigler, upon the action of X-rays in blood
 diseases, 477
- Zimmern, on exophthalmic goitre, 587
 Zulich, on exophthalmic goitre, 583

THE END

