



3 1761 04905227 7

Digitized by the Internet Archive
in 2008 with funding from
Microsoft Corporation

A CLINICAL TEXT-BOOK

OF

MEDICAL DIAGNOSIS

FOR

PHYSICIANS AND STUDENTS

BASED ON THE MOST RECENT METHODS OF EXAMINATION.

BY

DR. VIERORDT, M.D.,

PROFESSOR OF MEDICINE AT THE UNIVERSITY OF HEIDELBERG,
FORMERLY PRIVAT-DOCENT AT THE UNIVERSITY OF LEIPZIG; LATER, PROFESSOR OF MEDICINE
AND DIRECTOR OF THE MEDICAL POLYCLINIC AT THE UNIVERSITY OF JENA.

AUTHORIZED TRANSLATION,

WITH ADDITIONS.

BY

FRANCIS H. STUART, A.M., M.D.,

MEMBER OF THE MEDICAL SOCIETY OF THE COUNTY OF KINGS, NEW YORK; FELLOW OF THE
NEW YORK ACADEMY OF MEDICINE; MEMBER OF THE BRITISH MEDICAL ASSOCIATION;
OBSTETRICIAN TO THE BROOKLYN HOSPITAL, ETC.

THIRD REVISED EDITION.

WITH ONE HUNDRED AND SEVENTY-EIGHT ILLUSTRATIONS,

Many of which are in colors.

PHILADELPHIA.

W. B. SAUNDERS,

925 WALNUT STREET.

1896.



71
V663
1896

Entered according to the Act of Congress, in the years 1891, 1893, by
W. B. SAUNDERS,
in the Office of the Librarian of Congress, at Washington.

VORWORT DES AUTORS ZUR ENGLISCHEN AUFLAGE.

Es gereicht mir zur lebhaften Genugthuung, Herrn Francis H. Stuart, M.D., meinen Dank dafür auszusprechen, dass er es unternommen hat, meine *Diagnostik* in das Englische zu übersetzen. Ich bezweifle nicht, dass die Übersetzung ihm gut gelungen ist, und gebe ihr den Wunsch mit auf den Weg, dass sie sich in der neuen Welt ebenso viele Freunde erwerben möge, wie die deutsche Ausgabe in Deutschland gefunden hat.

HEIDELBERG, 30sten März, 1891.

PROF. DR. O. VIERORDT,

Director der Poliklinik.

TRANSLATOR'S PREFACE TO THE THIRD EDITION.

THE rapid sale of the second edition, which was quite large, has enabled the Translator to subject his work to another careful revision. For the correction of many slight errors and suggestions of improvement he is indebted to Professor George Dock of the University of Michigan, who was a pupil of the Author, and who uses the work as a text-book in his classes.

The Translator desires to express his gratification that this valuable work of Professor Vierordt has met in its English dress such universal welcome and appreciation. This generous reception by the profession has been a reward for his labor, and a stimulus to him to make the work still more worthy of its popularity.

FRANCIS H. STUART.

123 JORALEMON STREET, BROOKLYN, N. Y.,

TRANSLATOR'S PREFACE.

THE work of which a translation is here offered is one of the best that has yet been written upon the subject. When it first came into the hands of the translator he had no thought of ever using it except as a work of reference. But as he read it he became convinced that it had such merit that it would certainly be welcomed by a large class of readers if it were rendered into English. Accordingly, after communicating with the author and his publisher, the work of translation was begun, and has been prosecuted at such intervals of time as could be secured from an active professional life. If the work shall commend itself to others as it has to him, the translator will feel amply rewarded for the effort he has made to put it into their hands.

Here and there slight additions have been made, which the translator trusts will increase the value of the work. A very full index has been prepared, which, it is believed, comprises a reference to every material statement in the book.

The translation was almost completed when a copy of the second edition of the original was received from the publisher. The author has made numerous additions which have enhanced its value, and the translation has been made to correspond with this enlarged edition. It is gratifying to the translator to find that a second edition has so soon been called for, and that his own favorable opinion has been further confirmed by the fact that Italian and Russian translations of the work have been made.

FRANCIS H. STUART.

123 JORALEMON STREET, BROOKLYN, N.Y.,

MARCH, 1891.

AUTHOR'S PREFACE TO THE SECOND EDITION.

IN this edition the book has received, as I think, not inconsiderable additions and improvements. To mention only the most important ones: The section upon the examination of the contents of the stomach has been almost entirely rewritten, and so have some portions of the section on the examination of the organs of the senses, especially that of the eye. The laryngoscopic examination of the larynx has been treated anew, and much more extensively than in the first edition. A short section, almost entirely new, has been added upon the enlargement of the vessels of the brain, and at the end of the book a concise presentation of those peculiarities of micro-organisms whose recognition and discrimination are made possible by cultures and inoculation. Finally, with the hearty coöperation of the publisher, the illustrations of the most important micro-organisms are printed in colors, and also some entirely new figures have been added.

I am indebted to the friendly assistance of Professor Gärtner in the department of bacteriology, of which I here make public acknowledgment.

OSWALD VIERORDT.

JENA, AUGUST, 1889.

PREFACE TO THE FIRST EDITION.

THE book which is here offered to the medical public was undertaken at the solicitation of a number of associates, and in view of the experience which I have acquired during more than four years of work as Teacher of Diagnosis in the Medical Clinic at the University of Leipsic. Originally I had in view a very extensive treatise comprising a detailed explanation of normal and pathological anatomy and physiology as a foundation for diagnosis. But this plan I abandoned with a view to the convenience and general usefulness of the book.

Regarding the principles which have guided me, and which I hope, particularly in the "Special Part," notwithstanding the brevity of the presentation, have been made plain, I may be permitted here to specify the following. I have here, as well as in my teaching, taken pains to emphasize that, besides availing ourselves of the constantly-increasing finer methods of diagnosis, the simple use of our senses, especially of the unaided eye, must not be forgotten. Still more the manifold labors with the microscope and in the laboratory ought not to permit the physician to forget that a preparation or a chemical reaction is not enough for a diagnosis, but that the whole organism must always be brought under consideration. In other words, in diagnosis as well as therapeutics this rule is imperative: We must *individualize* the case. Should the book to any extent antagonize the inclination of our time to theorizing, it would afford me especial satisfaction.

OSWALD VIERORDT.

LEIPSIK, JUNE, 1888.

CONTENTS.

PART I.

CHAPTER I.

INTRODUCTION.

	PAGE
Anamnesis	18
Mode of Taking the Anamnesis	19
What the Anamnesis Comprises	20
Previous History of the Patient	20
The Present Disease	22

CHAPTER II.

EXAMINATION OF PATIENTS.

What the Examination Comprises	24
[Note by the Translator upon Keeping Records of Cases, and a Form for Recording the Results of a Medical Examination]	24

PART II.

CHAPTER III.

GENERAL EXAMINATION.

I. The Psychical Condition of the Patient	31
II. The Position of the Patient	31
III. The Structure of the Body and Nutrition	33
IV. Skin and Subcutaneous Cellular Tissue	36
A. The State of Nutrition of the Skin	36
B. The Moisture of the Skin ; Perspiration	36

	PAGE
c. The Color of the Skin	38
1. The Pale Skin	39
2. Abnormal Redness of Skin	41
3. The Blue-red Skin, Cyanosis	42
4. The Yellow Skin, Icterus, Jaundice	45
5. The Bronze Skin	48
6. The Gray Skin of Silver Deposit	49
d. Other Pathological Appearances of the Skin which are of General Diagnostic Value	49
1. Acute Exanthematous Diseases	49
2. Exanthemata from Poisons and the Use of Medicines	50
3. Hemorrhages in the Skin	51
4. Scars	52
e. Edema of the Skin and Subcutaneous Cellular Tissue (Edema, Anasarca)	52
f. Emphysema of the Skin	55
V. The Temperature of the Body. Fever	57
1. The Terms Used and the Method of Taking the Temperature	57
2. The Normal Temperature of the Body	59
3. Elevated Temperature. Fever	60
4. The Subnormal Temperature	63
5. Diagnostic Value of the Temperature, especially of its General Course	64
6. Local Elevation or Lowering of the Temperature	71

PART III.

CHAPTER IV.

EXAMINATION OF THE RESPIRATORY APPARATUS.

Examination of the Nose and Larynx	73
1. The Nose	73
2. The Larynx	74
Examination of the Lungs	76
Topographical Anatomy of the Lungs	76
The Anatomical Boundaries of the Lungs with Reference to the Thorax	77
Inspection of the Thorax	81
1. Normal Form of Thorax and Normal Respiration	81
2. Pathological Forms of Thorax	83
3. Anomalies of Respiration	89

	PAGE
Palpation of the Thorax	100
1. Pain caused by Pressure upon the Thorax	101
2. Testing the Movement during Respiration	102
General and Preliminary Remarks Regarding Percussion	103
1. History and Methods	104
2. Qualities of Sounds	106
3. The Conditions that determine the Quality of the Sounds and their Production in the Body. The Feeling of Re- sistance	109
4. Topographical Percussion: Determining the Parietal Bound- aries of Organs	116
Percussion of the Thorax, Especially of the Lungs	118
1. Methods	118
2. Normal Sound over the Lungs, Trachea, and Larynx. The Normal Boundaries of the Lungs	119
3. Abnormal Sound over the Lungs. Abnormal position of the Border of the Lungs	125
The Second Quality of Sound which is found over Diseased Lungs	130
Auscultation of the Lungs	138
1. History. The Sphere of Auscultation at the Present Time	138
2. Methods of Auscultation	138
3. Auscultatory Signs in Normal Respiration	141
4. Pathological Sounds in the Respiratory Apparatus	144
Palpation of Vocal Fremitus (Auscultation of the Voice)	156
Exploratory Puncture of the Pleura	160
Methods of Measuring and Stethography	162
Measuring the Thorax	162
Spirometry, Pneumatometry, and Stethography	163
Cough and Expectoration	164
Expectoration, Sputum	167
1. General Characteristics of the Expectoration	168
2. Foreign Substances in the Sputum which are Visible to the Unaided Eye	171
3. Microscopical Examination of the Sputum	175

CHAPTER V.

EXAMINATION OF THE CIRCULATORY APPARATUS.

Examination of the Heart	191
Anatomy of the Normal Heart	191
Preliminary Remarks necessary to Understand the Physical Phe- nomena of the Heart	193

	PAGE
Inspection and Palpation of the Region of the Heart	197
The Apex-beat	197
Alteration in the Width and Strength of the Apex-beat	200
The Neighborhood of the Heart in general	202
The Epigastrium	204
Percussion of the Heart	204
Normal Percussion Figure of the Heart	205
Methods of Percussion	205
Enlargement of the Area of Heart-dulness	208
Diminution or Loss of Heart-dulness	210
Displacement (dislocation) of the Heart-dulness	210
Auscultation of the Heart	211
Method and Normal Condition	211
Pathological Changes in the Heart-sounds	216
Organic Endocardial Heart-murmurs	221
Inorganic, Anæmic Murmurs. (Synonyms: accidental, blood murmurs.)	229
Pericardial Murmurs. [Friction-sounds.]	230
Examination of the Arteries	234
I. The Pulse, its Palpation and Graphic Representation	234
Palpation of the Pulse	234
1. The Normal Pulse	234
2. Pathological Frequency of the Pulse	237
3. Want of Rhythm of the Pulse	241
4. Quality of the Pulse	241
5. Symmetry of the Radial Pulse	245
II. Other Phenomena in Arteries	253
Examination of the Veins	260
Inspection and Palpation of Veins	260
1. Increased Fulness of Veins	260
2. Phenomena of Circulation in the Jugular Veins	262
3. Phenomena of Circulation in Other Veins	267
4. Venous Thrombosis	268
Auscultation of Veins	268
Examination of the Blood	270
Preliminary Remarks	270
1. Color and Spectroscopic Character of the Blood	270
2. Microscopic Examination of the Blood	273

CHAPTER VI.

EXAMINATION OF THE DIGESTIVE APPARATUS.

Mouth, Palate, and Pharyngeal Cavity	284
Examination of the Œsophagus	291

	PAGE
Examination of the Stomach	297
Anatomy of the Stomach	297
Inspection and Palpation of the Stomach	299
Percussion of the Stomach	304
Auscultation of the Stomach	307
Examination of the Intestines	308
Inspection and Palpation	308
Percussion of the Intestine	311
Auscultation of the Intestine	312
Examination of the Peritoneum	312
Inspection of the Abdomen	313
Examination of the Liver	319
Inspection of the Liver	320
Palpation of the Liver	323
Percussion of the Liver	326
Examination of the Spleen	332
Inspection of the Spleen	334
Palpation of the Spleen	334
Percussion of the Spleen	336
Auscultation of the Spleen	339
Examination of the Pancreas, Omentum, Retro-peritoneal Glands	340
Examination of the Contents of the Stomach	341
Examination of the Process of Digestion	342
Stomach-digestion and its Disturbances	342
Mode of Procedure in Examining the Stomach-digestion	347
Vomiting, and the Examination of What is Vomited	358
The Vomit	359
Animal Parasites	377

CHAPTER VII.

EXAMINATION OF THE URINARY APPARATUS.

Examination of the Kidneys	392
Anatomy	392
Local Examination of the Kidneys	394
Pathological Conditions of the Kidneys	394
Examination of the Ureters and Bladder	398
Examination of the Urine	399
(A) Normal Urine	401
(B) Pathological Urine	406
Sediments of Organic Bodies, or Direct Products of These	416
Inorganic Sediments	428
Examination of the Urinary Constituents in Solution	433
Bile-pigments and Bile-acids	442
The Urine as Affected by Medicines	450

CHAPTER VIII.

EXAMINATION OF THE NERVOUS SYSTEM.

	PAGE
Anatomy; Normal and Pathological Physiology	452
1. The Cortico-muscular Tract (the Pyramidal Tract, Flechsig)	452
2. The Sensitive or Centripetal Tracts	459
3. Centres and Tracts of the Special Senses	460
4. Remarks upon the Vessels Supplying the Brain	461
Symptomatology and Methods of Examination	463
Examination of the Seat of Disease	463
The Spinal Column	467
The Peripheral Nerves and their Surroundings	468
Examination of the Condition of the Mind	469
Disturbances of Sensibility	472
1. Sensitiveness to Peripheral Irritation	472
(<i>a</i>) Sensibility of the Skin	473
(<i>b</i>) Deep Sensibility	479
The Knowledge of Form (Stereognosis)	481
2. Sensible Phenomena of Irritation and Pain from Pressure upon Nerves	482
1. Paræsthesia	482
2. Spontaneous Pain	482
3. Distribution of the Sensory Cutaneous Nerves	484
Disturbances of Motility	488
1. Paralysis	488
2. Disturbance of the Nutrition and Tone of the Muscles	489
3. The Reflexes	495
1. Skin Reflex	495
2. Tendon Reflexes (periosteal, fascial reflex)	497
4. Electrical Examination of the Nerves and Muscles	501
Regarding the Physics, and the Instruments Employed	501
Methods of Examination and their Physiological Results upon the Living Human Body	505
General Methods, and Explanation of the Terms Employed in Galvanic Examinations	506
Method of Examination in Detail. Normal Condition	507
1. Points of Stimulation	508
2. Examination	510
(<i>a</i>) Faradic Examination	512
(<i>b</i>) Galvanic Examination	515
3. What to Observe in Determining the Electrical Re- action	516
Faradic Current	517
Galvanic Current	517

	PAGE
1. The Reaction of Degeneration (EaR)	519
(a) Complete EaR	519
(b) Partial EaR	519
Varieties of EaR	523
(c) Mixed Electrical Reaction	523
2. Myotonic Reaction (Erb)	524
3. Diagnostic Value of the Electrical Condition	524
4. Mechanical Excitability of Muscles and Nerves	526
5. Coördination and Ataxia	527
6. Spasms of the Voluntary Muscles	530
7. Voluntary Muscles, their Innervation, their Function, and the Diseases that Disturb Them	536
Disturbances of Speech (Lalopathy)	548
I. Dysarthria and Anarthria	548
II. Aphasic Disturbances, Disturbance of Graphic Communica- tion (of Mimicking and Singing)	549
Mode of Procedure in Testing for Aphasic Disturbances	555
Sense Organs	561
Disturbances of the Vegetative System in Nervous Diseases	575
1. General Phenomena	575
2. Disturbances of the Respiratory Apparatus	575
3. Disturbances in the Circulatory Apparatus	576
4. Disturbances of the Digestive Apparatus	577
5. Disturbances of the Urinary Apparatus	579
6. Disturbances of the Genital Apparatus	580
7. Disturbances of the Skin	581
Bones and Joints	583
The Diagnostic Value of the Symptoms in Nervous Diseases	583

 APPENDIX.

1. Laryngoscopic Examination of the Larynx	589
Paralysis of the Muscles of the Larynx	597
2. Examination with the Ophthalmoscope	600
3. Bacteria which come under Consideration in the Diagnosis of In- ternal Diseases	602



MEDICAL DIAGNOSIS.

PART I.

CHAPTER I.

INTRODUCTION.

THE physician arrives at an opinion regarding his patient in two ways: by inquiry of the patient or of friends of the patient, and by his own objective examination. The result of the former is called the *Anamnesis*; the latter reveals the *Present Condition of the Patient*. The notes which the physician makes from time to time in the course of his continued observation of the patient, and in which he records the changing phenomena of the disease, constitute the *History of the Case*.

The judgment formed in this way is expressed by the *Diagnosis*. In a narrow sense such a judgment simply consists in giving a name to the disease that is found; or, if there are several diseases together, or special complications of one, names to several diseases. But in the wider sense, a diagnosis must always consist of something more than this. The physician must endeavor to form a clear conception, in a given case, as to how the whole organism has been affected from the beginning, what is the character of the disease, or what harm it has wrought already in the organism as a whole, as well as locally. If in the narrow sense the diagnosis is schematic, so that the disease can be classified, then the diagnosis is in a broader sense individualized. A complete, exhaustive presentation of the peculiarity and severity of the existing disease and of the patient's prospects

(Prognosis) is presented only by this method. This alone is a sure guide in treatment.

We attain to a diagnosis in this wider sense only by having our perception of the general behavior of patients quickened and by carefully combining with it the experience derived from previous examinations.

Since the chief object of this work is the teaching of the examination of patients and the presentation of the methods of conducting it, we begin with but a very few words in regard to obtaining the

ANAMNESIS.

What is it necessary for the physician to know, beyond what his examination reveals, in order to recognize a given disease in itself and to form a critical judgment regarding the patient in a larger sense? It is difficult to define this. Facts which appear insignificant in themselves in experience often exercise a decided influence upon the special diagnosis, and especially in forming a judgment regarding the constitution of the patient, or upon the timely recognition of a secondary disease. From having at hand clear knowledge of the symptoms of the different diseases, both of their remote or predisposing and of their directly exciting causes, the physician is constantly able to select what is essential from the past, and so to avoid too great prolixity. But it is always well for the beginner to secure as complete an anamnesis, or prior history, as possible, in order that he may allow nothing of importance to escape his attention.

The anamnesis generally begins with and involves the question as to whether the disease is acute or chronic, what organs are affected, or are inclined to be diseased. This determines the examination to follow, in that certain organs are examined with greater exactitude than others. But the examiner must guard himself from too great influence or prejudice from the result of the anamnesis; the objectivity of the objective examination must be kept in view; and this, in turn, may give occasion for supplementing the anamnesis, by occasioning additional inquiries regarding certain occurrences and appearances, and thus a conclusion is finally reached. It is advisable for the student, under all circumstances, with all the patients he examines, and for the physician at least with his more important cases, to note

down in regular order the results both of the anamnesis and of his examination. [See Translator's note, page 24 *et seq.*]

Mode of Taking the Anamnesis.

First, we always note the name, occupation, age, residence of the patient. Then we conduct, as simply as possible, a dialogue with the patient, or in the case of a child or of a person who is insensible, unconscious, or mentally disturbed, with his neighbors or relatives. How much we may allow them simply to tell, how much we must learn by asking questions, must depend upon the cultivation and intelligence of the person who is giving the information. We must particularly guard against asking the patient leading questions—that is, influencing his reply by the manner in which we put the questions. To the question: “Have you then really never had any pain in the bowels?” or, “Did you never have any pain in the bowels?” we shall almost certainly receive an affirmative answer, either from indifference, or from a desire to make his complaints as interesting as possible and enlarge upon them; or, lastly, whether because he is of a very impressionable nature, and the mere calling to mind the question of pain suggests to him what in reality he has not had.

On the other hand, we must exercise close scrutiny of what we learn, a scrutiny which it is generally best not to allow the patient to know of. This scrutiny may be made with reference to three points:

(a) We must not accept without further inquiry the name the patient gives to a disease he has formerly passed through, since mischief is often done by the laity in the use of the names of diseases, as of diphtheria, typhus, etc. In any doubtful case we inquire its symptoms, and also what the physician who attended the patient had called the disease.

(b) The simulation of a disease is common. This was confined in large part to the domain of hysteria; but, now-a-days, from certain social reasons, it is much more frequent. Neuralgia, rheumatism, trembling, spasms, lameness, also pains in the bowels, asthmatic attacks, are the conditions which are most often simulated. The attempt to deceive is made not only with reference to the anamnesis, but also during the objective examination.

(c) The concealment of the appearances of disease is manifest with reference to the different sexual diseases, especially syphilis. Women,

moreover, often attempt to avoid all statements in regard to the sexual apparatus, even when it alone is diseased. Inebriates, and those who practise onanism, often confess their habits to the physician only with great reluctance.

What the Anamnesis Comprises.

The exact knowledge of the etiology and symptomatology of internal diseases is here the only correct guide, and, at the same time, gives us complete information respecting the cases which, under various circumstances, come under consideration. We are content with indicating the essential point of view by the introduction of a few examples. We may divide every anamnesis into the following two parts:

I. *Previous history of the patient:* This comprises all that it is important to know up to the beginning of the disease on account of which the patient consults the physician.

II. *The present disease:* This relates to the exciting causes, the commencement, and the course to the present time.

PREVIOUS HISTORY OF THE PATIENT.

1. *Hereditary disease (heredity).* This is of importance in so many diseases that in each and every case we have to inquire regarding the parents, brothers and sisters of the patient, and also very often regarding the brothers, sisters, and parents of the parents. There especially come into view in this connection, syphilis, tuberculosis, diseases of the brain, and certain general neuroses. Heredity, as regards rheumatism, carcinoma, and diseases of the heart, is of secondary importance, yet not immaterial. These diseases are in part inherited as such, in part they confer upon the descendants only the organic foundation, the disposition to the new development of the same or related diseases. Different descendants are variously divided by heredity. Often individuals, or a majority, are wholly exempt. It also happens that one generation is entirely passed over, and the trouble reappears in the following generation (hence the question regarding the grandparents).

Of the infectious diseases, smallpox and syphilis can, without

doubt, be conveyed *in utero*; but the intra-uterine communication of tuberculosis from the mother to the child is extremely improbable.

2. *The manner of life, habits, profession, occupation, residence, experiences as to fatigue, other harmful influences to which they have been exposed, whether they have descendants, and, in the case of women, the number and character of their confinements,* compose this group.

Under *the manner of life* are considered the diet, character of dwelling, and the clothing. Injurious habits play a very important part in the manner of life, especially immoderate use of alcohol and tobacco; so, also, venereal excesses must be taken into account. But it is important to remember that, at least within certain limits, the harmful limit of these things differs with the individual.

Profession and occupation on the one hand affect the whole constitution, and on the other are often to be regarded as predisposing or exciting causes of disease; finally, they may exert a favorable or an unfavorable influence upon the course of an existing chronic disease. Thus, for instance, stonemasons and polishers, by continually inhaling fine dust from the stone, are very frequently inclined to bronchial attacks and diseases of the lungs; thus, too, the occupations that have to do with lead (type-setting, type-polishing, painting), or with mercury (making mirrors, etc.), frequently cause chronic poisoning by these metals. Persons who are engaged about sheep, swine, horses, or with the fresh skins and hair of these animals, are apt to have malignant pustule and other diseases.

The *place of prior residence* is to be considered with reference to miasmatic (intermittent), endemic diseases, or epidemics which may have prevailed there at that time. With travellers, exotic diseases, which less frequently occur in their native places, as lepra, certain exotic animal parasites, etc., must be thought of.

As regards *fatigue*, army marches are to be regarded as particularly fruitful sources of disease; so of exposure to *harmful influences*. A fall, slight, perhaps, but whose effects continue; or a wound, without other immediate sequelæ except that it does not heal—of these, account must be taken; and also of very harmful momentary experiences, as sorrow, care, severe fright, anxiety.

Where there is *sterility* we consider anomalies of the sexual apparatus of the man or woman, but especially the question of syphilis. The

puerperal period, even when it does not pursue an unfavorable course, may in various ways be a source of disease.

3. *Diseases which one has had*, not only acute diseases, but the temporary outbreak of a chronic disease ending in apparent or real recovery.

Certain acute diseases may have as sequelæ certain other diseases which either are directly connected with them, as paralysis following diphtheria, nephritis after scarlet fever; or which appear after a shorter or longer period, as valvular disease of the heart from endocarditis in acute articular rheumatism, arising during scarlet fever.

The *outbreaks of a chronic disease* are often spoken of by patients as diseases which they have gone through; as, especially, the primary and secondary affections of syphilis, temporary manifestations of tuberculosis of the lungs, etc.

This point is of special importance in two ways: 1. There are certain acute diseases which one does not easily have a second time, as scarlet fever, measles, typhoid fever. On the other hand, others readily occur again, as erysipelas, pneumonia, articular rheumatism, typhlitis. 2. Certain diseases of childhood are especially to be considered—for example, scrofulosis as early indications of tuberculosis; manifestations of hereditary syphilis; frequent convulsions as an early sign of anomalous condition of the nervous system. The diseases ordinarily designated as “children’s diseases” generally have no significance as to the future, but yet sometimes, unfortunately, they leave lasting suffering behind them, as emphysema after whooping-cough, etc.

THE PRESENT DISEASE.

1. *The possible exciting causes* must be first considered. It is especially important for the early diagnosis of an infectious disease to inquire whether the patient has been exposed to infection. Many diseases are conveyed by a very short exposure, others require a longer, or even a personal contact. Also the period of incubation must be considered. This is the period from the moment of infection until the outbreak of the disease. With most transferable diseases this period is of a known, somewhat exactly defined duration. Moreover, “taking cold,” over-exertion, improper eating and drinking, taking of poison, etc., come under consideration.

It is to be remarked that the laity often assume something as an exciting cause, thus especially "taking cold."

2. *The first appearances and the course of the disease* up to the time of examination.

With chronic diseases the first appearances are sometimes at the beginning scarcely noticeable: they often consist only in a change from the previous behavior, unless the new condition in itself directly appears to be one of disease; a person who previously had red cheeks becomes paler (all kinds of wasting diseases), a stout person without other reason becomes thin, one who always previously ate and drank little, all at once eats and drinks considerably (diabetes), a person formerly very orderly becomes disorderly, forgetful (disease of the brain, especially progressive paralysis). Even when they have made considerable progress, such gradually developing disturbances often are not at all noticed by ignorant and indifferent people.

CHAPTER II.

EXAMINATION OF PATIENTS.

THE examination of the patient comprises :

1. *A general examination*, which takes into account certain phenomena of disease which concern the organism as a whole, and are the expression of a pathological change of the whole organism.

2. *A special examination*, which inquires into the different regions and organs, the secretions and excretions of the body. At the bedside we generally proceed in such a way that, beginning at the head, we gradually go downward, in order to facilitate the investigation by examining contiguous organs. But in many cases it is better to group together organs that are functionally related, no matter what their anatomical location may be, since we thus quickly obtain a comprehensive view of the way in which the affected organs or systems are disturbed. Thus, in diseases of the heart, the heart and bloodvessels, in diseases of the nervous system, the central and peripheral nervous systems are examined together. Sometimes, as in the case of very weak or very unruly patients, as children, the examination of the body must be very brief. Here the expertness of the physician especially is put to the test to the utmost degree.

It will best answer the purposes of study if the division of the subject throughout strictly conforms to the organ-systems, and hence the special part is divided into :

- I. Examination of the respiratory apparatus.
- II. Examination of the circulatory apparatus.
- III. Examination of the digestive apparatus.
- IV. Examination of the urinary apparatus, including also in part the sexual apparatus.
- V. Examination of the nervous system.

[NOTE BY THE TRANSLATOR UPON KEEPING RECORDS OF CASES, AND A FORM FOR RECORDING THE RESULTS OF A MEDICAL EXAMINATION.

It is not practicable at the bedside to go through any set form for conducting the inquiry regarding the present illness. The most direct

way of getting at it, and the one that will lead to the most satisfactory replies to our interrogatories, is to ask the question, What is your complaint? How are you sick? or some such direct question as this. In this way we get at once at the disease we are called upon first to diagnose and then to treat. As we proceed we will arrange the facts in our minds, and when we make the record, we shall place them in a natural and logical order. Having a regular form for keeping records of cases soon develops an order of procedure in accordance with it.

Case-taking is a most valuable aid to the student in clinical study.

1. He learns to make a systematic examination of the patients he sees. He forms the habit of bringing before his mind each factor in the case in orderly succession. There are two advantages from this. First. He forms the *habit of thoroughness in examining* his cases. Second. He can readily compare one case with another—having arranged the factors of each in like order. While it is not necessary in making the examination to have or to follow strictly a printed form, yet it is desirable to have some regular form for making the record, so that cases that are similar can be readily compared. One case may require going over only a few points, in another it will be necessary to examine every organ in the body.

2. The memory is greatly strengthened. Memory depends upon attention and repetition. Case-taking cultivates both of these in an eminent degree. Facts and symptoms that else would escape notice entirely, or be only slightly noted, are brought prominently before the mind for consideration. Their value or bearing is weighed, and so they are strongly impressed upon the mind.

3. The mind is developed by this habit of carefully reflecting upon every feature of a case. Thought is both stimulated and made easy. Clearness and power of thought are increased. Independence of judgment is cultivated. Both knowledge and intellectual cultivation are acquired. "By knowledge is understood the mere possession of truths; *by intellectual cultivation, or intellectual development, the power, acquired by exercise of the higher faculties, of a more varied, vigorous and protracted activity.*" (Sir William Hamilton.)

4. Ease and habit of writing are almost unconsciously acquired. This is most valuable. The great majority of physicians keep no records of cases. Many never record or publish important ones,

because they have not the facility of writing which comes with practice. *Anything is easy to the practised hand.* “Who can estimate how much we have lost, from the fact that generations of men gifted with powers of acute and shrewd observation, have passed away without leaving one record behind them? Think not that it is the hospital physician or surgeon alone who can advance the progress of medicine. There is not a practitioner who could not aid this great work. But he can only add to it with efficiency if he has *faithfully recorded his observations*, and does not trust to the general and vague impressions of unassisted memory. Therefore, on all grounds, personal to yourselves and general for medical science, so engrain this habit within you that it becomes a second nature.” (Coupland.)

THE ANAMNESIS.

Personal and Previous History.

Name,	Address,	
Birthplace,	Age,	Sex,
Family history—Heredity :		
Father,		
Mother,		
Brothers,		
Sisters,		
Other relatives.		

Manner of life, habits, occupation, residence, etc.,

Previous diseases—character and results.

(Note each one that was of such a character as to have any lasting effect upon the health or vitality.)

Present Illness.

Duration,

Possible exciting cause,

How began—suddenly or not; prodromal symptoms,

Course of the disease till the time of examination.

Examination of the Patient.

General examination :

Appearance,
Psychical condition,
Position in bed,
Structure and nutrition,
Skin and subcutaneous tissues,
Temperature,
Pulse.

This covers the general features of every case. Attention has been directed, by what has been learned thus far, to some one or more of the special organs or systems of the body. It is usually best first to examine that, and to make this examination very full and thorough. Then the remaining organs of the body can be examined with greater or less fulness, according as they are found to be affected by the principal disease, or as they are related to the one specially diseased. It is well to form the habit of following a certain order in examining each organ. One is much less apt to overlook any part; and, too, as has already been pointed out, the records will be more easily consulted and compared. For this purpose, it is well to take the order of the text-book, so as to become thoroughly familiar with each subject. It is not of so much importance that this or that one is adopted, provided it is a good one. But we have here a notable illustration of the truth and value of the Spanish proverb: "Beware of the man of one book."

Presuming that those who use this work will follow the order laid down in it, the form now given conforms with the order in which the systems are treated.

SPECIAL EXAMINATION.

Examination of the respiratory apparatus :

Nose,
Mouth,
Larynx.

Examination of the nervous system :

Disturbances of sensibility,

Location of,

Superficial or deep,

Motor disturbances,

Disturbances of speech,

Condition of the organs of special sense.

]

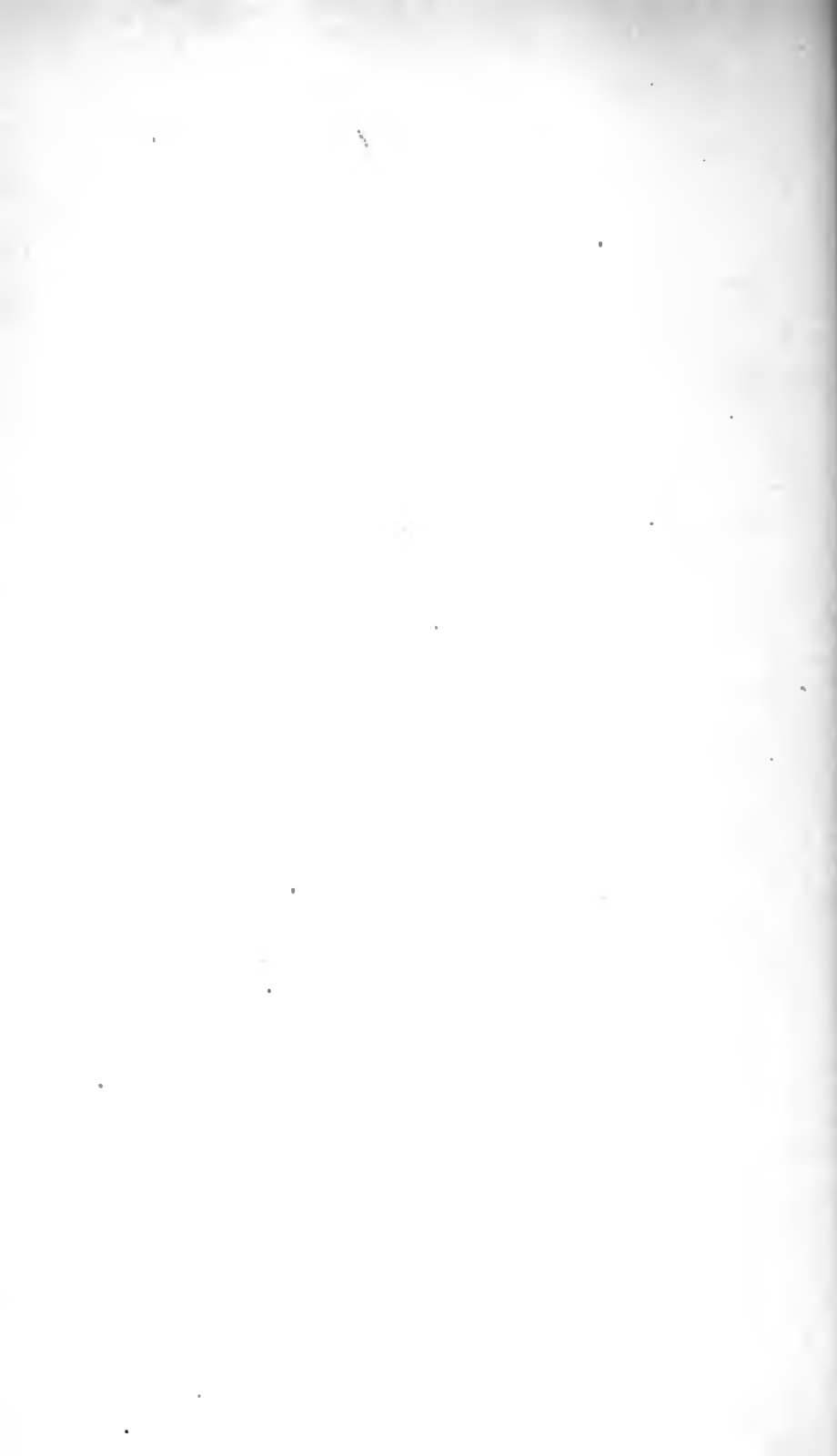

PART II.

CHAPTER III.

GENERAL EXAMINATION.

THIS consists of a number of subordinate divisions, namely: we have to consider:

- I. The psychical condition of the patient.
- II. The position in bed.
- III. The general structure of the body and the nutrition.
- IV. The skin and the subcutaneous cellular tissue.
- V. The temperature and the pulse.

I. THE PSYCHICAL CONDITION OF THE PATIENT.

From this—that is, from the clearness of his intelligence, his susceptibility to external impressions, his power of thought, from the possible presence of depression or irritability—we may often obtain important points of diagnosis; both for diagnosis in the narrower sense, certain diseases being accompanied with definite manifestations of this kind, and for diagnosis in a broader sense, since the severity of a disease, the possible turn for better or worse, often becomes manifest by the psychical condition of the patient. (Regarding this and the way in which the examination in this direction is conducted, see the section on “Examination of the Nervous System.”)

II. THE POSITION OF THE PATIENT.

This furnishes a very simple aid to diagnosis, because generally it can be determined by a single glance of the eye. From it conclusions in various directions may be drawn. People in health or only slightly sick usually assume the dorsal position, or a position upon one side,

in a certain unconstrained comfortable position (the active dorsal or side position). On the contrary, patients who either are not wholly conscious, or who have become very weak, frequently are inclined to slide down toward the foot of the bed and sink into a heap there, a position which manifests weakness, and in some respects, but especially for breathing, is very unfavorable (the *passive dorsal and side position*).

In acute infectious diseases, more than elsewhere, the *passive dorsal position* is specially noteworthy. It is particularly so when apathy and clouded intelligence are combined with great muscular weakness, as is frequently the case in typhoid fever, where such a condition of the patient is so frequently and sometimes early present that it may aid in the diagnosis.

But in still another way *the position in bed* is sometimes characteristic. Patients with *acute affections of the chest organs* involving only *one side* (pneumonia, pleurisy, pneumothorax) generally *lie upon the side*, and for the most part *upon the side affected*. This may be due to various causes. The pain caused by breathing is generally in this way diminished, because by lying upon the side the motion of that side is very much lessened, while, on the other hand, the motion of the opposite side in breathing is greater than when the patient lies upon the back; hence the sound side, when the patient lies upon the diseased side, can better compensate for the loss of the portion diseased. In exudative pleuritis frequently there is the further advantage in lying upon the affected side that the exudation least interferes by pressure with the healthy side.

Yet patients with pneumonia not infrequently lie upon the healthy side, because they have least pain in this position. That in diseases of the chest in general patients are inclined at the beginning of the disease to lie upon the sound side, and later upon the diseased side, I am not able to affirm.

Difficult breathing, dyspnœa, if extreme, prompts one to assume the upright sitting posture in bed or in an easy chair—*orthopnœa*; because in this attitude the action of the accessory muscles of respiration is more effective than when lying down. *Orthopnœa* may, therefore, occur with all diseases which are accompanied with marked interference with respiration: as in narrowing of the air-passages in disease of the lungs (comparatively rare with phthisis—see under

“Dyspnœa”), in diseases of the pleura, heart, pericardium, with large effusions into the abdominal cavity, which press the diaphragm up; and in general dropsy with effusions into the cavities of the body. In the severest cases the patients may indeed be obliged to keep the sitting posture, even to sleep. The continued exertion of sitting and the diminished sleep obtained in this position, besides the great anxiety and excitement these patients generally have, usually quickly bring on exhaustion.

Another group of characteristic situations and positions in bed refer to *diseases of the brain and its membranes*. Thus meningitis betrays itself often at the first glance by opisthotonus, with the head boring into the pillow, so-called contraction of the neck; in circumscribed disease of the cerebrum the head is sometimes persistently inclined to be drawn forcibly to one side: forcible contraction of the head; in affections of the cerebellum, also of the crus cerebelli, we not infrequently see the whole body continually, as one lies in bed, drawn sharply to one side, and, when turned over to the dorsal position, returning immediately again to this constrained position. These phenomena, however, are in part to be reckoned as convulsive conditions, which indeed bring about the greatest variety of characteristic positions and attitudes of the body. These latter, however, are generally quite transitory.

III. THE STRUCTURE OF THE BODY AND NUTRITION.

The development of the skeleton determines the form of the body. Generally firm bones and broad, flat chest are characteristic of strong and enduring health; while those persons of delicate skeleton, especially with slender ribs and narrow chest, are considered capable of both limited life and endurance. Yet this is only a general rule. We often see people of delicate build who are remarkably tough and enduring, both with reference to exertion and disease; and not infrequently we find robust people with little power of resistance, especially to acute diseases.

Unusually small development of the skeleton is often observed in idiots and cretins; and, in more rare cases, in *dwarfs*, without any other anomaly.

The form of the thorax is of especial importance. With a slight

and narrow chest-cavity there is a proportionally frequent disposition to tuberculosis of the lungs; and, on the other hand, a certain fulness carries with it a tendency to emphysema of the lungs. This will be more particularly spoken of under Respiratory Organs.

The significance of the structure of the pelvis is manifest in the practice of obstetrics.

The muscles, the subcutaneous tissues, and the skin furnish a means of judging of the nutrition, and also of the weight. In general, well-nourished and healthy persons have a certain volume and firmness of muscles. There is also a relation between the muscles and the skeleton. But even in perfectly normal persons there is a very marked difference in the volume of the muscles, which is not always explained by differences of occupation. By experience the eye gradually becomes quick in recognizing a suspiciously small muscular volume; yet the firmness of the muscles is a better guide to an opinion than their volume.

The fat of the subcutaneous tissues may be very differently developed in persons of good health. As a rule, it varies with the age, being greater for the first years of life up to the forty-fifth or fiftieth year. Beyond this it again, as a rule, becomes less. It also sometimes varies in a shorter time without being caused by disease, as in women at about twenty years of age. It varies also, as a matter of course, with the kind and the richness of food, as well as with the occupation. Loose adipose tissue generally indicates a weak organization.

A marked degree of leanness of the subcutaneous tissue is, under all circumstances, suspicious, and suggests an examination as to whether it may be caused by disease. In the same way the accumulation of fat beyond a certain degree becomes pathological. The measure or degree can only be established by experience.

Of much greater importance is a *commencing*, even though a slight, wasting away of the subcutaneous fat, and eventually also of the muscles. As we have said, this is sometimes physiological. It can also take place, as among the poorer classes, from very poor nourishment. But in the majority of cases it is caused by disease, and it is, therefore, important not to overlook it. This wasting can only really be learned by the physician when he has known the patient for some time. When this is not the case he must rely upon the statements of

the patient and his surroundings, and, therefore, this subject properly belongs to the "previous history." When the emaciation is marked, its proof is furnished by the condition of the skin. In these cases the skin of the patient's whole body is loose, and can easily be taken up in folds.

Excessive wasting is denominated *atrophy, emaciation*; and when this is accompanied by general loss of strength and failure of function, *marasmus* or *cachexia*.

The weight of the body is an excellent index and one which is superior to all other signs of corpulence, and its increase or diminution. The absolute value of the weight of the body in the different periods of life has no diagnostic interest, for the reason that it varies within wide limits. Likewise the relation of the weight of the body to the height and the circumference of the chest has scarcely any significance for our purposes. On the other hand, change in the body-weight wrought by disease is of the greatest importance. In chronic diseases this is an extremely valuable means of determining whether the disease is increasing, standing still, or is being recovered from. Taking the weight regularly (say, weekly) in cases of tuberculosis is especially to be recommended, also in diseases of the digestive apparatus. In convalescence from acute diseases, following the weight of the body is also a very important aid, especially for the early recognition of the possibility of the disease becoming chronic, or of the presence of associated chronic diseases. Moreover, in all these cases we must remember that œdema (which see) produces a deceptive increase in the weight of the body.

According to Bornhardt (cited by H. Vierordt), the relation of the weight of the body, P, to the height, H (in cm.), and to the average circumference of the chest, C (measured at the level of the nipples, in cm.), for the average individual, may be reckoned as follows:

$$P = \left(\frac{HC}{240} \right) \text{ kilograms.}$$

The weight of the body of the newly-born and its increase during the first months is of special significance. Regarding this subject, see works upon obstetrics and diseases of children, also *Daten und Tabellen*, by H. Vierordt.

Diseases of the alimentary tract, more than others, produce emacia-

tion; next, all febrile diseases, whether acute or chronic (of the latter especially tuberculosis), then severe forms of diabetes mellitus, and, finally, all malignant growths. A certain degree of emaciation can be produced by any disease of an internal organ.

IV. SKIN AND SUBCUTANEOUS CELLULAR TISSUE.

In medical diagnosis the condition of the skin and subcutaneous tissue is considered with reference to the following points:

A. The condition of general nutrition.

B. The moisture of the skin; perspiration.

C. The color of the skin.

D. Certain pathological appearances of general diagnostic value (characteristic eruptions, hemorrhages, scars, etc.).

E. The presence of œdema.

F. Possible emphysema of the skin.

Skin diseases proper and certain acute infectious diseases, with special localization upon the skin (the so-called acute exanthematous diseases) are not considered in this work.

A. THE STATE OF NUTRITION OF THE SKIN.

In old age the nutrition of the skin is diminished over the whole body. This is physiological. In earlier years a noticeable general atrophy of the skin exists only where there is a very severe cachexia. The skin is then thin and generally dry. It loses its tone, and when taken up in a fold resumes its place slowly.

The different forms of circumscribed atrophy of the skin which have been described do not interest us here. They belong to works upon skin diseases.

B. THE MOISTURE OF THE SKIN; PERSPIRATION.

Physiology teaches us that the moisture of the skin, as well as the visible secretion of perspiration, is influenced by various circumstances. It is increased during active exertion, by increased temperature of the blood, by moist heat, by mental impressions, especially fear; finally, by certain ingesta, as hot tea, by pilocarpine, etc.

In some of these cases there is at the same time an increase of heat of the body, which is overcome by the perspiration, cooling being caused by its evaporation.

Perspiration is a regulator of the temperature of the body.

The loss of water by evaporation (the greater part of the insensible perspiration) in health is, *cæteris paribus*, greater at night than during the day. It seems to alternate with the secretion of the urine.

In healthy people the secretion of perspiration is in this way very changeable. But it is still more so in cases of illness. It may be increased to such a degree that the whole bed may be wet through (hyperidrosis). On the other hand, it may be so diminished (hyphidrosis) that the skin is perfectly dry (anidrosis). Hyperidrosis of the whole body is called hyperidrosis universalis; if confined to a part of the body, hyperidrosis localis. The latter may be unilateral (hemidrosis).

A general perspiration may take place in cases of illness:

1. When there are present conditions which are analogous to those which produce it in persons in a state of health, as in cases of strong tetanic convulsions by the increased muscular work and heart-action. On the contrary, in cases of epileptic, hysterical, and other convulsions we have either no perspiration or at least none corresponding with the very great muscular exertion; in all possible diseased conditions connected with great excitement, especially fear, or with severe pain; and again, sometimes (not always, see below under Anidrosis) from a high degree of atmospheric heat, warm baths, moist warm pack, or sudorifics (pilocarpine, etc.). Morphine, also, with some persons, induces perspiration.

2. *In difficult breathing—dyspnœa.* This is generally connected with sweating. (In the same way sweating sometimes occurs with heart disease, accompanied by an engorged condition of the “greater” circulation; also with all diseases of the respiratory organs and their surroundings, which interfere with respiration.)

3. *In febrile diseases.* Sweating usually occurs with the fall of the temperature in these diseases. The most important instances are (a) the critical sweat of a rapid definite decline of the fever especially frequent in pneumonia and febris recurrens [relapsing fever]; (b) the sweat which regularly accompanies the fall of temperature in intermittent fever and pyæmia (diseases which manifest themselves by rapid rise

and fall of temperature), the night-sweats of the hectic fever of phthisis and the sweat of the remittent (hectic) fever of typhoid fever; and (c) the cold sweat of collapse (that is, the sudden failure of strength in the death struggle).

Acute articular rheumatism manifests itself by considerable perspiration, which may not depend upon a fall of temperature. Finally, there is always the inclination to perspiration in the commencement of convalescence from severe diseases and in parturient patients, when there is great weakness and the heart is easily excited.

Local sweating occurs in various neuroses, also in organic diseases of the nervous system. There is very frequently sweating of the whole of one side (hemidrosis), or of the head alone, as in Basedow's disease, migraine, hysteria; localized disease of the brain, and in mental diseases.

Diminished secretion of sweat, even to complete anidrosis, is observed chiefly in high continued fever. It is, moreover, a peculiarity of all diseases which are accompanied with considerable loss of water by the bowels or the kidneys, of severe diarrhoea of any kind, contracted kidney, and diabetes. The anidrosis which exists with general dropsy, in consequence of the anæmia of the skin produced by the pressure and stretching, has a peculiar appearance.

The anidrosis of high fever and general dropsy is very persistent, often resisting all therapeutic measures, both those acting directly upon the skin (moist heat, etc.) and the medicines already mentioned.

Qualitative alterations of sweat exist sometimes in severe jaundice, when it contains the coloring-matter of bile and is yellow in color; also, when the urinary secretion is greatly diminished or entirely suppressed, as in nephritis, diseases of the urinary tract, and cholera. It then contains considerable quantities of urinary products, which, by the evaporation of the perspiration, crystallize upon the skin (especially upon the nose and forehead) in small white scales. This is called uridrosis, the scales giving the reaction of urinary ingredients.

C. THE COLOR OF THE SKIN.

As is well known, races differ in the color of the skin, but even in the Indo-Germanic race there are variations depending upon the stock, the climate (blonde, brunette). In some nations the pale, in

others a more florid, complexion, especially of the face, preponderates. We know that there are differences depending on the mode of life; also that, even as regards the so-called healthy color of skin, considerable individual variations exist. But, after all, the hue of the skin stands in intimate relation to a large number of diseases of internal organs. It is considered most suitable to judge from the color of the countenance, the portion of the skin most generally reddened; and, since on every hand we have opportunity for practice, it is well to sharpen the eye for critically examining this part of the body. But the color of the countenance can sometimes deceive us (*vide* especially under "red skin"), and it is therefore advisable always to examine the mucous membrane of the lips, mouth, and throat,¹ and, besides, to glance at the color of the skin of a part of the body usually covered by the clothing.

We recognize the following abnormal colorations of the skin:

1. A pale skin.
2. The abnormally red skin.
3. The blue-red cyanotic skin.
4. The yellow skin of icterus.
5. The bronze skin.
6. The gray skin produced by nitrate of silver.

1. *The Pale Skin.*

This can to a certain extent be physiological, especially in persons who spend little time in the open air. In these cases a glance at the mucous membrane gives further information. But one can be deceived regarding such persons, who, having exposed the face (also arms and hands) frequently to radiant heat, or to cold and heat in rapid succession, often have a local redness of face. This redness of face may arise from other causes (p. 41).

Only experience can enable one to distinguish between physiological paleness and that produced by disease. The recognition of the latter is frequently aided in that it is associated with a grayish, yellowish color (see below). The color of the skin is produced by the fulness

¹ The conjunctival mucous membrane is not included. It is not decisive, since many persons in whom the teguments are elsewhere pale, at times have the conjunctiva easily injected.

of its capillary vessels. The abnormal paleness may be dependent upon disturbance of the circulation (and in consequence of diminished force of the heart or active narrowing of the peripheral arteries), or by a lessening of the quantity of the blood constituents, chiefly of the hæmoglobin. We distinguish: (a) Temporary paleness, which is partly physiological and partly pathological. It occurs with strong emotion, especially fright; in syncope or fainting; in the chill of fever, which ordinarily accompanies a rapid, considerable elevation of temperature; and in spasm of the capillary vessels. (b) Paleness lasting a longer or shorter time. This comes on sometimes quite rapidly, at least in the course of a few moments, during profuse hemorrhage and in sudden collapse—that is to say, in sudden failure of the heart as it occurs in acute, and sometimes chronic, diseases, and in acute poisoning. It is accompanied by a rapid and small pulse, increasing weakness, and, finally, loss of consciousness. Where there is external hemorrhage the condition is perfectly plain. But cases of severe internal hemorrhage, especially of the stomach or bowels, of ruptured aneurism, hemorrhage from internal wounds of any kind, are declared only by this sudden paleness, sometimes even before the patients themselves, if quiet in bed, complain of weakness.

In a case of endocarditis which I saw, the patient became pale, as one does from an internal hemorrhage, with increased frequency of pulse and stupor, within less than ten minutes. At the autopsy there was found a recent total rupture of an aortic valve.

This paleness can develop more slowly, within a few hours or days, by considerable repeated hemorrhages; as a symptom of weakening of the heart's activity in all acute and chronic diseases of the heart and pericardium; also in diseases of parts adjacent to the heart, as pleurisy and abdominal affections, with much pressure upon the diaphragm, in case they interfere with the action of the heart; finally, in many acute diseases, especially in diphtheria, in heart-failure from diseases affecting the muscular structure of the heart; and very often, and in a very striking way, in acute catarrh of the stomach (acute dyspepsia).

Finally, paleness of the skin comes on in certain conditions generally unnoticeable, insidious, and is a chronic condition: in the so-called special diseases of the blood and of the blood-making organs—indeed, most unfortunately, from a diminution of the hæmoglobin; hence, in

chlorosis, also in pernicious anæmia, leukæmia, pseudoleukæmia. In this list also probably belongs malarial cachexia. Paleness is a symptom of all slowly-developing *secondary anæmias* (*cachexia*) as they occur in a large number of diseases, such as all chronic febrile diseases, especially tuberculosis; in suppurations without fever; in continuing slight hemorrhages, as in many tumors and in ankylostomiasis [Egyptian chlorosis]; in all chronic diseases of the digestive tract; in most diseases of the female generative organs; in the different forms of chronic nephritis, especially the large white kidney; in chronic poisoning, especially by mercury and lead; sometimes, also, in constitutional syphilis; in malignant growths, especially in cancer proper; and in *chronic diseases of the heart*, but especially in fatty heart and mitral and aortic stenosis.

In most of these conditions there is, moreover, not only paleness of the skin, but its color has a still further characteristic appearance. In severe anæmias we often have a peculiar waxy appearance, which not rarely has a yellow tone. A striking, light white skin often exists with the so-called large white kidney, also in a certain proportion of the cases of lead-poisoning (which latter is often of a grayish white), of leukæmia and of tuberculosis. In chlorosis the skin has a greenish hue; in diseases of the heart-muscle and in mitral insufficiency the skin is generally a smutty yellow, while in the cachexia of cancer it is often gray-yellow.

In striking contrast is a large development of adipose tissue in cases of most marked paleness. This is very often so in diseases of the blood-making organs and in heart diseases. (It is not to be mistaken for œdema, *vide* under (Edema.)

2. *Abnormal Redness of Skin.*

This is an expression of a superfluity of normal blood, since a genuine plethora does not necessarily give rise to such a condition.

General abnormal redness of the skin exists as a sign of hyperæmia of the cutaneous capillaries in high fevers—especially in continuous fevers. It also is present during the perspiration following a warm bath. Finally, in poisoning with atropine, even in very mild cases, it is developed like the redness of scarlet fever. (The scarlet-fever redness, being connected with a disease of the skin, does not belong here.)

Local redness, depending upon a dilatation of the capillaries, exists very frequently in the face, and indeed is physiological in those who labor in the sun. It comes and goes quickly, as in blushing (*rubor pudicitiae*), in nervously excitable persons in consequence of very slight psychical impressions, also not infrequently as a result of physical exertion. Moreover, we see redness of the face in fever; finally, one-sided redness of face in the "paralytic" form of hemiplegia.

Tuberculosis is characterized by a very marked variation in the fulness of the capillaries of the face: if the patients are entirely at rest and without fever they are generally pale, but under excitement or exertion, after eating, and, lastly, during fever, they exhibit a very striking, generally bright, redness of the cheeks, and often a sharply-defined spot (*hectic redness*).

In the slight forms of anæmia, especially if it is associated with nervous irritability of heart (likewise with local vasomotor disturbances), there is sometimes intense redness of the face which may conceal the anæmia from the physician.

For distinction of circumscribed hyperæmia from hemorrhage in the skin, see under the latter.

3. *The Blue-red Skin, Cyanosis.*

This is most plain on the parts that normally are bright red, hence more than elsewhere on the mucous membranes, on the lips, cheeks, etc.; also on the knees, the phalanges of the fingers, and under the finger-nails. A moderate degree of cyanosis, therefore, would only be discovered at these parts. A marked degree, on the other hand, exhibits a blue color spread over the whole body, while those parts, especially the mucous membrane, become black-blue.

The cyanosis of the newborn, with heart-failure, is so striking to the experienced observer, that it is regarded by him as pathognomonic. One only sees anything like it in the death agony, and, exceptionally, in severe spasms with marked interference with breathing. The combination of cyanosis with great paleness is designated as "livid skin."

Cyanosis arises from the blue-red color of the capillaries, and this, as is well known, is caused by an accumulation of carbonic acid and

deficiency of oxygen—that is to say, by the venous or hypervenous character of the capillary contents.

Carbonic acid in the blood (serum and red corpuscles) arises from :
1. Interference with the exchange of gases in the lungs. 2. From the slowing of the capillary circulation and the consequently diminished gas-exchange in the tissues, that is to say, the diminished giving up of CO_2 by the tissues to the blood.

Cyanosis arises, therefore : 1. In disturbed respiration and circulation through the lungs ; 2. In disturbance of the “greater circulation,” which may be general or circumscribed according as the stoppage may be general or local. The two causes may be combined.

Here belong to 1 :

(a) *All conditions which cause a narrowing of the larger air-passages or of a large number of small bronchi* : inflammation of the neighborhood of the pharynx or entrance to the larynx ; retro-pharyngeal abscess, angina Ludovici ; very exceptionally a diphtheria of the throat. (In all of these cases the interference with respiration is either direct or dependent on œdema of the glottis.¹) The following are enumerated : spasm of the glottis, paralysis of the dilator of the glottis (crico-arytenoideus post.), all acute and chronic inflammations of the larynx, but especially croup ; tumors of the larynx ; cicatricial narrowing of the larynx ; foreign bodies in the larynx (something swallowed or vomited) ; also foreign bodies, croup and scars in the trachea or one or both primary bronchi, compression of these from without by enlarged glands, aneurism of the aorta, etc. ; mediastinal tumors, etc. ; bronchial spasm ; and severe diffuse bronchitis, especially the acute croupous form.

(b) *All diseases of the lungs and diseases in the neighborhood of the lungs which hinder their expansion or wholly compress them* : emphysema of the lungs ; all forms of consolidation ; pleuritic and great pericardial exudation, pneumothorax ; tumors in the chest-cavity ; abdominal diseases with marked upward pressure of the diaphragm.

(c) *Paralysis of the respiratory muscles* : bulbar paralysis, peripheral neuritis ; paralysis of diaphragm from peritonitis ; spasm of the

¹ A very distressing case of suffocation from the lodgement of a large piece of meat in the pharynx, and the consequent closure of the entrance of the larynx, presented itself at the Leipzig medical clinic.

museles of respiration, epilepsy, tetanus, but, on the other hand, very rarely hystero-epilepsy; special muscular diseases: myopathic forms of progressive muscular atrophy, trichinosis, myositis ossificans.

Disturbances of the circulation through the lungs occur in a number of the diseases which interfere with respiration. In emphysema a large number of capillary channels are closed, also in tuberculosis and other chronic lung affections; a large pleural exudation not only compresses the lungs, but also the capillaries. This acts in the same way as a hindrance to respiration.

(d) *Diseases of the heart which result in obstruction of the pulmonary circulation.* It is to be noticed that in the conditions named under (b) a disturbance of the respiration interferes with pulmonary circulation. Moreover, we must emphasize the fact that in several of these conditions (especially diseases of the pleura, of the peritoneum, in trichinosis of the diaphragm and intercostal museles) the insufficient breathing, as well as the cyanosis, will be increased by the pain caused by the act of breathing. If the physician correctly recognizes the chain of events he will be able to bring relief by the use of narcotics.

In persons very much wasted, especially from tuberculosis, cyanosis may be absent even in spite of the loss of a large part of the breathing surface of the lungs, since the remaining normal portion suffices for supplying the required quantity of oxygen to the diminished quantity of blood.

Under heading 2:

Slowing of the blood-current in the capillaries of the greater circulation is dependent upon stopping of the venous outlet. This can be general and caused by all the conditions of the first category, general cyanosis, or it can be occasioned by a venous stopping of an extremity or of the head, and so produce a local cyanosis.

General venous damming occurs in diminished pumping power of the right ventricle (valvular deficiency, congenital stenosis of the pulmonary artery, diseases of the heart-muscle, large pericardial exudation with hindering of the heart's action, considerable emphysema of the lungs with excessive damming of the smaller circulation), and in the rare case of compression of a large venous trunk just before it enters the right auricle (tumors of the mediastinum).

Local venous stasis is caused by closure or marked narrowing of a more or less large venous trunk. This closure may be produced by

compression or by thrombosis of the vein (compression of the cava or the extremity of a venous trunk by tumors); compression of the cava inferior in connection with the common iliac artery by very large effusion in the peritoneum, or by tumors; atrophic thrombosis of a vein of the extremity, especially the femoral. Not infrequently the collateral veins of the skin take up the conveyance of the blood of the venous stasis; they then become enlarged and sometimes tortuous (*vide* examination of the veins).

For the cyanosis produced by certain poisons, see Examination of the blood.

4. *The Yellow Skin, Icterus, Jaundice.*

The jaundiced state of the skin exists in well-marked cases, with slight differences, almost equally over the surface of the whole body. It is found especially in the conjunctiva, and in slight cases exclusively there and in the other mucous membranes, if the observer will render the spot anæmic by pressure (best done by means of a microscopic slide pressed upon the everted lip or upon the tongue). According to the intensity of the jaundice the tissues are but *slightly tinged with yellow*, or *citron color*, or yellow-green. Only in very severe cases (*melas-icterus*) does the skin become green or brownish-yellow.

Jaundice cannot be detected by the ordinary means of illumination, since the yellow, artificial light does not enable one to distinguish between white and yellow. In slight cases it will first be detected in the conjunctiva. But this must not be confounded with the yellow fat that sometimes exists there, especially in elderly people. In persons with yellow or brown skin the jaundice is revealed by an examination of the mucous membrane.

The yellow color of the skin after taking picric acid or santonine has no relation to jaundice. We distinguish this condition from jaundice by analysis of the urine (*q. v.*) and by the etiology of the former.

Jaundice of the skin is the yellow coloration of almost the whole body by the *coloring matter of the bile in the blood*. Very much the most frequent form is the jaundice of simple engorgement, hepatogenous or mechanical jaundice, according to the old designation. It is occasioned by a primary biliary engorgement in the liver, resulting

from a purely local interference with the discharge of bile. This interference is at the ductus choledochus, the transverse fissure of the liver, or within the liver.

But there are also so-called hæmatogenous forms of jaundice which have this in common, that at the first indication of the existence of jaundice there is hæmoglobinæmia, because hæmoglobin is set free from the red blood-corpuscles. In many of these cases (poisoning, see below), according to recent investigations, it is to be assumed that, from the decomposition of the red blood-corpuscles, there is secreted in the liver a very concentrated, thick bile, and that this cannot flow through the ductus choledochus, thus producing engorgement and jaundice. It is still uncertain whether this explanation can be applied to all cases of jaundice which are not to be referred to primary biliary engorgement. It is not inconceivable (although more and more doubtful) that hæmatoidin or bilirubin (these two being identical) is formed from the hæmoglobin which has become free within the blood-vessels. This would be a purely "blood-jaundice" in the old sense.

In all these cases the coloring-matter of the bile passes into the urine, although when the jaundice is very slight it may not do so (see particularly under 2 of this section). The occurrence of the bile-acids in the blood and its appearance in the urine can, of course, only take place in primary or secondary jaundice due to engorgement. Hence, these would be an infallible indication as to whether the jaundice was due to engorgement, or was "blood-jaundice," provided there was, on the one hand, no trace of bile-acids in the normal urine; or, on the other, if they very rapidly disappeared after passing into the blood. Thus, even in cases of undoubted engorgement-jaundice, the bile-acids might not appear in the urine.

In very marked jaundice the coloring-matter of the bile is also found in the perspiration and in the saliva.

It is to be remarked that by no means every case of hæmoglobinæmia results in jaundice; sometimes it simply results in hæmoglobinuria, sometimes also in urobilinuria.

1. *Hepatic jaundice* is almost always purely the result of a biliary stoppage. The cause of the penning-up of the bile may exist in the bowel; in gastroduodenal catarrh, with catarrhal swelling of the mucous membrane, and accumulation of mucus in the ductus choledochus; in tumors which press upon the duodenal orifice of the ductus

choledochus, and especially cancer of the head of the pancreas; in ascarides, or round-worms (*q. v.*) which enter the ductus choledochus; and also in gall-stones, which lodge there.

There may be compression of the hepatic duct or of the large gall-duct at the entrance of the liver by tumors (carcinoma, echinococcus), or by scars, or by closure of the same by gall-stones. Closure of many small bile-ducts may be caused by so-called intra-hepatic gall-stones; possibly also compression of these by marked damming in the branches of the veins of the liver from general venous stasis; finally, catarrh of the smallest bile-ducts may possibly cause bile stasis and jaundice, as in phosphorus-poisoning.

In case the flow of bile is much hindered or is wholly stopped, then, partly from the want of bile and partly from the fatty contents, the stools become light, perhaps entirely white or gray-white. The particulars of this condition of the stools and of urine in jaundice are explained in the chapters devoted to these subjects.

In some cases of severe jaundice there may be still other appearances: itching, various skin affections, minute cutaneous hemorrhages, slowing of pulse, or simple nervous manifestations. In very severe, long-standing jaundice, there may be marked heart disturbances, hemorrhagic diathesis may develop, or, finally, there may arise severe nervous manifestations (cholæmia, cholæmic manifestations).

Moreover, hepatic jaundice may be produced by the sudden diminution of pressure in the portal vein while the pressure in the bile-ducts remains the same, as at the moment of birth—icterus neonatorum (Frerichs).

2. Hæmato-jaundice, whose primary cause is to be regarded as a decomposition of the blood, takes place in certain acute infectious diseases (pyæmia, yellow fever, probably also sometimes in pneumonia); and from certain poisons (chloroform, ether, chloral, chlorate of potash, solution of arsenic, toluylendiamin).

In this case, as well as in the jaundice of damming, there may be bile coloring-matter in the urine. Not infrequently, as in pyæmia, well-marked signs of bile coloring-matter may be wanting, and this has diagnostic value for the assumption that we have a case of hæmato-jaundice.

It is very important to notice that in real blood-jaundice the flow

of bile into the intestine is not disturbed, and hence there is no alteration of the color of the stools.

Urobilin-icterus. In diseases of the liver, in prolonged hemorrhages of whatever nature, also in the hemorrhagic diathesis, finally, in fever, a larger quantity of urobilin is removed by the urine (see *Urine*). Hence in rare cases a mild jaundice is observed: *Urobilin-icterus* (Gerhardt, Jaksch).

The origin of urobilin is to be explained as follows: First hæmatoidin or bilirubin is formed, and then urobilin is formed from this by reduction in the tissues or in the bloodvessels.

5. *The Bronze Skin.*

Unlike cyanosis and jaundice, this is a condition pertaining only to the skin and mucous membrane. We speak of the chief symptom, instead of the true anatomical seat, of the disease, viz., the supra-renal capsule—the so-called Addison's disease. (Very frequently it is tubercular.) [The association of this peculiar brown discoloration of the skin is not constant in Addison's disease. It is not so constant in cancerous, but is more common with cheesy, degeneration. The latter condition may be present without bronzing of the skin. On the other hand, the skin may be bronzed, just as "in Addison's disease without the existence of cheesy degeneration or any other change in the supra-renal capsules. These facts have induced many observers to attribute the cutaneous discoloration rather to changes in the neighboring sympathetic nerves—the solar plexus and the semilunar ganglia."]

The bronze skin is characterized by a brown, gray to black discoloration, especially of the face and hands. There is also the common normal pigmentation of the skin in spots. The discoloration may gradually extend over the whole surface of the body, only the nails and cornea remaining clear.

It is very important to notice that the same discoloration appears upon the mucous membrane of the mouth, and more rarely upon the lips, as very sharply circumscribed, frequently quite small, brown specks.

The discoloration is caused by deposit of pigment in the rete Malpighii. Of course, pressure with the finger does not at all diminish it.

6. *The Gray Skin of Silver Deposit.*

After long-continued administration of nitrate of silver there may be deposits, in certain organs, of very fine black particles (metallic silver or silver albuminate?), as in the kidneys, intestine, and also in the skin, and especially in the corium, the tunica propria of the sweat-glands.

The skin of such persons, especially of the face and hands, is *gray* or *blackish*. The color is not changed by pressure. In severe cases we also observe corresponding gray specks in the mucous membrane of the mouth.

In a strict sense this is not a diseased condition: these people are perfectly well.

D. OTHER PATHOLOGICAL APPEARANCES OF THE SKIN OF GENERAL DIAGNOSTIC VALUE.

1. *Acute Exanthematous Diseases.*

In some acute infectious diseases a characteristic eruption of the skin has so marked an appearance that these diseases are designated as "acute exanthemata." They are: Scarlet fever, measles, German measles, smallpox, and varicella. Here we may pass over these diseases, since they are closely connected with the complete description as they are taught at the bedside.

On the other hand, there are certain other acute exanthematous diseases, less striking, but at the same time of great diagnostic importance. We may here briefly mention:

(a) *Roseola*. This presents a small, round, rose-red, slightly elevated spot.

It is generally scattered, is found most frequently upon the abdomen and lower part of the back, more rarely upon the breast and extremities in *typhoid fever*. It appears about the beginning, and generally fades at the end, of the second week. Now and then secondary roseolar spots appear later, which are connected with exacerbations of the disease (involving new portions of the intestine?).

Secondly, they appear in most cases of *typhus fever*. But, except in light cases, they are in this disease petechial—*i. e.*, the location of small hemorrhages, which are slowly absorbed.

Further, they exist in some cases of acute miliary tuberculosis, and finally in animal poisoning.

(b) *Herpes facialis*. This consists of a group of small vesicles upon a slightly red base. The vesicles contain at first clear water, then are cloudy, then yellow from pus contained in them. They may be confluent. After a few days they dry up and scale. Most frequently this exanthem is found in the neighborhood of the mouth—herpes labialis; or of the nose—herpes nasalis; it may also appear upon the cheeks or the ear.

It makes its appearance at the beginning of some acute diseases and seems to be especially peculiar to very rapidly rising fever. Above all it accompanies croupous pneumonia, then epidemic cerebro-spinal meningitis (in this disease it is often quite extensive), finally, sometimes in angina (angina herpetica), and a light febrile disease named in consequence, febris herpetica.

An herpetic eruption also sometimes accompanies the development of *intermittent fever* and the *chill of pyæmia*.

(c) *Miliaria* or *sudamina*. These are small, remarkably clear vesicles, which reflect the light strongly, generally in large numbers, especially upon the abdomen. They appear if a patient, after long-continued anhidrosis, begins to sweat profusely, especially in acute, but also sometimes in chronic, diseases. It is necessary to mention them here only because the explanation of their diagnostic, and likewise pathological, meaning ought to be made prominent.

Still other exanthemata of diagnostic importance could be mentioned here, as the (rare) scarlet redness in the beginning of *typhoid fever*, the different eruptions of *sepsis*, *pyæmia*, and other diseases.

2. *Exanthemata from Poisons and the Use of Medicines.*

These are of varied character, since they sometimes resemble those of acute diseases, viz., scarlet fever, measles, etc. They may, therefore, easily cause an error in diagnosis. It is sufficient here to point out the diagnostic importance of these exanthemata. The particulars regarding them belong to works on diseases of the skin, and also to pharmacology and toxicology.

3. Hemorrhages in the Skin.

They arise chiefly by diapedesis, and take place particularly, but not exclusively, in dependent parts, especially the lower extremities. They may be of every size—from the smallest perceivable point to the size of the palm of the hand, or even larger. The small, punctiform hemorrhages, ecchymoses or petechiæ, are most apt to appear at the hair-follicles. The color of fresh hemorrhages is like venous blood. During absorption they are brown-red, later becoming bright brown.

A hemorrhage is distinguished from a circumscribed inflammatory redness of skin *in that it does not disappear upon pressure*. (The small ecchymoses in the hair-follicles, mentioned above, are easily confounded with the latter, especially in cyanosis; further, petechiæ in parts previously inflamed, as in measles, are easily overlooked.)

Simplest test: Press a piece of glass, a microscope slide, upon the suspected spot. A hemorrhage is rendered more distinct, while the surrounding part becomes anæmic; an inflammatory hyperæmia, on the other hand, disappears.

Hemorrhages appear:

1. *As evidences of a marked hemorrhagic diathesis*. They are then generally extensive in the skin, and, moreover, occur in connection with hemorrhages from internal organs. They occur in scorbutus, purpura hemorrhagica; in severe acute infectious diseases, especially pyæmia, smallpox, and scarlet fever: in acute phosphorus-poisoning and acute yellow atrophy of the liver; and in all severe cachexiæ.

2. *Without internal hemorrhages*, as a condition limited to the skin: in peliosis rheumatica [*i. e.*, purpura occurring with severe pain in the extremities]; also as small petechiæ; almost constantly in typhus fever (see Roseola), often in measles, and scarlet fever; moreover, on the legs when the convalescent patient first stands up, especially after typhoid fever; and in badly nourished persons where they have been bitten by pediculi.

3. *In marked venous stasis*, local as well as general (see Cyanosis).

4. *As traumatic hemorrhages in and under the skin*. They are sometimes of importance for determining the occurrence of an injury, especially upon the skull.

4. *Scars.*

These are often important marks for limiting or explaining the clinical history, which, by reason of the scars, can be confined to past local or general diseases, or to injuries received.

Thus come under consideration "pock" (smallpox) marks and the scars which may remain after the different *scrofulous* and *syphilitic* diseases of the skin and deeper organs, especially the bones and glands. In internal medicine, *scars from injuries* have importance in many nervous diseases (injuries upon the head, the spine, in the course of peripheral nerves).

Here also belong the *scars of pregnancy, stricæ*, upon the lower part of the abdomen and the upper part of the thigh. Exactly the same scars occur in marked œdema (see the following section), and also sometimes in very fat persons.

E. ŒDEMA OF THE SKIN AND SUBCUTANEOUS CELLULAR TISSUE
(ŒDEMA, ANASARCA).

By these terms we designate an abnormal, marked saturation of the tissues with fluid, which fluid remains wholly or in part distributed in the cellular meshes and lymph-spaces, instead of a corresponding quantity of fluid existing in bulk, as its transudation takes place from the bloodvessels to be removed by the lymph-current.

Œdema is recognized by puffiness of the skin causing increase of volume of the affected part, and hence, also, the normal contour, the prominences of the joints, as well as depressions, are obliterated, and, moreover, there is a tendency to an equal roundness. The skin is smooth, generally slightly shining, and hence very pale in consequence of the diminished circulation. It is very noticeable that the œdematous tissue loses its elasticity, so that a depression made by the point of the finger remains for a certain time, sometimes for hours.

In general or widely extending œdema it is most manifest in dependent parts, or where the skin is tender and the subcutaneous cellular tissue is loose. Hence, in those persons who walk and stand it appears first at the ankles or on the dorsum of the feet (not on the soles and toes, since here the skin is too thick or closely attached;) in bed-ridden patients, on the inner side of the thigh or in the scrotum

and penis, where it is often enormous; on the lower part of the back; sometimes first of all, in the loose cellular tissue beneath the lower eyelid. One must examine all of these points if he would detect the first evidences of œdema.

In very marked cases the deeper parts, especially the muscles, become œdematous; the legs may then attain enormous proportions. Moreover, in marked general dropsy there are fluid accumulations in the cavities of the body, giving rise to hydroperitoneum or hydrops ascites, hydrothorax, hydropericardium.

In long-continued œdema the skin of the legs and the lower part of the abdomen may become thickened, as in elephantiasis.

We recognize three causes for dropsy of the skin (as for dropsy in general):

1. Venous stasis (hydrops mechanicus).
2. Altered condition of the blood, particularly its becoming watery.
3. Inflammations.

Hence, these corresponding diseases cause œdema:

1. All diseases, local or general, which hinder the return of venous blood to the right side of the heart, as those that have been already mentioned under Cyanosis (see p. 44).

In local stasis the œdema is naturally confined to the roots of the corresponding veins, as, for example, thrombosis of the right crural vein, causing dropsy of the right leg, or compression of the vena cava inferior by an abdominal tumor, causing dropsy of both lower extremities.

2. All forms of hydræmia (anæmia), acute and chronic nephritis, in which the diminished excretion of water, on the one side, and the loss of albumin from the blood, consequent upon the albuminuria (which see), on the other hand, occasions the hydræmia, which is the chief factor in the condition which permits frequent and often marked œdema. Yet the hydræmia does not always explain the existence of the œdema (Cohnheim and Lichtheim; see under Albuminuria).

All other kinds of anæmia (hydræmia, see Blood) come under this head when they appear as diseases of the blood or of the blood-making organs, and are secondary to the appearance of wasting diseases and severe acute diseases (as œdema of the ankles, when the convalescent patient first stands up).

The anæmia caused by long-continued slight hemorrhages (as those

occurring in ankylostomo-anæmia) may also lead to moderate œdema, for here also we have hydræmia, in that the loss of blood is replaced by water in the blood.

3. Œdema, sometimes of considerable extent, occurs *in the neighborhood of inflammation* ("inflammatory œdema," "collateral œdema"). This may be of great diagnostic importance, since it sometimes reveals a deep-seated inflammation.

This is of more interest to the surgeon. To the physician it is important, for instance, in pleuritis with œdema of the chest-wall. It shows, with tolerable certainty, that the pleuritis is purulent. Deep muscular abscesses in severe diseases, as in typhoid fever, may easily be overlooked, and may first be recognized by the appearance of œdema in the neighborhood, as along the femur.

The œdema in these different, but so heterogeneous, cases does not have a uniform character: that from stasis is sometimes soft, sometimes very elastic, the latter especially (in marked stasis) exists in the extremities, when it is often difficult, and sometimes impossible, to leave the mark of the pressure with the finger; moreover, in cases of nephritis, with a small quantity of urine and marked albuminuria, it is sometimes very considerable, but now and then softer. In the different anæmias the œdema is mostly slight—a scarcely noticeable puffiness.

Slight œdema disappears between morning and evening, or evening and morning, according to the change of position of the body.

The question, Why does œdema result from venous stasis, hydræmia, or inflammation? has not in all respects been satisfactorily answered. Until recently it seemed to be proved that this is entirely to be ascribed in these three conditions to an injury of the endothelium of the vessels, and by this means occasioning increased transudation into the tissues (Cohnheim). Recently the view has been advanced, and it seems to me has become well established, that the loss of elasticity and the diminished squeezing-out of lymph from the tissues by their being relaxed plays an important, perhaps a chief, part in causing œdema (Landerer). This relaxation of the tissues might be caused by the stasis from the increased transudation, or by the hydræmia from the deficient nourishment of the tissues by the morbidly thin blood: or, finally, it might be caused by inflammation excited in the neighborhood.

In conclusion, we must not omit to mention that, in rare cases, œdema exists without any other possible morbid disturbance. Here belong the essential œdema of children and the œdema of the feet after forced marches.

F. EMPHYSEMA OF THE SKIN.

By emphysema of the skin is understood the entrance of air into the cellular tissue. It may be limited to one region of the body, as the neck or the upper part of the chest, or the upper part of the abdomen. But it may be spread over almost the whole of the body. It is a very rare condition.

We recognize emphysema of the skin by the very pale skin over a region which is decidedly elevated above its surroundings. Indeed, on account of the loose fixation of the skin in certain parts, even depressions, as that over the clavicle, or the axillary space, or the intercostal spaces, *may be filled up*, so that sometimes on a first glance at the part it seems like marked œdema. Sometimes at such places there may even be an elevation of the skin like a pillow. Upon palpation we find that the part is very yielding, like a soft pillow. Quite unlike œdema, however, the depression made by pressure immediately disappears. Moreover, upon palpating the part, we feel and hear an unusually fine crackling.

The so-called *spontaneous emphysema* of the skin does not here concern us. It arises from decomposition of a blood extravasation, or abscesses with formation of putrid gases.

The so-called emphysema of skin from aspiration arises from the entrance of air or gas into the subcutaneous tissue, either from without through a wound of the skin, or from within from an organ containing air or gas.

(a) The entrance of air from without after a wound of the skin belongs to surgery. It is especially observed in wounds of the neck, of the breast, in the lower part of the face (so-called wounds of the mucous membrane). The wounds in question are sometimes remarkably small.

(b) Of much greater interest in themselves, as well as from a diagnostic point of view, is emphysema from air or gas entering the cellular tissue from within. Under all circumstances it is occasioned by the

rupture, either spontaneously or traumatically, of the wall of an organ containing air or gas. Hence, emphysema¹ from "aspiration" may arise—

1. From any portion of the respiratory tract, from the larynx down.

Deep-seated ulceration of the larynx or trachea may invade the walls of these organs, and thus the air may escape and enter the subcutaneous cellular tissue.

Cavities of the lungs (after previous, repeated adhesions between the pulmonary and parietal pleura) may ulcerate into the chest-wall, until, finally, communication with the cellular tissue is established. Then the pressure of a severe paroxysm of cough may cause the air in large quantity to spread out quickly under the skin. Single pulmonary alveoli may burst from any very high intra-thoracic pressure, as severe cough, especially in children with whooping-cough, bronchitis, or emphysema; sharp crying; severe exertion, as blowing on wind-instruments, or women in childbirth; and air may enter under the pleura or into the inter-alveolar tissue, reach the mediastinum, pass along the mediastinal space into the subcutaneous tissue of the neck, and so spread onward.

Wounds of the lungs (as fracture of the ribs without external wound) may either directly cause emphysema of skin, or, passing the mediastinum as above, take the same course.

2. From the œsophagus, stomach, or intestines, and, indeed, from the œsophagus again through the mediastinum; from the stomach or intestines by adhesions with the abdominal wall and invasion of the cellular tissue there; from traumatic rupture of the œsophagus, more frequently from ulceration, especially in connection with carcinoma of the œsophagus; with any kind of deep-seated ulcerations of the stomach and bowels.

Sometimes there occurs extensive decomposition of the cellular tissue, especially if emphysema of the skin is produced by gases from the intestinal canal (mixed with intestinal contents). Very often, however, the emphysema remains without such action. It may then spontaneously disappear. But at the same time, the emphysema is generally a final development, partly on account of the severity of the

¹ The name "emphysema" is not quite accurate, since generally the air is driven in under pressure, as is shown by what follows.

primary disease, and partly because it causes severe dyspnœa, as, for instance, that in the mediastinum, and hence is a very serious condition.

From a diagnostic point of view, emphysema of the skin is of great importance, since it affords a conclusion regarding the diseases mentioned. Under some circumstances it may afford the first and only symptom, as in the affections of the œsophagus.

V. THE TEMPERATURE OF THE BODY. FEVER.

It is a well-known peculiarity of warm-blooded animals that they, if the organization is otherwise sound, with remarkable constancy, maintain a certain internal temperature which is subject to very slight variations. If that peculiarity is lost, if the temperature departs from the normal, then, almost without exception, a morbid disturbance is present. A knowledge of this fact, and especially of the elevation of the specific heat in disease, attracted the attention of physicians to the temperature of the body from the earliest time. Recently, however, the measurement of the temperature has become of the greatest diagnostic aid. In what way this is so will be explained at length.

1. *The Terms Used and the Method of Taking the Temperature.*

Judging of the temperature by *laying on of the hands* is under all circumstances deceptive. Great errors cannot be avoided even if covered parts of the body are selected, while uncovered parts cool so rapidly as to furnish no standard.

We measure the temperature with the *Centigrade or Celsius's thermometer*, with the scale divided into tenths, from about 30° to 45°. There is no need for a thermometer with indications below 30° (see below).

In France the Réaumur scale is sometimes used; in England and America the Fahrenheit is generally used. To convert from one standard to another the following formula is used:

$$1^{\circ} \text{ C.} = \frac{4}{5}^{\circ} \text{ R.} = \left(\frac{9}{5} + 32\right)^{\circ} \text{ Fahr.}$$

It is further to be remarked, that in Germany still, especially at the public baths, the baths are frequently measured and are prescribed according to Réaumur standard.

Regarding the selection of the instrument, it concerns us to remember that there are many incorrect thermometers. Exact comparison with a standard at the time of purchase, and at least every two years thereafter, is indispensable, since all thermometers register somewhat higher with age. Thermometers with a cylindrical column of mercury are to be preferred, since they are more reliable and likewise easier to use. Maximal thermometers are strongly recommended, but the index must work exactly; moreover, it is of course always to be remembered that every time before using the thermometer the index must be shaken down as far as (in certain cases below) the normal mark.

When a comparison with a normal thermometer cannot be made, an approximate determination may be made by taking the temperature in the axilla of a healthy person upon say six different days an hour after breakfast. A thermometer which is correct in its reading must then give an average reading of 37° C. or a little less (Liebermeister).

The temperature may be taken in the axilla, the rectum, or in the vagina. (Taking the temperature in the mouth, and especially from freshly-passed urine, is to be avoided.) Of the three places mentioned, the rectum or vagina would be preferred, since their temperature most nearly corresponds with that of the inside of the body, since the thermometer lies very equally in either of these situations, and because it requires less time, the maximum being there soonest reached. But from reasons of delicacy we only take the temperature there when it is not possible to take it in the axilla.

Therefore, ordinarily, the thermometer is placed in the axilla (which should be first carefully wiped dry, if it is moist) as high as possible, and then the flexed arm should be pressed against the chest. [The maximum is indicated in from three to five minutes. Some thermometers accurately indicate it in one minute; but these are so delicate as to require special care to avoid breaking. The thermometer is to be left in as long as the index continues to rise. One can easily ascertain how long a given thermometer requires by testing it in warm water at various temperatures.]

If the patient is unconscious the arm must be held. In cases of marked unconsciousness, of unruly persons, and of children, it is better to take the temperature in the rectum or vagina.

If there are fecal accumulations in the rectum the result is unre-

liable. The thermometer is to be oiled and passed in to the depth of about 5 cm. The maximum is indicated in about five minutes. In the rectum the temperature is usually about $0.2^{\circ}\text{C.} = 0.36^{\circ}\text{F.}$ higher than in the axilla.

If the thermometer is not self-registering, it must, of course, be read before it is removed. After using the thermometer in either the rectum or vagina it must, in every case, even when there is no infectious disease of either of these organs, be carefully disinfected. [No matter where the thermometer is used, it ought always to be immediately cleaned most thoroughly.]

A single use of the thermometer may be of great value. But it is still more important, as will be shown below, to follow the state of the temperature progressively, and to ascertain its course. For this purpose it is necessary to measure it at stated intervals. How frequently this must be done in order to ascertain the course of the temperature, must be determined by the particular disease. The thermometer should be used at least twice in twenty-four hours (at about 8 A. M. and again at about 5 P. M.). In diseases with high fever, according to the rapidity with which the oscillations of the temperature are completed, the thermometer must be used every three hours, every two hours, or even hourly. Where the changes of temperature are very marked, it may be of interest to observe it every quarter-hour. It is to be understood that, where it is proper to do so, the use of the thermometer should, as far as possible, be suspended at night, in order not unnecessarily to disturb the patient's sleep.

The record of the course of the temperature may be indicated by a curve. Charts suitable for this purpose of various kinds are to be had. They serve also for the record of the pulse and respiration. Now-a-days, in every case of severe fever, the physician ought to prepare such a fever-curve.

In what follows, the statements regarding the temperature refer to measurements taken throughout in the axilla.

2. *The Normal Temperature of the Body.*

The average temperature is 37°C. , and varies from this about $1\frac{1}{4}^{\circ}$: from 36.25° to 37.5°C.

The variations are of different kinds and have different causes. Of least interest, since they are only very insignificant, are those de-

pendent upon age (in children, except the day after birth, a few tenths higher than later; in old people, again, a little higher); an elevation after meals; an elevation after severe exertion.

But the periodic daily variations are more important. They follow the following course: In early morning, between two and six, the "daily minimum" is reached, and then with considerable (not perfect) regularity it rises to the "daily maximum," between 5 and 8 in the evening. From that point it again, during the night, declines. The difference between the minimum and maximum, the "daily difference," is about 1° C. (in rare cases even nearly 2° C.).

After severe exertion, the temperature rises quite a considerable amount higher, especially in the sun (Obernier observed that in the case of a person running it rose to 39.6° C.) and in very warm baths.

3. *Elevated Temperature. Fever.*

Every elevation of temperature which is not dependent in a marked way upon over-heating or severe exertion of the body, we call *fever*. The febrile elevation of temperature is generally for a certain duration, but it may exist in single cases as a single short period, "a febrile paroxysm."¹

But it is here important to remember that fever does not alone consist of an elevation of temperature, but is a complex symptom, whose separate manifestations are occasioned partly by an increase of tissue-changes, partly by disturbance of the functions of certain organs. To it also belong the elevation of the specific heat; also general feeling of being sick, relaxation, sometimes mental disturbances; increased frequency of pulse and respiration with exhalation of CO_2 ; loss of appetite, increased thirst, disturbance of bowels. The urine is generally diminished in quantity, with increase of excretory products of the body, especially of urinary products, of uric acid and diminished chlorides. In case the fever continues there is notable wasting. Although a part of these appearances may be caused by over-heating of the organism, yet in febrile disease they are doubtless not to be regarded as simple results of high temperature. Hence it results, among other things, that the increased frequency of the pulse,

¹ The definition of fever as "a continued elevation of temperature," therefore, is not suitable.

the mental manifestations, and the disturbances of the bowels, do not have a constant relation to the height of the temperature, but, on the contrary, have a markedly different expression according to the *cause* of the fever—that is, *the nature of the disease*. Nevertheless, the height of the temperature is a very practical index of the severity of the fever, and these two factors clinically become fully identified. But the physician must never forget to pay attention to still other manifestations of fever beside.

With reference to bodily temperature, Wunderlich has prepared the following table :

- I. Normal temperature, 37° to 37.4° C.
- II. Subfebrile temperature, 37.5° to 38° C.
- III. Febrile temperature,
 - a*, slight fever, 38° to 38.4° C.;
 - b*, moderate fever, 38.5° to 39° C. morning, and 39.5° C. evening;¹
 - c*, considerable fever, 39.5° C. morning, and 40.5° C. evening;
 - d*, high fever, 39.5° C. morning, and 40.5 C. evening.

[*Comparison of Thermometric Scales:*

Cent.	Fahr.
34°	93.2°
35	95
36	96.8
Normal temperature, 37	98.6 Normal temperature.
38	100.4
39	102.2
40	104
41	105.8
42	107.6
43	109.4]

If the temperature reaches 42° C. then we speak of *hyperpyrexia*, *hyperpyretic fever*. While the higher temperatures even of high fevers do not occasion direct danger to the organization, in hyperpyrexia the temperature is directly dangerous to life; it generally leads to a fatal issue.

¹ Regarding this difference between morning and evening temperatures, see under Remission.

There is uncertainty regarding the highest temperatures that have been observed. Temperatures of 45° C. have been published as curiosities. One case of injury to the spine, which resulted in recovery, is reported by Teale to have repeatedly had a temperature of 122° F. = 50° C.

The course of the temperature in twenty-four hours can vary much only in fever. Most fevers show distinct fluctuations, in that toward morning the temperature falls more or less, *remission*, until it reaches the daily minimum, thence in the course of the day it rises, *exacerbation*, and toward evening reaches the daily maximum.

The difference between the daily maximum and the daily minimum in fever is called, as in normal temperature, the daily difference. While the course of the temperature in fever is analogous to that of health, not unfrequently the minimum and maximum come at quite a different time, as, for instance, the maximum may be at midday or at midnight; a complete reverse may even take place so that the maximum occurs in the morning and the minimum in the evening: *typus inversus*.

From this it is seen how the temperature must be exactly measured every hour of the day and night if it is of importance to know whether a patient has fever or not. There have been cases when the persons were thought to be without fever until the physician thought of ascertaining the temperature at night.

The exacerbation of the fever is frequently connected with shivering. If the temperature rises very rapidly (it may rise several degrees in a single hour) generally there is a chill, that is, a decided feeling of chilliness with severe shaking of the whole body, chattering of teeth, when the high internal temperature of the body is then very quickly contrasted with the subjective feeling of chilliness. The skin is at first pale, livid, and generally cool; toward the end of the chill, however, it is regularly very hot. On the other hand, a rapid remission of the temperature is generally accompanied with sweats.

According to the amount of the daily difference we distinguish three types of fever:

Continued fever: daily difference not more than 1° C. (chiefly high temperature).

Remittent fever: daily difference over 1° C.

Intermittent fever: maximum very high, minimum within the normal (or even below).

An important peculiarity of fever is that the temperature does not long remain at the same point, as it does in health. It is very changeable. Warm clothing, high temperature of the room, and sometimes the taking of nourishment, cause a very marked rise of the temperature in fever; likewise also psychical influences, as fright or anger. On the other hand, a cool room and (especially) a cool bath, also gradual loss of blood, as in menstruation, cause it to fall. It is absolutely necessary to know this if we wish to ascertain the cause of many remarkable variations of temperature in fever. Moreover, the sudden fall of the temperature is sometimes a sure indication of an internal hemorrhage.

4. *The Subnormal Temperature.*

It begins at 36.25° C.; the lowest observed temperature is 22° C.

1. It is observed in febrile diseases as an expression of two directly opposite conditions, namely:

a. In a sudden fall of the high fever with an advance to recovery, the "crisis," the critical decline of the fever. In this case the temperature falls during perspiration sometimes to below 34° C., and only in the course of one, two, or three days again returns to the normal. We recognize the "crisis" by the simultaneous diminution of the frequency of the pulse and the respiration, and the feeling of comfort and returning health by the patient.

b. In the so-called collapse. In this condition there is generally a very rapid fall of the temperature, and at the same time a sudden failure of the heart, with (as is the contrary in "crisis") increase of the frequency of the pulse, with paleness and general failure of strength. The condition of collapse may pass over, when there generally is an immediate rise of temperature again to the former point; or it may pass on to a fatal termination.

On the chart of the fever-curve the line of the falling temperature is crossed by the rising line of the line of the pulse-curve in a characteristic way (see Pulse). Sometimes, in a case of collapse ending fatally, the pulse-line sinks parallel with the temperature-line (see Pulse).

2. It occurs sometimes temporarily in severe hemorrhages, also

sometimes in all kinds of chronic diseases, especially in those of the heart and the lungs. If the temperature suddenly falls, accompanied by weakness of the heart and general prostration, then also we speak of collapse.

3. *Continuing subnormal temperature*, extending into a number of weeks, is very rare. It may exist in all severe wasting diseases and in diseases of the brain.

5. *Diagnostic Value of the Temperature, especially of its General Course.*

Under certain circumstances a single, or, in other words, the first measurement of the temperature may be of the greatest diagnostic value. Of this a few examples may be given.

1. Frequently the elevated temperature, with some indistinctive complaints (or, in the case of children, abstinence from food with restlessness), is the only sign of a disease just commencing, or of one that has been going on for some time. Ascertaining the temperature is then of great service, in that it leads to a more careful examination and more extended observation, and to directing suitable care of the patient. A high morning temperature points directly to an acute infectious disease.

2. In marked cachexia, without distinct organic disease, the existence of temporary fever indicates tuberculosis with considerable probability.

3. A single chill accompanied with a rise of the temperature to about 40° C. may, in a given case, say of a disease which from experience sometimes causes suppuration, lead to the diagnosis of suppuration, as in gall-stones, renal calculi, after injuries to the skull, as brain abscess; also here belongs puerperal fever, or, under certain circumstances, it may possibly be malaria.

But the continued observation of the course of the temperature is of still greater importance. It advances medical knowledge in various ways:

1. The course of the fever in a number of diseases is so typical that from the temperature alone the diagnosis may often be made with great probability, sometimes with certainty. At any rate it is always, taken in association with other symptoms, an important aid in diagnosis.

2. Moreover, during the progress of a febrile disease, the temperature not infrequently gives notice, by its unusual behavior, of the occurrence of an unusual event. Hence, not infrequently, we first become aware of an exacerbation or of a complication in a given disease by a specially high rise of the temperature. A sudden fall of the temperature may give notice of collapse, or a change to a fatal issue, or an internal hemorrhage, as of the bowels in typhoid fever.

In the following the most important typical courses of fever are briefly set forth :

1. Continued fever exists especially in two diseases : Typhoid fever and croupous pneumonia; also in typhus fever, sometimes in erysipelas and miliary tuberculosis. In a case of severe fever, with the diagnosis doubtful, a fever continued through several days points with probability to typhoid fever; and next to acute miliary tuberculosis.

In abdominal typhus [typhoid fever] the fever rises for several days by equal steps, "initial period"; reaches the summit, at which it remains as a continued fever one, two, or more weeks; then it, as a rule, gradually becomes a remittent fever, of such a character that at first the daily maximum remains high, with the minimum going lower ("the double stage" ["the long-continued paroxysm"])—the minimum may even go below the normal); then the defervescence begins,

FIG. 1.

Day of illness: 1 2 3 4 5 6 7 8 9 10 11 12 13 14 15 16 17 18 19 20 21 22

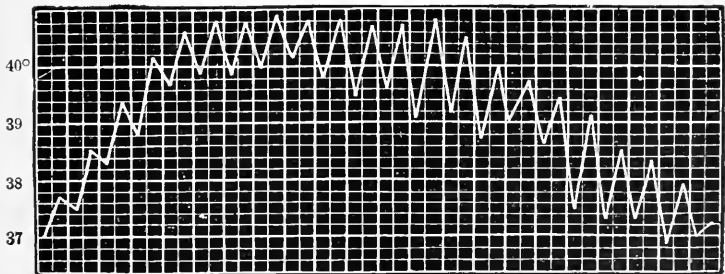

Initial period.

Acme.

Defervescence.

Fever-curve of a regular mild typhoid fever. (WUNDERLICH.)

the maximum declining; this usually reaches the normal in a few days. The remittent and defervescence stages may be protracted for

some time, even as much as a week: "slow typhus." Moreover, the temperature may, after it has somewhat declined, again rise: "recurrence"; or the disease, after the temperature has reached the normal, may begin anew, in the same manner as at first: "renewing" (see regarding these points Figs. 1, 2, 3).

FIG. 2.

Day of illness : 19 20 21 22 23 24 25 26 27 28 29 30 31 32 33 34 35

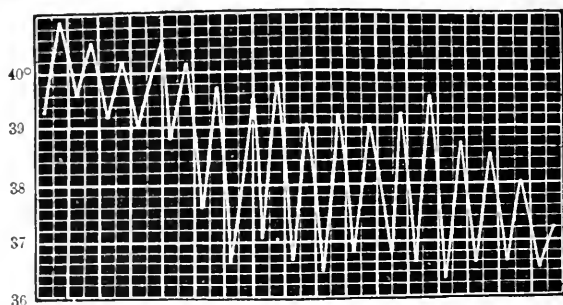

Long-continued paroxysm of typhoid fever.

There are all manner of variations from this behavior of the temperature in typhoid fever, so that a single case seldom really pursues a typical course. Particular variations partly declare themselves by

FIG. 3.

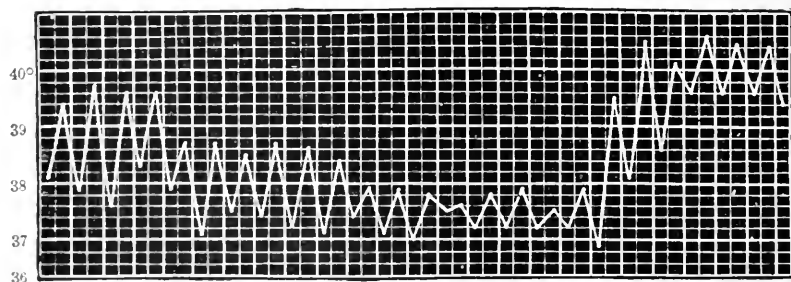

First attack.

Defervescence.

Second attack.

Typhoid fever, with recurrence of fever.

the earlier change of the temperature to the changeable character, mentioned on page 67; but the fever-curve will especially be affected

by the administration of antipyretics.¹ But, particularly, every exacerbation of the temperature should cause the physician to think of complications, and a fall of the temperature, of collapse, and also of possible intestinal hemorrhage.

In pneumonia (see Figs. 4 and 5) the temperature rises very rapidly ("initial period," lasting a few hours), often accompanied by chill, then remaining as a high continued fever. From this it may decline, also very rapidly—in a few hours—to or below the normal, with a simultaneous decline of the pulse and the respiration, and generally with severe sweating. Or the defervescence may be some-

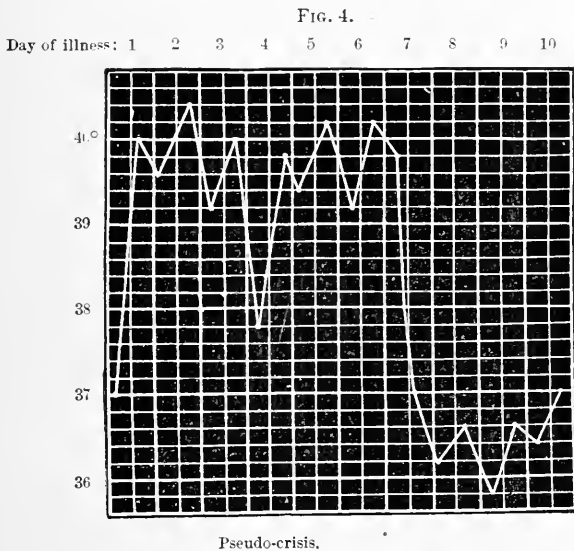

Fever curve of croupous pneumonia. (STRÜMPPELL.)

what slower, occupying one or two days. The former way is called "crisis" (critical sweat), the latter "lysis"; midway between these two is "protracted crisis."

Sometimes the day before the crisis the temperature suddenly falls very rapidly, and then again rises—"pseudo-crisis" (distinguished

¹ The antipyretic treatment, especially with internal remedies, has, no doubt, the result of rendering the course of the fever untypical, and so destroying its diagnostic value. Therefore, until the diagnosis has been established in a case of febrile disease, the internal antipyretic treatment ought, if possible, to be suspended.

from collapse by the pulse and the general condition, as referred to under "the subnormal temperature"). Or there is exacerbation of the temperature just before the crisis, rising from, say, 40° to 41° C. — "critical perturbation."

FIG. 5.

Day of illness: 2 3 4 5 6

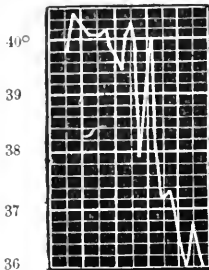

Pseudo-crisis and crisis in pneumonia. (WUNDERLICH.)

FIG. 6.

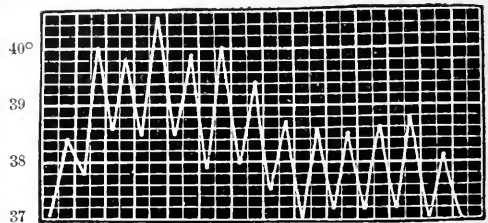

Remittent and intermittent fever (catarrhal pneumonia). (WUNDERLICH.)

2. *Remittent fever* is often met with. It may exist some time during the course of any febrile disease. While the temperature of continued fever is generally high—about 40° —the fever may remit, whatever its height. If the maxima are low, the minima may easily be normal—a behavior which, strictly speaking, must be considered as intermittent fever. Remittent fever belongs especially to chronic tuberculosis.

FIG. 7.

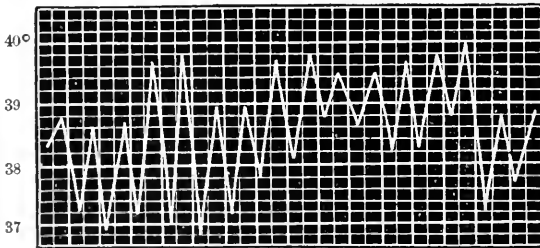

Hectic fever in tuberculosis of the lungs.

If the maximal points of the curve are high, the temperature often falls pretty rapidly, accompanied with chills and night-sweats (*hectic fever*). Similar conditions are observed in *the fever of pus-formation*.

3. *Intermittent fever*, in a general sense, occurs in combination with remittent fever (see Fig. 7). The hectic fever mentioned above as accompanying remittent typhus [relapsing fever], is often also an intermittent, in which the minimum may even be subnormal.

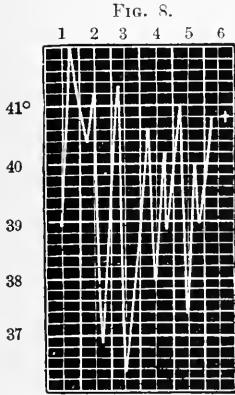

Pyæmia with rapidly fatal course.
(WUNDERLICH.)

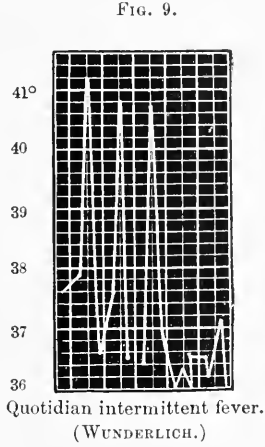

Quotidian intermittent fever.
(WUNDERLICH.)

A peculiar form of intermittent fever is observed in pyæmia, where the temperature during chill may rise two, three, or more times in twenty-four hours, and soon fall, with sweat and great exhaustion,

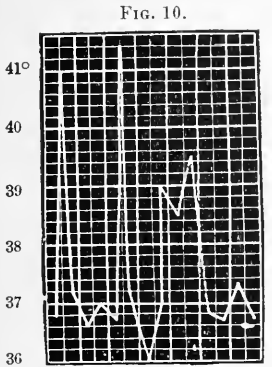

Tertian intermittent fever.
(WUNDERLICH.)

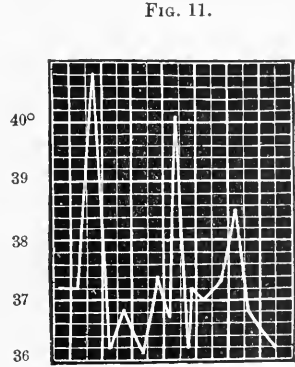

Quartan intermittent fever.
(WUNDERLICH.)

then again rising. The pulse is generally very frequent, and the patient often gives the impression, by the great prostration during the

sweating stage, of going into collapse; in fact, a condition of collapse sometimes exists with the fall of the temperature (see Fig. 8).

In a narrower sense, however, we designate as *intermittent fever* the course of temperature of a special form of malaria. In this there is a continual alternation between times without fever (apyrexia); a quick, high rise, and, after a short time, again, a rapid fall of temperature (often below normal)—“fever paroxysm.” Severe chills and perspiration accompany these attacks of fever. The attacks recur with great regularity, either every twenty-four hours (quotidian), or forty-eight hours (tertian), or seventy-two hours (quartan). Sometimes the attacks recur one or more hours earlier on successive days (anticipating), or they may recur later each time (postponing). In these forms of fever the diagnosis is made certain by the fever-curve (see Figs. 9, 10, 11).

FIG. 12.

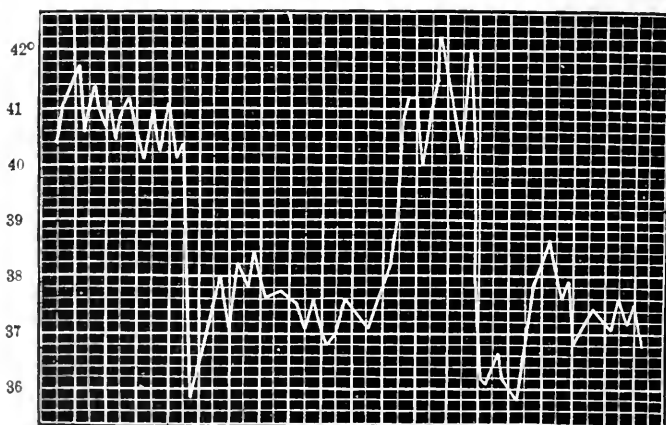

1. Apyrexia. 1. Relapse. 2. Apyrexia.
 Febris recurrens. (WUNDERLICH.) Compare p. 69.

4. *Recurrent fever* only exists as a renewal of a febrile disease, or a disease known as *relapsing fever*. There is an attack of fever very like that of pneumonia, with sharp transitions and very severe sweating, the temperature falling often to 34° or 35° C., and apyrexia; then a relapse after five to eight days, with a chill, followed by a high continued fever, which, in turn, ends in five or six days by a critical

sweat; new apyrexia, fresh relapse; and so, over and over again, but each new attack with less fever and of shorter duration.

5. Not infrequently a quite irregular fever will be met with. Its course is such that sometimes one cannot speak of any daily remission—at least, the lowest daily temperature comes at a variable hour of the day or night. But this fever may be of diagnostic value. In acute meningitis a continuing irregular movement of the temperature speaks against tuberculosis and against ordinary purulent meningitis, but, on the contrary, for epidemic cerebro-spinal meningitis. Again, a pronounced irregular fever in an acute disease in general speaks against any of those diseases which manifest themselves by any typical fever.

6. *Local Elevation or Lowering of the Temperature.*

1. *Elevation of the temperature.* In internal medicine this is seldom of diagnostic aid. We meet it where there is any kind of inflammation which is near the surface, as in surgery. In unilateral pneumonia, also, a careful measurement shows an elevation of the temperature in the axilla of the affected side. In recent paralysis of any sort the temperature of that side is somewhat higher for a short time; then the temperature usually falls. Rare cases of hysteria exhibit a one-sided elevation of temperature with redness of the skin and perspiration.

2. *Lowering of the temperature.* This is the expression of local disturbance of the circulation. In heart-failure, also in collapse and near-approaching death, the extremities and also the nose become cool. Coolness of the affected limb is observed in venous thrombosis, in paralysis of long standing in consequence of diminished venous blood-current, and in arterial embolism and thrombosis.

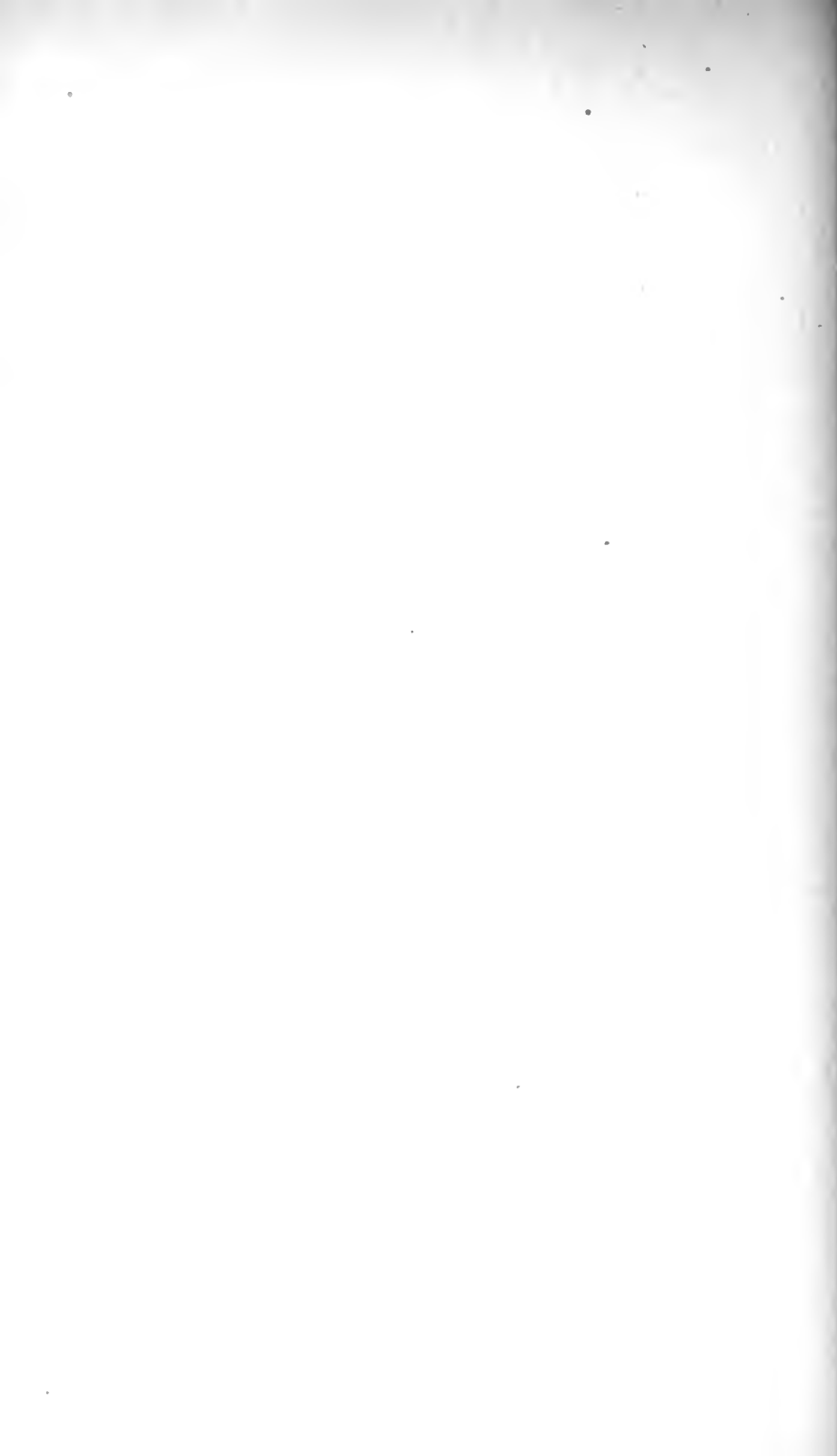

PART III.

SPECIAL DIAGNOSIS.

CHAPTER IV.

EXAMINATION OF THE RESPIRATORY APPARATUS.

EXAMINATION OF THE NOSE AND LARYNX.

1. *The Nose.*

INSPECTION of the nose sometimes reveals diseased conditions which concern the bony structure, and, therefore, belong to surgery: deformities, fistulæ, ulcers, with deeply-seated destructive process at the root of the nose.

Only one of these conditions has interest for us as physicians: the so-called saddle nose, arising from necrosis and removal of a part of the bony framework of the nose, is an almost infallible sign of constitutional syphilis.

Swelling and redness of the nostrils indicate inflammation of the nasal mucous membrane. Not infrequently we also see traces of a muco-purulent or purulent, sometimes an ill-looking bloody, serous secretion; the latter is sometimes offensive in odor.

Patients with obstructed nose (with severe catarrh or tumors) breathe through the mouth. On the other hand, in severe dyspnœa (*q. v.*) there is likewise motion of the *alæ nasi*.

Epistaxis shows itself most plainly by the flow of blood from the nose. However, when persons are entirely unconscious or healthy persons are asleep upon the back, the blood flows backward into the pharynx or even into the stomach. Then the hemorrhage may be overlooked, or the first symptom of epistaxis may be *vomiting of blood*.

In all important diseases of the nose it is necessary to make use of the nasal speculum. (For the use of this in examinations, see the Appendix.)

Palpation of the interior of the nose may be necessary (see works upon Surgery).

Acute muco-purulent and purulent catarrh of the nose is symptomatic in measles, diphtheria, and equinia. Chronic catarrh is a common symptom of scrofula (in which disease the whole nose is often swollen) and of syphilis. In the former disease there is sometimes an inflammatory thickening of the whole nose, particularly of its lower walls. Inflammation of an acute form, with very foul-smelling and ill-looking secretion, most frequently indicates diphtheria of the nose and pharynx.

2. *The Larynx.*

The larynx is examined with reference to its functions (voice, cough, breathing) and the local appearances; the latter includes the external and internal examination (see also under Sputum).

(a) THE FUNCTION.—The voice is changed in all affections of the larynx. It may be muffled, rough, hoarse, even to the entire loss of voice—"aphonia." In severe diseases it may have a whistling or sibilant (strident) quality: This indicates stenosis of the larynx; or it is very hoarse and deep: this points to deep-seated ulceration.

In diseases of the larynx the cough is hoarse, loud, or barking. In extensive destruction and in certain paralyses of the crico-arytenoid muscles, cough is either more difficult or is impossible, since the power to close the glottis preceding the cough, as is normally the case, is wanting (see Cough).

Breathing is obstructed in all conditions that narrow the larynx, as in inflammation resulting in hypertrophy, in new formations, in scars with contraction. Then there is an inspiratory and expiratory dyspnoea (which see), and a peculiar noise of stenosis, "stridor laryngeus." In marked stenosis, especially when the thorax is weak, as in children, there is a drawing-in of the lower part of the thorax in front, in the region of the insertion of the diaphragm (see the chapter on Anomalies of Respiration).

Stenosis only in inspiration, causing inspiratory dyspnoea, is ob-

served in paralysis of the crico-arytenoid muscles, the dilators of the larynx.

Laryngeal stenosis is distinguished from tracheal stenosis at the first glance, in that in the former condition the larynx moves up and down with each breath, and the neck is stretched to the fullest extent, while in the latter the larynx remains quiet and the head is always somewhat bent forward.

(b) LOCAL EXAMINATION.—*The external examination* is made with reference to pain, to deformities revealed to the sight or touch (these are very rare, resulting from destruction by periostitis), and laryngeal fremitus.

Laryngeal fremitus is a trembling of the thyroid cartilage during speech. It is stronger or weaker on one side in unilateral paralysis. It has no special diagnostic value.

The internal examination. By great care, and in the case of patients who have themselves under good control, sometimes the entrance to the larynx and the tissues even as far as the glottis can be *touched*. This method, however, has now little value, since it has been entirely superseded by the examination with the laryngeal mirror, which is the best means of examining the larynx. (Regarding its use see the Appendix.)

In inflammatory conditions, patients complain of pain in speaking, but sometimes, even with severe disturbances, there is no pain; now and then there is dyspnoea, especially on exertion. *Pain in swallowing* in chronic diseases of the larynx frequently indicates serious conditions: extension of new formation (carcinoma) toward the œsophagus, or destructive suppuration.

The leading *symptomatic indications* of diseases of the larynx with reference to other possible internal diseases, are as follows: acute laryngitis, with manifestations of an acute infectious disease, points especially to measles, croup (and also to smallpox). Chronic laryngitis points to tuberculosis and syphilis; to constriction by scars, to syphilis. Of *paralyses*, paralysis of the recurrent nerve is of special diagnostic importance, since it often arises from *pressure upon nerves*, especially upon the left side from aneurism of the aorta, carcinoma of the œsophagus, tumors of all kinds in the mediastinum. Certain paralyses indicate hysteria.

EXAMINATION OF THE LUNGS.

TOPOGRAPHICAL ANATOMY OF THE LUNGS.

For localizing the surface of the chest with reference to height and depth we make use partly of anatomical prominences and partly (for determining the breadth) of certain local lines which we think of as drawn upon the surface of the thorax.

Upon the front side of the thorax are the important anatomical regions: the fossa supraclavicularis (above the clavicle and bounded by the sterno-cleido-mastoid and trapezius muscles) and the fossa infraclavicularis. The latter has no distinct lower boundary. We understand it as the region immediately below the clavicle, about as far as to the second rib. From the second rib downward we designate the height by the ribs and intercostal spaces: as above the fourth, under the fourth rib, the fourth intercostal space. The number of the particular rib is determined by counting from the second rib downward. It is always easy to find this rib: it is in articulation with the sternum exactly where the manubrium and corpus sterni unite, ordinarily forming a very slight angle (*angulus Ludovici*), and this place is plainly to be felt, and often seen, as a cross-line or prominence. We feel for this prominence and find the second rib to be its prolongation. We count the ribs from that downward, feeling somewhat obliquely outward as we go down. Morenheim's depression [the outer part of the infraclavicular depression] and the so-called Sibson's furrow (the under border of the pectoralis major) are sometimes, although not very practically, useful as points for locating internal organs.

For determining the breadth the vertical lines now to be mentioned are useful (the subject is supposed to be standing): the middle line, drawn through the sternum; the two sternal lines, drawn parallel along the sides of the sternum; the mammillary lines, drawn through the male nipple; and the parasternal lines, drawn midway between the sternal and the mammillary lines.

On the two sides we determine the height by the ribs, which we count in front; and the breadth by the middle axillary line (drawn through the middle of the axilla, the arm being extended sidewise), the anterior and posterior axillary lines (drawn perpendicularly from

the points where the pectoralis major and latissimus dorsi muscles leave the thorax, with the arm raised sidewise to the horizontal).

Upon the back, we name the fossa supraspinata; above that, the suprascapular space; the fossa infraspinata; the interscapular space, between the two scapulæ; the infrascapular space, under the shoulder-blades. Exact determination of height is made by counting the ribs, which, however, are difficult to count, especially in fat persons. They can be determined by three methods:

(a) By counting the vertebral prominences from the vertebra prominens (the seventh cervical).

(b) By counting from the lower angle of the scapula; this overhangs the seventh rib in the average person when the shoulders hang comfortably and the arms rest against the chest with the fore-arms folded lightly.

(c) By the point of the twelfth rib, which is easily felt (the best way for the lower ribs).

Moreover, we have the scapular line, which is drawn upon the two sides of the spine through the lower angle of the scapulæ (at the point already mentioned under (b)).

It is to be observed that some of the vertical lines are not determined exactly. This is true regarding the mammillary line (always very important) more than any other. In women it is generally very variable. On this account it is always to be thought of as drawn upon a male thorax. But even in the male the nipple is an uncertain point. By much practice the eye is cultivated so as to recognize what is to be regarded as the average location of the nipple in the male, and by this we must always correct the mammillary line. The attempts to substitute other lines for this one have not been accepted.

The designation "infrascapular space" is little used. The expressions, "right, left; behind, below," correspond to it, and are much to be recommended: behind or below the right, the left, scapula.

THE ANATOMICAL BOUNDARIES OF THE LUNGS WITH REFERENCE TO THE THORAX.

In front the lungs reach to the sixth, and behind to the tenth, rib, and are almost everywhere directly in contact with the chest-wall. They are not in contact with the chest-wall in the neighborhood of the heart nor behind a small portion of the upper part of the sternum.

The accompanying figure exhibits the anatomical boundaries of the lungs. They project with their summits into the fossa clavicularis from three to five cm. above the clavicle, and with their inner anterior borders converging downward, so that behind the *angulus Ludovici*, not exactly behind the middle of the sternum, but a little to the left, they come to lie very close to each other; then they continue parallel

FIG. 13.

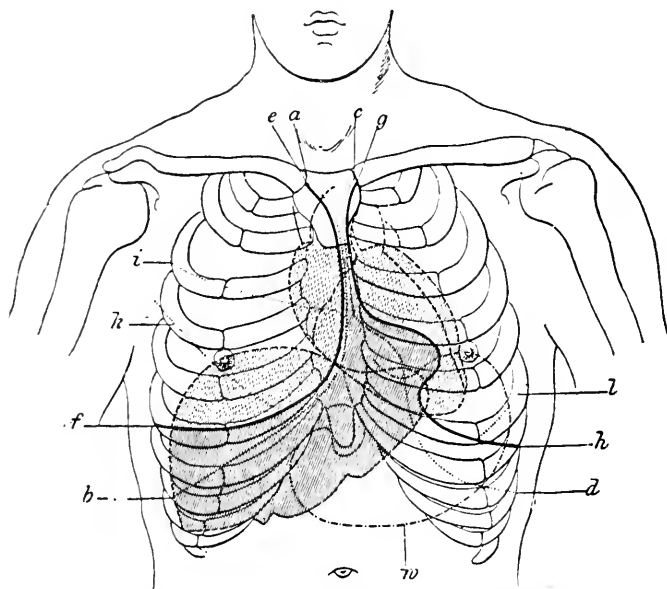

Position of the thoracic viscera, of the stomach and of the liver, from in front. The portions of the heart and liver which are drawn with unbroken hatched lines represent the parietal portions of those organs. The portions that are not in contact with the chest-wall, but are covered by the lungs, are represented by broken (clear) hatched lines. The line *c, f*, border of the right lung; *g, h*, border of the left lung; dotted lines (.....) *a, b* and *c, d*, the boundaries of the complementary pleural space; *i*, the boundary between the right upper and middle lobes; *k*, the boundary between the right middle and lower lobes of the lung; *l*, boundary between the left upper and lower lobes; *w*, greater curvature of the stomach. (WEIL-LUSCHKA.)

downward to the insertion of the fourth rib. From there the inner border of the right lung proceeds still further downward to the top of the insertion of the fifth rib, then gradually bends toward the right so that it follows along the sixth rib, on the upper border of which it meets the mammillary line. Then it continues approaching the hori-

zontal (in the upright posture) so that it lies, in the middle axillary line, upon the seventh or eighth rib, in the scapular line upon the tenth rib (this location on the dead body is about one cm. higher than in quiet respiration in the living subject). On the left side, the border of the lung bends sharply round from the fourth rib to give place to the heart, continues behind the fourth rib as far as the left

FIG. 14.

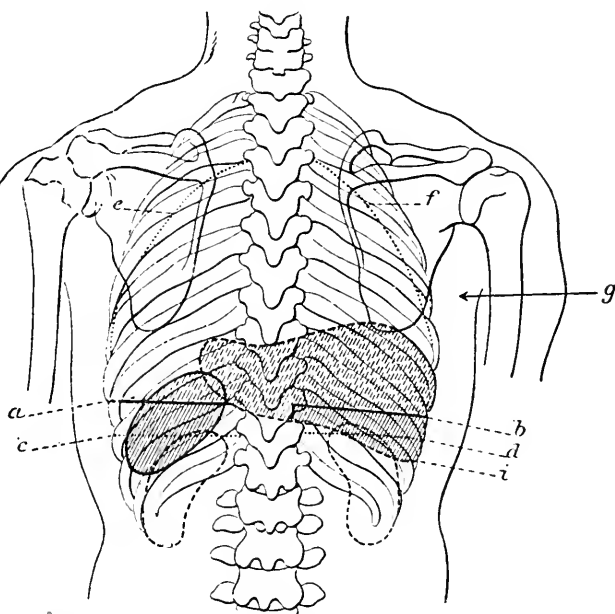

Position of the lungs, liver, spleen, and kidneys, seen from behind. The liver and spleen are represented by the same hatching as in Fig. 13. *ab*, the lower border of the lungs; *cd* (.....), complementary space; *i* (dotted line) (broken line), border of the liver; *ef* (dotted line), boundary between the upper and lower lobes of the lungs; *g*, boundary between the upper and middle lobes of the right lung. (WEIL-LUSCHKA.)

parasternal line, then bends vertically downward, making a small bow, which converges toward the right; then sharply bending again behind the sixth rib so as to pass the mammillary line under the sixth rib (hence, somewhat lower than on the right side), it passes the axillary line between the seventh and eighth, and the scapular line at the tenth, rib.

The boundaries of the lungs are different according to age, as well as in individuals. (See section on Percussion of the Lungs.)

The boundaries of the pleural sacs—that is, the lines on which the pleura costalis (sternalis) leaves the wall of the thorax and bends inward—agree in reality with the course of the inner borders of the lung. But along the lower borders of the lungs and at the cardiac concavity the pleural space extends considerably beyond the border of the lungs (in quiet breathing), making the sinus phrenico-costalis and the complementary pleural sinus. The size of these corresponds with the form. The largest is the complementary pleural sinus in the two axillary lines. This is there about ten cm. high.

The pleural sinuses are therefore important, since into them extend the lungs at every deep inspiration and also in the pathological, chronic inflation, emphysema pulmonum; and also, because in them fluid effusions into the pleural cavity ordinarily first accumulate.

The under surface of the lungs rests directly upon the diaphragm. The diaphragm in the dead body rises at its highest part, as a dome, about as high as the insertion of the fourth rib, a little higher upon the right than the left side. The average situation of the dome of the diaphragm in life, during quiet breathing, is a little lower.

Finally, it is necessary to mention the course of the boundaries of the lobes of the lungs, since they sometimes have an important part in diagnosis: at the back, near the spine, the boundary between the upper and lower lobes is at the height of the lower angle of the scapula; upon the left it gradually slopes forward and outward in such a way that in the axillary line it stands at the fourth rib, and meets the lower border of the lung (that is, at the sixth rib) in the mammillary line. On the right side the boundary-line divides near the outer border of the scapula into two diverging lines: the line between the upper and middle lobes and that between the middle and lower lobes. The former proceeds at first behind the third rib, and terminates at the inner border of the lung at the insertion of the fourth rib; the latter meets the lower border of the lung somewhat within the mammillary line, and, therefore, behind the sixth rib.

Hence, in front upon the right side, we have the upper lobe; about at the third intercostal space, from there downward really the middle lobe; in front on the left side, for the whole distance we really have the upper lobe; on the side at the right, we have the middle lobe above and the lower lobe below; on the side at the left, we have the lower

lobe; behind we have only the apices, formed by the upper lobes; all the rest is lower lobe.

INSPECTION OF THE THORAX.

The examination of the thoracic organs must always begin with the inspection of the thorax. Nothing is more faulty than to take up some other method of examination first. Inspection of the thorax is important because a very large number of the diseases of the lungs and pleura manifest themselves in the form of the chest cavity and a change of the respiration. Certain diseases of the internal organs have a causal relation to changes in the form of the thorax. In other cases, as it appears, a given form of thorax accompanies a "disposition" of the lungs to certain diseases (emphysema, phthisis). It is very probable, although it is difficult positively to establish, that sometimes the thorax by its form either causes or favors the development of the given disease. Moreover, we know that there are deformities of the chest which in other ways injure or render useless the thoracic organs; there are such, also, as have no influence upon the lungs or heart.

Method of procedure. During inspection (as in all examinations of the thorax) attention must be given to having the patient straight, but without undue muscular tension. The light should fall symmetrically upon the front or back, whichever is under examination; the eyes of the examiner should, if possible, be directly before the middle line of the body. The general structure of the thorax (and neck) should first be considered, next possible peculiarities, then the motions of respiration, first during quiet, then deeper, respiration.

1. *Normal Form of Thorax and Normal Respiration.*

In a well-constructed thorax we expect, first, perfect symmetry (this is departed from almost always normally, in that there is a very slight curvature of the dorsal vertebræ toward the right). Moreover, the clavicular depressions may only be indicated; the angulus Ludovici [also called the angle of Louis] (the angle formed by the junction of the manubrium and corpus sterni) may just be recognizable; the true ribs should so leave the sternum that from the top downward there

is increasing obliquity, making the angle formed by the two opposite bendings of the ribs. "the epigastric angle," almost a right angle; the thorax should be well developed; the scapulæ should, in the upright position, lie flat upon it; the intercostal spaces should be visible only at the lower ribs; finally, the dimensions of the chest and the size of the body should have a certain relation to each other. Very seldom does the normal thorax correspond to this ideal, and there are many departures from it in persons who are perfectly sound. Such "physiological" departures may be mentioned; a slight asymmetry in a gradually-acquired spinal curvature or a deformity of the ribs self-established: further, a peculiar form of thorax, where the upper part is somewhat shallow, but the lower of increasing depth, so that the lower aperture of the thorax is very large: also more marked angle of Louis (Braune); again, in a shorter thorax, a more acute epigastric angle may sometimes be observed in healthy persons (hence, also, without signs of emphysema. see below). The supra-clavicular depressions are often both deepened, with the apices of the lung entirely normal (unequal deepening of them is, however, very suspicious of tuberculosis. see below); single ribs. more frequently the second, third, also the fourth, sometimes on account of greater curvature, project more in front; on the other hand, the lower ribs will often be found pressed into the side and from there flattened forward, and other variations. The boundary between the unsymmetrical and the pathological form of chest is much confused; it can only be recognized in the individual case by attention to the location and function of the thoracic organs.

Normal breathing takes place in this wise: inspiration only is active, that is, is accomplished by muscular action; expiration, on the contrary, is produced wholly by the elasticity of the lungs, the weight of the chest wall, and the pressure of the abdominal organs upon the diaphragm. The number of respirations to the minute in the newborn is about 44; at five years, about 26; from the twentieth year, about 16 to 20. It is very easily influenced by a number of conditions: in sitting and standing it is somewhat higher than in lying; it is increased by bodily activity and psychical impressions. Therefore, it can only be determined during perfect quiet, with the attention withdrawn from the examiner, or during sleep. For counting

it, it is generally most advantageous to lay the hand lightly upon the chest (or upon the epigastrium).

The breathing is generally regular, and the single breaths of equal strength; but under the influence of the slightest psychical disturbance it easily becomes irregular and unequal. Many persons of sound health, as snorers in sleep, often breathe irregularly or unequally deeply. Breathing is either exactly or very nearly symmetrical, though the left side frequently inclines to breathe a trifle stronger.

The *inspiratory enlargement of the thorax* is occasioned by the elevation of the ribs and the sternum, and the simultaneous drawing of the former upward and outward (intercostales externi and interni muscles—“*costal breathing*”); moreover, by the contraction of the diaphragm, and, hence, flattening of its dome. The latter movement, at the same time, draws down the intestines, and so with every inspiration the whole anterior wall of the abdomen projects, but especially the epigastrium (diaphragmatic, or abdominal, breathing). The combination of costal and diaphragmatic breathing varies in the two sexes in that in the male the latter, and in the female the former, preponderates. But in aged females, with firm thoracic walls, diaphragmatic breathing increases; while, on the other hand, male as well as female children incline to the costal type of breathing. From this it seems that the degree of flexibility of the thorax influences the kind of breathing.

In the costal breathing of women, even in quiet respiration, the scaleni muscles (elevators of the first and second ribs) take a part; while in men these muscles belong to the auxiliary muscles of respiration (see below).

2. *Pathological Forms of Thorax.*

(a) *The inflated or emphysematous thorax.* This refers to a chronic symmetrical expansion in all directions, conforming somewhat to the form of the chest during inspiration (the inspiratory position). The antero-posterior (the sterno-vertebral) diameter is increased. In many cases it appears as if the thorax became enlarged, especially at about the height of the middle of the sternum, making a barrel-shaped chest; however, this may be entirely wanting. The ribs are generally strong, and are at right angles to the sternum, hence the epigastric

angle is larger than normal; the thorax is generally short. Frequently the angle of Louis is very prominent.

The supra-clavicular depressions may vary very much; sometimes they are deepened, again, shallow or even projecting like pillows (the latter condition obtaining in emphysema of the upper part of the lungs). The lower intercostal spaces are sometimes drawn in during inspiration.

In the emphysematous thorax the breathing is so changed that the expiration is both slower and imperfect in consequence of the diminished elasticity of the lungs; it is prolonged, and, in marked emphysema, it is assisted by muscular action, especially by the transversus abdominis and the quadratus lumborum. We can then plainly see the abdominal wall energetically flattened, and we are directly impressed with the idea that the thorax is forcibly expanded. But the inspiration is also altered in consequence of the rigidity of the chest-wall; ordinary costal breathing is wanting; it is very imperfect: and in its place we notice that the front of the chest, as a whole, has been drawn up by the powerful action of the sterno-cleido-mastoidei muscles. Consequently, in emphysema we have the breathing rendered difficult; in severe cases it may become so to a high degree (see *Dyspnœa*).

The typical emphysematous thorax points almost with certainty to emphysema, and hence its name; however, we must guard against the mistake of calling every short chest an emphysematous one. On the contrary, also, we not infrequently find a general emphysema of the lungs in a chest that has no trace of the "emphysematous" form. Active expiration, expiratory dyspnœa, is much more characteristic than the form of the thorax; besides emphysema, it exists in no other condition except certain diseases of the larynx (see *Dyspnœa*).

(*b*) *The paralytic or phthisical thorax.* This is the direct opposite of the preceding: it is flat, especially in the upper part; is often also narrow; the intercostal spaces are wide; the ribs are generally delicate, are sharply inclined downward from the sternum, and, hence, must be bent at a sharp angle again in order to come back to the vertebræ. This sloping from the sternum makes the epigastric angle very sharp; the chest, as a whole, chiefly in consequence of the course of the ribs, is long. The angle of Louis is often very marked.

The depressions are generally deep. The shoulder-blades frequently stand out like wings.

Quiet breathing may be almost normal; by exertion it is generally immediately very much increased in frequency; it is shallow; even in women the costal type is often wanting, especially at the upper part of the chest.

This form of chest corresponds with that of tuberculosis. A well-marked paralytic thorax, except where phthisis of the lungs has early developed, is very infrequently seen; but yet this disease occurs very often where the phthisical thorax is wholly absent—indeed with an emphysematous thorax. In a paralytic thorax, with phthisis already developed, by means of the latter the form of the thorax and the breathing will become essentially and variously changed. See above under (*a*) and below under (*d*).

But one must be very careful not to conclude that a thorax narrow from great emaciation, and especially one that appears flat, is a paralytic one. For example, a beginner is apt to find that a patient convalescent from typhoid fever has a paralytic chest. Strictly speaking, also, every plain or flattened thorax is not to be called a paralytic one. Moreover, emaciation and flattening of the upper parts of the chest, in cases of developed phthisis, frequently render the thorax paralytic, which it originally was not.

(*c*) *One-sided expansion of the thorax*, a relatively infrequent affection, occurs in disease, or functional loss, of the opposite lung. The dilated side is then the seat of the so-called “vicarious emphysema” of the lung. This is distinguished from true emphysema by the absence of expiratory dyspnoea.

The dilated side is much more frequently the diseased one. The widening of the chest-cavity is more plainly seen from the front than from behind. Very frequently the mamma and the scapula are further removed from the median line than upon the normal side. The intercostal spaces are level or are projecting; in contrast with this, the diseased side drags after the other—that is, in inspiration it rises later and less than the sound side, and it may even not rise at all. Hence, the spinal column is sometimes bent toward the diseased side.

Marked expansion is met with in pneumothorax and in extensive pleuritic exudation; while the development of the latter usually first

manifests itself by expansion and lagging behind at the posterior and lower part of the chest. A very slight expansion of one half of the chest is, moreover, sometimes seen in croupous pneumonia of the whole of the affected lung.

Circumscribed forward expansion of the chest occurs especially with tumors of the pleura, and is sometimes humped, and, again, uniform; empyema which inclines to breaking through, pushes the affected region prominently forward, and, at the same time, the skin is generally œdematous. Encapsulated pleuritic exudations or circumscribed pneumothorax seldom cause expansion, yet the first causes a smoothing out of the neighboring intercostal spaces, besides lagging behind. Local projections, moreover, occur not infrequently from inflammatory affections of the ribs or the subcutaneous cellular tissue.

Local expansions of the thorax are seen in cases of enlargement of other organs. The cardiac region may be bulged out in enlargement of the heart or distention of the pericardium (see under Examination of the Heart); a marked enlargement of the liver may press out the lower ribs on the right side, and enlargement of the spleen on the left; and sometimes, especially in children, a very marked expansion of the whole lower part of the thorax, an enlargement of the lower aperture of the chest, is observed in cases of considerable expansion of the whole, or the upper part, of the abdomen (meteorismus, ascites, peritonitis, tumors). Then the upper part of the chest seems quite small in comparison with the lower part; the whole trunk is, hence, shaped like a bee. From the drawing up of the diaphragm there results interference with diaphragmatic breathing, and generally there is severe dyspnoea.

It is very important to remember that the expansion of the chest, especially that caused by pleuritic exudation, varies with the flexibility of the thoracic wall. If the wall is soft, as is the case with children, the expansion is very pronounced; if rigid, as in subjects of emphysema, sometimes a very large pleuritic exudation causes no noticeable expansion. Therefore, while we expect in general that an extensive pleuritic exudation will manifest itself by an enlargement of the affected side of the chest, yet, where the walls are rigid, we must not conclude from the absence of expansion that there is no exudation.

(d) *Drawing-in or shrinking of one side.* This is seen more or less frequently as a symmetrical drawing-in of the whole side, so that

the affected side is altogether smaller than the other; the ribs are close together, and in the lower part they may even overlap, like shingles on a roof. The shoulder of that side hangs down; the mamma and scapula are nearer the median line. The *spinal column* is curved with its convexity toward the healthy side; hence, the whole carriage is affected. There is diminished breathing, or no breathing at all, on the side drawn in; on the healthy side, there develops a vicarious emphysema. This condition is observed in recovery from extensive pleuritic exudations, and in long-continued contraction of the lungs.

In pleurisy, it is the loss of elasticity and thickening of the pleura, with adhesions of pleural surfaces, in shrinking of the lungs, and the development of connective tissue in the lungs, which not alone hinder the lungs from following the inspiratory expansion of the thorax, but from the tendency to contract, as in scars of the skin, draws in the chest-wall. This inward traction, however, does not concern the thorax alone: the mediastinum, heart, and diaphragm are pulled toward the sunken side. Hence, there is displacement of the heart toward the diseased side, and the diaphragm is high in the chest.

More frequently there is an unequal degree or a partial shrinking on the affected side; with it also is always connected a more or less marked lagging. It is most frequently observed above in front, here sometimes noticeable at the first commencement as a deepening of the supra-clavicular depression (an important symptom of contraction of the apex of the lung from tuberculosis). Again, a partial drawing-in is often seen, most frequently low down posteriorly, after the disappearance of a small pleuritic exudation. But there may be shrinking of any part of the chest-wall, as after gangrene and abscesses of the lungs.

One must be careful not to confound a deformity of chest from disease of the thoracic organs with deformities that are dependent on a primary bending of the spine and thorax. Concerning these, see the following section.

A repaired fracture of the ribs may also cause deformity; a fracture of the clavicle which has healed with an angle forward may deepen the supra- and infra-clavicular depressions, and so deceive one; one-sided defect or atrophy of the pectoralis major, of course, flattens that side. All of these cases may be excluded by a more careful examination.

(e) *Expansion or retraction of the chest by primary deformity of the skeleton.* Kyphosis, or bending backward, and scoliosis, the bending sidewise of the spine, but, still more, the combination of both, *kyphoscoliosis*, occasion sometimes deformities of the chest that are enormous. Most frequently one side is smaller in front, while the other side appears as if enlarged; and the picture of one-sided contraction of pleura or lung is more complete from the dragging-after of the smaller side. In consequence of a peculiar twist of the spine and its effect upon the course of the ribs, the back is generally very crooked. This is spoken of more particularly in works upon surgery. Whether we have to deal with a primary deformity of the chest or with a contraction of the lung or pleura is generally made clear by the examination of the spine; in rare cases, however, this, and even the minutest examination of the thoracic organs, does not give a positive diagnosis. Moreover, the thoracic organs are almost always much displaced; the lungs are in part functionally very much disturbed. These patients have short breath on the least exertion; and in case of disease of the chest organs, especially in acute infectious diseases, are more in danger than others. The distinction of the different kinds of spinal curvature and their origin belongs to surgery.

Rhachitis is frequently the cause of such deformities, but it may also cause all other possible bendings of the chest. Of these especially characteristic are: 1. *The rhachitic chest*, a thickening of the point of transition from the cartilage to the bony ribs. The several prominences arising from it form on both sides of the sternum a line passing as an arch outward and downward. 2. *The pigeon-chest.* The chest seems to be compressed sidewise and pressed forward. The ribs run sharply backward from the front, so that the sternum stands forward like the keel of a ship, the sterno-vertebral measurement being much increased. 3. *A circular drawing-in* in the neighborhood of the costal attachment of the diaphragm. The ribs, as is well known, form a fixed point for the diaphragm; if, as in rhachitis, the chest is abnormally yielding, it is drawn inward by the contraction of the diaphragm, and this especially is the case if there is increased action of the diaphragm—that is, if from any cause there is difficulty of breathing.

Funnel-breast (Fig. 15). This deformity consists in a sinking-in of the sternum, especially of the lower portion of it; it may be

very considerable (as much as seven cm.). The affection is generally congenital, and, according to our experience, in very marked cases it may prove a hindrance to respiration. *Shoemakers'-breast* exhibits a sort of acquired funnel-breast, caused by pressure of tools against the lower part of the sternum and the xiphoid cartilage: the depression never becomes very great, and involves only the cartilage; it has no pathological significance.

FIG. 15.

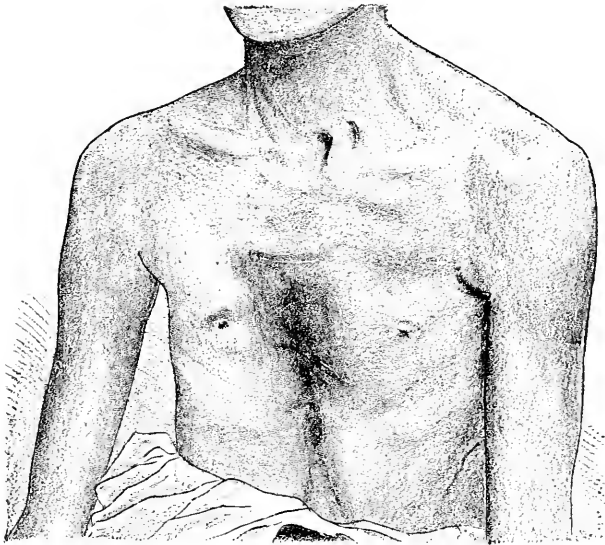

Funnel-breast. (EBSTEIN.)

According to recent experience, the funnel-breast sometimes is observed in several branches of a family. In individual cases it occurs as a sign of degeneration, with other errors of development, or associated with neuropathic or psychopathic disease or hereditary taint.

3. *Anomalies of Respiration.*

In the preceding section the anomalies of breathing which accompany the several pathological forms of thorax have been briefly referred to. But these require a further separate description. In

giving this it will not be possible to avoid a partial repetition of what has already been said.

(a) ANOMALIES OF THE MANNER OF BREATHING. The type of breathing which, as has been mentioned above, in the normal human being is typically different in the two sexes, and is denominated costal and costo-abdominal, may be influenced by a number of different pathological conditions.

1. The activity of the diaphragm, from some cause or other, may be restricted or entirely stopped; it may then be replaced by increased thoracic breathing; this causes the costal type peculiar to women to be still more prominent, while the male type is reversed; instead of the abdominal predominating, the costal becomes predominant or entirely prevails—that is, may take on the female type.

Such a restriction or prevention of the action of the diaphragm is occasioned by pain, or mechanical restraint, or by weakness or paralysis of the diaphragm. Such is the action of all inflammations of the abdominal or pleural cavities in case they involve the corresponding serous covering of the diaphragm, markedly impairing diaphragmatic breathing; they often act so because they are painful; but also sometimes, especially in inflammation of the diaphragmatic peritoneum, actual paralysis of the diaphragm quickly develops, which is recognized by the entire disappearance of abdominal breathing (see above, p. 83). This takes place quite commonly in diffuse peritonitis; it is, however, also sometimes the only symptom of a beginning local “sub-phrenic” peritonitis. Marked distention of the abdomen by tumors, fluid, and accumulations of gas in the intestines, hinder diaphragmatic breathing in a high degree. Finally, there occurs paralysis of the diaphragm in organic diseases of the nervous system (bulbar paralysis; neuritis of the phrenic nerve in the various forms of multiple neuritis), as well as a manifestation of functional neurosis (hysteria).

The action of the diaphragm is recognized, as has frequently been mentioned, by the protrusion of the epigastrium during inspiration. Of course, this does not take place when there is no contraction. In complete paralysis the diaphragm is sometimes even completely sucked into the thorax; in hysteria, during inspiration, the epigastrium sometimes sinks in extraordinarily deep. One-sided failure of action of the diaphragm may also occasionally be made out. (See Palpation.)

2. But sometimes, also, hindered thoracic breathing may be replaced

by increased diaphragmatic breathing; hence, in such a case, if the patient is a female, the type of breathing is changed—that is, abdominal breathing predominates instead of costal.

Therefore, in very rigid thorax (emphysema), sometimes also in women, diaphragmatic breathing predominates. Here belong paralysis of the muscles of inspiration (bulbar paralysis), and myositis ossificans (rare), since it causes a rigid condition of the thorax. A peculiar disease of the skin, scleroderma, may, if located upon the thorax, also entirely abolish thoracic breathing.

It has been shown above, under emphysematous thorax, how, in lieu of the peculiar costal breathing, this may in part be replaced by the movement of the thorax as a whole by the (auxiliary) muscles—the sterno-cleido-mastoidei.

3. Asymmetry of breathing, which is occasioned as follows: the whole side, or the upper or lower part of one side, either (very rarely plainly) expands somewhat later than the opposite side, or (most frequently) expands less strongly or not at all—which condition has already been mentioned several times.

Such a lagging may be caused by a unilateral painful affection of any kind; moreover, by all diseases of the thoracic organs which interfere with respiration upon one side. This “lagging behind” is a valuable symptom, especially in *phthisis* (lagging in the infra-clavicular depression), also in the beginning of *pneumonia and pleurisy*, when other symptoms are wanting. (See Palpation of the Thorax.)

(b) ANOMALIES OF BREATHING AS REGARDS FREQUENCY AND RHYTHM. Diminished frequency of breathing may take place in all severe diseases of the brain and its meninges, hence in large hemorrhages, tumors, etc., and in all forms of meningitis; thereby exists always more or less dulness of intellect; the slowness of breathing may sometimes pass into the Cheyne-Stokes respiration (see below). Further, in acute infectious diseases, with marked mental dulness, the respiration may be slower; finally, it is generally so in the death agony.

A very important form of diminished frequency of respiration is observed with stenosis of the upper air-passage; this belongs in the section on Dyspnoea. Increased frequency of respiration as a patho-

logical manifestation belongs, without exception, to a large group, which will also be discussed in the next section.

It has already been mentioned that we meet with temporary irregularity of breathing in healthy persons. It is of pathological, and generally of grave, import in all cases of marked mental dulness (as in apoplectic, uræmic, and the coma of severe typhus), and very especially in the death-agony.

The so-called Cheyne-Stokes breathing is a very peculiar form of breathing, which is periodically repeated. It is unequal and arhythmic: in typical cases one or two quite superficial breaths are followed by four or five that are successively deeper and more noisy, with strong action and snorting or snoring, sometimes also a sort of deep sighing; then the respirations are again regular, become also sometimes somewhat slower; the fourth or fifth from the acme is even hardly noticeable: then follows a pause of variable length without any breath ("apnœa"); this may last as much as a minute; then the course as above described is repeated. Frequently, also, there is a regularly recurring apnœa alternating with ordinary deep breaths.

Very remarkable cases, of which I have seen a few, but of which others have observed many, are those in which patients, ordinarily unconscious, become conscious regularly with each return of the deep breathing; they open the eyes, raise the head a little, and may possibly even ask questions; but, with the return of the apnœa, the patient again sinks into unconsciousness. In individual cases this form of breathing occurs with patients who are almost entirely conscious.

The Cheyne-Stokes respiration is observed in all forms of meningitis and in hemorrhages, tumors, etc., of the brain; likewise, in heart-failure in consequence of heart-disease of whatever sort, but especially from fatty heart (Stokes), in uræmia (uræmic coma); finally, in poisoning by opium or morphine. Besides, it may occur occasionally in any deep coma.

It is very difficult to explain the significance of this phenomenon, in that it is not always a fatal one. We have seen it frequently without fatal result in uræmia, also in one case of apoplexia cerebri, and once in a case of acute diffuse peritonitis of the vermiform appendix. In heart diseases it seems at any rate to indicate approaching

death. It may last hours and days; it is said to have even been observed to continue for almost seven months.

It is, without question, dependent upon a disturbance of the function of the respiratory centre in the medulla oblongata. But we are in want of any exact description of the nature of this disturbance. A simple diminution of the irritability of these ganglion-cells certainly must, from the blood containing CO_2 , have eventually, as a less frequent result, deep or superficial (possibly irregular) breathing, as is seen in the death-agony. To ascribe a different degree of irritability to particular cells or groups of cells, as some have done, is at least a great refinement. In short, we have no clear explanation of this phenomenon. Moreover, the peculiar change of consciousness, and the other manifestations that have sometimes been observed to accompany it (the contracted pupils in apnoea, jerking of the muscles at the close of the apnoea), do not throw any clear light upon the subject.¹

(a) DIFFICULT BREATHING, DYSPNŒA. We have to designate that form of dyspnœa as physiological which results when the respiratory centre is supplied with blood which contains less than the normal quantity of O, or an increased amount of CO_2 . The pathologist and the clinician speak of dyspnœa if the respiration is labored, whether the number of respirations be normal, or prolonged, or more frequent. Finally, in all cases of increased respiration, if rapid and labored breathing are combined, dyspnœa is caused by all those conditions that interfere in any way with the exchange of gases in the lungs (see under Cyanosis). But there is another condition which manifests itself by an increased formation and giving off of CO_2 ; that condition is fever.

Labored respiration with normal or diminished frequency takes place in stenosis of the upper air-passage—that is, of the larynx and trachea. Intra-tracheal tumors, foreign bodies, inflammations (especially croup), cicatricial strictures (generally syphilitic), granulations, also, compression from without, and lastly paralyses of certain laryngeal muscles (see under Inspiratory Dyspnœa), produce narrowing of the air-passage.

¹ Recently, Mosso points out that there is a like oscillation in the sleep of healthy persons, and explains it by the assumption of a "breathing luxus"; he considers the Cheyne-Stokes phenomenon simply as a pathological example of the same phenomenon; but the condition is not explained by this.

Strictly speaking, this form of dyspnoea often occurs in diseases of the brain (also see above, page 91). At the acme of respiration in Cheyne-Stokes breathing we must speak, too, of there being dyspnoea.

INCREASED FREQUENCY OF RESPIRATION OCCURS:

(a) In *fever*. Here it is often simply increased frequency, the breaths being deeper, but sometimes, also, we notice that they become somewhat labored (without its being a question of complication of the thoracic organs). The amount of quickening of the respiration varies very much, according to the nature of the disease and with the individual. Nervous persons often breathe remarkably rapidly in fever; with children, respirations as high as sixty or more to the minute have often been observed. Nevertheless, in fever every case of marked increase in frequency of breathing must lead to an especially careful examination of the thoracic organs. The cause of fever-dyspnoea is, moreover, not alone the increased formation of CO_2 , but is also the result of the irritation of the respiratory centre by the warmer blood.

Fever-dyspnoea may be increased by association with that caused by diseases of the respiratory apparatus.

(b) In *all conditions that are connected with pain in breathing*. Here belong all diseases of the pleura or the lungs in connection with the pleura (especially croupous pneumonia), inflammatory affections of the diaphragm (trichinosis), of the peritoneum (especially the diaphragmatic peritonæum), fracture of ribs, and severe rheumatism of the muscles of the thorax.

Rightly to explain this form of dyspnoea is often of the greatest therapeutic value: it may sometimes (not always) be relieved by a narcotic.

(c) In *diseases of the bronchial tubes*, which narrow or close the tubes by the secretion or exudation. Here belong all forms of bronchitis, and also bronchial asthma. In the latter disease there is much less swelling and exudation than from bronchial spasm of neurotic origin, which chiefly causes the dyspnoea. No doubt spasm of the diaphragm is associated with this sometimes, which causes a prolonged inspiratory expansion of the lungs, and, of course, this increases the dyspnoea.

Where there is bronchial asthma and croupous bronchitis in addition to laryngeal croup, there is generally very severe dyspnoea with quicker and very forced respiration. Simple catarrh of the bronchial

tubes generally leads to quickening of the respiration without the breaths being deeper; for a complete closure of the bronchial tubes cuts off a large section of lung, and so breathing is entirely lost in this section, as in capillary bronchitis, especially in children. The consideration of this condition properly belongs to the next section, in that it results in the lung-tissue itself becoming diseased.

(d) In all conditions in which the breathing surface of the lungs is diminished or the volumetric variation of the lungs, which is necessary for respiration, is disturbed. These are:

All *diseases of the lungs*: the different forms of pneumonia, œdema of the lungs, infarction, tuberculosis, emphysema (this not only on account of the diminished breathing surface, but also the loss of elasticity, and hence diminished contraction of the lungs during expiration); the different forms of *pleurisy with exudation*, *pneumo-thorax*; *tumors in the chest-cavity* which diminish its capacity; *abdominal affections* which push up the diaphragm; marked *kypho-scoliosis* with the resulting deformity of the chest and consequent unfavorable condition for breathing; *paralysis* of the muscles of respiration; and also *tonic and clonic spasm* of the muscles of the chest, as in tetanus and epilepsy, which may occasion the most severe dyspnœa.

As is evident, these diseases differ widely from one another. Those that diminish the chest-cavity, if they are inconsiderable, sometimes merely restrict the inspiratory expansion of the chest, and so affect the lungs; but, if they are marked, then they directly compress the lungs, and hence diminish their breathing-surface.

It has been already stated that in a number of these conditions the need of oxygen may be met by a substitution of diaphragmatic breathing in place of the diminished costal breathing, and *vice versâ*. It is, of course, very calamitous when there is a combination of several causes of dyspnœa, as, for example, when a subject of kypho-scoliosis has an abdominal affection which presses up the diaphragm, or has inflammation of the lungs.

Accommodation, adaptation, plays an important part in many chronic diseases which occasion dyspnœa. This becomes most strikingly evident if we compare the terrible dyspnœa of beginning pneumo-thorax with the relatively comfortable condition of patients who have continually at their disposal for breathing only one lung, or even only a part of a lung. In many of these cases it is

easy to understand this accommodation; chronic cases, especially phthisical patients, who here come prominently into view, are generally anæmic, and therefore require, at least when quiet, only a very small interchange of gases in the lungs; but every effort at muscular exertion immediately causes dyspnœa. On the other hand, "lung dyspnœa" is generally considerably increased in one who has an acute disease, by the fever. Likewise, there are cases where we cannot dispense with the idea, which formerly was not clear, of an "accommodation."

Dyspnœa further occurs:

(e) In diseases of the heart which cause stasis of blood in the lung circulation. These are mitral insufficiency or stenosis of the left auriculo-ventricular opening; also heart-failure, which may occur in all diseases of the heart.

It is evident that slowing of the capillary circulation of the lungs diminishes the interchange of gases in the whole quantity of the blood; but generally we have, beside this, a diminution of the alveolar lumen, from the capillaries being swollen, especially in the so-called brown induration of the lungs.

Increased and forced respiration. Forced respiration may at any time be associated with rapid breathing by increase of dyspnœa. The only exceptions to this are those cases that arise from pain and paralysis, both from reasons that are easily intelligible.

Mechanism of forced respiration. This is, in the most characteristic way, different from normal breathing, namely, that while the muscles of ordinary inspiration and the mechanical conditions of expiration no longer suffice, inspiration and expiration are assisted by the action of the auxiliary muscles of respiration.

The auxiliary muscles of inspiration are: the scaleni muscles in the male (in the female they act even in quiet breathing), as elevators of the two first ribs; the sterno-mastoidei draw up the sternum when the head is fixed; the pectoralis major and minor, the levatores costarum, the serratus post. super., all of which act as elevators of the ribs, the first named when the upper arms are fixed. In more severe dyspnœa the trapezius, the levator scapulae, the rhomboideus, are brought into action to elevate the scapula; in severest dyspnœa the extensors of the neck assist also, and then we notice the expansion of the alae nasi (see under Nose); when the mouth is open the soft palate is

seen to be drawn up during inspiration; and, finally, even those muscles that dilate the mouth and depress the larynx may be brought into action.

The muscles have very varying degrees of importance, the greatest being the work of lifting up the ribs, the sternum, and the shoulders. The expansion of the *alæ nasi* as a symptom is not unimportant, but really does not at all assist in breathing.

In *expiration* the following muscles act in assisting respiration: Of first importance are the broad muscles of the abdomen, especially the *transversus*, which compress the abdominal contents, thus pressing up the diaphragm; further, the *quadratus lumborum* and *serratus post. infer.*, which draw down the lower ribs.

It is easy to distinguish the moderate drawing-in of the thorax and epigastrium which occurs in normal passive expiration from the active expiration of dyspnoea, by the energy of the act in consequence of muscular contraction. Moreover, the contraction of the broad muscles of the abdomen is plainly to be seen.

Patients with *forced respiration* exhibit still other appearances which partly stand in direct relation to the increased energy of the breathing.

That the thorax may be entirely easy and that the auxiliary muscles may be able to act better, patients prefer the upright posture to lying down (*Orthopnoea*, p. 32)—indeed, in very severe dyspnoea, they may not be able to lie down at all; the arms are fixed in order that the upper arms and shoulders may furnish a fixed point for the auxiliary muscles; and, in order that the *sterno-cleido-mastoidei* may act most efficiently in assisting respiration, the neck is stretched and the face somewhat elevated.

Not infrequently the breathing is audible; in forced respiration, it is panting, groaning. In stenosis of the larynx or trachea we hear the before-mentioned hissing—*stridor laryngeus vel trachealis*. The voice is weak, often suppressed; the patient speaks with short, unnatural pauses; broken speech.

Here belongs the so-called inspiratory “drawing-in.” Even in healthy people we sometimes notice with forced respiration that the lower intercostal spaces in the beginning of inspiration sink in somewhat (a simple flattening-out takes place from the contraction of the intercostal muscles). Drawing-in that is more marked and is pro-

longed during the whole of inspiration, under all circumstances is pathological; with very yielding thorax (children), even the ribs and the lower part of the sternum may share in the condition. It shows that the lungs do not follow the motion of the thorax—that, therefore, the air is prevented from entering the alveoli.

Hence, all forms of *stenosis of the larynx* (especially frequent with croup) and of the *trachea* (likewise both bronchi) cause inspiratory drawing-in of both sides, most markedly of the lower part of the sternum, the lower ribs, and intercostal spaces; if the stenosis is very marked, the condition is extended to the upper ribs and intercostal spaces, as far as the jugular and supra-clavicular spaces. *Stenosis of a bronchus* causes inspiratory drawing-in of one side when the breathing has a certain degree of force, beside “lagging” of the affected side. *Bronchitis of the smaller tubes* (especially in children) may occasion inspiratory drawing-in in a more circumscribed way, as only the lower part upon one side. But we may also sometimes see an extended, very marked drawing-in with extensive capillary bronchitis (with atelectasis, broncho-pneumonia) in children.

There are two reasons why stenosis of the upper air-passage causes the drawing-in to be greatest at the lower part of the chest, and which may also affect the ribs of this part: first, the air entering the lungs, reaches the lowest part, as being the furthest removed, last; secondly, if the thorax is yielding, it is drawn in by the contraction of the diaphragm; for if the diaphragm cannot descend when it contracts, since the lung does not follow it, then the dome of the diaphragm becomes a fixed point, and the thorax in the neighborhood of the insertion of the diaphragm is drawn inward and upward.

Also, expiratory bulging sometimes takes place in the supra-clavicular depression, especially in marked emphysema of the upper part of the lung, as, for example, after whooping-cough (see p. 76); or in the upper intercostal spaces, when large cavities are adherent to the chest-wall, as in pulmonary phthisis. With this appearance there is a strongly-marked pressure in the thorax; hence it is observed only in very forced expiration, and especially in strained coughing.

Very frequently we find in cases of lung-cavities with expiratory bulging—especially frequent in the second intercostal space—the affected intercostal muscles very much shrunken, sometimes fatty degeneration of them.

Finally, the picture of such an unfortunate will be completed by the expression of subjective anxiety; sometimes of the most fearful agony; by the peculiar expression of the eyes, the consequence of the dilatation of the pupils which always exists in dyspnoea (see Nervous System); lastly, by the cyanosis and frequent cold sweat (*q. v.*).

According as inspiration or expiration, or both, are difficult, or the auxiliary muscles of respiration are brought into action, we distinguish an *inspiratory* (pure or preponderating), an *expiratory* (pure or preponderating), a *mixed*, *dyspnoea*.

Purely *inspiratory dyspnoea* exists with paralysis of the posterior crico-arytenoid muscles (dilators of the glottis); here expiration is free, since the escaping current of air presses the vocal bands apart; on the other hand, the in-rushing air brings them, like valves, in contact, and hence inspiration may be hindered even to threatened suffocation. *Tumors and foreign bodies* may, moreover, be sometimes so located as, by valve-like closure, almost completely to preclude inspiration. Further, inspiratory dyspnoea occurs with increased activity of other muscles when certain respiratory muscles are paralyzed (as, for example, in paralysis of the diaphragm, increased thoracic breathing is accomplished by the auxiliary muscles).

Purely expiratory dyspnoea is observed with movable tumors situated below the glottis; the out-going air pushes them against the rima glottidis, but in expiration they are drawn to one side.

Moreover, a preponderating expiratory dyspnoea is peculiar to *bronchial asthma* (in addition to the always present inspiratory). Probably we correctly assume that the smallest tubes, spasmodically narrowed, are still more compressed by the pressure in the thorax during expiration.

The disease that most frequently causes expiratory dyspnoea is emphysema of the *substance of the lungs*; the diminished power of expiration is chiefly from the loss of elasticity of the lung-tissue, the contracting force of the lungs; generally there is, besides, diminished thoracic breathing—since, if the thorax is too rigid to expand during inspiration, then it is also not contracted, either by virtue of its own elasticity or the traction of the lungs.

Bronchial asthma of long duration always causes emphysema of the lungs; then, of course, there is a twofold cause of expiratory dyspnoea.

In genuine emphysema of the lungs there is always also well-marked inspiratory dyspnœa, on account of the atrophy of lung-tissue and capillaries of the lung, and hence diminished breathing-surface. Moreover, it will be understood that whenever there is expiratory dyspnœa, if the difficulty of expiration is not equalized by forced or prolonged expiration, there must result a simultaneous inspiratory dyspnœa; there is a diminished interchange of gases in the lungs resulting from the incompleteness of the act of expiration; there is a demand for oxygen, and hence forced inspiration. There is no expiratory dyspnœa with vicarious emphysema of the lungs.

Mixed dyspnœa—that is, where it is manifest in equal degree in inspiration and expiration—is by far the most frequent. It accompanies all the diseases of the respiratory organs not mentioned here, also diseases of the heart, and fever.

PALPATION OF THE THORAX.

This method of examination has, on the one hand, an independent value, and on the other it confirms and, with sufficient practice, even adds to the results of inspection. It is, therefore, very wrong to omit it. It is indispensable on account of its simplicity, and because, like inspection, it quickly furnishes a result in a general way; moreover, its result is often decisive in differential diagnosis, in a certain direction, relative to vocal fremitus.

Palpation of the thorax, with reference to the respiratory organs, is made for the purpose of ascertaining:

1. Possible pain upon pressure.
2. The respiratory movements of the thorax, especially as to symmetry.
3. Any friction-sounds or râles that may be felt.
4. Vocal fremitus.

In addition, there are some rare appearances that are not unimportant in differential diagnosis.

The examination with reference to the first and second points may be combined with inspection; the trial of the third point may suitably be settled during auscultation, either before or after. Ordinarily we test the *vocal fremitus* after the completion of percussion and auscul-

tation, hence we conclude the physical examination of the thoracic organs by noticing the vocal fremitus.

We pause here, in the course of the examination, and only speak of the first and second points; the two others will be introduced under the heads of Percussion and Auscultation.

1. *Pain caused by Pressure upon the Thorax.*

In diseases of the chest pain is common, accompanying the diseases or elicited by pressure. In case it really refers to an internal organ, and not to the chest-wall, it indicates disease of the pleura or complication with the pleura. By carefully feeling the intercostal spaces with the tips of the fingers, the region that is tender on pressure may be very exactly defined; it is generally less extensive than the territory of spontaneous pain, since the latter ordinarily "radiates."

This tenderness sometimes exists with exudative pleuritis, but in this disease it is often wanting; more frequently it is seen in croupous pneumonia which involves also the pleura, and also in phthisis. In the latter disease it generally depends upon callous thickening of the pleura.

It is very important, but also frequently difficult, to distinguish between pleuritic pains produced by pressure from those arising in the *soft parts of the chest-wall* or the *ribs*. Phlegmonous inflammations and abscesses of the chest are, of course, easily recognized. Pain proceeding from a rib is generally characteristic; quite circumscribed, it occurs only when pressure is made upon the affected rib (caries, periostitis, over fractured ribs, slight pressure); also, rheumatism of the chest-muscles occasions no great difficulty, at least when it is in the superficial muscles; the muscle is ordinarily sensitive if pressed between two fingers. On the other hand, it is often not easy to distinguish between pleuritic pain and *intercostal neuralgia*; the latter can sometimes be distinguished by Valleix's points of tenderness, which stand wholly out of relation to deep breathing or cough. (See Nervous System.) It is important to remember that neuralgic intercostal pain may be present in affections of the pleura, as in tubercular thickening of the pleura in the lower part of the thorax.

In short, we ought, in the absence of other indications which point to a disease of the internal thoracic organs, to refer a pain produced

by pressure upon the thorax rather to something else than to the pleura; only continuous pain, always at the same places, over the upper sections of the lungs, arising either spontaneously or from pressure, is suspicious; this may indicate irritation of the pleura from *tuberculosis of the apices*.

Fractures of the ribs are recognized by crepitation, and also by dislocation of the fragments: also, often by the fact that pressure at any part of the broken rib causes pain at the seat of fracture. Moreover, fracture of the rib may cause pleurisy. *Caries of the rib* may also excite pleurisy. Then, in recognized pleurisy, caries may be proved to be the cause by the circumscribed pain elicited by pressure upon the rib.

It must also be mentioned that if a purulent pleuritis breaks outward (*empyema necessitatis*), it causes peripleural inflammation, and with this there is pain upon the slightest pressure, besides swelling, redness, heat, œdema of the skin, and, lastly, fluctuation.

To the above-mentioned conditions revealed by palpation of the thorax must be added *pulsations of the heart* felt through a portion of infiltrated lung lying over the heart, and also in the so-called *empyema pulsans* (*empyema pulsatile*).

This occurs when there is an accumulation of pus lying over the heart, almost always upon the left side, to which the pulsation of the heart is communicated. In some cases it is very difficult to distinguish it from aneurism of the aorta. It can only be done by taking a comprehensive view of the case. (We must be on our guard in puncturing or in making an exploratory puncture.) Sometimes pulsations are even found on the left lower posterior portion of the thorax. Usually several causes combine to produce the pulsation: paresis of the intercostal muscles, higher pressure of the exudate, direct contact with the heart, lastly, as indispensably necessary, powerful action of the heart.

2. *Testing the Movement during Respiration.*

With special reference to symmetry, with some practice, palpation is a most excellent method. It gives more exact results than inspection, and makes the further examination easier, in that it directs the

attention immediately to the diseased side or the region of the thorax affected.

The respiration is examined by placing the two hands alike upon the two sides of the chest. In order to test the breathing of the upper divisions of the lungs, place the hands flat in front, gradually diverging below, so that the tips of the fingers reach to the lower border of the clavicle. For examining the lower parts, spread out the hands with the thumbs extended so that the thumbs rest upon the angle of the ribs. Behind, only the respiration of the lower lobes will be tested by laying the flattened hands, with the thumbs extended, upon the surface in such a way that the points of the fingers reach about to the middle axillary lines.

For exact examination, it is necessary, if possible, for the physician to be exactly before or behind his patient; the latter position especially is often difficult when the patient sits in bed; it is best, then, to have the patient slide somewhat down toward the foot of the bed.

When palpation is well performed, "lagging" over the apex in beginning phthisis, or the "lagging" of the lower part of one side in pneumonia, pleurisy, infarction, etc., is recognized with great exactness; this is of great importance, because, as I have already said, "lagging" may be in many diseases for some time the only symptom.

We may also test the action of the diaphragm with reference to its symmetry by palpation. We place the hands so that the finger-tips cover the epigastrium; in this way may be detected the lack of contraction upon one side (pleuritis diaphragmatica, local peritonitis, paralysis of one phrenic nerve). Failure to contract upon both sides is, of course, seen at once.

GENERAL AND PRELIMINARY REMARKS REGARDING PERCUSSION.¹

In daily life we learn on every hand that bodies of different physical structure give forth different sounds when struck. We also sometimes strike an object in order to determine from the sound it gives forth what its physical condition is—that is, whether it is hollow or solid.

¹ In this chapter the author follows in many ways, but not entirely, the views and methods of presentation of Weil, whose personal pupil he was for ten years and whose teachings, in the courses upon percussion which the author has conducted for four years, were in many respects a rule of conduct to him.

This is the principle upon which percussion is practised on the human body; from the sound elicited by the blow, we judge of the physical condition of the part which lies beneath the covering of the body within the sphere of our percussion-stroke.

Hence, percussion gives direct information regarding organs or parts of organs which lie approximatively near to the surface of the body; in general, by this method, we penetrate only to the depth of five, or, at most, seven cm.

1. *History and Methods.*

The honor of the discovery of percussion belongs to a physician of Vienna, named Auenbrugger; the paper in which he made known his method appeared in 1761 under the title, *Inventum novum ex percussione thoracis humani ut signo abstrusos interni pectoris morbos detegendi*. For almost half a century Auenbrugger's discovery was, on the one hand, declared to be without importance, and, on the other, was ridiculed, until the year 1808, when Corvisart, body physician to Napoleon I., emphatically revived and largely improved it by a translation into French, with a commentary. Then the truth began really to prevail, especially by the influence of Piorry in France and Skoda in Vienna. The former was the founder of *topographical percussion*. During fifty years the method gradually became common professional property. Further, and up to the most recent time, it experienced improvement and explanation of every kind, especially by Wintrich, Traube, Biermer, Gerhardt, and Weil. For several years, especially since the labors of Veil, it appears that a degree of certainty has been reached in regard to this proceeding.

In the course of the development of percussion several methods of striking the body have been discovered, most of which still have value to-day.

Auenbrugger struck directly upon the thorax with the tips of the fingers: *direct* or *immediate percussion*.

Piorry discovered *indirect* or *mediate percussion*, in that he placed under the percussing finger a small plate of ivory—a *pleximeter*.

Wintrich introduced the percussion-hammer, which had already been sometimes used by Laennec and Piorry, in place of striking with the fingers.

But finally, in more recent times, the method of indirect percussion, without instruments, has very widely prevailed. The index- or middle finger of the left hand is used as the pleximeter, which is placed upon the spot to be percussed, and it is struck with the index- or middle finger of the right hand (finger-percussion).

Of these methods, that of Auenbrugger, the direct, has been dropped as being less practical, while now-a-days the three in use are all examples of the indirect method :

I. Finger-percussion.

II. Finger-pleximeter percussion.

III. Hammer-pleximeter percussion.

All three are practised and taught by good teachers of percussion ; all three, in reality, yield equally exact results ; the secret of their value lies in *their application*.

One who thoroughly understands finger-percussion can very quickly acquire a knowledge of the two other methods. Hence, I am most heartily in accord with those who, in their teachings and writings, emphatically recommend their students at first to practise the finger method of percussion exclusively.

I think it superfluous for me here to go into particulars regarding the *technique* ; these can only be made clear in the clinic ; but I must remark that the greatest difficulty in finger-percussion is in holding the percussing finger crooked, like a hammer, and, at the same time, having the wrist-joint move quite freely. Also, the numerous forms of percussion-hammers and pleximeters (the latter of glass, ivory, hard rubber, and wood, in different forms) cannot be described here. It appears to me that the hammer with a wooden handle and a metal head, not too heavy, is rather to be recommended ; likewise, a medium-sized oblong ivory pleximeter, about two cm. wide, and the so-called double pleximeter of Seitz. Even to those who practise finger-percussion this last is recommended for percussing the supra-clavicular depressions. There is one point of great importance : that the individual should, as much as possible, be homogeneous in his method and in accord with it throughout : in percussing, if the finger method is used, he should always strike upon the index- or always upon the middle finger of the left hand ; the pleximeter, if that is used, should always be used in exactly the same way, etc. Nothing is worse than frequently to change methods or instruments, be the

change ever so slight. But if physicians, as is true of many, are accustomed at certain parts of the thorax where it is difficult to use finger-percussion, regularly to employ a pleximeter, or both pleximeter and hammer, there is no objection to this twofold method; only he must be master of the two methods which he employs. It is well, also, always to repeat the same method upon the same parts of the body.

2. *Qualities of Sounds.*

By our striking upon the body we cause a sound. This percussion sound differs according to the condition of the part of the body which is shaken by our percussion blow.

Two principal sentences contain the foundation of percussion:

1. When we strike upon a solid portion of the body entirely free from air we elicit a toneless sound of the least possible intensity and duration; it is designated as "absolutely deadened," or as a "thigh sound," since it is like that caused by striking upon the thigh. [Deadness: I have frequently used this word and its derivations as giving a useful and accurate discrimination from the familiar English terms, flatness, dulness. Deadness is more than dulness.]

2. If organs containing air lie in the range of our percussion blow, then these give forth a sound of a certain intensity, duration, and tone; this sound is designated as "clear."

The clear sound of organs containing air may have only a different degree of intensity or clearness. Its intensity depends upon:

1. The *length of the oscillation*. It is, therefore, stronger, the stronger the blow; and, moreover, the nearer the organ containing the air is to the percussing finger—that is to say, the less the percussion-stroke is weakened by the tissue, as fat, muscles, bones [also clothing], intervening between it and the air-cavity.

2. By the volume of the parts of the air-containing tissue set in motion.

Hence, with equal strength of percussion, we have in different parts of the body different *intensity* and different *clearness* of sound, according to the greater or less amount of air which the tissues contain, or according to the nearness or distance of the air-cavity from the surface of the body—that is, from the percussing finger.

It is according to the change of these conditions in the human

body that we obtain the different clear sounds; we may meet every grade from absolute deadness to a very clear—the peculiarly clear—sound. These intervening grades are designated as “relative dullness” (that is, in comparison with a real clear sound it is dull).

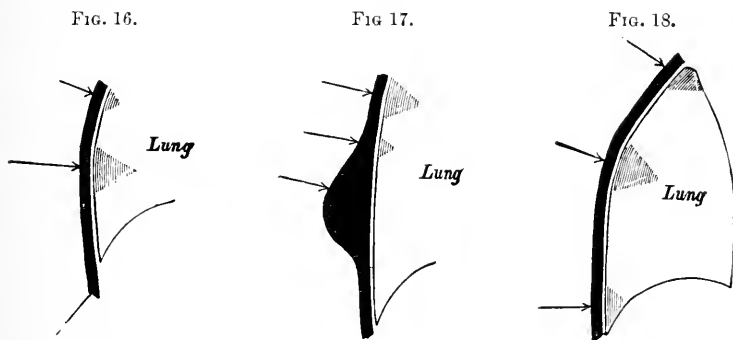

Fig. 16.—Diagrammatic representation of the difference between weak and strong percussion under circumstances that are otherwise alike. The length of the arrows corresponds with the strength of the percussion; the size of the triangle designates the volume of the portion of lung affected by the blow, and, at the same time, the intensity of the sound.

Fig. 17.—Representation of the difference of result with a percussion-stroke of equal strength, but when the thickness of the covering of the body varies. Clear sound, relatively dull sound, no resonance—that is, absolutely dull sound.

Fig. 18.—Representation of the effect upon percussing over a thick covering of the body. Over the apex and border of the lung the sound is less intense than over the rest of the lung, on account of the diminished volume of lung-tissue, the percussion-stroke having the same force, and this tolerably strong.

Absolutely dead or dull sounds differ according as they proceed from muscle, bone, etc. We cannot wholly ignore these differences, as if not existing.

On the other hand, the clear sounds fall into the two following important divisions:

1. *Tympanitic sound* (the name is from tympanon; the kettle-drum or tymbal, not exactly, but very nearly, produces it). This approaches a musical note, so that we can exactly define its place on the musical scale, and it is actually shown formed from regular oscillations in the rotating reflected image of the sensitive gas-flame. It shows, also, according to the different conditions to be described later, sharply definable differences of pitch. A tympanitic sound such as is frequently met with in the body can easily be produced if one strikes

upon his own cheeks, which have been inflated, but not too strongly stretched.

2. The clear sound called *non-tympanic*, also more briefly "lung-sound"—a very practical designation. This has no sound definable by its pitch, but yet it may be known in general as "high" or "deep."

Hence, both the tympanic and the non-tympanic sound have a certain *intensity* and *duration*; but, while the latter only approximately may be designated as high or deep, the pitch of the tone brings it toward the tympanic. Both occur in a very high degree of clearness and in all degrees of relative dullness ("relative dullness" or "dull tympanic sound"), even to an often unnoticeable transition to absolute dullness.

1. In the foregoing, we give those designations which, in late years, we have without exception employed in our instruction on percussion. Regarding the large number of other terms for qualities of sound which the older teachers of percussion have introduced, but which, to the great advantage of clearness of mutual understanding, have more and more disappeared from the literature of the subject, we refer to the classical work by Weil on *Topographical Percussion*. We have in fact, as will be seen, followed the nomenclature proposed by Weil, with only one exception; the term *dull* is avoided, and in place of it we have employed the expression (which, it is true, is somewhat circumstantial) "absolutely smothered," or "thigh-sound." This was done because, over and over, we found that pupils were reminded of the "dull sound of the kettle-drum," "dull roaring," etc., and, hence, were confused; in short, because the expression does not grammatically designate what is intended in teaching percussion. "Absolute smothered sound" has this advantage—that, to the beginner, it is a new association of words; it cannot, therefore, so easily occasion confusion. Moreover, the expression always summons one to a more exact testing as to whether, at the particular place, there is really absolute or only relative dullness; and every teacher of percussion knows how much this is needed—that, for instance, in percussing the lower part of the right mammillary line the so-called relative liver-dullness is spoken of as absolute dullness.

2. For the sake of brevity and clearness, we also have really not

gone into the many ideas and the manner of explaining them presented by others, on this subject, which was formerly quite confused, and is even yet difficult. But we cannot abstain from citing here the three fundamental sentences from Skoda :

(a) All fleshy parts, not containing air (except tense membranes and filaments), also fluid accumulations, give an entirely dead and empty, scarcely distinguishable percussion-sound, which can be demonstrated by striking upon the thigh.

(b) Only bones and cartilage when directly struck give a peculiar sound.

(c) Every sound which we elicit by percussing the thorax and abdomen, and which differs from the sound of the thigh or bone, comes from air or gas in the chest or abdominal cavity.

3. The acoustic character of the *clear*, and that of the relative or absolutely dull, *sound* is clearest expressed if we say: the dull sound is a very slight noise of short duration; the clear, non-tympanic sound is a noise louder and of longer duration, with a trace of being a note; this latter, however, is so little apparent that it either cannot at all be recognized, or only in general, as to its being high or deep. In the tympanic sound, with the discordant mingling of tones, a tone predominates of such a character that it is plainly heard and its musical pitch distinguished.

The Conditions that determine the Quality of the Sounds and their Production in the Body.—The Feeling of Resistance.

The tympanic sound exists :

1. Over cavities that contain air or gas, if they are surrounded by walls moderately smooth and capable of reflexion, and if they communicate with the external air through an opening, the walls being stiff or yielding. The intensity of the tympanic sound thus produced depends upon the conditions (mentioned on page 107) influencing the intensity of clear sounds in general. The musical pitch of the sound is determined by :

(a) The *size of the communicating opening*; the larger it is the higher the tone.

(b) The *volume of the cavity* containing the air; the larger, the deeper the tone.

(c) If the walls are yielding, membranous, by their *tension*; lax membranous walls make the tone deeper.

2. Over *air-containing cavities* with yielding, membranous walls, if the cavities are closed—that is, do not communicate with the external air; only the walls, and with them the enclosed air, must not be too tense. Here the *pitch* is determined only:

(a) By the *volume* of the air-cavity. (See above under *b*.)

(b) By the *tension of the wall*. (See above under *c*.)

But if the tension of the wall (and with it the enclosed air) of a closed cavity reaches a certain degree, then the percussion-tone becomes clear and non-tympanitic. Likewise, cavities that are closed on all sides by stiff walls give a non-tympanitic sound.

The tympanitic sound mentioned under 1 is called “open,” that under 2 “closed;” the former has a much more pronounced tympanitic character—that is, the pitch of the tone appears more distinctly than the latter.

When the cavities are cylindrical, communicating outward by an opening, the pitch of the tone is determined by the length of the cylinder; the longer it is, the higher the tone. Some experiments, illustrating what has been said, are easily performed and are strongly recommended to beginners: Take an empty Florence flask and percuss upon its mouth, either directly or hold the pleximeter lightly over its mouth, then diminish the quantity of air by partly filling the bottle with water; if possible, also compare the differences of pitch which are produced by different lengths of the neck of the bottle, other conditions remaining the same. Percuss a rubber gas-bag which is at first only moderately inflated, then more tensely, with air. In this way one can very easily illustrate the most important of the laws that have been mentioned.

3. Finally, *tympanitic sound* occurs under quite other conditions, namely, in certain conditions of the lungs which have this in common—that they probably accompany a want of tension of the lung-tissue.

Referring to what was said above under 1, we add that the *open tympanitic sound* occurs in the human body, under normal relations, when the *mouth, larynx, and trachea* are percussed; pathologically, when percussing *lung-cavities* which are in open communication with the air-passages: further, if in consequence of shrinking of the apices of the lungs, the trachea, or in consequence of shrinking or thickening

of the lung where it covers a fissure, a primary bronchus, would be reached by the percussion-stroke, and would, therefore, be itself percussed; and, finally, the open tympanitic sound sometimes occurs with *open pneumothorax*.

Herewith we notice a peculiarity of this sound, which truly stands in a certain (although still not altogether clear) relation to the laws above enunciated regarding the pitch of the open tympanitic sound: the sound is higher with the mouth open, deeper with the mouth closed. If this occurs when percussing a lung-cavity (or, also, in open pneumothorax) it is called *Wintrich's change of sound*; if on percussion of the trachea or a primary bronchus, then we speak of *Williams's tracheal tone*.

In addition to what was said above under 2, we remark that in the human body the *closed tympanitic sound* is heard over the stomach and bowels; in rare cases over closed pneumothorax; and, finally, in pneumopericardium.

Now, while it is difficult to apply the rules regarding the change of pitch to the open tympanitic sound, since the cavities of which we are speaking are of most extremely complicated form and have very different walls, the influence, on the one side, of the volume of the cavity, and on the other, the influence of the tension of a membranous wall, are shown over the stomach and intestines. A greater volume, as in the stomach and colon in comparison with that of the small intestine, deepens the sound; while increased tension heightens it, and even renders it non-tympanitic.

We add to what was said above under 3, that the normally clear, non-tympanitic sound over the lung *becomes tympanitic* if the tension of the lung-tissue diminishes—*i. e.*, if the lung, following the pull of its elasticity, is able to retract. This is true in all cases where the pleural cavity is diminished, hence, especially in *exudative pleuritis*. The tympanitic sound is found where the retracted lung lies against the thorax. All the other changes of the thoracic and abdominal cavities, working in the same way which have been before mentioned, occasion these phenomena.

Probably, for the same reason—*i. e.*, in consequence of the relaxation of the lung-tissue—a tympanitic sound is heard in *croupous pneumonia* during the stages of engorgement and of resolution; in *œdema of the lungs*; and, finally, in the neighborhood of thickened

parts of the lungs. In the latter relation the tympanitic sound over the apices of the lungs in the beginning of tuberculosis, where lung-tissue containing air is situated between groups of small tubercular masses, is of some diagnostic importance.

In these cases we must assume that the lung-tissue has become loose and ductile, and has, therefore, lost its power of stretching. It has not yet been established that this explanation is correct.

Metallic sound. We thus designate such a variety of tympanitic sound by which a *metallic character*, produced by a very high overtone, either occurring with the sound itself, a peculiar *metallic tone*, or it is produced afterward, *metallic after-sounds*. The metallic sound exists over not too small, very smooth-walled, regular cavities, both open and closed. Hence, we find it sometimes over the *normal stomach, intestines*, and sometimes over *lung-cavities*, in *pneumothorax, pneumopericardium*. It is best brought out in percussing with the so-called rod pleximeter, or in percussion-auscultation (Heubner). (See later.)

The *clear non-tympanitic sound* occurs where, "within the sphere of action of acoustics, there is found tissue containing air, but whose capacity for vibration is more diminished than in those cases in which the tympanitic sound occurs" (Weil, *Handbook of Topographical Percussion*, 2d ed., p. 35). It is heard over the normal lungs—a remarkable fact, since a lung that has been removed from the body, even if it is inflated to a volume corresponding with the condition during life, gives a sound that more nearly approaches the tympanitic than the non-tympanitic. Why a lung in the thorax loses wholly the tympanitic character of its sound is not entirely clear; but we cannot help thinking that, in some way or other, the chest-wall is the cause.

The *intensity of this lung-sound* is sufficiently explained by the rules given above; its *pitch*, only approximately recognizable, is chiefly influenced by the tension of the lung-tissue. We have mentioned above that retracted and relaxed lung-tissue gives a tympanitic sound; if the tension is only slightly diminished, then there is only a *very deep (and abnormally clear) non-tympanitic sound*. This occurs, also, in emphysema of the lungs, but sometimes in exudative pleurisy, and also in pneumonia in the air-containing, infiltrated adjacent sections of the lungs. The transition from the non-tympanitic to the tympanitic sound over the lungs may be thus summarized: According to the diminution of the normal tension of the healthy lungs, there takes

place in the thorax a change of the clear non-tympanitic sound to an abnormally clear and deep, and, in very marked relaxation, to a tympanitic sound. To the above corresponds the fact that in very deep respiration, at the height of inspiration, at many points of the thorax, the respiratory sound is distinctly higher, while in deep expiration it is deeper ("change of respiratory sound," Friedreich).

Moreover, we hear the lung-sound over the *stomach* and *bowels*, if they are very much inflated with gas, where gas, as well as wall, is under marked tension; finally, in *entrance of air* into the cavities of the body, in case their walls are thereby made tense; this especially happens in most cases of *pneumothorax* (except that open pneumothorax frequently gives a tympanitic sound). (See above.)

The deadened sound. Absolutely deadened or thigh-sound is met with "if only structures that are free from air lie within the sphere where the percussion-stroke acts acoustically" (Weil). Since this, at best—*i. e.*, with the strongest percussion—reaches only to the depth of six to seven cm., and not so much as this in a lateral direction, therefore, in case of only strong percussion, absolutely deadened sound

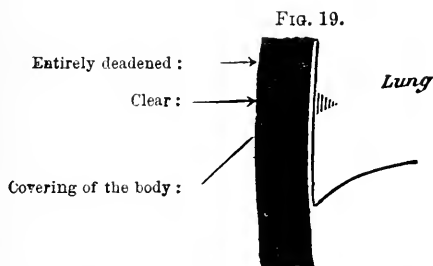

Diagrammatic representation of percussion over a thick covering of the body. The short arrow indicates weak, the long one strong, percussion. With weak percussion we have absolutely deadened resonance; with strong percussion a clear, although less intense, sound (indicated by the hatched triangle).

would, after all, be found where we percussed over *airless structure* of sufficient size, in case an organ containing air was not directly in contact with it. If we percuss still less strongly, we should, as a matter of course, the sooner receive an absolutely deadened sound.

In the human body we have next to consider the internal organs not containing air, called "parietal" if they lie in contact with the wall of the body; and, also, the *coverings* (subcutaneous fat, muscles,

bones) if they are of sufficient magnitude. Thus, frequently, in the neighborhood where the heart is parietal, and, further, where the liver also is, even with strong percussion there is absolutely deadened sound. Not infrequently, however, especially over the heart, absolute deadening does not exist, since the structures containing air lying under or near by may be reached chiefly through transmission by the chest-wall, though it may be only by its vibration, and may give the clear sound belonging to the air-containing structures.

As regards the *skeletal coverings*, in abnormally fat persons, and in oedematous diseases, these sometimes attain such proportions that even strong percussion yields an absolutely deadened sound; in normal, moderately fat persons it is only the fossa infraspinata that very frequently gives absolutely dull sound.

But, further, *parietal tumors*, and especially *fluid accumulations* in the pleura and peritoneum (more rarely, *thickening of the lungs*), occasion absolutely deadened sound in case they, together with the skeletal covering, possess sufficient depth and breadth.

Moreover, over ribs markedly bowed, as over the point of sharpest bending-out of the thorax in kypho-scoliosis, absolutely deadened sound may take the place of the lung sound; also, here, often a peculiar change of the lung (aplasia) plays some part.

Relatively dull sound occurs where air-containing structures of only small size are percussed, or where structures containing air are made to vibrate only slightly by percussion, or where these two conditions are met with together. Thus, a relatively dull sound is obtained with feeble percussion of air-containing structures, while strong percussion of the same yields a clear sound; the blow reaches only a small volume of the air-containing organ, and it moreover causes in it oscillations of only moderate amplitude. Likewise, where the volume of lung-tissue is small, as over the apices and just over the lower border of the lungs, the sound is relatively dull, and this is true even with strongest percussion, since there is here only a small portion of air-containing material to be acted upon. Finally, every layer of airless tissue which lies over an air-containing tissue or space causes a deadening of the percussion-sound of the latter—*i. e.*, a relatively deadened sound—if the overlying layer is not so thick as to cause an absolutely deadened sound. Subcutaneous fat, muscles, bones, parietal tumors, thickening of lungs, layers of fluid, callosities

—all these, as overlying airless masses, deaden the sound in proportion to their size.

A special description is required both of parietal and of *deeply seated airless parts* which normally contain air, such as appear

FIG. 20.

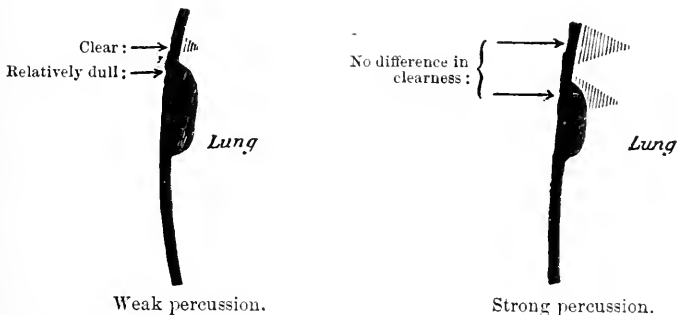

Diagrammatic representation of the value of gentle percussion in determining parietal condensation in the lungs. The length of the arrow indicates the strength of the percussion, the size of the hatched triangle the extent of the vibrations in breadth and depth. We notice that weak percussion is better, because it gives a deadened sound over the thickening, while over the lung it gives a clear sound.

especially in the lungs as *acute and chronic pneumonic thickenings, infarction, and tumors*. For ascertaining such solidifications it is necessary not to percuss too strongly; then we shall plainly make

FIG. 21.

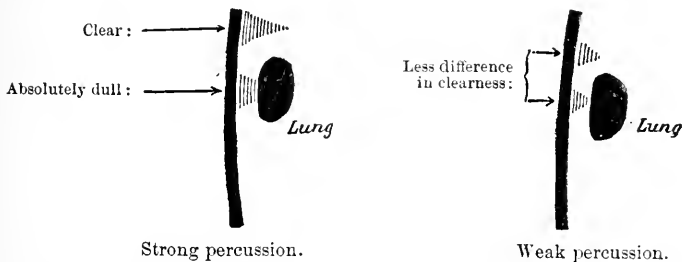

Diagrammatic representation of the value of strong percussion in determining condensation in the lungs lying at some distance from the surface. The strength of the percussion-stroke is indicated by the length of the arrows. The hatched triangle shows the extent of the oscillations in breadth and depth.

out the place where there is air by the difference in sound, if the given patch of thickening measures as much as about five cm. in

breadth and two cm. in depth (see Fig. 20). Deposits which are located at about three to four cm. in depth, if they are correspondingly large, may be detected, but only by very strong percussion; then we elicit a relatively deadened sound in the midst of what is quite normal, as is shown by Fig. 21.

SENSATION OF RESISTANCE.—We introduce here the description of this symptom, although it really belongs under Palpation, but in truth it is most intimately connected with Percussion.

With the percussing finger (less distinctly with the hammer) the examiner forms an opinion of the *degree of resistance*, or, to express it better, concerning the *degree of capacity of the parts lying beneath it to vibrate*. This feeling of resistance is strongest, the power to vibrate least conceivable, where it is absolutely deadened, the sound identical with the "thigh sound"; hence, normally, where we strike upon thick muscle, also bones and muscles; pathologically, it is especially distinct over *large pleuritic exudations, very thick pleura, solid parietal tumors of the chest; over large solid abdominal swellings; and in extremely rare cases, in extensive thickening of lungs, where the bronchi are completely stopped (as in the so-called "massive pneumonia" of the French.*

When the *percussing hammer* is used, to ascertain the feeling of resistance the index-finger is placed upon the head of the hammer. This has always seemed to me a very poor substitute for finger-percussion.

Other authors, as Weil, find a marked feeling of resistance only over massive layers of fluid. I have often convinced myself of the presence of marked resistance in the cases above mentioned.

4. *Topographical Percussion: Determining the Parietal Boundaries of Organs.*

Only of a part of the internal organs can we determine the boundaries by percussion on the surface of the body. The conditions of such determinations are these:

(a) That the given organ be parietal.

(b) That it yield a sound differing from its surrounding tissues.

Hence we can mark off the boundaries of a parietal organ that gives an absolutely deadened sound from one that gives a clear (tympanic

or non-tympanic) sound, as the liver from the lung or stomach, the heart from the lung; of a parietal organ that gives a tympanic sound from one that yields a non-tympanic sound, as the lung from the stomach or the intestine; of parietal organs with tympanic sounds of different pitch, as the stomach from the intestines; and also, though very seldom, two organs of non-tympanic sound, in case they are of very different pitch, as pneumothorax from lung lying against the opposite side.

But we can never recognize the boundaries between two organs giving deadened sound (heart and lungs), nor between the heart and fluid effusion in the pleura (see below).

Method of Determining the Boundary.—Generally we percuss from an organ that yields a clear sound toward that which gives a deadened sound and upon the line which stands perpendicular to the expected boundary-line (hence the pleximeter or the pleximeter-finger is placed parallel to the boundary-line). We proceed by long stages upon this perpendicular (striking it at intervals of about 3 cm.), until the sound has so distinctly changed that we are convinced that we are over another organ. Then we define the boundaries by placing the pleximeter at shorter and shorter intervals until we have defined the boundaries as sharply as possible. This is traced by means of a blue pencil. After the boundaries have been determined at various points and they have been thus marked, then the points are united in a line, which is the boundary-line of the particular organ. *The rule most important to observe is to percuss very lightly along the border of the organ we are trying to locate.*

It is easy to see the reason for this: 1. *By strong percussion*, as of the liver close to the lower border of the lungs, we should at the same time disturb the adjacent lung and so would elicit a noticeable clear sound, and we should then easily think that we were still over the lung. In the same way, in determining the lower border of the liver, by strong percussion we disturb the intestine which here lies under the thin portion of the liver, and so get a tympanic tone.

2. The ear perceives the very slight differences of sound which exist upon the border-line (we remember the lower border of the lung, how the clear sound yielded by it must have slight intensity) better if the sound is itself slight.

For those who are trained, the simplest method may be recom-

mended, that on approaching the boundary between the two organs one should successively percuss the more lightly.

After this indispensable explanation of the general rules for percussion, we again take up in succession the methods of examination of the respiratory organs.

PERCUSSION OF THE THORAX, ESPECIALLY OF THE LUNGS.

1. *Methods.*

It is best first to percuss patients who are out of bed in the standing posture, and later, if necessary for the front of the chest, lying down. Upon bedridden patients the examination of the chest is conducted with the patient in the dorsal position; for percussing the back, we have the patient sit up. We must then take care that the patient sits in a symmetrical position, but with the least possible tension of muscles; the head is held exactly straight, and especially in percussing the supraclavicular depressions it must not be turned; in the dorsal position the arms lie quietly by the side of the thorax. Both in sitting and standing the patient bows the back a little, inclines the head slightly forward, allows the shoulders to hang and folds the forearms across the chest. Every contracting muscle increases the thickness of the covering by its swelling and increases the impression of dulness; hence contraction of the muscles of the thorax must as much as possible be prevented.

In finger-percussion of the front of the chest with the patient in the dorsal position, we approach the bed if possible so as to stand on the left side of the patient. From the other side it is not possible to place the finger of the left hand, used as a pleximeter, symmetrically (see below) upon the two sides in both supraclavicular spaces.

We proceed in such a way as to compare at every situation the percussion-note of points that are symmetrically located. We must take particular care to strike exactly upon symmetrical points, otherwise the "comparative percussion" has no value. Moreover, since we wish to make an exact comparison throughout, we take care also not only to percuss at symmetrical points, but to percuss with equal strength, and somewhat moderately.

We first percuss the supraclavicular depressions, first on the right,

then on the left, whereby, in cases where it is of special importance, we determine the upper boundaries of the apices of the lungs; then, in the same way, the infraclavicular spaces are percussed; on the two sides in finger-percussion we must, if possible, hold the pleximeter hand in such way as always to have the wrist toward the middle line of the thorax and the pleximeter finger pointing outward.

Then we percuss the third intercostal space right and left, then downward only on the right, and usually only in the intercostal spaces. We do not further compare it with the left side, since the heart lies here, which is percussed by itself. Then follows the determination of the right lower border of the lungs according to the rules given above regarding the determination of parietal organs. We percuss upward, comparing the two sides of the thorax, again in the intercostal spaces. When we wish to percuss high in the axillæ, the arms are to be abducted. Then follows the determination of the boundaries of the right and left borders of the lungs in the middle axillary lines. Sometimes it is valuable also to percuss from the infraclavicular spaces sideward and downward upon a line which is at right angles with the course of the ribs.

In percussing the back we first compare the sound over the apices of the lungs, thus completely defining their upper boundaries; then we percuss on the right and the left, comparing corresponding intercostal spaces as we proceed downward to the lower borders of the lungs. Then we percuss on the sides of the spine below the angles of the scapulae, comparing symmetrical points. The boundaries of the lungs are best determined in the scapular lines.

In this way the thorax is generally to be percussed. But the presence of pathological conditions that require one to be especially careful in the examination of certain parts may give the preference to special methods of examination. These have been in part already mentioned in the general division. They follow directly from what was said there. They will be again mentioned in the description of percussion in pathological conditions of the lung.

2. *Normal Sound over the Lungs, Trachea, and Larynx. The normal boundaries of the lungs.*

It is shown that in percussion of the lungs in general over the normal lung there is elicited a non-tympanitic sound. But this sound

as regards its intensity is *individually very different* in different persons, also, in each single chest it is not alike throughout, but exhibits individual *regional differences*.

The individual variations arrange themselves first according to the amount of fat. Very fat bodies give a less clear thoracic sound, or in order to yield a clear sound they must be percussed more strongly, requiring perhaps the use of the hammer; but it is evident, as we have said, that this is unfavorable for determining the boundaries, for which the rule is to employ very light percussion.

Farther, the percussion-note of the chest differs *according to age*: with children, having a more elastic thorax, as well as with aged persons with thin structural coverings and somewhat lax or rarefied lungs, it is higher in pitch than in persons in middle life.

But also in the individual thorax the different regions normally give different clearness of sound. In other words, one region compared with another yields a relatively deadened sound, and according to the two chief points of view previously mentioned, namely, according to the varying thickness of the covering and according to the size of the lungs. Hence we remark the following facts:

(a) Over the apices of the lungs, even with strong percussion, the sound is not very intense; for though the covering is thin, the volume of the lung tissue is small.

(b) In the infraclavicular spaces, and still more in the second intercostal spaces, the sound is very intense (covering thin, more lung tissue).

(c) *Farther down*, not only in the male, but in still higher degree in the female, the sound is deadened by the pectoral muscle or by this and the mamma; in the female the sound may be absolutely deadened over the mamma; and this notwithstanding the fact that the lung-tissue is here very considerable.

(d) *Upon the back*, the apices yield a sound of very slight intensity, since here there is a very small volume of lung and a very thick body of muscle. *Over the scapulæ* there is likewise a very deadened sound, at the spine, and directly below, even a thigh-sound. In the *interscapular spaces* the sound is clearer.

(e) *Below the scapulæ* and at the *sides of the chest* the sound is very intense.

(f) Strictly speaking, here also belongs the description of the so-called "*relative heart and liver deadening.*" (See page 124.)

Now, it is further very important to know which similarly situated points on the thorax normally give the same kind of sound, since it is especially by comparative percussion that we seek to ascertain the presence of disease on one side. We may say that in healthy people marked *dissimilarity of sound* at symmetrical parts of the chest on the right and left sides exists only:

In the neighborhood of the heart, as compared with the corresponding part on the right.

At the two sides: on the left side normally the sound, almost as far back as the spine and forward in front at varying height as far sometimes as the fourth rib, is often clearer than on the right, and of somewhat tympanitic tone (combining with the sound of the stomach or colon).

In addition, there is a slight inequality sometimes *posteriorly over the apices*. In right-handed persons, the sound on the right side at that location may sometimes be met with a little less clear, because the muscles are somewhat more developed. On the left side, in left-handed persons, the case is reversed.

Lastly, it is necessary to mention a point of greater importance—that over the *whole sternum* there is a clearer, non-tympanitic sound, even where there is no lung-tissue at all, as at the upper part of the manubrium (trachea) and over the left half of the lower part of the corpus sterni. The sternum acts as an unusually thick pleximeter, and yields therefore throughout, and in equal strength, the sound of the lung lying in contact, spread out over its inner surface.

The *larynx* and *trachea* in the neck in front give the tympanitic sound of a hollow cavity with smooth walls. This has the peculiarity of being higher and more plainly tympanitic with the mouth open than with it closed (Williams's tracheal tone, tracheal change of sound). The cause of this phenomenon is not quite clear; the explanation given by Neukirch, and accepted by Weil, is based upon the assumption of the resonance of the mouth changing with its opening and closing. This will be referred to later.

NORMAL PERCUSSION-BOUNDARIES OF THE LUNGS.—It is not possible to define the boundaries of the lungs perfectly by percussion. Moreover, by percussion we can only establish:

1. The *apices* so far as they rise above the clavicle: they are distinguished by their clear sound in comparison with the deadened sound of their surrounding soft parts.

2. The boundaries of the left lung at the *incisura cardiaca*: the lung sound from the absolutely deadened sound of the heart—the *lung-heart boundary*.

3. *The lower borders of the lungs*, this especially at the lower border of the right lung: the lung sound marks the boundary of the absolutely deadened sound of the liver—the *lung-liver boundary*.

FIG. 22.

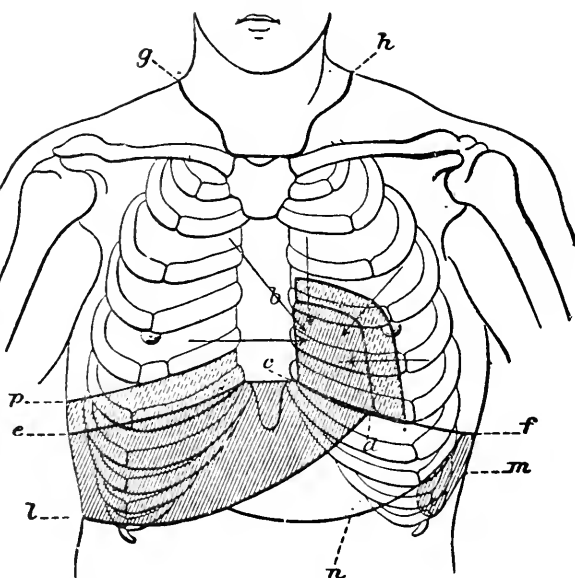

Boundary of the lungs as determined by percussion in front. (After WEIL.) *g h*, the extent of the lung upward; *c f*, the lower limit of the lungs; *b d*, the relations of the lung and heart at the *incisura cardiaca*. The strongly-hatched surface represents the portions of the heart and liver which are parietal; the lighter hatching shows the so-called relative heart and liver deadness. (See below.)

At the lower border of the left lung, first about from the mammillary to the middle of the middle axillary line, the lung sound marks the boundary of the tympanitic sound (stomach, or more rarely also intestines)—*lung-stomach boundary*; next, the lung sound from the deadened sound of the spleen—*lung-spleen boundary*; and,

lastly, from the deadened sound of the kidney—the *lung-kidney boundary*.

It is difficult to determine the boundaries of the lungs, since the difference of sound is often slight, especially as the tympanic sound of the stomach often mingles with the lung sound higher up than the anatomical border of the lower limits of the lung; moreover, the lower boundaries of the lungs close up to the spine on both sides, because of the thick layers of the erector spinæ, require strong percussion, and this is unfavorable for determining the boundaries. (See above.)

FIG. 23.

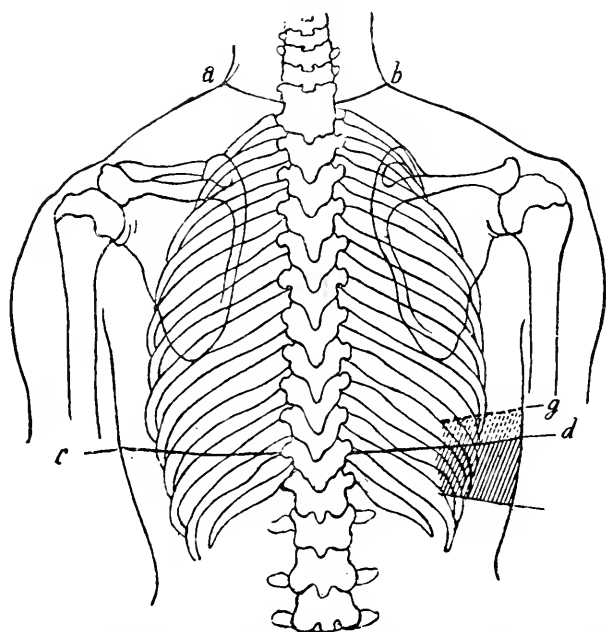

Boundary of the lungs as determined by percussion upon the back. (After WEIL.)
a b, the upper limits of the lungs; *c d*, lower limits.

We cannot determine by percussion the front borders of the lungs behind the sternum. This is the case because the lungs lie close to each other for some distance there, and also because the sternum, like a firm bone, yields a uniform sound and it is not possible to recognize a difference of sound in what lies beneath it: it yields throughout a clear sound, very like the lung resonance over the ribs.

Hence, it may also be explained that the lower part of the anterior border of the right lung, which behind the sternum is limited by the heart, cannot be defined by percussion: we much more receive, instead of the actual boundary of the right lung, one that is apparent—where the uniform sternal sound is exchanged for the absolutely deadened sound of the heart at the left border of the sternum. In front the base of the right lung does not extend so far down as the left—the right coming as low as the inferior border of the fifth rib, while the left corresponds with the superior border of the sixth rib.

Relative heart- and liver-dullness. The determination of the lung-heart and the lung-liver boundaries is made more difficult by the peculiar circumstance that, on account of the small volume of lung-tissue at the border of the lungs, the resonance of the lungs immediately over the borders has very slight intensity, a relatively deadened sound. We percuss from the lung toward the liver with strong or moderately strong strokes, and find, say in the mammillary line at the fifth rib, a strong relatively deadened sound which the beginner is inclined to regard as absolute liver-dullness. But this, as has been said, corresponds with the thinning of the lungs at the lower border. In this way a zone of relative dullness manifests itself over the whole of the lower border of the right lung, except close to the spine behind, and in a similar but somewhat smaller zone the heart-dullness bows round and to the left: this is the (incorrectly) so-called relative liver- and relative heart-dullness, as indicated by the light shading in Figs. 22 and 23. Also, sometimes, there is such a relative dullness over the lung-spleen boundary. It does not exist over the lung-stomach boundary, because here, by moderate percussion, the coincident sound of the stomach causes a low tympanitic sound.

These zones are diagnostically important only in isolated cases, and they have nothing to do with enlargement of the heart, liver, or spleen.

In order to avoid deception by these conditions, when determining the boundaries it is necessary to take care:

1. To percuss lightly in determining the boundaries of the lungs.
2. To mark the lung-heart and the lung-liver boundary, that is the border of the lungs where the relative dullness passes into absolute dullness, or, in other words, where, in percussing from the lungs toward the heart and the liver, the dullness begins to be so marked that it no longer increases.

On the average, that is, in middle life, we thus find (compare Figs. 22 and 23): *the lung-liver boundary* in the mammillary line at the sixth, in the middle axillary line at the eighth, in the scapular line at the tenth rib; *the lower border of the left lung*: in general as high as the right only in the mammillary line at the lower border of the sixth rib; *the lung-heart boundary*: at the fourth rib and more or less just without the parasternal line; *the upper limits of the apices of the lungs*: three to five cm. above the clavicle.

Differences by reason of age. In children, the lower border of the lungs is from a half to a whole intercostal space higher; in old persons, it is that much lower (Weil). There is a like difference as regards the lung-heart boundary. That is, the lungs increase with the years, as compared with other organs.

Displacement of lower border of the lungs is manifest by percussion:

1. In deep inspiration and expiration (active mobility): in the middle axillary line the lower border sinks with deepest inspiration about three to four cm.; in the mammillary and scapular lines about two to three cm.; in deepest expiration it rises up not quite so much above the average location (Weil). With deep inspiration, at the incisura cardiaca the lung moves so as quite to cover the heart; and it may even entirely obscure the heart dulness.

2. In change of position (passive mobility): when lying upon one or the other side the lower border of the lung of the opposite side moves down as much as three to four cm. (Gerhardt, Salzer, Weil).

3. *Abnormal Sound over the Lungs. Abnormal position of the border of the lungs.*

A. DULLNESS: DEADENED RESONANCE.—In order not to overlook slight deadening we must remember what was said upon comparative percussion on page 124; if the comparison with the opposite side is inadmissible, as when both sides are diseased, then the comparison is made with the adjacent parts upon the same side, bearing in mind the normal regional differences of intensity of sound.

Thus, in *disease of both apices* we sometimes recognize the deadness of the apex to be less affected by comparing the resonance over the latter with the percussion-resonance a little lower down; remembering that normally the resonance over the first and second inter-

costal spaces must be clearer than in the supraclavicular space, and clearer than over the third intercostal space.

But also, without further consideration, we must not designate every deadness as due to an internal organ, but consider the deadening influence of a sharply-bowed rib, etc. *Slight deadening*, without any other pathological evidence, especially over the apices, is to be given value with very great caution.

(a) Resonance is deadened by the development of airless tissue in the lungs either by condensation or by solid new formations in them.

In *croupous pneumonia* the lung-tissue in the height of the disease is in the stage of hepatization. Generally in a large region it is completely deprived of air through the filling of the alveoli with inflammatory exudation. An *intense deadening* is coëxtensive with this condition. It seldom becomes absolutely deadened like the thigh-sound, but there can generally be recognized a slight tympanitic tone. The *feeling of resistance* is generally likewise correspondingly increased, but not so much as is the case with a pleuritic exudation.

Thigh-dulness and very marked feeling of resistance may exist with *croupous pneumonia* if, besides the lung-tissue, the bronchial tubes of that part of the lung are likewise completely filled with the exudation ("massive pneumonia"), or if the croupous pneumonia is complicated with a large pleuritic exudation, which is then almost always behind and low in the chest. The extent of the deadening in croupous pneumonia very frequently corresponds with a lobe of the lung, because of its being a lobar pneumonia, or there is evidence of an enlargement of the lobe in all directions (the inflammatory exudation spreads out to a considerable extent). Often, therefore, in this disease we may recognize the boundaries of the lobe in the figure of the area of deadening, or the boundaries which correspond to the tracing of the lobe enlarged in all directions. The infiltrated part of the lung may, however, be also smaller, especially on the surface of the lungs, occupying so small an extent as not to cause any recognizable deadening. Auscultation (which see) here leads to a conclusion sooner than percussion.

In the neighborhood of an infiltration the resonance is generally abnormally loud and deep, even slightly tympanitic (compare what is said of croupous pneumonia under B. Tympanitic Sound).

Since the infiltrated lobe of the lung is somewhat larger than

normal, sometimes in pneumonia of the whole lower lobe deadness will be found posteriorly as far up as the apex without the apex being involved. Percussion upon the front of the chest then yields a very loud, deep sound over the upper part of the upper lobe. Further, for the same reason, in pneumonia of the left lower lobe the lower borders of the deadness may overstep the region of the normal boundaries of the lungs, as the marking out of the lung-stomach boundary then shows that the so-called "halfmoon-shaped space" is somewhat smaller. (See under Digestive Apparatus.)

Also in *catarrhal* or *lobular pneumonia* and tuberculosis (in the so-called infiltrated tuberculosis of a larger part of the lungs) there may be an extended thickening and a corresponding deadening. Often, indeed, there are pathological deposits so small that their presence is not revealed by percussion; but though widely scattered, they are interspersed with points still containing air and hence give a clear sound. Then, because the tissue of the parts still remaining normal is somewhat lax, the resonance is often tympanitic. Or, the latter sound is mingled with that of deadness from the infiltrated parts—the tympanitic deadened sound.

In *tuberculosis of the apices* of the lungs there is, at the beginning, in very slight measure, a mingling of thickened parts with tissue containing air, but relaxed; hence the resonance in the beginning over the diseased apex is very often tympanitic or tympanitic-deadened, in comparison with the healthy apex. Moreover, there is early retraction of the upper boundary of the apex upon the affected side. (See under Diminution of the Boundaries of the Lungs.)

Large hemorrhagic infarctions and sections of the lungs compressed even to the point of not containing any air, as from pleuritic exudations, tumors, and large pericardial exudations, may likewise give a deadened sound. Finally, it is conceivable that solid tumors of the lungs (sarcoma, carcinoma) produce the same effects in case they lie upon the surface or attain to a certain size.

(*b*) Resonance is deadened by the presence of a deadening medium over the lungs—that is, between it and the percussing finger.

Most important of these is *pleuritic exudation*. Generally, this first appears low down posteriorly in the complementary space and above it, and if it amounts to as much as 400 cubic cm. it may even be recognized by light percussion. Corresponding with the increase of

the exudation the area of deadness will gradually become more extensive; its limits ordinarily correspond with a fluid surface which, while the patient is in the posture most frequently assumed, is somewhat horizontal; that is to say, in bedridden patients the fluid levels itself high up on the posterior wall of the thorax, and the limits on the sides and in front drop off sharply; while with people who are much out of bed, or may still be at work, the fluid stands equally high in front and at the back of the chest. When the effusion is very large the deadness may extend even to the apex, both anteriorly and posteriorly. It quickly becomes, with considerable effusion, an absolute deadening and with the most marked feeling of resistance.

Corresponding with the increase of the fluid the lung becomes lax in an ever-increasing area, since it may then follow its elastic traction; immediately over the fluid it gives deadness, and when there is a large exudation, where at least there is ordinarily left a district with clear sound, namely, high in front, it yields an abnormally loud and deep, or a tympanitic sound, sometimes cracked-pot sound (see page 134). A very large exudation may even compress the lung to such a degree as to expel all air.

When there is a certain amount of exudation its weight presses upon the diaphragm, increases the affected pleural cavity toward the side, presses out the side of the thorax (see above), and pushes the mediastinum and the heart over toward the sound side (see Displacement of the Heart). The downward pressure of the diaphragm in cases of pleurisy of the right side is recognized by the liver being lower (see Percussion of the Liver). In pleurisy of the left side, it may directly be made out by locating the upper boundary of the so-called "halfmoon-shaped space."

When the pleural surfaces directly over the exudate are glued together, then in change of position of the patient the pleuritic exudation is not movable, and the boundaries of the deadness are therefore not changeable; not infrequently the exudation is entirely "capsulated" by the adhesion of the pleural surfaces. If the exudation is reabsorbed, then the evidences of expansion and of displacement, on the one hand, and the deadness (and, indeed, according to its extent, likewise its intensity), on the other hand, steadily disappear. Often

the upper border of deadness then shows as a bowed line with its convexity upward (Damoiseau's curve).

If a new pleuritic exudation takes place between pleural surfaces already adherent from a former attack, then, of course, it remains confined within the space thus prepared—"encapsulated, circumscribed pleurisy." The boundaries of the exudation may, in these cases, take a very varying course.

Hydrothorax practically gives rise to similar appearances; but it is generally on both sides, yet not infrequently with a very different amount upon the two sides. Further, hydrothorax always shows in change of position, although only after a certain time, a change of its relation to the thorax in such a way that it tends to take possession of the part of the thorax that, for the time being, is the lowest; accordingly, there is what may be called a passive mobility of the boundaries of deadness.

Serous or purulent, or ichorous, effusion into the pleural cavity complicating pneumothorax (sero-, pyo-pneumothorax) is distinguished from the above by its mobility with the change of posture. It behaves like the water in a bottle when the position of the latter is changed; in every situation the fluid maintains a horizontal surface, and occasions at the same time, with every change of place or location of the thorax, a prompt variation of the upper boundaries of the deadness.

Further, a deadening of the resonance is occasioned by the *thickening of the pleura*, which either remains after an exudative pleuritis or in conjunction with processes slowly going on in the lungs. The latter is the case very frequently in tuberculosis of the apices of the lungs; marked deadening, appearing early in the beginning of the disease, is generally caused by pleural thickening. The intensity of the deadness is determined by the amount of the thickening; it may even become like thigh-deadness. The feeling of resistance is generally very markedly increased; with very thick deposit this is positive. Tumors, as a matter of course, likewise cause deadening. This latter deadening generally exhibits an irregular boundary, if it is not, as is rarely the case, complicated by pleuritic exudations.

It is sometimes very difficult to distinguish between a thickened pleural surface and a portion of pleural exudation left behind with moderate thickening; this question often especially arises where the

deadness is low down posteriorly. In arriving at a decision the first thing to consider is whether there is expansion or contraction, or whether there is a deep or a high position of the diaphragm.

But here, as well as in the often very difficult differential diagnosis between pleural exudations and tumors, as of the lungs, pleura, or chest-wall, the application of the explorative puncture is the best means of deciding.

Finally, the resonance of the thorax is deadened by all processes in the chest-wall which lead to its being thickened—tumors, peripleuritis, œdema.

The second quality of sound which is found over diseased lungs is

B. TYMPANITIC SOUND.—(a) It occurs, pathologically, if the lung is in a state of elastic equilibrium: we know that this condition is a consequence of retraction of the lung: with large pleuritic exudation as well as shrinking in connection with pleurisy; further, in all other affections of the chest which decrease its capacity. Hence tympanitic resonance exists over the lungs in the neighborhood of tumors of all kinds: sometimes in the neighborhood of the heart in exudative pericarditis, more rarely in hypertrophy and dilatation of the heart; lower in the thorax: in diaphragmatic pleurisy; in high position of the diaphragm from subphrenic tumors, abscesses, etc.; and in general peritonitis, general distention of the abdomen from ascites, tumors, etc.

We may also think of the same condition of approaching equilibrium of elasticity as arising from *relaxation* of the lung-tissue (Weil); and this will explain the tympanitic resonance that exists with *croupous pneumonia* in the stage of engorgement and resolution; over many small *catarrhal-pneumonic* and *tubercular deposits*, since the intervening tissue containing air has become lax; and finally, in *œdema of the lungs*.

(b) In consequence of marked shrinking and thickening of the lung, in strong percussion of the supraclavicular fossa, it arises from the trachea, while in percussing the first or second intercostal space it arises from this or the primary bronchus, directly from the percussion-blow, and so the broncho-tracheal column of air is put in vibration; thus arises a peculiar change of sound in the trachea, the

sound with the mouth open being more distinctly tympanitic and higher (Williams's tracheal tone).

(c) *Over cavities within the lungs, caverns (vomicae).*

We may have here, according as the cavity does or does not communicate with the outer air by means of a pervious bronchial tube, the *open* or the *closed tympanitic resonance*. In the former case the sound is under all circumstances more distinctly tympanitic and also more intense; in the latter case, on the other hand, much less distinct and weaker, all the more since we must assume that the cavities, because they lie in the thorax, have more or less stiff walls, and since the rigidity of the wall with the cavity closed hinders the condition that causes the tympanitic sound.

How large the cavity must be in order to give a tympanitic sound it is not possible exactly to state, since besides the size, the situation of the cavity (whether parietal or deep), the amount of fluid secretion it contains, its walls (whether smooth and vibratory), the condition of the surrounding lung-tissue, and finally the vibratory capacity of the given thorax must also be taken into consideration. Generally, cavities occurring in the apices from tuberculosis exhibit more distinct physical characteristics than cavities in the lower portions of the lungs, which frequently are of the nature of bronchiectasis, since the former, even when of moderate size, must reach to the surface of the lungs, and generally have thickened walls. Cavities as large as a walnut in the upper parts of the lungs generally give a distinctly tympanitic resonance.

If the cavity is very large with relatively smooth walls a metallic tone is added to the tympanitic resonance.

If the cavity is covered by thickened lung-tissue or with thickened pleura (this very frequent) then the sound becomes *tympanitic-deadened*; if by a very thick layer of airless tissue, absolutely deadened.

Temporarily marked filling of the cavity with secretion deadens the tympanitic sound also, sometimes even to absolute deadening; further, the sound becomes temporarily indistinctly tympanitic and deadened-tympanitic if a bronchus connecting with it, otherwise open, becomes closed (with secretion or from dipping below the fluid contents of the cavity).

Under different conditions tympanitic sound over a cavity may change its pitch:

1. The so-called simple Wintrich's *change of sound*. The tympanic sound becomes louder, more distinctly tympanic, and higher, if the patient opens the mouth wide (and, what is desirable, at the same time protrudes the tongue a little). This can only occur over those cavities that freely communicate with the broncho-tracheal column of air.

We percuss, not too strongly, while the patient lies or stands quietly and alternately opens and closes the mouth; but it is necessary for the patient to breathe as superficially as possible, or we must compare the sound in the same stage of the breathing, since the sound also sometimes changes its pitch according to the stage of the breath (compare under 4. Respiratory change of sound).

The explanation of this symptom, as of the tracheal change of sound which is exactly similar, is that it is from the change of consonance of the mouth-throat cavity.

This Wintrich's change of sound may also occur over cavities in such a way that the sound with the mouth closed is markedly deadened, with only a trace of tympanic sound (especially with marked callous formations over the cavity), and only with the mouth open does the sound become tympanic (at the same time becoming louder and noticeably higher).

I would like, therefore, in opposition to Weil, to insist that we ought, if there is only a slight possibility of the existence of a cavity, and also in the case of tympanic sound slightly distinct, even indistinct, with dulness, to apply the test of Wintrich's change of sound.

It is very easy to confound the *simple Wintrich's change* of sound with Williams's tracheal tone. We should take notice: (1) Whether there is very marked contraction, when it is much more likely to indicate change of sound than Williams's tracheal tone. (2) Whether in order to cause the change of sound only weak percussion (cavity) or strong percussion (trachea or bronchus) is required. (3) Whether there are other symptoms of a cavity.

Simple Wintrich's change of sound points with greater probability to a cavity. But its value as an indication is diminished by the above-mentioned possibility of being confounded with Williams's tracheal tone.

2. Interrupted Wintrich's change of sound (Gerhardt, Moritz). It

is distinguished from the simple in that in some positions of the body it is plain, in others it is indistinct or is wanting. The explanation of this is that in one position the bronchus leading to the cavity is open, while in the other it dips into the secretion in the cavity and so is closed. In this way the tracheal change of sound cannot possibly be interrupted

This change of sound is very rarely met with, but it is to be regarded as a positive sign of a cavity.

3. *Gerhardt's change of sound.* A tympanic sound changes its pitch if the patient changes his posture (upright, dorsal, side position); and sometimes, if the patient changes from the dorsal to the upright

FIG. 24.

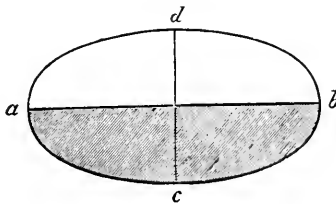
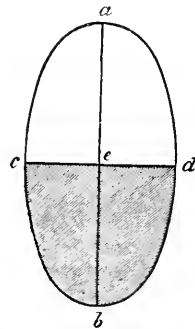

FIG. 25.



Gerhardt's change of sound.—Schematic representation of the behavior of the contents of a cavity with a change of position of the body of the patient.

position, the sound becomes deadened-tympanic or absolutely deadened over the lower part of the cavity, because in this position the fluid contents of the cavity come into contact with the chest-wall.

Gerhardt's change of sound may take place over communicating, as well as over closed, cavities. The change of pitch, in case the cavity is open, may have very different causes, which we will not discuss here. In closed cavities it is really due to a change in the tension of the chest (and cavity?) wall, perhaps also to a change in the size of the part of the cavity containing air—a change caused by different location of the secretion. (See Figs. 24 and 25, from *Weil's Handbook.*)

Gerhardt's change of sound is in every form an almost certain symptom of a cavity, but, like the former, it is very rare.

4. *Friedreich's or the respiratory change of sound:* the sound

becomes higher at the height of a deep inspiration. This occurs not alone over cavities, but may be observed in any case of tympanitic sound over the lungs. It depends upon the increased tension during inspiration of the chest-wall and lung-tissues, likewise of the wall of the cavity.

It does not have diagnostic significance. But it is important to know it in order that we may not be misled by it in the examination of other changes of sound; therefore, we ought in testing this to observe the rule to percuss during very superficial breathing, or still better always to percuss at the same stage of the breathing, as has been said above.

(d) Finally, the *tympanitic sound* occurs in very rare cases in pneumothorax and sometimes entirely in cases that have permanent and completely-open fistulæ; this "open" pneumothorax is generally circumscribed. In pneumothorax the tympanitic sound may sometimes exhibit Wintrich's change, since the physical conditions upon which it depends are also present, as in large communicating cavities: open communication of an air-space with the broncho-tracheal column of air. Here we have also metallic tone (see p. 135).

Cracked-pot sound (bruit de pot fêlé). It seems that this is the most suitable place to describe this phenomenon, which, while very surprising and remarkable, is of very subordinate diagnostic significance. It consists of a peculiar click ("clinking of coin" or "trembling"), which sometimes accompanies the clear sound and indeed generally the tympanitic, more rarely the clear, non-tympanitic. It corresponds to the noise which occurs when we strike a cracked plate or pot, or when we hold the palms of the hands together lightly and then strike them upon the knee. It occurs in the thorax if an instantaneous current of air of a given force is driven from the lungs against the larynx by the percussion-stroke, or if during expiration a stream of air flowing outward is for a moment suddenly sharply arrested. This symptom requires strong percussion, yielding thorax, and thin covering (generally in front superiorly, and also below posteriorly). It occurs sometimes in normal cases, especially in children.

Pathologically it occurs:

1. Over *large parietal cavities*, here often remarkably intense.
2. In *pneumothorax with open fistula*, especially if circumscribed.

3. Over *pneumonic deposits*.

4. Over *retracted lung tissue*, especially above large pleuritic exudations (high in front), rarely in the neighborhood of thickened portions of lung.

This phenomenon is always more distinct if we percuss during expiration; very often, especially in case of cavity and open pneumothorax, it becomes louder by opening the mouth.

As above remarked, this symptom has almost no diagnostic meaning, since it is present with such varying conditions.

The noise is caused by a swift current of air striking at a narrowed point; this happens at the glottis, in a cavity at the mouth of a bronchus, and at the puncture in the pleura in case of pneumothorax. Sometimes a rattling sound is mingled with the trembling ("the moist cracked-pot sound").

C. ABNORMALLY LOUD AND DEEP SOUND.—This occurs :

1. In *severe emphysema of the lungs*, designated as "band-box note" (Biermer).

2. In *decreased tension of lung tissue* above a pleuritic exudation : a zone of this abnormal sound lies just above the line of deadness produced by the exudation in the neighborhood of pneumonic thickening—as anteriorly in pneumonia of a whole lower lobe; sometimes in the neighborhood of the heart in pericarditis exudativa, but also with dilatation and hypertrophy; likewise, and especially, in the neighborhood of encroaching tumors, and with a high position of the diaphragm consequent upon abdominal affections.

As was said before, in most of these cases, if the tension of the lung-tissue is very considerable, tympanitic resonance may arise (see p. 130).

3. *With pneumothorax*. Here the sound, in consequence of the strong tension of the chest-wall, is almost always non-tympanitic, loud and deep. Only (a rare case) in open pneumothorax, especially if it be circumscribed, is tympanitic sound sometimes met with (see p. 134).

This abnormally loud and deep, even tympanitic sound of pneumothorax gives almost regularly the metallic sound, only seldom recognizable, however, by the ordinary methods of percussion, but very admirably by the *rod-pleximeter percussion* described by Heubner.

Mode of application. Rod-pleximeter percussion is best conducted by two examiners. One strikes with the handle of the percussion-hammer, or with a pencil upon a pleximeter; the other auscults the thorax. If both manipulate over a pneumothoracic cavity the second hears the strokes as the finest metallic, generally a silvery, clear ringing.

This, moreover, is sometimes also observed with very *large and smooth-walled cavities* with thin covering. With pneumothorax accompanied with fluid (pyo-, sero-pneumothorax) the metallic sound, almost without exception, changes its pitch with the change of position; in sitting up it is generally deeper, but sometimes also higher (Biermer's change of sound). If the effusion is so large as entirely, or almost entirely, to fill the pleural cavity of course the metallic sound disappears.

It will be mentioned in the appropriate sections that this metallic ringing in pneumothorax not only accompanies such an artificially created noise, but also may be present with rhonchus, respiratory sound, and heart-sound.

D. CHANGED CONDITION (AND DIMINISHED POWER OF DISPLACEMENT) OF THE BOUNDARIES OF THE LUNGS.—(a) *Extension of the boundaries of the lungs* takes place in *emphysema*: the lower borders usually move sidewise and deeper, both front and back, in the most marked cases. The mammillary line will be at the eighth rib, the axillary line at the tenth, the scapular line at the eleventh or twelfth. Heart-deadness may also or quite disappear, from the expanded lung lying over it from the side. At the apices of the lungs sometimes a slight enlargement of the lungs may be made out; in rare cases even expansion of the apices may likewise take place (as after whooping-cough in children). "Relative liver-dullness" and "heart-dullness" is very small; simultaneously with the expansion, the lung loses its power of displacement, both active and passive, even past recognition.

One-sided downward movement of the boundary of the lung occurs in vicarious emphysema, but the capacity to change its boundaries is preserved in this case.

Apparent one-sided expansion of the boundary—that is to say, the appearance of a clear sound upon one side quite beyond the normal boundary of the lung—takes place in diffuse pneumothorax: the

lower border of the clear sound is sometimes met with even deeper than in emphysema; this border is immovable, and always very sharply defined. The side of the thorax is expanded, the heart and also liver are displaced, or the tympanic sound of the "half-moon-shaped" space is replaced by the sound of pneumothorax. Displacement of the mediastinum in right-sided pneumothorax is generally distinctly recognized by the change of sound between it and the left lung (the boundary-line lies to the left of the upper part of the sternum).

(b) *Diminished volume of the lungs* is shown by the lower boundaries of the lungs being higher than normal on both sides, by the diaphragm being pressed up from below or from its being paralyzed; one-sided diminution, by shrinking from disease of the lung or a past pleurisy. The motility of the borders is thus diminished or destroyed. The liver stands correspondingly higher (see Liver), or the "half-moon-shaped" space is enlarged.

Sometimes diminution in size of an apex in phthisis manifests itself by the deeper position of the upper border of the lung upon one side.

(c) *Diminution of the motility alone*, especially during respiration, without change of the average condition of the borders, sometimes exists low down posteriorly as the *first symptom of pleurisy*, and also as the only sign of a past pleurisy, in which case it is noticed along the whole lower border of a lung or a part of the same, as at the heart; here, also, it is a residuum of pericarditis externa. (See Examination of the Heart.)

Retraction of the lungs in the neighborhood of the heart by shrinking permits the latter to come in contact with the chest-wall to a larger extent than normal; there is displacement of the heart-border of the lung to the left and upward, and, hence, hypertrophy or dilatation of the heart may at first be mistaken for the real condition. (See Heart.)

On the other hand, diseased conditions in the neck (tumors, scars, etc.) may influence the position of the apices, and thus at first may deceive the inexperienced in leading him to conclude that there is one-sided shrinking of the lung.

AUSCULTATION OF THE LUNGS.

1. *History. The Sphere of Auscultation at the Present Time.*

It now appears to us very strange that the idea of percussing the body was only so lately brought into medical practice. It is yet more difficult to understand that *methodical auscultation of the body* is only a child of the most recent time. It is true that Hippocrates heard what he named a succussion-sound, and also, no doubt, rattling and rubbing sounds: but to the two latter he did not attach any great importance, and in all the centuries from the Greek physician to the time of Laennec no real attention was given to the audible phenomena of the healthy and diseased body. Only a few voices—that of the often-mentioned Hooke more than any other (second half of the seventeenth century)—were timidly raised, and these were not heeded. Only in consequence of the discovery and general consideration of the value of percussion was auscultation developed, and this by Laennec, the discoverer of the stethoscope. His epoch-making work is called *Traité de l'Auscultation médiate et des Maladies des Poumons et du Cœur*. After him, Skoda, by critical sifting and by his own efforts, which traced the new phenomena to their physical causes, rendered imperishable service to this branch of knowledge. But up to the present time the work has still been going on, which, in part, has made new discoveries, and, in part, has investigated the nature of what was already known.

The sphere of auscultation—of listening—in its widest sense extends to all that we are able to take note of by the ear, hence, in the first place, to the voice, cough, noises caused by breathing, by mucus in the upper air-passages, which may often be heard in the furthest corner of the sick-chamber. But, strictly speaking, auscultation concerns only those phenomena which the ear perceives, either by direct application to the body or which are brought to it by an instrument, as a stethoscope or an ear-trumpet. These, so far as they refer to the respiratory apparatus, form the subject of the following section.

2. *Methods of Auscultation.*

Nowadays we employ both immediate (direct) and the mediate (indirect) auscultation. In the first, the ear is directly applied to the

person to be examined; in the latter, we employ a stethoscope or ear-trumpet. While, as will be referred to later, we employ almost exclusively the indirect method in examining the heart and vessels, both methods are applied in the examination of the respiratory apparatus, and particularly of the lungs. In applying both, where it is possible, we must endeavor to have the body bare; in no case should the covering be more than a single thickness, and that should be as thin as possible, and must be perfectly smooth. [By the use of a solid—a wooden or hard-rubber—stethoscope it is not absolutely necessary to remove the clothing; by pressing the instrument *firmly* against the chest with the fingers friction of the clothing is prevented.]

The application of the ear to the body consists simply in laying the ear lightly over the particular part to be examined. In order to place the ear exactly over the spot which we wish to auscult, it is well to place the tip of the index-finger at the point and keep it there until the ear is placed at the point indicated, when the finger is withdrawn. For stethoscopic auscultation, almost universally used in Germany at the present time, preference is given to the simple hollow stethoscope, the tube being about twelve to eighteen cm. long, with a not too small ear-plate. No doubt the plate has this disadvantage—unless the examiner is sufficiently careful—that it does not lie smoothly upon the outer ear; but, nevertheless, it is the most suitable form, since the stethoscope with hollowed ear-pieces, especially those recently devised, which, embracing the head of the auscultator, lie over the whole outer ear, for most persons have a most disturbing roar—a disadvantage which quite outweighs the advantage that, by increasing the resonance, it so well conducts the noises from the body; and the cone-shaped ear-pieces which are inserted into the outer ear, in the short stethoscopes with stiff tubes, cannot long be borne by the examiner.

These stethoscopes may have the further peculiarity that the end that rests upon the body measures, on the average, not more than two to five cm.; hence they conduct to the ear impressions of sound from a much smaller region than will be heard from by direct auscultation. They are made of various material (wood, hard rubber, ivory), but this is of small importance. The *flexible stethoscopes* (rubber tubing instead of the stiff tube, and ear-cones instead of the ear-plate) come less into use because it is difficult, at least in the beginning of their use, to exclude the marked noises that are associated with them. Of

the *double stethoscopes* I only mention that of Camman, since it is decidedly very useful; but it is a complicated instrument.

In general the use of the stethoscope resembles the practice of percussion in that everyone, especially while learning, ought always to use the same kind of instrument, in order that he may learn to judge correctly of the auditory impressions which his instrument furnishes. In my teaching I have always found that those students who each time they wished to make an examination had to borrow an instrument from their fellows did not hear anything.

There are a large number of forms of stethoscopes, especially of the hollow stiff ones, the separate models of which it is not possible to describe. It may be remarked that the microphone has recently been employed.

P. Niemeyer's solid stethoscope with ear-cones (acuoxylon) is decidedly not to be recommended; it has not proved practical, nor are the theoretical grounds of its construction sound.

It is very important in the beginning not to make pressure with the stethoscope. Hence it is advisable to steady the instrument with two fingers, and not to hold it in place with the head.

As was said above, it is decidedly to be recommended in the examination of the lungs to employ both direct and indirect auscultation. The former is here preferable, since by it we can generally listen at one time to a large region of the lung; hence it is on the one hand more comprehensive, and on the other hand furnishes collectively louder sounds. Moreover, in the examination of the chest posteriorly of very sick patients it cannot be dispensed with, since by its comprehensiveness it furnishes the means of conducting the examination with the necessary quickness. On the other hand the stethoscope is employed:

1. Where the ear cannot be applied, as over the supraclavicular spaces.

2. If we wish to listen quite separately to noises existing in a narrow limited space.

3. Sometimes from reasons of delicacy, as over the female breast.

4. If the physician wishes to avoid being soiled, the risk of receiving or getting parasitic insects, or infections.

In a general examination it is well to auscultate after percussing. After percussing the front of the chest, auscultate over the same

region and then percuss and auscult the back. Generally the patient should breathe deeply; it is not at all preferable to have him breathe very hard and quickly. Not infrequently we hear best with moderately deep breathing. Where it is possible, as in percussion, symmetrical parts should be compared. The particular points where it is necessary to take care are described in the following section.

3. *Auscultatory Signs in Normal Respiration.*

1. *Sound of bronchial breathing.* If we auscult the larynx or trachea of a healthy person during inspiration and expiration we hear a loud aspirating sound which corresponds somewhat exactly with that we can make with the mouth when we put it in position to pronounce "h" or "ch" and then inspire or expire. We designate this sound as the *laryngeal* and *tracheal*, or by the collective expression, *bronchial breathing* sound. Its peculiarity is its more or less pronounced sharpness (*ch* or *h* sound) and moreover a somewhat rising pitch; again, it is ordinarily somewhat louder (and deeper) in expiration than during inspiration. The sound is formed in the glottis by the eddies which are here formed in the current of air by the sudden narrowing; it is louder in expiration, because the rima glottidis is narrower than during inspiration. The strength and rapidity of the breathing have a great influence upon the loudness of the sound.

Besides over the throat in front, where the larynx and trachea lie superficially, we hear this sound over the *vertebra prominens* at the back of the neck in healthy persons during moderately strong breathing; also, sometimes, over the upper part of the sternum; very frequently, too, in the interscapular space, and more plainly upon the right than to the left of the median line (region of the bifurcation).

Bronchial breathing may be noticed at other parts of the thorax at a varying distance from the above regions during strong breathing, especially with violent, coughing expiration. It is heard earliest over the upper sections of the chest. There may be great individual differences and yet be within the limits of the normal. Confounding bronchial breathing with the diseased conditions to be mentioned later will be avoided by noting the approximate symmetry of this breathing-sound, the condition in feeble breathing, and also the result of the further examination.

A noise which arises in the pharynx and at the lips of the person examined not infrequently disturbs or deceives the beginner; closing the free ear is here recommended.

2. *Vesicular breathing.* In healthy persons this is heard wherever the lungs lie in contact with the chest wall (with the exception of in the interseapular space; see above). It is of a very slight shuffling character, resembling the sound we may produce by placing the lips in position to say "f" or "v." The pitch of this sound can only be approximately recognized (like the clear non-tympanitic sound).

This sound can only be heard in inspiration, and most plainly at the end of inspiration. In a sound lung *expiration* has a very slight breathing sound which may be said to be of bronchial character. Not infrequently it is wholly imperceptible; sometimes, however, we find inspiration which is simply like a very much weakened vesicular inspiratory sound.

The force of vesicular breathing varies very much. It is most determined by the strength of the breathing; in very strong respiration it is often so loud that it is also heard over the organs adjacent to the lungs, as over the heart, liver, and stomach. In the majority of healthy persons the vesicular murmur is louder upon the left side than upon the right (Stokes). Otherwise the strength of this breathing sound is determined by the loudness of the pulmonic sound; over thin portions of the lung, as the apices, it is very slight, and likewise it may be weakened by the thickness of the covering even to such a degree as not to be heard at all. Moreover, there are individual differences which depend chiefly upon the differences in the width of the glottis, also on the elasticity of the chest on the one hand and on that of the lungs on the other.

Puerile breathing (Laennec). The vesicular murmur in children is remarkably different from that of maturity; the *former* up to about the twelfth year of age exhibits a remarkably distinct, loud and sharp vesicular breathing sound, which approaches bronchial breathing, especially also in that often it is nearly as strong in expiration as in inspiration. Generally, also, women have a stronger vesicular murmur than men.

Origin. Vesicular breathing sound is nothing more than the *bronchial breathing sound* as it is heard over the trachea or larynx,

as it is formed at the rima glottidis (see above), but changed by being prolonged into the air-containing lung. It is the air-containing lung which causes that sharp sound, having a musical pitch, to reach our ears so changed in character. Any tissue not containing air, and, indeed, the lung-tissue that has been deprived of air by the products of disease, as will be shown below, conducts the bronchial breathing unchanged from the large tubes in which it forms to the surface of the chest, and so to the ear; and, on the other hand, a piece of animal lung inflated, placed upon the neck, when auscultated changes the laryngeal breathing sound to a vesicular. (Penzoldt.)

In our opinion, this explanation is probably correct. Moreover, it has this decided preference—that it forms a good foundation for comprehending almost all the pathological appearances. Hence, we do not mention other ways of explaining vesicular breathing here, but remark that very excellent authorities, particularly Dehio, prefer other explanations. Thus far, positive proofs have not been produced for any of the assumed methods of producing vesicular breathing.

Sometimes there are special peculiarities of vesicular breathing sound quite within the normal, which may easily mislead the beginner. We may see during inspiration interrupted or jerking respiration in persons who, at discretion, take deep breaths imperfectly, in a jerking manner; and, further, in whining children, who half suppress their sobs. This kind of jerking breathing exists over all portions of the lungs alike. Moreover, in the portion surrounding the heart, and as far up as to the apex of the left lung, the vesicular murmur exhibits interruptions exactly corresponding to the action of the heart (systolic vesicular breathing, depending upon the unequal entrance of air into this portion of the lung in consequence of the changed condition of the heart, and, hence, often especially plain in disturbed heart's action).

To learn to distinguish between the bronchial and vesicular breathing is, for the beginner, among the most difficult things in diagnosis. For the comprehension of the latter sound it is strongly recommended always to auscult directly, since the sound is then louder and its nature can thus be more clearly recognized. More than this, it is well to place the ear frequently, for comparison, upon the patient's neck, so as there to hear the bronchial sound.

4. *Pathological Sounds in the Respiratory Apparatus.*

The following are enumerated :

- (a) Certain changes in the vesicular breathing.
- (b) Bronchial breathing, in place of vesicular breathing.
- (c) The so-called indefinite, transition, breathing [broncho-vesicular].
- (d) Dry râles.
- (e) Moist râles.
- (f) Crepitant râles.
- (g) Friction-sound of the pleura.
- (h) Succussion-sound of Hippocrates.

From this enumeration, and still more from what follows, it is evident that the number of pathological sounds to be heard with the diseases of the respiratory apparatus is not small. The chief difficulty is that very often different ones are to be heard at the same time, so that one sound conceals another. It is urgently recommended that the beginner at first practise in such a way that, in auscultating, he endeavor always in the first place to learn to recognize only the breathing sound, and that he then endeavor to direct his attention to other possible so-called accessory sounds (râles, friction-sounds). One can acquire the power to exclude one sound in order to be able more exactly to pay attention to another—to acquire a certain dexterity which very much facilitates auscultation.

(a) ALTERATIONS OF VESICULAR BREATHING.—1. The vesicular breathing sound may be increased in inspiration, or sharpened. This takes place whenever the respiration is increased, as in active deep breathing; in the acme of Cheyne-Stokes breathing; in certain forms of dyspnoea, as of diabetic coma; and where one section of lung is vicariously performing the work of others which have been shut off.

Moreover, it forms a very important sign in bronchitis, here occasioned by the local narrowing of small bronchial tubes in consequence of swelling of the mucous membrane and accumulation of mucus. Not infrequently beginning tuberculosis of the apex is revealed solely by sharpened vesicular breathing in comparison with the sound side, as evidence of accompanying catarrh of small bronchial tubes.

Here the one-sidedness of the sharpened vesicular breathing is of the greatest importance: two-sided sharpened breathing of the upper portion of both lungs almost never has this signification; not infre-

quently it exists in tightly-laced women, also in children who breathe poorly with the lower portions of the lungs in consequence of a high position of the diaphragm, due to abdominal affections.

2. Vesicular breathing may be diminished, either in *bronchial catarrh* in case the entrance of air into a section of lung is notably diminished by the swelling and secretion; or if bronchial branches are more or less closed by foreign bodies or compression. Diminished breathing of a portion of lung is also a consequence of *pleural thickening*, and of many conditions which give *pain in respiration*, manifested by the lessened, weakened breathing of the affected side. Diminished interchange of air everywhere, and, hence, a two-sided extensive weakened breathing exists in *emphysema*, also in *stenosis of the upper air-passages*. All *thickenings of the chest-wall* (tumors, etc., oedema) weaken the respiratory sound by rendering the conduction more difficult; and, finally, marked weakening develops rapidly with *pleural exudations*, both on account of the diminished breathing and the more difficult propagation of the breathing sound by the layer of fluid.

In all these cases the breathing sound may even completely disappear; most frequently is this the case with pleural exudations, also in complete *closing of a large bronchial branch*, but it may exist even in *emphysema*.

3. *Prolonged expiration*. This occurs when the exit of the air from the alveoli is more prolonged than is normal, and this condition may be dependent upon diminished elasticity of the lung-tissue: *emphysema* or *bronchitis*—a certain degree of bronchial narrowing, which does not hinder the entrance of air, but its exit only. Of these two conditions, prolonged expiration is an important diagnostic mark, and here, again, especially comes into consideration bronchitis which accompanies the commencement of *tuberculosis of an apex* of the lung. The prolonged expiration of bronchitis is also generally sharpened, more markedly aspirant, somewhat more distinctly bronchial than normal. With pronounced bronchial expiration thickening may be conjectured to have taken place. (See below.)

4. *Jerking inspiration* may likewise be a sign of bronchitis, namely, in case the two conditions are excluded which, within the normal, cause these or a like phenomenon (see above, Sec. 3, p. 143). This pathological jerking respiration, according to its prominence, is confined to the region of the bronchitis, generally to an apex, as in

phthisis, and thus is distinguished from the interrupted inspiration of awkward breathing; but it exists always at the beginning of the examination. It results from the delayed entrance of the air into the lung portion of the bronchial tubes, if these are narrowed by catarrh.

It takes place with *sharpened* and with *jerking* breathing, and *breathing with prolonged expiration*, since in the majority of cases it is called forth or is accompanied by bronchitis, generally, also, toneless râles. (See below.)

(b) BRONCHIAL BREATHING.—In order to understand the pathological development of this respiratory sound, it first is of the greatest importance that it should be made clear how the respiratory sound normally at the glottis, pathologically also at every sudden narrowing of a not too small bronchus, exists as a bronchial sound, how it is further conveyed by the subdivided columns of air in the bronchial tree as a bronchial sound, and how in healthy persons it is deadened by lung-tissue normally containing air into the vesicular breathing sound. *There is no breathing sound without open bronchial tubes; there is no vesicular breathing without lung-tissue containing air.* If between the bronchi and the ear there is no air-containing lung-tissue, if anything at all is heard, it is bronchial breathing.

Pathologically, bronchial breathing occurs in *thickening of lung-tissue* of a certain extent—that is, in case it involves an extent that reaches as far as moderately sized bronchial tubes. Here belong acute and chronic *pneumonia*, *infarction*, under some circumstances *new formations*; and, also, *compression of the lungs* so that the air is expelled by a correspondingly large pleuritic exudation (this is generally near the upper posterior boundaries), or by tumors of any kind in the chest-cavity, or by very high position of the diaphragm.

If these conditions, which encroach upon the space of the chest, only involve retraction of the lungs so that they still contain air, the breathing remains vesicular; on the other hand, if they are so strong that they also compress the larger bronchial tubes, then we do not hear anything at all.

If a pneumonia is combined with a *stopping of the bronchial tubes* (mucus, fibrin), then, on account of this imperviousness, we do not hear anything, but after a cough the bronchial tubes may become pervious: there is bronchial breathing.

Moreover, we hear bronchial breathing over the lung-cavities and

in *open pneumothorax*; and besides, over the former, sometimes over the latter, we always hear it in the form of *amphoric breathing* (see below). It is only when the cavity is near the surface that we have bronchial breathing over it, when it is surrounded by tissue that contains no air and is in open communication with a not too small bronchial branch. In both conditions the bronchial sound really arises from the fact that the air, flowing out of the bronchus that connects with the cavity, or which, connected with a pleural cavity, enters into a larger air-space, or out of this air-space, again, into a narrow bronchial canal, is set into whirling motion. But there is no doubt that, besides, the sound that is conveyed from the glottis joins with it as bronchial. (See further upon this point under *Amphoric Breathing*.)

In the cases just mentioned, the bronchial breathing sound may, under various circumstances, become weakened, namely, either when the advance of the sound to the ear is made difficult, or when the breathing is weakened. Thus, of an *exudative pleuritis*, in consequence of the fluid which generally lies between the ear and the compressed lung, a slight, distant-sounding bronchial breathing is characteristic ("breathing of compression"); while, on the other hand, in *croupous pneumonia*, almost always there exists a very loud, sharp bronchial sound. But in pneumonia otherwise rare conditions in their turn may weaken the bronchial breathing; in closure of the bronchial tubes, as was mentioned before, we hear low bronchial breathing, or else nothing at all; further, in the so-called central pneumonia it may happen that from the part of the lung containing air which lies superficially, a vesicular, and, almost concealed by this, a low bronchial breathing sound is produced. Also, the loud pneumatic bronchial breathing may be weakened if the pneumonia is complicated with an *exudative pleurisy*.

In all these cases the low bronchial sound is usually most distinct during expiration (compare what was said above regarding expiration), often even only perceptible in expiration as a weak "ch" kind of blowing.

The *bronchial breathing of a hollow space* may be weakened, or even lost—weakened, in temporary narrowing or closing of the bronchus leading to it, by mucus (hence, loosened by cough); or lost, by the filling of the cavity with secretion. On the other hand, a thick

callous pleura covering a cavity may be the occasion of deadness before bronchial breathing is affected.

Special forms of bronchial breathing are the *amphoric* and the *metamorphosing* breathing. The former exists with very large, smooth-walled, communicating cavities and in *open pneumothorax*. It is a bronchial sound with metallic tone, exactly analogous to the metallic percussion sound that arises by resonance in large smooth-walled cavities.

It may, moreover, be found besides in *open pneumothorax* (and where there is valvular connection), also in *closed*, although more rarely and only very softly, since here the (bronchial) sound of the air flowing into the trachea acquires a resonance in the air-containing pleural cavity; likewise, râles, heart-sounds may acquire a metallic tone.

Metallic associated sound may also, in rare cases, accompany undefined—that is, bronchial breathing unnoticeably weakened; thus also, not rarely, in pneumothorax. It might, indeed, be suitable to designate it not as “amphoric,” but as “undefined, with metallic associated sound.”

Metamorphosing breathing (Seitz). In this the inspiration is divided: it begins distinctly bronchial, like the sound of stenosis, and suddenly changes to a weak bronchial breathing, which is then also heard during expiration. This phenomenon is very rare; it is said to be a sure sign of cavity. It is explained that the bronchus leading to the cavity is always first narrowed, and in the second part of inspiration it becomes dilated by the current of air (?).

(c) UNDEFINED BREATHING.—The breathing sound may in two ways be of such a character that it may be designated either as distinctly vesicular or as distinctly bronchial. It may be so weak that its character remains indistinct, or it is concealed or drowned by other sounds, particularly by râles; or, while it can be heard, it does not entirely correspond to either type of breathing, but seems rather to stand between the two, thus sometimes inclining more to bronchial, at other times more to vesicular, breathing—“transition breathing,” “hinted or indistinct bronchial or vesicular breathing,” “sharp breathing with bronchial breath in expiration,” etc.

The causes of what is included in the first category are very various (see what was said above concerning the strength and weakness of the

breathing sound). Of course, the examiner's sharpness of hearing is an important factor here. Râles that may be present may frequently be removed or diminished by coughing strongly.

The second group of undefined breathing is, of course, much more numerous with beginners than with those who are practised in auscultation. It is well, however, for the latter also to impose upon themselves some reserve in pronouncing whether it is vesicular or bronchial. The determination is often actually possible either by the tone itself or by the strength of expiration in relation to inspiration. Frequently, also, as in beginning phthisis, in various lobular pneumonic deposits, the physical conditions resulting from the pathologico-anatomical changes cause it to appear that there is a "transition breath"—that is, a mingling—in that the infiltrated part of the lung favors the transmission of the bronchial sound unchanged, the parts containing air convey the breath-sound to the ear toned down to the vesicular sound. Hence, under no circumstances can we miss this idea of "transition breathing," and it is best in such cases simply to describe the breath-sound.

(d) DRY RALES (RHONCHUS, HUMMING, WHISTLING, HISSING).—Like all râles, these are pathological sounds; they appear when there is a bronchial catarrh, which furnishes a tough, scanty secretion; they constitute those audible phenomena that are caused by the rushing together of the air and secretion in the bronchial tubes. It is as difficult to make a sharp distinction between a "tough" and a "fluid" secretion of the bronchial tubes as in a stricter sense it is to separate the so-called "dry" from what is later referred to as "moist" râles—much more, since transitions are everywhere present. Meanwhile, however, the class of sounds here referred to take a somewhat special place, both on account of the auditory impression they make and because they exactly correspond to the very toughest bronchial secretions. The humming, hissing, whistling sounds (sonorous, sibilant râles) arise from the fact that the swelling and mucus narrow the bronchial air-passages, and, hence, they are sounds of stenosis; but, besides, some of the very fine high hissing and whistling tones may be caused by the presence in the bronchial lumen of tense threads of mucus stretched across, which, like the strings of an Æolian harp, are blown upon by the current of air.

Sibilant râles very often have such a high musical tone that it

cannot be deadened even by the air-containing lung. Under some circumstances they may be confounded with the so-called ringing râles [metallic râles]. The dry humming often shows unnoticeable transitions to the character of the sound of the moist râles, approaching more nearly to crepitation. According to my view, they may still as dry, become ringing, râles—that is, may exhibit a ringing character like bronchial breathing. This is the case when we have thickening of the lungs and at the same time bronchitis with tough mucus. (See ringing râles, under Moist Râles.)

The humming, hissing, whistling may be abundant or scanty, loud or soft. It may occupy the whole time of inspiration and expiration and completely conceal the breath-sound, or it may only be heard at the end of inspiration. A very fine soft whistling is sometimes heard during the whole of expiration, since then, so far as vesicular breathing is concerned, the breath-sound is very soft. When they are very loud they may even be heard at a distance (a distinguishing peculiarity of emphysema). Finally, there are buzzing sounds in the chest which may be felt when the hand is applied to it. Cough has sometimes the effect of diminishing, and sometimes of increasing, them—at least the humming is generally very markedly changed by it.

It is not easily possible to confound the humming sounds with the pleuritic friction sounds (*q. v.*). On the other hand, I have not infrequently found that a very soft, fine humming was mistaken by beginners for sharp, even bronchial, breathing sound. This, as well as the distinguishing of whistling and hissing from a peculiar ringing râle, can only be learned by practice.

Conclusions. Humming, whistling, hissing sounds, as has been shown above, show a dry bronchial catarrh. Spread over the lungs, they are present with *diffuse bronchitis*, with *tough secretion*, when it occurs independently, but especially as an accompaniment of *emphysema*, in which they are almost never wholly wanting. In these cases the lower lobes of the lungs are generally the seat of the catarrh. When there is simply bronchitis, then these râles and a sharpened or weakened breathing are the only local physical signs of disease. In emphysema the percussion and auscultatory signs of this condition are also present. Localized dry râles exist as signs of *catarrh of the apices*, which accompanies commencing tuberculosis; here a low whistling in a perhaps somewhat prolonged expiration may for a long

time form the only symptom. Ringing dry râles are rare; I have most frequently heard them in pneumonia at the beginning of the second stage.

In all these cases the dry râles may be combined with the moist; regarding these see below.

(e) MOIST RALES.—These arise in the bronchial tubes, except the smallest, and in the pathological cavities of the lungs [vomiceæ]. Their production requires more or less fluid secretion; the more fluid there is the more moist the sound; if it is tougher, then there are “viscid-moist” râles, a transition to the dry. Generally, the ear directly receives an impression of a greater or less degree of moisture.

Formerly, moist râles were explained as being produced by the bursting of bubbles which the current of air caused upon the surface of the fluid. More recently, they have received another explanation: according to the analogy of the bubbles which we see formed when we blow through a tube one end of which is immersed in water, it is supposed that the current of air separately moves the air-bubbles which present projections into the bronchial tubes, and that as one such quantity of air breaks the bridge through the fluid and advances, the fluid behind it, immediately rushing on again and occupying the space, shares the vibration in the pent-up air (Talma, Baas). It is to be added that many consider moist râles in part due to stenosis; and, finally, that it is said that the to-and-fro motion of the secretion produced by the current of air causes râles (Traube). The explanation by Talma and Baas will serve very well for the râles formed in the medium-sized bronchial tubes; for vomiceæ it only serves in case the bronchial tubes leading thereto are immersed in the fluid secretion, which, indeed, is ordinarily not the case. Here, and with large bronchial tubes at any rate, we must think of bursting bubbles.

Moist râles may be so numerous that they can be heard in both inspiration and expiration, even outlasting the expiration. If they are scanty, then we are apt to hear them during inspiration, under some circumstances only toward the close of inspiration. A slight cough may increase them, or cause them, in case they were for the time being absent.

In cases where the râles are very scanty, scarcely to be heard, it is useful to inquire as to the time of day the cough is the most frequent, and to listen to them before the occurrence of the paroxysm of cough,

so as to make the examination before the bronchial tubes have been cleared of mucus (as shortly after waking).

The different moist râles make an impression upon the ear of different "size," and even beginners can without difficulty judge approximately whether they are found in a large or a small bronchus or cavity; we speak of *large*, *small*, also *medium-sized* râles. The discrimination of râles in this respect is very important; for instance, we may distinguish whether we have a bronchitis of only the large, or whether the smaller tubes have become involved; the dangerous capillary bronchitis of childhood is manifested by very small, fine râles, and also by crepitant râles (see below, page 154). Large râles may furnish an index in the examination of the apices: these contain only very small bronchi; hence, if in an apex there are large or only medium-sized râles, these cannot arise from the bronchi there, hence there must be a pathological space—a cavity. If there are *large râle sounds* which undoubtedly arise in the *apex*, they are a most certain sign of cavity.

The *loudness* of the râles does not depend upon their number, but upon the strength of the breathing. But the loudness furnishes an indication of the place where they arise: *cæteris paribus*, the sound will be loudest at the point where the ear is nearest to them. It may be of the very greatest importance to locate them exactly. Here, again, the most striking example concerns the diagnosis of phthisis, and, too, of the ominous catarrh of the apex. By a superficial examination it may easily happen to the inexperienced, especially in the examination of the back, that he locates râles which come from the neighborhood of the root of the lungs and are those of a benign bronchitis in the apex, and hence makes the diagnosis of phthisis.

It is of the very highest value, but often not easy, to distinguish whether we have a ringing or "consonant" (Skoda), or a non-ringing râle-sound. The former is acoustically related to the latter, as the bronchial breathing sound is to the vesicular (as tympanitic percussion note to lung-sound), and, like that, ringing râles appear if there be present either a *thickening of the lung* of sufficient extent, or if there be a *cavity*. But yet bronchial breathing and ringing râles, and vesicular breathing and non-ringing râles, are not always necessarily associated together; thus, not infrequently when there are small cavities, and even large ones, especially in the lower lobes, in case they are covered by a not very thick layer of air-containing tissue, we

hear ringing râles when the breathing is undefined, yet hinting toward the vesicular. In children, even when there is no trace of cavity or thickening, in simple bronchitis the râles may reach the ear as loudly ringing (from the elasticity of the lungs and of the thorax). On the other hand, in pneumonia and pleurisy we sometimes hear bronchial breathing and non-ringing râles.

But now, corresponding to "transition breathing," very frequently there are to be heard such râles as stand between the non-ringing and the pronounced ringing ("hinted" or slightly ringing râles). It is often difficult to interpret these. In general, with children they furnish no reason for the supposition of thickening or cavity more than with adults.

Loud ringing, hinted ringing, and non-ringing râles are often found together; we may even say that almost never do we hear ringing râles alone at one place. But, of course, if they are present they predominate. Though they exist very near together, yet they can be locally separated, as sometimes in *emphysema*; here, with extensive humming, whistling, and non-ringing râles at a certain point of the lower lobe, there may be ringing râles (perhaps without bronchial breathing, and without deadened or tympanitic resonance): this makes a bronchiectatic cavity probable. But, also, by the same signs, in general bronchitis a broncho-pneumonic deposit may be made known.

As the ringing râles correspond to bronchial breathing, so in their manifestation the so-called metallic râles correspond to *amphoric breathing* (metallic percussion note); but again in such a way that the two symptoms are not necessarily united together. The metallic râles then occur in correspondence with very large, smooth-walled, superficially-located cavities, and also in *pneumothorax*, where, arising from sections of the lungs which are breathing (even if on the other side), they are to be regarded as râle-sounds in the air-containing pleural cavities endowed with resonance.

Sounds of falling drops. These are often only separate, generally very much inflated, moist râles, which have a high metallic note; sometimes, indeed, there is only one in each phase of the breathing; then the above-mentioned designation of it serves.

Water-whistling, or the sound of lung-fistula (Unverricht, Riegel). We thus designate a metallic râle, or very fine metallic gurgling or splashing, which occurs in open pneumothorax, if the patient's position

is such that the opening in the pleura is directly below the smooth surface of the fluid, and if the patient then draws a breath (first observed by Unverricht while puncturing and aspirating a case of *hydro-pneumothorax*).

(f) CREPITANT RALES (CREPITATION).—Briefly expressed, by this we understand the finest r le sounds. It occupies a special place on account of its acoustic peculiarity, on account of its cause, which permits its classification either under the moist or under the dry r les, and, finally, on account of its special diagnostic meaning.

The so-called *atelectatic crepitation* occurs in health, and still more in disease, over parts of the lung which have for a time been breathing poorly and now are again distended by a full breath. Most frequently is it observed after quite long, especially low, dorsal position, over the lower parts of the lower lobes. It is purely inspiratory, and disappears generally after the first deep respirations.

Like this are crepitant r les which are to be heard in *croupous pneumonia* during the first and in the beginning of the third stage (crepitationo indux and redux), sometimes in *catarrhal pneumonia*, moreover in infarction, in individual cases (according to the author's observation) of *caseous pneumonia*, and, finally, especially in *oedema of the lungs*.

In all these cases we have to do with crepitation, heard during inspiration, or, at most, only the beginning also of expiration, which occurs in very fine and equal-sized bubbles. It is well compared to the noise produced by rubbing a lock of hair between the fingers in front of the ear, or by separating the thumb and finger moistened and pressed together as they are held before the ear (Eichhorst). It arises in the smallest bronchial tubes, the alveolar spaces, and in the alveoli when these are collapsed and glued together, or partly filled with secretion, and then during strong inspiration their walls are torn apart or freed from secretion.¹

The non-uniform crepitation, so called, forms the transition from these sounds to the fine bubbling r les. More than elsewhere it occurs with *capillary bronchitis* and also in *oedema of the lungs*. It is to be understood as a mixture of peculiar crepitations and small

¹ It is only in individual cases that this crepitation is heard in expiration, and still more rarely *only* in expiration. (Penzoldt.)

bubbling râles, and it accordingly is, in its coarse sounds, to be heard also in expiration.

(g) PLEURITIC FRICTION-SOUNDS.—The respiratory gliding of the pleura costalis upon the pleura pulmonalis, which normally is noiseless, is perceived by the ear and can also be felt when the hand is laid upon the chest when there are inflammatory deposits upon the serous surfaces. Thus, it is really the *pleuritis sicca* that causes it. Only in rare cases of unevenness of the pleura is this phenomenon observed in the absence of inflammation, as in acute *miliary tuberculosis* of the lungs and pleura; also in *pneumono-koniosis*. The conditions most favorable for the occurrence of this sound are where the respiratory movement of the lungs (forward and downward) is most marked: below and especially at the sides. But this sound may also exist farther up, even almost as high as the apex.

Pleuritic friction sounds like regular scraping, or like a scratching, creaking, beginning in distinct pauses, which ordinarily is louder during inspiration than expiration. Quite in the same way as it comes to be heard, it can be felt: the “sensible frictions” are best recognized by the laying on of the flat hand. It is not changed by cough, but continued deep breathing often causes it to disappear, since in this way the unevenness, upon which it depends, is smoothed out.

When this friction-sound is very loud and characteristic it is easily recognized. A difficulty may arise when it is very softly heard; this often occurs from the fact that the examiner does not auscultate at the right spot, for friction-sound is heard in only a circumscribed area, since it is poorly transmitted. A further difficulty lies in distinguishing it from certain medium-sized, tough, moist râles (cracking râles) and from soft buzzing; here it is most important to take note of the character of the particular sound, and the knowledge and recognition of this can only be acquired by practice. We may make use of the effect of coughing as an aid. Sometimes moderate pressure with the stethoscope increases the pleuritic sounds; also, palpation may help us to recognize them. Râle-sounds are seldom, or, at most, only slightly, to be felt.

It is to be remembered that friction- and râle-sounds may occur at the same time. Besides in pneumonia, I have observed it most frequently in disseminated tuberculosis and in caseous pneumonia of the lower lobes.

Friction occurs with all kinds of pleuritis. It occurs (seldom) in acute exudative pleuritis in the beginning of the attack, and also, as a favorable sign, later with the absorption of the fluid exudation. There can be no friction-sound while there is fluid present, since it is only heard when the pleural surfaces are in contact. In *chronic pleuritis* it may last indefinitely and over a large extent. Of the diseases of the lungs which usually are accompanied by *pleuritis sicca* many are first revealed by the friction-sounds which the latter causes: thus, *phthisis*, also *pyæmic deposits in the lungs*, *infarction*, *bronchiectasis* with reactive *pneumonia*, and *pleuritis with emphysema*.

Regarding pleuro-pericardial friction-sounds (*pericarditis externa*), see under Auscultation of the Heart.

(h) HIPPOCRATIC SUCCUSSION.—This is a phenomenon very easy to understand.

In *sero- and pyo-pneumothorax*, after a strong shaking of the chest, as in any vessel partly filled with fluid, there is splashing. This splashing, through the resonance associated with metallic tone, like all the audible phenomena of pneumothorax, is heard at a distance or by applying the ear to the chest.

This sign is usually most distinctly manifest when there is a small effusion and when it is serous. It is almost pathognomonic of hydro-pneumothorax in that it only elsewhere occurs in very isolated cases of large cavity with quite fluid contents.

The direction of Hippocrates was to shake the patient by the shoulders; but, on account of the grave condition of most of these patients, the greatest care is necessary. Many quickly learn to shake the body so as to produce the sound themselves.

Confounding this with the splashing from the stomach or colon will be avoided by local examination of these organs and by repeated examinations.

PALPATION OF VOCAL FREMITUS (AUSCULTATION OF THE VOICE).

Strictly speaking, this method of examination belongs in part to Palpation and in part to Auscultation; but at the same time it has a place here, because this comes next in the course of a thorough examination of patients. It is, besides, of sufficient importance in itself to be treated separately, because after Inspection, Palpation, Percus-

sion, and Auscultation have been completed, not infrequently it happens that this casts the decisive vote.

The vibrations of the glottis in phonation (speaking, singing, screaming) originate in the column of air in the trachea and bronchial tubes rather than in their walls; they traverse the lung-tissue, where, in case this is normal, they become considerably weakened, then the wall of the thorax and its coverings, and may be felt by the hand laid upon the chest as a whizzing: voice vibration, voice fremitus, pectoral fremitus (besides heard as indistinct *humming*; see below).

The technique of this method of examining is as follows: While the patient counts aloud, or, still better, repeats the same word (one, for example), the hand is laid upon different parts of the chest. Generally we employ the palm of the hand, but for finer examination it is preferable to apply the ball of the little finger or the tips of the first, second, and third fingers. Practice of the method last mentioned enables one to dispense with auscultation of the voice. Differences of voice vibration are distinguished by comparison of different locations and particularly of symmetrical points. It is quite unnecessary in making this comparison to apply both hands at the same time to the two sides of the chest; the difference is much more distinctly felt if we examine with the same hand, first upon one side and then upon the other.

Within normal limits, vocal fremitus is stronger the stronger the voice; it is very distinct when the voice is rough and deep, weak if the voice is high, and even not to be felt at all when the voice is high and thin (light), as is sometimes the case in women and children. The separate vibrations are felt more distinctly the richer and more prolonged they are. The fremitus is stronger upon the right side of the chest than the left, probably because the right bronchus is the larger in diameter. It is, moreover, very noticeably influenced by the thickness of the covering (muscles, mamma, subcutaneous fat).

There may be pathological conditions present upon one side that will not propagate the vibration of the voice so well as a normal condition would do, which may diminish or remove the vocal fremitus; on the other hand, they may better propagate it; strengthen the vocal fremitus.

Weakness or suppression of vocal fremitus occurs with *pleuritic exudation* (on account of the narrowing of the bronchial tubes from

compression and on account of the encroachment of the fluid); with *pneumothorax*, on the one hand, either on account of the poor conduction through the bronchial tubes of the retracted or the compressed lung, or, on the other, because it is not conducted through the air-cavity. If, however, there should be growths on the pleural surfaces, even if only in the form of fine fibres, these ordinarily act as good conductors of vocal fremitus. Finally, vocal fremitus is weak or suppressed with tumors of the pleura, and all *thickenings of the chest-wall* (abscess, œdema), and in *closure of the bronchial tubes*, since these are the most important means of propagating the oscillations (closure from mucus, masses of fibrin, foreign bodies, compression).

Increase of vocal fremitus is observed in pneumonia, since the solidified lung-tissue is a better conductor than when it contains air; for the same reason, sometimes, when the lung is compressed against the thorax-wall; above pleuritic exudation, and generally posteriorly at the roots of the lungs; and in cavities with open bronchus and small secretion—here partly by the good conduction of the sound and partly by consonance.

Vocal fremitus is an extremely valuable means of distinguishing between pneumonia and pleuritic exudation. Yet it may, in rare cases, so far deceive as that in pneumonia, if the bronchial tubes are stopped by secretion, there is no increase of vocal fremitus; it is even diminished, and, occasionally, with complete filling-up of the bronchial tubes, may even disappear altogether. Under some circumstances after cough and expectoration, as after a cool bath, it may return. It is easy to see how various the result may be if pneumonia and pleurisy, or if a cavity and thickened pleural walls, are combined.

In most cases, in my opinion, *auscultation of the voice* may be dispensed with where one is thoroughly trained in testing the vibration of the voice by palpation, especially by using the tip of the fingers. In reality, its result is fully analogous to that of palpation. Normally, over the thorax, we hear the voice of the person examined as an indistinct humming, which pathologically may be weakened or lost; but it may be strengthened to an extraordinary loudness (bronchophony), wholly under the conditions which correspond to those that influence vocal fremitus.

We sometimes find a very marked bronchophony over those cavities

where we hear amphoric breathing and metallic râles. Here, also, the bronchophony may acquire a kind of metallic quality (Laennec's pectoriloquy).

Ægophony, "bleating-voice," is a peculiar nasal, bleating pectoriloquy, as we hear it, with pleuritic exudations, in the neighborhood of the upper boundary of dulness.

Auscultation of the whispered voice was introduced by Baccelli. He found that it was propagated by serous exudations of the pleura, but not by purulent, since the latter dispersed the sound-waves. In most cases this method must be considered as without value, since in large serous exudations with marked compression of the lungs we as often do not hear the whispered voice. We may recognize it in very small and fresh purulent exudations, unconnected with thickening of the pleura.

Palpation and auscultation of the voice, of course, cannot be made in all those cases where the voice cannot be produced, as in unconsciousness and exhaustion, or when the patient is dumb (aphonic), or where, from caution, we do not wish to have the patient speak aloud, as in hæmoptysis, peritonitis, etc. Scherwald has recently devised a new procedure, which can be recommended—plegaphonia, or auscultation during percussion upon the larynx or trachea. The vibrations produced in this way take the place of those of the vocal cords during phonation, and this procedure is exactly synonymous with auscultation of the voice.

Mode of application: We have some one else place a large ivory or hard-rubber pleximeter upon the surface of the thyroid cartilage or upon the trachea, and percuss with a hammer (sometimes the patient himself can do both). The patient closes his mouth. By preference we auscult during expiration. Ausculting on the thorax, we hear the blows: 1, over the sound lung, very markedly weakened (loudest over the apices), as if it were vanishing, not tympanitic, but with a cracked-pot sound; 2, over infiltrated lung, very loud, tympanitic, with Wintrich's change of sound [which see]; here, also, the ear has a sensation as if the blows were upon itself; 3, over an exudation, simply weak, even to complete absence; 4, over cavities, the same as over tissue empty of air; over large open cavities, very loud, "smiting"; 5, over pneumothorax, a metallic sound.

EXPLORATORY PUNCTURE OF THE PLEURA.

Mode of procedure: For this small operation we employ either an ordinary large hypodermic syringe, or, better, a larger syringe of the same construction with a slightly larger canula—about seven cm. long. The syringe must always be kept very clean, and before using must be disinfected most carefully with carbolic acid or bichloride of mercury. The packing must be very tight. The needle is inserted in an intercostal space perpendicular to the surface with the piston pushed in, and then the piston is withdrawn. If the point of the needle rests in fluid, this will rush into the syringe.

Directly before making the exploratory puncture the patient must be placed in exactly the same position he is to occupy during the operation, then be carefully examined, and especially percussed.

In this way we may ascertain whether there is fluid in that portion of the thorax, and of what kind it is. It is especially applicable in the diagnosis of pleuritis (more rarely in hydrothorax and hydro-pneumothorax). It is to be performed in the following cases:

1. When there is the slightest doubt whether there is pleuritis or not. In the first place we have to consider the differential diagnosis between *pneumonia*, *tumors* of the chest-cavity, and *thickening of the pleura* (compare p. 158). In either of these three conditions the syringe will draw out nothing at all, or, at most, only a drop of blood. But positiveness of conclusion is limited in two ways: (1) Sometimes we do not reach the fluid with the syringe if the pleural exudation is buried behind a thick pleural membrane, or behind tumors of the chest-wall, because it does not penetrate as far as the exudation. (2) Even when the fluid is within reach, we often do not obtain any in case it contains floccules of fibrin, or it is a thick purulent fluid; either of which will close the needle. With these two possibilities, a limited value must always be assigned to the negative result of exploratory puncture.

2. *To determine the nature of the fluid in the pleural cavity.* If the small quantity of fluid withdrawn is quite or almost clear, like water, if it contains no material elements, if there is no effusion of fibrin, and if on boiling¹ there is little or no albumin, then the fluid is

¹ This test is difficult with a small quantity, but yet by care it may be applied by using a small test-tube, and adding water.

a *transudation*; otherwise it must be regarded as an *exudation*. The exudation may be serous, sero-fibrinous, sero-purulent, purulent, hemorrhagic, colorless or ichorous, or feculent. With purulent exudation there are never wanting, in the microscopic examination, besides the pus-cells, micrococci (streptococci and diplococci); of other organisms in pleural exudation, the bacillus tuberculosis comes into consideration (for the manner of demonstration see p. 188), and actinomyces (see p. 189). The latter elements, however, can hardly be obtained by the hypodermic syringe. Absence of bacillus tuberculosis, even the negative result of culture, does not decide positively against tubercular pleurisy. Even in empyema of tuberculous origin, cultures and inoculations are generally negative. (A. Fränkel.) The bacilli and spores are only present in the exudations if disintegration of tubercle takes place upon the diseased pleura. Micrococci are always found in great quantities in *septic pleuritis*.

In carcinomatous pleuritis, carcinomatous cells are sometimes found in the exudations. However, Quincke, the greatest authority upon this subject, has acknowledged that single carcinomatous cells cannot with certainty be distinguished from the pleural endothelium, and at best that this method of diagnosis is extremely difficult. Both species of cells, affected with fatty degeneration or granular, are found filled with large "vacuoles." If very abundant, both may form a cream-like layer upon the surface of the fluid drawn off. We must think of carcinomatous cells (which, moreover, can only occur when a carcinoma has ulcerated into the pleura), if the cells exist in abundance, are in balls, show great variations in form and size, and are colored brown by iodine (glycogen reaction).

Hemorrhagic exudation makes the existence of *tubercle* or *carcinoma* of the pleura probable. If the exudation is *feculent*, there is some connection with the intestine. But, sometimes, there is no disease of the pleura at all, but a *diaphragmatic peritonitis* (see), which simulates a pleuritis.

When pleuritis is complicated with *erysipelas* we ought to look for the coccus of that disease. But this is very difficult to distinguish from other cocci (especially *streptococcus pyogenes*, one of the most important pus-cocci), and it can only be distinguished by cultivation and inoculation.

Exploratory puncture, finally, must always be made—

3. *Before operative procedure* when pleurisy has been diagnosed, even if the diagnosis seems to be perfectly certain.

In making the exploratory puncture the needle and syringe employed must be always first thoroughly cleaned and disinfected with carbolic acid or corrosive sublimate. The syringe must have good suction. From what has been said it is clear that we operate only upon the lower part of the chest, not higher than the fourth rib in front and the sixth behind. Of course, we must avoid the region of the heart, and when there is a suspicion of aneurism explorative puncture must be omitted; otherwise there is no need of anxiety. When the exploratory puncture is made with the observance of every possible precaution it is not a dangerous procedure. The puncture is made quickly, in an intercostal space, as far as the needle will reach; if nothing is obtained, the needle is slightly withdrawn and suction again made. We may sometimes puncture at several points.

METHODS OF MEASURING AND STETHOGRAPHY.

Measuring the Thorax.

This serves, in measuring once, to determine the size of the chest, and to secure an approximate point of departure for determining its relation to the development of the rest of the body. But it does not furnish knowledge of diseases any better than, with sufficient practice, is given by inspection and palpation.

On the other hand, it has a very great value in connection with tracing the cross-section of the chest upon paper, if it is employed to determine the changes which the chest undergoes in the course of a certain disease.

We measure the diameter of the thorax with the caliper-compasses, and it is best to take the broad diameter at the highest point of the axilla, the deep, or sterno-vertebral, diameter on the level with the nipple and the insertion of the second rib. In tracing a cross-section of the thorax upon paper we must, of course, make the transverse and antero-posterior diameters at the same level (whether at the nipples or lower down). The circumference of the breast is generally measured at the level of the nipple, but sometimes over the highest

points of the axillæ and at the lower end of the corpus sterni. The length of the chest may be ascertained by measuring in the mammillary line from the clavicle to the border of the ribs. The linea costo-articularis is very useful for determining any change in the length.

The delineation of the form of a cross-section of the chest is made in the following manner: The opposite diameters at a given point are measured, and are marked upon a sheet of paper. Then a lead hoop or wire is accurately fitted first to one and then the other side of the chest at that level, then carefully removed and traced upon the paper. Instead of the leaden hoop (which is entirely satisfactory) we may employ Woillez's Cyrtometer, which is a chain with links that move stiffly.

Frequent measurements of the diameters and circumferences, as well as tracing the cross-section in the course of disease may give not unimportant results: in determining an increase or diminution of the quantity of pleural exudation or of the progress toward recovery by the amount of shrinking; in retraction of the lungs; but especially in all kinds of tumors of the chest-cavity. Thus, where aneurism is suspected, or a mediastinal tumor, the slightest increase in the antero-posterior diameter or of the circumference of the chest is of great significance.

In view of what has been said, the statement of the exact measure is impossible. It is only important to know that the right side of the chest measures, in people who are right-handed, about 1 to 1½ cm. more than the left; also, that the circumference of the chest at the level of the nipples in healthy persons is increased in inspiration about 5 to 7 cm.

Spirometry, Pneumatometry, and Stethography.

If we here discuss these three methods of examination somewhat briefly and dogmatically, let it be understood that this is only from the point of view of clinical diagnosis. But as to the application of these methods to physiological and pathological examinations in animals and man we take exactly the opposite view, for they, like measurements of the chest, can furnish many important conclusions.

Spirometry is employed to ascertain the vital capacity of the lungs—that is, the quantity of air which, after deepest inspiration, can be

given off by the deepest expiration. This is done by means of a Hutchinson's spirometer, which is constructed on the principle of a gasometer.

The relations of the size of the body to the vital capacity of the lungs are relatively the most constant. Von Ziemssen found that in men, if to each cm. of stature there was less than 20 c.cm. of vital capacity (or, in the case of women, less than 17 c.cm.), there probably was a considerable disturbance in the organs of respiration (phthisis, emphysema, adhesive pleuritis, bronchitis), or it already definitely existed. On the other hand, where the relation was as 1 : 25 (or 1 : 22) this was improbable. The vital capacity is of more importance for supplementing other methods of examination in the course of observation of a patient, for the reason that it changes with the recovery from, or exacerbation of, the given disease. It is to be observed that there seems to be an increase in the vital capacity of every patient in consequence of increased practice. Spirometry does not here have an independent value.

Pneumatometry is the determination of the pressure of the respiratory air during inspiration and expiration. It is determined by means of the pneumatometer of Waldenburg, improved by Biedert and Eichhorst, a modified mercurial manometer. We find that in health the expiratory pressure is always greater than the inspiratory, but the absolute results vary still more than those obtained by spirometry. The diminution of the expiratory pressure in emphysema is important, and furnishes a certain conclusion as to the severity of the disease, as well as of improvement or extension. Diminished inspiratory pressure in stenosis of the air-passages, in phthisis, and in exudative pleuritis has no diagnostic meaning.

Stethography is the graphic delineation of the respiratory motions of the chest and of the diaphragm. In many ways it is instructive and yields results that are valuable with reference to physiology and pathology, but it may be entirely dispensed with for the purposes of clinical diagnosis.

COUGH AND EXPECTORATION.

Cough is caused in the following way : By the closure of the glottis, after a deep inspiration has been taken, the pressure in the thorax

by means of the auxiliary muscles of expiration is increased, and then suddenly the glottis is opened; there results an audible outrush of air, which in turn brings with it the substances forming the expectoration (which substances cause *râles*).

The ability to cough is lost, not only when the crico-arytenoideus muscle in the larynx, but also the respiratory muscles, are paralyzed (bulbar paralysis). Pain, also, may cause suppression of cough.

Cough may be *spontaneous* or *reflex*. Reflexive cough-irritation may arise from all parts of the mucous membrane of the larynx, trachea, and bronchial tubes, as well as from inflamed pleura ("pleural cough"), no doubt occurring not infrequently. The trachea is especially irritable, and particularly the region of the inter-arytenoidean space, likewise the bifurcation; inflamed mucous membrane is more irritable than normal. There is never any irritative cough from the lung-tissue.

Cough may also arise from the abdominal organs reflexively, as from the stomach. I have known three persons who had a "nervous" cough at the beginning of each menstrual epoch. The cough of hysteria must be regarded as reflex, or direct from the nervous centres (?).

The cough which is caused by *disease of the respiratory organs* at the points above mentioned, either because these are themselves diseased or because they are irritated by diseased products, is a most important sign of disease. Moreover, in spite of the existence of irritation, there may be no cough in any patient whose mind is markedly obtunded (as, for example, in typhus abdominalis [typhoid fever], in disease of the brain, in carbonic-acid poisoning, in the death agony, etc.); hence, in these cases there is often considerable mucus rattling in the trachea, without any expectoration. The sudden stopping of cough and expectoration in consequence of unconsciousness, often accompanied with weakness, is, therefore, particularly in many diseases of the lungs, as in pneumonia, a bad sign; in phthisis, also, it sometimes denotes approaching death. It has already been mentioned that cough may disappear as a result of paralysis of the muscles concerned in coughing.

We can draw no diagnostic conclusion from the frequency of the cough. Regarding the time of day when it is most apt to occur,

frequently in phthisis, and also in chronic bronchitis, this regularly occurs soon after waking.

Dry cough is one that is not accompanied with expectoration. It is generally weak: "slight cough" (especially in the beginning of phthisis, also as "pleural cough" (see above); but also "nervous," from bad habit).

There is a cough with tough expectoration, difficult to be dislodged, brought up generally after a long series of labored efforts; at the end there is generally hawking: the patient often pauses to rest, and then continues to cough until a final hawking and expectoration, as in emphysema with tough bronchitis, and in croupous pneumonia.

Moist cough with fluid (more purulent) expectoration is easier, "looser." Here it is often remarkable what a quantity of sputum is thrown off, as from a cavity—sometimes from two efforts at coughing. Moreover, with patients who are weak and very miserable, often a series of efforts are necessary, which efforts then generally end with hawking (*phthisis in extremis*).

In *whooping-cough* the cough occurs in pronounced paroxysms. Here the inspiration is noisy, because it must be taken as quickly as possible, and also because the glottis is narrowed by swollen mucous membrane. In consequence of the prolonged effort at coughing, of the constantly increasing intra-thoracic pressure, and the diminished breathing, which causes a disturbance of the interchange of gases and blood-stasis, there is cyanosis; here, as otherwise in long-continued labored efforts at coughing, especially in phthisis, they finally very frequently end in vomiting. Severe attacks of coughing, moreover, result from swallowing the wrong way, as in paralysis of the throat from various causes. Unconscious patients often swallow the wrong way without any cough.

The tone of the cough may be unnaturally deep and rough, like the voice, in ulceration of the larynx; in stenosis of the larynx it is either a short stenosis sound, or rough and bellowing (the latter with children with diphtheria or false croup); in continued aphonia the cough is sometimes toneless, sometimes remarkably rough and sharp.

Hawking only brings up masses lodged in the pharynx, larynx, or the upper part of the trachea; but it must not be understood that what is thus brought up is formed at these locations; it may be

brought to the lower part of the larynx by previous cough or by the motion of the ciliated epithelium.

EXPECTORATION, SPUTUM.

By these terms is understood all that is brought up from the air-passages by coughing and hawking. According to the existing disease, they are formed from the secretions of the laryngeal, tracheal, and bronchial mucous membrane, from the contents of the alveoli of the lungs, and, lastly, from the contents of pathological cavities of the lungs, or from the lung tissue. In rare cases purulent exudations from the pleural cavities, from rupture of the pleura, may reach the air-passages and appear as sputum; still more rarely, by communication of the œsophagus or rupture of an aneurism, particles of food or blood may pass this way. The secretion of the mucous membrane or of the glands of the throat, of the mouth, of the nose, and also other substances from these locations (as blood, microorganisms, particles of food), mingled in various proportions with the expectoration, may give rise to error. Expectoration may be entirely wanting, even when the material for expectoration may be present in the air-passages in considerable quantity, when there is absence of cough, or when the cough is feeble (see page 165); finally, it may sometimes happen in all diseases of the respiratory organs that there is either no cough at all, or only a dry cough. It is not unimportant to note that blood escaping from the stomach by vomiting may give occasion for swallowing and then be expelled by coughing; but, on the other hand, in hemorrhage of the lungs a part of the blood—sometimes a considerable quantity—may be swallowed, and may give rise to symptoms of hematemesis.

When possible, it is best to collect the expectoration in a transparent glass vessel (as a matter of fact, we may readily understand that we shall generally have to employ a non-transparent receptacle). As much as possible, mixture with other substances, as vomited matters, is to be avoided. A white porcelain plate, with one-half of its surface blackened with asphalt, enables one to scrutinize more exactly the expectoration. The expectoration upon both halves of the plate is to be examined, and, in order to separate it or to remove a portion for microscopical examination, we employ a pair of microscopic needles.

1. *General Characteristics of the Expectoration.*

We must take into consideration the *quantity, reaction, consistence, or form* (here are included also the quantity of air mingled with it, and its arrangement in layers), its *color* and *transparency*, and, finally, its *odor*.

The quantity of expectoration changes with the amount of material which is in a condition to be thrown off (and this differs very much with different diseases) and with the strength of the cough. We have already referred several times to the influences that determine this. In general, patients with certain forms of *bronchitis* (broncho-blennorrhœa) and with *cavities*, especially those with *bronchiectasis*, have the most abundant expectoration; it may amount to one or two litres a day. Sudden marked increase of expectoration occurs with the rupture of *empyema* into the lungs.

When not much contaminated with vomited matter the reaction of the expectoration is always *alkaline*.

From the above-mentioned general peculiarities (*consistence, form, color*, except only the *odor*) we may recognize, according to its chief constituents, in which class the expectoration belongs. Accordingly, we distinguish:

Mucous sputum.

Muco-purulent sputum.

Purulent sputum.

Serous sputum.

Bloody sputum.

Mucous sputum. This is either quite glassy and transparent or whitish-gray, generally with some consistence, and tough; if more fluid, then it consists chiefly of saliva. It occurs in the first stage of *acute bronchitis* from the very slight—what may be called the physiological—secretion of mucus in the trachea. Very often its source is higher up in the pharynx.

Muco-purulent sputum. It consists of a mixture of mucus and pus in varying proportions. The latter is recognized by its yellowish-green color and its want of transparency. It may be distributed through the mucus in small particles or strings, or it may form larger flocks or balls held together by mucus: the latter, placed in water, are bullet-shaped; spread out upon the bottom of an empty glass, they

sometimes flatten out in circular form (coin-shaped sputa in case of cavities, but sometimes, also, in ordinary purulent bronchitis, as in measles); finally, in the scanty, spongy mucus with slight consistence, the pus of the separate sputa may run together ("confluent sputa"). If the sputum contains many air-bubbles, then these cause the separate lumps and balls to float in the watery part of the sputum (serous fluid, or very watery mucus, or saliva). *Mucus in three layers* consists of an upper layer of masses and balls, which the air-bubbles cause to swim and from which hang down into the second layer, consisting of watery mucus and serum, slimy, purulent strings; on the bottom is a layer entirely confluent, like a deposit of decomposed pus (fetid bronchitis, gangrene of the lung).

Purulent sputum consists of almost pure pus, whose source is either an abscess of the lung which has given way, or an empyema. Sometimes almost pure pus may be coughed up when there is a sudden very considerable discharge from a cavity. As it traverses the air-passages, there is always some mucus mixed with it.

Serous sputum is a special peculiarity of the sputum of *œdema of the lungs*. It is very fluid, but not so much so as blood-serum, being mixed with mucus. It consists of blood-serum, and, hence, contains albumin; for this reason it retains air vesicles for a long time, as do all fluids containing much albumin; it is markedly frothy. It is either a quite light gray and transparent, or, as is frequently the case, like beef-juice, owing to a slight admixture with blood; when containing much blood, it is the color of prune-juice (*œdema of the lungs with pneumonia*).

Bloody sputum. All of the varieties of sputum previously mentioned may be mixed with blood. Slight mixture of blood is seen in the expectoration of tough mucus as bloody streaks (generally from the upper air-passages, often from the throat or nose, but yet sometimes from the lungs or the smallest bronchial tubes, as in pneumonia). A small quantity of blood with partial escape of coloring matter of the blood, intimately mixed with tough, glassy mucus, colors the sputum uniformly bright red with a greenish tinge, or, by transformation of the coloring matter of the blood, makes it yellowish-red, rusty, even greenish (all of these with *pneumonia*). In muco-purulent sputum, blood appears either in streaks or as little spots, as in phthisis, or intimately mixed: the pus is then reddish-yellow, brownish-yellow, or

more markedly reddened (not infrequent with cavities). When there is only a small amount of blood, serous sputum is the color of beef-juice.

If there is considerable hemorrhage with the expectoration, it is markedly colored with blood; sometimes there may apparently be no sputum, but fluid blood may be expectorated in a liquid state, coagulating afterward. This is described as *hemoptysis*. When a pulmonary hemorrhage is quickly coughed up, the blood is bright-red and frothy from being mixed with the sputum; but sometimes it gushes out in such quantity that there is no cough. It is distinguished from blood that comes from the stomach in that the latter, from longer stagnation and from the effect of the secretion of the stomach, generally is darker, quite brown, like coffee-grounds; besides which it is often mixed with food and *has an acid reaction*. Yet the blood from the lungs, though only when there is considerable quantity, may be also dark, even black-red, if it has stagnated in the lungs or air-passages: thus, a patient who has had an hemoptysis may continue for a whole day to throw off markedly bloody sputum, which becomes more and more dark in color.

Hemorrhage of the lungs occurs very much more frequently with tuberculosis than from other causes. In this disease there occur all varieties of hemorrhage, from the scarcely-visible particles of blood or a slight coloring of the purulent discharge from a cavity to the profuse, almost immediately fatal hemorrhage. Moreover, in *infarction* of the lungs there may be bloody sputum, or even pure blood may be discharged. *Croupous pneumonia* and *œdema of the lungs* are generally accompanied with slight quantities of blood intimately mixed with the sputum.

Sometimes it is perfectly easy to diagnose hemorrhage of the lungs, and again it is extremely difficult. Particles and streaks of blood occurring in the midst of purulent material are very suspicious. If they occur with gray mucus, it is generally quite unimportant (pharynx, nose); but when there is considerable hemorrhage, there may be doubt as to whether the blood comes from the stomach or lungs if the blood is expectorated very rapidly, and so is yet bright-red, and if, during the act of vomiting, some blood is aspirated and causes cough. On the other hand, blood from the lungs may seem to come from the stomach if, from stagnation, it is unusually dark, or if a part of it is swallowed

and then vomited. Blood from the nose and throat, when the patient is unconscious or asleep, may be drawn into the air-passages, and then, after considerable has accumulated, be coughed up, but more frequently it flows into the stomach. In the latter case, by inspection of the throat we may sometimes see a streak of blood marking the track upon the posterior wall of the pharynx. In all such cases a decision is to be reached by the most careful examination of both the lungs and stomach.

A peculiar sputum, like raspberry jelly, is observed in cases of *tumor of the lungs*. Sometimes in *hysteria* there is an expectoration from the pharynx or œsophagus of a peculiar raspberry red, which may mislead one (recently described by E. Wagner).

The odor of sputum is ordinarily stale; when it is scanty, it is often offensive from mixture with the secretions of the mouth, especially among the lower classes or when the patient is very sick. Purulent sputum from a cavity, if it has been long retained, may be putrid or have a peculiar putrid-rancid odor (only with phthisical patients *in extremis*). In cases of *fetid bronchitis*, *bronchiectasis*, and *gangrene of the lungs* a more marked and very characteristic, sharper and more penetrating, quite offensive odor from the muco-purulent sputum decomposing in the air-passages, is commonly present; but in the last-mentioned disease it may be entirely wanting (“*odorless gangrene*”). Offensive odor of sputum may sometimes be caused by decomposition of particles of food in the mouth or by offensive plugs in the lacunæ of the tonsils, and thus one may be entirely deceived.

2. *Foreign Substances in the Sputum which are Visible to the Unaided Eye.*¹

The inhalation of *coal-soot* (most frequently by those especially exposed to it, but also by all dwellers in cities) colors the sputum, in streaks or diffusely, blackish-gray. When *iron-dust* is inhaled, it

¹ Nowadays the microscopical examination of the expectoration, with its brilliant, but partial, results, is carried to such an extent, and so calls the chief attention to this secretion, that it seems necessary to draw attention to the importance of examining it with the unaided eye. Carefully conducted, it not infrequently brings the physician, in difficult cases, directly to a correct diagnosis, beside facilitating the use of the microscope in showing how to find the right spots. Hence, this section is introduced with careful consideration.

colors the sputum quite black, or ochre-yellow and red (see on this point, also, under Microscopical Examination). When the sputum is scanty it is more deeply colored than when it is abundant, since in the former case the coloring-matter is more concentrated.

We have already referred to the addition of blood. The presence of *hæmatoidin* is sometimes evident to the unaided eye by a yellowish or brownish-red color in separate spots; it occurs in the lungs when there is *disease of the heart*, in cases of *abscess of the lungs*, and in *empyema* (confirmation by the microscope, see page 181).

In *icterus* the *bile pigment* is sometimes present in the expectoration; it has often been observed by myself (as well as others) that in *pneumonia with icterus*, more particularly, it colors the sputum a distinct yellow-green or green.

In *abscess of the lung* we observe lung-tissue in the shape of larger or smaller pieces. These "lung sequestra" may sometimes be very large—2.5 cm. long. (Salkowski, of Leyden). Pieces of cartilage from the trachea or the bronchial tubes, in deep *ulceration* and the accompanying *perichondritis* of these organs, will sometimes be coughed up.

Fibrinous tubes, formed in the bronchial tubes as a result of fibrinous inflammation there, may form a more or less considerable part of the expectoration. We may have a firm cast of an entire dichotomous ramification of a large bronchial trunk even to the finest branches (even to the alveolar tubes and the alveoli?); more frequently they come from the smaller bronchi, and are only divided two to five times. Very often these casts are thrown off while they are fresh, as is evident by their white color; they are also often yellowish-brown, or else reddish, from the addition of blood. They are often found as irregular lumps covered with mucus or small flakes, so that the inexperienced do not recognize their true character. In order to make them out, it is necessary to isolate them by shaking them up with water in a test-tube. Generally they exist only as casts of the smaller bronchial tubes in *croupous pneumonia*, and are most abundant before and during resolution: as dense large casts in *chronic croupous bronchitis*, and in *acute croupous bronchitis*, in consequence of laryngeal and tracheal croup.

Complete casts of the trachea, and even of the larynx, are sometimes thrown off in croup. Casts wholly from the smallest bronchial

tubes, or, in reality, from the alveolar channels, occur in bronchial asthma; and, more rarely, in croupous pneumonia as the so-called

FIG. 26.

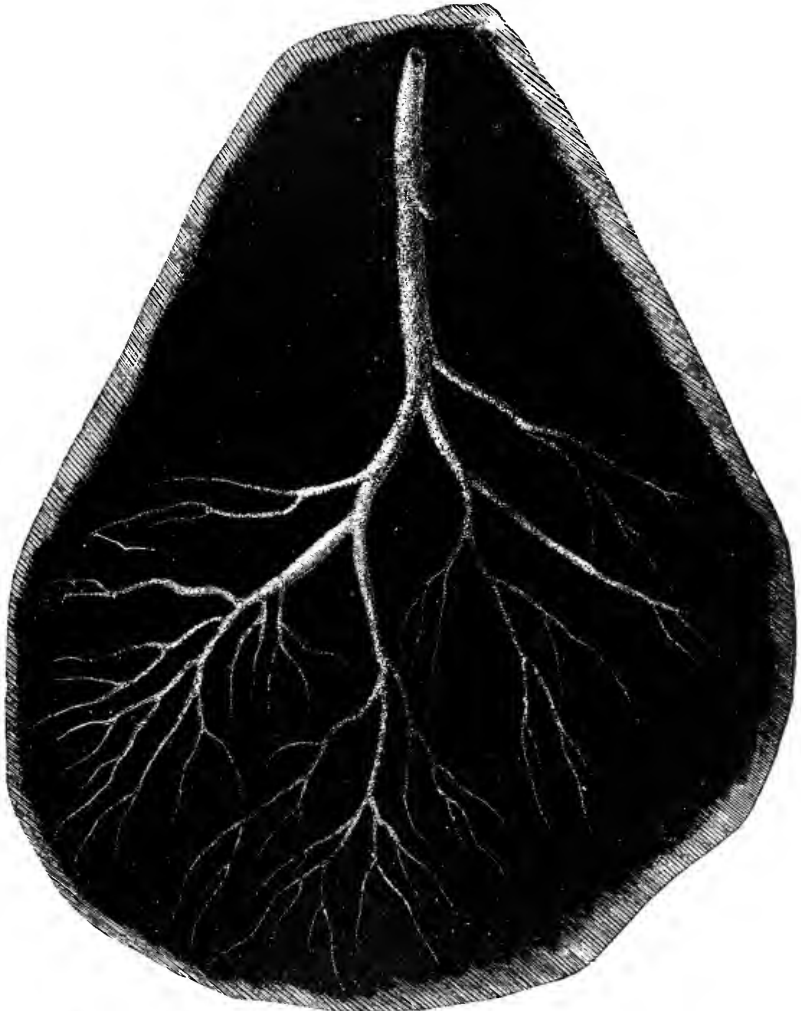

Large bronchial coagulum (chronic fibrinous bronchitis). (After RIEGAL.)

spirals. In the expectoration their smallest forms constitute diminutive gray transparent or whitish opaque flocks or lumps which

frequently, on close examination, look like fine hairs rolled together. (On these bodies, see p. 179.)

Regarding echinococcus bladders, and the exotic *Distoma pulmonum* (Bälz), found in the sputum, see under Microscopical Examination.

Of the *crystals* occurring in the sputum (which, of course, can only be perfectly made out by examination with the microscope), sometimes by careful examination with the naked eye two forms may possibly be

FIG. 27.



Bronchial coagulum, natural size, with croupous pneumonia. In this disease the small forms are very frequent, the large ones very rare, but frequent with chronic fibrinous bronchitis.

recognized. In the fetid sputum in three layers (fetid bronchitis and gangrene of the lungs) there exist peculiar grayish-yellow, very offensive lumps, which may be barely visible, or may be as large or larger than lentils; these lumps inclose fat-crystals (see p. 181). These same bodies occur as offensive plugs from the lacunæ of the tonsils, although never in so large a quantity as in the other conditions. Hence, when they are found in the sputum we must always carefully examine the tonsils.

Further, in chronic *croupous bronchitis* and in *bronchial asthma* there are found embedded in the sputum, sometimes adhering to the concretions, peculiar, small bodies, yellowish kernels, like grains of sand, which easily strike the practised eye; these, generally numerous, are the so-called Charcot-Leyden's crystals (see p. 181).

It remains to mention some fungi found in the sputum, whose

presence may be indicated by the macroscopical examination, but this examination would be without diagnostic value unless confirmed by the microscope. Different kinds of mould (especially *Aspergillus fumigatus*) are very rarely found, except as a pathological result, and generally in phthisical cavities, which are noticed as gray or greenish, little collections; *muguet* (see), as white tufts almost always arising from the mouth and throat (hence, these are to be carefully examined); *leptothrix buccalis*, sometimes mixed in the mouth with expectoration; if it stands some time in a warm place, developing as a yellow coating—all exceptional appearances of slight importance.

The finding of *actinomyces* in the expectoration is of greater importance, but of yet greater rarity. It can be recognized by the naked eye by the little kernels of uniform size, shaped like millet-seeds, greenish-yellow or yellowish-white, sometimes somewhat glassy (I have seen them in one case); of course, they are only to be accurately recognized by the microscope.

Also, we may sometimes conjecture the presence of the *tubercle bacillus* with the naked eye (which makes the microscopical examination easier), by the presence of yellowish, generally flat lumps—"lentils"—in the sputum from cavities, which, besides, usually contains many elastic fibres (see p. 177); and, also, although much more rare, if there are small white (scarcely visible) scales, very like those of which the artificial pure culture of the *bacillus tuberculosis* consists. Both elements, especially the latter, usually contain or consist of masses of bacilli. It is very easy to be deceived by the admixture of food-particles. Chiefly is this the case from the small white lumps of coagulated milk (which not infrequently contain fat-crystals) and minute particles of bread.

3. *Microscopical Examination of the Sputum.*

Small particles are placed under a glass cover, which is to be only moderately pressed. It is to be examined with a No. 7 or 8 Hartnack, or E or F Zeiss.

In all mucous and muco-purulent sputum there are threads of mucus and mucous corpuscles; the former are more sharply defined the tougher the mucus is. In pneumonia and asthma they are often spiral, and

in these diseases they pass by imperceptible gradations over into the finest and most delicate fibrinous formations. (See Spirals.)

White blood-corpuscles are found in all expectoration, but in much greater numbers in the purulent parts. They are generally of various sizes, granular, not infrequently filled with drops of fat and myelin, or contain particles of soot; and lastly, and more rarely, minute lumps of hæmatoidin (see).

Red blood-corpuscles are found in the different kinds of bloody sputum, generally with the form well preserved, but often paler, even as rings; when the sputum has been retained for a long time they are granular.

Epithelium. Flat epithelial cells from the mouth are a common ingredient of the sputum. They are easily recognized by their size and thinness, which manifests itself by numerous cracks and folds. Flat epithelium, which probably comes from the œsophagus, occurs in large clusters in the so-called bloody sputum of hysteria.

FIG. 28.

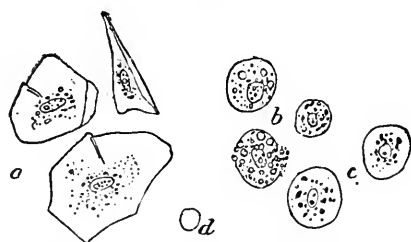

Epithelium from the sputum. *a.* Flat epithelium from the mouth. *b.* The so-called alveolar epithelium, containing little drops of fat and myelin. *d.* A red blood-corpuscle.

Changed *cylindrical epithelium* of the air-passages in the form of mucous and goblet cells are observed in all cases of catarrh of the trachea or of the bronchi, and sometimes in large numbers. On the other hand, it is rare to find these epithelial cells in their original condition, with homogeneous protoplasm, with bladder-like nucleus, covered with cilia; and still more rare to obtain the motion of the cilia, or to find it responsive to heat. The possible origin of these cells in the nose is not to be overlooked. They have diagnostic value.

The so-called *alveolar epithelium* (see Fig. 28) was formerly considered an important constituent of the sputum. But it is neither possible to affirm its source nor to give its diagnostic value. There are elliptic, or round, not infrequently somewhat flattened, cells with

an often indistinguishable nucleus (made visible by the addition of acetic acid), larger than the ordinary white blood-corpuscle. The protoplasm is fine or coarsely granular, sometimes filled with drops of fat or myelin (Virchow); also we may see complete fatty degeneration with formation of large fat and myelin drops. These cells contain particles of coal or iron dust (the latter made dark green by sulphide of ammonium, blue by yellow prussiate of potash and muriatic acid). In the lungs of cases that have died with *heart disease* they are found filled with lumps of hæmatoidin.

This alveolar epithelium occurs in bronchitis and all kinds of acute and chronic *pneumonia*, hence does not have any diagnostic value. Its epithelial character is not at all constant. I think it quite probable that it is mostly or altogether made up of white blood-corpuscles, enlarged by metamorphosis, or their protoplasm, and partly by absorption of small particles. In part, also, this may come from the deeper layer of the bronchial epithelium (Panizza, Fischl, Senator). On the other hand, the so-called *cells of heart disease* containing hæmatoidin are significant in recognizing the lungs of cases that have died from disease of the heart.

Elastic threads are an important constituent of sputum, since they infallibly show the destruction of lung tissue (less frequently of the tissue of the bronchi), but still more because they indicate such a severe disease of the lungs often before there are physical signs. They occur in *tuberculosis, gangrene, abscess of the lungs*. They generally have a double outline; now and then there are branching fibres, which have a serpentine course or large irregular curves. They generally lie in bundles, and often show the structure of the lung-vesicles.

They always exist in clusters and with a remarkably alveolar arrangement in the shreds of lung tissue in abscess of the lungs, and when there is suppurating gangrene; further, almost always in the so-called "lintels" of tubercular sputum. When elastic threads occur singly, which may be in all the conditions named, it is very difficult to say which is their special cause. Then, also, it is not easy to distinguish them from fat crystals (see), and farther from elastic fibres in food. Besides, since the discovery of the bacillus tuberculosis their importance for the early diagnosis of phthisis has disappeared; but

for determining whether we have a more or less destructive form of phthisis they are as valuable as ever.

To obtain elastic fibres, when they are not present in quantity, a

FIG. 29.

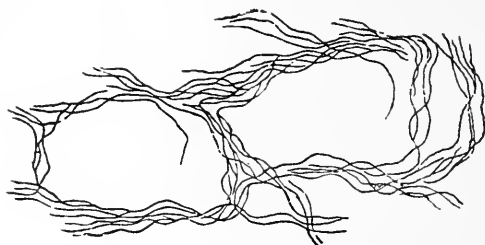

Elastic fibres. (After STRUEMPELL.)

FIG. 30.



Curschmann's spirals, natural size. (After CURSCHMANN.)

portion of sputum is boiled with an equal quantity of an 8 to 10 per cent. solution of caustic potash; then the jelly-like mass is to be diluted with water and allowed to stand for twenty-four hours. The elastic

fibres, as distinct organic substances, settle to the bottom, but are much swollen and not readily distinguished from fibres of the food.

In individual cases of *gangrene of the lungs*, but by no means in all, elastic fibres may be wanting; possibly they may be destroyed by the action of a ferment (Traube) [see p. 190]. Moreover, simple gangrene of the lungs is rare; we generally have a suppurating gangrene, and this can hardly fail to furnish the shreds of lung tissue previously described.

Spirals (Leyden, Curschmann, Zenker). They exhibit the finest forms of bronchial products, and hence correspond probably to a (fibrinous) catarrh of the smallest bronchial tubes. With some practice they are recognizable by the naked eye (Fig. 30), and under a glass cover when somewhat spread out by very slight pressure, even without any amplification, there may be seen a spiral twist, and often in the centre a bright line which is generally wavy. When very

FIG. 31.



FIG. 32.

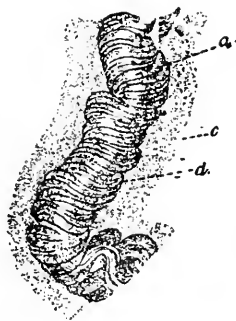
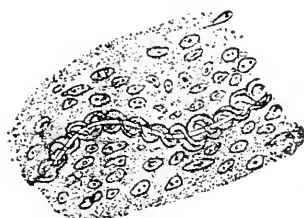

FIG. 33.



Curschmann's spirals. *a*. Central fibre. (After CURSCHMANN.)

slightly magnified (best seen with a simple microscope of good power) we can plainly see the spirals formed out of fibres wound like a corkscrew; and further, we can see the streak in the middle, the central thread, as a homogeneous, a somewhat bluish-tinted structure, coursing exactly along the middle of the tube. This central fibre, which may be entirely wanting, does not exhibit a sharply-defined contour, no matter how much it is magnified or how the focus of the microscope is adjusted. It is probably not a material structure, but an optical image of a space-cavity or of a strand of tightly-twisted fibres in the centre of the spiral. Regarding the peculiar finely granular cells accompanying them, and Charcot-Leyden's crystals, see page 182.

Curschmann has affirmed that these spirals have an important diagnostic, and indeed a causal relation to bronchial asthma ("bronchiolitis exudativa," Curschmann). They are especially abundant in these cases, in many patients only at the time of the attack, so that as the attack passes off, they are excreted in quantity. Rarely, and without diagnostic importance, they are present in *croupous pneumonia* (O. Vierordt, von Jaksch, and others). I saw them in a case of very chronic tuberculosis of the lungs. According to Pel, they consist largely of mucin.

Starch corpuscles They are often found in *hemorrhage of the lungs* (Friedreich), and in *gangrene* (von Jaksch), but are as yet without significance.

Crystals. Crystals of hæmatoidin are brownish-yellow, if pure, of a shining color, rhombic plates, or fine needles, and these single, or two or three crossed, or in tufts. The crystalline formation may also occur as grains and lumps; not infrequently in the centre is a white blood-corpuscle, and it may be that the needles are arranged with their points standing out from the cells.

FIG. 34.



Crystals of hæmatoidin.

FIG. 35.



Needles of fatty acids. (After STRUEMPELL.)

They indicate that blood has been long retained: in *gangrene* with formation of abscess; in the *pus of empyema* which has perforated a long time before, as in one case that came under my observation of a slow hemorrhage into the lungs from a thoracic aortic aneurism.

Sometimes there are spots macroscopically visible when there is hæmatoidin in the sputum. (See p. 172.)

Crystals of fatty acid (margaric acid crystals, see Fig. 35). They are long, thin, slender needles, slightly or very markedly bent, which are found singly, in large bundles or nodules, or quite irregularly arranged. They are generally distinguished from elastic fibres by the uniformity of their curving. When a portion of sputum is dried in the air, without heat, they are completely dissolved upon the addition of ether, while the elastic fibres under the same circumstances are not changed. They occur generally in masses, in *gangrene of the lungs* and *fetid bronchitis*, and especially in the lumps or plugs previously mentioned (page 174); they are also found in the plugs which are formed in inflamed tonsils (see); finally, they may occur singly in any muco-purulent sputum, especially after standing in a warm place for some time.

FIG. 36.

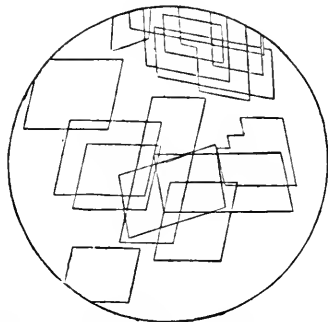

Crystals of cholesterine. (After STRUEPPELL.)

Cholesterine crystals. These are thin rhombic plates with the corners cut out, which become green and then red when treated with dilute sulphuric acid and tincture of iodine. They are sometimes found in old perforating pus, also in tuberculosis.

Charcot-Leyden's crystals. These are slight, somewhat blue, shining, elongated octahedrals of great variety of size, sometimes visible with a simple microscope, often only to be seen with a No. 8 Hartnack. They seem to be identical with the crystals found in the blood and marrow in *leukæmia*, also sometimes occurring in the feces. They probably consist of a mucous substance (Salkowski).

As a sign of *bronchial asthma* they are of great diagnostic importance (see Spirals); they then occur most abundantly during and after the attacks (Leyden). They are less frequently found in *acute bronchitis*, *chronic croupous bronchitis*, and *tuberculosis*.

FIG. 37.



Charcot-Leyden's asthma crystals. (After RIEGEL.)

The points in the expectoration of asthma where these are found can often be easily recognized with the naked eye as dry crumbs (see p. 174). They are very often mixed with peculiar, fine, granulated round cells which look as if filled with dust; at the same time with these are found spindle-formed figures with a slight glistening—a transition stage to Charcot's crystals (?). These crystals are found especially numerous upon and in the "spirals," and also with them these spindle-formed cells.

In isolated cases there are found in the sputum *tyrosin* (*fétid bronchitis*, *empyema*, according to Leyden), *oxalate of lime* (*diabetes*, Fürbringer; *asthma*, Ungar), and *triple phosphate* (see chapter on Urine, the section upon these substances).

Animal parasites. We may have whole echinococcus bladders or their fragments (recognized upon cross-section by the remarkable,

uniform streaking), and also the hooks of the scolices in the sputum, in case one of these parasites enters the bronchial tubes by rupture from the lungs or liver (slight increase in size).

FIG. 38.

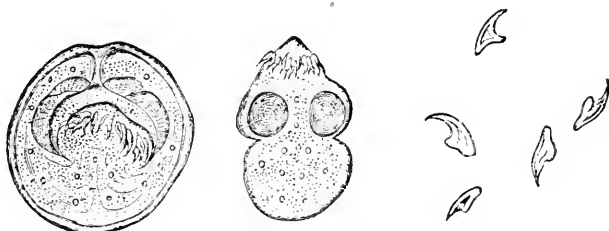

Echinococcus. (Scolices, hooks, after HELLER.)

The (exotic) *Distoma pulmonalum* (Bälz) which causes hemorrhage without any other manifestation, declares itself by its eggs in the sputum (to be seen by the simple microscope).

FIG. 39.

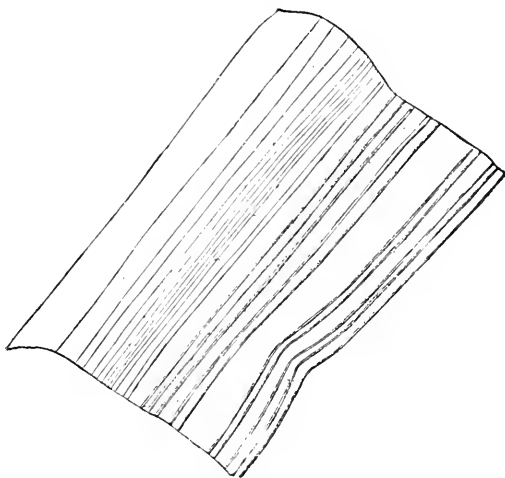

Echinococcus membrane, cross-section enlarged.

Infusoria (*Monas*, *Cereomonas-Kannenberg*) are found in gangrene; they are seemingly without significance.

Fungi (for the macroscopic evidences of the presence of some of them see p. 175).

Leptothrix buccalis is present in the yellow scum arising on sputum that has been standing some time, as has already been mentioned, in the bronchial plugs in putrid bronchitis (besides crystals of fatty acids), and also occurring separately. Either it is first mixed in the sputum in the mouth, or it has entered the air-passages from the mouth; but it is present there without any known pathological significance. *Specific reaction:* With iodine and potass. iod., it is stained blue-red. [For formula, see p. 189.] Without this reaction it may be confounded with elastic threads, even with fatty acids (see the chapter on the Digestive Apparatus).

FIG. 40.



Tubercle bacilli in the sputum, first colored with anilin-fuchsine and then with methylene-blue. Zeiss's homog. immersion $\frac{1}{2}$, Oc. 4, camera lucida drawing. Magnified about 1000 diam.

Sarcina pulmonalis is a fungus formed by division from developing endogenous spores (Hauser). While it is similar, although smaller, it has nothing to do with *sarcina ventriculi*. The recent views upon their frequent presence may be somewhat questioned (confounded with *Micrococcus tetragenus* (?) Flüggé). It has no known pathological significance.

Tubercle bacillus (Koch). This generally occurs in the purulent parts of the sputum of *tuberculosis* of the lungs or trachea. Exceptionally it may be mixed with the sputum from the throat and pharynx (nose), in case a tubercle breaks up at that point. They are generally very abundant in the so-called "lintels," and (rarely) in very small white scales (see p. 175). These split fungi are straight or moderately—rarely much—bent, very thin rods of somewhat variable length, 2 to almost 4 μ .¹—that is, about the diameter of a moderate-sized white blood-corpusele. They often contain spores. On account of their thinness and because they are without motion, they are with difficulty seen in the sputum unless they are colored. In order to bring them into view we stain them, and by a method which at the same time produces a special reaction, and so a very certain proof that it is the tubercle bacillus and not one of the numerous other bacilli. It is to be magnified 600–400, or, for those accustomed to examine for it, 300 diameters—that is to say, with a $\frac{1}{12}$ Abbé oil immersion lens, or a Hartnack No. 8 or at least No. 7.

Methods. I. (Weigert-Ehrlich.) With perfectly clean needles we place some sputum upon a plate with a black surface, and there spread it out with the needles. From this is selected a suitable portion (see above) and place it upon a glass cover, and then it is to be broken up with the needles. Upon this is now placed another glass cover and the two are pressed firmly together. What is squeezed out upon the edges is to be washed away, and then the two glasses are to be carefully separated, so that there may remain upon each the thinnest possible layer, equally distributed. These are then laid aside to dry. Then 20 drops of anilin oil are thoroughly mixed with a small test-tube full of distilled water, it being shaken till it is intimately mixed. The mixture is allowed to stand for a short time, and then some of it is to be filtered through a moistened filter into a watch-glass. From a previously prepared concentrated alcoholic solution of fuchsine there is then to be added sufficient to make the mixture opaque or to cause a slight metallic shimmer to appear upon the surface; about 6 drops are necessary. Good fuchsine S. is necessary.

The glass covers are allowed to dry in the air, and then each is passed three times through the flame of a spirit-lamp and laid in the

[¹ The Greek letter μ represents one-thousandth of a millimetre ($\mu=0.001$ mm.), and is the sign of a *micro-millimetre*, or a *micron*.]

coloring-solution with the sputum side down. The watch-glass, covered over, is allowed to stand for twenty-four hours, or it is slowly warmed over the spirit-lamp until a slight deposit of moisture appears not only upon the edges, but also upon the middle, and then it is set aside for about ten minutes.

The manipulation is continued by washing the glass cover in water and then for a few seconds dipping it in a mixture of one part of nitric acid and two of water (without letting go of it with the pincers) until it, being again washed in water, continues to show a slight red shimmer. Then the preparation may be immediately examined in water: the tubercle bacilli are colored an intense red, while all the rest is colored a pale reddish tone. It is advisable to stain the glass cover a second time with a watery solution of methylene-blue, which is done by placing it in this solution for a minute or two after taking it out of the acid mixture and thoroughly washing it with water, then again washing it, when it may be examined.

Instead of fuchsin and methylene-blue we may, in exactly the same way, employ gentian-violet and Bismark-brown. The preparations are preserved by first drying them in the air, then passing them three times through the flame before laying them upon slides upon which has been placed a drop of xylol-Canada balsam.

The decolorizing with the nitric acid solution must not be too prolonged, else the bacilli lose their coloring. With preparations that are to be preserved, the nitric acid must be very carefully removed by repeated washings with water, because the acid destroys the color.

The alcoholic gentian-violet, as well as the fuchsin solution, retains its color very well. Sometimes the Bismark-brown, and also the methylene-blue, must be filtered before using. Besides these, one needs for his work a black plate, two needles, a pincette with broad beak, some watch-glasses, glass slides and covers, and a spirit-lamp.

Biedert has recently recommended the following method for *demonstrating the bacilli when they are scant in numbers*: A teaspoonful of sputum and two teaspoonfuls of water are boiled with fifteen drops of solution of caustic soda, then four teaspoonfuls more of water are added and the whole again boiled till it forms a homogeneous fluid. It is allowed to stand for two days (not longer) in a conical glass; possible bacilli (and elastic fibres) form a sediment. The sediment is stained, not by the method described above, but by the

method recommended by Ziehl-Neelsen: instead of the aniline water and gentian-violet, we use a mixture of 90 parts of a 5-per-cent. solution of carbolic acid and 10 parts of concentrated alcoholic solution of fuchsine, staining by heat as above described; the other procedures are also the same as above referred to.

Where one is not accustomed to examine for bacillus tuberculosis, for the purpose of controlling the degree of staining he should at the same time stain some sputum that is known to contain the bacillus [or he should keep test slides on hand].

II. A new and decidedly useful mode of procedure is given by Gabett. A dry preparation which has been passed through a flame is placed for two minutes in a solution of 1 part of fuchsine S. in 100 parts of a 5 per cent. solution of carbolic acid and 10 parts of absolute alcohol, and then, immediately after, for one minute in a solution of two parts of methylene-blue to 100 parts of 25-per-cent. sulphuric acid. It is rinsed with water, and then, for preservation, is washed with alcohol, dried, and mounted in Canada balsam. For the sake of greater certainty, it may be warmed in the first solution. The preparations are very beautiful and permanent. The method seems to be a very distinct one. It is necessary to make very thin, and likewise uniformly thin, preparations.

The *tubercle bacilli* are distinctly recognized by their red (or blue) staining. Since the spores that may be present are not stained, they may be seen in the interior of bacilli as clear points, and they may be so abundant as to cause the bacilli, when only slightly magnified, to look like the chain coccus (Fig. 40).

The presence of this bacillus in the sputum indicates *tuberculosis of the lungs* (unless there may be tuberculosis of the larynx). Quite a close approximation of the severity of the disease may be made by the number of bacilli, but more closely by the quantity of the spores. Bacilli may often be discovered when the physical signs are still indistinct or are altogether wanting.

Absence of the bacilli at a single examination is without value. So, also, when the sputum is scanty and not very purulent, if they are absent in repeated examinations this fact is to be considered with greater caution. On the other hand, in sputum that is not too scantily purulent, the constant failure to find bacilli points with greater probability against tuberculosis. It is to be understood that

the staining material is as it should be (see above), that the staining has been properly done, and that the most careful examination of the preparation has been made. The culture-test, with the material in question, would come still nearer the truth. (See also in Appendix.)

Pneumonia cocci: The reports regarding these cocci are still conflicting. Friedländer has found micrococci both in the sputum and in the tissue-fluid, of oval form, single, or two or three arranged together, lying in a capsule which can be stained. But Friedländer himself acknowledges that, without the existence of pneumonia, these cocci—or cocci which cannot be microscopically distinguished from them—are also found in the sputum. We have found Friedländer's cocci¹

FIG. 41.



Fränkel's pneumonia coccus, bred from the expectoration. Prepared by Prof. Gärtner. Oil immersion lens, one-twelfth; eye-piece No. 4.

in numerous cases of broncho-pneumonia and bronchitis. The cocci which A. Fränkel found in the lungs in pneumonia are lancet-shaped and they generally occur as double cocci, and are, like Friedländer's, in a capsule. Fränkel's coccus is likewise found in empyema and meningitis, which complicate croupous pneumonia. It also occurs in normal saliva. Finally, Pio Foà has discovered in the tissue-juice of the pneumonic lung a diplococcus inclosed in a capsule which is very like both of the cocci named above.

Staining of Friedländer's coccus: A dry covering-glass preparation is placed for a few minutes in a 1-per-cent. solution of acetic acid, then this is blown away with a pipette; dry in the air; dip for a few seconds in aniline water and gentian-violet solution (see above), rinse in water (Friedländer.) Fränkel's coccus is stained with all aniline dyes. Pio Foà recommends Gram's method for his coccus.

3. *Micrococci* and *bacilli* of all sorts, also *spirochætae*, are found

[¹ Friedländer's cocci are now known to be bacilli.]

in every specimen of sputum—from the mouth! They are very much increased in *fetid bronchitis*, in *bronchiectatic cavities* and *gangrene of the lungs*; and also in every sputum that has stood long and become foul.

FIG. 42.



Micrococci, bacilli, spirals, spirochaetae, from the sputum. (After PFLUEGGE.)

There may be a simple staining of the dry preparation with methylene-blue, after which it is to be rinsed in water. Or, the preparation, stained according to Gram, with gentian-violet solution and aniline water (see p. 187), may be taken from this and immersed for

FIG. 43.

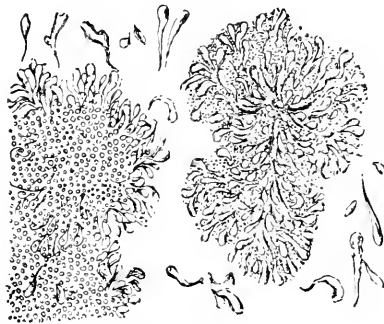

Actinomyces. (After V. JAKSCH.)

two or three minutes in the following preparation: Iodine, 1, potass. iod., 2, aq. destil., 300; then in absolute alcohol till the color disappears. Only the microbes are stained, but these are intensely colored.

4. *Actinomyces*. In actinomycosis of the lungs or of the pleura, in isolated cases, this fungus is found in the sputum. I have observed it in the characteristic small kernels (see p. 175). It is recognized by the projections, like clubs, closely pressed together, which project from the surface of a confused mass, which look much like detritus. We can best see the club-like projections without

staining. The fungus can be distinctly stained by Gram's method [described on the preceding page].

Mould (aspergillus, mucor) and isolated yeast-cells, when seen in the sputum are without significance. The microbe of whooping-cough of Letzerich and Berger still needs confirmation.

CHEMICAL EXAMINATION.—This has a minor place, considered with reference to diagnosis.

There occur in the sputum albuminous corpuscles in the form of mucin, nuclein, serum-albumin. The latter is very abundant in œdema of the lungs. Peptone is found very abundantly in the sputum after the crisis of *pneumonia* (Kosselt); it is also found in excess in all purulent sputum. Temporary fatty acids occur very abundantly in *gangrene of the lungs* (Hoppe-Seyler, Leyden, and Jaffé).

Finally, it is notable that in *gangrene of the lungs* and *bronchitis* there is found a ferment like the pancreas ferment (Filehne, Stolnikow).

CHAPTER V.

EXAMINATION OF THE CIRCULATORY APPARATUS.

EXAMINATION OF THE HEART.

THE development of the methods of local examination of the heart is closely connected with the introduction of percussion and auscultation. So we have here also chiefly to thank Laennec and Skoda, as well as Piorry, Friedreich, Bamber and Gerhardt.

ANATOMY OF THE NORMAL HEART.

The heart lies upon the diaphragm, sloping obliquely forward in such a way that its long axis is inclined forward and toward the left. It extends from about 8 or 9 centimetres to the left of the median line (apex of the heart), to about 4 or 5 centimetres to the right of the same (*i. e.*, about one and a half finger-breadths to the right of the right border of the sternum—right auricle), so that about two-thirds of the heart is in the left half of the chest, and one-third in the right half. Its highest point (the left auricle) is at the lower border of the sternal insertion of the second rib, its lowest point at the upper border of the sixth costal cartilage, or the fifth intercostal space (see Fig. 44). The three borders of the heart are formed as follows: the right by the right auricle, the lower by the right ventricle, and the left by the left ventricle. Only a small portion of the latter lies on the anterior surface, much the greater part of which is formed by the right ventricle.

The figure (Fig. 44) shows how the lungs glide over the heart, so that only a small four-cornered portion, belonging exclusively to the right ventricle, is in contact with the wall of the chest. Of the borders of this superficial part of the heart, the one toward the right lies between the middle line and the left sternal line, the upper behind the fourth rib, the left somewhat outside of the left parasternal line. Below, the heart is in relation with the liver in such a way that it

overlaps the latter with its lower border. It can be seen from the course of the line *c d*, which indicates the complementary space of the *incisura cardiaca lob. sup. sinistra*, what a considerable portion of the heart which is in contact with the chest-wall would become still smaller if the lung should completely fill the complementary space.

FIG. 44.

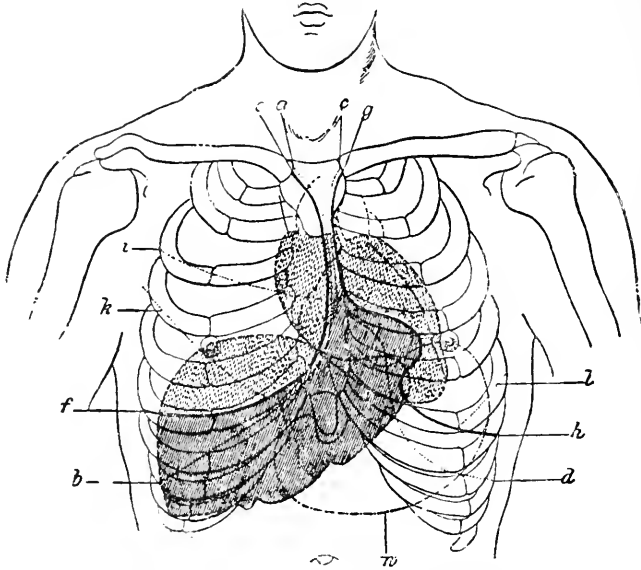

Position of the contents of the thorax, of the stomach, and of the liver from in front. (WEIL-LESCHEA.) The portions of the heart and liver which are drawn with unbroken hatched lines represent the extent to which these organs are in contact with the chest-wall. The portions that are not in contact with the chest-wall, but are covered by the lungs, are represented by broken (clear) hatched lines. *ef*, border of the right lung, *gh*, border of the left lung; *ab* and *cd* (. . .), the boundaries of the complementary pleural sinus. *i*, boundary between the upper and middle lobes of the right lung; *k*, boundary between the middle and lower lobe of the right lung; *l*, boundary between the upper and lower lobe of the left lung. *v*, stomach (greater curvature).

These are the location and extent as they are found in the adult in the dorsal or upright position. With children the heart (as well as the diaphragm and the lower borders of the lungs) is about one rib higher. It is also, since it is proportionately larger, to a larger extent in contact with the wall of the chest; with increasing *age*, on the other hand, it moves lower down (to the lower border of the sixth rib (the

sixth intercostal space) with a smaller portion parietal, since the lungs lie over it to a larger extent. In the side position, especially on the left side, the heart always sinks very considerably to the lower side. (See under Apex-beat.)

Situs viscerum inversus exhibits the heart in such a way that "right" and "left" are exactly reversed, like the reflection in a mirror. Hence we need not say anything more about it.

PRELIMINARY REMARKS NECESSARY TO UNDERSTAND THE PHYSICAL PHENOMENA OF THE HEART.

What follows is a brief explanation of those facts regarding the physiology and the general pathology of the heart, which must be always kept in mind by the educated physician in examining and forming a judgment of the heart.

1. *The movement of the blood in the heart.* The blood flows from the body through the *cavæ* into the right auricle, from whence, during the ventricular diastole, it passes through the right auriculo-ventricular opening, the tricuspid valve, into the right ventricle, being urged forward toward the end of the diastole by the weak muscular contraction of the right auricle. The systole which immediately follows drives the blood out of the ventricle, the tricuspid valve being at the same time closed, through the open pulmonary semilunar valve into the pulmonary artery. The blood, prevented from flowing back into the ventricle during the diastole which immediately follows by the closure of the pulmonary semilunar valve, passes through the lungs, and from them flows into the left auricle, whence, by the diastole of the ventricle, it flows through the left auriculo-ventricular opening, the mitral valve, into the left ventricle, whither it is again assisted at the end of the diastole by the contraction of the auricle. The left ventricle discharges its contents during the systole (the mitral valve being closed) into the commencement of the aorta, through the open aortic-semilunar valve, whence it is prevented from returning to the ventricle when the pressure from the ventricle ceases and the diastole begins, by the closure of the aortic semilunar valve. The blood then flows from the *conus aortæ* into the body.

2. *Valvular insufficiency and its effects upon the movement of the blood.* From the foregoing it is evident that the openings of the

heart are very important factors, on the one side being the entrance and exit of the ventricles, and on the other being the location of the valves of the heart which hinder any backward flow of the blood. The motion of the blood can only in two ways be interfered with by pathological processes at the openings of the heart: either by narrowing at the opening (*stenosis of valve*), or by the valves losing their power to close (*insufficiency of the particular valve*).

Stenosis of a valve may be caused by products of endocarditis, which cause adhesion of the flaps of the valve, with formation of a cicatricial narrowing ring at the base of the valves. Insufficiency may likewise be caused by endocarditis (general shortening of the flaps and of the tendinous processes of the papillary muscles), and this is the most frequent cause of insufficiency; but the condition may also arise from a distention of the opening so that the flaps are too short to close it (relative valvular insufficiency, in weak heart with dilatation).

An opening that is narrowed hinders the passage of the blood through it. If it is an auriculo-ventricular opening (*mitral or tricuspid stenosis*), then, at the moment of diastole of the heart, the blood is hindered in its entrance into the ventricles: there is imperfect filling of the ventricles; if it is an arterial opening that is narrowed (*aortic or pulmonary stenosis*), then the exit of the blood from the ventricles at the systole is interfered with. If the valvular mechanism is in such a condition that it cannot perfectly close, then at the moment when it ought to close it allows a part of the blood to flow backward. If the difficulty is with the entrance to the ventricles (*insufficiency of mitral or tricuspid valve*), then with the systole a part of the contents of the ventricle flows back into the auricle; but if the deficiency is at the outlet of the ventricle (*insufficiency of the aortic or pulmonary valve*), then at the end of the systole, during the diastole which follows, a part of the blood that has just been thrown into the artery will be thrown back into the ventricle.

In one respect all the defects that have been mentioned are alike: they check the blood current, they cause a stasis of blood in that chamber of the heart which is, with reference to the direction of the blood current, just behind the defective opening. Thus a defect of an arterial opening causes stasis in the corresponding ventricle; a defect

in an auriculo-ventricular opening occasions stasis in the corresponding auricle, and also beyond this in the corresponding veins.

3. *Compensation, accommodation of valvular deficiency.* The abnormal resistance which is exerted against the blood-current from the valvular defect would immediately lead to more considerable disturbances of the blood-current if it were not promptly equalized by the increased work of that section of the heart lying (in the course of the blood-current) above the point of resistance. But this does not continue, for with increased work the overloaded section of the heart becomes hypertrophied—*compensatory hypertrophy*. This condition is extremely simple in defects at the aortic opening. They are compensated by hypertrophy of the left ventricle, which is associated with dilatation (eccentric dilatation). The latter is especially marked in insufficiency of the aortic valve, and this is explained by the fact that, with aortic insufficiency, the left ventricle during the diastole receives blood from two sources, hence very much more than normal. With mitral insufficiency the auricle must accommodate for the defect; but, notwithstanding the fact that it becomes dilated and hypertrophied, it cannot perform the necessary work, cannot overcome the stagnation: the accumulated blood passes through it to the veins of the lungs, capillaries and arteries of the lungs, and so on till it reaches the right ventricle; this becomes dilated and hypertrophied, and thus causes the increase of the propulsive power necessary for the accommodation.

Though defect of the valve of the pulmonary artery is rare, the actual consequences are the same as of defect of the aortic valve, defect of the tricuspid, which is likewise rare, with the exception of relative insufficiency, and produces accommodation of hypertrophy of the right auricle, but only to a very slight degree; for the increased pressure in the general venous system has no effect upon the pressure in the arteries of the body, and hence cannot produce any notable compensatory hypertrophy of the left ventricle.

Thus, insufficiency and stenosis of the aorta cause hypertrophy of the left, and insufficiency and stenosis of the mitral valve hypertrophy of the right, ventricle. But with mitral insufficiency something more follows: during the diastole of the left ventricle there flows into it from the dilated auricle the blood which has accumulated there under very much increased pressure and in increased quantity; it becomes dilated, and, since it also has to dispose of the increased quantity of

blood, which it does by driving part of it forward into the aorta and part backward through the mitral orifice into the auricle, it also becomes hypertrophied. Hence mitral insufficiency leads to hypertrophy and dilatation of both ventricles.

These different hypertrophies are aids in the diagnosis of the individual valvular lesions.

4. *Hypertrophy of the heart from other causes.* Besides the valvular defects, certain other conditions lead to hypertrophy: thus, the left ventricle becomes hypertrophied by the increased resistance in the general arterial system produced by *sclerosis of the arteries*; it sometimes results from continued excessive muscular exertion (*idiopathic hypertrophy*), further, from different forms of *chronic nephritis*, and in this it is more marked the longer the general vigor is maintained (hence most marked in renal atrophy); finally, also in *acute nephritis*, if it lasts long enough. The right ventricle becomes hypertrophied whenever there is continued increased resistance in the pulmonary circulation, most regularly and markedly in *emphysema* (from destruction of the capillaries of the lungs from atrophy of the tissue), in marked *contraction of the lungs*, in marked *kypho-scoliosis*.

5. *The form of the heart* is changed in consequence of the hypertrophy (and dilatation): hypertrophy of the left ventricle broadens the heart to the left and somewhat lengthens it; if there is dilatation also, the broadening to the left is still more increased. Hypertrophy and dilatation to the right ventricle simply broaden the heart to the right. Hypertrophy and dilatation of both ventricles broaden the heart in both directions and lengthen it.

6. *Simple dilatation.* This results entirely from weakness or paralysis, and is dependent upon a diminished tone of the heart-muscle with a simultaneous loss of its power to contract. It may also occur in a heart that was previously dilated and hypertrophied, and it then results in a very great enlargement of the heart. In dilatation of the heart the enlargement is nearly symmetrical in all directions.

The diagnosis between enlargement of the heart from hypertrophy (with dilatation) and the dilatation just mentioned is chiefly made by the consideration of the evidences of the amount of work the heart is doing.

7. *The extent to which the heart is in contact with the chest-wall* is in very close relation to the size of the heart (regarding the peri-

cardium, see later). An enlarged heart always has a larger area in contact with the chest-wall than does a normal heart, if there are no conditions in the neighborhood of the heart which keep it away from the chest-wall. This may be occasioned by emphysema of the lungs, or by an increase in the volume of the lungs, whether from anomaly of both lungs or only of the left lung, either chronic or temporary. In emphysema a normal heart therefore would be to a less extent parietal than if the lungs were normal; hence in case of emphysema an enlarged heart may possibly not be manifest by its size, as it would be if the lungs were normal. When there are both enlargement of the heart and emphysema of the lungs the heart may be found to be parietal only to the normal extent, or may be so to an even less extent than normal (overlying of the heart).

Still another condition has its effect: inflammatory adhesion of the border of the lungs at the incisura cardiaca with the parietal pleura. This unchangeably determines the parietal relation of the heart. And yet, often in this condition, just the opposite takes place, as in the previous case; from shrinking, the lung is somewhat drawn away from the heart and thus it is more largely parietal than, according to its size, it would be. Enlargement of the heart may thus be simulated.

Hence in forming an opinion as to the size of the heart from the extent to which it is in contact with the chest-wall we must always bear in mind the possibility of the presence of these conditions (see Percussion; "absolute heart dulness").

INSPECTION AND PALPATION OF THE REGION OF THE HEART.¹

Both these methods of examining the heart, like the foregoing, will be best practised in a moderately high dorsal position. There are technical difficulties in examining a patient either standing or sitting; but sometimes in severe heart diseases the latter cannot be avoided on account of the existence of *orthopnœa* (see pp. 32, 97). Palpation may be performed either with the tips of the first and second fingers, or with the flat, bare hand.

The Apex-beat.

Normal conditions. The apex-beat is of the greatest importance as an anatomical starting-point, for it corresponds either exactly to

¹ The two methods of examination have such close connection with reference to the heart that to separate them would seem to be artificial.

the apex or to a spot very close to it, a little nearer to the median line. In the majority of healthy persons it is recognizable, by the eye, as well as by the finger applied to the spot, as a rhythmical and systolic projection forward about the breadth of the finger, which in the adult in the upright or dorsal position occurs in the fifth intercostal space just within the mammillary line; only exceptionally, chiefly with persons with very short chest, it is found in the fourth intercostal space. In children, up to the age of ten years, it is usually found in the fourth intercostal space and either in the mammillary line or just outside of it (see above in the section on Anatomy). In old age, on the contrary, it is sometimes found in the sixth intercostal space. Much fat, or the mamma, also narrow intercostal spaces, render it invisible, but yet it may generally be felt. Moreover, without a distinct cause, it may sometimes be entirely wanting in healthy persons.

Quiet breathing produces no change in the apex-beat. With deep inspiration, it is covered by the distended lung, which then occupies the complementary space; if it be still evident, it moves sometimes an intercostal space lower down, corresponding to the inspiratory sinking of the diaphragm.

The effect of *change of posture* is very noticeable in the side position: the left-side position moves the apex-beat outward beyond the mammillary line, even as far as the anterior axillary line; the right-side position causes the beat to disappear or moves it somewhat to the right.

Physical exertion and mental excitement, the chief physiological disturbers of the heart's action, may noticeably change the apex-beat in perfectly sound persons, but still more in nervous persons: it may become plainly stronger and even broader, or move somewhat to the left.

There is much dispute as to the *cause of the apex-beat*. It is certain that it is produced by a variety of causes. Briefly stated they are as follows:

1. Change in the form of the heart at the systole: its transverse measurement (antero-posteriorly) increases (Ludwig); the apex moves forward, to the right, and upward (Filehne, Penzoldt).

2. Change in the location of the heart: it revolves upon its long axis, so that the stronger left ventricle moves toward the front.

The assumption that has hitherto been made that the apex-beat is wholly or in part to be explained by the recoil (the so-called Gutbrod-Skoda, better Alderson's, theory), must henceforth be regarded as abandoned, since Martius has proved that, at the time when the apex-stroke takes place, the semilunar valves are not yet closed, and the gush of the blood into the vessels consequently does not begin till the apex-stroke is over.

Displacement (dislocation) of the apex-beat in disease. It may be brought about: (a) by dislocation of the heart, (b) by enlargement of the heart.

(a) *Dislocation of the heart.* The apex-beat is a very important sign for determining this, since the other methods often have a very indefinite result, or may entirely fail.

Deformity of the thorax may cause displacement in all possible directions. It may happen that in a chest that is flattened or pressed-in in the neighborhood of the heart the apex-beat (likewise the heart) will be found considerably outward or considerably inward.

Emphysema of the lungs, in case the apex-beat is not lost by the overlapping, presses it down into the sixth intercostal space (depression of the diaphragm).

In exudative pleuritis and *pneumothorax* the heart and apex-beat are pushed toward the sound side, in the worst cases as far to the left as the middle axillary line, but to the right very rarely beyond the mammillary line. Likewise, the mediastinum and the base of the heart move over, although not so far as the apex. *Mediastinal tumors* may have the same effect as pleuritis of the right side.

In pleurisy of the right side the apex is sometimes pushed not only to the left but also upward into the fourth intercostal space. We are not certain why this is so. It is highly improbable that the left lobe of the liver rises up while the right is dragged down, for the point of traction, the suspensory ligament, brings it still lower by the pressure of the exudation upon the right side. The location of the heart when pressed upon is subject to many disturbances, which we cannot describe at this time.

Shrinking of the lungs and of the side of the chest after a pleuritis draws the mediastinum and the heart into the diseased side, and at the same time draws the diaphragm up; hence in shrinking of the right side the heart moves upward and to the right side, but in disease of the left side it is drawn upward or upward and to the left.

If the heart chances to be drawn to the right so much as to bring it under or close up to the sternum, where the intercostal spaces are very narrow, of course we cannot observe the apex-beat.

In *exudative pleuritis* it sometimes happens that the heart becomes fixed by inflammatory adhesions, and then the apex-beat remains at that point even after the cause of the displacement has been removed.

Elevation of the diaphragm as a result of peritonitis or of simple mechanical pressure from below, or from neurotic paralysis of the diaphragm, causes dislocation of the heart upward or upward and to the left.

(b) *Enlargement of the heart.* *Hypertrophy* and *dilatation* of the *left ventricle* are made manifest by displacement of the apex-beat *outward* or *outward and downward*, and under some circumstances as far as to the posterior axillary line and the eighth intercostal space. The apex-beat is also broader and stronger, see below.

The conditions which bring about hypertrophy and dilatation of the left side have been referred to on page 195. Likewise hypertrophy and dilatation of the right ventricle displace the apex-beat a little toward the left, since the large right ventricle pushes the left somewhat to one side. But the displacement is always quite small, at most not beyond the mammillary line.

Alteration in the Width and Strength of the Apex-beat.

We judge of the breadth both by inspection and palpation. We seldom have an increase in the *breadth* without an increase in the strength as well: in the normal heart, if it becomes parietal over a larger area from shrinking of the lungs; moreover, I have sometimes seen it with deformity of the chest (without hypertrophy of the heart) and where there was marked wasting, so that the patient was very lean.

As a rule, breadth of the apex-beat is associated with a strong beat.

The *strength* of the apex-beat can only be made out by palpation. By constant practice with the hand it can be distinctly recognized. An apex-beat that is so strong that it lifts the finger that is moderately pressing over it is called "heaving."

Temporary, often notably strengthened and moderately broadened impulse is caused by increased heart-work (see above) in consequence

of exertion and mental excitement. For this reason the heart ought always to be examined only when these two conditions can be excluded.

In *nervous palpitation*, *Basedow's disease*, and sometimes in *chronic nicotine-poisoning*, the heart-beat may for a time be very much stronger and even somewhat broader, as an indication of the increased work of the heart, without any organic change in it. The same thing occurs, though in a moderate degree, in *fever*. Moreover, the apex-beat may be stronger at the same time that the heart's work is not increased, if the heart is pressed firmly against the chest-wall, as in mediastinal tumors.

Continued strength and breadth of apex-beat is the most important sign of hypertrophy of the left ventricle. In well-marked cases the beat is "heaving," and is as wide as several fingers—being displaced toward the left and downward (see above).

It is assumed that an enlarged heart works with strength increased in proportion to its increased volume. If the heart becomes weak, then there is a diminution as regards the breadth and strength; and yet it may be distinctly recognized as diseased.

In many cases it is difficult to separate the apex-beat from the "heart-beat" in general, for which see p. 203.

Weakening of the apex-beat. It has been mentioned already that the apex-beat may be weak in persons who are perfectly healthy, or it may be entirely wanting.

Pathologically it is diminished or lost :

By the activity of the heart being concealed by overlapping : from emphysema of the lungs, by a pleuritic or pericardial exudation, and by tumors.

By *œdema, emphysema of the skin*, inflammatory diseases of the chest-wall in the neighborhood of the heart.

By *diminution of the work of the heart*, as takes place with any kind of degeneration of the heart-muscle; here we may mention: myocarditis, lipomatosis cordis, weakness or degeneration of an hypertrophied heart, especially with incompenation with valvular deficiency, weakness in febrile diseases (especially collapse).

The disappearance of an apex-beat which has previously been distinct is sometimes the only sure, and hence is a very important, sign of the development of *exudative pericarditis*. But diminution of the

work of the heart is more distinctly declared at the radial pulse than by the apex-beat; see below for the explanation of the meaning of all these conditions. Moreover, the radial pulse is the only direct measurer of what the heart does in all the above-mentioned cases of concealment of the work of the heart. It is especially important in pericarditis.

Where the apex-beat is covered by fluid in the pericardium it often again becomes distinct when the patient sits up or bends forward, because the heart then, on account of its greater weight, rests against the chest-wall. It is then often found in the sixth intercostal space, because the distended pericardium presses the diaphragm down. This sign, of course, is wanting in cases where the apex-beat is missed from weakness of the heart.

Further, the apex-beat is wanting where there are *pericardial adhesions* (see below under Systolic Retraction), and sometimes in *stenosis of the commencement of the aorta*, and this notwithstanding the existence of hypertrophy of the left ventricle (slow ventricular contraction resulting from difficulty in emptying itself).

So far as experience goes, "*systolic drawing-in*" in the neighborhood of the apex-beat has no diagnostic value. Regarding systolic drawing-in of the whole lower region of the heart, see below.

Doubling of the apex-beat, so that a single pulsation of the carotid corresponds to two beats at the apex, occurs in *hemisystole* (Leyden). By this we have understood an action of the heart in which both ventricles do not contract exactly simultaneously, so that then the contraction of the left ventricle, as well as the right, causes an apex-beat. But it is probable that we here have in these cases simply an alternating action of the heart (see Pulsus Alternans), in which the contraction of the heart is too feeble to produce a perceptible pulse every time.

The application of the graphic method to the apex-beat (cardiography) has thus far yielded no notable contribution to pathology.

The Neighborhood of the Heart in general.

Prominence of the neighborhood of the heart, including the ribs and sternum, takes place gradually in marked hypertrophy and dilatation; when there are hypertrophy and dilatation of both ventricles or of the

right alone the swelling extends sometimes beyond the sternum; in hypertrophy of the left ventricle alone it lies more to the left. *Pericarditis exudativa* sometimes causes a distinct swelling.

This sign depends upon two factors: the size of the heart or of the pericardium, and the flexibility of the chest-wall. If the latter is marked the swelling develops quickly, as in acute pericarditis, and is very marked (enlargement of the heart in children); when the thorax is rigid there may be no projection, though the heart is very large. This condition is not to be confounded with the pressing forward of the heart from mediastinal tumors—aneurism. Generally when there is a *broad heart-beat* in the intercostal spaces in the neighborhood of the heart, and even upon the ribs and sternum, it is from a hypertrophy of the heart. But, also, when there is contraction of the left lung, with the heart free from attachment, the motions of the heart may be seen as well as felt over a broader extent in the intercostal spaces. If, in such cases, the heart's action is excited, there is the impression of a notable hypertrophy of the heart, even when the heart is quite normal in size.

If, in a case where the heart, from dilatation or retraction of the lungs, is more extensively parietal, weakness of the heart occurs, then we not infrequently see a broader waving in the intercostal spaces, which, by its evident lack of energy, is visibly in contrast with its former powerful motions.

It is sometimes very difficult to distinguish a broadened heart-beat from the ordinary apex-beat; but generally it can be distinguished by its having peculiar vigor, more than other heart motions.

Pulsations at the base of the heart sharply limited to the second intercostal space on the right and left side of the sternum come from the aorta or pulmonary artery. They are rarely visible; generally they can only be felt. If they are systolic they may indicate aneurism of these vessels. More frequently we may feel a diastolic shock, but especially upon the left over the pulmonary artery. If the lungs and heart are normal it cannot be felt; but if the lungs are drawn back from the base of the heart (by shrinking, or by enlargement of the heart), or if there is thickening, then it may be felt, especially if it is simultaneously strengthened by hypertrophy of the right ventricle. In emphysema of the lungs there exists the peculiar condition that, although the closure of the pulmonary valve is in a marked degree stronger, yet it cannot be made out because the inflated lung lies over it.

Pulsation in the region about the heart occurs in empyema lying near the heart upon the left side (empyema pulsans); farther in, *aortic aneurism* (which see).

Although systolic drawing-in at the apex of the heart is of no significance (see above), yet systolic drawing-in of several intercostal spaces in the neighborhood of the heart, but especially of the ribs and the lower part of the sternum, is of diagnostic value: it is probable that there is *pericarditis adhesiva* with *mediastinal pericarditis*, accompanied by thickening. But yet these signs may be entirely wanting, although the condition is present: and, on the other hand, they may be observed in cases where this condition does not exist. The drawing-in may be caused by a dense mediastinum being adherent to the spine and again by pericardial adhesion to the chest-wall; its contraction—that is, its constantly becoming shorter—must of necessity cause a drawing-in of the chest-wall.

“*Buzzing*” and friction-sounds that may be felt in the neighborhood of the heart accompany very marked endocardial or pericardial sounds (see under Auscultation).

The Epigastrium.

In inspecting and palpating the heart this must always be considered. *Systolic trembling*, or even *systolic pulsation*, may be observed here if the heart, more particularly the right ventricle, is drawn nearer the abdominal wall by the depression of the diaphragm, but especially is this the case when, *at the same time*, the right ventricle is hypertrophied—emphysema of the lungs.

This epigastric pulsation must not be confounded with that which is to be seen from the abdominal aorta when the abdomen is very empty, and the abdominal wall very thin, whether the aorta pulsates normally strongly or not, or whether there is an aneurism of the abdominal aorta. This pulsation is, moreover, best transmitted when a tumor of the lymphatic glands, of the stomach, or a thin but firm liver, lies over the aorta. Sometimes (not always) the pulse is felt noticeably later than the systole of the heart.

PERCUSSION OF THE HEART.

This has for its object the determination:

1. Of the absolute, “small” *dulness of the heart*, which corre-

sponds with the portion of the heart that is in contact with the chest-wall; and which has an almost definite relation to the size of the heart.

2. The so-called *relative heart-dulness*, which lies above and to the left of the absolute dulness, and which is determined by the thinness of the lungs around its border (see above, page 124). It often stands indirectly in some relation to the size of the heart, but it is not applicable for ascertaining it. It does not even show the exact size of the heart.

To these two, Ebstein has added:

3. *Palpatory percussion of the "heart's resistance,"* which is determined by ascertaining the anatomical size of the heart; regarding this method see below.

METHODS OF PERCUSSION.

Normal Percussion Figure of the Heart.

1. *Absolute heart-dulness.* This is determined by light percussion, and corresponds, in fact, to the portion of the heart that is parietal. In two respects it departs from this, though not essentially; the small strip of the heart which is parietal behind the sternum between its left border and the inner border of the right lung, is not dull as would be expected, but gives a clear sound, as indeed occurs over the whole surface of the sternum (see above, page 123); the lingula, being so small, does not affect percussion; over it we notice absolutely deadened sound. Thus we have the following figure of the absolute heart-dulness in persons in middle life (Fig. 45): the boundary on the right is the left sternal line, the upper boundary lies upon the fourth rib, the left boundary is outside of the left parasternal line. The lower boundary toward the liver cannot be exactly determined, it being defined by the apex-beat, and generally also by the upper border of the sixth rib. In children the area of heart-dulness (absolute) is somewhat greater, the heart being relatively larger, the upper boundary in the third intercostal space; hence the apex-beat is generally in the fourth intercostal space, the left boundary near the mammillary line; in old age, however, it is smaller (from inflation of the lungs), about over the fifth rib, or the parasternal line.

In quiet breathing the dulness does not distinctly change; in *deep inspiration* it is very decidedly diminished, or entirely disappears, because the costal cartilages come close together at the sternum. Compare the course of the boundary of the complementary space (Fig. 44). It makes no difference whether the examination is made in the dorsal or the upright position. Examination upon the side makes considerable alteration of the area of dulness.

FIG. 45.

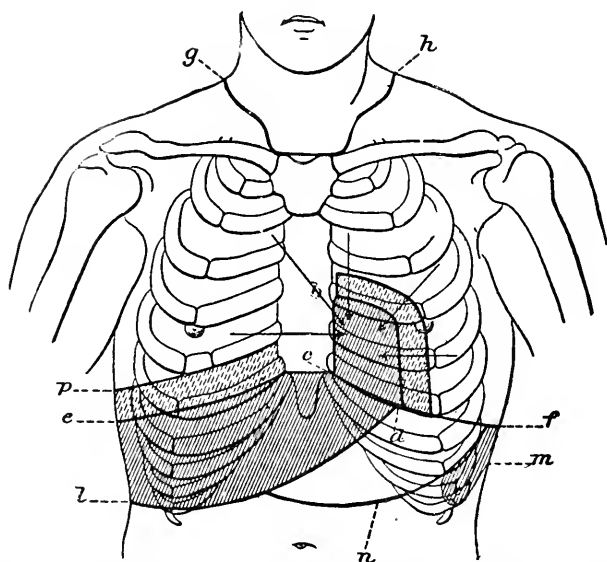

Percussion boundary of the lungs in front (WEIL). *g h*. The upper limits of the lungs; *e f*, the lower limits of the lungs; *b d*, boundary between the lungs and heart at the incisura cardiaca. The strongly hatched surface represents the portions of the heart and liver that are in contact with the wall of the chest; the lighter hatching the so-called relative heart and liver deadness (see later). *m*. Spleen deadness.

The beginner is apt to be much confused, because in a considerable part of the location of heart-dulness, even within the entire region, he will find a tympanic resonance. This is especially frequent in short persons with a short, thick thorax and a full abdomen. The resonance is from the stomach, which lies under the heart, and is more promptly elicited by strong than by weak percussion. When there is an otherwise normal condition of the heart and lungs this phenomenon has no pathological significance.

2. *Relative heart-dulness.* This forms a border around the absolute dulness to the left and above it, and it corresponds with the thinned-out portion of the lungs. It is revealed by stronger, and, in its upper part, by comparative percussion. It no doubt depends, in a certain degree, upon the perceptions of the individual making the examination as to where he will fix the limits between it and those of normal lung sound. Hence, an individual examiner may, if he is accustomed to examine carefully with reference to its determination, be able to fix upon a line of demarcation very satisfactorily for himself, but different examiners would not be able to agree among themselves. Hence, the differences among authors as to the size and diagnostic value of the area of relative heart-dulness.

According to Weil, its course is as follows (see Fig. 45): It begins above at the lower border of the third rib, continues in a curve downward toward the left, within the mammillary line. In rare cases there is also a relative dulness at the right of the absolute dulness, which is limited by the lower end of the sternum. In children the relative dulness begins in the third intercostal space, it extends somewhat beyond the left mammillary line, and is also constantly present on the right, and, indeed, reaches even beyond the right side of the sternum.

Whatever may be the meaning and value which these two regions of dulness may have as subjects for instruction and knowledge for physicians, there is no doubt that at least that of absolute dulness must be considered, since only regarding it is perfect agreement possible, and since the amount of time and trouble which every student and young physician can and must employ in the practice of percussion suffices for learning how to determine it.

It is true, that in pathological cases a difficulty accompanies the determination of absolute dulness; it indicates the parietal state of the heart, but this is dependent, not alone upon the size of the heart, but also upon that of the lungs, though, of course, in an opposite sense. This may make a conclusion regarding the size of the heart from the extent of absolute dulness difficult; however, a person who accustoms himself every time he makes an examination to consider carefully the condition of the lungs when he is determining by percussion the figure of the heart, whether there is emphysema or shrinkage—such a person may very materially diminish this difficulty.

Opinion is divided regarding Ebstein's newer method of determining by direct palpatory percussion *the resistance of the heart* as the true image of the total size of the heart. Indeed, Eichhorst is the only one who warmly espouses the idea. It seems to me that there is no doubt of its use in many cases—that is to say, in those with delicate thorax having thin covering of flesh. At the same time I cannot recommend it as a subject for instruction to others, since it is liable to give rise to many mistakes, and in my opinion it is very difficult to learn.

Riess has recently very strongly entered a plea for relative heart-dulness. He thinks that by a consideration of the relative dulness a figure could be drawn which would very nearly represent the anatomical boundaries of the heart. We think this is going much too far, and that we must maintain the position that we have set forth above.

3. *Method of percussing the heart.* We percuss strongly on both sides close to the sternum going downward, and note the upper boundary of relative heart-dulness; then we percuss lightly the upper boundary of absolute heart-dulness; next we percuss upon the outer ends of radii drawn from the middle of what is thought to be area of absolute dulness (first the one obliquely upward to the right, then from the right, always beginning beyond the sternum; then on the left obliquely upward; lastly, from the left), always strongly at first to determine a possible relative dulness, then lightly for the absolute. At first we percuss at longer intervening spaces, of at least $1\frac{1}{2}$ centimetres, and when a difference of resonance is found then at short intervals of space over the particular region. In Fig. 45 the lines and the directions in which we ought to percuss are designated by arrows.

Enlargement of the Area of Heart-dulness.

Generally, relative and absolute dulness exist in about equal proportions, but, now and then, the relative may be very small. Always in enlargement of the right side of the heart, and sometimes in enlargement of the left side, relative dulness toward the right is increased as compared with the absolute.

Heart-dulness is increased:

1. *In hypertrophy and dilatation of the heart.* If of the right ventricle, the dulness spreads toward the right, sometimes also slightly

toward the left, the whole involving the right half-circle. If the left ventricle is changed, the increased dulness is toward the left and downward, not infrequently also upward, but scarcely any, or at most very little, toward the right. Regarding a small independent dulness which sometimes is found on the right near the upper end of the sternum, see Aorta.

2. *In dilatation of the heart* (weak heart). This causes the previously existing dulness, it may be of a normal heart or of one that was already hypertrophied, to spread out on both sides. (For distinguishing from hypertrophy see "apex-beat" and "radial pulse.")

3. *Fluid in the pericardium* (*pericarditis exudativa and hydro-pericardium*). Generally, this causes the dulness to enlarge at first upward and then to the right and left. Not infrequently the area of dulness has a three-cornered shape—one point above close to the sternum, one on the right on the other side of the sternum below, and one on the left also below on the outer side of the mammillary line; the relative dulness is generally very small. If the exudation is very large, the lung surrounding it is generally retracted, and hence around the dulness there is a border of tympanitic resonance. In sitting, the area of dulness is greater than in lying, and, when bending forward, still greater than in sitting, because there is a change in the extent of that which is parietal.

Regarding the apex-beat in pericarditis, see p. 202; in the latter disease it is often deeper and not on the left border of the dulness, as in enlarged heart, but further toward the right and generally within the mammillary line (a not unimportant point in differential diagnosis). The pulse (which see) is often important.

4. *When the heart is normal, but is to a greater extent parietal*, on account of retraction of the lung. In this case the mobility of the border of the lungs in deep breathing is completely wanting. The apex-beat may be normal, but by simultaneous displacement it is further to the left.

5. *Apparent enlargement of the heart* is noticed if anywhere in its neighborhood there is a diseased condition which causes absolute dulness. Of this kind we may name thickening of the lungs, of the pleura, of the mediastinum, and especially aneurism. It is almost impossible to mark the boundary between the heart and such pathological structures, since we are denied the aid of percussion; on the

other hand, an approximate determination may often be attained during auscultation by the appearances of motion (apex-beat, etc.), and sometimes by the vocal fremitus.

Pulsating affections give especial difficulty, as aneurism and the emphyema pulsans previously mentioned. Here the object is sometimes attained by repeated examinations. For distinguishing emphyema pulsans from aneurism, see the latter.

Diminution or Loss of Heart-dulness.

This takes place :

1. In *emphysema of the lungs*. It affects the parietal condition of the heart, whether it is normal or enlarged. If the heart is normal there is considerable diminution of the area of dulness, even, possibly, to its entire disappearance. If the heart is, at the same time, enlarged (as it has already been mentioned, it generally is in consequence of the emphysema, which causes hypertrophy of the right ventricle), the emphysema makes the dulness smaller than it would be with a heart of the same size and normal lungs. Hence, when there is emphysema we must make some addition to the extent of the dulness we are able to map out before we form a judgment regarding the heart. A normal area of heart-dulness, with the existence of a marked emphysema, indicates considerable hypertrophy of the heart, if there is no adhesion of the borders of the lungs. Hence, we must notice their active movability.

2. In *pneumo-pericardium*, entrance of air into the pericardium, either from without by an external injury or from within by perforation of the œsophagus, stomach, or intestine, we may have the condition of pneumothorax. There is then tympanitic or abnormally loud and deep resonance in the neighborhood of the heart (also, metallic heart-sound). Finally (very rarely) in *emphysema of the mediastinum*. (See p. 57.)

Displacement (dislocation) of the Heart-dulness.

This, of course, arises from displacement of the heart, as is declared by the apex-beat; but in this case, for various reasons, it is generally an imperfect sign of such change. For one thing, it often happens

that the condition which causes the dislocation itself presents dulness, which invades the region of heart-dulness. This is the case when a pleuritic exudation displaces the heart, or when shrinking of the pleura or lungs distorts the heart. Again, it is usually especially difficult to determine the location of the heart by percussion if there exists a vicarious emphysema on the left side simultaneously with considerable shrinking on the right. In this case the heart is sometimes moved over to the middle of the thorax (*mesocardia*).

Still further, the extent to which the heart is parietal is frequently changed by dislocation; thus, when the diaphragm stands very high the heart is pushed upward, usually causing an increased area of dulness, since the heart is then more flat against the chest than is normal.

If there is an *apex-beat* in such cases, it is a very sure sign; often it is necessary to employ auscultation to aid in establishing by the location of the greatest intensity of sound, at least approximatively, the position of the heart.

AUSCULTATION OF THE HEART.

Method and Normal Condition.

Method. Ordinarily we are to auscultate the heart exclusively by the stethoscope. After long practice and experience the examiner may think it advisable to compare what he hears with the stethoscope with the results of direct auscultation; but these are exceptions. The very urgent reason for the use of the stethoscope is that by it we are able to distinguish as sharply as it is possible to do the impressions of sound which come from the different points, so as to be able to refer every sign to its proper place of origin.

First of all, we are to examine the patient when he is in the greatest possible quietude of body and mind; in some cases we may then, after we have begun, find it advantageous to increase the activity of the heart by having the patient make a certain amount of exertion (as by sitting up in bed several times in succession or moving about), since we can thus sometimes obtain certain signs clearer. This will be referred to from time to time. The position of the patient during the examination will, in general, be the same as for percussion, already

referred to. However, we often hear much plainer in the upright position, and hence in doubtful cases auscultation in this position is not to be neglected.

More than anywhere else, in auscultation of the heart it is necessary to examine several times. The rapidity and strength of the heart's action, and possible extraneous sounds, have a great influence upon the distinctness of what is heard. In severe diseases of the heart, especially with heart-failure from different causes which will be mentioned, the impression is generally so confused that no physician of experience will pronounce a definite opinion until, by appropriate treatment, the heart has been restored to a degree of strength.

Normal condition. Over the whole region of the heart, and for a certain distance beyond it, we hear, corresponding with each pulsation of the heart, two "sounds"—one coincides with the ventricular contraction, the "systolic," the "first" sound: one, which is heard at the beginning of the diastole, the "diastolic," the "second" sound. Corresponding with the greater duration of the diastole, the pause between the second and the following first sound is always greater than that between the first and second.

The *rhythm* in general is as represented here :

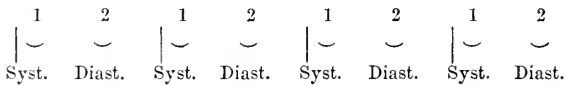

The apex-beat coincides in time with the systolic sound, and likewise, as we can directly observe, with the pulse in the common carotid in the neck. But the pulse of the peripheral arteries occurs noticeably later, so that the radial pulse is felt between the first and second sounds of the heart.

The expression "sounds" is not to be taken in a strictly acoustic sense. In reality it is a short, sharply-defined noise which only approaches a tone. But the term is not so inappropriately selected, as everyone must be impressed who compares these phenomena of sounds with the peculiar heart-sounds to be spoken of hereafter.

These two—the first and second *heart-sounds*—can be heard over the whole region of the heart; but at different points they are of different nature and origin, as is partly declared by the character of their tone. A part of each sound has its origin in each of the four portions of the heart, and hence is in all eightfold:

1. The sudden tension and closure of the mitral and tricuspid valves cause a systolic sound, which naturally is most distinctly heard in the neighborhood of these valves or over the ventricles.

2. The closure of the semilunar aortic and pulmonary valves causes a diastolic flapping tone, heard most distinctly over those valves or in their neighborhood.

3. The sudden contraction of the ventricle causes a dull systolic sound of short duration.

4. The sudden filling of the *conus arteriosus*, aortic and pulmonary, in consequence of the motion of the blood, or, more probably, of the sudden tension of the walls of these vessels, causes a short, somewhat ringing sound.

Thus, we see that the valves have a very essential part in the production of the heart-sound; and since, as has already been remarked in the "preliminary observations" [p. 194], the heart-sounds arising in certain circumstances are *only* connected with the valves or the different openings, these are the chief consideration in auscultation. Hence, we have chiefly to attend to the auscultation of the *mitral valve*, the *mitral orifice*, the *aortic valve*, the *aortic orifice*, etc.

Hence, it follows that we always first listen at those four points of the chest which lie nearest to these valves. But experience has shown that for two of these this is not the best method, as is easily understood from the anatomical relations.

We cannot auscultate the aortic valves at the point of the chest which lies nearest to them, since they are obliquely behind the pulmonary valves, and at that point the sound which comes from the pulmonary artery and its valves predominates; hence, we must auscultate at the beginning of the aorta; and we do not ordinarily hear the sounds of the mitral most distinctly at the point where it is located, since a layer of lung there covers the heart, but better at the apex of the heart. The points of election for auscultating the heart are as follows (compare Fig. 46):

Mitral valve,	} Apex of the heart.
Left auriculo-ventricular opening.	
Tricuspid valve,	} Over the sternum.
Right auriculo-ventricular opening.	
Aortic semilunar (ost. aort.):	2d intercostal space, right of sternum.
Pulm. semilunar (ost. pulm.):	2d intercostal space, left of sternum.

The accompanying figure exhibits the situation of the openings and the points where they may be best auscultated. We see that the auscultation-points of the mitral and aortic valves are so related to the respective openings that they lie downward from them with reference to the normal course of the blood-current.

FIG. 46.

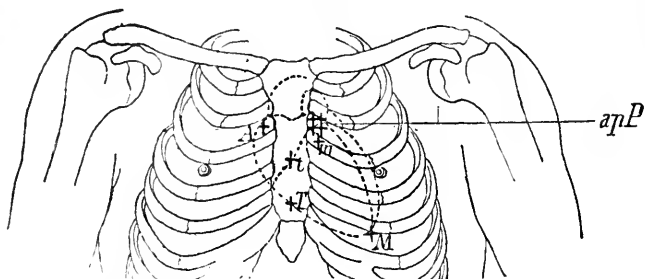

The anatomical situation and the points for auscultating the valves of the heart and its orifices. The small letters show the location of the valves; the large ones the points for auscultating. *aA* = the aorta; *mM* = mitral valve; *pP* = the pulmonary orifice; *tT* = tricuspid.

The "sounds" that can be heard in health at the four points mentioned correspond with the occurrence of the sounds just referred to in the following way:

Apex of the heart (*mitral orifice*):

1st sound: Closure of the mitral valves and ventricular contraction.

2d sound: Prolonged aortic second sound (closure of aortic valve).

Under the sternum (*tricuspid orifice*):

1st sound: Closure of the tricuspid valves and ventricular contraction.

2d sound: Prolonged pulmonary second sound.

Second intercostal space right or left (*aorta, pulmonary art.*):

1st sound: sudden filling of the beginning of the aorta, of the pulmonary artery, and continuation of the first ventricular sound.

2d sound: closure of the semilunar valves of the aorta, or of the pulmonary artery.

Thus the first sound is a mixed one, composed of muscle, valve, or also of vessel-sound; it is dull and somewhat prolonged. The second

sound is throughout wholly from the semilunar valves; it is short, flapping. Hence I represent the first by a dash, the second by a short curved line. The heart's action is hence represented in the following way:

FIG. 47.

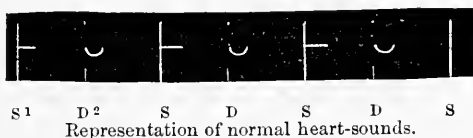

and since we hear the second sound over the ventricle only as conducted from above against the current of blood, over the ventricle it is very light, hence the accent at the apex and [over the sternum, *i. e.,*] under the sternum is represented as follows:

FIG. 48.



In auscultating, however, at the mouth of the arteries we hear the second sound at the place of its origin; it is here louder, and indeed louder than the first, and hence the accent is *at the base of the heart*:

FIG. 49

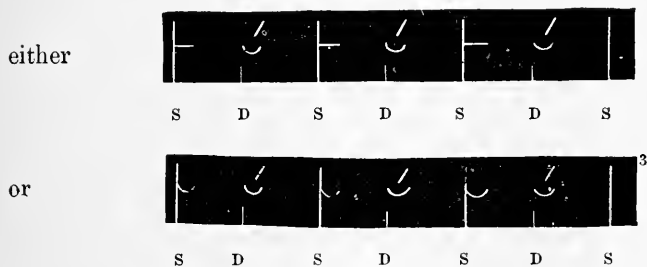

according as the first sound is like the ventricular tone or not.

¹ S = systole.

² D = diastole.

³ This representation departs from the habit of authors, who draw the comparison with the trochaic and iambic foot, and this does violence to the length of the sounds, merely for the sake of making the comparison. I maintain that the above representation is more in accordance with the facts.

Differences of variations within normal limits. The absolute strength of the heart-sounds varies very much in persons in health. It depends upon the elasticity and delicacy of the thorax: children and persons with delicate thorax generally have loud heart-sounds; with the former (children), they are widely conducted by the lungs, and this for the same reason that with them the breathing-sound is sharper (see). Further, the thickness of the covering of the chest has its effect: large mammæ, thick layer of fat, weaken the sounds. Temporary excitement of the heart may increase the sounds so very much that even an experienced person may be tempted to suppose that they are increased by pathological conditions.

The tone of the heart-sounds also varies: with many the first sound as well as the second is more "tone-like," with others less so. Especially variable are the first sounds: sometimes shorter, sometimes longer, noise-like, "impure"; further, sometimes very deep and not clear, "dull."

The first sound of the heart (much more rarely the second) may even in health be doubled:

FIG. 50.

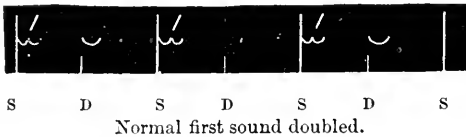

This is generally only at the end of expiration and the beginning of inspiration, probably disturbed by the ventricles not contracting synchronously (see also under Pathological Doubling).

Regarding the measurement of the heart-sounds see page 217.

Pathological Changes in the Heart-sounds.

General strengthening of the sounds indicates increased activity of the heart: this may occur, as above indicated regarding healthy persons, but to a still higher degree, from temporary excitement in nervous disease of the heart, and also in Basedow's disease; it is also

a frequent accompaniment of fever—this without the heart being hypertrophied. But also, it corresponds with the increased work of the heart in *hypertrophy*, especially of the left ventricle; and we meet a strength and hence often a flapping character of sound not infrequent in *anæmia*, and especially in *chlorosis*.

Strengthened heart-sounds are, as a matter of course, heard over a larger area beyond the heart than normal. They may be heard over the whole thorax. However, such more *extended perception* of heart-sounds may be due to condensation of the lungs (pneumonia, chronic contracting phthisis).

It is difficult to measure exactly the strength of the sounds of the heart. Recently a very ingenious method has been proposed by H. Vierordt. Its significance will be greatly affected by the changing dulling effect of the chest-wall and its covering, also of the lungs. It is interesting to note that normally the mitral first sound is the loudest and the aortic first sound the softest. Dull sounds, which by the usual mode of auscultation the ear is accustomed to consider light, by this method sometimes manifest themselves as louder, like flapping, thus apparently more intense.

Strengthening of separate sounds. Strengthening of a second sound (more emphatic closure of the semilunar valves), if persistent, is a very sure sign of hypertrophy of the corresponding ventricle. Only we must not consider a slight emphasis of the aortic or pulmonary second sound as a pathological strengthening. (Regarding the conditions which lead to hypertrophy of the ventricle see the Preliminary Remarks.) Abnormally strong, *accentuated pulmonary second sound* is thus a very important *sign of hypertrophy of the right ventricle*, and it is the more important since in this condition percussion is often doubtful. *Strengthened aortic second sound*, especially in sclerosis of the aorta, becomes slightly sonorous, ringing. In hypertrophy of the left ventricle from insufficiency of the aortic valves accentuation is wanting, because in the main the second sound is wanting, since the valves do not close.

This accentuation of the second sound immediately disappears when the heart becomes weak, when heart failure takes place. The disappearance of the accentuation of the pulmonary second sound is therefore of especial diagnostic value, since we have no other direct sign of

commencing failure of the right ventricle. If there occurs a *relative tricuspid insufficiency* from a high degree of weakness and dilatation of the right ventricle (see Preliminary Remarks), then the pulmonary second sound almost entirely fails, since the blood now has an outlet upon both sides, backward through the ostium venosum, and forward into the pulmonary artery, and thus the pulmonary pressure falls off very greatly.

In a case of disease of the heart the importance of the second pulmonary sound cannot be too strongly impressed upon the beginner in making his observations; it is a measure of the activity of the right ventricle, as the pulse is of the work of the left (see Pulse).

Not infrequently *both pulmonary sounds* (much less frequently *both aortic sounds*) are *strengthened* because the base of the heart is in contact with the chest-wall, when there is shrinking of the lungs. An accented pulmonary second sound from hypertrophy of the right ventricle may be *felt* thus as a diastolic stroke in the left second intercostal space. The author once found, in a case of mitral insufficiency with hypertrophy of the left ventricle with shrinking of the lung, an aortic second sound that could be *felt* in the right second intercostal space.

Pathological strengthening and flapping character of the *first sound at the apex* are so frequently occurrences in *mitral stenosis* that to the experienced observer they have diagnostic value. The phenomenon is ordinarily explained as being a consequence of diminished filling of the left ventricle which follows from the lessened size of the orifice by which it is filled, the segments of the mitral valve at the end of the diastole are still very lax, and so come together with more energy at the beginning of the systole. This explanation does not appear to us to be wholly acceptable.

Weakness of all the sounds of the heart (more inclined to concern the second sounds) occurs in *all cases of weak heart*, as takes place in hearts previously sound in consequence of over-exertion, severe hemorrhages, carbonic acid poisoning, or any kind of interference with breathing (see), any other kind of poison, as heart poison, in acute febrile diseases: finally, in central or peripheral paralysis of the vagus, as follows disease of the heart-muscle, or as generally at last from some cause or other overtakes an hypertrophied heart.

Hypertrophy of one division of the heart is, as referred to in the

Preliminary Remarks, generally "*compensatory*"—that is, it is said to accompany any obstruction of the circulation. If a hypertrophic heart can no longer meet the demands made upon it, we then use the term "*incompensation*." Then heart-sounds that in part were previously strengthened at first become about normal, and then become weaker than normal.

Moreover, when *an emphysematous lung forms a layer over the heart*, the heart-sounds are found to be persistently weakened, even to marked indistinctness, and this involves, also, the pulmonary second sound, which, in emphysema, is strengthened. This weakening occurs with large *pericardial exudations* or *hydro-pericardium*; more rarely from a *tumor* or *pleural exudation* pressing against the heart.

Weakening of individual sounds. If there is an "organic heart murmur" (see p. 221), then the sound with which it occurs, or at which it ceases, becomes either weakened or indistinct, or it is entirely wanting, so that the "murmur" takes the place of the sound. But also with certain valvular defects there occurs weakening of other sounds, such as of the *aortic second sound in mitral stenosis*, in consequence of which the left ventricle has only a little blood to throw into the aorta (see Preliminary Remarks); weakening of the same *aortic second sound in stenosis of the aorta*, as the *pulmonary second sound in stenosis of the pulmonary artery*, as a consequence of those valves being less free in their action. Not without diagnostic value, also, is a high degree of weakening (even to complete disappearance) of the *first sound at the apex in aortic insufficiency*. This is explained by the reflux from the aorta, with the normal afflux from the auricle, filling the ventricle abnormally full; it becomes dilated, and thus the tips of the mitral valves, even before the beginning of the systole, are somewhat pushed up. When the systole takes place, there is then only a moderate increase in its tension. Moreover, in aortic insufficiency, over the aorta the first sound is often weak and very impure, without other contemporaneous signs of aortic stenosis being present. (See Heart Murmurs, and Pulse.)

Divided or double heart-sounds. These ordinarily are without significance if the condition otherwise is one of health (see p. 217). They occur also in pathological conditions, and are then of diagnostic meaning. We bring together here (Fig. 51) the cases in which, instead of

two heart-sounds we hear three, without sharply separating between "divided" and "doubled" sounds.

Division of the second sound at the apex occurs in mitral stenosis. It may conceal a diastolic sound, which, with the patient in the up-

FIG. 51.

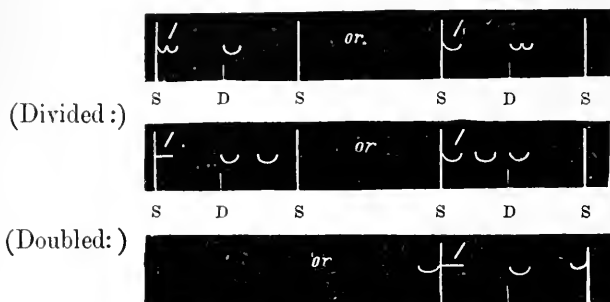

Different kinds of division and doubling of the heart sounds.

right position and heart excited, sometimes can only be distinctly heard by placing the stethoscope at the outer left end of the apex-beat. We may especially refer a divided second sound at the apex, according to my experience, to mitral stenosis, in case there are, besides, undoubted signs of *mitral insufficiency*.

Further, a *divided second sound* is heard in *pericarditis adhesiva* and systolic retraction of the apex-beat. (Friedreich's explanation of the phenomenon may be doubted.)

Finally, here belongs the *gallop rhythm*, sometimes present:

FIG. 52.

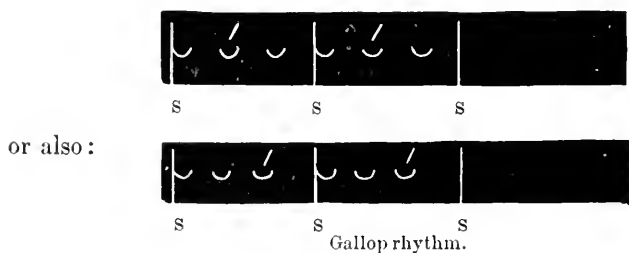

that is, three similar short ringing sounds, of which either the second or third has an accent, but in many cases neither has an accent.

This gallop rhythm may, but quite exceptionally, be observed in health with excited action (I have seen two cases). It is also observed in emphysema, contracted kidney, arterial sclerosis, heart disease with slight incompensation. But it generally indicates severe, often fatal heart-failure, and especially in infectious diseases. It is particularly frequent in children; it may here, for example, in *diphtheria*, be the first sign of beginning paralysis of the heart, even before the pulse becomes markedly quickened. In my opinion the gallop rhythm may be explained in the same way as the divided sound, the ventricles not contracting at the same time. This question will be variously answered by different authors.

Metallic heart-sounds. They come from the resonance of a large smooth-walled layer of air close over the heart, as is the case in *pneumo-pericardium*, not infrequently in *pneumothorax*, and in individual cases of large *cavity in the lung* with smooth walls which lies close to the heart. *Intestinal or peritoneal meteorism* (see both of these), or a very much *inflated stomach*, may sometimes cause metallic heart-sounds.

In *pneumo-pericardium*, also in cases of inflation of stomach with gas, if the action of the heart is very strong or excited, the sounds may be so loud that the first, or even the first and second, can be heard at a distance.

Organic Endocardial Heart-murmurs.

By *endocardial heart-murmurs*, as the name implies, we understand murmurs arising within the heart in distinction from those arising in the pericardium. Endocardial murmurs are again distinguished as organic and inorganic, according as they are dependent upon anatomical changes or not. We now consider the former.

Organic heart-murmurs will be caused by stenosis of the openings or by imperfect closure of the valves or insufficiency, both the ordinary and the relative insufficiency of the valves (see Preliminary Remarks, paragraph 2). They furnish us with an important means of recognizing the so-called valvular defects.

If fluid is flowing through a tube which suddenly at a certain point is contracted, from this stenosis eddies in the current will arise below that point, and these eddies will cause murmurs. If the fluid flows

very rapidly the eddies and their sounds are increased. Normally the blood passes through the openings of the heart without sound, since there is no notable narrowing of the course of the blood; but if an *opening is narrowed*, then eddies and sounds are produced, and so much the more markedly if there is compensation, when the blood from the section of the heart lying behind the narrowed opening is driven with much greater rapidity than normal through the narrowed opening (see Preliminary Remarks).

Such a murmur will be heard at the moment when normally the blood passes through that opening—that is, at the systole, if an arterial opening is narrowed, at the diastole if a venous opening is affected (auriculo-ventricular).

But murmurs are produced by insufficiency of the valves, which are to be explained in the following way: The effect of insufficiency is such that the blood, which, in the preceding stage of the heart's action, passes through the affected opening, in the following stage, in which the valves of that opening would have closed, partly flows back; it likewise flows against the blood normally flowing into the cavity and rebounds with it: thus eddies arise and also a murmur. The intensity of this murmur depends, in the first place, upon the degree of insufficiency, and, again, very materially varies with the strength of the heart's action: for the greater this is the more marked is the difference in pressure and the more violent the backward current which it causes.

Likewise, there occurs the *murmur of insufficiency* in that stage of the heart's action in which the affected valves ought normally to close—that is, at the arterial openings with the diastole, and at the venous openings with the systole.

Moreover, it appears to me to be unquestionable that, in the great majority of cases of insufficiency, the murmur is increased by the simultaneous occurrence of a murmur from stenosis; for the reflux current of blood certainly flows through a narrowed opening if the insufficiency is not greater than it usually is. I also think that, in connection with this, in cases of severe aortic insufficiency (N. B., with full compensation), we find the diastolic murmur especially soft. (See further regarding this the following, upon the influences that affect the loudness and character of the heart-murmurs.)

Loudness of the endocardial murmurs. From what has already been said it is evident that the loudness of the murmur is not alone dependent upon the severity of the valvular lesion. It is also a very great mistake to draw a conclusion about the degree of the stenosis or insufficiency from the loudness of the murmur; regarding this, the effects of the valvular lesions upon the heart and circulation, especially the pulse (which see), are much more determinative.

Murmurs are very much affected by the strength of the action of the heart: they are plainly louder when the heart is excited, and hence when they are indistinct, if the patient is able to do so and is not harmed by it, he can first move about or can sit up and lie down again several times in bed before we auscultate him. On the contrary, a murmur previously distinct becomes, without exception, more feeble if the strength of the heart declines. In very marked weakness of heart the murmur may even become entirely imperceptible, hence, in disease of the heart, the murmurs entirely disappear if an unfavorable turn takes place; also, they disappear in cases of heart disease where the patient is overtaken with a severe febrile disease (see above). Hence, an exact diagnosis of disease of the heart, if the heart is weak, is always uncertain, and often impossible, whenever the action of the heart is accelerated. (See Relation of Heart-murmurs to the Time of Action of the Heart, p. 224.) Hard (calcareous) or rough valves have the effect of *strengthening* or *sharpening the murmurs* of stenosis, or, perhaps, also of insufficiency; also, in individual cases, the murmur may be changed by the relaxation or rupture of the tendinous cords of the valves (see Character of the Murmurs). In other respects the strength of the murmurs is dependent upon the same influences as affect the heart-sounds (which see).

In rare cases the heart-murmur is so marked that it may be heard *at a distance*, without laying the ear over the chest. Such murmurs may sometimes be perceived by the patient. Only those arising at the aortic orifice have this peculiarity.

Localization of the murmurs. The next diagnostic point of importance is that we can determine, from the location in the region of the heart where a murmur can be heard most distinctly or where it is loudest, whence it arises—that is, at which opening the valves are diseased. The auscultation-points already mentioned serve here as points of departure. We listen—

At the apex of the heart—that is to say, at the point of the apex-beat—for the mitral valve, the left venous opening.

Over the lower part of the sternum—for the tricuspid valve, the right venous opening.

In the right second intercostal space, close to the sternum—for the [aortic] opening and the auricular semilunar valves.

In the left second intercostal space, close to the sternum—for the opening [of the pulmonary artery] and the pulmonary semilunar valves.

But it is to be noticed that the murmur caused by aortic insufficiency is, as a rule, not heard in the right second intercostal space, but is most distinct over the sternum, sometimes even in the left third intercostal space at the left of the sternum; since it is caused by the backward flow of the blood, it is conducted in the direction of the ventricle. Analogously, but only exceptionally, the murmur of insufficiency of the mitral valves may be noticed most markedly, not at the apex, but on the left of the base of the heart—that is, in case the dilated left auricle, with its appendage, lies somewhat forward (Naunyn).

The murmur of stenosis of the left auriculo-ventricular opening is often distinctly heard close to the outer edge of the apex-beat.

Relation of the heart-murmurs to the time of action of the heart. It follows from the above discussion that the organic heart-murmurs are very closely connected with certain instants of the action of the heart, and, further, that they are divided into systolic and diastolic. And thus we hear in—

Stenosis of the aorta: A systolic murmur in the right second intercostal space.

FIG. 53.

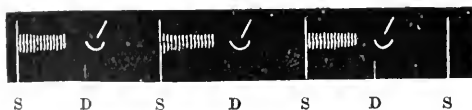

Aortic insufficiency: A diastolic murmur at the same place, or, better, lower down to the left of this, over the sternum.

FIG. 54.

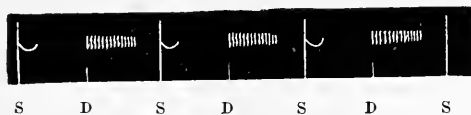

Mitral stenosis: A diastolic murmur at the apex, the first sound being accentuated; or approximately so, if the second sound is heard at all. (See more exactly below).

FIG. 55.

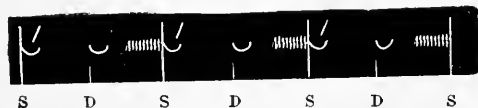

Mitral insufficiency: A systolic murmur at the apex of the heart.

FIG. 56.

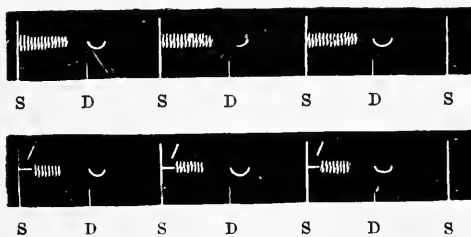

or:

Quite analogously, in *pulmonary stenosis* and *tricuspid insufficiency*, we hear a systolic murmur, in *pulmonary insufficiency* and *tricuspid stenosis*, a diastolic murmur at the corresponding points (see above). Of these valvular defects of the right side of the heart the only one frequently present is *tricuspid insufficiency*, and this is relatively much more frequent (in great weakness of the heart) than insufficiency caused by endocarditis. Pulmonary insufficiency and stenosis are almost always congenital, and then are very often associated with a permanently open foramen ovale (regarding which see later).

Systolic murmurs in stenosis of the aorta and insufficiency of the mitral valve, and the diastolic murmur from aortic insufficiency generally are directly joined with the sound affected by them; but

these sounds are thus always weakened, or the sound completely disappears and the murmur takes its place. In such cases the sound may still be heard if we remove the ear a short distance from the ear-plate of the stethoscope. Probably the weakened sound is not to be referred to the valve that is affected, but is conducted so as to be heard elsewhere.

On the other hand, a peculiar condition commonly belongs to the *diastolic murmur of mitral stenosis*; it occurs at the end of the diastole as a so-called *presystolic* murmur, or, in case it is present at the beginning of the diastole, it becomes stronger toward the end; hence, either:

FIG. 57.



or:



The explanation of this remarkable phenomenon is very simple: toward the end of the diastole the auricle contracts and drives the blood with greater rapidity through the narrow ostium venosum; hence, the strengthening of the eddy and murmur.

In most cases a little practice enables one to recognize in what period of the action of the heart an endocardial murmur belongs. But if there remains the slightest doubt whether a murmur is systolic or diastolic, then the examiner must observe the action of the heart by palpating at the same time he is auscultating, and this is best done by applying a finger to the common carotid in the neck; here the pulse is almost simultaneous with the ventricular systole, and hence demonstrates the time of its occurrence.

We cannot employ the radial pulse, because it is felt too long after the systole. When the action of the heart is very irregular, and still more when it is very much accelerated, it is very difficult, or it may be entirely impossible, to distinguish between systole and diastole.

Murmurs differ very much in character: murmurs of insufficiency are, as a rule, softer, blowing, and, indeed, the murmur of *aortic insufficiency* manifests itself often by its length and remarkable delicacy (it may easily be overlooked), while that of *mitral insufficiency* usually is louder, but not quite so long. Of the murmurs of *stenosis*, that of the aorta is generally loud, "sawing"; *mitral stenosis*, on the other hand, is almost always very soft, peculiarly rolling or "flowing," or seeming to consist of several very soft sounds. This murmur is sometimes imperceptible, even with strong action of the heart.

Under some circumstances aortic or mitral murmurs of insufficiency may be musical—that is, they contain a sound which approaches a distinct, always very high musical tone. In such cases there have frequently been found at the autopsy the suspected causes of this phenomenon in that the semilunar valve has been found to be perforated, also torn floating shreds of valves, sinewy threads in the lumen of the ventricle, floating torn shreds of papillary muscle, etc. These conditions generally furnish no indication as to the particular heart-lesion; it is, therefore, of no value to recognize them during life. In many cases, moreover, of which two came under my own observation, it happens that at the autopsy nothing is found to explain the occurrence of the musical murmurs during life.

Metallic murmurs occur under the same conditions as metallic heart-sounds (see): in general, if there is a resonant air-space near to the heart.

Murmurs that may be felt: endocardial whizzing, "frémissement cataire," cat's purring. This occurs generally, but by no means always, with murmurs that are distinguished by their loudness. Locally, their most distinct perception by touch always corresponds with the locations where they are heard most distinctly. We palpate with the hand or finger-tips and recognize thus, though only in rare cases, a fine whizzing, which is most like what we feel when we stroke the back of a purring cat.

In this way, by the aid of palpation, we may prove the existence at the apex of systolic and diastolic, or presystolic mitral murmurs, and in the right second intercostal space of systolic and diastolic aortic murmurs. Defects of the right heart seldom produce murmurs that can be felt. The palpation of endocardial murmurs has so

subordinate a value that we can never permit ourselves to dispense with auscultation, which yields so much sharper and clearer results.

Transmission of heart-murmurs. It is understood that an endocardial murmur is very often not confined to that spot on the thorax where it is auscultated, but will be heard at some distance away from it. The conduction takes place especially in the direction of the blood-current. Thus an aortic systolic murmur is often heard even over the carotid in the neck. On the other hand, the diastolic aortic murmurs generally are perceived over the sternum, even louder than in the right second intercostal space; but they are also often to be heard as far down as the apex. Systolic blowing in mitral insufficiency is sometimes conducted toward the right as well as further upward. On the other hand, diastolic [presystolic] murmur from mitral stenosis is always sharply confined to the left border of the heart. An *inorganic systolic pulmonary murmur* which can be heard some distance downward from the base of the heart very often disturbs or deceives us.

Combination of several murmurs. This results from the *combination of several valvular defects*. It more frequently happens that insufficiency of a valve is connected with stenosis of the opening to which that valve belongs. Then we hear at a particular spot a murmur with each of the two stages of the heart's action. It is more difficult to interpret what is heard when the disease affects different openings or valves, and especially if there are two murmurs both of which occur with the systole (mitral insufficiency and aortic stenosis), or both in the diastole (mitral stenosis and aortic insufficiency). Then, it may happen that only one valve is supposed to be diseased and that the second murmur which is heard is transmitted from the first. But also a mistake in the opposite direction may be possible, namely, that we assume that there is a combination of two valvular affections when in fact there is only one, as when a murmur of aortic insufficiency which is heard at the apex is considered as a new, independent murmur produced by mitral stenosis. The differentiation by auscultation is made in two ways: 1. By the *character of the murmur*. If one is blowing and the other is rough there certainly are two murmurs; if both are alike then there may be only one, which is conveyed from the opening where it arises to a second opening. Yet it might be that even in this case there were two murmurs, with different origin.

2. We auscultate step by step from the point where we can hear one to where the other exists, as from the apex to the aorta. If the murmur is everywhere distinct, only that toward one spot it gradually becomes louder, then it arises at this point and is conveyed to another. But if it is lost somewhere on the way from the apex to the aorta and is again heard at the aorta, then there are two murmurs.

This procedure may answer the purpose, but it often fails, and in such difficult cases auscultation alone cannot decide, but we must take a view of the whole picture of the heart and vessels in order to reach a diagnosis. This will be treated of further on.

Finally, murmurs that arise in the neighborhood of the heart may be mistaken for heart-murmurs. Those that come from the trachea and bronchi can easily be excluded by having the patient, if necessary, hold the breath. But it is more difficult to discriminate between heart-murmurs and those that have their origin in the aorta (especially aneurism), regarding which see below.

Inorganic, Anæmic Murmurs. (Synonyms: accidental, blood murmurs.)

These are so designated because they occur in all forms of *anæmia*, both light and severe, but especially in *chlorosis*, in all *wasting diseases*, and also in *febrile diseases*, without there being any disease at all of the heart or vessels. They serve as a sign of anæmia; they generally entirely disappear with the removal of this condition.

In very pronounced cases there are very *soft, systolic, blowing murmurs* which are heard over the pulmonary artery or lower down with indefinite location, or they may even be heard over the apex. But not very infrequently such an inorganic murmur is also sharp, even very loud; on the other hand, it is very seldom diastolic; also we may almost say that it never is heard over the aorta. Thus the other signs of valvular disease are wanting, especially hypertrophy of a ventricle, while the pulse gives evidence of anæmia, and there are murmurs in certain vessels, especially the veins of the neck.

Sometimes there is at the same time considerable dilatation of the heart, as takes place in anæmia (which see); on the other hand, we have those marked dilatations which give rise to murmurs from

relative valvular insufficiency and which may also exist in severe conditions, with which we are not at present concerned.

It is very difficult to explain anæmic heart-murmurs. Nothing of what has already been said regarding murmurs seems to us to be applicable here: we think with others that the nature of the phenomena differs in different cases, and in many cases we may apply Sahli's supposition that venous murmurs from the large veins in the thorax lie behind these heart-murmurs.

For distinguishing them from the organic heart-murmurs it is in the first place necessary to call to mind what has been mentioned as characteristic of anæmic murmurs, and then to observe whether there are other signs of anæmia present. Further, a valvular defect is to be excluded by the most careful examination of the heart and pulse. It is true that in many cases the phenomena are such that we can only obtain a clear idea by long observation, especially remarking whether treatment of the anæmia removes the murmur. It is very difficult to decide that a diastolic murmur is due to anæmia.

The author recalls having seen two cases of pronounced pernicious anæmia complicated with mitral endocarditis and mitral insufficiency, in both of which the differential diagnosis between anæmic murmurs and the valvular disease mentioned could not be positively established during life. In both there existed simultaneously considerable emphysema which concealed the slight hypertrophy of the left and right ventricles.

Pericardial Murmurs. [Friction-sounds.]

The name explains the situation of these murmurs. Their nature is the same as pleuritic friction-sounds; they are caused by the friction of the visceral and parietal pericardium made by the action of the heart when their opposing surfaces rub against one another; they do this when the surfaces are rough, exceptionally even if they are simply unusually dry.

We have near to the ear a ringing, short scratching, scraping, shuffling, more rarely a creaking sound, one which with a little practice is generally easily correctly recognized by its acoustic character. It is generally very sharply defined as to location, and is most frequently heard at the base of the heart, but often farther down at the left of the sternum.

Of greater importance is the relation of the friction-sound to the action of the heart: it occurs, not in close conjunction with the sounds, but between them, either only during the systole, or more frequently in both stages, but generally louder with the first sound:

FIG. 58.

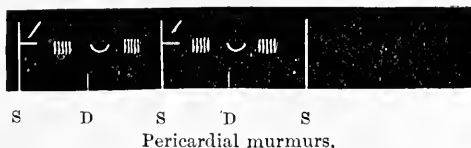

More rarely, tolerably closely before and after the second sound:

FIG. 59.

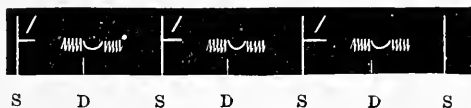

Or covering the first sound:

FIG. 60.

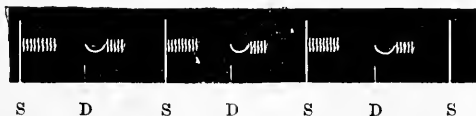

The rubbing of marked pericardial friction-sounds can be felt by applying the hand to the spot. Several special peculiarities of these friction-sounds will be mentioned when we treat of differential diagnosis.

Pericardial friction-sounds occur:

In *Pericarditis*, when the surfaces of the pericardium, where the fibrinous exudation exists, rub against each other without becoming adherent. Hence, we hear friction-sounds in *pericarditis sicca* so long as it is not adhesive, and in *pericarditis exudativa*, if there is fibrinous exudation without enough fluid completely to separate the surfaces of the pericardium. This is why the friction-sound is generally heard at the base of the heart or near to it; it is not infrequently heard

there as the first sign, and then often disappears as the exudation increases, and it may again return when the exudation diminishes. The *disappearance* of a previously existing pericardial friction-sound may depend upon one of four causes: 1. The complete decline of a pericarditis, without any sequelæ. 2. By the addition of a fluid exudation. 3. By adhesion of the pericardial surfaces. 4. From great weakness of the heart. It is necessary to ascertain in every case which of these four causes is operating. If there is no evidence of the second or the fourth, then the first and third must be considered; and between these it is possible to make a differential diagnosis only in very rare cases.

They also occur in rare cases of *tuberculosis of the pericardium* (which usually results in adhesion), quite exceptionally with fragments of fibrinous cords and calcifications in the pericardium, and in *abnormal dryness of the pericardium*, as in cholera.

The differential diagnosis between pericardial and endocardial murmurs is generally very easy for those who are accustomed to hear both sounds, frequently by the character of the pericardial sounds and the circumstance that they sound so near the ear. Musical persons generally also immediately recognize the difference in time (see above). But the following may enable us to distinguish between them:

(a) Very much the most important is the consideration of the whole picture of the disease (form of the dulness, apex-beat, sounds, pulse, etc.).

(b) *Change of position.* The pericardial sound almost always changes, and much more than the endocardial, with change of position.

(c) Strong pressure with the stethoscope. If we press exactly at the right spot, especially if it be in an intercostal space, sometimes the pressure very strikingly increases a pericardial sound, but never an endocardial one. But in the majority of cases, even of the former, the sounds are not increased by pressure; hence, it is merely confirmatory when it exists, but failure to notice it has no meaning.

(d) Pericardial sounds often change their location, strength, and character in a few hours; they may even very quickly disappear and very suddenly return (see above). Endocardial murmurs are markedly chronic and regular. Very exceptionally they come and disappear

suddenly, if they are organic, and only in exceptional cases when due to heart weakness.

Extra-pericardial friction-sounds. The friction-sounds which are heard close to the heart, and even over it, and which resemble them in sound, may be very easily confounded with the pericardial sounds. This extra-pericardial sound is, in the great majority of cases, a *pleuritic friction-sound* which is caused by the contact of the pleura with the heart, especially at the lingula, and which by the mechanical effect of the action of the heart results in thrusts which correspond with the movements of the heart. It is distinguished from pericardial friction-sound in that it is greatly influenced by the breathing: it is often heard only with deep inspiration, or, on the contrary, during very superficial breathing. In individual cases we hear it as pleuritic friction with strong breathing, while with quiet breathing it has the time of pericardial friction-sound.

There occurs, also, a peritoneal friction with peritonitis involving the lower surface of the diaphragm (subphrenic peritonitis), and quite exceptionally over the liver. This sound is transmitted by the motion of the heart upon the diaphragm as a pseudo-pericardial sound (Emminghaus).

The differential diagnosis of these sounds from pericarditis will depend upon the other signs of a pleurisy or peritonitis, and with reference to pleuro-pericardial friction the effect of the breathing is to be considered. Hence, the differential diagnosis may here be very difficult, because sometimes a pleurisy close to the heart may by contiguity awaken a pericarditis.

Fine crepitations, like those in emphysema of the skin (see p. 55), occur in the neighborhood of the heart, synchronous with the action of the heart, in mediastinal emphysema.

Metallic pericardial splashing results from fluid and air in the pericardium (pyo-pneumocardium), exactly as we have succussion-sound with hydro-pneumothorax, only that the succussion is caused by the heart itself. Moreover, after the analogy of extra-pericardial friction-sound, a pseudo-pericardial—in fact, pleuritic—splashing, simultaneous with the motions of the heart, occurs with hydro-pneumothorax, where the motions of the heart are communicated to the fluid. This happens exceptionally, too, with large cavities close to the heart or when the stomach is filled with fluid and air. But these are merely curiosities.

Exploratory puncture of the heart is only to be undertaken with reference to the performance of puncture, and hence belongs under therapeutics.

EXAMINATION OF THE ARTERIES.

Usually we select the *radial pulse*, which, because of its importance, requires a separate and complete consideration. Then we can add to this the description of the characters of the other arteries.

I. THE PULSE, ITS PALPATION AND GRAPHIC REPRESENTATION.

From the commencement of medical study the radial artery has been examined where it passes between the styloid process of the radius and the tendons of the long flexors of the hand and fingers. The examination of the pulse is not a simple thing. It requires practice, and hence it is the more important, in order to be able to recognize the differences and peculiarities of different cases, always to take the pulse at the same artery; but it is easy to understand that the radial artery is preferable because of its location, and hence it has been selected.

Palpation of the Pulse.

The arm being held in an unconstrained position, we palpate the radial by making slight pressure upon it with the tips of the first and second fingers. Generally the impression is threefold: we learn the *condition of the artery itself*, the general state of its *fulness with blood*, and its *pulsatory dilatation and contraction*. This latter constitutes the pulse in its narrow sense.

We study the pulse with reference to its *frequency*, its *rhythm* (whether the succession of beats is regular or not), and its *quality*. First we consider the normal pulse; then the pathological departures from it with reference to these three points of view.

1. *The Normal Pulse.*

Its *frequency* varies with the *period of life*, being highest in the newly born—about 140 beats in the minute. It becomes constantly less up to the twentieth year, when in the adult male or female it is,

on the average 70 to 75, and again somewhat rises with age up to about 80 beats. *Sex* makes a slight difference, the female average being a few beats more than the male at the same age. Moreover, the *size of the body* has some influence; the average of large persons is somewhat less than that of smaller persons, *cæteris paribus*.

The *daily variations* in the frequency of the pulse correspond with those of the bodily temperature; the maximum is generally between noon and evening, the minimum in the early morning; the difference is generally less than ten, seldom more than twenty beats. Of about the same value is the variation of the pulse with reference to the *position of the body*: its frequency is highest in standing, less while sitting, and least while lying down. It varies also with the *external temperature*, in case the latter changes considerably from the average: the lower the temperature the higher the pulse.

Meals, especially of food that is rich, and of hot dishes and drinks, quicken the pulse for one or two hours. *Sleep* has no essential effect, though the pulse rises, and generally considerably for a short time at the moment of waking, even when this is without noticeable excitement (see below).

Movement of the body always increases the frequency, under some circumstances even till the frequency is doubled. Active *deep breathing* increases it. *Mental excitement* of any kind, as fright, anxiety, joy, joyful or painful tension likewise quickens the pulse, but very differently in amount in different individuals according to their general excitability.

All the above-mentioned influences manifest themselves with very marked variations according to the bodily constitution and the character of the nervous system [temperament]. Pale, delicate persons, who are also excitable, show the greatest increase in frequency. During convalescence merely rising in bed, a little food, joyful or sad news considerably quickens the pulse. In disease this is still more the case, of which see below.

Method of observing the pulse: After excluding the temporary influences that have been mentioned, we count by the second-hand of the watch for twenty seconds; where greater exactness is required for a half or full minute. Sometimes in hospitals the nurses employ small sand-glasses; of course, their accuracy must be carefully tested. [In England and America these glasses are not used.] Sometimes in

sickness the pulse is so frequent that it cannot be counted. It has been recommended, under these circumstances, to try to count every other beat, and then to double the result. In case the radial pulse cannot be felt, or if we suspect that some beats drop out (see under Intermittent Pulse), we can then count while we auscultate the heart.

In connection with the employment of temperature-charts we have become accustomed to note upon the chart, every time the temperature is taken, also the frequency of the pulse and respiration; thus we obtain upon the fever-chart a continuous line representing the pulse, which materially aids in forming a judgment of it. (Regarding the value of this continued observation of the pulse, see below.)

The *rhythm* of the pulse in perfect mental quiet and during quiet breathing is in health regular. But mental excitement easily makes the pulse somewhat irregular, especially in nervous persons. Again, the rhythm of the pulse is changed with many persons during deep breathing, especially, too, in nervous persons. Usually at the end of expiration and the beginning of inspiration it is quicker, while at the height of inspiration and the beginning of expiration it is slower.

Normally the pulse at the two radials is exactly simultaneous, the crural pulse is also approximatively simultaneous with the radial. But if we compare the radial with the action of the heart we notice that it is always notably later than the corresponding systole.

Regarding the *quality* of the pulse: the radial in health has a certain general fulness and hardness, and the separate pulse-waves also have a certain size, hardness, and form. All these peculiarities exhibit not inconsiderable variations within the normal. Correct estimate of them by palpation is a matter of much careful practice. (For particulars regarding the different forms of pulse which we meet, see below.) Here it is next to be remarked that in the normal pulse *equality of its separate beats* is desirable (*equal pulse*); only quite small, scarcely perceptible inequality sometimes occurs, again especially with nervous persons. A general symmetrical increase in the hardness of the pulse and enlargement of its waves are results of physical exertion, mental excitement, etc.; in short, from anything that temporarily quickens the action of the heart.

2. *Pathological Frequency of the Pulse.*

We distinguish a *pulsus rarus* (slow, infrequent pulse) and a *frequent pulse* (accelerated pulse).

The *slow pulse* occurs:

1. In individual cases of pathological increase of the work of the heart, namely, in *acute nephritis*, especially the *nephritis of scarlet fever*. Hypertrophy of the left ventricle is often included here. But the diminished frequency of the pulse is very slight.

2. In the opposite condition of diminished pressure in the arterial system in consequence of *hemorrhage*; and in individual cases of febrile diseases with fatal collapse.

3. In *disease of the heart-muscle*, especially in *fatty heart*, but also in *fibroid myocarditis* (but here we must be on our guard not to confound it with intermittent pulse, which see); 48 to 36 beats are here not at all infrequently met with. The lowest number pretended to have been observed is 8.

4. In *old age*, without any disease of the heart (this is very exceptional, but yet it sometimes occurs, as I have been able in one case to confirm by autopsy that there was no disease), and in *marked inanition* (from stenosis of œsophagus, pylorus, etc.). Here, also, the slowing of the pulse may be considerable—even to 48 or less.

5. Sometimes with *stenosis ostii aortæ*; here the difference is very slight—about 60 beats.

6. In *disease of the brain* or *of the meninges*, which results in irritation of the vagus centre. This may really be only mechanical, from increased intracranial pressure (*tumors, hemorrhages, hydrocephalus*), or from inflammatory irritation (*acute meningitis*, especially basilar). The slowing is considerable.

7. In the *critical decline of fever* in acute febrile diseases, possibly from the effect of certain products of the fever upon the heart or the vagus centre, an effect which is only manifest when the quickening effect of the high temperature (which see) upon the pulse is past. It is a considerable, but quite temporary slowing.

8. In *hepatogenic icterus*, from the effect upon the heart of the gall-acids circulating in the blood. The pulse is diminished quite frequently as low as to 48, sometimes still lower.

9. In individual cases, with acute articular rheumatism.

It has been recently stated that slowness of the pulse ("brachycardia") in many of these cases is accompanied with characteristic maladies (attacks of fainting, a feeling of oppression of breathing, apoplectiform attacks). It has also been observed as a seemingly independent condition without any sign whatever of an anatomical disease, hence as a "neurosis" (Grob). We have never seen any cases of this kind.

Frequent pulse occurs:

1. *In fever*, as its chief manifestation. We recognize a general relation between the elevation of the temperature and quickening of

FIG. 61.

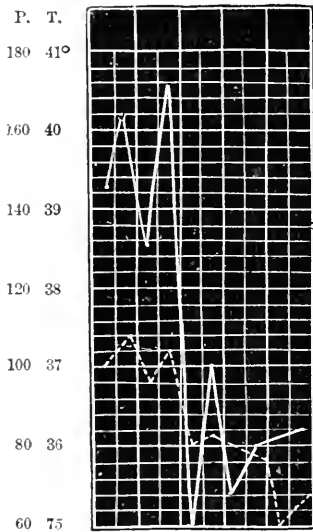

Diminution of frequency of pulse after critical fall of temperature in pneumonia. The unbroken line represents the temperature-curve, the broken one the pulse-curve.

FIG. 62.

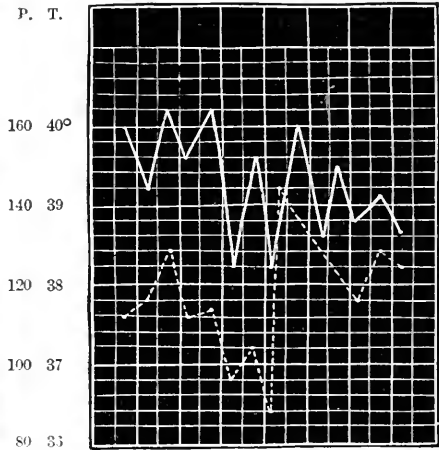

Abdominal typhus in the third to the fourth week. The rise in the pulse corresponds with the beginning of pneumonia.

the pulse—to every degree of heat above 37° the pulse increases 8 beats above the normal (Liebermeister); but there are very great variations from this proportion, according to the kind of febrile disease, its localization in particular organs, and, further, with the age of the patient, the strength of the heart. Thus, in *abdominal typhus*, so long as it is not complicated, there is only a moderate quickening of

the pulse; hence, in this disease, a pulse of 120 has a graver meaning than, for example, it has in *pneumonia*. This moderate quickening of the pulse, peculiar to typhus abdominalis, is even an aid in diagnosis in severe cases, as distinguishing it from *acute miliary tuberculosis* and *pyæmia*. It has already been mentioned that in *meningitis* there is slowing of the pulse; when meningitis is added to a febrile disease it may lower the pulse, previously quickened, to the normal, or may even bring it below the normal. On the other hand, during an *abdominal typhus*, the addition of a complicating *pneumonia* will, under some circumstances, be first noticed by the increased frequency of the pulse. (See Fig. 62.)

FIG. 63.

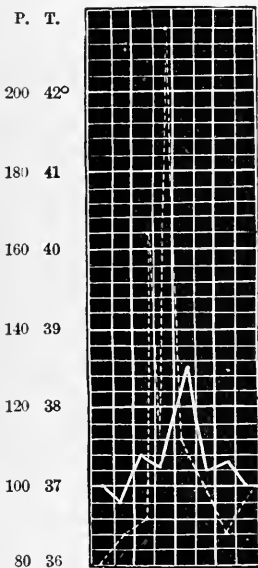

Very rapid action of the heart (mitral insufficiency).

FIG. 64.

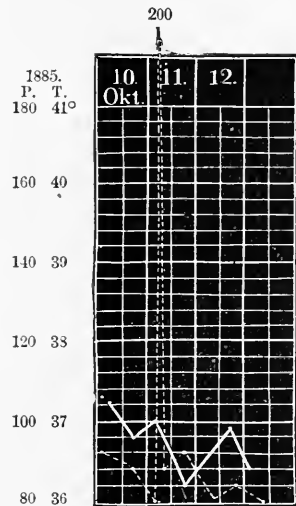

Very rapid action of the heart (convalescence from typhus; suspicion of mitral insufficiency).

Febrile diseases with *complicating heart disease* usually have a quicker pulse than the same diseases when the heart is normal. With children the pulse is always very much higher in febrile diseases than with adults.

In the course of febrile diseases the constant observation of the

frequency of the pulse is of the greatest importance for estimating the strength of the heart, and with it the general vigor, or showing the occurrence of complications, etc. (See further, hereafter.) It is also to be observed that in fever the frequency of the pulse is immediately increased by the least exertion or by excitement.

In general it is an unfavorable sign when adults have a pulse of over 120, and the case requires special consideration. But when it reaches 140 it is a grave symptom.

2. In *valvular disease of the heart*, except only in stenosis of the aorta (see above), and also even with complete compensation. Attacks of great frequency of the pulse—180 and over—are infrequent occurrences, which chiefly accompany mitral defects (*palpitation of the heart*).

FIG. 65.

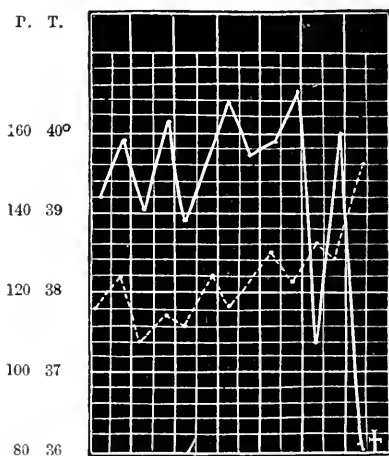

Increased frequency of the pulse in fatal collapse (erysipelas).

3. In *heart-failure or paralysis*. Thus, in the collapse of febrile diseases (see Fig 65), where there is a simultaneous fall of the temperature and rise of the pulse; in the arrested compensation of heart disease, and in weakening of the heart in consequence of disease of the substance of the heart; finally, with central and peripheral paralysis of the vagus.

4. In *certain neuroses*: Basedow's disease, nervous palpitation, angina pectoris (without the nature of this phenomenon being clear).

5. In any condition of *anxiety*, and with *severe pain*.

3. *Want of Rhythm of the Pulse.*

Instead of the normal equal succession of the beats there may be complete irregularity (*arhythm*); in the most marked degree this is so in *mitral stenosis* (even when there is perfect compensation). Moderate or marked arhythm is very frequent in *myocarditis* (sometimes the inequality of the pulse is here *the only sign*). It occurs during the stage of incompensation in all cases of heart-defect, and sometimes in all forms of marked heart-weakness. Moreover, the inequality of the pulse [irregularity of volume] is more important in judging of the weakness of the heart than arhythm.

If, in such arhythm, there are individual pauses in which no pulse is felt, then we speak of "suspended" pulse, which may be *pulsus deficiens*—that is, the pauses indicate real pauses in the action of the heart; or it may be a *pulsus intermittens*: they result from weak contractions of the heart, which cannot be felt as far as the radial. We determine, in a given case, which of the two kinds of pulse it is by auscultating the heart.

But there are other forms of irregularity of pulse in which the irregularity of the beats follows a rule: *pulsus bigeminus*, *p. trigeminus* (where two or three beats are regular and then follows a longer pause). These forms generally indicate moderate weakness of the heart.

Lastly, we must mention an especially frequent form of irregularity which stands somewhat between the two last-named forms and complete irregularity—the *pulsus intercідens*: after several perfectly regular beats, suddenly there is one that follows immediately after the last regular one (which is also always weaker), then there generally follows a slight pause. Most frequently it indicates considerable weakness of heart, and is often the forerunner of severe heart-weakness. It occurs in valvular disease and myocarditis.

In order to determine the succession of pulse-beats it is sometimes useful to employ the graphic method (which see).

4. *Quality of the Pulse.*

As has been already mentioned above, a correct judgment of the size and tension of the radial artery and of the size and form of the

individual waves can only be attained by much practice. It is indispensably necessary that there should be acuteness of feeling in the examining finger, much experience of what is normal and what is pathological, and of the boundaries between the two, which cannot be sharply defined in words.

The inequality of the examination must be taken into consideration, as it is affected by somewhat individual differences of the location of the arteries, the difference in the subcutaneous fat, or as affected by arterial sclerosis. The exact examination of the pulse may not be possible on account of the abnormal course of the radial artery—the most frequent variation being where the artery winds around the radius to its dorsal surface above the styloid process.

We distinguish the different forms of pulse according to the following points of view :

1. According to the *size of the pulse*: full or empty pulse, *pulsus plenus—vacuus*; a not very clear method of designation. It would be much more suitable to describe the average fulness of the artery, or, still better, its thickness at the moment of its systole—that is, in the depression between two pulse-waves. In this sense the pulse is full in almost all those cases in which it is large in so far as it depends upon work of the heart, which is strong or increased. But it further depends, to a certain extent, upon the amount of blood in the system; a certain fulness of the pulse, which, in a strong person, is not remarkable, in an anæmic subject indicates a pathological increase in the work of the heart. Within certain limits, moreover, the difference in the fulness of the pulse is individual, being simply dependent upon the internal diameter of the arteries. We are not to confound a full pulse with a case where there is thickening of the wall of the artery by arterial sclerosis.

Larger and small pulse: *pulsus magnus—parvus*. When the *work* of the heart is simply increased, and still more when there is *hypertrophy of the left ventricle*, the pulse is large. There is an exception to this when we have the two valvular defects, in which the left ventricle, notwithstanding its hypertrophy, is able to force only a moderate quantity of blood into the aorta (aortic stenosis, see under *pulsus tardus*), and mitral insufficiency. The reason for the former is clear; the explanation of the latter is, that with every systole a part of the blood contained in the left ventricle flows back into the left auricle.

Absence of pulse depends upon diminished work of the heart, upon an obstruction between the heart and the aortic system (aortic stenosis, aneurism), and upon marked anæmia. It is present in the highest degree in *mitral stenosis*, since in this condition the left ventricle contains an abnormally small quantity of blood, and hence it can drive but little into the aorta.

If the pulse is very small, and at the same time very empty, it is called thread-like or filiform. The trembling pulse (*pulsus tremulus*) is caused by a moderately full artery, in which the wave is imperceptibly small. Both are noticed when the heart is very weak.

Regular and irregular pulse [as to volume]: *pulsus æqualis—inequalis*. As was previously stated, there occur in health insignificant irregularities in the individual pulse-waves. A very marked inequality is a most important sign of *weak heart*, more important than the irregularity which almost always accompanies it. Only in *mitral stenosis* we have a very markedly unequal (and irregular) pulse without the heart being really weak.

Often, too, there exists in a measure a condition between inequality and irregularity as follows: A pulse follows the previous one with a shorter pause, then after a longer pause there is one with a stronger beat. Especially in *pulsus intercidens* (see p. 241) the between-beat that immediately follows a pulse-wave is always small.

Pulsus alternans is so called when a larger wave alternates with a smaller one. At the same time it is generally bigeminus. (See above.)

We call a pulse *pulsus paradoxus* which has the peculiarity that in deep breathing, toward the end of inspiration, it becomes weaker, or is once or more times omitted. It is an important sign of *pericarditis adhesiva* with fibroid mediastino-pericarditis, and it arises from the bending or traction of large arterial branches as the thorax is broadened in the act of inspiration and the diaphragm is pressed down.

2. We distinguish the form of the pulse-wave as quick or slow, *pulsus celer—tardus*. Here also belongs the *pulsus dicrotus*.

In the *quick pulse* the artery quickly enlarges and immediately becomes narrow with a like quick contraction. But with a *slow pulse* the enlargement and contraction are slower than normal, and the artery also lingers in the diastole during a portion of time which a trained

finger may recognize. With the quick pulse the examiner notices that the stroke is very short, while in the latter it is more a pressure in the vessel against the palpating finger.

Every *pulsus magnus* may exhibit a moderate celerity. Only in *aortic insufficiency* is the pulse decidedly quick. It is a miniature picture of the large fluctuations of pressure in the aorta which quickly follow one another, as with every systole it receives from the dilated and hypertrophied left ventricle an abnormally large quantity of blood which it immediately disposes of in two directions—sending part back again into the ventricle, and part forward into the body.

It is remarkable that also in heart-weakness there is sometimes a light, quick pulse. It is true that it is always very easy to compress it, and between the pulse-waves the walls of the artery fall together very decidedly (*pulsus vacuus*, and at the same time *celer*).

Pulsus tardus is an especial peculiarity of *aortic stenosis*, and at the same time it is generally smaller than normal. How much it may be diminished in size depends upon the degree of stenosis and the strength of the heart. *Pulsus tardus* occurs also with *arterial sclerosis*, likewise with *lead colic*, but also sometimes with other colics as well as in *peritonitis*.

Pulsus dicrotus will be more exactly described with the sphygmography of the pulse (see p. 248).

3. According to the *hardness of the pulse* (tension of the arterial wall) we distinguish hard or tense, and soft pulse, *pulsus durus* (*tensus*)—*mollis*. Here we must especially guard against confounding it with arterial sclerosis, which imparts to the wall of the vessel a hardness which has nothing to do with its tension.

We test the hardness of the pulse by endeavoring to compress it with the finger; it is easy to compress a soft pulse.

Again, it is really the power of the heart that produces these peculiarities, as well as the active tension of the wall of the vessel. In heart-weakness the small pulse is also always a soft pulse; the large pulse is likewise often hard. With *pulsus tardus* there is almost always a strong action of the heart, and if the heart is hypertrophied the pulse at the same time is often hard. When the pulse is quick there are constantly marked variations in its hardness.

The hardness of the pulse is especially characteristic in *contracted kidney* with hypertrophy of the heart, also in *lead colic* (“wire pulse”).

The pulse is tense also in *apoplexy cerebri* and in commencing *meningitis*, no doubt from irritation of the vasomotor centre.

V. Basch has constructed a sphygmomanometer, which is very useful for measuring exactly the tension in the arterial wall, and thus the blood-pressure. Unfortunately, we cannot affirm that the absolute height of the blood-pressure in its finer gradations leads to results that have diagnostic value. The reason of this is that, as v. Basch himself found, the limits of the normal are very wide apart; moreover, from the fact that the arterial pressure is the result of two forces acting in opposition, the contraction of the heart and the active contraction of the vessel. Lastly, as has already been intimated, the anatomical peculiarity of the arteries (arterial sclerosis) has an influence upon the hardness—that is, the compressibility of the pulse. Yet, after all, we think that v. Basch's instrument is very excellent for determining the variations of the blood-pressure in the course of making observations upon a patient.

5. *Symmetry of the Radial Pulse.*

As has been already mentioned, apart from anatomical variations of the artery upon one side, the pulse upon the two sides is perfectly alike as to time and quality. It may be disturbed, even to complete absence of the pulse upon one side.

1. By *surgical diseases of the arm*, as fracture of the bone, injuries or operations which displace the radial, or which result in narrowing, compression, or cicatricial contraction of the radial, brachial, or axillary artery; in which case the pulse upon that side is found to be smaller.

2. By tumors of the chest cavity, of the supra- or infra-clavicular fossa, or of the axilla, which press upon the innominate, subclavian, or axillary artery of one side. They weaken the radial pulse even to complete obliteration.

3. By *aneurism of the aorta, innominate* (in what way, see below), also by aneurism of the subclavian, axillary, and brachial (all very rare; see works upon surgery).

4. By *emboli and autochthonous clots* toward the centre from the location of the pulse. In this case the pulse is commonly entirely wanting.

5. In *pneumothorax, also large pleuritic exudation* with com-

pression and distortion of the subclavian. Sometimes the pulse upon the affected side is smaller, also frequently later.

SPHYGMOGRAPHY OF THE RADIAL PULSE.—K. Vierordt originated the idea of sphygmography. With continued improvements of the apparatus the idea has been further developed by *Marey*, *Wolff*, *Landois*, *Sommerbrodt*, *Riegel* [and others].

Sommerbrodt's sphygmograph is the one now most generally used, but it has defects. Recently Ludwig has very decidedly improved upon Marey's instrument, as it seems to me. It can be obtained from Petzold, instrument-maker, in Leipzig. [The instrument devised by Dr. Richardson, of London, is, in the opinion of the Translator, the most practically useful one yet brought out.]

The sphygmograph has little value for the purposes of diagnosis, but is of great value in clinical instruction.

In health the pulse-curve obtained with this instrument shows elevations and depressions, ascending and descending line corresponding with the expansion and collapse of the artery. The expressions "apex curve" (c g) and "curve at the base" (b) do not need further explanation. At both these points the curve stops only a very small portion of time.

The ascension line (a l) is even almost perpendicular; that is, the rise follows very quickly. The descent (d) is more drawn out and shows several small waves, which generally (not always) may be distinguished as a marked elevation (r), the backward-stroke elevation, caused by a wave of blood which results from the closure of the semilunar valve, and two (sometimes also three) or only one weaker, elevation produced by elasticity (e); the elastic secondary oscillation of the wall of the artery (according to *Landois*, but otherwise explained by others).

The elevation (r), the "recoil," has hitherto been regarded as a positive centrifugal wave due to the closure of the aortic valves. But recent investigations have shown that this positive wave is centripetal, and that it is probably to be regarded as a reflected wave from the peripheral end of the circulation of the body, as from the end of a closed tube (v. Frey and Krehl). The opinion formerly expressed that r was more marked the nearer we were to the heart, by the new theory would be explained by saying that it was the summation of the reflected waves arising from the various arterial regions.

It is worthy of notice with regard to the backward-stroke elevation that it increases with the diminution of the tension of the artery. Thus it is a sort of indication of the blood-pressure. But the elevation produced by elasticity is just the opposite. It is to be remarked

FIG. 66.



Normal pulse-curve in a healthy man, aged twenty-five years. (After EICHHORST.)

regarding the sphygmography of other arteries that *r* becomes more marked the nearer we go to the heart.

The following are the *essential pathological forms* of sphygmographic pulse-waves :

1. A descending line with several very marked elasticity elevations, but smaller backward-stroke elevations (often difficult to make out) which correspond with the increased tension in the aortic system (*lead colic, contracted kidney and acute nephritis, etc.*).

FIG. 67.



2. On the other hand, diminution of the elasticity elevation with more marked backward-stroke elevation shows diminished blood-pressure. Such increase of *r* is called "dicrotic," and the pulse "dicrotic pulse." Such a pulse, even if it is only moderately pronounced, can be recognized by palpation. It occurs in certain conditions which accompany a moderate diminution of strength of the heart, but especially a diminution of the tone of the arteries :

a. In *acute febrile diseases*, and indeed in so marked a degree and so early in *typhus abdominalis* that in diagnosis we may attach some, though small, value to this symptom.

b. In *chronic wasting diseases*, especially febrile, more than others in *tuberculosis*. Here, according to my observation, it is not infrequent.

c. In other weak conditions, as after great loss of blood, and in general in all forms of anæmia.

FIG. 68.

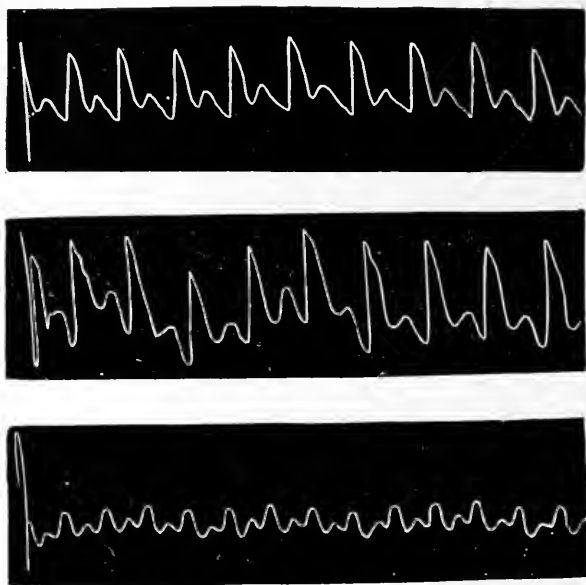

Different forms of dicrotic pulse. (After EICHHORST.)

The above curves show that in the dicrotic pulse the backward-stroke elevation may fall in the descending line (*sub-dicrotic pulse*), as well as in the middle of the basis curve (*complete dicrotic pulse*), likewise in the ascending line of the next following wave (*super-dicrotic pulse*). The so-called *monocrotic pulse* (no visible backward-stroke elevation) is a sort of super-dicrotic pulse.

What has been said in general regarding dicrotic pulse expresses the diagnostic value of all these forms of pulse.

3. To the *pulsus celer* corresponds a curve with a very steep ascending line and an unnaturally high apex-curve (in consequence of the quickness of the arterial diastole the recording lever of the apparatus is always thrown too high up). Moreover, the apex-curve is

sharp-pointed, and the descending line is almost as steep as the ascending line. The elasticity elevations are marked. With *pulsus celer* due to *aortic insufficiency* there is, of course, no backward-stroke elevation, as the semilunar valve does not close. Compare what has been said on p. 243 upon *Pulsus celer*.

FIG. 69.

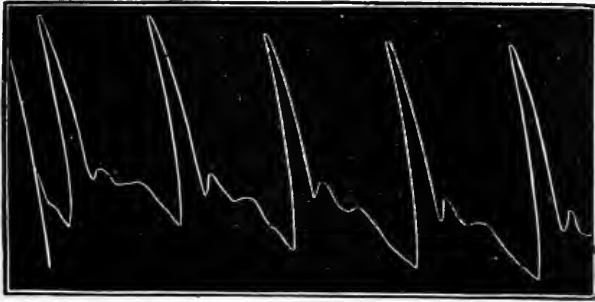

Pulse-curve in aortic insufficiency. (After STRUEMPELL.)

4. *Pulsus tardus*, as in palpation (see p. 244) so in the curve, is the exact opposite of the preceding. With it there are usually more complete loss of the elasticity elevation and indistinct backward-stroke elevation.

FIG. 70.



Pulse-curve in stenosis of the aortic orifice. (Ibid.)

FIG. 71.



Pulsus tardus in atheroma of the arteries. (After EICHHORST.)

A peculiar combination of *pulsus celer* and *tardus* manifests itself with insufficiency and stenosis of the aorta.

FIG. 72.



Pulse with anacrotic elevation in aortic insufficiency with moderate stenosis of the orifice and arterial sclerosis.

In *pulsus tardus* the quickness of the apparatus is completely wanting on account of the slowness of the ascension, hence it always seems small in comparison with the normal pulse-wave; and with that of *pulsus celer* (see above) still smaller than is really the case.

It is quite impossible to form an estimate of the size of the pulse from the sphygmographic curve. The unequal pulse will generally be very beautifully delineated by the apparatus, but it cannot be more exactly depicted than it can be learned by exact palpation. It is true that the apparatus includes small waves that the finger cannot recognize, but often these cannot be distinguished from the elevations indicating the backward stroke.

FIG. 73.



Pulse-curve with marked mitral stenosis. (After STRUEPPELL.)

The *rhythm* of the pulse will, of course, even if only for a very short distance, be very well exhibited, and it is in this direction that the graphic delineation is very useful in giving instruction. But here sphygmography is wholly wanting for diagnostic purposes, since every notable useful irregularity can be felt just as well.

Annexed is an example of *pulsus bigeminus* (after Riegel).

FIG. 74.



Pulsus bigeminus. (After RIEGEL.)

DIAGNOSTIC VALUE OF THE EXAMINATION OF THE PULSE.—From what has been said it is sufficiently evident that for the purposes of diagnosis palpation of the radial pulse is preferable to sphygmography. The latter is more circumstantial, and gives, at best, to one sufficiently practised in palpation in general, no better result than that it occasionally shows a dicrotic pulse which the sense of touch does not detect. It very easily even deceives, especially regarding the size of the pulse, but sometimes also its form, from reasons that lie in the apparatus. The great value of the sphygmograph for the clinician consists almost exclusively in its usefulness in giving instruction, for exhibiting a characteristic anomaly of the pulse to a large number of hearers, or it may serve to show a pupil what he ought to feel.

In what follows will be briefly indicated in which direction the examination of the pulse is of value for diagnosis, and how it can be turned to account.

1. The pulse very often directly serves to determine the diagnosis; not that it alone is sufficient, but in connection with other phenomena it is. We are to bear in mind here what has previously been said regarding the behavior of the pulse in the various febrile diseases. But in diseases of the heart it especially has such an important place that a diagnosis is never to be made without taking into consideration the condition of the pulse.

In what follows is brought together what can be said regarding the behavior of the pulse in the most important of the diseases of the heart.

In *mitral insufficiency* the pulse does not markedly or notably vary from the normal. But in addition the signs of hypertrophy of the right and left ventricles are present: systolic murmur at the apex.

Mitral stenosis: Pulse absent, unequal, or irregular, its frequency often much increased. (In addition, signs of hypertrophy of the right ventricle and a presystolic murmur at the apex.)

Aortic insufficiency: Pulse quick, frequency either normal or increased; generally equal and regular. In addition there are the signs of hypertrophy of the left ventricle and a diastolic blowing murmur at the aorta. (For the conditions at certain arteries, etc., see p. 256.)

Stenosis of the aorta: Pulse small, slow, normal or diminished frequency, equal and regular. In addition, signs of hypertrophy of the left ventricle; only the apex-beat is often very strong and a systolic murmur heard over the aorta.

Myocarditis: Pulse more or less small and soft, almost always irregular in quality, and generally so in time (here especially we have sometimes *pulsus incidens*, *bigeminus*). Frequency is increased, normal, or diminished. Nothing abnormal at the heart, or signs of dilatation of one or both ventricles (or of hypertrophy); no murmurs.

Pericarditis exudativa: Pulse strong if the heart remains so, generally somewhat quickened. In addition, at the heart all signs of its activity diminished or removed by being covered over, marked dulness; in paralysis of the heart no pulse, or very much quickened; sometimes *pulsus paradoxus*.

We are particularly to notice the opposite condition of the pulse in aortic insufficiency and stenosis, and also that in myocarditis the pulse may be the only sign.

In *combined valvular disease* the pulse is of importance in two ways: it betrays the existence of a second valvular disease besides the one already made out, as is especially the case in mitral insufficiency and stenosis. The latter near the former may be overlooked because very slight, or may even be entirely wanting, and because it produces hypertrophy of the right ventricle, which is also produced by the former, for there may be a very small, unequal, irregular pulse, which alone indicates the stenosis. Also, an aortic stenosis, besides insufficiency of the aorta, is sometimes certainly discovered only by the pulse, since there may be a weak systolic murmur at the aorta without stenosis. Thus the question as to which cardiac orifice is concerned in the murmur, or whether we have one murmur widely conducted, or two murmurs independent of each other, may be determined by the pulse.

Moreover, in a patient with combined valvular disease the pulse may very greatly assist in determining which disease is the more marked or important. This is especially true in insufficiency and stenosis of the aorta (the distinctness of the murmurs is, of course, not at all indicative, see above), also of the mitral, or for combined disease of the aortic and mitral valves.

Thus we would diagnosticate a preponderating insufficiency and a

very slight stenosis of the aorta when we have the signs of hypertrophy of the left ventricle, a loud sawing systolic and a very slight diastolic aortic murmur and a pronounced *pulsus celer*. Thus, with the signs of aortic insufficiency and mitral stenosis, a very small pulse points to the preponderance of the latter.

It is impossible to make a diagnosis of the particular heart-lesion, either from the general symptoms or from the pulse, so long as there is continued evidence of incompenation.

Moreover, in the cases where the heart and its action are concealed, especially in pericarditis exudativa, also in emphysema, sometimes in marked deformity of the thorax, displacement of the heart, tumors of the chest-wall, the pulse is the only sure sign of what work the left ventricle is doing. In pericarditis the contrariety that exists between a diminishing apex-beat, the slight, almost imperceptible, heart-sound, and a strong pulse, is sometimes a very important diagnostic point.

2. The pulse enables us to judge of the strength of the heart in all other possible, especially febrile, diseases. Even the first examination of the pulse furnishes, in this case, important information; but the signification of indications furnished by repeated examinations of the pulse (palpation and representation of its varying frequency upon the temperature-chart) becomes very much more valuable. These indications furnish still more important diagnostic points, some of which have already been spoken of. They have reference to the beginning of complications in acute infectious diseases, especially those affecting the heart, the lungs (which are very frequent), the kidneys, as in scarlet fever, when the pulse has greater tension and diminished frequency, and to the brain (decline in frequency in meningitis); also, the effect of treatment, as of cold baths, may be determined partly by the behavior of the pulse; in general, it often determines the treatment; further, we are to mention all diseases which in any way affect the heart, as pleuritis, pericarditis, peritonitis, in which the pulse, especially as a measure of treatment, has any part.

II. OTHER PHENOMENA IN ARTERIES.

THE AORTA.—Sometimes a pulsation is to be seen and felt in the neck; exceptionally, also, in health (higher location of the arch); likewise, in *hypertrophy of the left ventricle* (most marked in *aortic*

insufficiency, since this causes a broadening of the commencement of the aorta); and, finally, in *aneurism of the arch of the aorta*.

The occurrence of pulsation that can be seen and felt in the right second intercostal space is always pathological. It occurs in *hypertrophy of the left ventricle*, and also especially in *insufficiency of the aorta*; further, in *aneurism of the aorta*, see below. In rare cases, when there is marked hypertrophy, the second aortic sound may be felt (of course, this can never occur in aortic insufficiency).

In rare cases of aortic insufficiency the commencement of the aorta is accessible for percussion. It is to be remembered that here it is very much broadened, and to the right of the sternum, from the lower border of the second rib to the third rib, there is a small area of dulness. Sometimes over the aorta (in the right second intercostal space), in marked atheroma, there ought to be heard a systolic murmur, even when there is no endocarditis aortica.

Aneurism of the aorta requires a special description. It most frequently occurs in the ascending portion or the arch of the aorta, and gives rise to the following phenomena: Only when the aneurism is large is a swelling to be seen, and this, if present, is seen either above the sternum or close to the right of it. It generally pulsates—that is, becomes larger in all directions—with the systole of the heart. From stagnation (see p. 261) the enlarged veins of the skin are very early visible: later they may become red from inflammation, or even be necrotic. In large aneurism, under some circumstances, when we palpate, we feel the pulsation, and besides, not infrequently, a peculiar whizzing or thrill. With large tumors, also, it further shows that the bones and cartilages over them have been absorbed. Repeated measurement of the thorax shows a gradual increase of the sterno-vertebral diameter. Percussion generally very early exhibits dulness, usually on the right, close to the sternum and over the manubrium; more rarely to the left of the sternum, and this either in connection with the area of heart-dulness or distinct from it. Auscultation not infrequently reveals the systolic whizzing, which has already been referred to as being felt, or also only two dull, impure sounds, or they may not be heard at all. The radial pulse, also the carotid, is not infrequently early upon one side smaller and a little later than on the other in consequence of the compression of the particular branches of the aorta or distortion of their openings at the point of origin. Aneurism of the ascending aorta

affects the vessels of the right side, and of the arch of the aorta sometimes affects those of the left side. Not infrequently, also, there exists *insufficiency of the aorta* with hypertrophy of the heart. As by all tumors in its neighborhood, the heart may be crowded toward the left side; also, we see, in examining the larynx, evidences of pressure by these tumors upon the trachea, the œsophagus, the left (seldom the right) recurrent nerve, and the large veins of the body (p. 261).

Aneurism of the innominate produces about the same symptoms as aneurism of the ascending aorta, only generally somewhat higher up.

Aneurism of the descending aorta (rare) may cause corresponding phenomena upon the left side, posteriorly, near the spine. The pulse in the abdominal aorta and its branches is usually later.

Aneurism of the abdominal aorta (likewise rare) is generally at the level of the *tricus coeliacus*. It may be felt as a pulsating tumor in the upper part of the abdomen, and sometimes exhibits the whizzing mentioned above.

Considerable *stenosis or even closure of the aorta* at the junction of the ductus arteriosus is a very rare congenital condition which is recognized by the fact that certain arteries furnish collateral circulation between the ascending aorta and the region of the descending thoracic aorta, or the abdominal aorta. These collateral vessels become very much enlarged, and pulsate so as to be seen and felt. Diagnostically, the most important are the internal mammary, the anterior superior and inferior epigastric anteriorly, the transversus scapulæ and dorsalis posteriorly.

THE PULMONARY ARTERY.—In very rare cases aneurism of the pulmonary artery may give rise to almost the same symptoms as aneurism of the aorta, except in being at the left of the sternum. A systolic murmur over the pulmonary artery may, besides, be caused by stenosis of the pulmonary opening or by *narrowing of the artery* itself. This may be congenital or be developed later, in the latter case by shrinking of the upper portion of the left lung. In such cases the second pulmonary sound is generally accentuated (hypertrophy of the right ventricle), and, under some circumstances, may even be felt (see above).

THE OTHER ARTERIES.—Excepting during excitement of the heart (by mental excitement or physical exertion), we observe in health a visible pulsation of the carotid in the neck just under the angle of the

jaw; also of the temporal artery. A marked pulsation of the carotid, especially when there is perfect mental and physical quietude, or, again, a general visible pulsation of smaller vessels, as of the temporal, the brachial, in the sulcus of the brachial muscle or at the bend of the elbow, of the radial, peroneal, dorsalis pedis, points to *hypertrophy of the left ventricle*. These abnormal pulsations are most marked in *insufficiency of the aortic valves* and in *arterial sclerosis*; in the first case on account of the fulness of the pulse, in the latter case on account of the thickened and stiffened vessels being prominent. In both classes of cases the smaller arteries are very tortuous.

Here, also, a *capillary pulse* is to be mentioned: alternating between marked fulness and emptiness of the capillaries occasioned by the pulse in the arteries, the pulse may become visible under the finger-nails, more rarely over the tendons, in case these variations are connected with a large and quick pulse in the arteries, which, in turn, have large and quick alternations of size. Then, in examining the finger-nail, we see the red part rhythmically become alternately white and red: *capillary pulse of the bed of the nail*.¹ This is a sign of aortic insufficiency with marked hypertrophy of the left ventricle (which would also be present in some cases of marasmus).

Palpation. Medium-sized and small arteries sometimes feel thickened and moderately stiff, or scattered in their walls we feel separate rigid patches, very like the plates of cartilage of the bronchial tubes, or the rings of a small trachea ("goose's throat"). The latter become especially plain if we slip the tip of the finger up and down along the course of the artery. This is the condition in *arterial sclerosis*. Hence, the vessels are often tortuous (see above), and show variations of the pulse (see). It is very easy to recognize arterial sclerosis in the temporal, radial, and brachial arteries. From the condition of these we can correctly estimate the condition of other arteries of the same size.

Palpation of the radial artery has already been described. Of the other arteries of the extremities the pulse of which we can feel in health, we may mention the brachial, in many persons the ulnar, the crural, the popliteal, and in most people the peroneal. Increased

¹ This is often an unfavorable situation for making the observation. Quinke, who first described the capillary pulse, now recommends rubbing gently a spot upon the forehead. Berliner klin. Wochenschr., March 24, 1890.]

pulsation in arteries that can be felt, its occurrence in small arteries that can be felt, which in health are never made out, takes place in *aortic insufficiency*. A pulsation that can be felt in the dorsalis pedis artery is here very frequent, but the same thing may take place in still smaller arteries—in the digital, in the coronariæ labii inferior., superior., and the like. Very exceptionally in aortic insufficiency we may even observe an “arterial liver-pulse”—that is, a continuous to-and-fro swelling of the liver from the marked pulse in the arteries of the liver (quite like the venous liver-pulse, see p. 266). Still more rare is an arterial pulse at the spleen (see under Examination of the Spleen).

When in *symmetrical vessels*, like the two radials, we find a pulse that is unequal as to strength or time, we may generally conclude that there is a mechanical hindrance to the passage of the blood-current. We then have to seek toward the centre from the weaker or later pulsating artery for a compressing tumor, thrombosis (autochthonous or embolic), or for an aneurism. Moreover, there are observed variations of the pulse in symmetrical vessels, caused by vasomotor influences from the nerve-centres. Finally, we must not overlook the possibility of anatomical variations.

Auscultation. Mode of procedure: Here, it is to be understood throughout, the stethoscope is to be employed, and that ordinarily it is to rest upon the surface without pressure. We auscultate the carotid with the neck somewhat extended, but not stretched, in the intersterno-cleido-mastoid fossa or at the angle of the jaw; the subclavian, in the angle between the clavicle and the clavicular head of the sterno-cleido-mastoid muscle; the brachial, on the inner border of the biceps in the bend of the elbow, with the arm slightly extended; the crural, close below Poupart's ligament.

Normal condition. In health we usually hear over the carotid, as well as the subclavian, two sounds—one corresponding to the pulse, with the systole of the heart (the conducted aortic first sound and local diastolic sound in the vessel). In individual cases the first sound is impure, or is entirely wanting. In health the diastolic heart-sound is never wanting. We sometimes hear over the abdominal aorta and the crural artery a sound which corresponds with the pulse, or at any rate arises locally from the tension of the vessels. We usually hear nothing over any of the small vessels. If we press with the stetho-

scope over the given vessel, then we hear the so-called acoustic pressure-sound, not alone over the aorta and subclavian, but also regularly over the abdominal aorta and crural artery, and usually, also, over the brachial. Thus, over these vessels by moderate pressure we hear a pressure-murmur corresponding to the arterial pulse; by stronger pressure, which almost, but not quite, closes the artery, this murmur is changed into a tone—pressure-tone. That these acoustic phenomena, resulting from pressure, are everywhere present, are the chief reasons why the pathological conditions over the large vessels, which are to be mentioned later, have only conditional diagnostic value.

We must also mention a phenomenon frequently present in *healthy* children, called “cerebral blowing”; it is heard between the third month and the sixth year, with the systole of the heart, or, more exactly, as a blowing corresponding with the carotid pulse, which is heard sometimes light, sometimes tolerably loud, over the fontanelle while still open, but also sometimes after it has closed, and elsewhere over the head. Jurasz has, in most cases, found at the same time a blowing over the carotid, and thinks that the cerebral blowing is merely this murmur conducted upward. He explains the latter by the compression which the carotid sustains in the carotid canal during the development of the skull.

Pathological conditions. In aortic stenosis there will be heard over the carotid, in place of the first sound, a rough *systolic heart-murmur* (the stethoscope must rest very lightly).

In aortic insufficiency the second sound of the carotid and subclavian is wanting, or it is replaced by blowing with the diastole of the heart (rare). This, as well as the systolic murmur previously mentioned, is conducted from the mouth of the aorta. The former, arising in a current of blood flowing forward, would naturally, as a rule, be more loudly conducted than the latter, which comes from a backward-flowing blood-current.

Sounds in such arteries as in health very seldom or never furnish a sound, accompany *aortic insufficiency*, being produced by the quick and strong tension of the vessels during their diastole. We then hear a sound corresponding with the pulse over the crural, brachial, radial, even the ulnar, peroneal, dorsalis pedis arteries: sometimes, even, over still smaller vessels. A sound is also observed over the crural

in *high fever*, as well as in *anæmia* and *chlorosis* (and as well in some healthy persons).

A double sound over the crural artery (Traube) is heard in individual cases of aortic insufficiency. But this phenomenon has also, although very exceptionally, been observed with mitral stenosis (Weil), likewise in lead-poisoning (Matterstock), lastly, in pregnancy (Gerhardt). Much more important is the double murmur which is heard when considerable pressure is made with the stethoscope—Duroziez's double murmur. In the experience of observers thus far, this occurs only with aortic insufficiency, and this when there is good compensation, and this has all the greater significance from the fact that it is decidedly more frequent than was previously supposed.

Double sound, as well as double murmur, can only occur when there is a large and quick pulse. In the first phenomenon, the double sound is caused by the sudden collapse of the artery; with double murmur, the second murmur is probably to be explained by the short reflux blood-current which may be assumed to flow into the large vessels when there is aortic insufficiency (?). A double sound can also be heard over the crural artery if one of the two sounds, or even if both sounds arise from the crural vein. (See, regarding this, in the next chapter.)

A *systolic subclavian murmur* is sometimes heard on both sides, or sometimes only on one side (especially the left), as a very disturbing addition to the breath-sounds at the apex of the lungs. It is stronger, or, perhaps, only to be heard toward the end of inspiration. When it occurs upon both sides it, as a rule, does not indicate a pathological condition; when unilateral it also has no significance, and yet it always gives the suspicion of phthisis, with which we often meet it. It is explained by a temporary pulling or bending, and, hence, narrowing of the subclavian artery during deep breathing. In phthisis this is caused by adhesion of the pleural surfaces at the anterior surface of the apex of the lungs. We do not know exactly why this murmur occurs also with persons apparently perfectly healthy, but it may possibly be from the same cause.

Loud *blowing murmurs* over the thyroid glands sometimes occur in all forms of *struma*. These murmurs may be felt. They are not infrequent with *struma* of Basedow's disease, but here they are caused by the excited action of the heart.

The murmurs which in some cases are heard over aneurism have been already mentioned.

EXAMINATION OF THE VEINS.

We examine chiefly, in many cases exclusively, the jugular veins (external and internal in the neck), but also the cutaneous veins of the body and extremities. Only in special cases (thrombosis) do the deep veins of the extremities become accessible for examination. The ophthalmoscopic examination of the ophthalmic veins does not come within the scope of this book. It is important that we are able to judge of the abnormal fulness (engorgement) of certain deep veins by its effect upon particular internal organs, as enlargement of the liver and spleen, also ascites, and, lastly, the suppression of urine.

The examination of the veins is made by inspection, or sometimes by palpation, and auscultation.

INSPECTION AND PALPATION OF VEINS.

By these means we ascertain the degree of fulness, the condition of the circulation, and, under some circumstances, the existence of venous thrombosis. An unusually empty condition of the veins does not come under consideration. This would also be very difficult to determine, for the reason that even in health, especially in fat people, the superficial veins may be indistinct or entirely invisible.

It remains to describe: 1. Increased fulness of veins; 2. Circulation in the veins of the neck; 3. Circulation in the other veins; 4. Venous thrombosis.

1. *Increased Fulness of Veins.*

This is the result of stoppage of the blood in its course toward the centre. It is general or local, according to the cause of the engorgement—whether this be central or at some place in the course of the nerves that control the circulation.

General increased fulness is the result of general venous engorgement. We first recognize it by the swelling of the internal and external jugular veins upon both sides. The first of these is usually visible in health (but not always, especially in fat people), coursing

obliquely over the sterno-cleido-mastoid muscle. When the head is turned toward the opposite side it usually swells still more. With the increased fulness it becomes distinct, perhaps can be felt. With normal fulness the internal jugular cannot be made out, situated, as it is, under the sterno-cleido-mastoid muscle, where it is divided into the clavicular and sternal portion just in the angle between these at the bottom of the intersterno-cleido-mastoid fossa. Where it passes into the bulbus jugularis it has a valve (ordinarily exactly at the upper border of the sterno-clavicular articulation, but sometimes, especially in consequence of the engorgement, located somewhat higher up). Abnormal fulness of the jugular vein fills up the intersterno-cleido-mastoid fossa, or it may cause a projection there. Dorsal posture increases the fulness. Fulness of the cutaneous veins of the trunk and extremities, not occurring without general engorgement, is usually not so pronounced as that of the veins of the neck, especially on account of the marked œdema which accompanies the congestion. Important associated symptoms of general engorgement are cyanosis, œdema, effusion into the cavities of the body, enlargement of liver and spleen, disturbance of the bowels, and so-called concentrated urine (which see).

This condition arises when the right heart is not able to propel the required quantity of blood into the lungs. It occurs in various diseases of the heart, in emphysema of the lungs, and in all the conditions that lead to marked interference with the action of the heart, especially pericarditis. The most marked engorgement occurs in general when the right side of the heart is paralyzed after it has been obliged for a long time previously to meet unusual demands, and hence has become hypertrophied; hence with mitral, and, more rarely, pulmonary defects and emphysema, and likewise, in the very rare tricuspid stenosis and insufficiency (see under 3).

General abnormal fulness of the veins may also be the result, exceptionally, of diminished flow of blood from the two cavæ into the right auricle in consequence of pressure by a mediastinal tumor.

Local increased fulness of the veins may be caused by a considerable narrowing or closure anywhere of a venous trunk by a thrombus or by compression. The larger the vessel thus affected, the more extensive the area of abnormal fulness. Thus sometimes abnormal fulness of the jugular and its branches, also of the ophthalmic vein (recognized

by the ophthalmoscope), will be caused by a mediastinal tumor which presses upon the cava. Also the superficial veins of the skull between the ear and the fontanelle will become distended and tortuous if the longitudinal sinus of the dura is stopped. Fulness of the veins of an arm points to compression of the axillary vein (generally tumors or scars from operations in the axilla). The swelling of single small cutaneous veins over the sternum and in its neighborhood is a very important early sign of mediastinal tumor. The cutaneous veins of the leg are enlarged when there is thrombosis or compression of the femoral vein of that side. The veins of both legs may swell as the result of double thrombosis or compression of the vena cava inferior or both iliac veins (ascites, tumors). In all these cases there may be local œdema (which see). This may even give a better and earlier sign of local engorgement, but, on the other hand, it may conceal the fulness of the veins.

In the majority of such cases the cutaneous veins supply the necessary collateral circulation. But this is especially the case in engorgement of the portal vein (see also Enlargement of the Spleen and Ascites), whether due to cirrhosis of the liver or compression or thrombosis of the portal trunk. Here we may see the abdominal veins enlarged, part of which go upward to the thorax and part down to the inguinal region. In individual cases there is a crown of such veins around the navel—"caput Medusæ"—since the umbilical vein, remaining open, receives a part of the overflow of blood which the portal is not able to carry.

Very extensive enlargement and tortuosity of a large part of the cutaneous veins of the trunk, or of the chest (generally symmetrical), or enlargement of single cutaneous veins of an extremity also occurs without any possible assignable cause (perhaps closure of a deep branch), so that recently we are inclined to the assumption that in such cases there is a congenital condition or disease of the wall of the vein itself.

2. *Phenomena of Circulation in the Jugular Veins.*

Respiratory motions. The suction-action of the chest with inspiration causes a rapid emptying of the blood from the veins of the body into the heart during inspiration, as well as during expiration. On

the other hand, a forced expiration, likewise strong effort, and very especially the increased internal pressure within the chest which takes place in coughing before each cough-impulse, checks the discharge. The alteration in the fulness of the veins in the neighborhood of the heart which is thus caused is usually only to be observed in the jugular veins. But in normal fulness of these veins the simple respiratory oscillation of their volume is not noticeable. Such veins only distinctly swell with marked pressing and coughing (whooping-cough), and then the veins of the face become very full. Yet when the veins of the neck are constantly abnormally full or engorged, then in ordinary breathing they show a corresponding to-and-fro swelling, and with forced expiration, pressing or coughing, they stand out very distinctly. The *bulbus jugularis* may then appear as a round bunch between the heads of the two sterno-cleido-mastoidei muscles; but even the whole internal jugular may swell and contract if the valve over the bulb does not close. This phenomenon occurs in the most marked degree with the labored expiration of emphysema. Here, also, in very rare cases, this variation in the fulness extends to the cutaneous veins of the face, the chest, and arms.

The opposite condition of the veins of the neck, becoming tumid with inspiration and emptying with expiration, may be caused by fibroid mediastinitis (mediastino-pericarditis). The cause of the phenomenon, like that of *pulsus paradoxus* (which see), is the traction and bending of the large vessels during inspiration (Kussmaul).

Venous pulse. Circulatory movements in the veins or the neck, which directly or indirectly depend upon the action of the heart, and hence are rhythmic, are designated as venous pulse. This motion may be communicated, or be really in the vessels (autochthonous, real pulse). The former is only the pulsation in the carotid communicated to the internal jugular, which shows most frequently and plainly when the carotid pulsates very strongly, or when the internal jugular is very full, or if both conditions exist. (For distinction between this and genuine systolic venous pulse, see p. 267.)

We divide the real venous pulse, pulsation in the veins of the neck, into that which occurs in health, the so-called "normal," or negative; and the positive, which is always pathological. The normal venous pulse is presystolic, and usually is only observed in the external jugular. It would be best designated as a collapse of the vein

accompanying the systole of the heart; for the external jugular, exactly corresponding with the apex-beat and the carotid pulse, quickly empties itself and immediately again slowly fills, sometimes visibly in two intervals, so that it attains its complete distention before the next systole of the heart, and hence is presystolic.

This phenomenon depends upon the part the auricle plays in the action of the heart: during the ventricular systole it is in diastole,

FIG. 74.

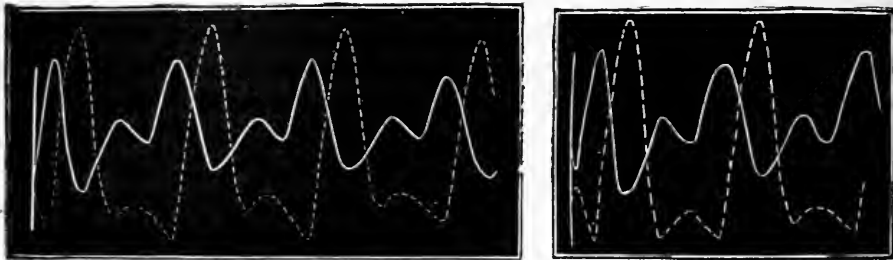

Normal venous pulse or venous collapse with systole of the heart, and (broken line) carotid pulse. (After RIEGEL.)

and thus favors the flow of blood from the veins. Shortly after the beginning of the ventricular diastole it begins to contract, and thus the flow of the venous blood from the cava into the auricle is impeded. It seems to me that the first elevation of the ascending side of the tracing of the curve of the venous pulse has not yet been explained. In health this pulse is seen to a very small, scarcely noticeable degree; it is beautifully seen in dogs when the jugular is laid bare. In healthy persons, without any known reason, it is in some cases strong enough to be observed. But it is still stronger sometimes when the external jugular is abnormally full, hence in engorgement. Often this pulse occurs only indistinctly, its rhythm is difficult to recognize, and also affected by the pulsations of the carotid. Then we speak of undulation in the veins of the neck.

The positive venous pulse is systolic, hence is contemporaneous with the carotid pulse. It is a pathognomonic sign of insufficiency of the tricuspid valve, and is caused by the contraction of the right ventricle, which causes a regurgitant positive blood-wave into the cava and its nearest branches through the imperfectly closed right *ostium*

venosum. It first and most markedly appears in the internal jugulars or their bulb, and generally only here. The very direct course of the innominate and right jugular from the cava causes the right jugular vein to show the phenomenon more frequently and stronger than the left.

If the valve of the vein closes above the bulb of the jugular then the regurgitant wave ends there. This pushes the bulb up and dis-

FIG. 75.

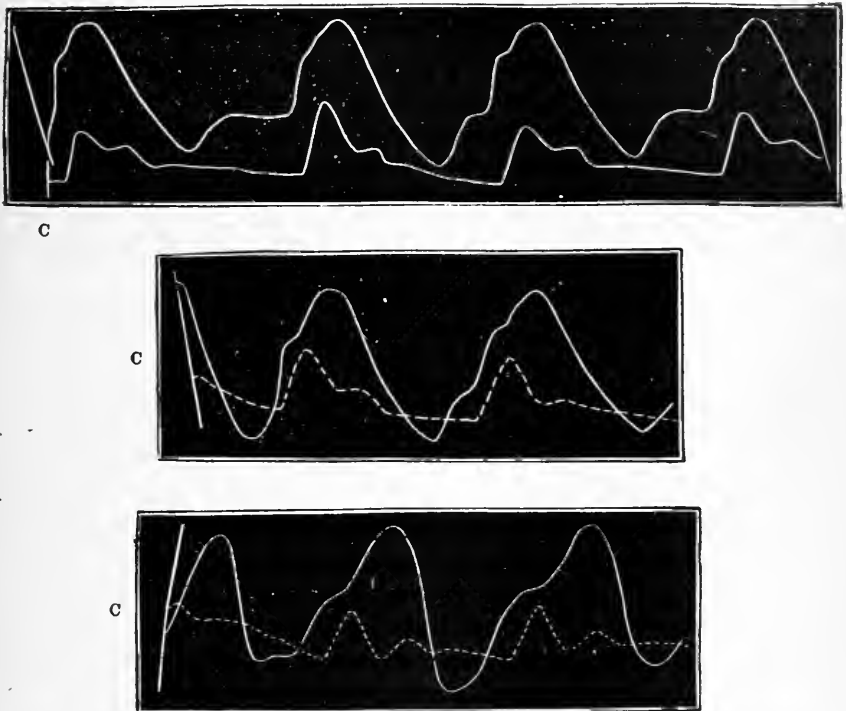

Positive jugular pulse compared with (C) carotid pulse. (After RIEGEL.)

tends it, and it is then seen, enlarged and pulsating, in the intersterno-cleido-mastoid fossa (bulbar pulse). The bound of the pulse-wave against the valve sometimes causes a valvular sound in the jugular. But ordinarily the valve is insufficient from previous engorgement (or is congenitally so), or it becomes so from the distending action of the pulse, and then the pulse-wave passes into the internal

jugular, and exceptionally also into its branches in the face. This systolic pulse must likewise be supposed to be propagated to a certain extent also in all other veins that are directly given off from the cava; but they cannot be examined except in a large venous territory: the veins of the liver. Here the pulse manifests itself by a constant systolic swelling and diastolic collapse of the organ, *the venous liver pulse*. Palpation of a liver thus constantly enlarged frequently shows the phenomenon of systolic venous pulse to a high degree.

The systolic jugular pulse may be graphically represented, as is shown in Fig. 75.

The mode of procedure in palpating the liver is as follows: One hand is placed upon the right hypochondrium or the epigastrium, the other is passed around the chest at the level of the eleventh and twelfth ribs posteriorly. We can then feel that the organ is systolically enlarged, and thus we may avoid confounding it with lifting up of the liver by the aorta or even with marked epigastric pulsation. Moreover, we recognize the liver-pulse in this way easier—that is sooner—than by simply palpating in front. The liver is usually enlarged, almost always by the previously existing engorgement (see Enlargement of the Liver); at least, it immediately becomes so if tricuspid insufficiency occurs, as we very distinctly observed in a case of mitral insufficiency and stenosis, in which relative tricuspid insufficiency occurred, then subsided and again reappeared.

Arterial liver-pulse is exactly like venous liver-pulse in its phenomena (in aortic insufficiency, see p. 257).

For the production of a recognizable venous liver-pulse, as well as a strong jugular-pulse, there is, of course, required a certain moderate, and, if it has not been met with before, also it must not be too frequent action of the heart. As the heart grows more and more weak the liver-pulse fails and the jugular-pulse gradually becomes smaller and more slow, until finally there is only a slight to-and-fro movement of the vein.

In order to make a differential diagnosis of the different kinds of pulse in the veins of the neck it is necessary to bear in mind the following: 1. The transmitted pulse will be best distinguished from the positive real pulsation, occurring at the same time with it, by placing the finger, or, better still, a pleximeter, with its edge in the middle of the neck upon the vein: if the pulsation is communicated it disappears

in the central empty portion and becomes more distinct in the periphery from the engorgement of the distended portion; on the other hand, a positive genuine pulse remains centrally unchanged. 2. The negative true pulse is distinguished from the positive and from the communicated pulsation generally by comparison with the apex-beat as well as by comparison with the carotid pulse. (We seize the left carotid, and at the same time observe the right jugular.) It is also to be observed that with the negative pulse the collapse of the vein is usually quick and that it refills slowly. In this way, with a little practice, one can often immediately judge correctly.

In order more exactly to observe and study these phenomena it is well to have the patient for a time breathe very superficially, or, if possible, to hold the breath, so as to eliminate the respiratory to-and-fro swelling of the veins.

We must still mention some occurrences that are extremely rare or are of very little diagnostic value :

Diastolic collapse of the cervical veins (Friedreich), which looks very like systolic venous pulse, sometimes occurs in adhesive pericarditis and fibroid mediastinitis, and is connected with systolic drawing-in in the neighborhood of the heart which occurs with this condition. The springing forward of the heart in the diastole, together with the forward movement of the anterior wall of the chest, probably produces an aspiration of the contents of the large veins.

Systolic venous pulse may exceptionally occur with mitral insufficiency and open foramen ovale: through the latter and the left ostium venosum the contraction of the left ventricle produces a recurrent pulse-wave in the cavæ and their nearest branches (very rare, being thus far only observed in one case).

Double positive venous pulse (Leyden) is observed in hemisystole.

3. *Phenomena of Circulation in other Veins.*

Systolic true pulse may, as has already been mentioned, be propagated to the veins of the face, but this is rare. It has, in individual cases, even been observed in the cutaneous veins of the arm, in the small branches of the internal mammary (of which I have seen one case), in the vena cava inferior (Geigel), etc.

The so-called progressive venous pulse (Quincke) has been seen in

the veins of the hand and the back of the foot with existing capillary pulse (aortic insufficiency, also in severe anæmia; likewise reported to have been seen in health), as a pulse-wave flowing centrally, and later appearing as the radial pulse (a very great rarity). It can be regarded as nothing else than the arterial pulse propagated through the capillaries.

4. *Venous Thrombosis.*

The transformation of the soft venous tubes into firm round cords that can be felt exhibits venous thrombosis. The thrombosed vein may often also be perceived by pressure. In internal medicine, of especial interest and importance is thrombosis of the large veins of the lower extremities as it sometimes occurs in the course of severe acute infectious diseases, as the result of chronic invalidism, and in marasmus of the aged. Frequently, but never while resting in bed, it occurs in the œdema of engorgement in the affected limb.

AUSCULTATION OF VEINS.

1. Sounds and murmurs of short duration are sometimes heard over the jugular and crural veins:

In tricuspid insufficiency there is a systolic recurrent blood-wave, which, by its impulse against the closing valve above the *bulbus jugularis* and against those in the crural vein at Poupert's ligament, and also by the sudden tension of the vein itself, causes a sound which will be heard by very lightly placing the stethoscope at these points. But a sound has also been heard where the crural valve was defective. In such cases it must be alone caused by the sudden tension of the venous tube. If these valves are insufficient there may be a corresponding short murmur (very rare).

Jugular sound generally accompanies the bulbar pulse of tricuspid insufficiency. A venous sound over the crural is, however, rare, because the recurrent wave only exceptionally reaches this vessel. Quite exceptionally there may be with tricuspid insufficiency a double sound over the crural vein, indicating first auricular, then ventricular, contraction (Friedreich). It can be distinguished with certainty from the sounds, double sounds, and murmurs of the crural artery only when there exist signs of aortic or tricuspid insufficiency (hence, how

small is the diagnostic value of these phenomena!). Crural, arterial, and venous sounds may be combined when there exist at the same time aortic and tricuspid insufficiency.

Now and then, even in health, especially in thin persons, a sound is produced over the crural vein by sudden straining or coughing (expiratory valvular sound in the crural vein—Friedreich).

2. A continuous murmur, designated as venous humming, venous murmur, or buzzing, is often heard in anæmic, and especially in chlorotic, patients, but sometimes also in many healthy persons, over the jugular veins. It is usually louder on the right side. It sounds like a regular humming or a very fine whizzing or like the humming of a top. If it is very marked it can also be felt. The murmur is caused by the whirl in the blood as it flows from the narrow jugular into its wider bulb. The whirls are the more marked, the more rapid the stream; and hence the murmur becomes louder in deep inspiration, and for the same reason it is generally louder in the upright position than when lying down. And likewise it is not infrequently louder in the diastole than in the systole of the heart. Also, the predominance of the right jugular over the left is explained by the difference in the rapidity of the current caused by the different shape of opening into the cava (see above, p. 265). This murmur will be increased by slight compression, as may be produced by the stethoscope or by turning the head to the opposite side. This latter effect comes from the tension of the *fascia colli*, and probably also from the contraction of the omo-hyoideus muscle.

As to what the occurrence of this murmur means we must rest upon the old idea that it chiefly occurs with anæmic and especially chlorotic patients. Friedreich's claim that it is more marked in these cases, while in health it is usually only to be heard as a soft humming, seems to me to be very far-fetched. Strictly speaking, no diagnostic importance is to be attached to this phenomenon.

Similar murmurs occur exceptionally in other veins, and it is to be noted, almost exclusively in anæmia; thus in the large veins of the extremities and also in the intrathoracic trunks. Here the murmur is always much stronger during the heart's diastole and can thus appear to be interrupted. It has already been mentioned that Sahli declared the anæmic heart-murmurs to be in part propagated from the venous trunks in the chest.

EXAMINATION OF THE BLOOD.

PRELIMINARY REMARKS.

In health the entire quantity of blood in the body amounts to about one-thirteenth of its weight. At the bedside we can in no way reach an approximation of the quantity of the blood, although it is evident that the capacity of the arteries (assuming that there is an equal proportion of blood in the circulation) must in general determine the total quantity of blood. But the loss arising from this defect in our methods of examination is only very small, because, according to our present knowledge, the quantity of the blood is affected in a way that is characteristic and understood by us only in isolated conditions, as for instance, immediately after loss of blood, with extensive watery discharges, as in Asiatic cholera and in severe diarrhœa, especially in children.

On the other hand, according to our present knowledge of pathology, and our methods of examination, there are a number of conditions of the blood which relate to its morphological constituents or morphological admixtures, which are, as also the amount of hæmoglobin, and certain relations of this substance with O, CO₂, etc., of the greatest importance in recognizing certain diseases. There are some less important diagnostic chemical departures from the normal.

Besides the inspection of the skin, which is not entirely without value, the methods which chiefly come into consideration are: the examination of a drop of blood with the naked eye, spectroscopic examination, and that which is made with certain apparatus for approximative determination of the intensity of the color (amount of hæmoglobin).

1. *Color and Spectroscopic Character of the Blood.*

Blood taken directly from a healthy person is of a recognized color; if arterial it is brighter, rich in oxygen, that is, rich in oxyhæmoglobin. If venous, it is darker; if bluish-red, it is poor in oxygen. The marked deficiency of oxygen in the blood of a person suffering from dyspnœa or venous engorgement, or both, makes the blood very dark. In carbonic acid poisoning the blood is bright cherry-red; from chlorate of potash, anilin, and in severe poisoning by hydro-

cyanic acid and nitrobenzole it is brownish-red or chocolate color. In severe anæmia and chlorosis (hydræmia) the blood is watery: in marked leukæmia it looks a peculiar whitish-red as if mixed with milk, or chocolate color.

These changes in the color of the blood all have an effect upon the color of the patient's skin, as has partly already been mentioned. Hence patients with carbonic acid poisoning look strikingly rosy, while in poisoning with chlorate of potash, anilin, and nitrobenzole the skin and mucous membrane is a peculiar grayish blue or black color. These discolorations of the skin, as well as the differences in the color of a drop of blood obtained by pricking with a needle, have too little distinction to be directly of diagnostic use. But, especially with regard to the poisons that have been mentioned, if they are recognized as unusual, they demand that a timely and thorough examination of the blood be made by the spectroscope or microscope. In this lies the great value of a knowledge of these discolorations.

For recognizing hæmoglobinæmia (from the hæmoglobin that appears in solution in the serum of the blood originating from the red blood-corpuscles) it is necessary to employ a wet cupping-glass. The blood thus withdrawn is allowed to stand covered for twenty-four hours, if possible in an ice chest, and then the serum, separated from the coagulum, is to be examined. That from normal blood is yellow, in hæmoglobinæmia it is rubine-red, and in the spectroscope gives the bands of oxyhæmoglobin (see below).

Approximative determination of the amount of hæmoglobin: A diminution in the amount of the hæmoglobin may be conditioned upon a diminished number of red corpuscles or upon a decrease in the amount in single corpuscles, or upon both (see below). It is recognized by the paleness, and if the loss be very great, the practised eye recognizes it by the clear watery look of a drop of blood. A variety of apparatus, called hæmochromometer, has been devised for determining this condition (Quincke, Bizzozero), but recently these have been surpassed in simplicity and utility by the hæmometer of Fleischl. The principle of this is as follows:

A certain very small quantity of blood (obtained by a prick) is thinned by a definite quantity of water, and then by lamp or gaslight the color of this mixture is compared with the color of a glass wedge

which has been colored with Cassius' gold purple and carries a movable scale. Upon this scale the figure 100 corresponds with the intensity of color of a mixture of normal blood. Material that has less intensity has the numbers 90, 80, etc., down to 10, thus giving directly the percentage relation of the mixture of blood that is being examined to that of normal blood with reference to the quantity of hæmoglobin. Thus 90 indicates, if the mixture of blood has been properly prepared and corresponds in color with the color of the glass wedge at that point of the scale, that this blood contains only ninety per centum of normal quantity of hæmoglobin.

But the determination of the exact quantity of hæmoglobin can only be made by quantitative spectrum analysis (K. Vierordt). It would exceed the limits of this book to give a description of the method of procedure.

Spectroscopic condition of the blood. In certain cases its examination has decided significance. Recently it has been rendered very much more easy by very practical clinical and uncomplicated apparatus, of which we may mention the spectroscope devised by Desaga (Heidelberg), and still more recently Hering's very cheap spectroscope without lenses. According to our own experience and also the opinion of Jaksch, the latter after a little practice is entirely satisfactory for clinical purposes.

In three classes of cases the spectroscopic examination of the blood gives a valuable result: in hæmoglobinæmia there is no doubt about the presence of the coloring matter of the blood in the serum (see previous page) if the serum shows the absorption band of oxyhæmoglobin; one in yellow near green (close to D, Fraunhofer), and one in green near the former, between D and E. Moreover, in carbonic oxide poisoning there appear in the blood two absorption-bands which are very near the two above mentioned, only a little nearer the violet line, and hence they may be confounded with them, but they are very distinctly separated from bands of oxyhæmoglobin in that they do not disappear on the addition of ammonium sulphate (since carbonic oxyhæmoglobin is not thus reduced).

Lastly, it has recently been discovered that in poisoning with chlorate of potash methæmoglobin occurs in the blood in the living organism. In acid and neutral solutions this causes an absorption-band in yellow (between C and D, besides three others more faint),

which coincide with that of hæmatin, but which are distinguished from it in that upon the addition of ammonium sulphate it first gives place to the absorption-bands of oxyhæmoglobin, then to that of O-free hæmoglobin (a broader band from D almost to E in green and yellow). In alkaline solution, methæmoglobin shows a narrow band in yellow near to D, and one in yellow-green and green.

There are still other changes in the blood partly relating to its color and partly relating to its behavior in the spectrum, when animals are poisoned, but they do not seem to require mention in this book.

2. *Microscopic Examination of the Blood.*

Mode of procedure. When we wish to examine a patient's blood we first clean an object-glass and a cover as carefully as possible. Then cleaning the tip of the finger with water or a $\frac{1}{2}$ per cent. solution of salt as carefully as possible, we puncture the finger-tip with a clean needle and allow a drop of blood as it escapes to fall upon the object-glass and without pressure cover it, or we move the cover lightly, without disturbing the finger, over the escaping blood, and then immediately very cautiously place it upon the object-glass. It is not advisable to squeeze the patient's finger in order to force the blood out.

In examining for microorganisms all instruments or apparatus must be especially cleaned, and the finger scrubbed with soap and a brush, then with alcohol and ether. According to the special object of the examination we employ a magnifying power of from 300 to 700 diameters.

If, instead of the finger, we prick the lobe of the ear, it is just as well, and the whole proceeding is much less painful to the patient.

The normal structures of the blood consist of red and white blood-corpuscles, and blood-plates. Clinically the latter of these have previously had no interest. The pathological conditions that are recognizable by the microscope may be divided into alterations in the number or appearance of the blood-cells, and into foreign substances, as microorganisms.

In general, we again distinguish the changes in the number and character of the blood-corpuscles with reference to diminution of the red corpuscles (oligocythæmia) and changes in the structure and size

of the red corpuscles (poikilocythæmia and microcythæmia). But these forms often pass into each other.

1. *Oligocythæmia, diminution in the number of red corpuscles*, is the change which takes place in anæmia (not in chlorosis). If very marked, it is even recognized by the watery appearance of a drop of blood. At all events, by the practised eye it may be recognized without farther examination of the ordinary microscopical preparation (although very little reliance can be placed upon such a superficial examination). For exactly determining the number of blood-corpuscles we employ an apparatus devised for counting the corpuscles in a given quantity of blood.

It is in the first place to be remarked that counting of the red corpuscles is very seldom absolutely necessary for making a diagnosis of the different forms of anæmia (of which see below), but it may be of great value in judging of the course of a given disease, especially as regards the effect of treatment.

The Thoma-Zeiss apparatus for counting the number of corpuscles is the best of all those now in use. It consists of a mixer and a Hayem's counting chamber.

The mixer serves to distribute the blood in as equal a manner as possible, a very important point. For thinning the blood a 3 per cent. solution of salt is recommended. The mixer is a kind of measuring pipette with a very fine canal, and with a spherical enlargement containing a little glass ball. The portion of the tube below the cavity has the marks 0.5 and 1.0. Just above the cavity is the mark 101. The first two marks are those to which the blood, directly after it has been drawn from the finger, is sucked. If we wish a mixture of 1 to 200 we draw it up to 0.5; if a mixture of 1 to 100 to 1.0. In both cases we wash off the blood clinging to the point, and draw in a 3 per cent. solution of salt to 101. Then the mixer is shaken several times so that the glass ball equally mixes its contents. We next expel the contents of the fine tube, which consist of salt solution, after which we fill from the mixture a Hayem's counting chamber. This consists of an object-glass with a circular excavation; it is a space exactly $\frac{1}{10}$ mm. deep, the floor of which is divided into microscopic squares, whose sides are $\frac{1}{20}$ mm. long. The cubic capacity of the space over each square is $\frac{1}{20} \times \frac{1}{20} \times \frac{1}{10}$ c.mm. = $\frac{1}{4000}$ c.mm.

Into this cavity some of the blood-mixture is blown and then covered with a glass cover after carefully expelling any air bubbles.

After waiting a moment in order that the blood-corpuscles may as far as possible equally distribute themselves, we magnify it about 50 diameters and count the number of corpuscles in the larger number of the above-named squares, and thus obtain an average of the contents of say sixteen of them. The oftener these sixteen squares are counted, the greater will be the accuracy of the result. We can calculate the number of corpuscles in a cubic millimetre from the proportions of the mixture and the cubic contents of the squares, as given above.

Immediately after use, the mixer must be most carefully washed with water, alcohol and ether.

Normally, in a cubic millimetre of human blood, there are in the male about five million, in the female about four and a half million red corpuscles (C. Vierordt, Laache). We may only positively affirm that there is a pathological diminution when, examining a case for the first time, the enumeration gives half of the number or less. The least quantity observed in disease is about 400,000 to the cubic millimetre.

Besides diminution in the number of red corpuscles, in anæmia (hydræmia) we observe the following: 1. They manifest diminished or even no tendency to the formation of *rouleaux*, which is a well-known peculiarity of normal blood. 2. Star forms, mulberry forms, which are also usual in normal blood as soon as it is withdrawn, occur seldom or not at all. 3. The red corpuscles are paler in simple anæmia (very markedly so in chlorosis), on account of the diminished amount of hæmoglobin. The opposite condition is not infrequent in poikilo- and micro-cythæmia (which see). 4. In a certain proportion of cases there occurs a slight alteration in the form and size of the red corpuscles, as referred to under 3. 5. The white corpuscles are, in proportion to the red, somewhat increased (relative leucocythæmia).

Oligocythæmia is always connected with diminished amount of hæmoglobin in the blood, whether there is a diminution in the number of the red corpuscles or the individual corpuscles are paler. The diseases in which both conditions exist are the different forms of anæmia, pernicious anæmia, leucæmia. On the other hand, only a

diminished quantity of hæmoglobin in the blood, that is to say, no notable diminution in the number of red corpuscles, occurs in chlorosis. In observing the progress of the first-named diseases we must make an enumeration and examine with reference to the amount of hæmoglobin, while in chlorosis it is only necessary to examine for the latter. In the former case the number of red corpuscles and the hæmoglobin seem to go hand in hand. Hence it seems to me that, especially on account of its simplicity and its approximate accuracy, Fleischl's hæmometer may be very strongly recommended to physicians for examining the color of the blood in the course of an anæmia (strictly speaking, chlorosis), thus answering in a great majority of cases, on account of the particular care which the enumeration requires, unless there should be some indication for counting the corpuscles.

2. *Alterations in the size and form of the red corpuscles.* Formerly this was, in its totality, considered as a diagnostic sign of pernicious anæmia. Now we know that there are other conditions that accompany such variations. The simplest way of determining the size is to compare a preparation of blood with that of a healthy person (the examiner himself). The normal diameter of red blood-corpuscles is 7.7 to 8 μ [*i. e.*, about $\frac{1}{3300}$ of an inch].

Microcythæmia. By this we understand the occurrence of forms containing hæmoglobin, which are smaller than red blood-corpuscles, in which the form is nearly or quite perfect, or, if they are very small, they are simply globular. We see the former in the new formations of blood after hæmorrhages, and also in all kinds of anæmia. They are probably young red corpuscles. The latter—microcytes, strictly so-called—occur especially frequently in pernicious anæmia, and also in all other forms of anæmia. The supposition that they are formed upon the glass slide is possibly correct, because they may even be found in normal blood when the preparation contains air, is pressed, or is old. I have never seen them when examining a perfectly fresh, otherwise normal preparation of blood, except at the border (the effect of air).

Macrocytes—abnormally large red corpuscles, besides those of normal size and very small ones—occur in individual cases of marked and simple anæmia, but especially in pernicious anæmia. This disease must always be suspected when they are present. Corpuscles

that are larger than normal are almost always also poikilocytes, like the following :

Poikilocytes, strictly speaking, are red corpuscles changed in form. They may assume the greatest variety of forms—club, biscuit, pear, flask, and drum-stick are the most usual forms. In many ways poikilocytes correspond to enlarged red corpuscles. In individual cases they exhibit amoeboid movements. In a wider sense we employ the expression poikilocytosis to a mixture of such forms with microcytes and macrocytes, which are almost always present.

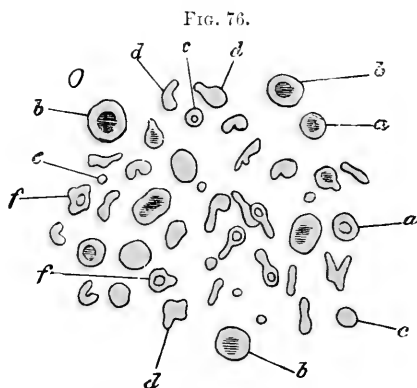

Poikilo-, macro-, microcytosis (as represented by the letters *d*, *b*, *c*). *a*, normal blood-corpuscle; *c*, product of decomposition of a red blood-corpuscle; *f*, nucleated red blood-corpuscle (marked anæmia). (After QUINCKE.)

We must avoid confounding with them the mulberry and thorn-apple forms, which occur normally, or mechanical or chemical products, by using the greatest care in making the preparations and then immediately examining them.

Poikilocytosis is not at all a pathognomonic symptom of pernicious anæmia, although in other forms of anæmia it does not occur so regularly and in so marked a degree as in pernicious anæmia. It may occur with any severe form of anæmia and cachexia, as in tape-worm, or cancer-cachexia.

As a matter of course, all these changes in the red corpuscles usually very notably accompany diminution in their number and of the amount of hæmoglobin. Hence, as has already been mentioned, the amount of hæmoglobin in single blood-corpuscles is not infrequently increased.

3. *Increase of the white blood-corpuscles (leukæmia, leucocytosis).* The proportion of white blood-corpuscles to the red in normal blood, drawn by pricking the finger, if we take the average of the reported observations, is about 1:400 to 1:700, which is a considerable variation.

Where this proportion varies temporarily and slightly in favor of the white corpuscles, we designate the condition as leucocytosis; if it is long continued and very marked, as leukæmia.

Ordinarily we can easily distinguish at the first glance between these two conditions, since leukæmia is generally accompanied with a very marked increase, and leucocytosis with but a slight increase of the white cells. Hence, we rarely have cases that are on the border between the two.

FIG. 77.

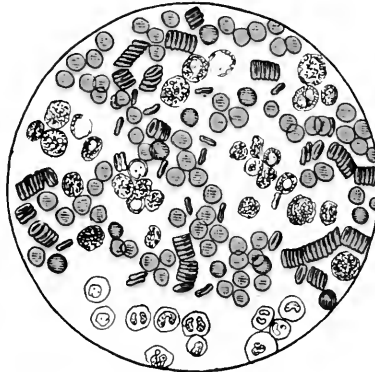

Blood of leukæmia. (After FUNKB.)

During digestion, leucocytosis is observed as a physiological condition. It is also seen in acute infectious diseases, especially in typhoid fever and in relapsing fever, malignant pustule, etc. We have inflammatory leucocytosis in swelling of the lymphatic glands from inflammation of all kinds, especially in erysipelas. Lastly, we meet with cachectic or hydræmic leucocytosis in all forms of anæmia, and this may be either relative, dependent upon a diminution of the red corpuscles, or, as enumeration shows, it may be absolute. In the latter case, it is explained by the undoubted acceleration of the lymph-current in consequence of hydræmia.

Under the microscope, leukæmia is manifest in that usually there is a remarkable increase in the white corpuscles. The proportion of white to red corpuscles is as 1 to 10; many writers think that when the proportion is more than 1 to 20 we have the condition of leukæmia. In extreme cases, which are rare, the number of red and white corpuscles becomes about equal.

At any rate, the number of red corpuscles is always diminished: Jaksch found the average of a number of cases to be two to three million cells (red and white) in a cubic millimetre of blood. The size of the white corpuscles usually remains normal; but very often remarkably large leucocytes are found, some of which have strikingly large nuclei. Moreover, we sometimes find nucleated red corpuscles (probably transition forms from the white to red). The red corpuscles often have the forms of poikilocytosis. Ehrlich found a remarkable behavior of leucocytes—that is, their protoplasmic granules—in the presence of certain aniline colors. His most important result is the discovery that only in leukæmia are there found in the blood white cells called eosinophile—that is, that are distinctly colored with eosin. In doubtful cases this fact would seem to be useful in diagnosing leukæmia.¹

Ehrlich dries a preparation upon a covering glass, as thin as possible, in the air or exsiccator, heats it for ten to twelve hours in a drying chamber at 120°–130° C., and quickly stains it with eosin-glycerin. Then he washes it with water, and mounts it dry in Canada balsam.

Opinion is divided as to whether it is possible to recognize the different pathological, anatomical, or clinical forms of leukæmia by the condition of the blood—that is, to discriminate whether the leukæmia exists by participation with lymph-glands, the spleen, medulla of the bones (lymphatic, splenic, myelogenic leukæmia). It seems true that the above-mentioned transition-forms between red and white blood-corpuscles point to alterations in the medulla of the bones. Moreover, many think that the small cells are more connected with the lymph-glands and the large ones with the spleen.

In extremely rare cases of leukæmia, crystals are found in the blood (Charcot): they are colorless, shining, long octahedral, like Charcot's crystals found in the stools and expectoration, or they are identical with them.

¹ According to the investigations of Müller and Rieder, the eosinophile cells show that in leukæmia the bone-marrow is primarily affected.—TRANSLATOR.

4. *Abnormal additions to the blood.* Of these we first mention melanæmia and lipæmia.

Melanæmia occurs directly after severe attacks of malaria and in malarial disease. We sometimes find, swimming free in the blood, brownish-black or yellow-brown lumps and granules, or, also, white blood-corpuscles filled with such granules. They result from breaking up of red corpuscles.

By *lipæmia* we understand the occurrence of extremely fine drops of fat in the blood, as in drunkards, in diabetes, and in chyluria; but they are also sometimes seen in health.

In recent times we have learned to recognize microorganisms as most important additions to human blood. They are exclusively schizomycetes.

FIG. 78.

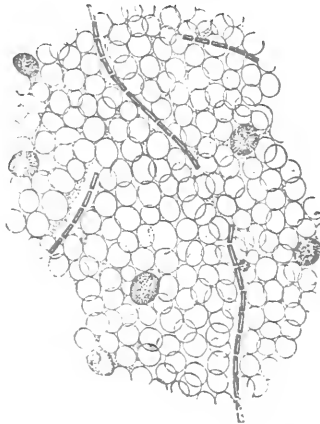

Anthrax bacilli in the arterial human blood (fuchsin-staining. Ziess's homogeneous immersion lens $\frac{1}{2}$, eye piece 4, camera lucida, magnified about 1000 diameters). The white line in the middle of the bacilli indicates only reflections. Prepared by Dr. Freimuth in Danzig.

Anthrax bacilli in the blood have been repeatedly found in infection by anthrax, although always in moderate quantity. The defect in the microscopical proof does not exclude, however, a general infection: a test by inoculating mice may, however, succeed.

We may often have single bacilli of anthrax occurring together, not threads; spores may be entirely wanting. The bacilli are recog-

nized, without staining, as tolerably thick rods, as long as, or twice the diameter of, a red blood-corpusele. Regarding staining, see below.

FIG. 79.

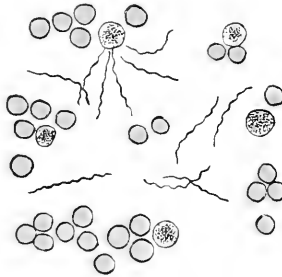

Spirillum recurrentes in the blood. (After JAKSCH.)

The first microörganisms that were seen in the blood were the *spirillum recurrentes* (Obermeier). We find them during an attack of recurrent fever. They disappear shortly before the decline of the fever. By careful examination they can always be demonstrated, although sometimes there are only a few of them.

In a fresh drop of blood they appear (Hartnack 8, Zeiss F) as extremely fine threads, about five times as long as the diameter of a red corpusele, with extremely active spiral, serpentine motion. They occur either singly or several close together, sometimes lying together like a group of rats' tails. I have very often first seen them near white blood-corpuseles. The white or red corpusele against which it lies is usually set slightly in motion by the microbe, and hence we find them there first. Moreover, there often occurs in the blood slight leukocytosis; also, we sometimes meet with shining granules (elementary granules? spores?). As to staining, which, after a little practice, is not necessary, see below.

Tubercle bacillus exists in the blood as evidence of miliary tuberculosis. But in this disease we may lack this proof. With the exception of one case observed by Jacksch, it always occurs quite isolated. A special treatment is required for obtaining this microbe. We arrange a thin layer of blood upon the glass cover just as we do a preparation of sputum (see Sputum).

Typhus abdominalis bacilli have in several cases been found in the

blood as short (one-third the diameter of the red corpuscle), thick clubs, rounded at the end. See examination of the Stools (for staining, see below).

The *bacilli of glanders* are, in general, a little longer than the preceding, but considerably slimmer. They have likewise been found a number of times in the blood of this disease. It is necessary to stain them (see below).

[Since the publication of the first edition of this work the *plasmodium malarie* (Laveran) has been studied by many observers (Marchiafava, Celli, Canalis, v. Jaksch, Osler, Shattuck, Doek, and many others). All concur in stating that certain organisms are found in the blood in every genuine case of malarial fever. Doubtful cases can be differentiated by examining the blood for them, and a positive diagnosis made from their absence or presence. Corresponding with the different clinical features of malarial fevers, there are found three different types of malarial parasites: those of tertian, of quartan, and of the atypical and irregular fevers.] They are protoplasmic bodies, within [and without] the red corpuscles, which can be stained by methylene-blue. No cultures of them have yet been obtained.

The greatest care and cleanliness are necessary in arranging a preparation of blood for microscopic examination for microorganisms, although the minutiae of disinfection and sterilization, as in preparing for culture, are not required. In malignant pustule and *febris recurrens* staining can be dispensed with. When it is necessary to stain a preparation, it is prepared by drying a small drop of blood which has been spread out and made as thin as possible by pressing two covers together. Then they are separated, allowed to dry in the air, and afterward passed two or three times through the flame of a spirit-lamp or a Bunsen's burner. If, now, we wish to examine for tubercle bacilli, a special treatment is necessary, as has already been described under Sputum. For other microorganisms we stain with basic aniline colors (vesuvine, fuchsine, particularly methylene-blue, etc.), and then carefully rinse and examine in water, or, after drying, in Canada balsam. The staining is much more beautiful if we first briefly dip them in gentian-violet-aniline water (see above under Sputum), and then stain them a few minutes in Gram's iodine-iodide-of-potassium solution

(iodine 1 part, iodide of potassium 2 parts, aq. destil. 300 parts), then in absolute alcohol.

Finally, we briefly refer to two animal parasites which are met with in the blood, though they do not belong in this book: the *filaria sanguinis hominis*, which causes hæmatochyluria (in British India and Brazil), generally only found in the blood at night-time, and *distoma hæmatobium* (Bilharz), which causes a kind of hæmaturia, chiefly occurring in Egypt. (See under Urine.)

FIG. 80.



Distoma hæmatobium with eggs.
(After JAKSCH.)

FIG. 81.

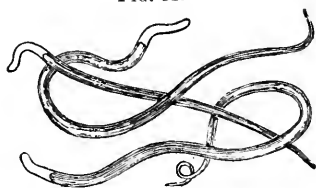

Filaria sanguinis hominis.
(After JAKSCH.)

CHEMICAL EXAMINATION OF THE BLOOD.—We content ourselves with a few hints regarding this department, since it lies almost entirely outside of the limits of diagnosis.

Recently, in certain diseases, the degree of alkalescence of freshly-drawn blood has been determined by various methods, and it has been found that in severe anæmia, fever, and diabetes (Jaksch) the alkalescence is considerably diminished. Uric acid in unusual quantity has been found in the blood in gout.

The quickness with which blood coagulates after it has been withdrawn varies in different diseases. In health, coagulation takes place in about nine minutes. It is slower than this where the nutrition is chronically disturbed. (H. Vierordt.)

CHAPTER VI.

EXAMINATION OF THE DIGESTIVE APPARATUS.

MOUTH, PALATE, AND PHARYNGEAL CAVITY.

THE inspection of these parts requires good illumination, and for a portion of them, in many cases, a quick view. Bright daylight is better than artificial light. The mouth is to be opened widely, the tongue protruded, and not only put out, but, for inspecting its borders, turned from side to side. (For examining it with reference to paralysis, see Nervous System.) In order to inspect the mucous membrane of the mouth, we turn out the upper and lower lips with the finger, the mouth being closed; then, the mouth being opened, we carefully lift the mucous membrane of the cheeks from the back teeth with a mouth-spatula (made of ivory, hard rubber, horn, or metal). The gums are examined by opening the mouth as widely as possible and holding the tongue down carefully with a tongue-depressor (a teaspoon serves very well). The back of the mouth is best brought into view by having the patient say distinctly “æ” (full elevation of the soft palate).

The patient should be required to drink some water, also to clear the throat thoroughly before it is examined. If we meet with opposition, especially in children, it is sometimes necessary to hold the nose, and thus compel them to open the mouth. When a child cries, we are able to see very well. It is often useful to cause the sensation of strangling by putting the tongue-depressor far back, and thus we are able to see the tonsils better—of course, only for an instant. [One learns, by practice, to take a very perfect and complete view of the whole cavity of the mouth and pharynx in this instant of strangulation, and then can carry the mental picture long enough to note all its particulars.]

But we must guard against being too harsh or rough with children with *diphtheria*, or with any very sick patient. In *diphtheria*, imme-

diate death may follow an effort at examining the throat. With those who are unconscious, it is necessary to cause gagging in order to inspect the posterior part of the mouth. In marked cases of this character, it is often impossible to obtain a view at all.

Palpation is only rarely employed for examining the tongue, floor of the mouth (making counter-pressure from without), the tonsils, or the back part of the pharynx. We employ the index, or this and the middle fingers, which have been carefully washed in the presence of the patient.

The odor from the mouth is, in many cases, important. A foul odor—*fætor ex ore*—results from imperfect cleansing of the teeth, caries of the teeth, or dyspepsia. From this odor we distinguish the stale, and at the same time foul, fetor from considerable old deposit in the mouth of patients who are very ill. If the sense of smell is acute, one can also distinguish a slight cadaveric odor upon patients who are very sick, even if the mouth is quite clean, and sometimes it precedes death.

Of much more diagnostic value are the different odors which we meet with in poisoning from prussic acid, phosphorus, alcohol, and chloroform; but the two former, even in recent cases, may possibly be wanting. Lastly, we mention the odor of fruit, wrongly called “acetone” odor, very like fresh apples, which sometimes occurs with the so-called chloride of iron reaction of the urine (see) in diabetes, especially before or during the onset of diabetic coma.

The lips. With regard to their color (pale, cyanosed, etc.), we can refer to what has already been said when speaking of the mucous membrane. Dryness of the lips is seen in connection with dryness of the tongue (which see). There is marked dryness in severe febrile diseases, with a dirty looking crust adherent to the mucous membrane, which easily bleeds when this is removed (fuliginous deposit). Small cracks (rhagades, crevices) are, in themselves, without significance. On the contrary, in children, rhagades are an important, generally a positive, sign of hereditary syphilis.

The teeth and gums. We must take both into consideration, and, besides, as to whether the teeth are sound. In small children we notice whether the first teeth have all come; in the later years of childhood, the change to the permanent set.

There is often marked caries of the teeth in *diabetes mellitus*,

though it is very common without this disease. A circular excavation of the lower edge of the upper middle incisor teeth of the second dentition [Hutchinson's teeth] is usually a positive, almost pathognomonic, sign of congenital *sypphilis* (with catarrh of the middle-ear and parenchymatous keratitis, the whole forming the infallible Hutchinson's triad). Imperfect and diseased teeth, interfering with mastication, are often the chief cause of dyspepsia.

Loosening of the teeth, and the gums discolored bluish-red, receding from the teeth, easily bleeding, and even inflamed, are important symptoms of *scorbutus*. Loose teeth, with moderate swelling, is a sign of chronic poisoning with mercury.

A grayish deposit upon the teeth, and a gray line along the dental border of the gums, results from chronic lead-poisoning. In poisoning by copper, we have sometimes the same condition, only the color is greener.

The eruption of the first teeth is a source of much disturbance in the mouth of the little patients. Occasionally it gives rise to serious disturbances—diarrhœa in rare cases, epileptiform attacks (eclampsia of children, infantile convulsions, spasms of dentition), also spasm of the glottis. Second dentition and the eruption of the wisdom-teeth are not infrequently accompanied with limited or general oral disturbances, sometimes likewise the cause of abscess. To the red border upon the gum, observed by Frédéricq-Thompson, which in young subjects is said to be a very suspicious sign of tuberculosis, we have given careful attention for a long time, and conclude that it has no significance.

The tongue. For paralysis and neurotic atrophy of the tongue, see under the Nervous System.

Enlargement of the tongue, if slight, is only to be determined from the indentations on its borders by the lower teeth. This occurs with the various forms of *stomatitis*. Marked enlargement of the tongue may be caused by parenchymatous glossitis, tumors, and also by severe angina, which produce venous engorgement of the tongue. Moreover, there are very great individual variations in the size of the tongue.

Circumscribed swelling and hardness, or the latter alone, are the first evidences of carcinomatous or syphilitic formations of the tongue. It is extremely difficult to make the very important differential diag-

nosis between these new growths, and usually it can only be made by microscopically examining a small piece, which can easily be removed from it. (See, regarding this, in works upon surgery.)

Wounds and the resulting scars, sometimes accompanied with swelling, are frequent appearances after epileptic attacks, and result from biting the tongue (see Scars). We never see the tongue bitten in *hystero-epilepsy*.

If the tongue trembles when it is protruded, or if it does so when within the mouth, it is a valuable sign of chronic *alcoholism*. This is also the case in severe fevers, and especially early in typhus abdominalis [typhoid fever]. In these cases, when there is marked herbetude, the patient often will not draw in his tongue after protruding it unless he is directed to do so.

The color of the tongue is affected by that of the blood: cyanosis affords the most marked instance of this. It is quite common to find local redness with febrile conditions. It often goes side by side with the febrile redness of the cheeks. Mulberry tongue is one in which there is a decided redness with swelling of the papillæ, and is an important sign of scarlet fever, which, in individual cases, may develop before the cutaneous eruption. Very often the coating of the tongue conceals the color of the mucous membrane.

When the saliva is glutinous or diminished it causes the tongue to be sticky or dry. In connection with dryness of the throat, febrile diseases cause thirst. When the fever is very high, the dryness is often increased by the patient keeping his mouth constantly open. Then the surface of the tongue, if free from coating, first becomes horny, then quickly very smooth, and soon rough and cracked.

Coating of the tongue, as a thin white layer, is often constant in health. When a tongue which previously was clean becomes coated, especially if thickly coated, it indicates dyspepsia. There is very marked coating of the tongue in severe acute and chronic diseases of the stomach and with the dyspepsia of fever. With the latter, it is often discolored brownish-red from small hemorrhages of the mucous membrane. When there is great dryness of the tongue, it becomes crusty and adheres so closely that when removed the mucous membrane bleeds. Articles of diet may cause temporary coating, or they may color the coating that is already there (milk, cocoa, coffee, etc.).

A thick white—often, also, a discolored—coating on the tongue may depend upon the development of *thrush* (*Oidium albicans*). In

very pronounced cases it forms separate small tufts about the size of a millet-seed which spread out and coalesce. It is cheesy and tolerably adherent. It may cover the surface of the tongue, the soft and hard palate, the mucous membrane of the cheeks; it may even extend down into the œsophagus; occasionally, we see the whole surface of the mouth and throat covered with it. Small children have it quite often; adults only in cases of severe illness when the care of the mouth is neglected, especially in fevers, diabetes, tuberculosis, etc. Whenever there is a thick coating in the mouth we must think of this growth, because its early recognition is very important. The diagnosis is promptly made by the aid of the microscope (see below).

For scars from biting of the tongue during an attack of epilepsy, see above under Wounds. Dense, often depressed, scars upon the surface of the tongue indicate healed syphilitic ulcers.

When there is a suspicion of *syphilis*, the mucous membrane of the mouth must be examined with the greatest care (scars, ulcers [mucous patches]); also, when there is a possibility of poisoning with strong mineral acids or alkalies, corrosive sublimate, carbolic acid (superficial gray color and under it marked injection of the mucous membrane, raw patches).

It may also be the seat of *catarrhal ulcers* as well as of the development of thrush (see above). *Cancerum oris* (Noma) usually begins with a circumscribed bluish-black discoloration of the mucous membrane of the cheek or an ulcer with this condition around it and with a thick, inflammatory infiltration of the cheek. It is a kind of spontaneous gangrene with a decided reactive inflammation in poor, wasting children. It is a rare disease.

We examine the floor of the mouth by palpation from within and without. It may be the seat of very dangerous inflammation (angina Ludwigii).

Salivary glands and saliva. Of the former we notice only the parotid gland. When it is inflamed there are pain and swelling, and if it proceeds to the formation of an abscess, there are also redness and fluctuation above the angle of the jaw.

The saliva is increased (salivation, ptyalism) by all kinds of irritation that affect the mucous membrane of the mouth: physiologically by eating, pathologically by all inflammatory conditions of the mouth (ulcers, inflammation of the gums in connection with affections of the

teeth, dental abscess, etc.; corrosive action of acids, alkalies in the mouth and throat); also, in chronic mercurial poisoning, and, lastly, sometimes in disease of the medulla oblongata (see Bulbar Paralysis). The saliva is diminished in febrile diseases, in diabetes, in severe diarrhœa (cholera). Thus far the chemical examination of the saliva has been of no diagnostic value. It is of interest that in *nephritis* it may contain urea, and also that thus far there has never been discovered in it any coloring matter from the bile nor any sugar. Many substances, like iodide of potassium, after they have entered the stomach appear remarkably quickly in the saliva.

Microscopic examination of the contents of the mouth. Normally we find flat epithelial cells from the upper layer of the mucous membrane of the mouth, separate white blood-corpuscles, and likewise micrococci, bacilli, and spirochæta (especially a microbe like the cholera bacillus and one like the *recurrens* spirilla). Among these microorganisms, no doubt, there are some which may become pathogenic for the individuals in whom they occur. In the coating of the teeth we find these microorganisms very abundantly, and besides the *leptothrix buccalis* (long bacilli, often forming long threads, which are colored blue-red by iodide of potassium, see Fig. 82).

FIG. 82.

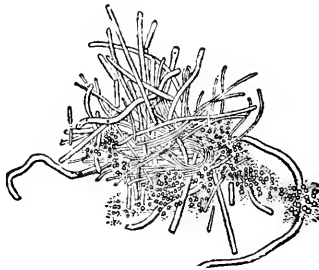

Leptothrix buccalis, 1000 : 1 (after FLÜGGE).

There is an unusually large quantity of the different schizomycetes, especially cocci, in any case where the contents of the mouth are decomposed (*scorbutus*, severe chronic *mercurial poisoning*, in any severe disease where there is difficulty in swallowing, especially if the mouth is not carefully cleaned). We also usually find an abundance of red and also white blood-corpuscles.

In the common white coating of the tongue there are abundant flat epithelial cells and fungi; these, together with a quantity of brown detritus, as well as red corpuscles, are found in the coating when discolored.

It is easy to recognize the thrush fungus under the microscope by the characteristic, tolerably broad, light fungus-threads (they are more than half as broad as a white blood-corpuscle) and by their roundish-oval, clear granules.

Suppurations in the mouth proceeding from the inferior maxilla are, in rare cases, caused by actinomyces. Whenever there is a discharge of pus into the mouth we must remember the characteristic granules (see p. 175; Microscopic Examination, see p. 189).

Of the *soft palate*, we are chiefly interested in the tonsils. We take note of their size and the appearance of their surface. Large tonsils with deep, empty lacunæ indicate frequent attacks of *tonsillitis*; prominent white scars, *sypphilis*. If active disease be present, we are to notice whether there are plugs in the lacunæ (*follicular tonsillitis*); whether there is a deposit upon the tonsils, and, in case there is, whether it is confined only to the tonsils and lacunæ (in both cases, *angina necrotica*); whether it extends over upon the arches (diphtheria); whether it is loose or adherent, testing it with the spatula, and whether we find beneath it a necrosis of the tonsil going on. *Diphtheria* may cause a deposit upon the arches of the pharynx, the uvula, all of the soft palate, and even a part of the hard palate. We recognize an abscess of the tonsil by its [usually] being on one side only, with swelling of the anterior arch, by the fluctuation (which is felt with the finger). Long-continued ulcers of the tonsils and soft palate are generally syphilitic; more rarely, tubercular. In the latter case there is often a broad, reticulated, purulent discoloration of the mucous membrane, which reminds one of slightly-inflamed pleura covered with a fine fibrinous exudate. (Paralysis of the Throat, see Nervous System.)

In the pharynx, we look for possible chronic or acute inflammation and ulcers; in children who, for some unknown reason, swallow badly and have distress in breathing, for possible swelling of the posterior pharyngeal wall (retropharyngeal abscess, the fluctuation in which may be detected by palpation).

We must always examine the *lymphatic glands* in the neck in con-

nection with the examination of the throat. In all acute inflammations of the latter they swell, most markedly in diphtheria, also in chronic inflammations, especially syphilis.

In diseases of the palate and pharynx the microscope gives very little assistance. It is chiefly useful in tuberculosis. When there is a suspicion of a tubercular ulcer, we scrape a little directly from the surface of the ulcer, but yet we cannot be certain that we have not taken some tubercular sputum which has adhered there. Long-standing plugs from lacunæ (often quite free from irritation) frequently contain leptothrix (pharyngomycosis leptothricia). The important differential diagnosis between *diphtheria* and *benign necrosis* of the tonsils cannot, with our present knowledge, be made by the aid of the microscope.

Pharyngomycosis leptothricia (algoris faucium leptothricia) may, as has been observed in individual cases, extend from the tonsils, particularly to the follicular glands at the root of the tongue, or even still further into the trachea itself. They manifest themselves as a number of distinct, elevated, yellowish-white specks. The nature of these deposits is easily recognized under the microscope, especially after the addition of iodine (see preceding page).

EXAMINATION OF THE ŒSOPHAGUS.

Preliminary anatomical remarks: The œsophagus begins at the level of the cricoid cartilage of the larynx (= the lower border of the sixth cervical vertebra), and extends to the stomach, at about the height of the base of the xiphoid process. At first it lies immediately in front of the vertebræ, then it comes a little forward, and, at about the seventh dorsal vertebra, it bends a little to the right, then again to the left, to reach the œsophageal opening in the diaphragm. In adults, the œsophagus is about twenty-five cm. long. When we employ an œsophageal sound, we estimate the distance from the incisor teeth to the stomach at about seventeen cm., in the newly born, while with adults it is about forty cm. In the latter, the distance from the incisor teeth to the bifurcation of the trachea is about twenty-two cm. The œsophagus does not have the same diameter throughout: its narrowest points are at the commencement, and the point where it perforates the diaphragm. The neighboring organs with which it has

important relations in different diseases are: the trachea for the upper seven to eight cm. of the œsophagus, the bronchial glands, the pleura, the pericardium, the aorta from the bifurcation of the trachea downward, lastly, the recurrent nerve from the bifurcation upward. It is only in the neck that the œsophagus can be felt from without. Below the neck, we cannot employ the usual methods of examination.

Characteristic difficulties almost always occur with certain diseases of this organ, namely, with those conditions which result in *stenosis* (stricture): there are more or less deeply-seated difficulties in swallowing; the patient, after taking food, has a feeling of pressure, or even of pain, in the neck or the chest—a feeling that what has been taken cannot be passed down. According to the place or degree of the stenosis, the patient experiences difficulty only after taking large, slightly comminuted bites of food, or even after swallowing soup or fluids, either immediately after the former or only after many bites or swallows. Moreover, the food may be regurgitated, wholly or in part, some time after it has been taken. Then we distinguish it from vomiting by the absence of odor, of acid reaction, and of muriatic acid. Pain in swallowing, without stenosis, occurs with inflammation of the mucous membrane of the œsophagus or in its near neighborhood (mediastinum).

Examination of the œsophagus is almost confined to direct palpation from within by means of the sound, excepting that, in the cervical portion, we can employ inspection and palpation from without. Auscultation furnishes little, percussion no, aid. But it is very important in many cases to examine the neighborhood, particularly the thorax.

Only in exceptional cases do inspection and palpation of the cervical portion yield any result, because the great majority of diseases of the œsophagus are located quite below the bifurcation of the trachea. We can feel a *carcinom* of the cervical portion (likewise swelling of the glands of the neck), we can feel, and often also see, pulsating diverticula when they are full—that is, after the patient has eaten. Carcinoma of the lower end of the œsophagus can be felt from the abdomen, if the cardiac end of the stomach is encroached upon. *Pain* from pressure in the neck occurs in the conditions above named and in inflammations, as after swallowing acids and alkalies.

DIRECT PALPATION; EXAMINATION WITH THE SOUND.—For diagnostic sounding of the œsophagus we employ either a whalebone or English œsophageal sound. The former consists of a thin staff with an olive-shaped ivory knob screwed upon one end. We have knobs of different sizes, in order to determine and measure the degree of the stenosis (see below). Before using, we are to make certain that the bulb is secure upon the staff, and also that the staff is perfectly smooth, so as not to catch anywhere and thus mislead us. This sound furnishes the most positive information, and yet it requires the greatest dexterity and caution in using it. The English œsophageal sound is a cylindrical India-rubber tube, tolerably stiff when cold, with its end slightly smaller and closed, but having two openings at the side. Before using, it must be somewhat softened by dipping it in warm water. We must have at hand several such sounds of different sizes. The end should always be rounded and perfectly smooth, so as not to produce a rupture.

Before introducing it, we are to moisten only the knob of the whalebone sound, but the whole of the English sound with glycerin or white-of-egg (not with olive oil, nor with water). The patient sits upon a chair or the edge of the bed with the chin somewhat elevated. The index and middle fingers of the left hand are introduced into the mouth, and with them we slowly feel as far as the root of the tongue. Then we seize the sound with the right hand, like a pen-holder, and slowly push it along the tongue under the two fingers. As soon as it passes beyond the ends of the fingers, we press its end somewhat downward with the tip of the fingers, and at the same time elevate the right hand, so that the sound may not strike against the back of the throat. The sound is then with gentle pressure pushed on, always holding it as if writing. The left hand is now withdrawn.

Special precautionary measures, such as placing a cork between the teeth, or anything to hold the jaw, are usually not necessary, since this operation is not performed upon unwilling or unconscious patients (see Sounding the Stomach). Only with children are we sometimes obliged to use the cork. Many patients bear a skilfully-performed sounding very well, but others can only become accustomed to it from considering its beneficial results. If the motions of strangling are not severe, we need not be disturbed by them, but if there is vomiting we must at once withdraw the sound in order that there may

be no choking. A slight spasm of the glottis and momentary arrest of breathing have no significance, yet attention is called to the second paragraph below.

We sometimes meet with a resistance which is not pathological: 1. At the posterior wall of the throat, but only with unskilful introduction of the sound (see above). 2. Sometimes, if the cricoid cartilage of the larynx overlaps the œsophagus somewhat, from the point of the sound striking against it; this is easily passed by withdrawing it a little, and then pushing it on again. 3. By spasm of the œsophagus, caused by the sound, which disappears soon by waiting.

Two occurrences may endanger the life of a patient: 1. The introduction of the sound into the trachea, which very rarely happens. At any rate, as soon as there is marked difficulty in breathing the sound is to be withdrawn. If the patient is able to pronounce "a" clearly, moreover, if the portion of the sound introduced is longer than the trachea, then we know that it has not entered the trachea. Other signs are deceptive. 2. A still greater danger is that the wall of the œsophagus may be injured or ruptured. This results from narrowing of the canal, if it has become thin and fragile from a crumbling new formation, or by an ulceration, or when an abscess or aneurism near the œsophagus is thus perforated. The results of these are either ichorous mediastinus or pleurisy with fatal termination, or if an aneurism, with immediately fatal hemorrhage. We must never employ force if the sound meets with resistance. If we can confirm the suspicion of an aneurism by examining the chest, we are always to omit using the sound.

Examination with the sound gives information in the following ways:

1. Sometimes a deep-seated pain occurs after the examination has been made several times, although the sound has only been introduced a certain distance. It may depend upon inflammation in that neighborhood (for determining its height, see under "Stenosis"), upon an ulcer, a carcinoma not causing stenosis, a purulent œsophagitis, or periœsophagitis.

2. The sound meets with resistance. Then the patient, in many cases, is sensible of pressure, or has a sensation of pain; sometimes there is severe strangulation. We move the sound back and forth, and endeavor to advance it with very slight pressure. We mount a smaller knob upon the whalebone sound, or take a thinner rubber one. But

the smaller the sound the greater the danger, and hence greater caution is required in using it.

If we are at length able to advance it further, then we feel resistance just so long as the knob is in the stenosed portion. After passing the narrowed part, it again passes easily, but, of course, meets with resistance at the same point as it is withdrawn.

We obtain information regarding the *situation* of a stricture, by bearing in mind the rules given when referring to the anatomy of the parts. We introduce the sound as far as the stenosis, note the location, starting from the incisor teeth (by seizing the sound accurately with the fingers), draw it out and measure it.

Regarding the *degree* and *length* of the stenosis: we learn the former by the thickness of the sound that will just pass the stricture; the *length* of the stricture will best be ascertained by employing whale-bone sounds, in that we can mark the place where the incisor teeth touch the sound when it enters the stenosis, and as it passes through the stenosis. Also, if there is a double stenosis, it is indicated (see Fig. 83).

We can learn almost nothing regarding the nature of the stenosis, unless we should catch in the fenestrum of an India-rubber sound a shred of tissue which would enable us to diagnose a carcinoma, or unless we should meet with the condition described in the next section (3).

FIG. 83.

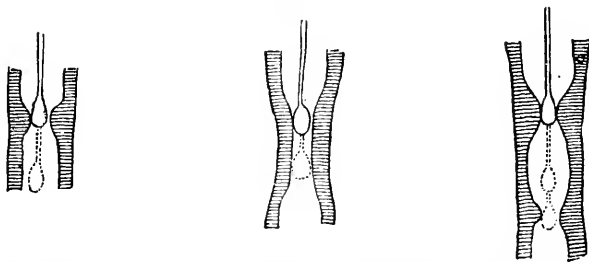

Diagrammatic representation of sounding the œsophagus when there is a short, long, and a double stenosis.

3. By repeated introductions of the sound, we are sometimes able to pass it through, but if again we meet with an insuperable obstruction we must be very careful: this points to a diverticulum, though

not indeed with absolute certainty, since it may be met with in other kinds of stenosis.

4. In a case of stenosis which we have repeatedly examined, we suddenly find ourselves unable to get the smallest sound through, where it has frequently passed easily. This may indicate an *obstruction* by a foreign body, as was the case in one instance under my observation, which ended fatally, where a cherry stone was found in the stenosis.

5. The end of the sound may meet with opposition upon one side and not upon the other. This indicates a *dilatation* of the œsophagus (generally above the stenosis).

Stenosis may be caused by *scars* resulting from swallowing a corrosive fluid some time before (Anamnesis), or by *carcinoma* of the œsophagus, or by *diverticula* (see above under 3); these are generally high up in the œsophagus; or by *compression* of the œsophagus. Congenital stenosis (difficulty in swallowing from birth), and stenosis caused

by *thrush*, are both very rare.

Examination of the neighborhood of the œsophagus, that is of the neck and thorax, is of the greatest importance. We are thus able to discover compressing tumors, or to exclude them with probability. We may aid the diagnosis by giving attention to the larynx, and observing whether there is a recurrent paralysis, which may exist even though the voice be quite clear. Compression of the recurrent nerve sometimes occurs in carcinoma of the œsophagus, with aneurism of the aorta (particularly the left nerve). Moreover, we take into consideration the examination of the chest, especially whenever there is any evidence of a rupture, as in pleuritis, gangrene of the lungs, rupture into the trachea or bronchus, with coughing up of particles of food; pericarditis, and emphysema of the skin (see).

Percussion of the œsophagus itself can be of almost no aid. Large diverticula in the neck may show dullness, provided they are full. Exceptionally, a dilatation above a stenosis in the thoracic portion may, if full, also produce dullness.

FIG. 84.

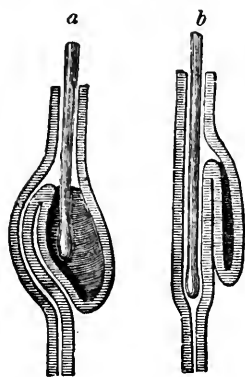

a. Sounding the œsophagus when the diverticulum is full; b. sounding when the diverticulum is empty.

Auscultation of the œsophagus is of very subordinate value. It can be employed as far as to the seventh thoracic vertebra at the left of the spine, in examining the lower part of the œsophagus; or we may listen over the spine or to the right of it. In health, when fluids are being swallowed, we can hear a gurgling in the whole extent of the œsophagus. When there is stenosis, we sometimes notice that the gurgling ceases just at that point. The sounds of swallowing which we hear at the stomach are less certain signs than this phenomenon; in health, there is sometimes heard a sound six or seven seconds after an act of swallowing, as of something being pressed through, and sometimes preceding this is a sound of squirting (Kronecker and Meltzer, B. Fränkel).

Œsophagoscopy (illuminating the œsophagus with an electric light) has not yet attained a position as a recognized method of examination.

EXAMINATION OF THE STOMACH.

Topography of the abdomen. This is represented in the accompanying figure. We form the different sections by prolonging the mammillary lines (or a line which passes from the middle of Poupart's ligament upon each side); also by lines which, in the upright position, are drawn through the ends of the eleventh ribs, and through the anterior superior spines of the ilei. By these latter lines, the section lying between the mammillary lines is divided into the epigastrium, mesogastrium, and hypogastrium. It is further to be added that the region, directly over Poupart's ligament, which extends inward toward the symphysis pubis, and outward somewhat over the middle of the ligament, is called the inguinal region, and the territory below the ends of the ribs, the hypochondrium. So far as the abdominal contents are parietal, their relations to the separate regions of the abdomen are plainly indicated in the accompanying figure.

ANATOMY OF THE STOMACH.

Only a little more than the pyloric portion [one-sixth] of the stomach lies in the right half of the body, the rest [five-sixths] being on the left of the median line. It slopes obliquely from the left downward toward the right, so that the cardia is about behind the

sternal insertion of the seventh rib, the pylorus between the right sternal and parasternal lines, on a level with the apex of the xiphoid cartilage. The fundus—the portion situated the highest, clinging to the left side of the dome of the diaphragm—rises as high as the fourth

FIG. 85.

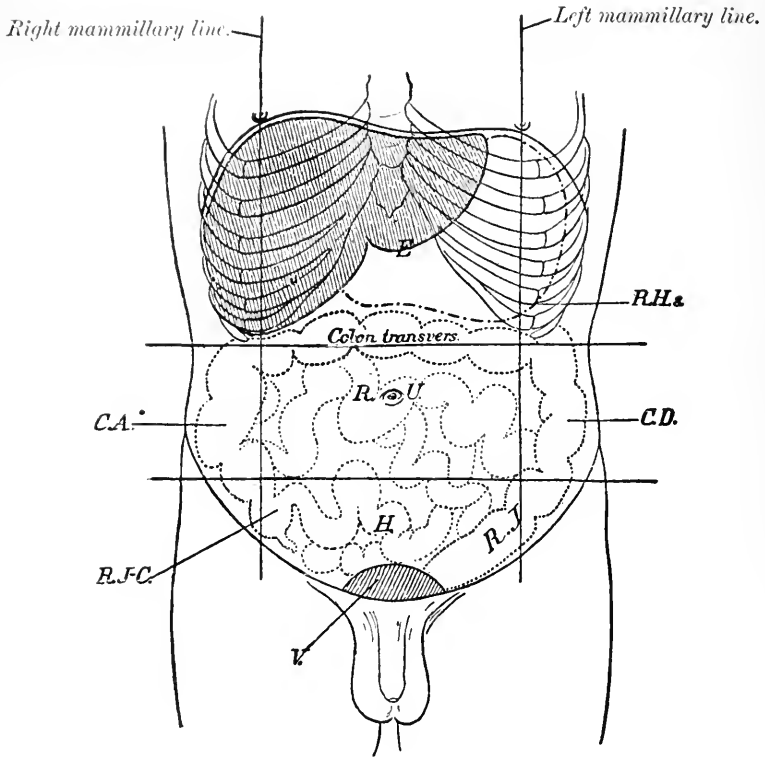

Position of the abdominal contents.

CA. Ascending colon. *CD.* Descending colon. *RJ-C.* Ileocecal region. *RJ.* Inguinal region. *RHS.* Left hypochondrium. *EE.* Epigastrium. *RU.* Umbilical region. *H.* Hypogastrum.

intercostal space. The lesser curvature forms a bow with its convexity arranged obliquely downward toward the left. It, with the cardia and pylorus, which it connects, lies more posteriorly, covered by the liver, while the greater curvature extends forward toward the abdominal wall; so that a line drawn from the lowest point of the

lesser, to the lowest point of the greater, curvature would incline forward and downward. The situation of the greater curvature varies very much with the degree of distention of the stomach. In health, it only very exceptionally extends to the umbilicus.

The fundus of the stomach is adjacent to the diaphragm, the spleen, and the left kidney; its greater curvature, and also the lower part of its posterior surface, to the transverse colon; the pylorus, lesser curvature, and that portion of its anterior surface which is near to these, to the left lobe of the liver. Behind and above the stomach, situated at the upper part of its posterior surface, is the sinus of the peritoneal cavity, the bursa omentalis (pathologically not unimportant), and also the pancreas.

When the stomach is moderately distended, a part of the anterior surface, and the greater curvature, are parietal, so far as they are not prevented by the lung or heart from above, or by the spleen on the left, and by the left lobe of the liver on the right. That part of the parietal surface of the stomach which is covered by the left lower portion of the ribs comprises the important region to which Traube gave the name of "halfmoon-shaped space." We see from this description that, with moderate distention, only a small part of the healthy stomach can be directly examined. The most important parts, the cardia and pylorus, are bent deeply in. But we have a favorable moment for examining the latter in certain pathological conditions, where it is desirable to be able to judge of it, it being often pushed down with the lesser curvature below the liver.

INSPECTION AND PALPATION OF THE STOMACH.

There is scarcely any place where inspection and palpation are so closely connected as at the abdomen, and especially the stomach. The patient is placed so as to lie comfortably, with the upper portion of the body moderately raised. We look at the region of the stomach with the greatest care, illuminating it from all possible directions; then palpate with the tips of the first, second, and third fingers, and thus notice first the tenderness (always at first proceeding very cautiously), then the objective condition, finally completing the palpation with inspection, or *vice versâ*.

The result of the two methods of examination will be affected by

several factors—by the size, sharpness of the boundaries, and density (resistance) which we discover in the abdominal wall, and its condition. As regards the latter, it is important for the examiner to avoid causing contraction of the abdominal muscles, by having the patient in the recumbent posture, cautioning him to keep the muscles lax, and by proceeding slowly with the palpation, the hands being warmed. Contraction of the recti abdominis, with their short tumor-like sections of muscle, may very much disturb, or even deceive, one in making an examination. As to the general thickness of the abdominal walls in chronic diseases of the stomach, especially if very severe, this is very much lessened by wasting—a condition favorable for making an examination.

The normal stomach cannot at all distinctly be recognized or defined through the abdominal wall. It can only exceptionally be done when there is extreme emaciation.

I remember two cases where, in extremely wasted females with very lax walls, the greater curvature and peristalsis of the anterior wall of the stomach could be clearly seen. In both cases the stomach was very slightly distended, and in both cases the autopsy showed a normal condition of the stomach.

On the other hand, the healthy stomach, distended with food or gas, sometimes enables us to imagine its condition by the projection in the epigastrium, and still more by a high halfmoon-shaped space—that is, by tympanitic resonance over the left lower lobe of the lung in the side (see under Percussion). We can sharply bound a healthy stomach only in individual cases when it is inflated with gas (see method of procedure, p. 301). Thus, it has been found that the greater curvature of a normal stomach, when very greatly distended, may reach as far as the umbilicus. Of course, we cannot ascertain the location of the lesser curvature. Moreover, the distensibility of the healthy stomach varies very much with different persons, so that on trial one person earlier, and another later, has difficulty, especially oppression, which marks the limit of distention.

The chief pathological signs furnished by the stomach are, its distention or displacement, its thickness, and amount of peristaltic action of its walls, also signs of circumscribed tumors in its walls. Other important signs are to be added to those already mentioned. Pain upon pressure during palpation requires a special description.

Distention is more or less distinctly made out by inspection and palpation, according to its extent and the thinness of the abdominal walls. But it may also entirely elude examination. In favorable cases, we can see and feel (easily when looking down from the patient's head) the greater curvature. To a varying extent it moves down, often below the umbilicus, more rarely nearly to the symphysis, and in so doing it shows the bend toward the left. The position of the greater curvature, of course, varies with the degree of fulness of the stomach, but usually, unless artificially emptied, as by emesis or the stomach-pump, it does not come up above the umbilicus. Thus, the pyloric portion behaves peculiarly, in that it influences the situation of the stomach and renders the pylorus, as well as the lesser curvature accessible for examination. When the stomach is, for the time being, distended by a large quantity of food, in the upright position of the patient, it pulls the pylorus forward from under the liver, and with it, under some circumstances, the lesser curvature. This, in rare cases, is seen in the upper epigastrium, in a line convex downward (when the light falls from the foot of the bed), when it may even be felt. Also the *portio pylorica*, and the pylorus itself, may be felt (see under Tumors). In consequence of this displacement of the pylorus, the whole stomach slopes more strongly downward toward the right.

In rare cases, the pylorus stands as low down, without there being any dilatation of the stomach. The condition is congenital, or caused by strong adhesions (Kussmaul).

As has already been mentioned, the distinctness with which the figure of the stomach can be made out is largely influenced by the extent of its fulness. Hence, for the purpose of making the examination, we must artificially distend it (Frerichs). Until very recently, this was always done with carbonic acid, by giving the patient as much as two teaspoonfuls of tartaric acid and bicarbonate of soda dissolved in a little water. The gas quickly develops in the stomach, and demonstrates clearly the situation and size of the organ, rendering the examination of its walls easy (see under Peristalsis and Hypertrophy). But this procedure sometimes gives rise to a feeling of oppression, and even of symptoms of collapse; and recently there has been devised a method of inflating the stomach which is much more to be recommended, because the amount of gas for distending the

stomach can be regulated exactly, and, if necessary, it can be emptied out in an instant. A Nélaton stomach-sound is introduced (just as in sounding the œsophagus), and then the stomach is inflated with air through the sound by means of an India-rubber ball, introducing as much as is necessary, or as the patient can bear. At any time the air can immediately be let out through the sound.

By inflating the stomach, Eichhorst has several times easily recognized the so-called *hour-glass stomach* (twice it was formed by a scar which strictured it in the middle). In the same way, we can discover that the pylorus does not close, by the fact that the gas blown in does not distend the stomach, but immediately enters the small intestine.

Ziemssen still gives the preference to distention with carbonic acid. In his last communication he gives the proportions for adult men as seven grammes of bicarbonate of soda and six grammes of tartaric acid, for adult women, one gramme less of each.

The sound may be employed in the same way as with the œsophagus to determine stenosis at the cardia, due to cancer. (The employment of an English œsophageal sound for ascertaining the size of the stomach [Leube] requires the greatest caution. The sound is introduced into the stomach and pushed on until it meets resistance at the greater curvature, and then we ascertain where the end of the sound is by palpation from without.)

Regarding palpation by striking and the resulting splashing, see under Auscultation. In the neighborhood of the stomach we may have epigastric pulsation (see p. 204), liver-pulse (see p. 266), lastly it may be communicated from the aorta or from aneurism of the abdominal aorta. With tumors of the stomach, the pulsation from the aorta is usually very distinctly transmitted.

Increased resistance; peristaltic motions. The former occurs simultaneously with the general distention of the stomach in consequence of the hypertrophy of the muscular portion, which generally accompanies dilatation of the stomach. Hence, it is an indirect sign of dilatation.

If it is found within a limited area, as in the right half of the epigastrium, even if it is not sharply defined, it may indicate carcinoma. We must be careful not to confound it with contraction of one of the bellies of the rectus abdominis. Peristaltic motions which can be felt as well as seen are very important, being often the first signs of

a hypertrophy, and, thus, a dilatation. By their situation and extent, they may also indicate the size of the stomach. It is very rare for them to occur without dilatation—in nervous “peristaltic unrest” of the stomach (Kussmaul). Generally it extends in the normal direction from the fundus to the pyloric region. But sometimes it is reversed (marked pyloric stenosis, Kussmaul)—antiperistalsis. It will often be excited or increased by gentle strokes, and by faradization; sometimes by irritation of the skin, as by simply uncovering it. With very lean persons, we must think of the possibility of it being, under some conditions, intestinal peristalsis.

Tumors in the region of the stomach are often only to be felt, not seen. They cannot be demonstrated if connected with a part of the stomach that is not parietal: cardia, lesser curvature, posterior wall of the stomach, commencing cancer of the pylorus. These tumors are most frequently cancer of the stomach (more rarely a dense scar from ulcer), and are most often located to the right of the middle line, because they belong to the portio pylorica or to the pylorus itself. In the latter case, they can generally only be felt when the pylorus is pushed downward, as has already been mentioned. Carcinoma usually feels uneven and dense. Less frequently it is smooth, and can then easily be overlooked, or be mistaken for a belly of the rectus (see above, under Resistance). Projection of the stomach during deep breathing, as a result of the movements of the diaphragm, usually does not take place at all, for the reason that the stomach is not a solid body. We observe a slight, or possibly a marked, respiratory displacement when there is adhesion of the distended pylorus and the liver (see), or if there is a tumor which extends from the subphrenic region to a parietal portion of the stomach. Dense scars from ulcers and the infrequent hypertrophy of the pylorus, also solid bodies that have been swallowed, may feel like tumors. Mistaking them for scybala in the transverse colon (see Intestine) is not likely to happen.

In all diseases of the stomach, pain upon pressure during palpation may be wanting. It is absent least frequently with ulcer of the stomach. If there is pain, it may vary very much: in acute catarrh of the stomach, also sometimes in chronic, it is dull and quite diffuse; with ulcer, it is often very much circumscribed, limited to a spot the size of a dime, extremely severe, often shooting through to the back

(especially toward the left); in carcinoma, there is sometimes a marked insensibility, sometimes a more diffuse, sometimes a narrowly-defined, pain of various intensity.

PERCUSSION OF THE STOMACH.

This applies to that portion of the anterior wall of the stomach which lies against the abdomen and the anterior (left lower) wall of the thorax. It yields, in much the greater majority of cases, a very deep tympanitic sound; and sometimes, when there is marked tension

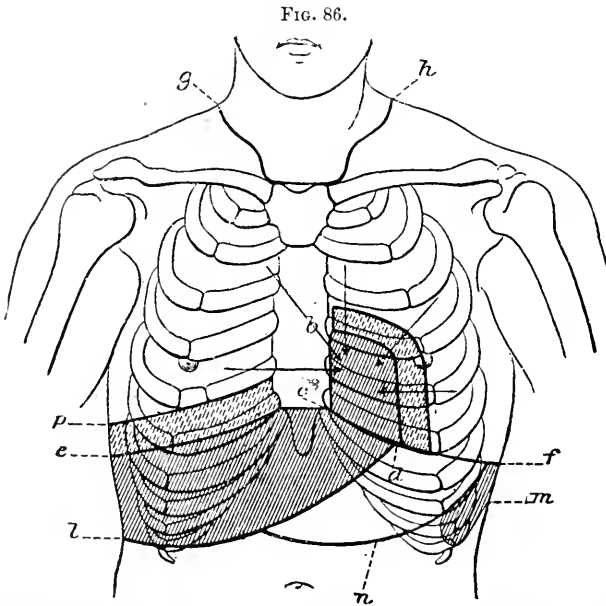

Percussion boundary of the lungs in front. (WELL.) *g, h*, the upper boundary of the lungs; *c, f*, the lower boundary of the lungs; *b, d*, boundary between the lung and heart at the incisura cardiaca. The dark hatched surface represents the portions of the heart and liver that are in contact with the chest-wall; the light hatching, the so-called relative heart- and liver deadness (see later). *m*, spleen-deadness; *n*, the average position of the lower boundary of the stomach.

of the stomach, a clear non-tympanitic sound. If the stomach contains a considerable amount of food it may, in part (especially in standing), have an absolutely dull sound. But we hardly ever find it dull throughout the whole extent of that portion of the stomach that

is parietal, because it almost always contains considerable gas as well as food. The tympanitic, as well as the non-tympanitic, stomach-sound frequently has a metallic quality.

The boundaries of the stomach are determined by topographical percussion (see Fig. 86).

On the side toward the liver, there is a dull sound; it is often difficult to make out, because the border of the liver is thin (see Percussion of the Liver). On the side toward the lung, there is a non-tympanitic, clear sound. Here it is often difficult to mark sharply the boundary line, on account of the thinness of the border of the lung and the similarity of the two sounds.

Sometimes we have to distinguish a boundary of the stomach from the heart, should its apex reach further toward the left than the liver; sometimes from the spleen, if the stomach should be stretched out somewhat. We can separate it from the large and small intestine, both of which give a tympanitic sound.

Except these last named, the boundary lines are all dependent upon the situation and size of the surrounding organs. Therefore, and because there are no true boundary lines for the stomach, except its parietal boundaries, we do not employ percussion for the stomach. The only real boundary is that on the side toward the intestine, which gives the situation of the greater curvature.

But it is almost always very difficult to determine this line (there being a tympanitic sound on both sides of it, with only a difference in pitch). We can hardly even maintain its correctness without the aid of inspection and palpation. Thus, percussion of the stomach, for the great majority of cases, has an extremely doubtful value.

On the whole, we get the best results from percussion in health, and particularly when the stomach has been artificially dilated. With the former, we then find that the greater curvature usually is somewhat above the umbilicus, sometimes reaching to it. When the stomach is moderately full, it commonly stands about midway between the apex of the xiphoid process and the umbilicus. If the stomach is dilated, the boundary is lower down (see Inspection, Palpation). Likewise, should the lesser curvature be lower down, it can be made out by the aid of percussion.

Another procedure, but one which is not always successful, is first to empty the stomach as much as possible (see Emesis), then to percuss

the abdomen, the patient being in the standing position. Usually we do not find any boundary for the stomach. Then we have the patient drink freely, and again percuss while he is standing. In the lower part of the stomach, hence above the greater curvature, about in the middle line, we shall find a dulness which indicates the situation of the greater curvature, and thus a possible dilatation may be recognized (modified after Penzoldt). This dulness may sometimes be directly proved, without any preliminary procedure, if the stomach is partly filled with fluid. The dulness disappears when the patient lies down.

There is distinct dulness with tumors of the stomach (strong percussion) only when they are very thick, and this is not often the case. Hence they usually give stomach-resonance. But tumors of the liver and spleen, on the other hand, almost always are dull because they are larger. Yet this difference is not an entirely sure sign.

Rod-pleximeter-percussion (see p. 136) over the stomach usually gives a beautiful silver tone. It is employed for determining the boundary, under the supposition that in this way the person who is listening over the stomach must hear the high silver tone just so long as his assistant percusses over the stomach; but the result of this procedure is hardly ever positive enough to give it value.

That part of the left lower lobe of the lung is designated as the "circular stomach-lung space," where a tympanitic sound may be heard with strong percussion (Ferber). We may likewise speak of a "circular stomach-liver space," sometimes even of a "stomach-heart space" (see page 206). None of these have any value for determining the size of the stomach.

THE HALF-MOON-SHAPED SPACE (TRAUBE).—It is that portion of the lower left part of the thorax which lies below the lung (or heart) between the liver and spleen, and, as a rule, in health gives a tympanitic sound, most frequently a stomach sound, but not infrequently also an intestinal sound, or both. It is discovered by gentle percussion. Occasionally, in health, we here find dulness instead of tympanites, and then only when the stomach is decidedly full, or when the full transverse colon is here parietal, or when the greater omentum is unusually loaded with fat (Weil).

In *enlargement of the liver*, of the left heart, and of the spleen, this space will always be found correspondingly smaller. But its behavior in certain conditions of the left lung, or of the left pleura, is

of especial diagnostic interest. Exudation in the left pleura usually causes dulness correspondingly early in the upper portion of this space, in that it first collects in the complementary pleural sinus. As the exudation increases, the half-moon-shaped space diminishes more and more, the dulness sometimes extending as far as the bend of the ribs, depending upon the amount of downward pressure of the diaphragm (unless there are pleuritic adhesions in the pleural sinus, in which case we do not have the space diminished). As the pleuritic exudation is absorbed, the space resumes its normal proportions, and if there is shrinking after the absorption, it becomes greater than normal, for the reason that the lower border of the lungs does not again come down to its former place, and, on the other hand, the diaphragm stands higher. Rarely, with *pneumonia* of the whole left lung, or its lower lobe, the half-moon-shaped space becomes very slightly smaller, as a result of the enlargement of the lung during hepatization, and also, probably, from a small pleuritic exudation.

It is to be observed that in an acute disease of the left half of the chest, an early distinct diminution of the half-moon-shaped space is made manifest by a certain degree of dulness; a marked diminution of the space indicates very plainly a pleuritic exudation; and if there is extensive dulness in the left half of the chest, if the differential diagnosis between pneumonia and pleurisy is uncertain (see p. 158), then a decided diminution in the size of the space speaks with strong emphasis in favor of the latter.

AUSCULTATION OF THE STOMACH.

This has value in only one direction, but that is not to be undervalued. When palpation is made by strokes upon the region of the stomach, striking more or less strongly, according to the sensibility of the patient, very short blows with the tips of the fingers, we sometimes hear a splashing which is loud enough to be heard at a distance. This results from a certain relation between the fluid and the gas in the stomach even in health, but very much more frequently in dilatation. Hence, in making a careful examination of the stomach, we must always employ it. In itself it does not indicate anything, even though it is often found when the examination is frequently repeated.

If we apply the ear when the stomach is inflated with carbonic acid

we shall hear a loud seething. We can recognize the same thing, but less distinctly, in dilatation of the stomach with fermentation of its contents.

It is evident from the above that very often anatomical diseases of the stomach exist without any physical signs. This is almost always the case in the different forms of *nervous dyspepsia*, which are accompanied with marked subjective symptoms. Hence, in most cases of affection of the stomach, the examination of its contents gives much more important conclusions than the local examination. Therefore, especial attention is called to the former.

EXAMINATION OF THE INTESTINES.

INSPECTION AND PALPATION.

In employing the former, there must of course be illumination. The patient being in the dorsal position, we inspect the trunk as a whole, from a distance; in detail, close at hand, palpating with a warm hand. Then, carefully grasping a part, we notice always first as to the amount of tenderness, when, if there is any suspicion of simulation or exaggeration, it is best not to ask whether we are causing pain, but simply to notice the result of a moderate and also stronger pressure. After completing the first examination, which gives one the bearings of the case, inspection and palpation go very closely, hand in hand, together; for this reason, we speak of them together.

Pain produced by pressure [Tenderness]. A diffuse dull pain often occurs with *intestinal catarrh*. A like diffuse, but generally an extremely severe, pain is observed with acute general *peritonitis*. Circumscribed tenderness is especially frequent in the right iliac fossa. It is often quite marked in *abdominal typhus* [typhoid fever], often more severe in *intestinal tuberculosis*, moderately severe in *typhlitis* and affections of the vermiform appendix, in both the last-named diseases generally (not always), in connection with other local signs (which see). Pain in the left iliac fossa is connected with the descending colon (especially dysentery). Very circumscribed severe pain shifting about, may occur with a circumscribed affection of the small intestine, as invagination (see Palpation, Intestinal Tuberculosis). The seats of hernia

require very especial attention. (Works upon surgery are to be consulted regarding these). It is to be further remarked that pain in the abdomen, according to its location, may come from any of the organs contained in its cavity, and also from its walls; from the anterior abdominal wall (abscess); pain in the inguinal region, from psoas abscess in the iliac regions, from the sacral spines (inflammation, tumors).

The general extent of the abdomen may be increased by a layer of fat, by gas in the intestines (intestinal meteorism, tympanites), as it occurs continually, scarcely pathologically, after hearty eating, often with a large development of fat; but we may also have it in every variety of degree as a pathological condition: in acute and chronic catarrh of the intestine, intestinal stenosis, in acute and chronic peritonitis, and in abdominal typhus [typhoid fever], where it is often of diagnostic value. According to the amount of distention, the abdomen is more or less full, which changes its normal soft condition to one of marked resistance. When there is marked meteorism, the liver and diaphragm are pressed upon, and by the latter the lungs and heart are pressed upward.

In a case of typhus abdominalis [typhoid fever] I once saw an extensive inflammatory undermining of the abdominal wall, which very closely simulated meteorism by considerably distending the abdomen, which proved to be an abscess in the abdominal muscle. For distention of the abdomen with fluid and air in the peritoneal sac, see Peritoneum.

There may be circumscribed distention of the abdomen from a great variety of causes: most frequently from some condition in the peritoneum (which see, and also the next page under Tumors).

Diminished volume of the abdomen (drawing-in, sinking-in) results from an insufficient amount of nourishment from any cause (especially from diseases of the œsophagus, pyloric stenosis, any cachexia—in short, from any disease that requires, or results, in restricted diet. Usually this condition is more especially manifested by the absence of fat and wasting of the abdominal muscles. A particularly marked—the so-called “scaphoid”—drawing-in, probably related to an active contraction of the abdominal muscles, occurs in meningitis, particularly basilar, and in lead-colic.

Intestinal peristalsis exceptionally can be seen when the abdominal wall is very thin and lax. It occurs almost exclusively in women

who have had children (particularly if there is a separation of the recti muscles). It is to be distinguished from its similarity to what is described as pathological peristalsis only by the absence of other phenomena, and by the narrowness of the intestinal figure.

Peristalsis that is pathological is an important visible and palpable sign of stenosis of the intestine, and occurs in the portion of intestine above the stenosis. We observe a round projection, with the slow motions of a worm, now disappearing and often immediately reappearing in a spot not far distant, so that we have the phenomenon of peristalsis. The intestine, as it becomes prominent, is moderately resistant, and is often distinctly distended. [During the instant of greatest distention the prominence is more distinctly tympanitic.] The resistance may become greater in chronic stenosis of the intestine with hypertrophy. Sometimes the last swelling—that is, the one just above the point of stenosis—is the largest, and subsides with a loud cooing or bursting sound. This phenomenon may have a very great variety of manifestations, generally with a pressing, choking pain, and it may manifest itself under gentle blows, with faradization, or even by merely exposing the surface to the air. It is usually very difficult to draw any conclusion regarding the portion of the intestine involved by the location of the phenomenon or the direction of the peristalsis. On account of its thickness, we are apt to mistake a dilated loop of small intestine for a portion of the colon.

Circumscribed *tumors of the intestine* are always felt before they can be seen. They may be: 1. Balls of feces, scybala, in the large intestine, often recognized by being arranged in a circular form, by their location (which is often deceptive), or by their retaining an indentation. Sometimes we are only able to be positive regarding their nature by their disappearance after free purgation. 2. Tumors of the intestine are either new formations, which are generally very firm, uneven, or, from invagination of one portion of the small intestine into another or into the large intestine, which are round vermiform tumors. The former are entirely fixed, the latter may suddenly disappear. Both may be connected with signs of stenosis of the intestine. If they belong to the small intestine, they usually more or less change their location. (For distinguishing these tumors from those of the other abdominal organs, of the peritoneum, and of the abdominal wall, see below. For inflammatory tumors of the intestine, perityphlitis, etc., see Peritoneum.)

Tumors of the rectum cannot be recognized from the abdomen (see for these, below). Those at the point of union between the transverse and the descending colon are often recognized late, because they lie concealed. They may easily be confounded with tumors of the spleen or with the kidneys (which see). In this connection we must bear in mind the phenomena of stenosis. (For peritoneal friction-sounds, see Peritoneum; for cooing-sounds that can be felt, see Auscultation of the Intestine.)

Palpation of the rectum. The rectum must be examined with the finger if the movement of the bowels or the character of the stools indicate disease of this organ, or if disease in the neighborhood (as the wall of the true pelvis, the prostate in men, the uterus and its annexæ in women) is suspected. In making the examination, we first obtain a view of the anus externally (as to varices, pedunculated new formations, which sometimes come into view at the anus from above the flexure, an external rectal fistula). Sometimes it is also necessary to obtain a thorough emptying of the bowel beforehand. The index-finger is to be oiled and introduced with the patient either lying on the side or back. (For examining during narcosis by introducing the whole hand, see works upon surgery.) When the rectal sound is employed, in order to reach a stenosis beyond the reach of the finger, the greatest care is necessary. It is best to employ a sound open at the end, so as to throw in some lukewarm water by means of an irrigator, so that any obstruction to the passing of the sound may be gotten out of the way. Sometimes a large quantity of water is thus employed, as recommended by Hegar (see also the works upon surgery for the employment of the mirror in making the examination).

Distending the descending colon by inflating it with air introduced from the anus through the sound, if carefully done, is not dangerous, and is very strongly recommended for determining the location of the colon with reference to other organs, tumors (see spleen, kidneys), the figure and condition of the colon itself.

PERCUSSION OF THE INTESTINE.

Generally the intestine gives a tympanitic sound; with meteorism with great tension, it may become clear non-tympanitic. Over large intestinal loops, and also over the stomach (with like tension), the sound is

deeper than over narrow portions; over lax portions, it is deeper than over those under strong tension. But we can hardly ever determine as to the width of any portion of intestine by the resonance, chiefly because of the influence of tension, which, for a single loop of intestine, we cannot at all control. Hence, we cannot with certainty determine by percussion the boundary between the colon and small intestine, a dilatation above a stenosis from another portion, or intestine from the stomach. At most, we can only determine the boundary of the descending colon by artificially inflating it.

(For determining by percussion the boundaries of the abdominal organs that do not contain air, see under the different ones.) Intestinal tumors do not always become so large as to give dulness. In percussing them, we first press tolerably deeply with the finger used as pleximeter, and if we do not find dulness we press still deeper, in order that we may push aside any fold of intestine that may lie over the tumor ("deep percussion," Weil).

AUSCULTATION OF THE INTESTINE.

Borborygmi and splashings, which may often be heard at a distance, and are in themselves very troublesome (especially in women who have had children), do not have any further significance. A loud cooing is not without diagnostic value, if it occurs at the close of an attack of pain like strangulation. Even if we cannot see any intestinal peristalsis, we must remember the possibility of stenosis of the intestine. Although formerly too much importance was attached to it, yet there is some diagnostic value in the cooing, which is more frequently felt than seen in the ileo-cæcal region in typhoid fever (ileo-cæcal gurgling).

EXAMINATION OF THE PERITONEUM.

Pathological conditions of the peritoneum are, in part, of such a character that they affect the outer layers, the coverings of the other abdominal viscera, hence possible anomalies of the peritoneum may be overlooked in the direct examination. Thus, very many diseases of other abdominal organs are combined with those of the peritoneum. This fact and the anatomical interrelations of the diaphragm and certain other organs make it very difficult to give a separate descrip-

tion of its physical diagnosis. In what follows we mention what may be learned in peritoneal diseases by the separate methods of examination, but we call attention to the point that the examiner ought to learn to give his attention to all the abdominal organs, by inspection, palpation, etc., at the same time.

INSPECTION OF THE ABDOMEN.

In diseases of the peritoneum, this may reveal distention of the abdomen, which may be quite considerable, and quite like intestinal meteorism. *Meteorismus peritonei*—that is, escape of air into the abdominal cavity from the intestine or stomach—is a very serious condition, which always results in peritonitis. (See below.)

There is general, though often unequal, distention when there is freely-movable fluid in the peritoneal cavity: *ascites*. Such a fluid effusion collects in the most dependent part of the abdominal cavity, first in the true pelvis; then, as the amount increases, it rises higher, reaching the abdominal wall, where its level may stand at different heights. The abdominal organs that contain air float upon the top of the fluid so far as the peritoneal fold permits. In consequence of the increased internal pressure, the abdomen is broader, and the lower part contains the fluid, while the intestine, containing air, lies at the upper part, and is in contact with the abdominal wall. But the fluid, since it is freely movable, occupies always the most dependent part with every change of position of the body, and, if the tension of the abdominal wall is not too great, there often results an unequal distention of the abdomen which varies with the position of the body. In the dorsal position, it is quite toward the sides; when lying upon the side, it is over the inguinal and lumbar regions upon each side; while in the sitting posture, it fills the dependent abdominal sides, the upper portions being empty; and in standing, the lower part of the abdomen projects. If there is so large an effusion as to fill the abdomen very full there is no change in the distention, and it is also more regular, like that we have with marked meteorism. (Regarding the high position of the diaphragm, when there is distention of the abdomen, see Respiratory Organs and Liver.)

If the skin is examined when there is marked effusion it will not at all look as it usually does: on account of the tension, it is smooth,

shining, and shows, especially in the dependent parts, a peculiar bluish shimmer. When the tension is of long standing, there are colorless streaks or striæ which are formed in the skin by the continuous stretching, as in the scars resulting from pregnancy, so-called from their chief cause. The umbilicus may be obliterated or even project. In marked *ascites*, the cutaneous veins of the abdomen are found enlarged, since, as collateral veins, they must take up the overflow of the intra-abdominal veins, which are compressed. Under some circumstances, there may be œdema of the legs from compression of the iliac veins. (Regarding the *caput medusæ* and the abdominal veins in general in cirrhosis of the liver, see under Liver.)

Ascites that moves about generally results from transudation into the abdominal cavity from stasis, being rarely, except in the beginning of a disease, dependent upon inflammatory exudations. In the former case, it is either a partial indication of general dropsy, and connected with œdema (see), or entirely the result of obstruction of the portal vein (cirrhosis of the liver, compression, and thrombosis of the vein). In the latter case it is a sign of peritonitis. (See under Palpation, Percussion.)

Circumscribed distention of the abdomen, where there has been little or no change in posture, may be due to inflammatory fluid exudations, which are enclosed between adhesions of the intestine to itself or the abdominal wall, or by any kind of tumor in the abdominal cavity; and also by tumors or abscess in the abdominal wall itself. Circumscribed distention, with inflammatory redness, indicates a discharge outward of an abscess, either fecal or some other collection of pus in the abdominal cavity, or of the abdominal wall.

In diseases of the peritoneum, palpation gives very important signs:

Pain in all inflammatory affections. It is usually very severe in acute *peritonitis*, sometimes so great that the slightest motion, or even the lightest covering upon the abdomen, cannot be borne. This sensibility is an important indication of peritonitis, especially in distinguishing the ordinary intestinal meteorism from the intestinal meteorism with peritonitis, sometimes also in distinguishing inflammatory ascites from dropsical ascites. Circumscribed pain may indicate a circumscribed peritonitis, as it occurs more particularly over tumors, abscess of the stomach and intestine. In chronic peritonitis, especially in tuberculosis, sometimes there is entire absence of tenderness.

Now and then, in chronic peritonitis there is a general, more or less symmetrical, hardness of the abdominal wall—that is to say, it feels as if it were thickened. This is to be distinguished from the general increased resistance from tension due to marked distention of the abdomen from meteorism and ascites. Thus, there is a marked difference between the resistance of fluid and that of meteorism in a fold of intestine. The latter has more the feeling of an air-pillow, the former is more like a material substance. But we recognize fluid with much more certainty by the feeling of fluctuation, undulation. A hand is laid flat upon the surface of the abdomen, and then the abdominal wall is tapped lightly with one or two fingers, just as in direct percussion. If both hands are used, fluctuation is found in a place where there is an accumulation of fluid, and the stroke of the wave is felt with every tap of the fingers. In this way the presence of even a small amount of fluid in the abdominal cavity can be made out with great certainty. When there is great effusion under high pressure this sign may fail. On the other hand, we may be deceived in the case of persons who have a large accumulation of fat in the abdomen by the trembling of the layers of fat, and possibly, also, by the fat in the abdominal cavity, in the omentum especially.

Very much increase of resistance, and thus an indistinct fluctuation, generally occurs when the peritoneal fluid is encysted. Circumscribed hard resistance, now like a round ball and again cord-like, occurs with extremely great variations in chronic peritonitis, not alone of the tubercular variety, but also in the so-called simple peritonitis from inflammatory new formations; nevertheless, the former is usually the much more frequent condition. Particularly often in this, although sometimes also in simple chronic peritonitis, we feel above the navel a dense transverse string: the omentum is shrunken and thickened by inflammatory products. Besides there are usually, but not always, the signs of encysted or even of free fluid in the peritoneal cavity. Exactly the same phenomena are present in carcinoma and sarcoma of the peritoneum.

There occurs in an acute way resistance in the neighborhood of the cæcum in *typhlitis* and *perityphlitis*. Here there is generally a circumscribed globular, or flattened globular, tumor, usually immovable, which, at first at least, is extremely tender. It indicates a fixed mass of feces in the cæcum, or an inflammatory deposit upon the serous side

of the cæcum, or both. In inflammatory cases, there remains for a long time, or even permanently after recovery, a dense spot (a scar from shrunken inflammatory new formation in the peritoneum). In inflammation of the vermiform appendix, we can seldom affirm that there is a tumor.

Palpation of the peritoneum through the vagina in order to discover whether there are tumors, exudations in Douglas's space and anywhere in the neighborhood of the uterus, especially the different forms of peritonitis, belongs to gynecology. It is not necessary to measure the circumference of the abdomen for establishing a diagnosis, but yet it is valuable for the purpose of observing the course of an abdominal affection, and particularly for ascertaining the increase and diminution of fluid exudations. It is generally sufficient to measure the abdominal circumference across the navel and the lower lumbar vertebræ. It is better also to measure the distance between the xiphoid process and the symphysis pubis.

Percussion gives valuable information regarding the peritoneum, as to whether there is fluid effusion in the peritoneal cavity, its location and nature. By percussing with some force at what we suppose to be the boundary line, we can easily determine the boundary between the dulness of fluid and the tympanitic resonance of the intestine; but we can never distinguish it from that of those organs that do not contain air, as the liver, spleen, etc. The superior surface of a freely-movable effusion is always horizontal, and hence its upper boundary line must correspond to a section of a horizontal plane drawn through the abdomen, in whatever position the patient may assume. Whenever the patient changes his position, immediately the effusion changes its relations to the abdominal cavity (see above, under Inspection). Hence the result of percussion changes with the position of the body: if the patient lies upon the right side, then the portion of the abdomen which is now lowest gives a deadened sound, while the upper boundary is horizontal; in the left half of the cavity, there is tympanitic resonance: if the patient turns upon the left side, this is now dull, and the right is tympanitic. This is an important sign, not only that the fluid is movable, but often that there is fluid present. Small effusions, which rarely rise only a little above the pelvis, will hence be first recognized by percussing when the patient stands upright. If there is then dulness above the symphysis pubis, it immediately disappears

when the patient lies upon the back. Very large effusions may fill the abdomen so full that the intestines, on account of a short mesentery, cannot float, and hence cannot come in contact with the abdominal wall. Then the strongly-distended abdomen gives a dull sound throughout, and we sometimes notice a change of the boundary of dullness only in the position on the side, when the upper portion gives a clear sound.

When the fluid moves about with difficulty, slowly and incompletely changing its location with the change of position of the body, and still more if it is entirely immovable, *inflammatory exudation* with glueing or adhesion of the intestines together and to the abdominal wall is indicated. If the fluid does not move it is said to be encysted. But not infrequently even inflammatory exudation, at least in the beginning of its effusion, is freely movable.

Percussion may be an important aid in recognizing *meteorismus peritonei* in so far that in many cases, if adhesions have not already been formed before the occurrence of perforation, it gives a perfectly uniform tympanitic or, if the tension is great, a non-tympanitic sound over the whole abdomen, also over the region of the liver and spleen, and besides, on account of the diaphragm being arched high up, as far as the fifth, or even the fourth, rib. Not infrequently in this way we obtain Heubner's rod-pleximeter phenomenon (see p. 112).

Subphrenic peritonitis, pyopneumothorax subphrenicus (Leyden), subphrenic abscess. We understand by this an ichorous-purulent, sacculated peritonitis below the diaphragm. From paralysis (partly also from destruction), the diaphragm is pushed very high into the thorax, causing a marked retraction or compression of the lung of that side. That half of the thorax is broadened, and by the presence of pus and gas in the cavity, one is apt to mistake the condition for pyopneumothorax. Peritonitis of this character usually begins at the stomach as an ulcer, or at the intestine, especially at the vermiform appendix and cæcum. In making a differential diagnosis, we observe whether, in the *status præsens* or in the previous development, there were indications of disease of the lungs or, on the other hand, of the abdomen, and also whether the lung of the diseased side still performs the motions of respiration. During puncture, it has frequently been found that the pressure rises during inspiration in a subphrenic cavity,

while it falls, of course, in a pleural cavity. This can be recognized by the varying rapidity of discharge from the aperture made by the needle, or by introducing a manometer into the cavity.

The presence of air which has escaped into the peritoneal cavity is shown in many cases by the clear, metallic ringing, intestinal sound in the upper part of the abdominal cavity, sometimes even a metallic, transmitted breathing sound, which it yields to auscultation. Moreover, with the inflammatory deposits upon the reduplications of the peritoneum, especially over the liver and spleen, there occurs synchronously with breathing a peritoneal friction sound, exactly corresponding to the pleuritic friction sound. It is very rarely produced by peristalsis over the intestines. If the friction sound is pronounced, it can also be felt.

When it is advisable, as a therapeutic measure, to draw off fluid from the peritoneal cavity by puncture, it may be of diagnostic value in two ways :

1. It is then possible to examine the organs in the abdominal cavity, which previously were concealed by the ascites. Not only does the fluid prevent the examination of the organs more or less completely covered by it, but the folds of the intestine floating upon it also do so, in that they crowd in between certain parts, especially the liver and spleen, and the anterior abdominal wall. When the abdomen has been emptied, its wall, which before was tensely stretched, is very lax, and this renders the examination extremely easy. Hence we can now usually very easily discover the diseases which caused the effusion (cirrhosis of the liver, tumors, which press upon the portal vein ; cancer of the stomach, ovarian tumor, etc.), or certain results of peritonitis (bands of scar tissue, which compress the intestine, swollen mesentery, etc.).

2. The fluid that has been drawn off can be examined. It is as important to do this as to examine pleural fluid (which see, p. 160).

The ordinary hypodermic syringe, holding one gramme—not the one recommended for puncturing the pleura—is to be employed for puncturing the abdomen.

Exploratory puncture, by means of a large hypodermic syringe, is useful in distinguishing encysted peritoneal fluid from the solid and fluid contents of certain tumors (see Abdominal Tumors).

Chylous ascites has been observed in some cases of compression of

the thoracic duct; the ascitic fluid is, to a varying extent, milk-like in appearance. It contains molecules of fat and a ferment that forms sugar.

EXAMINATION OF THE LIVER.

ANATOMY.—The liver, covered by the peritoneum, lies close to the diaphragm—within its arch—and is held in place by the suspensory ligament and by the intra-abdominal pressure exerted upon its lower

FIG. 87.

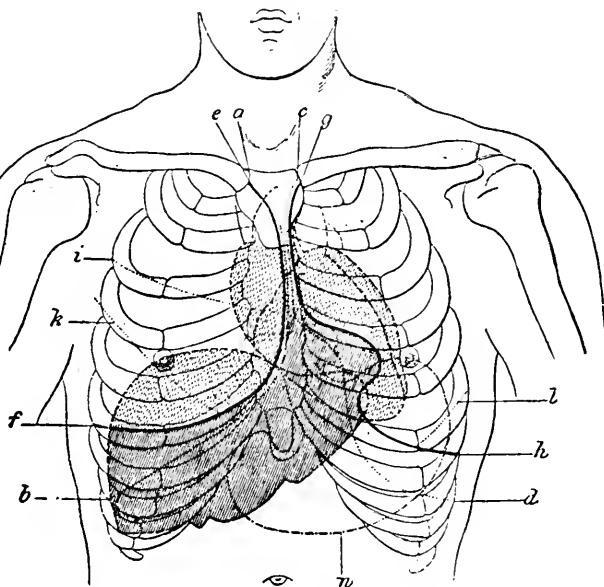

Location of the thoracic contents, of the stomach, and of the liver, from in front. (WEIL-LUSCHKA.) The unbroken hatched lines represent the portions of the heart and liver that are in contact with the thoracic wall. The portions of these organs that are not in parietal contact and are covered by the lungs are represented by the light hatching. *ef* (—), border of the right lung; *gh* (—), border of the left lung; *ab*, and *cd* (. . .), boundary of the complementary pleural sinus; *i*, boundary between the upper and middle lobes of the right lung; *k*, boundary between the middle and lower lobes; *l*, boundary between the upper and lower lobes of the left lung; *w*, stomach (greater curvature).

surface. About three-fourths of it is in the right side of the body, and one-fourth in the left. With reference to its superficial topography, a larger portion of it belongs to the right hypochondrium,

extending into the epigastrium, and with a small portion into the left hypochondrium. Usually it does not extend so far to the left as the apex of the heart. Above, the lungs and heart glide over it, and it glides over the stomach (see Fig. 13, p. 78).

The extent to which its surface is in contact with the thoracic wall is determined by the relation of its upper surface to the diaphragm. Hence, during expiration it rises in the right half of the body as high as the fourth intercostal space, and with its extreme left end to the fifth rib. The lower border, in the scapular and middle axillary line, stands about at the eleventh rib, in the mammillary line, just at the border of the ribs, then proceeds obliquely upward toward the left, through the epigastrium, under the left border of the ribs, and almost to the apex of the heart.

In the middle line, it stands about midway between the xiphoid process and the umbilicus. The gall-bladder lies just where the lower border of the liver passes under the right border of the ribs, hence close within the right mammillary line.

The organs that border upon the liver are the lungs, heart, and the diaphragm above, and the right kidney, colon and stomach below. That portion of its upper convex surface which is not covered by the lungs or heart is parietal. This parietal portion is very small behind. As it comes forward, it is much broader, and is, for the most part, covered by the chest-wall, except in the epigastrium, where it is free from its bony covering.

With children, the liver is in all dimensions proportionally larger, so that its lower border is in the axillary line below the border of the ribs.

Normally, the liver, strictly speaking, only moves in connection with the diaphragm.

INSPECTION OF THE LIVER.

This is made with the body in the dorsal position moderately elevated.

In the healthy condition, in adults, absolutely nothing can be made out. The right and left hypochondriac regions are exactly alike. In small children, we can sometimes notice a moderate projection of the right hypochondrium.

Projection of the right hypochondrium, or also of the epigastrium and the region below the right border of the ribs, indicates enlargement of the liver. This must be pretty well marked, in order to be noticed in this way. Where the thorax is very stiff, the ribs do not usually project; but when the ribs are very flexible (children, young females), where it can relatively easily take place, the projection of the abdominal wall is plainer if the abdomen is a little full and the covering thin.

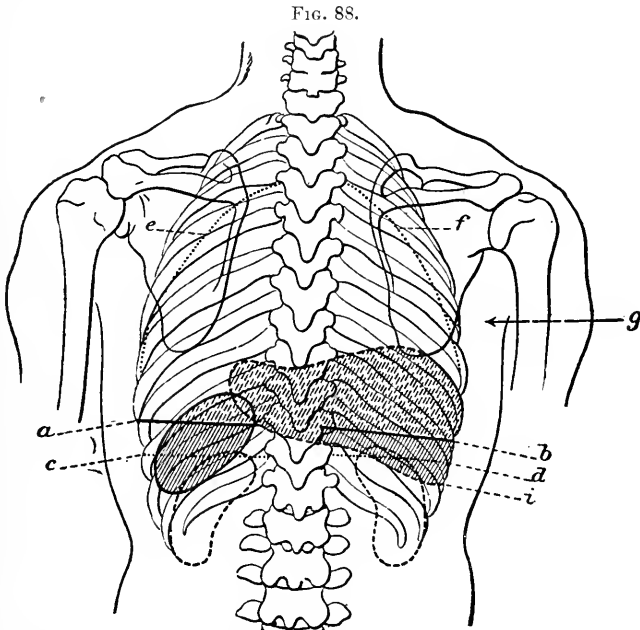

Location of the lungs, liver, spleen, and of the kidneys, from behind. (WEIL-LUSCHKA.) The liver and spleen are represented by the same kind of hatching as in Fig. 87. *ab* (—), lower border of the lungs; *cd* (...), complementary space; *i* (---), border of the liver; *ef* (...), boundary between the upper and lower lobes of the lungs; *g*, boundary between the upper and middle lobes of the right lung.

If the projection is entirely of the portion of the abdomen below the border of the ribs, it points more to a displacement of the liver downward. There may be very marked distention when an enlarged liver is so displaced.

It is very rare to see or to feel the lower border of the liver. But it may be, if, on account of enlargement or displacement, or both, it

is located low down, and if the abdominal wall is thin. We can then also observe how the border of the liver moves downward with the motion of the diaphragm in deep inspiration. For observing this the light must come from the head of the bed.

When the wall is very thin, tumors on the surface of the liver in contact with the abdominal wall, or on the lower surface of the border, and also a distended gall-bladder, can be seen. With deep breathing, they follow the motions of the diaphragm, and they transmit the motions to tumors of the stomach or omentum, which may be adherent to them, or, like them, visible.

Finally, arterial or venous liver-pulse may be visible, especially the latter, which always accompanies enlargement of the liver.

Enlargement of the liver may be dependent upon different diseases of this organ. In engorgement of the liver, especially in mitral defects and in emphysema, in fatty or amyloid liver, or when it is due to obstruction of the gall-bladder, and in diffuse hepatitis, in certain acute infectious diseases, the enlargement of the liver is tolerably uniform, its form being retained. It manifests itself by its lower border moving down into the abdomen, but, on the other hand, the diaphragm is pressed upward only when the liver is very greatly enlarged, or when the general abdominal pressure is increased (especially in ascites). The liver is irregularly enlarged in carcinoma, echinococcus, generally in syphilis, and in abscess. To what extent it is noticeable depends upon the location of the swelling, whether anterior, inferior, or superior, with displacement of the diaphragm.

Downward displacement or dislocation of the liver occurs generally with depression of the diaphragm, with severe emphysema, with pleurisy or pneumothorax of the right side. Left-sided pleurisy or pneumothorax, pericarditis, though generally only to a slight degree, press the point of the left lobe of the liver downward, and thus the lower border of the liver in the epigastrium is horizontal. Moreover, under some circumstances the liver is pressed downward by sub-phrenic abscess (see above), which at the same time pushes up the diaphragm. Lastly, here belongs the "wandering" liver, due to relaxation of the suspensory ligament (occurring in women who have borne children). It is only in the two conditions last named that it is not in contact with the diaphragm.

It is to be observed that the lower border of the liver moves downward not only when it is enlarged, but also when it is displaced. These two conditions will be distinguished chiefly by palpation and percussion, and the consideration of the accompanying conditions of the organs in the chest and abdomen.

Displacement of the liver upward, can, of course only take place when the diaphragm is higher than normal, as in retraction of the lungs, pressure from below, inflammatory or neurotic paralysis of the diaphragm.

PALPATION OF THE LIVER.

In every relation, this is the most important and certain method of examining this organ, and hence must be most diligently practised by the beginner. It is best to have the patient in the dorsal position, and the abdominal wall as relaxed as possible. We first seize, with the warm hands, the whole abdominal sac, have the patient open the mouth and breathe quietly. Drawing up the limbs is of little aid and disturbs the examination. We very frequently make use of deep breathing, because in this way the parts hidden under the ribs move deeper, and the border or any small unevenness, etc., can be felt more distinctly as it moves against the examining fingers; and lastly, because the liver can be distinguished from other organs (kidney, colon, omentum, often stomach, abdominal wall) by its motions during deep breathing. By striking palpation we understand a brusque stroke with the tips of the fingers. We employ it in meteorism and ascites in order to push aside for the moment a layer of intestine lying over the liver or fluid, and thus be able to reach the liver with the tips of the fingers. (See, moreover, what is said on page 318 regarding palpation of the abdomen after puncture.)

Normally, in the adult, with the ordinary thickness of abdominal wall, we can feel scarcely anything of the liver. If there is a thin lax wall (especially in women), we not infrequently feel the edge of the liver in the mammillary line at the border of the ribs, seldom also in the epigastrium, particularly if it is pressed down in deep inspiration. In children it is often very distinct.

For example, we take a condition bordering on the normal, the so-called constricted liver, a disease almost without significance. It occurs in women who have laced themselves very tightly for a long

time. Corresponding to the anatomical condition of the liver, we can feel a tongue-like prolongation of the right lobe, which prolongation is separated from the mass of the liver by a constricting furrow close under the border of the ribs. Sometimes the constricted liver is sensitive on pressure.

In ascertaining the pathological conditions of the liver by palpation a series of points of view come under consideration :

1. The existence of *tenderness*. There is no tenderness with the fatty, amyloid, cirrhotic liver, with echinococcus (if there is no formation of pus), nor engorged liver (infrequent), if it has been for a long time uniformly engorged; the syphilitic liver is usually not tender, but sometimes it is so. Generally, in the beginning of cirrhosis the liver is sensitive, also in biliary engorgement. According to the extent to which the peritoneum is involved, carcinoma of the liver may be entirely without tenderness, or it may be very sensitive, also, when engorgement of the liver has rapidly developed, it may be very tender. When an abscess of the liver is parietal, possibly involving the peritoneum, there is a circumscribed area of great tenderness; with deep-seated abscess, there is no pain. Tenderness of the liver may, besides, be caused by chronic (often tubercular) peritonitis, without there being any trouble with the liver itself.

2. The *size and form*. Depression of the lower border, without change in form, indicates uniform enlargement, but possibly also displacement. Unless there is considerable enlargement, it is often difficult to distinguish between these two conditions. If there is simultaneously tenderness and hardness (see below), or if there are conditions of other organs which make enlargement of the liver probable, as valvular disease of the heart with engorgement, a disease causing an amyloid condition, then we are very seldom wrong in the supposition that there is an enlargement. On the other hand, for example, the existence of pleuritic exudation, *dextra*, etc. (see above), makes displacement more probable. There also may be at the same time enlargement and downward displacement. But it must be remembered that, when a liver is markedly displaced downward, the impression is easily made that it is also enlarged, because, by traction about its transverse axis, it becomes parietal to a larger extent.

When a downward-displaced liver is distinctly movable by pressure with the finger, in such a way that in the dorsal position it can be

brought back to its normal position, then we have a "wandering" liver.

The form of the liver is recognized with varying distinctness, according to the increased extent to which it lies against the abdominal wall, when it may be enlarged. It has already been mentioned under what conditions the liver retains its form. Tumors of all kinds (especially carcinoma, gummata, echinococcus) and scars (syphilis) change its form. Whole portions of the parenchyma of the liver may often, not always, be marked off by the scars of syphilis if they are very deep: "lobulated liver."

3. Again, the *surface of the liver* can be judged by the portion of the upper surface or the lower border which is accessible to palpation, and we can do this best by moving the finger-tips with the abdominal wall back and forth over the liver. In individual cases it is only possible to feel a portion of the lower surface. In *engorgement of the liver*, in fatty liver, in amyloid liver, in a portion of the first stage of cirrhosis, and in the so-called *hypertrophic liver*, the surface will be found to be smooth; also, in echinococcus, carcinoma, and syphilis of the liver, if we palpate a portion entirely free from tumor or scars. Small inequalities, generally to a certain extent uniform over the whole palpable portions of the surface, sometimes so fine that if the abdominal wall is thick it is difficult to feel them, are the characteristic signs of ordinary cirrhosis of the liver (interstitial hepatitis, granulated liver) toward the end of the first stage and into the second. Here, for two reasons, it is usually very difficult to reach the liver with the fingers: first, because in the second stage it is smaller, and hence is to a less extent parietal, and second, because the disease is commonly associated with ascites. For this reason, what has been said regarding "stroking palpation" and examination after puncture, applies especially here. It is further to be remarked that the surface of the liver in chronic, and especially in *tubercular peritonitis*, may feel tuberculated in consequence of inflammatory growths upon the serous coat, and this without there being any cirrhosis (although not infrequently this exists at the same time). Large rough tumors, from the size of a cherry to that of an apple, often mingled with small knots, are the usual appearances with carcinoma of the liver. We can sometimes recognize upon the top of these carcinomatous knots a depression, the cancer navel; but they are of neither positive nor negative diagnostic weight. More

smooth, flat projections, especially if, besides, we can feel scar-like depressions, indicate the presence of syphilitic gummata. *Echinococcus* causes smooth tumors which, according to their location, are flat or elevated, or they may even stand out prominently from the surface of the liver; thus also abscess of the liver causes smooth prominences of different sizes and elevations.

4. The *consistence of the liver* is uniformly, and generally markedly, increased in amyloid disease, engorged liver, and in cirrhosis. Carcinoma manifests itself, as elsewhere, usually by great density. Abscess of the liver and echinococcus bladders may distinctly fluctuate; the latter often, if tightly full, feel dense as well as elastic, and we can sometimes recognize by quick, short strokes of the opposing hands a peculiar whizzing—the *hydatid thrill*.

In many cases exploratory puncture will be indicated, as in order to recognize or exclude echinococcus or abscess. (Regarding the condition when there is echinococcus, particularly of the effects, see pp. 322, 325.) Moreover, it is necessary to compare the results of palpation, in the broad sense of the word, with the accompanying appearances of other organs, which belong to the individual diseases of the liver. These may stand in a causal relation (constitutional syphilis, primary cancer of the stomach, etc.), or they may be results (ascites in cirrhosis of the liver or pressure from tumors, scars of the portal vein, rigors in abscess of the liver, etc.).

The *gall-bladder*. If this is normal, it is only in cases of extreme emaciation that it can occasionally be felt. This is much sooner possible when it is abnormally full of fluid, as in biliary engorgement, *hydrops vesicæ felleæ*, suppuration, or when it is distended with gall-stones. In biliary engorgement and catarrhal icterus it is possible to diminish the gall-bladder by carefully compressing it, and expelling the contents into the ductus choledochus and the duodenum. When there are gall-stones, if the abdominal wall is thin, we sometimes get the distinct impression of a sac filled with angular stones rubbing against one another. A dense, rough tumor indicates *carcinoma* of the gall-bladder.

PERCUSSION OF THE LIVER.

Wherever the liver is in contact with the thoracic or abdominal wall, we, of course, have dulness, and this is an absolutely deadened

sound where the liver receives the whole of the percussion-stroke, and the stroke is not permitted to reach to an underlying air-containing organ, as the intestine or stomach. A relative dulness, with tympanitic associated sound, occurs when a thin layer of liver lies over the stomach or intestine, as is the case in the neighborhood of the lower border of the liver. To a certain extent it depends upon the strength

FIG. 89.

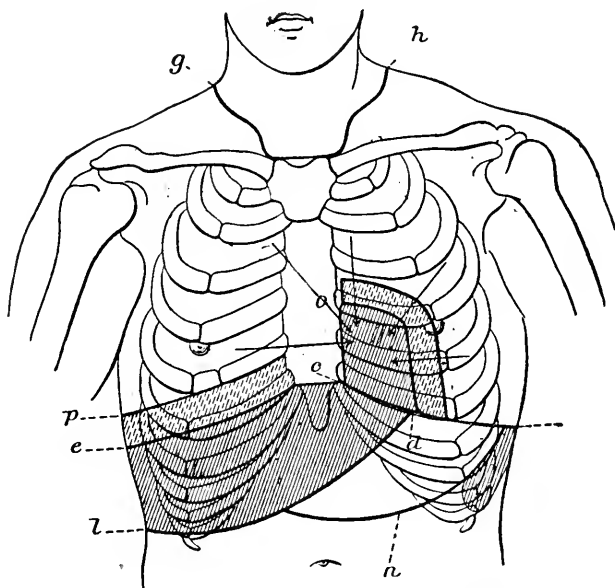

Percussion boundary of the liver in front (WEIL).

g h, the upper limits of the lungs; *e f*, the lower limits of the lungs; *b d*, the boundary between the lung and heart at the incisura cardiaca. The darkly-hatched surface represents the portions of the heart and liver that are in contact with the chest-wall; the light hatching, the so-called relative heart and liver deadness; *m*, spleen deadness; *n*, the average position of the lower border of the stomach.

of the percussion-stroke whether we have a relative or an absolutely deadened sound (see p. 117): the weaker the stroke, the sooner do we have absolute dulness. The varying thickness of the covering of the liver is confusing—consisting partly of ribs and partly of abdominal wall. Still more confusing for exact examination is it that the border of the arch of the ribs, at the most important point in the mammillary line, normally exactly corresponds with the lower border of the liver.

The difference in sound which is caused by this change in the covering alone obscures the exact examination of the liver at this point.

The limits of the liver, so far as they are determined by percussion, are ascertained by gentle percussion at the right lower border of the lung, by the transition from the clear lung-sound (or relative liver-dulness) to the absolutely deadened sound. Thus, the upper boundary of the parietal part of the liver is easily found, with the exception of a small portion, where the liver lies against the heart (see Fig. 87). Here we cannot determine the boundary by percussion, because the heart-dulness and liver-dulness cannot be distinguished. The lower border of the liver near the spine cannot be pointed out, because it joins the kidney (see Fig. 88), but everywhere else its sound could be very easily distinguished from the tympanitic sound of the stomach and intestine if its anterior part were not too sharp—that is, if the liver were not here too thin. For this reason, even with the most gentle percussion in the epigastric region, it is usually found too high. Often no distinct liver-dulness can be perceived in any portion of the epigastrium. Moreover, we must guard against being deceived by the dulness of one of the bellies of the rectus abdominis (lax abdominal wall).

The relative liver-dulness lying above the absolute does not correspond to the anatomical size of the liver, which lies much further back than this, as is shown by a comparison of the anatomical figure with the boundary as determined by percussion. This is because the lung becomes thinner at its lower border; moreover, it is only anteriorly and at the side that it is always distinctly present. It usually fails between the scapular line and the spine, owing to the thick wall and the diminished sharpness of the edge of the lung.

Mode of procedure: We percuss strongly or lightly down a known vertical line on the thorax, for determining the beginning of relative liver-dulness, and thus fix the lung-liver boundary—that is, the transition from the relative to the absolute liver-deadness. Then we percuss downward, through the extent of liver-dulness, until by the gentlest percussion, we get the entirely pure tympanitic sound. From this point we go again upward till we get the first indication of relative dulness. We determine the exact boundary lines by exclusion (see p. 117).

The average boundary-lines of the liver, as determined by percussion, are about as follows :

The upper, the lung-liver boundary : Middle line, base of the ensiform cartilage ; mammillary line, sixth rib ; middle axillary line, eighth rib ; scapular line, tenth rib.

The heart-liver boundary cannot be determined by percussion, but it lies near the apex-beat.

The lower, the liver-stomach (intestine) boundary : Left of the middle line, toward the half-moon-shaped space, ascending obliquely to about the sixth rib in the parasternal line ; middle line, not lower—often higher—than midway between xiphoid process and the umbilicus ; mammillary line, at the bend of the ribs ; middle axillary line, the tenth rib ; scapular line, the eleventh rib.

But from these there is frequently a considerable departure, even normally. Throughout, the lower boundary has been found much higher, this being caused by a fold of intestine lying over the liver and thus diminishing the extent to which it is parietal. This is particularly the case with the ugly, but not pathological, form of the thorax where it is short and its lower aperture is quite wide ; also, in persons who have a full abdomen. In this way the liver-dulness may sometimes be entirely wanting : at the upper boundary of the half-moon-shaped space we pass, in percussing, from lung-sound into tympanitic resonance.

Extreme elevation of the liver-dulness, although very variable within normal limits, is not at all applicable in diagnosis.

Mobility of the boundaries of the liver. In deep breathing, there is a more marked active displacement of the upper boundary (corresponding to the respiratory excursion of the border of the lung) than of the lower, which displacement is the expression of the movement of the dome of the diaphragm. As regards passive movement, we only notice that in the left-side position both boundaries move downward, the upper distinctly so (see Lungs) ; the lower, very little.

PATHOLOGICAL RELATIONS.—1. The upper boundary of dulness is found higher. The cause of this can first of all be found in the pleural cavity : pleural exudation, tumors of the pleura, of the lungs, pneumonia ; or in the chest wall : tumors, peripleuritis. Then, of course, it is not possible to distinguish the dulness of what lies above the liver from that of the liver itself, since two media that on per-

cussion give dulness cannot be distinguished from one another. If there is exudative pleuritis upon the right side, the diaphragm is deeper and the liver moves down, causing its lower boundary of dulness to be lower, and thus in this disease there may be an extensive dulness, reaching from high in the thorax to far below the border of the ribs—dulness of the exudation plus liver-dulness.

If the conditions just named are excluded, then we may have

(a) Displacement of the liver upward, with high position of the diaphragm. Then, at the same time, the lower border of the liver is higher, and indeed the latter is displaced upward further than the former, because the liver, as it moves upward, in a sense turns on its axis—that is, the lower border turns up, so that it is to a less extent parietal—the square position of Frerichs. (For the conditions which displace the liver, see above.)

(b) A tumor, of the convexity of the liver, as a new formation, an abscess, echinococcus, when the upper boundary of dulness pursues an irregular course, according to the form of the tumor; or a subphrenic abscess. In these cases, the liver is usually displaced downward, often very markedly so; hence, the lower boundary of the liver at the same time stands deeper.

(c) A simultaneous general enlargement of the liver. This is rare, occurring only when the liver is very large. Here also the lower boundary of dulness is considerably deeper. It is often very difficult to distinguish, and then only by inspection (projection) and palpation of the surface and consistence of the liver, and other evidences of disease referred to under (b).

2. The upper boundary of dulness is found deeper. This occurs:

(a) With a simultaneous normal position of the lower boundary, in slight substantive, and in vicarious, *emphysema*. Although in this case the lung moves down into the complementary space, and thus covers the liver somewhat more than is normal, yet the dome of the diaphragm does not become deeper.

(b) With simultaneous downward displacement of the lower boundary: low position of the diaphragm with the liver: marked *emphysema* with low position of the diaphragm; *pneumothorax*. We can have the same percussion result with considerable *emphysema* and *enlargement* of the liver. Finally, there may be low position of both boundaries resulting from the low position and enlargement of the

liver, as is a frequent occurrence in severe emphysema, because of the existing engorgement of the liver.

When the liver is displaced downward it easily gives the impression of being enlarged without such being the fact, because it is often parietal for a larger area than is normal. Also, for this reason, the liver-dulness is higher than it is normally on the average; especially in pneumothorax is it often distinct.

3. The behavior of the lower boundary when the upper is displaced has in general been already mentioned. It remains to be noticed that, when the liver is pushed down by a thoracic affection on the right side (*pleurisy, pneumothorax*), it stands obliquely, that is, the right lobe is deeper than the left, hence the depressed lower boundary of dulness stands steeper than normal, sloping from the right toward the left. On the other hand, when we have a pleurisy or pneumothorax upon the left side, or marked *pericarditis exudativa*, since the left end of the liver (*lob. sinistra*) is then alone pressed down, the lower line of dulness is found more horizontal.

With a normal upper border, the lower boundary stands deep and reaches further into the half-moon-shaped space when the liver is enlarged; on the other hand, it is higher than normal, under some circumstances even until the liver dulness completely disappears in the following conditions: (a) If the liver is smaller, as in *cirrhosis*, acute *yellow atrophy*, here occurring rapidly. (b) As happens much more frequently than (a), in case the liver, though perfectly sound, is less parietal than normal, or is not at all so, as in those who are on the whole well, in *meteorism, ascites*, entrance of air into the peritoneum. In this way even an enlarged liver may elude examination. In yet two other rare cases is the liver dulness entirely wanting; in *situs inversus viscerum* and in cases of "wandering liver." With the latter, sometimes a portion of the upper surface of the liver will be found in contact with the abdominal wall further down.

Apparent low position of the lower border occurs when there is an airless mass below the liver, as with a full colon, or a large tumor of the colon, of the omentum, or of the stomach, although these are rare.

The form of the lower border departs from the normal when there is unequal enlargement of the liver (see above); also sometimes in marked enlargement of the gall-bladder, seldom determined by per-

cussion. (For the different kinds of enlargement, see under Palpation.)

4. Relative liver-dulness is diagnostically of little interest. It is relatively high, if the diaphragm rises steeply upward and inward from the thoracic wall, and very low, if the diaphragm goes off perpendicularly from the thoracic wall, as in severe *emphysema*, but especially in *pneumothorax*.

All in all, percussion of the liver, when rightly performed and correctly interpreted, is of very great value. But where palpation can be employed, as is usually the case whenever the inferior border of the liver is lower than normal, it must yield to the latter method of examination, which is more anatomical and hence more exact. If the border of the liver can be felt, then we note its course upon the body by the results of palpation and not of percussion, and proceed with the diagnosis in accordance with this position.

EXAMINATION OF THE SPLEEN.

ANATOMY.—The spleen, a long, generally almost oval, organ, lies in the left hypochondrium, between the ninth and eleventh ribs, in such a way that its long diameter in the dorsal position of the body lies almost exactly behind and parallel to the tenth rib. Its posterior end lies about two centimetres from the tenth dorsal vertebra; its anterior end, normally, scarcely reaches to a line drawn from the tip of the eleventh rib to the left sterno-clavicular articulation (*linea costo-articularis*), at any rate does not pass beyond it. The upper (anterior—upper¹) of the two borders of the spleen exhibits one or two notches.

The spleen lies close to the under surface of the diaphragm, in the periphery of that portion which rises sharply upward, and toward its inner lower end it covers a small portion of the upper part of the left kidney, also the colon and stomach. Topographically, with reference to the thorax, its location is as follows: Its upper third, during moderate respiration, is covered by the lung. The lower two-thirds are in con-

¹ In what follows I designate the two borders of the spleen as "upper" and "lower," because from the topographical standpoint that always seems to me the most natural. We speak of an upper and lower border of all the ribs, even of the lower ones, which are oblique. I cannot understand why one of the two ends of the spleen should be called the "upper" and the other the "anterior," as is done by Weil.

tact with the thoracic wall, but it changes its relation somewhat with the position of the body by reason of the passive mobility of the border of the lung (which see). Its upper border follows the ninth rib, forms the outer boundary of the "half-moon-shaped space," and

FIG. 90.

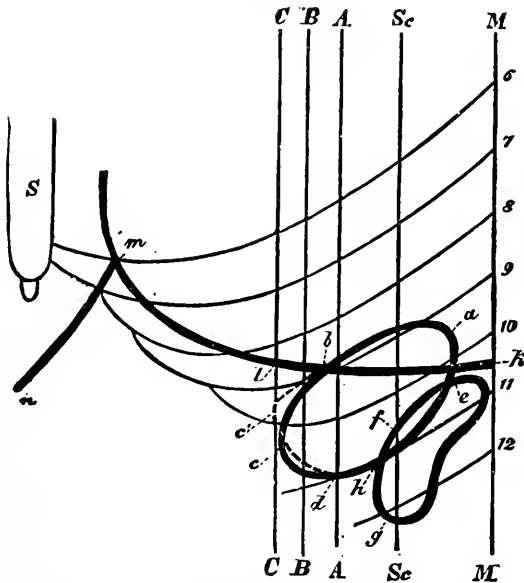

Position of the spleen. (WEIL.) *M*, the middle line of the back; *A, B, C*, the axillary lines; *Sc*, the scapular lines; *abcd*, spleen; *abc'd*, unusual rhomboidal form of the spleen; *efg*, outer boundary of the kidney; *lbc*, the spleen-lung and *dhg*, the spleen-kidney angle; *nm*, the lower border of the liver.

stands at a sharp angle with the lower border of the lung (see figure), called the spleen-lung angle, whose apex, in the upright position, is about at the posterior axillary line, but when in the right-side position, in consequence of the movement downward of the lower border of the lung, it moves somewhat forward, even as far as the anterior axillary line. Its lower border follows the eleventh rib, and for the most part bounds the left kidney.

The spleen is in parietal contact only in its lower two-thirds, but it cannot be reached by the finger except sometimes by turning the abdominal wall under the border of the ribs.

INSPECTION OF THE SPLEEN.

In the normal condition, and even when greatly enlarged, inspection of the spleen gives no result. A very considerable enlargement causes a projection of the left hypochondrium, and of the abdominal region obliquely inward and downward from it. When the abdominal wall is thin, the border of the enlarged organ or a circumscribed swelling on its parietal surface may be seen. Then if the upper end of the spleen has not left its place close to the diaphragm (see below), it usually plainly descends with deep inspiration.

PALPATION OF THE SPLEEN.

Palpation is very much the most important method of examination, because its results are much more reliable than is the case with percussion. Ordinarily, in order to employ palpation, it is necessary for the patient to assume what is called the diagonal position on the right side, that is to say, a position midway between the dorsal and the right-side position, and also for the reason that percussion can be practised very much better in this position, and because the unity of the position is useful for comparing the results of the two methods of examination. When the patient is very sick, it is better to palpate in the dorsal position. When the spleen is of very considerable size, this is also best (then, too, it is preferable for percussion). If it is difficult to find the spleen, then we try the right-side position, because this more fully relaxes the left side of the abdominal wall. If we have the patient take several deep inspirations, a slight swelling of the spleen can usually be made out by feeling the anterior end of the organ close to the border of the ribs, at about the tenth rib, where it comes in contact with the tip of the finger. Without further investigation we cannot refer a simple increase of resistance at the edge of the ribs to the spleen; but we must further seek to feel its border.

The spleen can be felt :

1. In individual cases in health, when the abdominal wall is very lax; also, sometimes, in persons with deformed chest (kypho-scoliosis).
2. If it is enlarged. It may be enlarged and yet retain its form. It is uniformly enlarged in certain acute infectious diseases, as in typhoid, exanthematous and recurrent fever; in scarlet fever, usually in

severe smallpox; malaria, here relatively very large; in erysipelas, here often very little enlarged; in sepsis and pyæmia; sometimes in acute miliary tuberculosis; in engorgement of the spleen, especially in cirrhosis of the liver; in occlusion of the portal vein; in general venous engorgement; in amyloid disease of the spleen; in leukæmia (greatest enlargement), and in splenic anæmia; sometimes, in infarction of the spleen (heart disease); and also in tubercular peritonitis. We must here also mention the apparent enlargement of the spleen where there are thick peritoneal deposits (perisplenitis).

It may also be unequally enlarged by new formations, especially by carcinoma, and by echinococcus and abscess.

3. It may be felt if it is displaced, with low position of the diaphragm (rare); the "wandering" spleen.

In palpating we take notice of:

Pain. Tenderness, probably always from the peritoneum, sometimes occurs in acute infectious diseases, in suddenly developed engorgement, in infarction of spleen, new formations, abscesses. There may sometimes, in abscesses and infarction, be tenderness to pressure upon the ribs in the neighborhood of the spleen.

Size. The largest tumors of the spleen, often reaching into the right side of the abdomen, occur in leukæmia. On the other hand, in the acute infectious diseases, we have moderate enlargement of the spleen, which does not come below the border of the ribs. In other diseases the splenic tumor varies very much in size. Pulsating splenic tumor has been observed now and then in cases of aortic insufficiency.

Consistence. As a rule, the consistence increases with the size, and is more dense in chronic, than in acute, cases. Generally, the consistence is not a guide in diagnosis.

Form, surface. It has already been mentioned in what diseases the spleen is uniformly, and in what unequally, enlarged. In diseases of the first group, we can almost always, and in the latter sometimes, feel distinctly the notches in the upper border, if the spleen projects far enough beyond the border of the ribs. In carcinoma, the surface shows hard, uneven tumors; in echinococcus, they are round, tense, elastic. But in leukæmia, the surface is not always uniform, for it may sometimes exhibit flat elevations.

Mobility. We have already mentioned the downward movement of the spleen with deep inspiration. I have seen cases of very great

enlargement of spleen where this did not take place, because the spleen had pushed the diaphragm high up on the left side (see Percussion), and hindered its contraction.

Wandering spleen, having diminished respiratory movement, but passively movable, and sometimes even showing displacement downward with change of posture, occurs only in women. The spleen may wander astonishingly far from its place, even into the true pelvis, and it has been found in the abdominal cavity entirely free from its attachments; but usually there is only slight displacement. Tumors of this kind are recognized as wandering spleen by their form and by the notches. Often, it is at the same time enlarged. A spleen displaced by the low position of the diaphragm can seldom be felt. (See further regarding displacement, under Percussion of the Spleen.)

Relation of the colon to the spleen. Enlarged and wandering spleen lies in front of the colon. We can best prove this by inflating the colon with air in connection with palpation and percussion.

PERCUSSION OF THE SPLEEN.

Percussion is limited to that portion of the spleen which is not covered by the lung (Weil). It is bounded above by the lung; toward the front superiorly, we have the upper border, inferiorly, the anterior end, and a portion some distance behind (inferior border), against the stomach and intestine; further back, against the kidney. But this latter portion cannot be defined, there being dulness against dulness.

When we can only percuss with the patient in one position, as with very sick patients, we do so in the right diagonal posture. But if we wish to be very exact, and the patient can bear it, it is best also to percuss in the upright posture. Let it be repeated, that palpation generally, even though the physician be skilful in percussion, gives a much more certain result. But percussion must never be omitted. When the spleen is very much enlarged, we may examine the patient in the dorsal position. The diagonal posture is only required to determine whether, and how much, the spleen pushes up the diaphragm.

In both the diagonal and the upright posture, we begin by determining the lower border of the left lung. It is normally in the upright position:

mammillary line, sixth rib; middle axillary line, eighth rib; scapular line, tenth rib. In the diagonal position, it varies from the seventh to the eleventh rib. From here, if we percuss in the vertical line, over the border of the lung downward, and, in the diagonal position, about in the anterior or middle axillary line, below the border of the lung, we will meet dulness instead of the tympanitic sound of the half-moon-shaped space: spleen-dulness. The place at the border of the lung where the dulness is met with is the apex of the spleen-lung angle (see anatomy, p. 333). We now percuss vertically downward, through this angle beyond the deadened sound, till we come to a tympanitic (intestinal) resonance: the boundary line is the lower border of the spleen. Then we percuss from the half-moon-shaped space and from the abdomen, upon lines which cross what we suppose to be the area of spleen-dulness, and thus ascertain where the tympanitic stomach or intestinal resonance changes to dulness. This marks the line of the spleen. If we mark these points, and connect them, we obtain the figure of the parietal portion of the spleen, which we can complete by determining the lower border of the spleen in the posterior axillary line, or in a vertical line between this and the scapular line.

In the upright position, the conditions are altered in such a way that the border of the lungs, and with it the lung-spleen boundary, stands somewhat higher (see above), and hence we find the apex of the lung-spleen angle in the middle or posterior axillary line.

As has already been said, the size of the spleen-dulness, with careful percussion and under favorable conditions (see below), corresponds to the parietal part of the spleen. From this we must estimate the size of the spleen. In measuring it, we have only two points of departure: the height of the spleen-dulness in the vertical

FIG. 91.

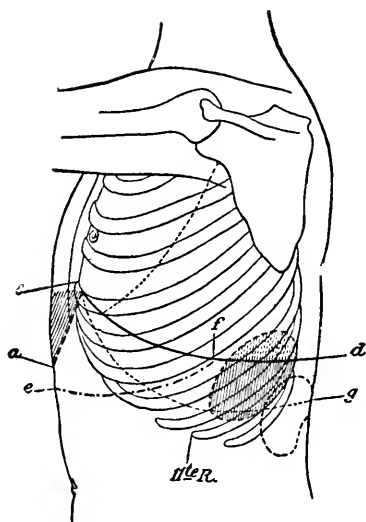

Shape of the spleen-dulness.

line passing through the apex of the spleen-lung angle, and the relation of the anterior end of the spleen to the *linea costo-articularis*. The average in health has been found to be (Weil):

In the diagonal posture, the height of the spleen is 5.5 to 7 cm., the anterior end at most reaching to the *linea costo-articularis*.

In the upright position, the height is 4.5 to 6 cm., the anterior end under some circumstances passing a little beyond the *linea costo-articularis*: the spleen-lung angle more pointed—that is, the spleen is a little more horizontal.

We are interested in the mobility of the spleen-dulness in deep inspiration only so far as it affects the boundary between the spleen and lung (see what has been said regarding active mobility of the border of the lung).

Weil, in his work upon *Topographical Percussion*, has sufficiently explained why we must forego the determination of the portion of the spleen which is covered by the lung.

In the first place, we percuss tolerably strongly. If in that way we obtain no result, we then percuss very lightly. With strong percussion over the spleen, we very seldom get resonance; also, with moderately strong, only rarely absolute deadness. Also, we must often be satisfied, by gentle percussion, with a relative dulness, associated with tympanitic accompaniment.

Departures from what has been called the “average” in health: (a) The dulness of the spleen is only approximated as regards size or intensity: a very frequent occurrence when it is covered by intestine, or the spleen is thin and the intestines near it are distended by gas.

(b) The area of spleen-dulness is larger, while its form is retained or is changed: this occurs when the stomach is overloaded with food, when there are fecal masses in the neighboring colon, when there is corpulence (the greater omentum loaded with fat); but, also, sometimes without these conditions being present. We must guard against deception as respects the stomach and intestine by repeated examinations, especially with abstinence from food and after free purgation. When there is obesity, we ought not, on the whole, to draw any conclusion from a large area of spleen-dulness.

But, at any rate, we must never, by a single examination, diagnose a spleen-tumor from percussion alone.

PATHOLOGICAL RELATIONS.—As mentioned above, *diminution of spleen-dulness* is often met with in health. In sickness, it occurs from

overlapping of the spleen from above by the lung: this happens with emphysema of the lung, when the lung spreads into the complementary space; sinking down of the lower border of the spleen and its anterior end, as evidence of displacement downward by flattening of the diaphragm, but in emphysema this cannot be proved. There is always diminution of spleen-dulness (even to complete disappearance) when it is displaced upward, as in shrinking after pleurisy, contraction of the lung, high position of the diaphragm. Here, generally, there is no spleen-dulness at all, on account of the intestine lying over it.

Enlargement of spleen-dulness. If we make out such a condition we ought to call to mind the sources of error mentioned above. We should never make the diagnosis of enlarged spleen from a single percussion, without the support afforded by palpation. We must notice whether the enlarged dulness shows the relations of the figure of the spleen; if it does, then it is quite probable that the spleen is enlarged; likewise, if the examination in the diagonal and the standing position shows a similar result, with change of dulness that distinctly corresponds with the changed position of the border of the lung and the spleen.

Enlargement of the spleen is to be assumed when the vertical measurement of dulness is as much as 9 cm. or more; also, if the area of dulness extends considerably beyond the *linea costo-articularis*; and, lastly, if the dulness is very decided, with moderately strong percussion absolute. When there is considerable enlargement of the spleen, the area of dulness upward is larger, and, hence, the diaphragm, and with it the border of the lung, moves higher in the chest. Moreover, in every upward enlargement of the spleen-dulness it is to be remembered that it may be merely apparent, being caused by pleuritic exudation, infiltration of the lungs, or pleural tumor.

When there is a decided enlargement of the spleen, it considerably diminishes the half-moon-shaped space. If there is, simultaneously, tumor of spleen and liver, the space may be entirely deadened.

AUSCULTATION OF THE SPLEEN.

In rare cases, auscultation enables us to recognize peritoneal friction-sounds should there be inflammatory deposits upon the serous coat of the

spleen and the parietal portion of the peritoneum opposite to it, if the diaphragm is not paralyzed by the peritonitis or the spleen has not become adherent. Peritoneal friction-sound over the spleen (and over the liver) seems to me to have greater weight as evidence that the first of the two last-named conditions is wanting, than as the sign of peritonitis, for the latter usually appears to be plainer from other symptoms. It may easily happen that we find it difficult to distinguish whether we really have peritoneal, rather than pleuritic, friction-sound. Auscultating with the stethoscope enables us to localize the sound more exactly. We must also take into consideration the whole picture of the disease.

EXAMINATION OF THE PANCREAS, OMENTUM, RETRO-PERITONEAL GLANDS.

The pancreas is accessible for examination, and even to palpation, if it is the seat of new formation, as of carcinoma, especially of the *caput pancreatis*, and hence is larger and harder than normal: we have a roundish tumor in the right epigastrium which does not move during respiration, about midway between the point of the xiphoid cartilage and the umbilicus, hence, directly under the border of the liver; or a somewhat longer tumor across the epigastrium. Unless there are characteristic associated symptoms (compression of the ductus choledochus and pancreaticus, biliary engorgement, and change in the character of the stools), the diagnosis of tumor of the pancreas can scarcely be made from such a tumor, which may also belong to the omentum, but especially to the retro-peritoneal glands.

The omentum, also, is only perceptible when it is thickened by inflammation or new formations, or by both. It frequently shrinks up to a transverse band which lies close above the umbilicus, as in tuberculosis, but doubtless also in "simple" chronic peritonitis. Carcinomatous knots in the omentum are best to be distinguished from similar deposits in the anterior wall of the stomach, by examining the latter, both when empty, and full, or inflated. Sometimes it is very difficult to distinguish them from carcinoma of the liver, especially if the omentum, from adhesion with the liver, moves with each respiration. Echinococcus of the omentum is quite rare.

Enlargement of the retro-peritoneal glands generally occurs in

secondary carcinoma as firm, immovable bunches, which are located in the cavity of the abdomen, about on the level with the umbilicus; but sometimes they reach even deeper. They may compress the side of the inferior vena cava or the iliac vein. This may easily be confounded with aneurism of the aorta, especially if it is a round tumor and propagates pulsations, and it may also even communicate a humming murmur of stenosis from the aorta.

We must again call attention to the importance of always emptying the intestines and bladder in all cases of this character where the diagnosis is difficult.

This is not the place to explain the differential diagnosis of a large number of other affections of the abdomen, especially tumors of the uterus, ovaries; also, pregnancy. (We refer for these to works upon Gynæcology and Obstetrics.)

EXAMINATION OF THE CONTENTS OF THE STOMACH.

In general we may obtain the contents of the stomach for examination in two ways: when the patient vomits, or when, by emptying the stomach by means of an œsophageal catheter, we remove a portion of its contents. The catheter may be introduced for therapeutic purposes, or only for the purposes of diagnosis.

The latter way of obtaining some of the contents of the stomach, it is readily seen, is the more exact for making a diagnosis, because we regulate the time for doing it by the object we have in view. First, with reference to the most important problem in the diagnosis of the contents of the stomach, namely, the examination of the stomach-digestion and the secretion of gastric juice, it is only necessary to empty the stomach to obtain the object required. At the same time, it is to be remembered that, in many cases, the examination of vomited matters or the fluid employed in rinsing out the stomach (especially in cases of poisoning) is of very great importance, and is, then, not to be overlooked.

Artificial emptying of the stomach or removal of some of its contents for the purposes of diagnosis is, as has been said, the only method which enables us to form a reliable opinion regarding the gastric secretion and the process of digestion, for the reason just given, that such an opinion can usually only be formed when the contents of the

stomach have been obtained in a pure state and at a definite time after partaking of a meal. Vomiting can make the artificial emptying of the stomach unnecessary only when it occurs at exactly the time desired, and when the material vomited does not contain bile and not too much mucus (see below).

Induction of emesis is contra-indicated when there is a tendency to hemorrhage, and in poisoning, where we have reason to think the poisons, as acids and alkalies, have caused erosion of the œsophagus or stomach. Sounds, even soft ones, are to be employed with the greatest caution if there has ever been any hemorrhage of the stomach, and also when there is any suspicion of an ulcer of the stomach or of a carcinoma that is eating through the walls.

Knowledge regarding the secretion of gastric juice and stomach-digestion is important really in three directions, because, by means of it, certain diseases may be recognized early, before inspection, palpation, etc., are of any value, or where these methods do not in any way give any result. And even where other methods of examination have led to a positive conclusion, the diagnosis is not only made still more definite by this knowledge, but likewise the effect of a disease of the stomach upon its functions is determined. Lastly, there is sometimes a flat contradiction between the severe complaints of the patient regarding the stomach and a perfectly normal gastric digestion. In this case, the examination of the contents of the stomach immediately furnishes an explanation, as in some forms of "nervous" dyspepsia.

EXAMINATION OF THE PROCESS OF DIGESTION.

Stomach-digestion and its Disturbances.

1. After partaking of a meal which contains albumen and starch (fat does not come under consideration, because it is not digested by the stomach), there first occurs, under the influence of the ptyalin of the saliva, the amylolytic period of digestion: the starch contained in the food taken gradually disappears, and dextrine takes its place (achroö- and erythro-dextrine) and there is a slight amount of grape-sugar; any cane-sugar that has been taken is inverted, that is, is partly transformed into grape-sugar. These processes go on tolerably rapidly. Moreover, under the influence of microorganisms that excite fermenta-

tion, there occurs a partial lactic-acid fermentation of the grape-sugar, and hence lactic acid is formed (lactic-acid fermentation).

This amylolytic period varies in length according to the size of the meal; on the average, it lasts three-quarters of an hour. As a matter of course, it is entirely absent if only meat is eaten; then, also, there is no lactic acid.

Immediately after food is taken, the mucous membrane of the stomach begins to secrete muriatic acid and pepsin, and the stomach-juice mixes with the alkaline chyme. But at first the muriatic acid is in combination, and we do not have free muriatic acid in any quantity until, on the average, one-half to three-quarters of an hour; thus the amylolytic period is brought to a close, because the diastatic action of the saliva cannot go on in an acid solution. Instead, there begins the peptonizing action of the secretion of the stomach upon the albuminous bodies. The lactic acid disappears, and after the first hour none, or only a trace of it, can be detected. The stomach now contains an increasing amount of free muriatic acid, and this reaches its maximum, 0.2 per cent., or less, according to the size and character of the meal, from two to five hours after the time it was eaten. From now on there appear peptones and their precursors (syntonin and propeptone).

Simultaneously with the free muriatic acid, the [milk-curdling ferment] rennet-ferment appears, under whose action the casein of the milk that has been taken is coagulated.

The pepsin and rennet-ferment are not secreted as such by the mucous membrane of the stomach, but are formed by their zymogens [*zymon*, ferment], propepsin and rennet-zymogen. Both, under the influence of the muriatic acid, become transformed into pepsin and rennet-ferment. The lactic acid, although in very much larger quantity, has this effect upon the zymogens also.

This second or muriatic-acid period of stomach-digestion, now shows the very important peculiarity that, during its course, under the influence of the 0.2 per cent. of free muriatic acid, we have the antiseptic action of the gastric juice, by which the greater proportion of the microorganisms swallowed with the food and drink, particularly those that excite fermentation and putridity, as well as certain pathogenic ones, as the cholera bacillus, are destroyed.

During the progress of stomach-digestion the food is mixed by peristalsis, and partly by the aid of the ferments is comminuted and reduced

to a homogeneous mass. A small portion of the fluid resulting from digestion is absorbed; but besides, at the pyloric end of the stomach, a continuous separation of the solid and fluid portions is going on, and the latter, during the whole period of digestion, passes little by little into the duodenum.

2. About six hours after a mixed meal of moderate quantity (much sooner after a smaller one), the stomach has become entirely empty, or at most contains only small particles of food. In the interval until the next meal, in the great majority of healthy persons, it appears that the stomach contains a very scant amount of clear fluid, with a neutral reaction, but no muriatic acid or pepsin.

The stomach-digestion of nurslings has as yet been very little studied. According to Leo, the fasting stomach of a nursling almost always contains free muriatic acid, while during digestion free muriatic acid cannot at all, or only after an hour, be demonstrated; this is not because there is none secreted, but because it is neutralized by the milk. Leo always found rennet-ferment, excepting in one case where there was rennet-zymogen. After half an hour, the greater portion of the milk has passed into the intestine, and in one, or at most two hours, the stomach is empty. Leo also thinks that the peptonizing of the milk in the stomach is a subordinate process. He regards the stomach as really a milk-reservoir, and perhaps as offering a barrier to pathogenic microorganisms.

3. The chief points in regard to the effect of pathological disturbances of the gastric secretion, of the motions of the stomach upon digestion, and the sterilization of the food and its further transportation into the intestine, are as follows:

Diminished secretion of muriatic acid (subacidity, hypacidity) interferes with the digestion of albumen and the power of the stomach to prevent decomposition and fermentation.

When the muriatic acid is increased (superacidity, hyperacidity), free acid is present earlier, and thus there is interference with the digestion of the starches, because this only goes on while the contents of the stomach have an alkaline reaction; likewise, the albuminous bodies are either normally, or more rapidly, peptonized, but in some cases it is remarkable that they are more slowly peptonized.

Diminution of the muriatic acid generally appears to go parallel with a diminution of the pepsin. On the other hand, this parallelism

is generally not present when there is superacidity; with increase of the muriatic acid, there even appears to be an absence of pepsin. At least, this latter condition alone explains those cases where the peptonization of the albuminous bodies is prolonged, although the free acid is increased.

Hence, with subacidity (inacidity) not only are the albuminous bodies imperfectly digested, but under the influence of the unrestrained development of microorganisms there occurs an abnormal decomposition, and particularly of fermentation with formation of lactic acid in excess of the normal time and amount, as well as of other organic acids. This abnormal chemical activity in turn produces a paralysis of peristalsis and muscular tone. The removal of the food stops for this reason, and probably also because the pylorus does not readily allow material to pass into the duodenum which is in an abnormal chemical, and in part physical, condition. The food remains too long in the stomach, and hence the stomach-digestion is prolonged. Lastly, if the condition persists, there is ectasia or dilatation of the stomach. It is to be remarked that by the word dilatation alone is always meant permanent dilatation, in contradistinction from temporary dilatation, which occurs after every meal.

Quite similar in its final results is the effect of a hindrance to the emptying of the stomach, as is particularly frequent with pyloric stenosis; only here the disturbance is on the whole much more marked. In stenosis of the pylorus, the difficulty in expelling the food is at first overcome by an hypertrophy of the muscular coats of the stomach; but gradually there becomes manifest a disproportion between the strength of the stomach and the narrowed passage. Part of the contents of the stomach remain behind at the time of the next meal, and so the stomach becomes more and more dilated. There is an accumulation of material (peptones, albuminates, muriatic and phosphoric acid salts); and the muriatic acid, though free, is yet so interfered with that it no longer exerts its peptonizing and antifermentative action. There is no further digestion, but in place of it the food accumulated in the stomach takes on fermentation, with formation of a great amount of lactic acid, butyric acid, acetic acid, and alcohol.

Through this abnormal chemical action, peristalsis and the muscular tone are still more weakened: there results a true *circulus vitiosus* of the motor and chemical phenomena.

4. The chief points in the symptomatology of a distended stomach are the following:

Subacidity or in acidity may be recognized by the diminished percentage of muriatic acid or its absence. Further, there are signs of abnormal fermentation, of which the most important is the unusual duration and amount of lactic acid. Digestion is usually prolonged: the stomach is not empty after seven hours; it still contains unchanged particles of meat, discernible microscopically or even macroscopically. If we institute experimental digestion with the gastric juice in an incubator (see below), we find that it is diminished, or that it has lost its power to digest albumen.

Superacidity during digestion shows an increased amount of free muriatic acid: usually the free acid makes its appearance too early; the amylolytic period is thus shortened, and there is unchanged starch (microscopically and chemically demonstrable). Albuminous digestion in the incubator may be quickened.

Increased difficulty in conveying the food from the stomach (especially when due to stenosis of the pylorus) is connected with diminution or absence of free muriatic acid. Thus, the secretion of acid may be normal or even increased; but the muriatic acid is loosely connected with the bulky remaining albuminates, peptones, and salts, and hence is without chemical or antiseptic action on the one hand, and, on the other, its presence is "concealed," or cannot be established by the ordinary reactions. The great amount of lactic acids (butyric and acetic acids) is shown by the amount of fermentation. The diminished digestion of all kinds of food shows this plainly. In the incubator the albumen is not digested.

5. A peculiar anomaly as respects the gastric secretion consists in the fact that even when the stomach is empty, muriatic acid, pepsin, and rennet-ferment, or propepsin and rennet-zymogen, are secreted (supersecretion, hypersecretion). A very considerable amount of this gastric secretion may be accumulated in the stomach; and this is still more increased by the fact that, generally, the presence of an acid fluid in the stomach stimulates the secretion of saliva. The saliva swallowed is not, however, sufficient to neutralize the acid fluid.

Schreiber has recently found that, even in persons who are in perfect health, there is a small quantity of acid gastric secretion in the fasting stomach. This is in direct contradiction of the statements of

former authors. We will again enter (p. 355) upon the question of the gastric secretion in the fasting stomach.

Mode of Procedure in Examining the Stomach-Digestion.

The action of the stomach is divided into the chemical effect of its secretion and the assistance furnished by mechanically mixing the food and reducing it to small particles; the passing-on of the digested or sterilized material, and the absorption of a portion of it. Compared with that which is passed along, the amount absorbed seems to be small. These processes imply, as has been shown above, a certain length of time, which, in health and when a meal of moderate size is eaten, takes place within tolerably definite limits.

Thus, the examination of the action of the stomach is connected with the determination of the duration of digestion, the examination of the chemical action during digestion, lastly, the relation of the onward movement and absorption.

I. *Duration of digestion.* Since the duration of digestion very much depends upon the kind and size of the meal, in making the examination, it is indispensably necessary to arrange similar conditions artificially. This requirement will be met by Leube's experimental meal, consisting of a plate of water-gruel, an ordinary piece of beef-steak, and white bread. After partaking of this meal, the patient takes nothing until seven hours from the time it was eaten, when the stomach is to be emptied by means of an œsophageal catheter. When the digestion is normal, the stomach after this space of time is empty, or contains only a few particles of the remains of the food.

The stomach is emptied or washed out by means of an œsophageal catheter and a siphon, or exceptionally by employing a stomach-pump. We employ a soft Nélaton's œsophageal catheter of at least 0.6 cm. internal diameter, to which we attach a piece of rubber tubing, 1 m. to 1.20 m. in length, with a short piece of glass tubing inserted along its course; on the other end of the tubing is a glass funnel. The catheter is introduced without a guide; in short, like any other œsophageal sound (see p. 293). After it has been used several times, the patient learns to introduce it himself, which he does by a sort of swallowing motion. Care must be taken lest the sound goes clear down, as has more than once happened.

If the stomach is quite full, then immediately after the catheter is introduced its contents well up through it, even if the rubber tube and funnel have not been attached. If the stomach is only moderately full, then it is often simply necessary to press the patient in order to bring up the contents of the stomach through the catheter. If, in this way, we do not receive anything, then, if there is no reason to suspect an ulcer or a carcinoma that will bleed easily, we may carefully aspirate with a stomach-pump. If, even then, we do not get anything, we must wash out the stomach with a small, but measured, amount of water, so as to see whether there are still some remaining particles of food. For this purpose we fill the tube and a part of the funnel with lukewarm water, before connecting it with the catheter, and then we pour more water into the funnel, hold it high and allow the water to run into the stomach. Next, before it is quite empty, we lower the funnel quickly into a vessel standing ready upon the floor: the tubing and funnel act as a siphon, and suck out the contents of the stomach. By filling and emptying it several times, the stomach will generally be completely emptied.

If, in this way, we cannot obtain sufficient siphon-action, we can increase the suction power of the apparatus by placing the funnel in a vessel of water, extending the rubber tube, and then lifting the funnel a little in the water.

If the rinsings of the stomach after seven hours contain at most only a few remnants of food, in most cases the digestion is normal. At any rate, if it is tolerably certain that there is diminution of gastric juice, we can almost certainly conclude that the power of the stomach to empty itself is unimpaired. But it is possible that there is superacidity, and, as a matter of course, supersecretion. If this is the case, we repeat the experiment, except that the catheter is introduced one or two hours sooner. In this way we determine the duration of digestion.

If, after seven hours, the stomach still contains considerable portions of food, then digestion is prolonged: subacidity, or there is interference with the physiological emptying of the stomach: stenosis of the pylorus, diminished peristalsis, or dilatation. Digestion of a simple meal (see above) lasting longer than seven hours is, in health, only observed in menstruating women.

II. *The chemistry of digestion.* We may again employ Leube's experimental meal for investigating the chemistry of digestion. Some-

times we may make use of what we obtain while determining the duration of digestion—that is, if seven hours after the meal we find the stomach yet full. If it is empty, then we repeat the experimental meal, and make the trial five hours after it. If we then find it empty (which, normally, is not seldom the case), we go back to four hours. In such cases, at any rate, where there is free muriatic acid, we endeavor to examine the contents of the stomach at the height of the muriatic-acid digestion—that is, at the time when the muriatic acid has its chief value. This is usually about an hour before the close of the period of gastric digestion.

Ewald has introduced an important simplification of this examination. He gives a test-breakfast, consisting of a dry roll and lukewarm water or dilute tea, which are taken fasting. The period of digestion is thus so shortened that one hour after digestion has reached its highest point.

In regard to the dispute as to which is preferable, the experimental meal or the experimental breakfast, we take the ground that the latter is decidedly to be preferred for settling the important points we are seeking, particularly for the practising physician, who is not able to control his patients, and hence must choose the experiment lasting one hour rather than the other, where he is obliged to be away from his fasting patient from four to six hours. But, on the other hand, we must, with others, emphasize the fact that the experimental breakfast makes too slight a demand upon the stomach to permit of a nice judgment as to what it can do. Hence, our experience leads us to believe that the experimental breakfast may mislead us in two diametrically opposite directions—in many cases, by the digestive power of the stomach seeming greater than it is; or, in other cases, that it does not appear to be as strong as it really is, because it is too little stimulated (in certain nervous dyspepsias, also in many cases of chronic catarrh, as alcoholic catarrh). The greater “cleanliness” of his experiment, as Ewald maintains, cannot be recognized as regulative; after filtration, in all cases, we obtain after the experimental meal a perfectly clear fluid, which responds very well to the reactions presently to be described.

Jaworski gives as the experimental meal the albumin of two boiled eggs with 100 gm. of water—a simplification which we do not think useful or necessary. It is an unnatural experiment, as the well-known instinctive disgust for food of pure albumin proves.

The following procedure is recommended for making the examination:

1. We satisfy ourselves whether there is any bile, blood, or pus in the contents of the stomach (see *Vomit*). If there is not, then we filter a portion for further examination.

2. We carefully examine the residuum upon the filtering-paper with the naked eye. If an experimental meal has been given, then we observe how thoroughly the masses of meat have been macerated, especially whether the maceration is uniform; further, we notice whether there are any unchanged particles of bread. (Regarding certain things seen under the microscope, see *Vomit*.)

3. We test the reaction of the fluid-filtrate with litmus (paper or tincture). An acid reaction may be due to muriatic acid or organic acids, or both.

4. Then follows the qualitative examination for free muriatic acid and lactic acid.

For testing for free muriatic acid we recommend the test with tropäolin-paper.¹ We moisten the paper with a drop of the filtrate, then place the bit of paper in a watch-glass and heat it. If there is free HCl, the tropäolin-paper first becomes brown, then, as it dries, lilac color. Approximately equivalent is the test with a saturated alcoholic solution of 00-tropäolin, which has been mixed with a double quantity of the filtrate in a small porcelain dish, distributed by whirling. After pouring off the surplus, it is to be slowly heated: free HCl yields a lilac-red reflection. Lactic acid gives no reaction, even when tolerably concentrated (0.6 per cent.). It is very distinct when the solution of HCl is pure—about 0.05 per cent. In the presence of albumin, peptones, phosphates, it is much less distinct.

Still more certain and much more distinct, while its distinctness is much less affected by other substances, is the phloroglucin-vanillin test. The reagent consists of phloroglucin 2 parts, vanillin 1 part, to absolute alcohol 30 parts. Of this, one or two drops are placed in a shallow porcelain dish, with an equal amount of the filtrate, and carefully heated. Free HCl gives a deep red, or, if the quantity is small, a bright rosy-red deposit: if there is no HCl, then the deposit is brown-red or brown. It is distinct—even to 0.05 per thousand. It is very

¹ Filter-paper soaked with a saturated solution of 00-Tropäolin.

nearly absolutely certain; its only drawback is that the reaction takes place also in the presence of sulphuretted hydrogen (hence, after tainted eggs have been eaten). This test very much surpasses all others. It is sufficient to employ this only.

Of the numerous other tests we only mention: The reaction with methyl-violet, which is applied as follows: two reagent-glasses are half-filled with a transparent solution of methyl-violet, and to this some of the filtrate is added. Free HCl colors methyl-violet blue. The reaction is not very distinct, nor is it very reliable; it can be imitated by table-salt, and it may be concealed by albuminate, peptone, etc. There are also to be named: congo-paper, blue ultramarine, and, lastly, resorcin, recently recommended by Boas (resorcin 5 parts, sugar 3 parts, dilute spirit to 100 parts).

The examination for lactic acid is conducted in the way suggested by Uffelmann: to about 100 gm. of a 2-per-cent. solution of carbolic acid we add one to two drops of a solution of chloride of iron, when the mixture becomes steel-blue. To this we add some of the stomach-fluid. If lactic acid is present, the solution is discolored and becomes yellow or yellowish-green; on the other hand, if there is only HCl, the solution becomes clear, like water. Butyric and acetic acids give it a more yellowish-red color; moreover, they are recognized by their odor, at any rate after shaking up some of the stomach-fluid with ether and evaporating the ether. The test is a very delicate one, and shows 0.01 per thousand of lactic acid. Its certainty is somewhat detracted from by the fact that lactic-acid salts give the same reaction. It is more important that alcohol, sugar, and acid salts cause the solution of chloride of iron and carbolic acid to assume a straw-yellow color. For this reason, in case there is no pronounced greenish-yellow, but a straw-yellow coloration, we must employ a more certain method: we simply agitate some of the filtrate with ether in a reagent-glass, pour off the ether, and then evaporate the residue over hot water, not a flame. We dissolve the deposit in water, and apply Uffelmann's reaction by the addition of a few drops of the reagent (Ewald).

5. The quantitative examination of the muriatic acid has a certain value in subacidity, but still greater when there is a suspicion of superacidity. Let it be once more remarked that the latter may be the case not only when the duration of the digestion of albuminous

material is diminished, but also when it is normal, or even when its duration is prolonged. Two methods may be employed, in both of which the supposed time of greatest amount of HCl is selected. Pus, blood, bile, a large amount of saliva must be excluded. Repeated examination is necessary. If the quantity of HCl exceeds 0.3 per cent., it may certainly be regarded as pathological. As much as 0.6 per cent. of free acid has been found.

First method: The determination of the total acidity is made by neutralizing it with a normal solution of soda. Of course, this will be understood to have value only in case there are no organic acids present, or not an appreciable amount of them. It is treated with a 1 to 10 normal solution of soda and litmus or phenol-phtallëin; 1 c.c. of the 1 to 10 soda solution neutralizes 0.0365 HCl.

Second method: As suggested by Günzburg, we can employ the phloroglucin-vanillin reaction for an approximative quantitative determination of HCl, by remembering that the reaction still positively takes place in the presence of 0.05 per thousand of HCl. Hence we have to dilute the stomach-fluid with a definite quantity of distilled water so long as the reaction is produced sufficiently to be recognized. Since Günzburg's reaction is not disturbed by lactic acid, the simultaneous presence of lactic acid does not interfere with this method. It is still very desirable that there should be an exact revisional proof of this method.

6. Examining the digestion in an incubator. The examination of the digestive power of the gastric juice is of especial value for demonstrating pepsin. At any rate, experience shows that when there is free muriatic acid, pepsin is usually present; on the other hand, when muriatic acid is absent, no pepsin is present, for the reason that the mucous membrane of the stomach does not secrete pepsin itself, but secretes its zymogen, propepsin, and because muriatic acid has the exclusive, or at least the chief, power to form pepsin out of propepsin. For these reasons, it may suffice, in most cases, to examine for muriatic acid alone. But the thorough examination is of the greatest value for arriving at a complete judgment.

We test the digestive power of the gastric juice upon a piece of the white of a hard-boiled egg. A piece about a centimetre square and a millimetre thick placed in a reagent-glass full of normal stomach-fluid should be dissolved in about an hour. If the solution is delayed, or

does not take place at all, it proves that there is a deficiency in the normal amount of pepsin only when we are able to determine that there is also a deficiency in muriatic acid. For this reason, it is best to conduct the examination simultaneously in two reagent glasses, to one of which a few drops of HCl have been added.

The coagulating effect of the gastric juice—that is to say, of the rennet-ferment—upon the casein of milk is proved by the fact that, at the temperature of the body, neutralized stomach-filtrate with neutral (or amphoteric) milk is coagulated; in fifteen to thirty minutes, if the rennet-ferment is present, there is coagulation of the casein. This test, it seems, can generally be omitted if it concerns nurslings, in whom it is of special interest: for it has been shown that when free HCl and pepsin are present, the rennet-ferment is never absent; even in most cases of absence of both the others, rennet-ferment indeed seems not to be met with, but rennet-zymogen, which requires muriatic acid in order to transform it into rennet-ferment. In order to prove the presence of rennet-zymogen in gastric juice which is deficient in HCl and rennet-ferment, we supply the deficiency by adding HCl and then allow it to stand in an incubator for two hours, after which we apply the test for the ferment mentioned above. In atrophy of the mucous membrane of the stomach, there is entire absence of rennet-zymogen, as well as of HCl and pepsin.

Of the somewhat difficult methods of examining the products of digestion we can here mention the two following: 1. The transformation of the starches into erythro- and achroö-dextrin can be qualitatively followed by means of dilute Lugol's solution (iod. 1 part, iodide of potash 2 parts, aq. dest. 200 parts); it colors starch blue; erythro-dextrin, purple-red; achroö-dextrin remains colorless or becomes yellow. A mixture of starch and dextrin with the first drops of the iodine solution becomes colorless, but upon further addition it becomes red and then blue.

2. Peptone and propeptone in alkaline solution, upon the addition of a solution of sulphate of copper, give a beautiful purple color; albumin makes it a blue-violet; hence, on account of this similarity of colors, it is often extremely difficult to distinguish albumin from peptone, particularly if the stomach-fluid is turbid.

III. The effort has been made in various ways to ascertain what part the movements of the stomach play in digestion. No method

that has thus far been devised meets the requirement; hence, we only mention them very briefly.

The peculiarity of salol that it splits up into salicylic acid and phenol only in the intestine, whereupon the appearance of salicylic acid in the urine is easily proved, has been employed by Ewald to determine the rapidity of the passage of food from the stomach into the intestine. Salicylic acid is recognized in the urine after the addition of chloride of iron by the violet reaction in the urine. In order to recognize the first traces, we must make the test upon an ethereal extract [of the urine. (Compare what is said later regarding the *Urine after the Administration of Medicines.*)]. Ewald found that in health the first positive reaction took place one-half to one hour after it had been taken; when the process of transportation from the stomach had been interrupted, it was later. However, the results of this procedure seem to be quite variable.

The same thing must be said of the use of pills of iodide of potash coated with keratin, which very evidently are preferable, because we do not need to employ the urine in proving the absorption of the iodide, but we can make use of the saliva. But Stintzing has found that these pills are sometimes dissolved in the stomach.

Finally, Klemperer has attempted a method, which, from a purely technical standpoint, is very exact, but is decidedly impracticable. He introduces into the empty stomach 100 grammes of olive oil, and, after a certain interval, washes the stomach out. From healthy stomachs he found that, in two hours, 70 to 80 grammes of the oil had been discharged into the intestine, while in cases of catarrh of the stomach about half, and in one case of atrophy a quarter, of that amount had in the same time disappeared from the stomach. This method is less objectionable, because the oil is sometimes not borne in the patient's stomach—it may even be rejected. But it is much more so because it does not sufficiently irritate the stomach.

Lastly, the absorptive power of the stomach has been frequently the object of examination.

Penzoldt gives 0.2 iodide of potassium in gelatin capsules, and then at once tests the saliva to see whether the capsule was close and free from iodide of potassium upon its outer surface. For this purpose we have the patient, moment by moment, spit upon a piece of filter-paper saturated with a solution of starch, upon which we place a trace of

fuming nitric acid; the appearance of the iodide in the saliva will be recognized by the red and blue coloration of the paper. In health, the iodide will make its appearance, if it has been taken upon an empty stomach or three hours after eating, in from six and a half to eleven minutes; if directly after a meal has been eaten, after twenty to forty-five minutes. In cases of dilatation, if taken upon a fasting stomach, its earliest appearance is after fifteen to thirty minutes. It also seems to be delayed in carcinoma, chronic catarrh, and in fevers.

The question is, whether we can draw a conclusion as to the absorption of the products of digestion from the behavior of the iodide.

The examination of the fasting stomach has for its object the determination of the behavior of the gastric secretion after the completion of stomach-digestion. Hence, it is conducted with reference to the diagnosis of a possible hypersecretion.

Method. Recent investigations upon this subject show that it is very important to avoid making use of the secretion of the stomach which results from any mechanical irritation. Hence, we must be very cautious and proceed very rapidly. We recommend a Nélaton's sound, without an eye, but, instead, a number of fine openings at the end, which is to be introduced into the stomach some hours after we have washed it out in order to make sure that it was empty. Or, still better, we first determine the duration of digestion, then we allow the stomach to be quiet after the expiration of the last meal. Then a stomach-pump is quickly introduced; aspirate, withdraw the sound, and empty it into a vessel. Next we examine the fluid thus obtained as to its reaction, and, if acid, for muriatic acid: further, as to its digesting qualities. For passing judgment upon the results of this procedure and its diagnostic significance, see the following pages.

Finally, on account of its historical interest, we mention here the method given by Leube, but superseded by his experimental digestion. He introduced ice-water into the empty stomach and then aspirated it, in order to obtain for examination the gastric secretion pure—that is, diluted with water.

Results of the examination of stomach-digestion: their value.

1. If the examination of the duration of digestion shows that it is not prolonged, then, as a rule, the process of digestion is normal; but

the period of digestion may be shortened, and this sometimes is the case when there is superacidity. If the period of digestion is prolonged, this must be further investigated.

2. Free muriatic acid, which belongs to the time when normal digestion is at its height, may be completely wanting (inacidity, anacidity). This almost uniformly occurs when there is complete destruction (corrosion) of the mucous membrane of the stomach, when it is atrophied, or has undergone amyloid degeneration. Further, inacidity is almost always present in carcinoma ventriculi with dilatation, more rarely, although also very frequently, in all other kinds of dilatation. Of these we must mention especially that which occurs with chronic gastric catarrh. The dilatation produced by the scar of an ulcer (at the pylorus), or accompanying an ulcer, is associated with diminution or absence of free HCl. Subacidity, or even inacidity, is further observed in severe anæmia of all kinds and with fever, and, lastly, in certain cases of nervous dyspepsia.

Accompanying this condition is the more or less markedly increased formation of lactic acids (butyric, acetic acids, alcohol)—a sign of abnormal fermentation. In very severe cases it may result in fetid decomposition of the contents of the stomach. Moreover, for an unusual length of time or continuously, there may be undigested masses or fine particles of meat.

For reasons that are readily understood, the behavior of the stomach in cases of phthisis has been very much studied; the results vary in a very remarkable degree. The general conclusion from these examinations (Liebermeister, Hildebrand, Brieger) seems to be that in cases of severe phthisis with continued fever, very often no free HCl, sometimes even no rennet-zymogen, is found, but that free muriatic acid is also sometimes wanting in remittent fever. At any rate, the examination of the stomach-digestion in phthisis for prognostic and therapeutic reasons is to be recommended in every single case.

3. Increased amount of HCl at the height of digestion, shortening of the time (normal maximum of one hour) during which lactic acid is present, are signs of superacidity. Thus the period of digestion is shortened, or normal, or sometimes even prolonged. As evidence of disturbed amylolysis, we have unchanged starch during the whole period of digestion.

Superacidity is present in the majority of cases of ulcer, also in certain nervous dyspepsias (gastroxynsis, pyrosis hydrochlorica), lastly in acute and sometimes in chronic gastric catarrh. It is also observed in the forms of insanity accompanied with depression.

4. It has been shown by recent investigations (Schreiber, and particularly E. Pick), regarding the significance of the presence of acid-secretion of the stomach, that a positive conclusion from the examination can only be drawn with caution, because the irritation of the sound seems to stimulate the stomach to pour out its secretion very rapidly. We can only diagnose supersecretion (hypersecretion), when by a rapid, careful procedure at least about 200 c. c. of acid gastric secretion are obtained.

Supersecretion occurs in the gastric crisis of tabes and certain neuroses, as hysteria and nervousness. It is sometimes also observed with *ulcus ventriculi*, in individual cases of carcinoma, and in acute and chronic catarrh.

Emptying the stomach for therapeutic purposes, or washing it out, must be undertaken, in the first place, in cases of recent acute poisoning, and frequently for the purpose of diagnosis. This is the case in almost all cases of poisoning, where the poison has been swallowed. But it must be remembered that in poisoning with substances that are corrosive, as acids and alkalies, on account of the danger of perforation of the œsophagus or stomach, the sound must be used with the greatest caution, or even not at all. The detection of the kind of poison in the contents of the stomach belongs to toxicology. Some poisons entirely escape detection.

What has been said above regarding the examination of the contents of the stomach, explains the therapeutic use of washing out the stomach when it is diseased, in that it can be employed for observing the course of the disturbance of digestion in diseases of the stomach. For instance, it is evident from what has been said that it is not without value occasionally to institute a daily washing out of the stomach, in case it is diseased, to determine whether it contains lactic acid many hours after the last meal was taken. Also, frequent microscopical examination of the sediment of the rinsings of the stomach (in *sarcina ventriculi*, etc., see *Vomit*) is of undoubted value.

VOMITING, AND THE EXAMINATION OF WHAT IS VOMITED.

The act of vomiting consists of one or several strong forcible contractions which occur simultaneously in the oblique abdominal muscles and the diaphragm. In this way the stomach is compressed, and, by the simultaneous opening of the cardiac orifice, its contents escape upward. Otherwise the stomach takes no active part in expelling the food. From the not infrequent presence of bile in the last portions that are vomited toward the end of a severe effort at vomiting, it is evident that the pylorus also sometimes does not entirely close.

In this connection we do not include the vomiting, or rather the expulsion of food from dilated parts of the œsophagus when there is stenosis or diverticula. (See Examination of the Œsophagus.)

Vomiting may occur in a great variety of ways, and in diseases which differ greatly in character. We suppose that the so-called vomiting-centre is situated in the oblongata. This may be stimulated from the periphery, chiefly through the sensory portion of the vagus, and so give rise to reflex vomiting. Moreover, it may be stimulated directly or by impressions from other portions of the brain (central vomiting).

Children generally vomit easier than adults. There are also individual differences. Clinically, we distinguish:

1. Vomiting occasioned by reflex influences from the stomach. It occurs in all diseases of the stomach, but also in irritation of the mucous membrane of the stomach by different poisons, certain emetics, etc., and also by overloading the stomach.

2. Reflex vomiting caused by other abdominal organs, as from the female sexual apparatus in menstruation, pregnancy, diseases of the sexual apparatus; from inflammation of the peritoneum; also, in renal and biliary colic, etc.

Likewise, vomiting may be caused by irritation or tickling of the fauces. Probably here also belongs vomiting which occurs at the end of a severe fit of coughing, as in whooping-cough and phthisis.

3. Central vomiting. It may result from irritation of the brain of various kinds: as different evident diseases of the brain, especially tumors; in the different forms of meningitis; in neuroses, particularly hysteria; and from uræmia. Vomiting occurs also in the beginning of certain acute infectious diseases, as pneumonia, scarlet fever, small-pox, erysipelas, [remittent fever].

Vomiting is almost always accompanied by certain other phenomena: previous malaise, often severe sweating, quickening of the pulse; exhaustion, with the feeling of relief, but also evidences of collapse. In diseases of the brain, it sometimes occurs without any preliminary indisposition, even quite suddenly and unexpectedly.

As regards the time when the vomiting begins, in diseases of the stomach, it often (not always) follows eating. Also in peritonitis, vomiting is often excited by the taking of food; but here also it takes place quite independently of this. The *vomitus matutinus* of drunkards, as a rule, regularly occurs early in the morning, when the stomach is empty. Also in certain nervous dyspepsias there are apt to be attacks of vomiting when the stomach is empty. When there is severe vomiting without phenomena of stomach or other abdominal disturbances, we must take into consideration the other conditions named above—acute infectious diseases, disease of the brain, uræmia, hysteria—according to the circumstances.

The frequency of vomiting is extraordinarily variable, and is of little moment in diagnosis; only that it might be mentioned that in very marked dilatation of the stomach, from pyloric stenosis, vomiting occurs remarkably infrequently, but in most cases tolerably regularly, at intervals of several days (but then very profusely).

There may be eructation in all the conditions in which vomiting occurs. It is observed, especially, in slight and severe diseases of the stomach of all kinds. The odor of the eructation corresponds to that of the contents of the stomach, as a matter of course. (See under Odor of the Vomit.) In individual cases, combustible gases have been observed (marsh gas, and probably also other gases). There occur with nervous persons very distressing and entirely odorless eructations.

THE VOMIT.

When we examine the vomit, we notice the quantity, the macroscopical and microscopical appearance, the odor, and the reaction.

The chemical examination can probably occasionally enable us to judge of the character of the stomach-digestion. This is especially the case in those diseases which we cannot include in a methodical investigation, as, particularly, inclination to hemorrhage, etc. (See above.) Of course, we must consider the relation of the vomiting to

the time of the last meal, and what this meal consisted of. The points of view are to be taken from what has been said above regarding experimental digestion. Where there are macroscopical appearances of blood and coloring matter of bile, we must farther apply the chemical tests for these substances.

The quantity vomited. Here we must consider the time and frequency of the vomiting, as well as the amount of food taken. When there is vomiting from an empty stomach, there is usually only a little mucus, seldom much mucus or saliva that has been swallowed (*vomitus matutinus potatorum*), or more or less pure gastric juice (hypersecretion). In acute infectious diseases, diseases of the brain, uræmia, sometimes scarcely anything at all is vomited.

A vomiting which seems to result from the ingestion of food, but the amount of which considerably exceeds the quantity of food and drink last taken, is an almost mathematically sure proof of dilatation of the stomach. Here the contents of the stomach may accumulate for a number of days and then be thrown off *en masse*, to the amount of several litres.

The macroscopical appearance. This will naturally depend very much upon the food taken. It was mentioned above, when speaking of the experiments with digestion, that under some circumstances we can form a conclusion regarding digestion by the comminution of the food. Some foods, as coffee, cocoa, red wine, huckleberries, etc., markedly color the vomit, and may sometimes give rise to mistake, if it is superficially examined, by causing one to think that there has been hæmatemesis (the laity being not infrequently thus deceived, and hence we must be very careful in accepting the anamnesis). When preparations of iron have been taken, the vomit is black; but it is also sometimes black in acute lead-poisoning. Apart from the food, we can, from some prominent constituents (when the contents of the stomach are abnormal), make certain important distinctions in what is vomited, just as in the sputum.

Watery, watery-mucous, mucous vomit. The first and the second named may ordinarily have two very different meanings. In both cases we have a somewhat turbid fluid, resembling saliva or fluid mucus, which is vomited from a fasting stomach. It has an alkaline reaction, and usually indicates chronic gastric catarrh. The fluid consists of mucus from the mucous membrane of the stomach, and of

saliva that has been swallowed. In this way the frequently mentioned "water-brash" of drunkards (*vomitus matutinus potatorum*) especially manifests itself in the early morning, immediately after rising. Also such vomiting occurs (rare) in *nervous dyspepsia*. If the fluid smells sour, and has an acid reaction, and if it shows the muriatic acid reaction and power of digestion, then we have gastric juice secreted by the empty stomach: hypersecretion. This gastric juice is often over-acid—hypersecretion with hyperacidity (over 0.3 per cent.). This occurs in certain kinds of nervous dyspepsia (gastroxynsis, gastroxia; also hysteria; tabes), but also in dyspepsia following healed ulcer, and acute and chronic gastric catarrh. In these cases the quantity vomited may amount to several hundred grammes.

A special form of watery-mucous vomit is peculiar to Asiatic cholera. In this disease there is often vomited a great quantity of alkaline, stale-smelling fluid, like rice-water (very like the stools of cholera) (which see). The small flocks, like rice, are mucous flocks. It is not possible to separate mucous from watery-mucous vomit. Sometimes a great quantity of mucus is observed in chronic catarrh of the stomach.

Vomiting of bile. As previously mentioned, bile may be mixed with every vomit, and this is especially apt to be the case in very severe efforts at vomiting, so that toward the end almost pure bile is ejected. The vomit looks yellowish-green or green, and smells decidedly bilious. It exhibits the reaction of the coloring matter of the bile. (See Urine.)

A grass-green bilious vomit, occurring with tolerable uniformity, with every act of vomiting whether violent or not, is a not unimportant peculiarity of peritonitis, and of marked obstruction of the bowels.

Bloody vomit, vomiting of blood (*hæmatemesis*). Blood from the nose, throat, and œsophagus may become mixed with the vomit in the act of vomiting. Small quantities, in streaks, are usually of no significance. Large hemorrhages from the œsophagus, as in varices of the lower portion of the œsophagus, and in cirrhosis of the liver, usually after it has run down into the stomach, cause severe hæmatemesis. Also blood from the nose, and even from the lungs, may reach the stomach and be vomited up (see p. 170). We must be careful not to confound such an occurrence with hemorrhage of the

stomach. In doubtful cases the anamnesis is of less value than the examination of the stomach, nose, and lungs. (See p. 170 for further particulars regarding the distinction of hemorrhage of the lungs from that of the stomach.)

Small points of blood and streaks in the vomit, moreover, even if they come from the stomach, according to our experience, are generally without significance: that they are from the stomach is proved by the presence, not infrequently, of bloody suffusion of the mucous membrane of the stomach at the autopsy. Streaks of blood frequently recurring, whose source the autopsy proves to be the stomach, are not at all uncommon in cirrhosis of the liver.

Bloody vomit, from hemorrhage of the stomach, takes place in ulcer of the stomach, carcinoma ventriculi, portal engorgement from cirrhosis of the liver, closure of the portal vein (rarely in general venous stasis), in severe lesions of the mucous membrane of the stomach by corrosive poisons, also in general hemorrhagic diathesis (see cutaneous hemorrhages), in yellow fever, melæna neonatorum; in the last-named cases there usually occurs simultaneous hemorrhage of the bowels. Very decided, and sometimes fatal, hæmatemesis is chiefly peculiar to ulcus ventriculi (also melæna). In carcinoma we notice very frequently repeated, but always moderate, hemorrhages. Moreover, in all these conditions the vomiting of blood may be entirely wanting, either because there is no escape of blood into the stomach, or because the blood is not vomited.

When we suspect hemorrhage of the stomach, which is not vomited, we are to examine the stools (which see). Sometimes, in ulcer of the stomach, the patient becomes suddenly pale, may collapse, or may even die from a hemorrhage of the stomach, without there being any vomiting of blood. In order to observe exactly an ulceration of the stomach, it is particularly necessary to observe uninterruptedly the stools.

Pure blood is seldom vomited, unless there is a great quantity of it, or it is vomited directly after or during the hemorrhage. Moreover, it is never of so clear an arterial color as in hemorrhage of the lungs. The blood is almost always more or less changed by the gastric juice: it is very dark, black-brown, and has an acid reaction. If it has been in the stomach for some time, as is quite often the case in carcinoma with dilatation, because the hemorrhages are usually small and there

are long pauses between the hemorrhages, under the influence of the acids, by the breaking-up of the red corpuscles and the hæmoglobin, and the appearance of hæmatin, it becomes coffee-brown and also of the consistence of coffee-grounds. Then, in case it is abundant, it is easy, with some experience, to recognize it; yet it is easy to confound it with other substances, as coffee, cocoa, etc. (See above.) For this reason, and because here the microscope is deceptive, it is preferable, in this case, always to make a special test of the blood.

Testing the blood: 1. Very correctly, the hæmin test is generally employed, because it is certain and distinct. The following is the best way to make it: Some of the coffee-grounds material is filtered; a

FIG. 92.



Crystals of hæmin. Zeiss's apochromatic lens No. 8, eye-piece No. 8, camera lucida.
Magnified about 300 diameters.

little of this is to be evaporated in a watch-glass. Scrape off some of the dried material, mix it with a trace of finely-pulverized salt, place the dried mixture upon an object-glass, cover it with a glass cover, and allow one or two drops of glacial acetic acid to flow under it; then the acetic acid is again evaporated very slowly, and, after it is thoroughly dry, one or two drops of distilled water are allowed to flow under to dissolve any crystals of salt that may be present. Under the microscope, there can be seen crystals of hæmin (hydrochlorate of hæmatin) in coffee-brown or reddish-brown crystals in rhombic plates, which must be considerably magnified, as the crystals are very small.

The following method (an adaptation to the vomit of Heller's test for blood-coloring material in the urine, which see) leads to a result more quickly: We place some of the filtered stomach-fluid in a reagent-glass, with a like quantity of normal urine, make it strongly alkaline with liquor potassæ, and heat it. The urine-phosphates are precipitated and carry with them the coloring-material of the blood, and when blood is present, we have a cloudy, flocculent, reddish-brown deposit.

Vomiting of pus. Pus, as a macroscopically visible constituent of the vomit, is somewhat unusual, and is only observed in isolated cases of phlegmonous gastritis or of abscess of a neighboring organ, breaking into the stomach. Probably it can then only be observed when it pours into the stomach in such quantities and so quickly that it makes the contents of the stomach alkaline, for only thus will it avoid immediate digestion. Regarding separate white corpuscles, see below.

Fæcal vomiting (miserere, ileus). In this condition, either there are considerable quantities vomited which do not look distinctly feculent, probably coming rather from the stomach or the upper portion of the small intestine, and the fecal addition is betrayed by its odor, or there are distinctly fecal masses, even balls of excrement. This kind of vomit occurs in severe diffuse peritonitis and in serious occlusion of the bowels (see Inspection and Palpation of the Abdomen). It indicates an extremely serious and, in most cases, fatal condition; yet it does not by any means have the absolutely fatal significance which was formerly ascribed to it.

As visible admixtures which can be seen with the naked eye, are still to be mentioned:

Round worms, which come from the small intestine, probably brought into the stomach by the first efforts at vomiting, and are afterward seen in the material vomited up. It is a startling appearance, but in itself has no significance. Also:

Membranous rags of echinococcus, in case one should break into the stomach from the liver or spleen. In these cases, the microscope sometimes shows the scolices and hooks of the parasite (see illustration, p. 183).

Moreover, in individual cases, there are found in the vomit, also, oxyuris, anchylostomæ, trichinæ (see these under Stool).

Microscopical examination. This is of very little independent

value in determining the processes of digestion. In vomiting which takes place during digestion, we, of course, expect to find portions of food in very varying condition, according to the time the vomiting occurs.

Starch-grains in considerable quantity, for the time when the amyolytic digestive period ought to be past, indicate incomplete amyolysis, as is almost always produced by hyperacidity (in consequence of the too early appearance of free muriatic acid).

Mucous corpuscles are found in watery and mucous vomit; epithelium, from the mouth, throat, œsophagus, also sometimes from the stomach, is observed; unchanged red blood-corpuscles are very rare; in hemorrhage of the stomach, the microscope generally is useless, because the red blood-corpuscles are broken up. Also, it is rare to find white blood-corpuscles that are well-preserved.

FIG. 93.

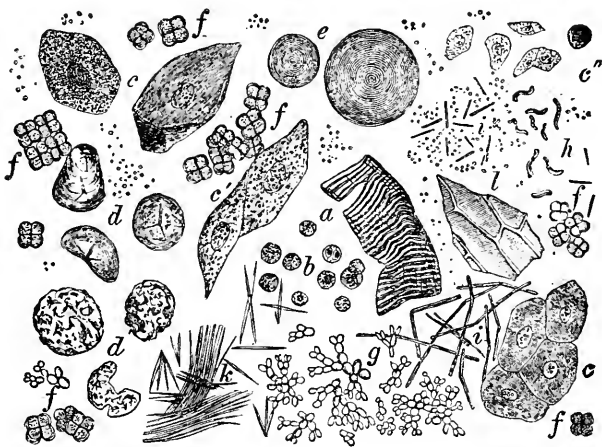

Vomited material (JAKSCH). *a*, Muscular fibre; *b*, white blood-corpuscle; *c, c', c''*, flat and cylindrical epithelium; *d*, starch-corpuscles; *e*, fat-globules; *f*, sarcina ventriculi; *g*, yeast-ferment; *h, i*, cocci and bacilli (those near *h* were once found by Jaksch in a case of ileus, hence arising from the intestine); *k*, fat-needles, connective tissue; *l*, vegetable cells.

Sarcina ventriculi (schizomycetes) and torula cerevisiæ (yeast-fungus) are not entirely without value, as indications that the stomach retains its contents for a long time, as, especially, in dilatation.

Of the two fungi, the sarcina is the more important. If it is not macerated or deformed by pressure with the covering-glass, it is generally easily recognized, when strongly magnified, by its peculiar resemblance to a ball wrapped with a string crossing at right-angles. It is stained a reddish-brown by a weak solution of iodine, or iodide of potassium.

Torulae of different kinds and sizes (the latter very much like a small white blood-corpusele, generally smaller) are easily distinguished as small bodies strung along together, sharply defined, which refract the light and are egg- or elliptical-shaped. Isolated ones are observed in the contents of the stomach with normal digestion. When the quantity is considerable, it shows that it has been a long time in the stomach, whose contents have undergone alcoholic fermentation.

Other different kinds of bacilli and cocci, which have only recently been carefully studied, are found in the vomit, but as yet they have no diagnostic value.

Also, there are found in the vomit aphthæ (probably originating in the œsophagus, see above) and favus fungus, achorion Schönleinii.

Reaction of the vomit. This is usually acid from muriatic or organic acids (see above, under Digestion). It may be alkaline when a considerable quantity of blood is vomited, as in water-brash, the watery vomit of Asiatic cholera; also, rarely, in putrid vomiting, as in ulcerating cancer of the stomach, and in the vomiting of kidney-disease (see below, under Odor). Moreover, œsophagus-vomiting manifests itself by being always alkaline (see under Examination of the Esophagus).

Odor of the vomit. In many respects this is very important. Thus, particularly the presence of fatty acids is recognized with great certainty by their characteristic pungent odor.

The odor is very important in many poisons, as with phosphorus (odor of garlic), bitter almonds, or nitro-benzole (odor of bitter almonds), ammonia, carbolic acid, etc.

There is fecal odor with ileus, cadaveric odor in ulcerating carcinoma, also in fresh hemorrhage of the stomach.

The odor is ammoniacal in nephritic patients, especially when there is uræmia. It is thought to result from the separation of urea by the mucous membrane of the stomach, by the urea in the stomach changing into carbonate of ammonia.

EXAMINATION OF THE FECES.

As in examining the contents of the stomach, the inquiring physician must pursue his task from two points of view :

On the one hand, he is to draw a conclusion from the character of the intestinal discharges as to the intestinal digestion, and any possible disturbances of it from the abnormal chemical changes, and also an opinion regarding the present disease. On the other hand, he is to form a diagnosis directly from the occurrence of certain products of disease, or even of substances generated by disease, as intestinal parasites or microorganisms found in the stools. Unfortunately an explanation from the point of view first mentioned is difficult for several reasons : first, because we have to do with the last step of an extremely complicated process, and then, in many respects, we do not sufficiently understand this process itself, or its pathological variations. With reference to the other point, and especially regarding organic exciting causes of disease, we have only a few sure principles, part of which are old, and part have only recently been acquired.

We have to consider :

The intestinal discharges, with reference to their frequency and their possible, usually subjective, accompanying symptoms.

The more particular examination of the stools : quantity, consistence, or form, color, odor. In addition, there are the admixtures which are visible by the naked eye, and those to be seen only by the aid of the microscope.

As yet, it is not possible to form an estimate of the intestinal digestion by the character of the intestinal fluid. It is well known that sometimes (especially by evacuating the fasting stomach) there enters into the stomach a fluid mixed with bile which is to be regarded as a mixture of pancreatic and intestinal fluids, since with an alkaline reaction it digests albumin, starch is changed into dextrine and maltose, and fat is split up. But this occasional occurrence has not yet been employed for consecutive examinations. Boas recently, after carefully rinsing out the stomach with soda and having it tightly squeezed, has endeavored, by employing an œsophageal sound, to obtain the intestinal juice. But his results have not yet been completely published ; hence it is not possible to form an opinion as to what assistance his method will be for the purposes of diagnosis.

Intestinal discharges. In health their frequency varies individually very much. Ordinarily, at all ages, excepting nursing children who have three or four movements a day, there is one stool in twenty-four hours: but many persons regularly have a movement twice in the twenty-four hours, while others only have one in two or three days, or even at longer intervals, without experiencing any inconvenience [or disorder]. But in scarcely any other way do physiology and pathology so much encroach upon each other's limits as with reference to the frequency of the intestinal discharges, for sometimes a movement even once in two days may be troublesome, and the physiological habitual constipation, in many cases, cannot in any way be distinguished from the pathological condition.

Constipation, or, better, pathological constipation, is called obstipation; the expression obstruction (severe obstruction) is often intentionally used for constipation in a serious sense. The opposite to this condition is looseness, diarrhœa.

The frequency of the discharges is directly connected with the quantity of food taken; hence a person who is fasting is always constipated. This point must often be thought of. The character of the food, too, has an influence upon the frequency of the discharges, and upon the passage of food through the intestinal canal. (See under "quantity.") Thus rapid peristalsis causes diarrhœa, slow peristalsis, obstipation. Hence, any mechanical obstruction in the alimentary canal brings on constipation.

Diarrhœa is the most important sign of intestinal catarrh. This is brought about by errors of diet, by cold, by infectious causes, as the intestinal catarrh of typhus, dysenteric inflammation of the large intestine, and also many intestinal catarrhs which were formerly referred to the cause first mentioned. In this condition, the stools are always thin (see the second section below and Consistence of the Stools); their frequency may be increased, even to occurring hourly, or yet oftener.

Moreover, medicines or poisons may increase the peristalsis alone, or intestinal catarrh, and thus result in diarrhœa.

In all these cases the increased peristalsis increases the fluidity of the intestinal contents, even causing effusion from the intestinal wall into the intestinal cavity (cholera), until we have the condition of diarrhœa. (See below.)

Obstipation may be a disease which is relatively harmless, although very troublesome, becoming habitual. But it is of much greater diagnostic significance, however, as an early sign of peritonitis from paralysis of the intestine. Of still greater importance is severe obstruction in all forms of stenosis of the intestine, as fecal accumulation, particularly in the cæcum; strangulation, invagination, intussusception of the intestine; new formations, scars in the intestinal wall, compressing tumors external to the intestine; constrictions, bends produced by peritoneal exudations. In many cases of chronic intestinal occlusion, as in chronic peritonitis, constipation alternates with diarrhœa.

But the condition of obstipation or diarrhœa is still more affected by a possible increased or diminished abstraction of fluid from the intestinal contents; the more fluid there is, the quicker it passes through the bowel. Now, if the intestinal contents part with much fluid when there is slow peristalsis, as a result of prolonged retention, they become dry and hard, hence are carried forward with difficulty. If the peristalsis is quicker, the contrary exists. The effect of slow or quick peristalsis is felt in the transit [of the intestinal contents], causing either obstipation or diarrhœa.

The severest diarrhœa occurs in *cholera Asiatica*, because in this disease there is great effusion of fluid from the intestinal wall into the lumen of the intestine.

1. It is to be understood that an ordinary constipation and severe obstruction are to be sharply distinguished from each other, for a quite ordinary obstipation may be very obstinate. Here the decision is made by considering other phenomena, as vomiting, pain, and particularly by examining the abdomen. This can never be omitted in any sudden attack of obstipation, special attention being given to the hernial orifices and the cæcum.

2. Persons who eat little or nothing, whom many things either strangle (stenosis of the œsophagus), or cause vomiting, as in diseases of the stomach, but especially pyloric stenosis, in which case there is infrequent but considerable vomiting at a time, cannot have frequent stools; hence they must be obstipated. Such cases are easily overlooked, particularly if the patients complain a good deal of obstipation.

The special peculiarities which precede the examination of the bowels are of diagnostic importance :

Pain with the movements. There will be pain at the anus or at the lower portion of the abdomen in all kinds of inflammatory affections of the anus, the rectum, or their neighborhood. We have severest pain when the lower portion of the rectum is compressed by a large inflammatory (purulent) exudation, especially in the exudation of peri- and para-metritis ; also in fissure of the anus and abscesses from peri-proctitis (see Surgery). Likewise, in carcinomatous, syphilitic, gonorrhœal stenosis of the rectum, but also in the usually harmless hemorrhoids, the pain at stool is characteristic. Sometimes in all these conditions, and particularly in all inflammations of the large intestine, but most pronounced in dysentery, there is usually painful straining at stool, and pain after it—*tenesmus*. Whenever there is pain at stool there must be a careful inspection of the anus and palpation of the rectum.

Involuntary discharges of the bowels, *incontinentia alvi*, are most frequently dependent upon the cloudiness of intelligence which accompanies any severe disease ; but they may result from paralysis, particularly in diseases of the spinal cord. If the stools are thin, then incontinence occurs with less loss of intelligence than if they are firm. Slight incontinence manifests itself sometimes by the fact that the patient must hasten to go to stool as soon as he has the impulse. Incontinentia is opposed to *retentio alvi* as regards its neurotic origin. (See Examination of the Nervous System.)

Physical and chemical peculiarities of the feces. Assuming an unobstructed passage, the amount of the stools is determined by the quantity and quality of the food taken. In the latter respect it depends upon how much of the food is digested and taken up ; hence, all vegetable foods make copious stools.

Also, the quantity of the stools is increased in diarrhœa, because too little of the fluid portion of the intestinal contents is taken up. The greatest increase occurs in cholera, from the effusion of quantities of fluid into the intestine.

Enormous quantities of firm, solid stools may be passed after prolonged obstipation or serious obstruction.

We may form an estimate from the amount of the stools, or of their weight, of the resorption of food, if we know how much of resorbable

substances the food taken contains, and if we can decide that a particular stool comes from the food taken within the period of observation, by the admixture of substances which give a distinctive color. However, we neglect the addition made to the feces during digestion from the digestive juices. On the one side, there is a too rapid movement of the food along the alimentary canal, and, on the other, disturbance of the resorption of the food. We learn from the recent investigations of F. Müller, that in mild enteritis and in mild amyloid degeneration only the fat, but in severe cases of disease of the mucous membrane all the nutritive material, is poorly resorbed; further, that a deficiency of pancreatic juice makes no special disturbance; deficiency of bile and tuberculosis of the lymphatic glands disturb the absorption of fat (see below): finally, that absorption is only slightly disturbed by accumulation in the intestinal canal.

Consistence, or form of the stool. Normally, it is firm or mushy.

The fact has already been stated, and the reason given, why in diarrhœa the stool is more or less thin, or like thin soup. The stool may really be watery, as in cholera Asiatica, but also in all severe acute cases of enteritis, also in dysentery. The dried fecal balls which are passed with or after obstipation are very hard.

The form of firm feces does not have any independent value. Especially the stool which is like the stool of sheep (small, hard balls, about the size of a cherry) is not characteristic of stenosis of the rectum, because it also occurs in ordinary constipation. Band-like flat scybala rather indicates stenosis, more especially compression of the rectum antero-posteriorly.

Here may be mentioned the arrangement in layers of the thin and the mushy stools which not infrequently are met with. In these the firm portions settle so that the upper part of the stool consists of a clear watery layer. This is the kind of stool we have in typhus abdominalis [typhoid fever], but we also have it in other thin stools, and it is very commonly a result of the admixture of urine.

Odor of the stools. The variations from the normal fecal odor not infrequently have distinct diagnostic value. In nursing children a slightly sour odor is normal.

The alcoholic stool is offensive, but does not always really have a foul odor. An odor like fatty acids (and acid reaction from acid fermentation) is peculiar to the slight forms of infantile diarrhœa. A

decidedly foul smell (putrid albumin, alkaline fermentation) belongs to severe forms of this disease. The stools of cholera and dysentery often smell flat, like semen (cadaverin, Brieger). Cadaverous, foul, stinking stools characterize gangrenous dysentery, carcinomatous or syphilitic ulceration of the rectum. When blood or pus is mixed with the stool in considerable quantities the fecal odor may be masked and replaced by a mild, stale odor. Often the stool is ammoniacal, from admixture with urine which has decomposed.

Reaction of the stools. Only in children, particularly nurslings (in whom it is normally slightly acid) is the reaction diagnostic, and gives important indications for treatment. Decided acid reaction is observed in acid fermentation in the intestinal canal; alkaline reaction in alkaline fermentation with putrid albumin. In both conditions there is intestinal catarrh.

Color, constituents, admixtures of the stools (so far as they can be recognized by the naked eye). The normal color of the stools varies from bright- to blackish-brown. It is in part due to the addition of bile (that is, products of decomposition of the coloring matter of the bile, particularly hydrobilirubin), and partly to the food. By the latter, the stool may be unusually colored, as by huckleberries, which color it black, and may be confounded with blood.

In the normal stool, portions of food can be recognized with the naked eye, if things that cannot be digested—like cherry-stones, particles of wood, etc.—have been swallowed. We also see grape-seeds, the skin of many kinds of fruit, etc. Large fibres of connective-tissue, undigested portions of grains, mushrooms, etc., may sometimes be met with in the stools, if the patient has eaten rapidly or has swallowed his food in quantities. With the naked eye, we can see fibres and pieces of undigested substances, the old designation for which was *lientery*, like portions of muscle, flocks of casein, in the stools of children; sometimes somewhat friable, perhaps slimy; or even portions of starch. All of these indicate disturbance of digestion in the small intestine, or also in the stomach, as is seen in intestinal catarrh, or catarrh of the stomach, or in the dyspepsia of fever, with increased peristalsis.

In the rare condition of communication between the stomach and colon (perforating ulcer of the stomach), we find the coarsest admixture of digestible portions of food in the stool.

Occasionally, extraordinary forms of remains of vegetables (orange-like, etc.) have given rise to mistake. With children, hysterical persons, and imbeciles, we must be prepared for all sorts of preposterous foreign bodies in the stools.

The stools of nurslings and of adults who live upon milk illustrate the appearance of the stool when colored only by bile-pigment. Firm stools are generally darker than thin ones, because more concentrated. In severe diarrhœa, but especially in cholera, dysentery, also severe enteritis, after the first evacuations have swept out the intestinal contents, the stools always become brighter, afterward grayish-white and watery, or, in dysentery, colored by blood, etc.

When there is diminished flow of bile into the intestine, as occurs in hepatogenous icterus, the stools are lighter. If the bile is cut off, they are grayish-white, clayey, and faintly glistening. This is due not alone to the want of the transformation of the bile-pigment, but also, it would seem, chiefly to the large amount of fat in the so-called acholic stools. The increased amount of fat, in turn, shows diminished digestion of the fat, due to the deficiency of bile.

We designate as bilious stools those which contain the coloring-matter of the bile unchanged. A quick passage of the contents of the intestine, and profuse diarrhœa, always bring about this kind of stool. We see it most frequently in acute intestinal catarrh, especially in children; perhaps there is here also an increased effusion of bile. The bilious stool is bright-yellow, green-yellow, or green, and has the reaction of the coloring-matter of the bile. We filter it, and treat the filtrate as we do when testing for bile in the urine (which see).

Mucous stool. When mucus can be distinctly recognized in the evacuations of the bowels, it always indicates catarrh of the mucous membrane of the intestine, and hence something pathological; though in many cases the disturbance in the intestines may be regarded as without significance. There are unnoticeable transitions from the normal secretion of mucus by the intestine to a decided stimulation by chemical or mechanical irritation, even to a true enteritis. Nothnagel considers that small, visible particles of mucus interspersed in firm stools belong to a normal condition.

Larger masses of mucus, in the form of more or less thick shreds, always indicate with greater probability a catarrh of the large intestine.

Certain small, roundish particles of mucus, like sago granules, are said to come usually from this portion of the intestine. Catarrh of the large intestine then can be definitely diagnosed from the stools, if firm fecal balls are passed which are covered with mucus. Sometimes we find spread over the scybala a layer of thick, tough mucus. An abundant admixture of mucus in thin stools occurs, especially in acute intestinal catarrh, if the large intestine is also affected, and in catarrhal dysentery.

We designate as intestinal infarction cylindrical tubes which consist entirely of mucus (or partly of fibrine), and which form casts of the large intestine. In rare cases they occur in chronic catarrh of the large intestine, and are usually passed with great pain (mucous colic).

If there are fine and equal portions of mucus in solid fecal balls, we then think of catarrh of the small intestine. But, also, mucus occurring in thin stools may have its origin in the small intestine. Then it is usually finely divided, and is soft. In cholera Asiatica (also in cholera morbus) the stools are watery, and contain particles of mucus which look like boiled rice (rice-water stools).

Nothnagel utters a warning against regarding all small, slimy-looking particles in the stools as mucus. They may come from the food. The chemical reaction determines in a doubtful case.

Watery stools. To these we have already referred repeatedly. They occur in severe acute intestinal catarrh, in dysentery, and in cholera Asiatica, and express profuse diarrhoea, by which the intestinal contents are completely expelled. Even bile, or its transition products, are not usually found in watery stools.

Fatty stool. This is usually recognized by its slightly glistening, and its greasy look. When there is much fat, the stools are clayey-looking, or whitish, even when the bile is not cut off from the intestine. When the stool contains considerable fat, moreover, it has the peculiarity of becoming softer and more glistening with the elevation of the temperature of the body. For further regarding fatty stool and its occurrence, see under Microscopical Examination.

Bloody stool. This has an extremely variable appearance, dependent upon the more or less change in the blood, and whether it is not at all, or is intimately, mixed with the feces.

When firm scybala are covered over with blood, it indicates hemorrhage of the rectum, or large intestine. If the blood does not look

at all changed, it is from the rectum or anus. When there is an admixture of blood with thin stools, if the blood retains its color, and is not intimately mixed with feces, mucus, or pus, it points with tolerable certainty to the large intestine or anus. However, there may be intimate mixture of blood even in hemorrhage from the large intestine, and in watery stools, as in meat-juice stools in dysentery, and in severe catarrh of the large intestine in children.

Hemorrhage of the large intestine occurs most frequently with hemorrhoids in the lower portion of the rectum, carcinomatous ulceration, again chiefly from the rectum, and in other ulcerations of the large intestine of any kind, as in dysentery.

When the blood is intimately mixed with the feces, it indicates hemorrhage from the small intestine or from the stomach. Besides, in this case the blood is usually more or less changed, brownish-red, even deep-black, the color of tar, from breaking up of the red corpuscles and of hæmoglobin (formation of sulphate of iron?).

The degree of change which the blood undergoes depends upon the length of time it has been in the intestinal canal, and the way in which it is mixed with the feces. There is the least change, the blood sometimes remaining red, with preservation of the red corpuscles, when a large quantity of blood from the lower part of the ileum passes quickly into the colon, because of existing diarrhœa. This happens with the profuse hemorrhage of the bowels in typhus abdominalis. Blood which comes from the stomach, duodenum (in ulcer of the stomach, *ulcus duodenale*) becomes as black as tar before it is evacuated, because of its slow transit and the usual absence of diarrhœa. Moreover, with gastric hemorrhage, the blood may appear in the stool like coffee-grounds (see above, p. 363).

In most cases, in order to prove the existence of blood, it does not suffice merely to examine with the naked eye. Then we employ the microscope to make out the red blood-corpuscles, and if they are broken up, then it is necessary to test for hæmin. (See above, p. 363.)

1. We have already repeatedly spoken of the importance of giving continued attention to the stools whenever there is a suspicion of hemorrhage in the alimentary canal. This obtains particularly with ulcer of the stomach or duodenum.

2. It is evident that any blood which reaches the stomach, having its origin in the œsophagus, or coming from farther up and being swallowed,

may appear in the stools (see examination of the nose, expectoration, œsophagus).

Purulent stools. A considerable quantity of pure pus is not so very rare, happening as a sign of a rupture somewhere of a collection of pus (generally of a parametric exudation) into the intestines, especially the rectum. Therefore, whenever there is a febrile affection of the abdomen, where the formation of the pus is either made out, or at least is thought to be possible, we ought always, but especially if there has been a sudden decline of the fever, carefully to examine the stools as well as the urine (which see).

Moreover, dysenteric, catarrhal, syphilitic, and carcinomatous, ulcerations of the large intestine produce some, or possibly considerable, accumulation of pus, according to their extent; likewise, periproctitic abscesses.

Gall-stones, enteroliths. The former come either from the gall-bladder or the intrahepatic gall-passages (intrahepatic stones, much smaller than the others, rare) through the ductus choledochus, and, as they come into the intestine, often produce severe colic and jaundice. Whenever there is abdominal colic, particularly if it is connected with jaundice, and generally whenever there is jaundice, we must look out for gall-stones in the stools. In rare cases, if there is suppuration of the gall-bladder, they come from the gall-bladder, there being adhesion with the colon, into which they break, and thus directly reach the intestine.

When we are looking for gall-stones the stool must be passed through a sieve. If it is formed or mushy, it must be broken up by pouring a stream of water upon it. The gall-stones are generally very easily recognized by their shining appearance, smooth surface, and many angled (facets) form. Small, especially intrahepatic, stones may not have facets, and be more crumbling. They consist chiefly of cholesterin, and also contain coloring matter of the bile.

Enteroliths are rare. They usually come from the vermiform appendix, and their centre commonly consists of solid, undigested portions of food, as a cherry-stone, around which have been deposited some lime or magnesium salts.

Portions of tissue from the intestinal canal. In very rare cases, when there is invagination of the intestine, the whole of the portion that is turned in sloughs off, the intestine forming new adhesions,

and thus life is preserved. This entire piece may appear in the stool. Shreds of mucous membrane from the large intestine in dysentery, portions of tissue of carcinoma, or other new formations, may appear in the stools.

ANIMAL PARASITES.

In what follows it will be shown that some of the animal parasites that exist in the human alimentary canal have no pathological significance; others, on the other hand, are very important factors as excitors of disease. The examination for these latter or for their eggs cannot be made too frequently, or too carefully. An examination of the stools for parasites must be undertaken not alone when there are complaints or symptoms which directly indicate intestinal parasites, or in general when there are evidences of intestinal catarrh, but in any case of anæmia, when there is any general nervous depression, in certain other phenomena of the nervous system (see works upon pathology), if the cause of the particular complaint does not appear to be clear. The cases are numberless where, after long fruitless search elsewhere, the discovery of a joint of a tapeworm, for instance, leads to the correct apprehension and treatment of the patient.

In order not to separate what belongs together, we collect here all that is to be said regarding the occurrence of intestinal animal parasites and their eggs in the stools, whether in the examination we employ the naked eye, the simple or the compound microscope.

Tape-worm (cestodes). Its habitat is exclusively the small intestine. It gives rise to very great pathological disturbances (intestinal catarrh, anæmia, nervous manifestations of varying severity). It consists of a very small head and neck, and a ribbon of flat joints (proglottides), several meters long, which constantly push off at the end of the worm, and grow again from above. It clings to the wall of the intestine by its head.

It can be recognized by a single joint, which can easily be seen with the naked eye, or by the presence of eggs in the stools (microscopical examination).

1. *Tænia solium.* This is 2 or 3 meters long. Its head is the size of the head of a pin, glistening gray; the rest of the worm is white, or yellowish-white. Upon the head are four pigmented sucking cups (to be seen with a simple microscope), which surround a crown of chitin hooks, "crown of hooks." The ripe proglottides—

that is, those on the lower end of the worm—are about 10 mm. long, 5 or 6 mm. broad, and are like gourd-seeds (but are smaller). From the peculiarity of these ripe joints, which are continuously thrown off and passed with the stool, we are able to make the differential diagnosis

FIG. 94.

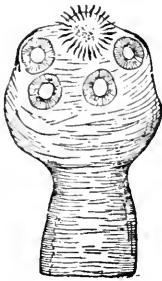

FIG. 95.

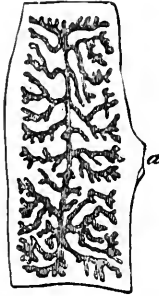

FIG. 96.



Fig. 94.—*Tania solium*, head enlarged. (HELLER.)

Fig. 95.—*Tænia solium*. Ripe joint, magnified 6 times. (HELLER.)

Fig. 96.—Egg of *tænia solium*. (HELLER.)

between this and the other tape-worms. The joints show a longitudinal canal (the uterus), from which, toward both sides, as many as a dozen branches go off which ramify like the branches of a tree.

The eggs of *T. solium* (which require the use of a moderate microscopic power in order to find them, stronger to examine them carefully) are round, and, if they are ripe, have very thick shells (which show radiating lines, and which, with a little pressure upon the covering glass, break into hard pieces. In the finely granular contents we often see a few chitin hooks.

2. The *Tænia meliocanellata*, seu *saginata*, grows to 4 or 5 meters. The head is somewhat larger than that of the *solium*, is also more strongly pigmented. It has no crown of hooks, but four sucking cups, which are much stronger than those of the *solium*. On the whole, the rest of the worm, as respects its individual joints, is fatter and thicker than the first-named. The ripe proglottides are passed, not only by the stool, but wander independently from the anus, having strong, very energetic, independent movements. They are distinguished from the *T. solium* in that the uterus gives off more and finer branches on each side, which divide dichotomously.

The egg of the *T. mediocanellata* looks extremely like that of the *T. solium*, except that on the average it is somewhat larger.

FIG. 97.



FIG. 98.

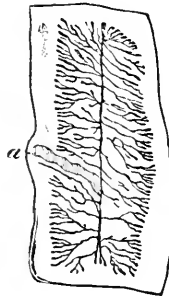

FIG. 99.



Fig. 97.—*Tænia mediocanellata*. Head darkly pigmented. (HELLER.)

Fig. 98.—*Tænia mediocanellata*. Ripe joint, magnified 6 times. (HELLER.)

Fig. 99.—Egg of *tænia mediocanellata*. (HELLER.)

3. *Bothriocephalus lata* (sinus head) is found in Germany, only in the neighborhood of the North and East Seas, of Lake Geneva, and in Northwestern Russia [Sweden, Poland, Belgium, Holland.

FIG. 100.



FIG. 101.



FIG. 102.

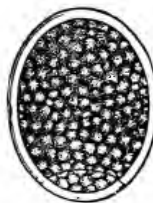

FIG. 103.



Fig. 100.—Head of *bothriocephalus latus*. (HELLER.)

Fig. 101.—Ripe joint of *bothriocephalus latus* enlarged six times. (HELLER.)

Fig. 102.—Egg of *bothriocephalus latus*. (HELLER.)

Fig. 103.—Egg of *bothriocephalus latus*, with developed embryo. (LEUCKART.)

“Low-lying damp regions near the borders of seas and lakes are those in which it is most often abundant.”] It is the largest of the tape-

worms, and reaches to 7 or 8 meters in length. Its head is elongated, and has two narrow, long-drawn out sucking cups. The illustration shows its form and the shape of the uterus.

The ripe joints are not given off singly, but a large piece of the worm is always passed at one time, and then, after a long interval, another; most frequently in the spring and fall.

For this reason we here refer to the finding of the eggs (which are always present in the stools). They are oval (see Fig 102), and much larger than those of two other kinds of tape-worm. The shell is bright brown, relatively thin, and, on one end of the oval, has an opening which is closed with a cover of exactly the same kind. The contents of the egg are granular.

As has recently become known, the bothriocephalus gives rise to severe anæmia, with changes in the blood like those in severe pernicious anæmia; for this reason, and because there are no joints thrown off, this tape-worm is very easily overlooked for a long time.

4. *Tenia cucumerina*, 5–20 cm. long, 2 mm. wide; the head is somewhat long, and has sixty hooks; the last joints are reddish, and have the form of pumpkin seed. Six to fifteen of the eggs lie together in the so-called cocoon. It occurs in dogs, cats, and not infrequently in men, especially children (Leuckart). Its pathological significance is not known. (See Fig. 104.)

FIG. 104.

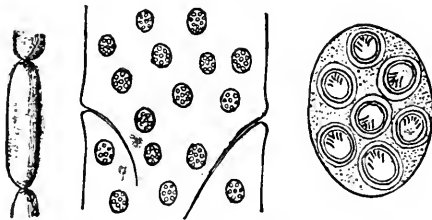

Tania cucumerina (BIRCH-HIRSCHFELD). a, joint, natural size; b, enlarged 12 times; c, cocoon, enlarged 290 times.

Round worms—*Ascaris lumbricoides*. This is easily recognized from its likeness to the common earth-worm. Its habitat is the small intestine. Very frequently it gives rise to little or no complaint, but it sometimes, and especially in children, causes very uncomfortable phenomena of all sorts, particularly of the nervous system. Occasionally, when there is severe vomiting [and sometimes when there

has not been any vomiting at all], it gets into the stomach and is then vomited. Moreover, it may crawl into the ductus choledochus, and thus cause obstinate jaundice. These worms appear in the stools; and sometimes, in sleep, they will crawl out of the anus. They are said sometimes to come out of the mouth and nose while the person is sleeping.

The fresh eggs of the *ascaris lumbricoides* have a very peculiar appearance, since its chitin capsule is covered with an uneven, as it were, humped albuminous envelope. (See Fig. 105.)

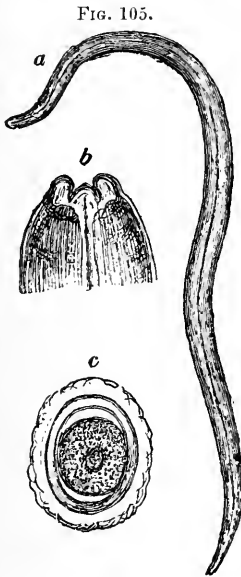

FIG. 105.

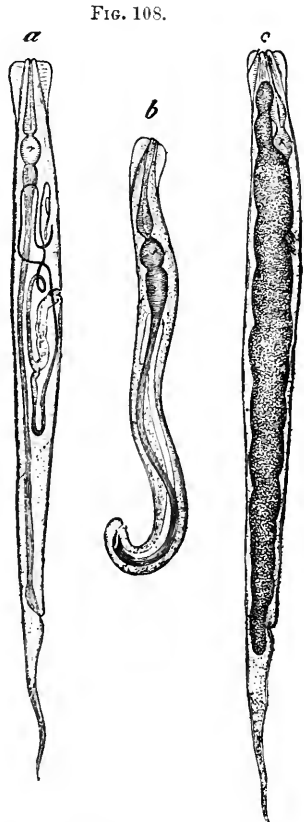

FIG. 108.



FIG. 106.

FIG. 107.

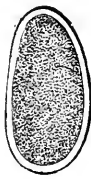

Fig. 105.—*Ascaris lumbricoides* (JAKSCH). *a*, worm natural size; *b*, head; *c*, egg.

Fig. 106.—*Oxyuris vermicularis*. Natural size. 1, female; 2, males.

Fig. 107.—Egg of *oxyuris vermicularis* (enlarged).

Fig. 108.—*Oxyuris vermicularis*, enlarged. *a*, ripe, but unimpregnated female; *b*, male; *c*, female containing eggs.

Oxyuris vermicularis is a small, white worm (Fig. 106) found particularly in the large intestine. It may wander from the anus into the vagina. It has very slight pathological significance. It appears in the stools, and also it is not infrequently found by itself in the neighborhood of the anus. When first passed, it has usually very lively peculiar movements. The eggs are commonly unsymmetrical. (See Fig. 107.)

Anchylostoma duodenale, very like the last in form, but often longer, even twice as long; usually inhabits the upper part of the small intestine, especially the duodenum.

Formerly it was only observed in other countries [discovered by Dubini in 1838, in northern Italy], more recently also in Switzerland (first during the building of the St. Gothard tunnel), and finally it was noticed among brickmakers. Because it continually sucks blood from the wall of the intestine, it causes severe, sometimes fatal, anæmia (anchylostomiasis, formerly "Egyptian-chlorosis," Griesinger). It is difficult to discover the worms in the stools unless some vermifuge is used, but, on the other hand, the tolerably characteristic eggs are always present. They are as large as, or perhaps a little larger than, those of

FIG. 109.

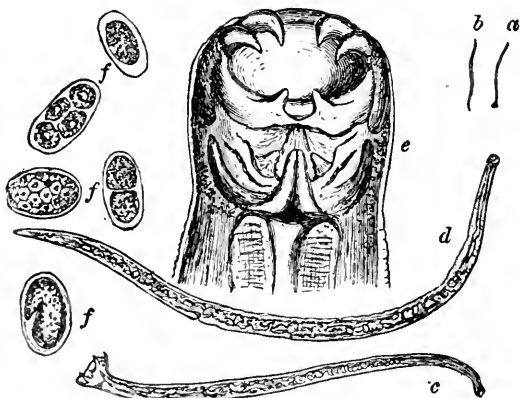

Anchylostoma duodenale (JAKSCH). *a*, male; *b*, female, natural size; *c*, male; *d*, female, slightly magnified; *e*, head; *f*, egg.

the oxyuris. They have a thick covering, and contain two or more segmentation globules. By allowing the stool to stand for several

days in a warm place, we can see the embryos develop in the eggs. In this very serious disease the stools often contain blood.

Besides the intestinal parasites already mentioned, there are the following, part of which are pathologically unimportant, and others are very rare:

Trichocephalus dispar. Its habitat is the colon, especially the cæcum. It is of no importance. Both the worms and eggs are highly characteristic in form. (See Figs. 110 and 111.)

FIG. 110.

Fig. 110.—*Trichocephalus dispar*, natural size. (HELLER.)

FIG. 111.

Fig. 111.—Egg of *trichocephalus dispar*, moderately enlarged.

Trichina spiralis. It very rarely occurs in the intestine, but sometimes in the first stage of the trichinosis, the stomach-stage, with intestinal phenomena, it is found in the stools. Since the early recognition of trichinosis is of the greatest importance, in a suspicious case the stool is to be examined with the greatest care, best after the administration of an aperient.

The appearance of the intestinal trichina is shown in Fig. 112. It is only one-third as long as the oxyuris, and hence cannot be seen with the naked eye.

Distoma hepaticum and *D. lanceolatum*, two rare, but pathologically important, parasites, which inhabit the gall-passages of the liver, sometimes make themselves known by their eggs, which, passing out into the intestine with the bile, appear in the stools. The egg of the *D. hepaticum* is much larger than the other parasites previously mentioned, about three times as large as those of *ascaris lumb.* The egg of the *D. lanceolatum* is somewhat smaller than that of the oxyuris. For its other characteristics see Fig. 114.

Infusoria of very great variety of species are found in the stools of all kinds of diarrhœa: in acute and chronic intestinal catarrh, in

typhoid fever, in tuberculosis of the intestine. Immediately after the evacuation of the bowels they manifest very active movement. Their pathological and diagnostic significance are both negative.

FIG. 112.

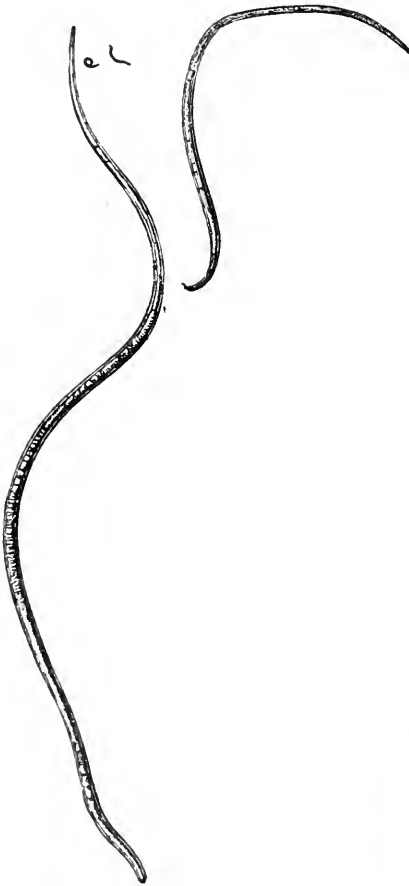

FIG. 113.

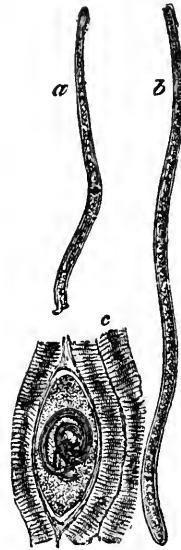

FIG. 114.

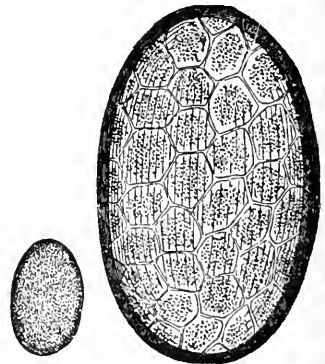

Fig. 112.—Adult intestinal trichina, human. Male, female, and two embryos slightly magnified. (BIRCH-HIRSCHFELD.)

Fig. 113.—Trichina (JAKSCH.) *a*, male; *b*, female intestinal trichina; *c*, musculo trichina.

Fig. 114.—Egg of *distoma hepaticum* and *distoma lanceolatum*. (HELLER.)

Microscopic examination of the feces. Thin, or thin-mushy stools, are examined without making any addition to them. To thick, mushy, or solid stools, about a half per cent. of solution of salt is added; and the solid portions must, of course, be broken up. Somewhat of a selec-

FIG. 115.

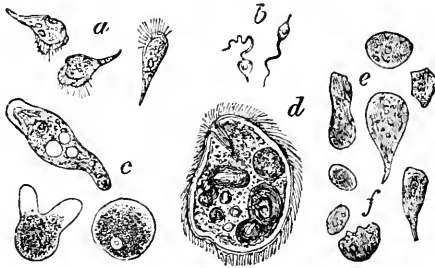

Monads from the feces (JAKSCH). *a*, tricomonas intestinalis; *b*, cercomonas intes.; *c*, Amœba coli; *d*, paramœcium coli; *e*, living monads; *f*, dead monads.

tion must be made from the different portions of the stool, according to the object of the examination. In what follows are presented the details. The amplification also varies with the object of the exami-

FIG. 116.

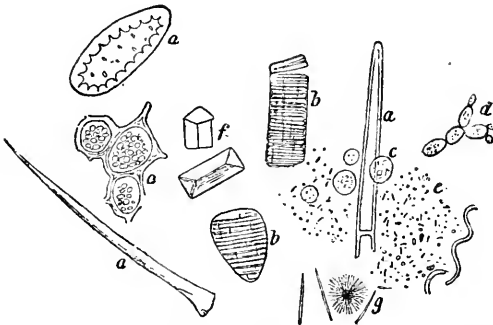

Microscopical constituents of the stools (partly from JAKSCH). *a*, vegetable fragments; *b*, muscular fibres; *c*, white blood-corpuscles; *d*, saccharomyces; *e*, microorganisms; *f*, crystals of triple phosphate; *g*, fatty acid crystals.

nation. In general, we employ the dry method. When looking for parasites (which have already been described), it is better, on the other hand, to make use of a tolerably strong amplification.

1. *Undigested portions of food.* These may be found in every stool, and in varying quantities, according to the kind of food eaten. We mostly meet with coverings of vegetable cells, elastic fibres, etc.

2. *Portions of digested food.* Although these, if visible with the naked eye, indicate disturbed digestion in the small intestine, yet microscopical particles of these substances are seen in small quantities in normal stool, as well as small portions of muscular fibre, with the transverse striations, shreds of connective tissue, starch granules, and fat.

But considerable quantities of the substances named always indicate disturbed digestion either in the small intestine or the stomach, and hence have the same significance as the occurrence of larger pieces, which can be seen without being magnified. When the microscopical particles are colored a bright-yellow, as we commonly see small portions, particularly of muscular tissue, but sometimes almost all the solid portions of the stools, it shows that there is unchanged bile in the stool, and catarrh of the small intestine.

Fat, in the shape of polygonal glassy lumps, of needle-shaped crystals, and also in the form of drops, is a very frequent constituent of the stools. The glassy lumps occur very frequently in health, and are often colored yellow or yellowish-red. They are recognized as fat, fatty acids, or soap, by their transformation upon the addition of sulphuric acid, and, when warmed, into drops of fat (Müller). Drops of fat occur in the stools with milk-diet (hence, particularly in those of children), when taking cod-liver oil, likewise castor-oil, and, if there is intestinal catarrh, then in very considerable amount.

The needles of fat have pathological significance. They sometimes occur singly, and, again, in bundles and druses. They are changed by simply warming them, or by the addition of acid and then warming, into drops of fat, and this takes place whether they consist of fatty acids or (lime-) soap.

When there are great numbers of fat-needles, it is a pathological sign of disturbance of the resorption of fat, as may result from shutting off of the bile from the intestine, from any form of enteritis, of tuberculosis, amyloid degeneration of the intestine, and, lastly, from disease of the mesenteric glands.

The increase of the fat in the stool is not, as was formerly assumed, characteristic of a want of pancreatic juice (disease of the pancreas,

closure of the ductus Wirsungianus). As a matter of fact, the absence of pancreatic juice does not seem to hinder the resorption of fat (Müller).

Detritus. With respect to detritus in the stools little needs to be said, because we cannot determine separately a great number of the kernels, husks, etc.

3. *Additions to the stools* from the alimentary canal. A microscopical quantity of *mucus* occurs in the stools of persons in health. Small glassy lumps of mucus may also be present, which come from the cells of plants. Usually the examination with the naked eye is sufficient to determine whether there is a pathological admixture of mucus.

It is necessary only to mention that a firm stool, abundantly interspersed with small light lumps of mucus, is observed with intestinal catarrh (Nothnagel). In these cases, we can generally discover the mucus, if we carefully examine, without any artificial aid.

Epithelium. Some cylindrical cells, often in mucous metamorphosis, are a frequent occurrence. If the quantity is large, it indicates intestinal catarrh. Very abundant cylindrical epithelium occurs in chronic catarrh of the large intestine, especially in mucous colic, in this case caused by mucous "infarction." It has already been mentioned that regular shreds of mucous membrane are found in the stools, also portions of tissue.

Red and white *blood-corpuscles*. These are present in quantities in fresh bloody, and in purulent, stools. When seen but once, they do not have significance.

4. *Crystals.* Except the fat crystals mentioned above, there are almost no crystals which are brought into requisition for the purposes of diagnosis. Crystals of ammoniaco-magnesian phosphates (see these under the examination of the urine), no doubt, occur in the stools in enteritis and abdominal typhus. But they may also be found in any other stools, if they are not kept separate from the urine and stand for a long time.

Lime-salts of all kinds, partly with inorganic, partly with organic, acids, in the form of wedges, dumb-bells, needles, etc., sometimes colored an intense yellow by the bile in the stool, have no diagnostic import.

Charcot's crystals, in appearance and probably also chemically

entirely agreeing with the Charcot-Leyden crystals of asthma, are observed in rare cases of dysentery, typhus abdominalis, intestinal tuberculosis, anchylostomiasis.

5. *Vegetable parasites.* We may divide the large number of vegetable microorganisms which we find in the stools, from the standpoint of clinical diagnosis, into two classes:

(a) Those which, primarily, for clinical diagnosis are only of subordinate significance, because we do not know that they have any definite connection with any diseases. Here, also, we class those which are indirectly harmful—that is, they cause abnormal decomposition of the intestinal contents. This class is extremely numerous, and great numbers of one kind or another are present in every stool. The knowledge of the different kinds has recently been greatly extended by the important labors of Nothnagel, Bienstock, Escherich, and others. But the point has not yet been reached which makes them as available, for clinical diagnosis, as the other peculiarities of the stools. For this reason we will treat of them only very briefly here.

Of the fungus-spores we have (very rarely) that of thrush in children who are suffering from thrush in the mouth. Yeast fungus, and, indeed, the different kinds of *tortula cervisiæ* (see Fig. 116, *d*), occasionally occur in all stools, especially in the milk-stools of children. In intestinal *dyspepsia* with acid fermentation they are generally more abundant than in normal digestion. But the schizomycetes belong to the numberless microorganisms which are seen in every microscopical preparation of the stools, whether normal or pathological. Of chief importance are the micrococci and bacilli. A very large part of these are colored yellow or brownish with iodine and iodide of potassium; others are colored by the same reagent blue or violet (Nothnagel). These latter, according to Jaksch, are increased in intestinal catarrh.

We are already able to conclude that the knowledge of these intestinal bacteria furnish diagnostic indications of anomalies in intestinal digestion, and that the different kinds of bacilli possess extraordinary biological peculiarities. Some require for their rapid development a neutral or slightly alkaline reaction, while others an acid reaction, of the intestinal contents; some are aërobiotic, others

anaërobic; and while some have the power to transform starch into sugar, others cause the decomposition of albumin.

(b) *Pathogenic fungi*. These we are able to isolate, and from them diagnosticate the disease they cause, as the tubercle-bacillus in the sputum.

Here, also, belong the *pathogenic schizomycetes*. These are: Koch's cholera bacillus, the bacilli of typhus and tubercle.

Cholera bacilli (comma bacilli) are the pathognomonic sign of Asiatic cholera. They are short, more or less crooked rods, which are sometimes connected one to another in such a way as to form "spirals," like a screw. The curve may be very slight, even wanting; or marked, even semicircular. In general, they are shorter, but thicker, than the bacilli of tubercle.

FIG. 117.

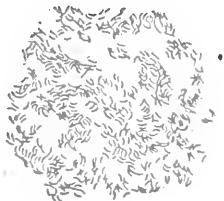

Comma bacillus, pure culture (prepared by Prof. Gärtner). Zeiss's immersion lens one-twelfth, eye-piece No. 2, camera lucida. Magnified about 600 times.

FIG. 118.

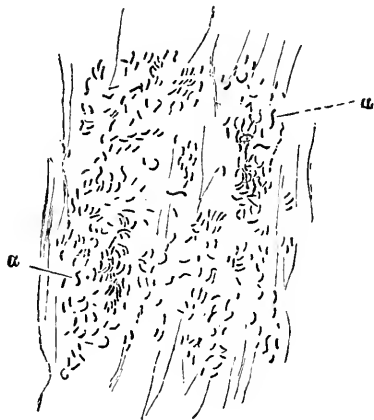

Cholera dejections upon a damp sheet. (Two days old.) a, S-form bacilli, 600 : 1. (Кочн.)

Habitat: mode of preparation. They are particularly found in the free mucous floccules of rice-water stools, also very abundantly upon the linen soiled by the dejections, and, indeed, here after two or three days, provided the linen has been kept moist. A mucous floccule (or a drop of the stools), or some of the deposit on the linen, is placed upon a covering-glass. First dry it in the air, then pass it

two or three times through the flame of a spirit-lamp, and stain it with methylene-blue or fuchsin by warming it one to five minutes.

These bacilli have been found, we may say, constantly in the stools of Asiatic cholera by a great many other examiners besides Koch, and they are found in no other stools. They must, therefore, diagnostically be of pathognomonic value to even those who doubt Koch's teachings concerning their pathogenic character.

FIG. 119.

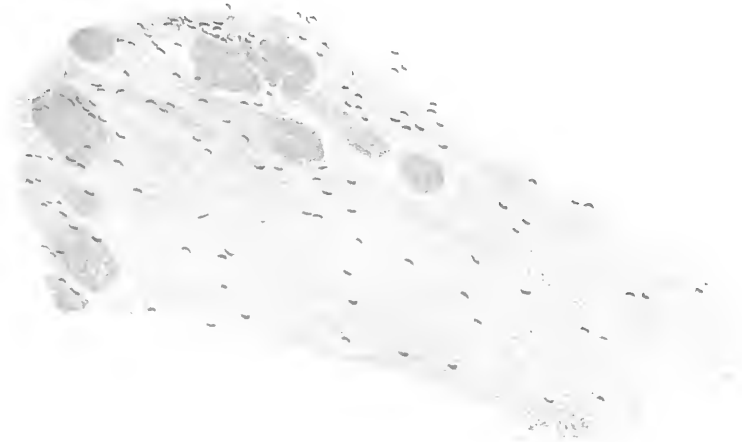

Covering-glass preparation of a mucous floccule in Asiatic cholera. Zeiss's homogeneous immersion one-twelfth, eye-piece No. 2, drawn by a camera lucida. Magnified about 650 diameters.

But since the morphological peculiarities of the cholera bacillus in the microscopical preparation do not furnish an absolutely certain recognition, and, on the other hand, since there is no specific reaction (as with the tubercle-bacillus), in order to determine an isolated case, it is indispensably necessary to establish a pure culture. (See, regarding this, the works upon bacteriology.)

Comma bacilli are also, in individual cases, found in the vomit of Asiatic cholera.

Morphologically, but not biologically, they are like Finkler and Prior's spirals of *cholera nostras*, which possibly stand in the same relation to this latter disease that the comma bacillus does to Asiatic cholera. They are positively distinguished from the bacilli of Asiatic cholera by pure culture.

A bacillus which is morphologically like the comma bacillus occurs in tooth-mucus (Lewis and Miller), and just such an one, also, in old cheese (cheese-spirals, Deneke). Biologically, they differ from Koch's comma bacillus and from each other.

Typhus abdominalis bacillus. These bacilli are regularly found in typhus abdominalis, in the diseased portion of intestine, in the mesenteric glands, the spleen and liver, in the kidneys, and also frequently in the blood (which see). They have also frequently been found in

FIG. 120.



Spirillum (Finkler and Prior), 700 : 1.
(FLÜGGE.)

FIG. 121.



Typhus abdominalis bacillus in pure culture. Zeiss's homogeneous immersion lens one-twelfth, eye-piece No. 2, drawn with camera lucida. Magnified about 650 times.

the stools of typhus. But since they are neither distinguished by their form (just at the end they are rounded; are about as long as the tubercle bacillus, but are much thicker—about one-third as thick as long) nor by a specific color-reaction from the other bacilli which occurs in the stools, their microscopical proof is extremely uncertain. Pure cultures are here much more necessary for the positive determination, and even then are uncertain.

The typhus abdominalis bacillus is best stained with methylene-blue or fuchsine in a dry preparation upon the glass cover.

Tubercle bacillus. These are frequently found in tuberculous ulcers of the intestine. It is not yet sufficiently established whether they are always present, chiefly because not infrequently tubercular ulcers of the intestines do not have any symptoms, and particularly do not cause diarrhœa; and so, often enough, the firm stools are not examined for bacilli. On the other hand, in phthisical patients, the tubercle bacillus is sometimes observed in the stools without there being any intestinal tuberculosis. They come from swallowing tuberculous sputum.¹

¹ *Amœba coli* is a protozoa which has been found by Koch, Osler, Dock, and others in the stools of patients suffering from severe chronic enteritis and dysentery.—
TRANSLATOR.

CHAPTER VII.

EXAMINATION OF THE URINARY APPARATUS.

THIS comprises the examination of the urinary organs themselves and the examination of the urine. Indeed, in very many cases, the latter examination only is made, or it forms the chief part, whether in its relation as being the secretion of the kidneys, or whether it be in reference to admixtures or alterations of the urine, which occur in the course of its transit through the urinary passages. The local examination of the urinary organs is now not often required, but if it is, the result of the examination generally confirms the diagnosis. This direct examination, therefore, ought never to be neglected. Moreover, where the kidneys themselves are diseased there come into consideration certain resulting phenomena in the different organs of the body.

EXAMINATION OF THE KIDNEYS.

Anatomy.

The kidneys, about 10 to 12 cm. long, about 5 cm. broad, of well-known form, lie upon the two sides of the spinal column, upon the anterior surface of the quadratus lumborum muscle and the lumbar portion of the diaphragm, and reach from the level of the twelfth dorsal vertebra to the level of the second or third lumbar vertebra. The lower portions diverge somewhat downward, and hence lie with their lower ends somewhat further from the median line of the body (about three fingers' breadth) than the upper ends (about two fingers' breadth). The right kidney is a little lower down than the left.

The upper half of both kidneys is covered by the eleventh and twelfth ribs, the extreme upper portion also by the complementary pleural sinus (see Fig. 122); hence, the lower border of the lungs does not extend as low down as the kidneys. It is very important to note that the outer border of both kidneys corresponds tolerably exactly

with the outer border of the thick fleshy layer of the sacro-spinalis muscle.

The left kidney at its upper end, rather by its suprarenal capsule, is in contact with the spleen; the right kidney, with the under surface of the liver. Both organs encroach upon the upper end of the kidney of their respective sides, like the tiles of a roof (see Fig. 122). The figure also furnishes information regarding the so-called spleen-kidney and liver-kidney angle.

FIG. 122.

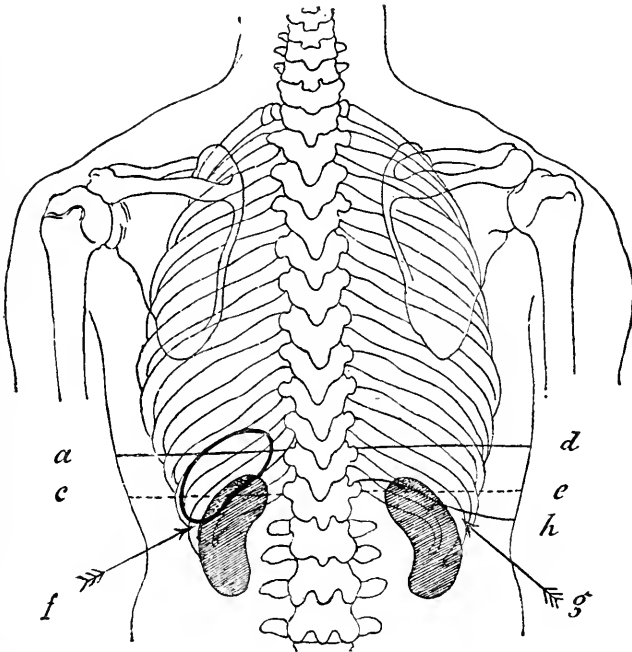

Anatomical situation of the kidneys. (WEIL.) *a, d*, borders of the lungs; *c, e*, limits of the pleural sacs; *f*, angle between the spleen and kidney; *g*, angle between the liver and kidney.

The superior surface of each kidney is covered by the parietal peritoneum, and in front of it lies the ascending or descending colon. The anterior inner border of the right kidney is not far from the ductus choledochus and the duodenum.

In the rare condition known as horseshoe-kidney, the lower ends of

the two kidneys are connected by a transverse band consisting of kidney-parenchyma. This transverse portion passes, like a bridge, across the aorta and the spine, about on a level with the second lumbar vertebra.

Local Examination of the Kidneys.

In every respect its result is almost negative. The normal kidney, of course, cannot be inspected. In remarkably exceptional cases we may, by employing bimanual palpation, with the legs drawn well up (one hand being placed behind in the lumbar region and the other pressing deeply in front), get some information, provided the abdominal covering is very unusually lax and thin, and the stomach is empty. Of late, percussion of the kidneys has very rightly come more and more into discredit. It must be perfectly evident to every one that it is impossible to point out the normal kidneys, or even moderately enlarged ones, if he remembers that the kidney is less voluminous than the spleen; that, moreover, it lies much less favorably; and, besides, if he takes into consideration how often the normal spleen is with difficulty, or cannot at all, be made out. The kidney is unfavorably located for percussion, because the sacro-spinalis muscle (of considerable mass) lies over it, but especially for the reason that its lateral border almost exactly corresponds with the convex border of the kidney. So we cannot with certainty determine whether the kidney lies under the muscle, nor where its limits are.

Individual exceptional cases, where very thin or atrophic sacro-spinalis muscles permit of percussion of the kidneys, may nevertheless occur, as the cases mentioned above, where the normal kidneys can be felt. But we cannot consider the result of percussion of the kidneys as of great value.

Pathological Conditions of the Kidneys.

Inspection. The kidney can only be inspected when it is very much enlarged, or enlarged and displaced. Tumors of the kidney may make their appearance in the lumbar region, in the side, and in the lateral anterior portion of the abdomen, near the border of the ribs. According to their nature, they are smooth, roundish, irregular,

or uneven (see Palpation). They do not move with respiration. Their appearance may strikingly vary, but not necessarily so, with the changes of position of the body (the dorsal position, lying down). If the tumor is very large, then it generally presses the colon, ascending or descending, toward the anterior abdominal wall, and then the colon, according to the amount of its distention, may lie up against the abdominal wall (see Palpation).

If the kidney is the seat of a tumor, it very often departs from its place high up against the diaphragm, and becomes the so-called wandering kidney. In this case it is much easier seen from in front. A normal kidney wandering so much as to be visible, is a curiosity (Bartels).

A roundish, symmetrical swelling, located in the dorsum in the region of the kidney, or somewhat sidewise from it, points to purulent perinephritis. Sometimes it extends upward in the abdominal cavity, from the diaphragm being pushed up. Often there is œdema of the skin at the spot (deep formation of pus, see p. 52), or there may be inflammatory redness. Moreover, abscess, due to the congestion accompanying caries of the spine, may break here. Also, large perinephritic abscesses have been seen as tumors above the border of Poupart's ligament in the iliac region.

Palpation. This is most important in the local examination of the kidneys. We employ it in the dorsal position with the knees well drawn up, but sometimes also in the abdominal position. In both cases, we always first examine bimanually, one hand being upon the region of the kidney and the other upon the abdomen.

Tenderness upon pressure occurs: sometimes in acute, almost never in chronic, *nephritis*; also in *tumor of the kidney, stone* in the pelvis of the kidney, in case it excites inflammation; in inflammatory *hydronephrosis*, and in *perinephritis* (here there is often very great sensibility).

When the kidney is enlarged from engorgement, amyloid disease, or nephritis (large white kidney), it is never perceptible to palpation except it leave its place (wandering kidney), or we have one of the exceptional cases in which even a kidney of normal size and location can be felt (see above, Local Examination of the Kidney). Very large new formations, as carcinoma, sarcoma, hydro- and pyo-nephrosis, echinococcus, and perinephritis, only are palpable. The tumor

can be felt in one side of the lumbar region, or at one side of the anterior abdominal region. With new formations it is usually uneven; in hydronephrosis, smoothly round, more or less tense, under some circumstances fluctuation can be distinctly made out. Echinococcus is usually smooth and tensely elastic; it may show hydatid vibration (see above, p. 326).

It is important to remember that tumor of the kidney is only very rarely movable upon pressure (for if it descends, then we have a wandering kidney). We have never seen a case where one moved with respiration; but it seems that in some cases there is this movement. At any rate, the absence of respiratory movement points to the kidney, and especially against the spleen or a tumor fixed to the liver.

In a considerable number of cases it will be found that the ascending and descending colon is in front of the kidney-tumor and pressed by it against the abdominal wall. In these cases, this fact has great value for differential diagnosis. In other cases, the tumor will be found lying exactly in the median line, and then it is of significance for differential diagnosis, especially from ovarian tumor. The location of the colon, moreover, is usually only made out with certainty when it can be felt, and particularly when it contains air. It is, therefore, advisable to inflate it (see p. 311).

Wandering kidney; movable kidney. By this we understand downward dislocation of the kidney, whether much or little. Almost always only one is dislocated, and this is usually the right one. In these cases the kidney is commonly of normal size, but it may be enlarged, and this is most frequently due to hydronephrosis caused by the bending of the ureter, or also because it is the seat of a new formation.

It is generally very easy to recognize a kidney that is very much out of place, but when it is still high up, near the liver or the spleen, it is often very difficult to do so. The diagnosis is based upon the bean-shaped form of the kidney, eventually, upon its being of the appropriate size, and upon its mobility by pressure, which is almost never wanting; also, sometimes, with the changes of position of the body. Not infrequently the kidney can be perfectly replaced. In some cases dyspeptic symptoms, even dilatation of the stomach, also jaundice from engorgement, have been observed when the right

kidney was displaced (from compression of the duodenum or of the ductus choledochus). Those cases are rarities where the pulse can be felt in the renal artery.

Percussion. We employ percussion to establish the existence of tumors of the kidney which give a deadened sound, on account of their solidity; but they are almost always clearly made out by palpation. Its value in determining dislocation of the kidney was formerly very much over-rated. It was thought that we were able to prove one-sided dislocation of the kidney, because, when the patient was lying upon the abdomen, the resonance of the two sides in the neighborhood of the kidneys was found to be different: clearer upon the side of the wandering kidney, in contrast with the absolute dulness of the normal side. In our opinion, even in the most favorable cases, such a condition cannot be employed for deciding the diagnosis.

But, on the other hand, percussion may be of the greatest value, either to determine the relation of a tumor in one side of the abdomen to the colon, or to determine the course of the colon over a tumor of the kidney (see above). In such a case, distending the colon with air is of the greatest assistance. Further, it might possibly occur that a considerable enlargement of the kidney could be made probable (never certain) by an area of dulness upon the back, extending from the region of the kidneys toward the side.

Differential diagnosis of tumor of the kidney. The positive evidence of tumor of the kidney has just been spoken of. We may have to make a differential diagnosis between a right kidney which is not very much displaced downward and a distended gall-bladder, or an echinococcus located upon the lower surface of the liver. If there is respiratory mobility, this speaks against it being the kidney, but if the tumor can be replaced, so that it may even disappear, then it speaks for it being the kidney. Both wandering kidney and a pedunculated echinococcus may be easily movable upon pressure. It may often be impossible to determine exactly the form of a tumor situated close under the liver.

A wandering left kidney is distinguished from a wandering spleen by the form, which is made out by percussing the neighborhood of the region of the spleen: in wandering spleen, we may find notches; if it is the kidney, we may feel the pulse at the hilus. We distinguish tumor of the left kidney from tumor of the spleen by the

form and relation to the colon. Sometimes respiratory mobility decides in favor of the spleen; but with this it may also be wanting; while notches on the upper border of the tumor may speak with probability for the spleen, yet in one case, where they could be very distinctly felt, they led us to a false diagnosis; it was found to be a carcinoma of the kidney.

We know of one case where a movable tumor of the left side of the abdomen was, by a recognized master of percussion, pronounced a wandering kidney on account of the tympanitic resonance in the region of the left kidney. It was operated upon; it proved to be a wandering spleen. It was extirpated with permanently favorable result.

EXAMINATION OF THE URETERS AND BLADDER.

Simon, by introducing the hand into the rectum, has repeatedly felt of the ureters (see works upon Surgery). Recently Heger-Kaltenbach and Sanger have proposed, in the case of women, to palpate them *per vaginam*. We can feel their lower ends where they come down on either side of the neck of the uterus and enter the lower side of the bladder. With some practice often even a normal ureter, but still more one that is thickened, can be felt in the lateral and anterior *fornix vaginæ* and the anterior vaginal wall close to the middle line.

In this way it is not difficult to recognize thickening or tenderness of one or both ureters. Both occur in cystopyelitis and in tuberculosis of the urinary apparatus; thickening and distention may sometimes be observed also in *pyelitis calculosa* (renal calculus).

The bladder lies behind the symphysis pubis, when ordinarily distended, it rises above it, but only when it is excessively full, as in paralysis of the bladder, spasm of the sphincter, stone in the bladder, stricture of the urethra, does it swell so much as to be noticed (rarely) by inspection; but especially by palpation and percussion, as a roundish tumor, which, of course, is dull in sound. In men it can also be felt from the rectum. We are able to decide with certainty whether a tumor in the hypogastrium is a distended bladder or not by drawing off the urine with a catheter. It may be confounded with a pregnant uterus, and also with other swellings. Always before undertaking an examination of the abdomen, we must see that the bladder is empty, partly to avoid confounding the distended bladder

with something else, and partly because, if the bladder is full, it interferes with the examination of the abdomen.

Anomalies located in the wall of the bladder can usually be felt best when the bladder is full. The external examination is made *per vaginam*, *per rectum*, and sometimes bimanually.

Surgery and gynecology teach the complicated methods of examining the bladder and ureters. With reference to the examination of the male urethra, we refer to works upon Surgery.

EXAMINATION OF THE URINE.

Under normal conditions and when free from admixture, the urine, as it issues from the orifice of the urethra, exhibits the renal secretion in a state of purity, since, in its transit through the urinary passages, it receives scarcely any additions from the mucous membrane that are worth mentioning; and further, since, at the time of its discharge from the body, and for some time after, its physical and chemical conditions are the same as at the moment of secretion. In a number of pathological conditions, also, the urine is the pure and unaltered secretion of the kidneys; while, in a second series of diseases, it is changed by its exit from the body, and, indeed, by admixtures from the urinary passages, or by decomposition of its constituents in the bladder. To the first series belong the anomalies of the secretion itself; to the second, the diseases of the urinary passages.

In women the urine may be contaminated by admixture of material from the vagina or uterus, and of these the most frequent and important is the menstrual fluid. In order to avoid this contamination, we are sometimes obliged to draw off the urine with the catheter. It is usually contaminated by fecal material only from carelessness of the patient or of the attendant. But sometimes it results from communication of the intestine with the urinary passages, as of the rectum with the bladder or with the vagina.

Recent investigations by Lustgarten and Mannaberg show that the former assumption that the urine is normally free from bacteria must be given up. The urine of healthy persons contains a number of microorganisms which have their origin in the urethra. The most important are a large streptococcus, a diplococcus which resembles the gonococcus, also like that in epithelium, but, of course, it is not found

in pus-corpuscles, and lastly, a bacillus which morphologically and in its color-reactions agrees with the tubercle bacillus, and which probably is the smegma bacillus, which also occurs in the preputial sac. This latter may give occasion for the erroneous supposition that there is tuberculosis. But that it has its origin in the urethra is shown by the fact that it is observed even when the preputial sac has been most carefully cleaned previous to urination, though it is only found in individual cases, while in cases of tuberculosis it is always abundantly found in the urine. Sometimes inoculation must decide (see Appendix). We may avoid the urethral bacillus by drawing the urine with a catheter, but then also, sometimes, possible tubercle bacilli from the prostate or genital apparatus may be found in the urine.

In case of disease of one kidney or pelvis of the kidney, the question may arise as to what part of the urine passed is from the right, and what from the left, kidney. If one kidney fails, the other acts vicariously. In tuberculosis of the urinary passage and in pyelitis, it may happen that for a time one ureter is stopped; the urine comes only from the other kidney, and it may be quite normal. Then, suddenly, the character of the urine will change, showing considerable white blood-corpuscles, seed-like particles, tubercle bacilli, or calculi, and blood. The quantity of urine is, for the time being, increased; for the closed side has again opened.

In certain diseases of the urinary apparatus, the manner of passing the urine shows characteristic peculiarities; but in many of the conditions under consideration, the urine is passed in a perfectly normal way. Painful strangury, frequent urination, a feeling of burning in the urethra while passing the urine, may result from the urine being much concentrated, such as is passed when there is engorgement of the kidneys, and in the majority of cases of acute nephritis. Very pronounced *tenesmus* of the bladder—that is, painful urgency, extremely frequent, very painful urination, in which only a small quantity of urine is passed at a time—indicates cystitis. We must mention here, further, retention and incontinence of urine, nocturnal enuresis (regarding these, see under Examination of the Nervous System).

In regard to the mode of procedure in examining the urine, let it be here remarked, in the first place, that we should take care that the urine is received in vessels that are perfectly clean—if possible, in

glass vessels; and, also, that for judging of certain general characteristics, it is necessary to examine the mixed urine passed during twenty-four hours, or that passed during the day and during the night, separately. For certain examinations it is necessary to separate, in the most careful way, the urine passed each twenty-four hours. In the warm season of the year, the urine ought to be examined as soon as possible after it is passed. In order to examine the sediment, the upper portion of the urine is to be carefully poured off, and the remaining cloudy portion is put into a conical glass, in which it is allowed to stand till the sediment is deposited; then we take up a few drops from the bottom of the glass with a pipette.

When there is unconsciousness or difficulty in passing the urine, we must employ the catheter. The artificial emptying of the bladder, for the purposes of examination, must never be omitted in any case of unconsciousness. We briefly describe the characteristics of the normal urine.

(A) NORMAL URINE.

1. *Amount.* In twenty-four hours, with healthy persons, it amounts on the average to about 1500 grms. But its variations within physiological limits are very considerable, since every increase in the amount of water taken increases the amount of the urine, and every increase in the amount of water disposed of in other ways diminishes the urine. In the latter respect, in health we have to consider the loss of water by respiration and by perspiration, from heat and from active bodily exertion. It is superfluous in the cases just referred to to specify the maximal and minimal figures for the amount of the urine; only when those conditions are wanting, must a departure from the average quantity of urine given above cause us to think of a pathological condition.

Within the twenty-four hours, the least urine is passed at night, or in the early morning, very much the greater portion being passed during the course of the day. Usually, the amount of urine passed increases about an hour after taking fluid. Emotional excitement, especially anxiety, sometimes temporarily increases the secretion of urine.

2. *Color; transparency.* In health, the color is usually dark straw-color to reddish-yellow. Generally, the greater the amount of urine

the clearer it is. In this respect as well as in the quantity, with physiologically exceptional cases, it shows marked variations from the average; from being almost as clear as water, after a great amount of fluid has been drunk, to a decidedly dark reddish-yellow (concentrated urine), after severe sweating. The coloring-materials which give the normal color to the urine are not yet all exactly known. The most important pigment seems to be urobilin; moreover, indican interests the clinician. Both coloring-materials may, in disease, be pathologically increased. (See *Pathological Colors of the Urine*.)

Urine freshly passed is, in health, always perfectly clear and transparent; but in these respects it may change some time after it has been passed.

(a) In almost all normal urine, after standing a short time, there is formed a slight cloud of mucus. This is from the urinary passages, chiefly from the bladder.

(b) It not infrequently happens, with healthy persons, that the urine, if somewhat concentrated, is cloudy when it becomes cool from the separation of the uric-acid salts. Gradually, the salts sink down and form a sediment of clear brick-dust red or flesh-color (associated coloring-matter of the urine, brick-dust sediment, lateritious sediment). It has the peculiarity—by which it is likewise recognized—that it is again immediately dissolved as soon as the urine is warmed. After a long march in the heat, this sediment occurs very regularly, because the urine is then concentrated; but it also is observed in urine that is not so very dark, if it is allowed to stand in a cool place. (See further regarding the *Urinary Sediments*, p. 428.)

(c) Urine that stands exposed for a long time, both clear and dark, likewise sometimes becomes cloudy, because it undergoes ammoniacal fermentation. The urea is changed into carbonate of ammonia, which makes the urine alkaline, whence there is a deposit of phosphates (ammonio-magnesian phosphates or triple-phosphates, also phosphate of lime). Urate of ammonia also is formed and deposited. These separations and numerous bacteria render the urine cloudy and gradually form a whitish sediment. In hot weather this ammoniacal fermentation takes place within a few hours after the urine is passed; in a cool place, it does not begin before 36 to 48 hours, or not at all. For a more particular account of the condition when there is ammoniacal fermentation of the urine, see p. 413.

3. *Specific gravity.* In health it usually varies between 1015 and 1020. It depends upon the amount of solids held in solution by the urine, hence, on the one hand, upon the absolute quantity of the solids, and, on the other, of the amount of the watery portion of the urine, or the quantity of the urine. The abundant urine which follows drinking a great amount of water is always of low specific gravity, and, therefore, clear. A scanty urine, from the loss of water in other ways, is always of high specific gravity, and hence is dark. Then, also, in health the specific gravity, under some circumstances, temporarily oversteps very considerably the figures given above, from as low as 1003 to as high as 1025, or even higher. In the absence of "physiological causes," these figures are always of pathological significance.

Mode of procedure: We measure the specific gravity of the urine by means of an areometer graduated for taking the specific gravity of the urine (that is, from 1000 to about 1040, "urometer"). We take a portion of the urine which we wish to weigh (generally a mixture of that which has been passed during the previous twenty-four hours) and pour it into a not too narrow cylindrical glass until the column of urine is longer than the urometer. With filter-paper or a pipette, we remove any air-bubbles from the surface, and then introduce into it a perfectly clean and dry urometer; wait until it has become quiet, and then observe the figure that stands opposite the lower border of the meniscus of the fluid.

None of the simple medical instruments is so often useless as the urometer. We should never use one until its accuracy has been tested. It is always desirable to have a urometer upon which is given the temperature for which its scale is arranged; not that we must always have the urine at this temperature, but because the absence of this declaration from the instrument shows very certainly that it has been prepared without care.

4. *Reaction:* In general, this is always acid, chiefly from the presence of acid urates and phosphates. The degree of acidity varies individually; moreover, it is a constant quantity in every individual case of health, and when the food is approximately alike.

But in the twenty-four hours the reaction varies considerably, so as to be even alkaline, and yet physiological. The variations proceed in such a way that, after every meal consisting of a mixed diet, the

acidity declines until, after about two hours, it becomes alkaliescent—but this quickly passes so as to give place again to an acid reaction (Görges). These variations have been referred by many to the loss by the body of acids and alkalies in stomach and intestinal digestion. Hence it is assumed that the separation of HCl in the stomach increases the alkaliescence of the blood, and hence the urine becomes less acid, or alkaline. But, according to recent investigations by Noorden, this increased alkalinity of the blood does not exist. By a graphic representation of the reaction of the urine during twenty-four hours we obtain the so-called “acid-curve.” This, with some healthy persons, and under like conditions (as to time and quality of food), is tolerably constant, but with other healthy persons it varies considerably.

Sometimes the reaction of the urine is amphoteric—that is, it colors red litmus blue, and at the same time colors blue litmus red.

The neutral or alkaline urine of health at the time of passing is usually clear. But it quickly becomes cloudy from the withdrawal of the phosphates, which gradually form a sediment. The cloudiness does not disappear upon the application of heat, but becomes more marked; on the other hand, the urine again becomes clear upon adding acetic acid, which dissolves the phosphates.

5. *Odor.* The normal aromatic odor of urine is well known; it is changed by certain foods. Most frequent and most striking is the stench of urine after eating asparagus; garlic gives its odor to the urine. During alkaline fermentation we may have the development of ammonia, which gives its known pungent odor.

6. *Sediments.* With reference to the cloudiness, the urate sediment of the acid, and the phosphatic sediment of the alkaline urine, have been mentioned on p. 402. (Regarding the microscopical condition of the sediment, see p. 430.)

Whenever there is a sediment it is not unimportant to remember that different things may have been mixed with the urine after it was passed; see above, p. 390.

7. *The portions in solution.* The constituents of normal urine, which, from our present knowledge, are of importance to the clinician, besides the coloring materials, are the following: urea, uric acid, kreatinin, oxalic acid, chloride of sodium, sulphates, phosphates, carbonates.

Urea $\left\{ \text{CO} \begin{array}{c} \text{NH}_2 \\ \text{NH}_2 \end{array} \right\}$ passed in twenty-four hours amounts in the adult to about 30 grammes (men somewhat more, women somewhat less). However, the amount of urea varies within wide limits: it is dependent upon the amount of albuminous material in the food taken, and, on the other hand, it is almost independent of the amount of muscular exertion.

Uric acid, like urea, is a product of the metabolism of albumin; in man the quantity is much smaller than the former, being in proportion to the urea about as 1 : 45; but it is to be remarked that great variations take place, chiefly under the influence of the food; and this in such a way that albuminous food increases the acidity of the urine. With reference to clinical diagnosis, the uric acid as well as the kreatinin is chiefly of interest, because they may place difficulties in the way in examining the urine for sugar, in that they sometimes simulate the reaction of sugar. Sometimes, on the other hand, they hinder the reaction of sugar (see under Sugar in Urine).

Chloride of sodium, the most important of the inorganic constituents, in health corresponds in amount with tolerable exactness to the amount of salt in the food taken. On the average, it usually is proportioned to the urea as 1 : 2 to 1 : 3.

Exceptionally, in health, there is found in the urine:

Albumin, the so-called physiological albumin. There is still great difference of opinion regarding this subject; while it is doubted by some, others maintain (Senator, recently Posner) that traces of albumin exist in the urine in every healthy person. It occurs in very small quantity (about one per cent.) after severe exertion or hearty eating. The urine of the newly-born not infrequently contains some albumin.

Sugar (grape sugar) is observed in individual cases in very small quantities. After partaking freely of cane sugar, this may appear in the urine.

Bile acids are likewise observed in very small quantities in normal urine.

Fat is recognizable generally only in microscopical drops (or only in ether extract), and is found when the food has contained a great abundance of fat, as of cod-liver oil.

(B) PATHOLOGICAL URINE.

Anomalies in the Quantity.

Increased amount (polyuria) is observed.

1. In a watery condition of the blood, in the different forms of anæmia or hydræmia. The increase here is never very great: 2000 grammes or less; there may be no increase, and if the heart is weak (see below) it may even be diminished.

2. In the different forms of contracted kidney, and this in consequence of the accompanying hypertrophy of the left ventricle, which causes increased pressure in the whole arterial system, and thus also in the renal arteries (here even to 3500 grammes or more). Here the chief cause of the polyuria is the increased arterial pressure from the increased action of the heart (see below).

3. When the exudation or transudation in the serous cavities of the body, or the fluid in the cellular tissues (œdema), is resorbed, the daily excretion of urine sometimes amounts to four thousand grams or more. The increased arterial pressure from quickening of the action of the heart, which occurs at the same time, is also a prominent factor in producing polyuria.

4. In *diabetes*. Both diabetes insipidus and mellitus (mellituria) manifest themselves by the increase, often an enormous amount of urine: 4000 to 10,000 grammes, and more. Sometimes in diabetes mellitus there is only a moderate polyuria, or, for a time, in this disease there is even complete absence of polyuria (diabetes decipiens). (See under Specific Gravity and Sugar in the Urine.)

5. As a necessary consequence of abnormal thirst, polydipsia, as it is sometimes particularly observed in hysteria.

In this connection we must further mention the quite temporary polyuria which sometimes occurs in nervous persons after great mental excitement. Finally, there is the polyuria which occupies a place by itself, resulting from an obstruction somewhere in the urinary passages, where the urine is held back, and then the passage again becomes free (see under Obstruction).

Finally, we must briefly refer to some drinks which temporarily increase the amount of the urine, as coffee, beer, and wine, which increase the quantity of urine more than the amount of water represented. Likewise there are to be mentioned certain articles of diet which have the same effect, partly in that they increase the blood-

pressure by affecting the action of the heart, partly in that they stimulate the secreting action of the kidneys.

In the above pathological conditions, where we do not have a removal from the organism of water that has accumulated there, then the polyuria must be made up, of course, by imbibing an increased amount of drink (polydipsia). Whether we have the increased thirst from increased loss of water, or whether the polyuria is the result of the polydipsia, is not entirely clear, especially in many cases of diabetes insipidus. In diabetes mellitus the polyuria is probably only a purely secondary result of the polydipsia, which, in turn, is to be regarded as the consequence of the glukæmia (Cohnheim).

Diminution in the amount of urine, under some circumstances even to the extent of not passing any (anuria), occurs :

From diminution in the secretion of urine :

1. In the loss of water in other ways : in severe sweating (see, also, Normal Urine) ; in any kind of severe diarrhoea, particularly in Asiatic cholera, where for days together there is continuous anuria. Thus, also, during the formation of a pleuritic or peritoneal exudation, where fever is to be taken into account as a cause (see below).

2. In fever, and largely in consequence of the loss of water in other ways ; by increased perspiration and the greater loss of water by the lungs.

3. By reduced blood-pressure resulting from the diminished work of the heart ; hence, in diseases of the heart-muscle : incompensation in valvular disease, in weakening of the hypertrophic heart of contracted kidney, in emphysema, in all the diseases, frequently mentioned, which harmfully affect the action of the heart. In these conditions the amount of the urine is the chief means of forming a judgment of the course of the disease, and furnishes the indications for treatment.

4. In acute nephritis, subacute and chronic nephritis, except contracted kidney (regarding which see also under 3). In these diseases, also, the amount of the urine is a symptom which indicates the severity of the case. In acute nephritis there not infrequently is, for a time, anuria.

5. From suppression of urinary secretion due to nervous causes, especially in a still indistinct reflex way in trauma, as from operations affecting the abdomen.

Also, there may be a less quantity of urine from difficulty in mic-

turition; from a very narrow stricture of the urethra (surgery); from retention in the bladder; from obstruction in the ureters. In regard to the latter, when one kidney is cut off, the other generally vicariously performs the work of both; but there may also be anuria when one ureter is closed, as from stone in the kidney, and this, in fact, from a kind of reflex suppression in the other kidney (see Shock).

The great zeal in using the catheter in recent times has given us as a result, among other things, the knowledge of the fact that in health with every urination the bladder is completely emptied, even to a few drops. If a certain amount of urine remains in the bladder (residual urine) there is a pathological cause for it. This may be a purely mechanical hindrance to the emptying of the bladder, as stricture, hypertrophy of the prostate, urinary calculi; or it may result from the mechanical hindrance, atony of the bladder; or there may be primary nervous paresis of the detrusor, as occurs in tabes and in all diseases of the lumbar cord. The amount of residual urine is said to be tolerably constant; it is measured by having the patient pass his urine, and then use the catheter immediately afterward.

Color and Transparency of the Urine in Disease.

Primarily, *the color* varies according to the degree of concentration, in the same way as in normal urine; and as in health, so also in general in disease, it stands in a certain relation to the amount of the urine: the greater the amount the clearer the urine. But, like the variations of quantity from the average, the changes in the color of the urine are also much more significant in disease than is the case in normal urine. The scale of colors of the urine passes from the almost colorless to the straw-yellow, reddish, red-brown, even brown-black. It is not necessary to have a very exact determination of the color of the urine by comparing it with those of a table of colors, as was proposed by Vogel, because it could only have a value in determining the degree of concentration, and generally for this the specific gravity is much more exact (see).

Patients with cirrhosis (without icterus, which see) sometimes pass urine that, in proportion to its amount, is very dark. Anæmic (chlorotic) persons, on the other hand, often pass remarkably clear urine.

In fever the urine is relatively dark—reddish or brownish-red (see below, Urobilin).

In *diabetes mellitus* there is a peculiarity in the very striking contradiction between the clear color and great amount of the urine on the one side, and its high specific gravity upon the other, which is of diagnostic importance.

As special pigments of the urine, the following are to be mentioned :

1. *Color due to the increase in the normal pigments.* Two of these come into consideration here :

Indican, occurring in increased amount may sometimes give to the urine a bluish or bluish-black color, if it has been decomposed in the urinary passages and changed into indigo-blue ; but very often we do not recognize that the urine contains more indican, because indigo has not yet been formed. Hence, when there is a suspicion of indican, or if we wish to make use of its possible presence for the purposes of diagnosis, even when the urine appears to be perfectly normal, we must examine it with reference to this substance. When urine containing indican has been standing for some hours, it can generally be recognized by the bluish shimmer of the residuum, from the drops of urine from the upper part of the urine-glass sprinkled and spread out as thin as possible, and sometimes, also, by a bluish film upon the surface of the urine. Besides, all of the urine is sometimes blackish-blue, and this is most markedly the case when the urine putrefies (for its chemical reaction, see below).

Indican urea — that is increase of the indican—occurs: when there is accumulation of the intestinal contents, especially of the contents of the small intestine, hence in occlusion of the intestine from any cause, as peritonitis or obstinate obstipation; likewise, in all forms of severe cachexia, as well as in Asiatic cholera; lastly, in individual cases in health.

Urobilin, if it exist in considerable quantity in the urine, colors it a decided red or brownish-red. The foam of the urine sometimes looks yellowish-red or yellowish-brown.

While there is only a small quantity of it in health, it is abundant in febrile diseases and where there is at any time resorption of large effusions of blood. When there is a marked separation of it which continues for some time, a brownish discoloration of the skin is observed in the so-called urobilin-icterus, though there is still dispute as to its nature.

Proof of the increase of indican : The following reaction establishes

the presence of indican in increased amount, because it does not operate in the presence of the small quantity found in normal urine. We mix equal parts of urine and fuming nitro-muriatic acid in a reagent glass; into this we drop two to three, or at most four, drops of a concentrated solution of chlorinated potash; immediately, or after a few seconds, there is formed just beneath the surface a blue-black cloud—indigo-blue. By stirring the solution of potash in the urine we obtain, according to the quantity of indigo formed, a more or less dark coloration of the whole fluid. If, then, we add a few drops of chloroform and agitate (not shake) the reagent-glass several times, we have the blue color at the bottom from the settling of the chloroform (it becomes green if too much of the solution of chlorinated potash has been added, from the further oxidation of the indigo-blue).

Proof of urobilin. 1. Spectroscopic: Absorption bands in green-blue, between Fraunhofer's lines b and F (sometimes it is necessary to dilute the urine with water, in order to be able to make the examination). 2. Chemically: We add ammonia to the reddish urine in the reagent-glass. If there is much urobilin there, it gradually becomes a clear green; it is then filtered; and, sometimes, upon the addition of a few drops of a watery solution of chloride of zinc, there appears the rose-red-greenish fluorescence that is peculiar to urobilin.

2. *Discoloration of the urine from the presence of the coloring-matter of the blood, and of the bile.* That of the blood colors the urine variously according to the amount that is mixed with the urine, also whether it is fresh or has been changed, and according to the original color (concentration) of the urine: flesh-red or blood-red with greenish shimmer with the light passing through it, corresponding to the dichrotic behavior of the blood; or an untransparent brown, even blackish. Frequently the bloody color is easily recognized; but, generally, the reaction-test for blood coloring-matter is necessary (see Coloring Matter of the Blood).

Coloring-matter of blood occurs in the urine: 1. In hæmaturia, and this in the sediment. It is circumstantially described in the section on Admixture of Blood with the Urine. 2. In hæmoglobinuria. In this condition the hæmoglobin is found entirely dissolved or in granular lumps, but no red blood-corpuscles, or very few, are found in the urine. This results from hæmoglobinæmia (see p. 271), and this condition may arise from very different causes: from poisons (chlorate of potash, mineral acids, arsenical solutions, pyrogallic acid,

naphthol, poison of the edible mushroom, *helvella esculenta*; after transfusion of animal blood, as of lamb's blood); in infectious diseases (as scarlet fever, abdominal typhus, malaria, syphilis); after extensive burns; lastly, we have to mention a form of hæmoglobinuria which occurs as an independent disease—paroxysmal hæmoglobinuria.

Coloring matter of the bile exists in the urine in icterus (icteric urine). Such urine is most frequently a beer-brown, sometimes brown-green, or even black. If the urine of icterus, as is very seldom the case, is very thin, then it may have a golden-reddish tone. The foam that forms when it is shaken is then highly characteristic: from clear to dark yellow, green-yellow, even brownish. (Regarding the chemical tests for bile coloring-matter, and more particularly regarding its presence and that of the bile acids in the urine, see section on Coloring Matter of the Bile.)

3. *Staining of the urine from medicines.* It is very important to recognize these changes in color, so that one may be on the guard against deception by confounding them with the coloring matter of the bile and the blood.

The chrysophanic acid contained in rhubarb and senna passes off by the urine. It colors the urine slightly, making it at most a little brownish, if it is normally acid; but if it is alkaline, or is made so, then it becomes a purplish-red.

After taking logwood, alkaline urine also becomes reddish or violet.

Santonin colors the urine yellow or greenish-yellow, with a yellow foam; upon the addition of an alkali the color changes to red. Picric acid makes the urine yellow, but there is no change in color after changing the reaction.

Carbolic acid, naphthalin, creasote, and other preparations of tar, as well as the infusion of the leaves of *uvæ ursi* (arbutin) produce a greenish or greenish-black color of urine.

Brownish or blackish discoloration of the urine after standing for some time in the air is observed in patients with melanotic tumors, because the pigment which forms the coloring matter of the blood in those tumors passes off by the urine. A similar behavior of the urine is found in the presence of an abnormal amount of pyrocatechin, an extremely rare occurrence.

Transparency of the urine. A loss of transparency by turbidness may take place even in normal urine when it has been allowed to stand (see above). Urine that is turbid when passed is always pathological.

This is the case, first of all, in nephritis, in consequence of the presence of organized constituents; in all diseases of the urinary passages, for the same reason (here particularly on account of mucus); but especially in severe cystitis, because the urine in this condition is alkaline when it is passed (alkaline fermentation in the bladder), and hence, besides the organic constituents, contains a deposit of phosphates. Admixture of blood and pus always makes the urine turbid to some extent. The most striking, and, at the same time, the rarest kind of turbidness is that caused by fat in the urine, chyluria. Here the urine is milky, as if mixed with pus (galacturia) from the emulsified fat; or it contains large drops of fat or fat-bubbles swimming upon its surface (lipuria). By shaking the urine up with ether it becomes clear. But when it is allowed to stand, part of the fat settles as a sediment, and part forms a cream-like layer on top. (See further regarding Chyluria.)

The Specific Gravity of the Urine in Disease.

The specific gravity of the urine may vary from a little over 1000 to over 1060 (in diabetes mellitus). Apart from certain special admixtures (we mean particularly sugar, which increases the specific gravity without changing its color, and the special pigmentary admixtures, which, on the other hand, darken the color without essentially adding to the specific gravity), almost always in disease, as in health, a scanty, dark urine has a high specific gravity; an abundant, clear urine, a low specific gravity. According to Hæser and Neubauer, from the specific gravity we can obtain an approximation to the amount of solid constituents of the urine by multiplying the last two figures of the specific gravity by 2.33. This product represents the quantity of solid constituents in 1000 grammes of the urine. If we have 1200 grammes of urine with a specific gravity of 1021, then 1000 grammes of this contains $21 \times 2.33 = 48.93$ grammes of solids, and the whole amount = 58.7 grammes. But not much has been said regarding the change of material upon which it chiefly depends, because the different solid constituents of the urine have very different specific gravity, particularly urea, which, as compared with chloride of sodium is as 2 to 3. Hence, we can never draw definite conclusions from the specific gravity alone, and even where we can exactly determine the solids, as by examining the various material

changes, the quantitative determination of the urea or of the nitrogen is indispensably necessary.

The chief value in the determination of the specific gravity with reference to diagnosis consists in the following:

1. High specific gravity with clear and abundant urine points to diabetes mellitus. We may even say that a specific gravity of 1040 and over, the urine being clear, can only be caused by sugar, and hence is pathognomonic of diabetes.

2. Repeated or continued examination of the urine in general engorgement is of value, because this, as well as the quantity of the urine, measures the labor of the heart.

It is not unimportant to know further:

3. A low specific gravity, when there is a small amount of urine which is often high colored, occurs in nephritis from diminished excretion of urea, also in severe diarrhœa and vomiting.

Reaction of Urine in Disease.

For the reasons previously given (under Reaction of the Normal Urine), the reaction of the urine is reliable only a short time after it has been passed.

Neutral or alkaline reaction of the urine is met with in sickness:

1. Under the same conditions that make it neutral or alkaline in health.

2. When there is resorption of transudates and exudation in the cavities of the body, also from large effusions of blood, especially in the pleura and peritoneum.

3. With dilatation of the stomach, and particularly if the contents of the stomach must frequently be brought up, either by vomiting or artificially. The reason given is that the blood and the organism lose their acidity because free HCl is not again resorbed (?) (See above, under Reaction of the Normal Urine.)

4. Considerable admixture of blood or pus. In the cases of alkaline urine previously mentioned the urine is clear, or is turbid from the deposit of phosphate; it contains no bacteria, or only a few.

5. With alkaline fermentation of the urine in the bladder. This accompanies severe forms of cystitis. Here the urine is turbid, because of the presence of pus-corpuses, abundant bacteria, deposit of triple-phosphates, urate of ammonia, carbonate and phosphate of lime and magnesia. Sometimes it has a peculiar, urinous smell, and is

pungent from the free ammonia. By this latter a strip of red litmus-paper, just held free over the fluid, is colored blue.

Further regarding the formed constituents of simple alkaline urine, and that which has been the subject of alkaline fermentation, see under Sediment.

The acidity of the urine may be determined by a simple, but really not very accurate, method: Prepare a 10-per-cent. solution of caustic soda (1 of soda to 9 of distilled water), and pour this from a burette into the urine until a piece of very sensitive litmus becomes blue. 1 c.cm. of the soda solution corresponds to 0.0063 of oxalic acid.

Works upon analysis of the urine teach the more exact methods.

Pathological Odor of the Urine.

Here we must mention as worthy of recognition the pathological departures from the odor of normal urine. A urinous, more or less pungent, ammoniacal odor, in cases of severe cystitis, shows ammoniacal fermentation in the urine that is passed. Then there is the feculent odor when the urine is mixed with feces, whether the admixture takes place after the urine is passed (see Contamination, p. 399), or whether it has taken place from communication between the bladder and the intestine, with discharge into the bladder.

The most notable, and at the same time diagnostically important, odor of the urine is the fruity (apple-odor), or like chloroform. The substance which has this peculiar odor seems to be acetone (Petters) [compare what is said later regarding Acetone]. The urine which has this odor, upon the addition of chloride of iron, sometimes gives a burgundy-red reaction ("chloride-of-iron reaction," Gerhardt), which shows the presence of acetoacetic acid (see further below). Usually the odor of apples is more noticeable in the breath of the patient even than in the urine, and it may be noticed in the breath alone.

The apple-odor is observed in individual cases of diabetes mellitus. It especially occurs in diabetic coma or as the precursor of this condition, but it also exists, and, indeed, often for a long time, without the occurrence of coma.

Unusual odors may be imparted to the urine by medicines: after taking turpentine, violet odor; after cubebs and copaiva, the aromatic odor of these drugs.

Foul, albuminous urine, but especially urine that contains pus, develops, as the result of certain organisms, sulphuretted hydrogen:

hydrothionic urine. Sometimes this fermentation, with the development of sulphuretted hydrogen, seems to take place in the bladder (cystitis). On the other hand, if the urine, when first passed, is clear, and upon being promptly examined is found to contain sulphuretted hydrogen, it is probable that there has been resorption of SH_2 into the blood or into the bladder from the intestine, or from a depot of pus in the neighborhood of the bladder: under which circumstances the general symptoms of poisoning have recently been observed.

Urinary Sediments.

We are to call to mind the sediments, previously mentioned, which may occur in normal urine. On the other hand, these same sediments may sometimes be observed as pathological signs, as is shown in what follows:

All formed constituents which separate when the urine is allowed to stand are reckoned as "sediments," whether they can be recognized with the naked eye or only under the microscope, or whether they are organized or are really "deposits." As previously mentioned, in order to examine the sediment it is desirable carefully to pour off from the vessel containing the urine the upper part; the lower turbid or already settled portion is to be put into a glass with a pointed bottom, and again allowed to settle. Then follows the examination with the naked eye and with the microscope. For the latter, we take up some of the sediment with a pipette by introducing it closed by one finger upon the upper end to the bottom of the pointed glass, when it is to be opened again for a moment, then it is withdrawn and carefully wiped off, and a drop of its contents allowed to flow upon an object-glass. [A slide with a depression in the centre making a shallow cell is very convenient, since a larger drop can be examined at each time.] Upon this we place a glass cover, and examine it with a magnifying power of about 400 diameters. If the sediment is very scanty, we are to focus the microscope so as first to examine the edge of the covering-glass. It may happen that the sediment is so scanty that we cannot see anything at the bottom of the glass with the naked eye, but by carefully removing a drop from the bottom of the glass and placing it under the microscope we may possibly make out formed constituents, as a few casts (contracted kidney).

It is necessary to color the urinary preparations only when examining for certain microorganisms (see below).

1. *Sediments of Organic Bodies or their Direct Products.*

Mucus. Physiologically this exists only in small quantities. It is increased in all diseases of the urinary passages, but especially in cystitis, and also in fever.

Some mucous forms are characteristic: In the form of minute roundish floccules, the size of a millet-seed or the head of a pin, they are tolerably characteristic of mild cystitis. Under the microscope they show white blood-corpuscles lying closely to one another, and they are apparently conglomerations of white corpuscles.

In the form of threads, one to two centimetres long—gonorrhœal threads—sometimes more purely mucous in character, and, again, containing abundant pus-corpuscles: they occur in chronic gonorrhœa or as the residuum of a past attack.

Finally, we find microscopical mucous threads, cylindroids (see Fig. 123, p. 417), which may be confounded by the inexperienced with tube-casts. The origin and diagnostic significance of these is not clear. They are found in nephritis by the side of the casts, in cystitis, but also in health. They are distinguished from the urinary casts by their usually being of considerable length, their mucus-thread texture, their very varying thickness (as fine as threads, especially at the end), and their tape-like appearance.

Chemical proof of mucus in solution: The addition of acetic acid makes a flocculent precipitate, which is not again dissolved by an excess of acid, nor is it again dissolved by heat, as is the case with a precipitate of urates produced by acetic acid.

In women mistakes may arise from the admixture of vaginal mucus with the urine.

Blood, or red blood-corpuscles. The appearance of the urine varies very remarkably in hæmaturia. Sometimes there is a considerable bloody sediment, not infrequently partly coagulated; again, only a fine deposit of red blood-corpuscles spread out evenly; and lastly, sometimes, a more brown-red, clear, or dark-brownish sediment. The red blood-corpuscles may be so scanty as to escape detection with the naked eye. This distinction pertains to the amount of the blood and its having been for a longer or shorter time in the urine—that is, with reference to the location of the hemorrhage. (Regarding the color of the urine, see p. 401.)

Hæmaturia occurs :

(a) In diseases of the kidneys—that is to say, in acute and chronic hemorrhagic nephritis, in embolic hemorrhagic infarction of the kidney (valvular disease of the heart), in septic hemorrhage of the kidneys (acute endocarditis), in marked engorgement of the kidney, with new formations, and, lastly, in injuries to the kidney.

(b) In certain diseases of the urinary passages, and also of the pelvis of the kidney (nephrolithiasis, tumors), of the bladder (severe cystitis, tumors, stone), of the urethra (gonorrhœa with parasites of the urinary canal; see below).

Moreover, hæmaturia has symptomatic significance for recognizing diseases of other kinds. Thus it occurs in scorbutus, morbus Werlhofii, hæmophilia, and, lastly, in the rare hemorrhages of the kidney or urinary tract that are due to leukæmia.

From the appearance of the sediment and the way it is passed, a conclusion with reference to the location of the hemorrhage and the kind of disease will be made from the following points of view :

A small amount of blood, or, at least a not too abundant quantity of blood, uniformly mixed with the urine, the color of the blood being retained, or, more frequently, changed into a brownish color, points to a hemorrhage of the kidney. That this is its source can be more certainly proved by the microscope showing blood-casts (see below). Where there is renal hemorrhage, the blood-corpuscles are always more or less discolored, as rings or shadows. Cells and casts, if present, are stained brown by the coloring-matter of the blood. A brown color of the sediment

FIG. 123.

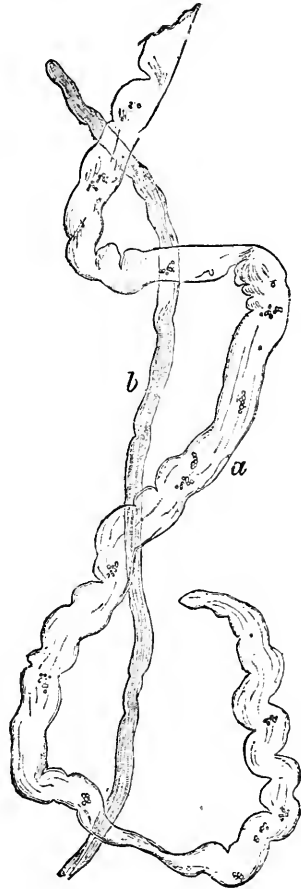

Cylindroids (see p. 416). (JAKSCH.)

and of the urine indicates acute hemorrhagic nephritis. The sudden occurrence of bloody urine, with valvular disease of the heart, points to renal infarction. Individual red blood-corpuscles occur in very concentrated urine in renal engorgement.

In hemorrhage of the pelvis of the kidney, especially that caused by stone, the urine usually alternates between being bloody and free from blood, and this, either because there are temporary hemorrhages or because the ureter of the diseased side is for the time being stopped, and then the urine that is passed only comes from the sound side. The blood may for a time escape very freely; in rare cases it may be passed in the form of vermiform coagula (casts of the ureter), which give great pain as they are passed.

Cystic hemorrhages, especially in villous tumors, may be so free as to be fatal. The urine is not intimately mixed with blood, especially if the patient lies quietly in bed; at first there is little or no blood at each urination; but then, again, pure blood is sometimes passed. On the other hand, in hemorrhage from the urethra, blood comes only at the beginning of the urination. Here, sometimes, there is an escape of blood between the urinations. Works upon surgery treat more at length of hemorrhages of the bladder and urethra.

Microscopical examination. In every respect this is the most valuable method for recognizing hæmaturia, especially from the following points of view: 1. Because the separate red blood-corpuscles can be discovered where neither the fluid portion of the urine nor the sediment shows the color of blood, and where, also, the fluid portion does not show the reaction of the blood-pigment (see below). 2. Because it alone establishes the differential diagnosis between hæmaturia and hæmoglobinuria. 3. Because, from the condition of the red blood-corpuscles, from the presence of possible blood-casts (see Casts), we can sometimes determine that there is renal hemorrhage.

In hæmaturia we find more or less abundance of red corpuscles. In decided hemorrhage, especially from the lower portion of the urinary tract, these are only slightly changed. If retained for some time in the urine, and particularly if they are scanty, as in renal hemorrhage, they are smaller, have granular contents, or are more or less markedly discolored. If they are very pale, then we have the so-called rings. If there are no red blood-corpuscles in a urine that is bloody and certainly contains hæmoglobin (see Examination of the

dissolved portion), or if they are very scanty in a urine that contains a good deal of hæmoglobin, then we have hæmoglobinuria (which see).

Besides red blood-corpuscles, we frequently find in the sediment, according to the disease present, still other formed constituents: in cystitis, first of all, white blood-corpuscles, phosphate crystals; in nephritis, casts and white blood-corpuscles. A considerable amount of blood in the urine makes it somewhat albuminous.

With women, we must remember the possibility of being deceived by the menstrual blood.

Hæmoglobin. In hæmoglobinuria there is usually a brown or brown-black sediment, which consists of brown flakes and fine granular detritus. A few red blood-corpuscles are likewise found. If casts and epithelium are present, they are often colored brown.

Pus, or white blood-corpuscles. It is rare that a considerable amount of pus is passed by the urethra. It happens if a neighboring depot of pus breaks into the urinary canal: in perinephritic abscess with discharge into the pelvis of the kidney, but particularly in abscesses of all kinds in the neighborhood of the bladder. Here the discharge of pus takes place suddenly, and after a short time the urine becomes normal again. But the discharge of pus into the urinary passage may continue for some time, or it may indicate cystitis.

Sediments of pus or white blood-corpuscles are more frequent, being caused by inflammation of the mucous membrane of the urinary tract, or by nephritis. In the latter case they are less abundant than in the former. The sediment is yellow to white, in nephritis; in catarrhal cystitis it is sometimes very like phosphatic sediment (which see). In inflammation of the urinary tract, generally the sediment becomes a peculiar compact jelly, from mucus; in alkaline urine, it is due to the mucous swelling of the white blood-corpuscles (see above); in nephritis, it is quite spongy.

The microscopical examination shows the white blood-corpuscles more or less changed according to their amount, the length of time they have been in the urine, and the reaction of the latter. In alkaline urine they are very clear and much swollen. Of the diseases of the kidneys, acute hemorrhagic nephritis, and sometimes the sub-

chronic (chronic parenchymatous) nephritis, show a relatively abundant amount of pus-corpuscles.

To a slight degree, pus makes the urine albuminous; a considerable amount of albumin in the urine is always due to renal albuminuria. When the quantity of albumin in the urine is slight, the question may arise whether we have nephritis, either as a separate disease or as a complication of cystitis or pyelitis. This can only be answered by the infallible sign of nephritis—that is, casts in the urine.

Fat-drops. The fat accompanying chyluria may, as was previously mentioned, exist in the urine as a sediment, but also as a cream-like or swimming layer, or in the form of large drops. We must remember that it may be due to impurities, as the use of an oiled catheter. The microscope shows minute particles of fat or large drops, which markedly refract the light. In the first case the fatty character of the sediment may be most quickly recognized by the grease-spot formed upon paper by the sediment. We may also shake it up with ether, and then allow the ether to escape by evaporation.

The occurrence of fat-drops free and attached to casts, adipose white blood-corpuscles, is very important in diagnosing large white kidney.

Epithelium. We find in the urine the epithelium of the urinary passages and the epithelium of the renal urinary channels [urinary tubules]. In addition, in women we have very frequently, but especially when there is leucorrhœa, flat epithelium from the vulva. The epithelial cells in transition are everywhere very similar. But renal epithelium is usually easily recognized as such.

While in normal urine only individual flat epithelial, and sometimes, caudate cells occur, we meet a large quantity of the three species of cells named in inflammation of the urinary passages. Usually, they are well preserved. It is misleading to form a conclusion from the kind of cells as to the location of the inflammation (especially whether of the pelvis of the kidney or of the bladder). The vulva being excluded, a large quantity of flat epithelium points to the bladder. Abundant caudate, but especially overlapping, “tile-like.” roundish cells with large nuclei, were formerly often regarded as characteristic of inflammation of the pelvis of the kidney; but more recently this view has come into discredit.

Renal epithelia occur in considerable numbers only in affections of the kidney, and especially in nephritis. If their form is well preserved, they are recognized without difficulty as polygonal or round-cornered cells of peculiarly sharp contour, with large oval nuclei and a decidedly granular, often yellowish-looking, protoplasm. They are small—not larger than white blood-corpuscles, sometimes smaller. In acute hemorrhagic nephritis they are often coarsely granular, brownish in color; in the large white (butter) kidney, but sometimes also in the first disease, we not infrequently see them in all stages of fatty degeneration.

FIG. 124.

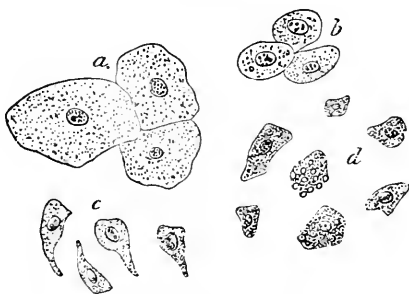

Epithelium from the urine. *a, b*, epithelium from the bladder, from the pelvis of the kidney; *c*, caudate epithelium (pelvis of the kidney?); *d*, renal epithelium, partly changed into fat.

Regarding cylindrical epithelium, see under Casts.

Shreds of tissue. Shreds of connective-tissue and “caseous crumbs” are found in tuberculosis of the urinary apparatus.

Particles of carcinomatous tissue are separated in carcinoma, but are more frequently found in *carcinoma villosum* of the bladder. Only particles which distinctly show the structure of carcinomatous tissue are of importance here. Single, or, also, several pretended “cancer-cells” lying close to one another have no diagnostic value.

Spermatozoa. After every discharge of semen these are seen in the urine. Hence, they are not unimportant for detecting masturbation. They also occur in spermatorrhœa. Lastly, sometimes they are found after epileptic attacks; also, now and then with severe diseases of all kinds, as in typhoid fever patients.

Casts. The so-called urinary casts (Henle, 1842) are incontestably the most important form-elements in pathological urine. They are

found with renal albuminuria. Aside from quite individual exceptional cases, they occur without simultaneous albuminuria only in one condition: hepatogenous icterus. Here they have no diagnostic interest further than that, from their occurrence, we may suspect the presence of bile-acids in the urine. They are intensely stained with the bile-pigment.

We concern ourselves only with the occurrence of casts with albuminuria. By their presence these not only permit a conclusion that there is a disease of the kidneys which causes albuminuria, but, by their quantity and character, also enable us to diagnose the exact nature of the disease. Regarding their numbers the casts are scanty, and then usually hyaline (see below), in engorgement of the kidneys, in fever, in physiological albuminuria; and, lastly, they are temporarily present in contracted and amyloid kidney. There is often here a sediment which is scarcely, or not at all, visible. In making a preparation we must, with the greatest care, take a few drops from the bottom of the urine-glass and examine the preparation with great thoroughness. It is advantageous, but not indispensable, to stain any casts that may be present by the addition of a little gentian-violet solution placed upon the edge of the covering-glass. The casts are very abundant in acute, and frequently also in chronic, nephritis. In these diseases they may form the principal portion of a tolerably abundant sediment.

Variation in the quantity of the casts is to be observed in all the diseases named. Sometimes it seems as if, after a period of stagnation, the casts are passed in greater abundance. This is not very rare in amyloid nephritis, also in acute attacks of nephritis.

In size and form the casts vary greatly. We will speak further regarding this.

As to their nature, we distinguish the following kinds of casts:

Hyaline casts. These are of great variety as to length and breadth; sometimes not so broad as a white blood-corpuscle (thin hyaline casts), and, again, five or six times as broad (thick or medium casts). In length they may be as much as one millimetre. They are homogeneous and clear as water, with a very fine outline, hence often very difficult to see; the ends look as if broken off, rounded, or even clubbed (for aggregation of substances within them, see below). They occur in company with other forms in all diseases of the kidney.

Exclusively hyaline casts occur most frequently in contracted and amyloid kidney, also in fever and with [renal] engorgement.

A special kind of hyaline casts are the waxy, so named from their dull lustre and usually yellowish color. Sometimes they show the amyloid reaction with iodine and iodide of potassium—brown, then violet with sulphuric acid. We cannot form a conclusion from them as to the nature of the disease of the kidney; certainly they are not pathognomonic of amyloid kidney.

Additions to the hyaline, and also to the waxy, casts frequently occur in the form of red and white blood-corpuscles, renal epithelium, crystals, granular masses, which, in turn, may show urates, phosphates,

FIG. 125.

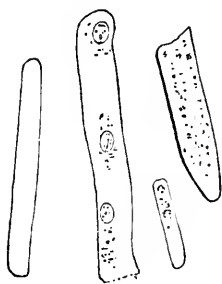

Hyaline casts (narrow and tolerably broad ones).

FIG. 126.

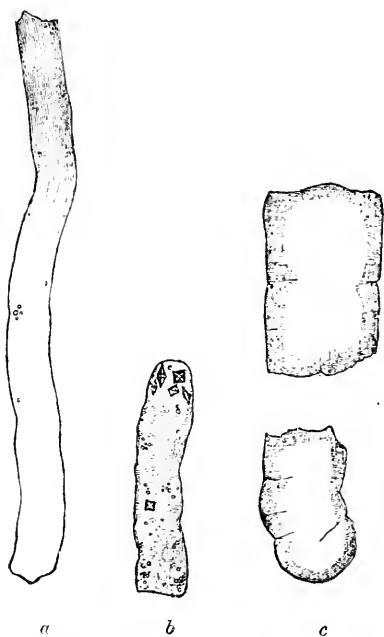

Waxy casts. (JAKSCH.) *b*, a cast containing crystals of oxalate of lime.

albuminous or fat granules, and, lastly, bacteria. Among these additions those of special significance are red blood-corpuscles, as in hemorrhagic nephritis, possibly adipose renal epithelia, white blood-corpuscles (granular spheres), and free fat-granules. These adipose elements, if abundant, are important for the diagnosis of large white or fatty kidney.

In some cases of pyelonephritis we have seen hyaline casts which

were split like a pair of trousers. These might possibly have their origin in collective tubes (?).

Casts that are coarse or finely granular are generally hyaline, with additions to their contents, as above. But, especially in acute nephritis, conglomerate casts of albumin in lumps and granules also occur; sometimes stained or mixed with hæmatoidin.

Blood casts are conglomerations of red blood-corpuscles held together by coagulation. They are important as indisputable signs of renal hæmaturia.

Epithelial casts are either hyaline casts with the addition of renal epithelium (recognized by their sharp outline and distinct large nuclei), or they are true epithelial tubes. In both cases they have the same significance—the free desquamation of renal epithelium, especially as it occurs with acute hemorrhagic nephritis.

FIG. 127.

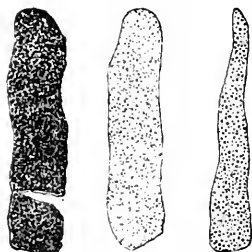

Fig. 127.—Granular casts. (JAKSCH.)

FIG. 128.

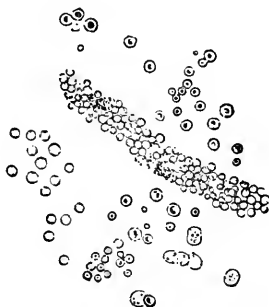

Fig. 128.—Red blood-corpuscles, partly as "rings" and cast of red blood-corpuscles. (EISENHORST.)

FIG. 129.



Fig. 129.—Epithelial cast. (JAKSCH.)

Casts of lumps of hæmoglobin in hæmoglobinuria, urate-casts in the newly born (uric acid infarction in connection with ammonium urate), and casts of bacteria in pyæmia (?) are very rare occurrences.

We may confound casts with cylindroids (see p. 416), also with threads of linen or other adventitious materials in the urine. Practice in examining and cleanliness guard one from mistake.

Animal Parasites.

Echinococcus. Shreds from echinococcus bladders, scolices, are met with in the urine if an echinococcus of the kidney or from the

neighborhood of the urinary apparatus breaks into the urinary passage. The passing of urine is often attended with severe pain, especially by attacks of colic during its transit through the ureters. They may be preceded by anuria from obstruction of the urethra, obstruction of one ureter, and "reflex" suppression of secretion upon the sound side (or reflex spasm of the sphincter vesicæ).

Distoma hæmatobium, an exotic from Egypt, located in the roots of the portal vein, also particularly in the plexus vesicalis, causes hæmaturia. The eggs of the parasite make their appearance in the urine.

Strongylus gigas located in the pelvis of the kidney causes pyuria and hæmaturia.

Filaria sanguinis, an exotic from East India, Japan, China, and Australia, located in the large lymph-vessels, among other things causes engorgement of the lymph-vessels of the bladder: chyluria (and likewise galacturia, see) and hæmaturia (peach-red urine). Besides, the urine contains embryo filaria, round worms of delicate structure, lying in a fine sheath, with lively motion. Its width is about that of a red blood-corpuscle; its length, two to three millimetres.

Oxyuris vermicularis, *trichomonas vaginalis* (an infusorium), and, in one case under my observation, the larva of a fly, *musca vomitoria* (!), may become mixed with the urine from the vagina.

Vegetable Parasites and Fungi.

Normal fresh urine, free from impurities, is not entirely free from fungi (see p. 399). A number of bacilli and cocci colonize in urine that has been standing for some time, of which those of special interest are the ones which cause alkaline fermentation, changing the urea into carbonate of ammonia (see p. 402).

The micrococci and bacilli of alkaline fermentation, and, with them, the signs of this fermentation—alkaline urine, crystals of triple-phosphate and carbonate of ammonia (see below)—however, occur in fresh urine in severe cystitis, particularly as the result of the use of a catheter that is unclean, in cases of weak or paralyzed bladder; but this is no doubt also caused by paralysis of the bladder alone, and the spontaneous entrance of fungus germs through the urethra. The fungi produce cystitis by the fermentation they set up, and this, in turn, favors the development of the fungi. If these schizomycetes are very numerous they may form the greater part of the abundant

sediment. Under the microscope we see chiefly the chain-coccus (*micrococcus ureæ*, *micrococcus ureæ liquifaciens*) and bacilli (chiefly *bacillus ureæ*, Leube), not so long, but thicker than the *bacillus tuberculosis*; all these forms of fungi being in the most lively motion. It is the presence of these fungi that distinguishes simple alkaline urine (see p. 413) from urine that is alkaline from fermentation.

Tubercle bacilli in the urine are an absolutely sure sign of ulcerating uro-genital tuberculosis. But in this disease, especially when there is tuberculosis of the pelvis of the kidney or of the kidney of only one side, the ureter of that side is temporarily or permanently stopped. In regard to the occurrence of single bacilli having the form and the color-reaction of tubercle bacilli, compare what has been said regarding smegma bacilli, p. 400. If tubercle bacilli appear at all in the urine, they are generally abundant, not infrequently even

FIG. 130.



Pure culture of tubercle bacilli in the urine in tuberculosis of the genito-urinary apparatus. Zeiss's homogeneous immersion one-twelfth eye-piece No. 4. Drawn with a camera lucida. Magnified about 1100. Author's observation.

in masses and with an arrangement which reminds one of a pure culture. Fig. 130 exhibits an excessive development of this kind (personal observation). In purulent urinary sediment they can be demonstrated just as distinctly as in the sputum. If there is decided anæmia, wasting, and continued fever, as well as in cases of long-continued gleet, every purulent urinary sediment should be examined for tubercle bacillus.

Gonococci (Neisser) occur in the pus of recent gonorrhœa in clusters, in epithelial cells, and in pus-cells. The latter circumstance is characteristic of gonococci, and distinguishes them from other bacteria which resemble them. Gonococci are chiefly met with as diplococci, and since the individual coccus seems to be divided into two by a bright transverse band, it often makes the so-called roll-form. In gleet and in persons who have formerly had gleet, but have for years

FIG. 131.



Gonococci in the pus from the urethra. Zeiss's homogeneous immersion one-twelfth, eye-piece No. 2 Drawn with a camera lucida. Magnified about 650.

been free from any symptoms, we find a diplococcus which resembles the gonococcus. But by recent investigations it has been discovered that even in the urethral secretion of persons in health, who have never had gonorrhœa, there occurs a diplococcus, free as well as enclosed in epithelia (although, of course, not in pus-corpuscles). This diplococcus has a form very much like the gonococcus (Lustgarten and Mannaberg). The gonococcus is to be stained with gentian-violet or methylene-blue, or fuchsin, and then rinsed in water.

Pathogenic fungi which circulate in the blood are, in individual cases, found in the urine: thus, tubercle bacilli in acute miliary tuberculosis, equinia, erysipelas cocci in erysipelatous nephritis (Fehleisen), spirillum recurrentis in complicating hemorrhage of the kidney (Kannenber), pus-micrococci in pyæmia and endocarditis (Weichselbaum). Also, casts of micrococci are described in septic processes (Litten and others).

Lastly, in cases of acute nephritis, bacteria have recently been found in the urine and in the kidney, which have been regarded by different authors as the specific excitants of the nephritis. These cases are too much isolated to permit us to form a definite conclusion as yet.

A small form of sarcina is found rarely in alkaline fermentation in the urine. It, as well as the other fungi named, is regarded as the cause of the transformation of the urea. *Leptothrix buccalis* occurs as a foreign substance, as from the preputial sac (Huber).

The occurrence of the yeast fungus, *saccharomyces*, in urine containing sugar is not unimportant. Here it causes acid fermentation. In urine that does not contain sugar, some yeast-cells are found occasionally, but they do not increase.

2 *Inorganic Sediments.*

These consist of materials which are ordinarily found in the urine in a state of solution, but which, for various reasons, are absent, chiefly because the urine is very much concentrated, or because its reaction has changed. These bodies show the forms of more or less pure crystals; they may be crystalline, or amorphous, but nevertheless often have a peculiar symmetrical form. Here we really consider the finer urinary sediments; urinary calculi, which belong to surgery, will be mentioned at the end and only very briefly.

(a) *The more frequent inorganic sediments.* From acid urine there are deposited:

Uric acid, uric acid salts (sodium, lime), oxalate of lime.

From the faintly acid, neutral (amphoteric), alkaline urine there are deposited:

Ammonio-magnesian phosphates, phosphate of lime, carbonate of lime, urate of ammonia, and sometimes uric acid.

All these substances may occasionally be deposited from healthy urine (see p. 402).

Uric acid. As is stated above, we find this as a deposit not only in acid, but sometimes in neutral and alkaline, urine. It can often be recognized with the naked eye in the form of yellowish-red, glittering granules, which are located upon the side of the urine-glass, or in the form of a yellowish-red powder at the bottom of the glass. Uric acid deposited from the urine always has this yellowish-red color, while the chemically pure uric acid is colorless. Under the microscope it shows the greatest variety of crystal forms and crystalline figures (see Fig. 132). The basis form is the rhomboidal plate. But this is rare. More frequently we have derivatives of

this, the so-called "whetstone" (with a cross or in druses), "barrel-shaped," also peculiar bundles of prisms, lastly, amorphous lumps and clubs with separate, shining, smooth surfaces—all easily recognized by their distinct color. We may artificially produce a separation of uric acid deposit by adding to the urine some concentrated solution of salt and allowing it to stand for twenty-four hours. Ordinarily, chemical reaction is not necessary.

FIG. 132.



Uric acid and urates. (FUNKE.)

FIG. 133.

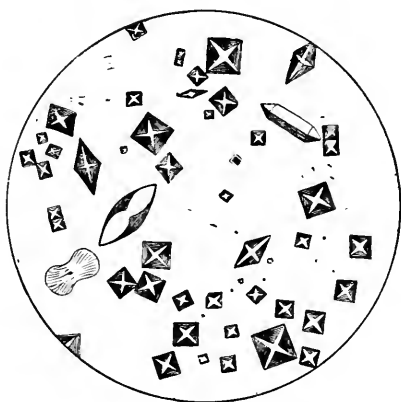

Oxalate of lime. (LAACHE.)

The occurrence of uric-acid crystals in the urine only shows that uric acid is not exactly wanting in the urine, and nothing more. It is said that the frequent separation of amorphous forms indicates urinary calculi (Utzmann).

Urate of soda and lime. When concentrated urine cools there is often a very abundant sediment, colored a flesh-red by the urinary pigment, "brick-dust sediment," or *sedimentum lateritium*. When cooled to zero, C., we can obtain it from any urine. It will be most easily recognized by the fact that it immediately completely dissolves when the urine is warmed (not boiled, because then there is a phosphatic cloudiness, and also coagulation of albumin, if present). Under the microscope the urates of soda and of lime are seen as very fine grains. They incline to settle upon the casts, and especially upon mucus threads. Uric-acid crystals form about half an hour after the addition of some muriatic acid.

From concentrated urine the lateritious sediment is deposited at

the ordinary temperature of the room, especially in engorgement of the kidneys, in attacks of diarrhoea, in fever, and also in health (see p. 402). We should never conclude from its presence that there is increased separation of uric acid. We can only determine this by ascertaining the amount of uric acid and urate separated in twenty-four hours.

Oxalate of lime. Single crystals of this may appear in any urine that has been standing for some time. The crystals are almost always tolerably small, sometimes minute regular octahedra, which are conspicuous by their perfect form and strong refraction of light (envelope-form). They are rarely hour-glass- and dumb-bell-shaped. The crystals are insoluble in water, and are thus distinguished from chloride of sodium.

FIG. 134.

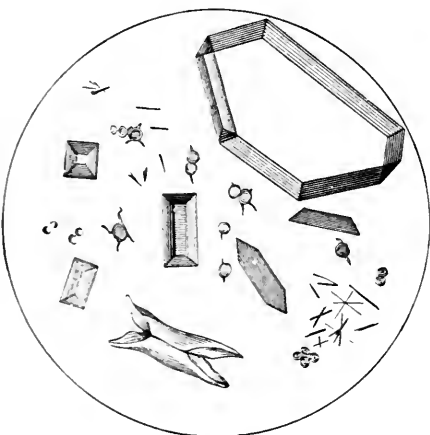

Triple-phosphates: urate of ammonia. (LAACHE.)

FIG. 135.



Phosphate of lime. (LAACHE.)

These crystals occur in the urine in great abundance after eating certain fruits and vegetables, as apples, pears, cauliflower, and the different kinds of sorrel; and also in diabetes mellitus, catarrhal icterus, hypochondria. Moreover, we cannot conclude, without further evidence than the mere occurrence of a somewhat large amount of these crystals, that there is increased separation of oxalic acid (oxaluria). The disease described by English physicians (and Cantani) as oxaluria does not seem to be a unity. This oxaluria occurs in cachexia (tuberculosis, cancer).

Ammoniaco-magnesian phosphate (triple-phosphate) is found in urine that is simply alkaline and that is undergoing alkaline fermentation. Sometimes it forms the principal portion of the whitish sediment. The basis form is the rhombic prism; it is well formed in the "coffin-lid crystals," often also of various other forms, and is then more difficult to recognize. The triple-phosphates are all perfectly colorless, and soluble in acetic acid, thus contrasting with oxalate of lime.

Phosphoric acid as a basic salt occurs in amorphous grains in alkaline fermentation of the urine. It is soluble in acetic acid, but not by heat. As a neutral salt it occurs in simple alkaline urine in the form of long wedges or knife-blades. These disappear in alkaline fermentation.

FIG. 136.

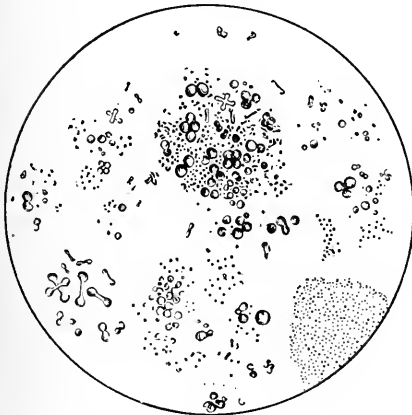

Carbonate of lime. (LAACHE.)

FIG. 137.

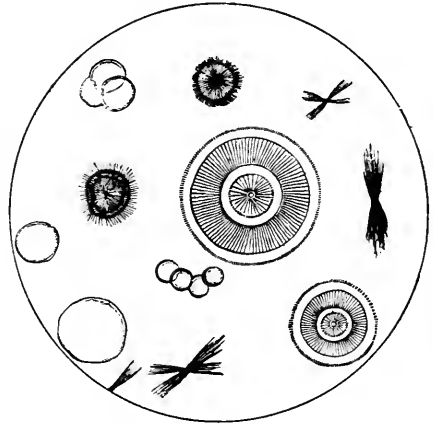

Leucin and tyrosin. (LAACHE.)

Carbonate of lime, in the form of spherules or crossed drum-sticks, seldom occurs in alkaline urine. ["In highly alkaline urine, in which the alkalescence is caused by carbonate of ammonia set free by decomposition of urea, carbonate of lime occurs in small quantity, but in an amorphous form. This is the only form in which I have yet seen carbonate of lime in human urine."—Beale.] It is dissolved by the addition of muriatic acid, with effervescence.

The so-called *phosphaturia* is a condition in which phosphates and carbonates are precipitated before or immediately after the urine is passed. But there is no increase in the phosphoric acid. The

precipitation is probably produced by the alkalinity of the urine. Phosphaturia occurs in neurasthenia, hypochondria, chronic articular rheumatism.

Urate of ammonia accompanies triple-phosphate in alkaline fermentation. The characteristic form is that of the thorn-apple (grayish-yellow or brownish opaque balls, from which fine needles project). When muriatic acid is added, there develop under the covering-glass uric-acid crystals.

(b) *More rare inorganic sediments.* Hæmatoidin is exceptionally found in the forms of needles and plates mentioned before (p. 180). Sometimes we see white blood-corpuscles which contain hæmatoidin needles, which project through the cell-membrane.

Leucin and tyrosin (see Fig. 137). The characteristic forms of these substances, which almost always appear together, are sometimes found in the sediment, more often only when we have evaporated the urine in a water-bath to the consistence of syrup, or until we slowly boil down a drop of urine upon an object-glass until it is almost dry. Leucin appears in the form of faintly shining spheres, which sometimes, if they are large, show radiating lines and concentric rings. Tyrosin crystallizes in very fine needles, which commonly form druses and bundles.

Leucin and tyrosin are products of the decomposition of albumin. They do not occur in normal urine. Diseases in which they are found and for which they may have diagnostic value, are acute yellow atrophy of the liver and acute poisoning by phosphorus. They are also seen in variola and typhus abdominalis [typhoid fever], as well as in pernicious anæmia (Laache).

Cystin sometimes occurs in the urine in health. Large quantities of cystin in the urine may cause the formation of cystin-calculi and excite cystitis, and are thus a pathological condition in themselves. According to recent investigations (Baumann, Brieger) there seems to be a connection between the occurrence of ptomaines and cystin in the urine. Brieger assumes that by the presence of certain ptomaines in the intestinal canal (hence, in mycotic enteritis) the cystin forms a combination with the ptomaines in the intestine, which overflows into the urine. There the compound decomposes, and cystin is again set free. Sometimes this does not take place, and so calculi are formed. The ptomaines, in turn, may cause inflammation, especially cystitis.

Cystin, besides occurring in the urine in the form of calculi, is seen in the form of extremely thin, six-sided, and very perfectly formed colorless plates.

(c) *Concretions in the urine.* We are interested only in the concretions that arise in the pelvis of the kidney, as in nephrolithiasis, pyelitis calculosa. Those that form in the bladder belong to surgery. The former are named, according to their size, renal sand, renal gravel, renal calculi. If they attain a certain size, they cause severe attacks of pain in their transit through the urethra (renal calculi colic). Most frequently the concretions consist chiefly of uric acid and urates. They are then brown or brown-black, and tolerably smooth on the surface. Stones of oxalate of lime are densely hard and have a rough surface (mulberry calculi); they are dark brown. A combination of layers of uric acid and oxalate of lime is likewise met with. Phosphatic calculi are tolerably soft, but not infrequently they contain a kernel of the first-named substances (phosphate deposited upon the stone from the alkaline urine of cystitis [excited by the original stone]). Finally, we must mention stones of cystin and (extremely rare) xanthin. All these stones, with the exception of the phosphatic calculi, are formed in acid urine.

For the exact chemical examination of the concretions we refer to the text-books upon Urinary Analysis.

EXAMINATION OF THE URINARY CONSTITUENTS IN SOLUTION.

1. *Anomalies in the Quantity of the Normal Constituents.*

In disease the normal constituents of the urine are variously increased or diminished. These quantitative variations, however, can only exceptionally be made use of for the diagnosis of disease. But they are important for determining the change of material and the removal of material that can be carried off by the urine in various diseases. This requires throughout an exact quantitative analysis, for the different "approximative methods" have no value at all. We cannot here go into an explanation of the exact methods, but must refer to the hand-books upon urinary analysis. However, we mention briefly the most important anomalies which belong here. We have already mentioned the quantities of the normal constituents of the urine, p. 404.

Urea. This is increased in fever, either absolutely, as in pneu-

monia, or relatively—that is, in relation to diminution in the amount of food taken. It is also increased in diabetes. We find it diminished in all forms of nephritis, but especially in uræmia; in cachexia of all kinds, especially if there is dropsy; and, lastly, sometimes in acute yellow atrophy of the liver. The very decided increase in the amount of excretion of urea which takes place immediately after the crisis in pneumonia is designated as post epicritical. It is probably connected with the increase in the amount of water secreted by the kidney.

Schwald has recently (*München med. Wochenschrift*, 1888, No. 46) devised a simplification of Knop-Hüfner's method of determining the amount of urea, which seems to us to be very practical and relatively exact. We have not yet had an opportunity to test thoroughly the method. At least, we recommend that it be tried.

Uric acid is usually increased in fever parallel with the urea. Besides, it is increased in leukæmia and pernicious anæmia (with the first, often very markedly), also in all diseases which affect the interchange of gases in the lungs; and, lastly, with the uric-acid or gouty diathesis, apart from attacks of gout, during which it is often diminished.

The total amount of nitrogenous material in the urine, the most important for determining the metamorphosis of tissues, approximately agrees with the amount estimated from the urea, because the uric acid, kreatinin, and xanthin bodies are insignificant in amount compared with the urea. Besides, the most practicable method for the quantitative determination of the urea (Liebig's) is really a determination of the total amount of nitrogen, expressed as urea (C. Voit, Salkowski, and Leube). When determining both nitrogen and urea, of course, it must be done apart from any possible albumin—that is to say, the latter must first be removed.

Chloride of sodium is pathologically increased during the resorption of transudations and exudations, and also in intermittent fever, from the destruction of red blood-corpuscles (Kast). It is diminished in fever, nephritis, and in many cachectic conditions. [In pneumonia, during the stage of exudation and until resolution begins, the chlorides are diminished or disappear from the urine. While the disappearance of the chlorides from the urine is not characteristic of

this disease alone, it shows that exudation is still going on, or that resolution has not yet commenced.]

Sulphuric acid interests us chiefly with reference to the associated ethylsulphuric acid (phenol-, indoxyl-sulphuric acids). It is found with increased separation of indican and carbolic acid. Regarding the former, see p. 409. The latter occurs with the internal and external use of carbolic acid.

It has been found that the phosphates are diminished in rhachitis, also in acute yellow atrophy of the liver. In nephritis they are not infrequently diminished.

2. *Abnormal Constituents.*

Albumin. Except in the rare cases of physiological albuminuria already mentioned, any separation of albumin in the urine is pathological. This is always so if it continues. The albuminous substances, which in the conditions reckoned as albuminuria in the narrow sense can be separated, are serum-albumin and serum-globulin. Their amount varies from a trace to one-half per cent.—very exceptionally more. Generally, it remains below one-half per cent. The secretion of hemialbuminose is very rare, and thus far has not been found to have special diagnostic significance. Of late, we are not accustomed to regard peptonuria as albuminuria. It will be considered at the close of this chapter.

Albuminuria occurs :

1. As true renal albuminuria, in all forms of acute and chronic nephritis, in amyloid kidney, in engorgement of the kidneys; in hydræmic conditions of the blood, as anæmia, leukæmia; in fever, and in acute poisoning; in these two cases, especially in the latter, there occur, besides all the transitions to nephritis; lastly, after epileptic attacks, apoplexy (transitory albuminuria).

Besides, there has recently been discovered a peculiar form of albuminuria which is distinguished from other forms by the absence of all pathological signs in the urine, especially of cylinders: cyclic albuminuria. See, regarding this, p. 437.

2. Further, albumin in solution in the urine may also pass over into the urinary passages when blood and pus are mingled with the urine in the bladder. The amount of albumin, however, is always small.

Qualitative tests for albumin. We select a few from the great number of tests for albumin, which have the tolerably uniform approval

of authors (see, regarding them, Penzoldt's *Old and New Urinary Tests*), and which, according to our experience, have the preference.

The preliminary condition is that the urine be not contaminated, as by menses or leucorrhœa, and that it be clear. The latter is the more necessary in proportion as the amount of the albumin is small. In order to be able to discover it when only a very little is present, it is necessary to filter the urine until it is perfectly clear.

(a) Addition of acetic acid and ferro-cyanide of potassium. By the acetic acid the urine is rendered distinctly acid, and then the cold urine is mixed with a few drops of a watery solution of potas. ferro-cyanide. Even with a very small amount of albumin, very fine floccules are formed, often almost milky cloudiness, though when there is only a very small quantity of albumin it is somewhat delayed. This very certain and distinct test is strongly recommended for use at the house of the physician.

(b) Boiling and the addition of nitric acid. If the urine is neutral or alkaline, acetic acid must be added to it to render it acid before boiling. If there is cloudiness, it can only be due to one of two causes: albumin or phosphates. To determine which of these it is, we add about ten drops of nitric acid, when the phosphatic deposit is immediately dissolved; but if the deposit is of albumin, it is made more distinct. When the albumin is somewhat abundant, the deposit can be immediately recognized by its floccular appearance. The test is a sharp one, showing even 0.005 to 0.01 per cent. of albumin, and, being tolerably certain, is in general to be recommended.

(c) Picric-acid test. We add to the urine a few drops of a concentrated watery solution of picric acid: if it immediately becomes cloudy, it shows albumin; but cloudiness appearing later shows nothing (Johnson, Penzoldt). It is a certain and sharp test, not less to be recommended than the others.

As portable tests for albumin, we can proportionally recommend the following as best:

(d) Geisler's albumin test-papers.¹ These consist of a piece of filter-paper saturated with a concentrated solution of citric acid, and of another saturated with a three-per-cent. solution of iodide of potassium added to a twelve or fifteen-per-cent. solution of corrosive subli-

[¹ They may be obtained of Parke, Davis & Co., and other manufacturing chemists.]

mate. We first put one of the strips of the first into the urine—if very alkaline, more than one—then one of the second papers, and shake it. Cloudiness due to albumin appears pretty promptly. Peptone is also precipitated, which, in many cases, can cause deception (see Peptonuria). In concentrated urine, urates are also precipitated, but these can afterward be dissolved by heat. Deception from the solution of particles of paper making a cloudiness is not possible, if it is carefully examined. As a preliminary test at the sick-bed, this method is to be recommended. But we ought not to be satisfied with its result, and should always afterward employ one of the tests previously mentioned.

If we examine the urine a number of times in twenty-four hours, and find that there is a periodic presence and absence of albumin, we designate this condition as cyclic albuminuria.¹ It never occurs after rest at night; the albumin is generally separated after exertion. In case this condition is suspected, we are to examine the urine several times during the day, and especially toward evening, also directly after rising in the morning.

Klemperer has made a very clear demonstration of the course of the separation of the albumin. He places about five c.cm. of the urine, passed at different times during the day, in a series of reagent-glasses, and then boils them with the addition of nitric acid. The height of the deposit in the glasses, as they are arranged in a row, may be regarded as a direct delineation of the "albumin curve."

Quantitative test for albumin. Here, as in all quantitative determinations, the urine of exactly twenty-four hours must be mixed, and a portion from this mixture examined. The urine for exactly twenty-four hours can be obtained if we have the patient urinate early, say shortly before seven o'clock, and then keep all the urine that is passed till the next morning at exactly the same hour, passing his urine again at seven o'clock.

It is possible to make an exact quantitative determination only by completely separating the albumin from a measured quantity of urine. Filter, wash the residue upon the filter-paper, dry, and weigh it. (For particulars regarding these processes, see text-books upon Urinary

[¹ In the British Medical Journal, January 31, 1891, p. 218, Dr. Herringham gives a valuable and careful study of a case of Cyclical Albuminuria which was under his care at the West London Hospital.—TRANSLATOR.]

Analysis.) This examination can only be conducted in a laboratory. There is no mode of procedure which is more simple, nor one that is so nearly exact as this. The polarizing method is only applicable when there is a considerable amount of albumin.

A substitute for the exact quantitative determination is quite commonly found by endeavoring to estimate the amount of deposit which results from the qualitative determination, especially by the boiling nitric-acid test: we wait a long time—till it settles in the reagent-glass—and then we speak of one-half, one-quarter, or the whole being albumin, by comparing the volume of albumin that can be seen with the whole amount of urine in the reagent-glass. It may be assumed that one-half the volume of albumin, if the reagent-glass has stood for one hour, corresponds to about 0.2 to 0.6. This estimate is extremely unreliable, being chiefly dependent upon the size and thickness of the flakes of albumin. But, if we always employ the same test for albumin, it is certainly not valueless for judging of the variations in the separation of albumin in the course of disease.

More exact is the method with Esbach's albuminometer, although it acts upon the same principle, and so is only approximative. What exactness it has depends in reality upon the employment always of the same reagents, mixing them with an equal amount of urine, and always allowing the same time for the deposit of the precipitate.

The albuminometer—a graduated thick reagent-glass—is filled with urine to the mark *U*, from there to *R* with the reagent. This reagent consists of 10 grammes of picric acid and 20 grammes of citric acid to 1000 of distilled water.¹ The glass is then closed with a rubber cork, turned upside down ten times, and allowed to stand undisturbed for twenty-four hours, best in a special stand. After this period of time we notice at what mark of the scale on the glass the albuminous deposit stands. The marks each give one-tenth per cent. of albumin. As the scale only goes as far as 0.7 per cent., urine that

FIG. 138.



Esbach's
Albuminometer.

¹ The exact amounts of both acids (chemically pure and dry) are to be dissolved in 1000 grammes of water, made hot, and, after cooling, any deficit in the amount of fluid is to be made up by the addition of water to 1000 grammes.

is strongly albuminous must be diluted in a definite way before the test. We must avoid producing air-bubbles, because these cause the precipitate, or a part of it, to swim, and for this reason we are not to shake the glass. If there are air-bubbles, they must be removed with a pipette.

In most cases the method is tolerably exact (an error of one-tenth to two-tenths of albumin), but in individual cases, and often without any recognizable cause, the precipitate does not sink down as well as it usually does. Nevertheless, it is to be recommended as an improvement upon the simple, rough "volumetric" estimate. [The apparatus is not at all expensive. It can be obtained in New York of Eimer & Amend.]

Rare Forms of Albumin.

Peptone (von Jaksch, Maixner, and others). This never occurs in healthy urine. Pathologically, it occurs sometimes in ordinary albuminuria, and, again, independently—peptonuria. It occurs in a great number of very different conditions: in large abscesses, in emphysema, sometimes in pneumonia; likewise in acute rheumatism, scorbutus, phosphorus-poisoning; also, in carcinoma ventriculi, in puerperal fever, in typhus abdominalis [typhoid fever], etc. Hence, this very remarkable substance has no value for diagnosis. Its determination, even qualitative (biuret reaction), is, for various reasons, difficult.

Hemialbumose (hemialbuminose, propeptone) very rarely exists in the urine (albumosuria). There must arise a suspicion of these albuminous bodies, which, according to the latest researches, show a mixture of four albuminous substances (Kühne, K., and Chittenden), if there is a precipitate in the urine after it has been subjected to the boiling and nitric-acid test. For demonstrative tests, see the textbooks upon the subject. Hitherto this substance has had no diagnostic significance.

Kahler has recently observed hemialbumose in multiple primary lympho-sarcoma of the spinal cord.

Fibrin occurs in the urine in hæmaturia, in deep-seated inflammation of the urinary passages, in tuberculosis, in poisoning with cantharides, and in chyluria. It is recognized by the fact that it coagulates spontaneously in the urine, although sometimes only after the urine has stood for some time. The coagula are then to be further examined.

In this place are to be mentioned two phenomena that occur in those diseases of the kidney that stand in close relation to albuminuria: dropsy and uræmia.

The dropsy of kidney disease manifests itself, very frequently, first in the skin of the face, especially at the eyelids. With contracted kidney the œdema is very fugitive, often changing its place; in a large number of cases, it is entirely wanting during the entire course of the disease. With large white kidney it is more decided and stable; there is often a very soft, doughy œdema. In this respect acute nephritis varies very much. In all forms of Bright's disease, from its association with heart-weakness, a new factor may come into play for the development or increase of the œdema and effusion into the cavities of the body (dropsy of engorgement).

With reference to the cause of the dropsy in kidney-disease, no doubt the most important element is the diminished elimination of water by the kidneys. This retention of water often, especially if excessive, has the effect that even a slight, perhaps a scarcely noticeable, dropsy of the skin and subcutaneous tissue considerably disturbs the excretion of water by perspiration. At any rate, it is certain that the dropsy of kidney-disease is, in many cases, not explained by the retention of water; but neither is Cohnheim's hypothesis, that the walls of the vessels are abnormally pervious, at all generally accepted. This whole matter is still an open question.

Uræmia is an association of nervous manifestations which, at least in the majority of cases, is dependent upon the retention in the blood of urinary products (especially uric acid). In individual cases of "uræmic" manifestations, however, this explanation is not correct, and the nature of such cases is not yet clear (œdema of the brain (?), Traube; sometimes anatomical changes in the brain (?), Strümpell, etc.). We coincide with Strümpell's view, that uræmia is a multifarious condition—a number of conditions, which by their presence and their phenomena seem to belong together, are in reality different.

Slight uræmic symptoms may last, with slight changes, for weeks, even months, as somnolence, restlessness, headache, malaise, vomiting, dyspnoea (uræmic asthma), indications of Cheyne-Stokes respiration, slight transitory disturbances of vision. The more severe symptoms are: decided cloudiness of intelligence, even to coma or delirium; maniacal conditions; convulsions, from single convulsive movements

to pronounced epileptic attacks; and temporary amaurosis. There may be slowness of the pulse, with acceleration later, and fever. In individual cases there occur evident symptoms of cerebral congestion: convulsions, paræsthesia, paralysis of an arm or of one side of the body, and aphasic manifestations.

Mucin. It has already been mentioned when this appears in the urine. When the mucin is dissolved, its presence can be established by the addition of acetic acid: it forms a flocculent, thready precipitate in cold urine, which is not again dissolved by an excess of acetic acid.

Coloring-matter of the blood. The occurrence of this body has also been previously mentioned (p. 410). Here we have to refer to testing for hæmoglobin, or hæmatin in solution.

First, it must be mentioned that, of course, the urine shows the presence of albumin in both hæmaturia and hæmoglobinuria. The amount of albumin is always small, provided there is no albuminuria besides.

Blood-pigment will be shown to be present by the following procedures:

(a) *Heller's test.* A portion of urine is made decidedly alkaline with caustic potash, and boiled in a reagent-glass: the phosphates are precipitated as very delicate floccules, which look like mucus, and slowly sink to the bottom. They accompany the blood-pigment, and hence look brown or red-yellow. When the urine is concentrated, we dilute it, after boiling, by filling the reagent-glass with water, because the color of the floccules is easily concealed. Urine that is poor in phosphates, as in nephritis, gives no phosphatic deposit. Such urine must be mixed with some that has the normal amount of phosphates, before making the test. The color described as belonging to the phosphatic deposit occurs nowhere else, except with urine containing chrysophanic acid, but this latter is recognized by its change in color after the reaction. This test is very simple, certain, and, with clear urine, is tolerably distinct.

(b) *Test with tincture of guaiac.* The reagent consists of tinct. guaiac, ol. terebinth. ozonizat., ãã 10 parts. A small portion of this, placed in a reagent-glass, is carefully covered with urine: when the coloring-matter of the blood is present, there is, besides the dirty white deposit of resin, an indigo-blue ring. When shaken up, the

whole contents of the glass become a non-transparent bright blue. The test is a very distinct one.

(c) *Test for hæmin.* This is made with a large drop of urine or urinary sediment, exactly in the same way as has been described already (p. 363) for finding it in the material vomited. The test is more distinct than the preceding, particularly if we boil it down in a porcelain dish and then apply the reaction.

(d) *Spectroscopic examination.* This gives the absorption-bands of methæmoglobin, namely, in yellow, green, and red. Of course, this is an extremely distinct test.

Bile-pigments and Bile-acids.

Gmellin's test for bile-pigments. We pour a small quantity of nitric acid into a reagent-glass and add to it one or two drops of fuming nitric acid, forming a trace of an admixture of nitrous acid. To this mixture we very cautiously add a layer of urine, by permitting it to flow from a pipette, down the side of the glass held obliquely. When the bile-pigment is abundant, if the fluids are kept carefully distinct, there is a ring of green (blue), violet, and red. The first named constitutes the test. There is no reaction when there is only a small amount of bile-pigment.

Rosenbach's modification is decidedly more distinct. Filter some urine, not too little (about 200 c.cm.), through a medium-sized filter, and pour upon this the mixture of nitric and nitrous acids. The colored rings form upon the filtrate.

Still sharper is Gmellin's test, if, after acidulating the urine with acetic acid, we shake it up with chloroform, pour off the urine, and then with the chloroform, colored yellow by the bile-pigment, make a layer with the nitric-acid mixture.

Penzoldt recommends a filtrate prepared as in the Gmellin-Rosenbach test (allowing a good deal of urine to flow through), over which acetic acid is poured, and this is allowed to flow into a broad glass vessel, so as to have it in a shallow, but broad, layer. The acetic acid becomes yellow-green, gradually becomes green (quicker, if it is warmed), even bluish-green. Penzoldt declares that this test is very distinct.

Pottenkofer's test for bile-acids: glycocholic, taurocholic, and

cholal acids. This test is based upon the fact that the addition of a weak solution of cane-sugar (1 to 500) and a trace of concentrated sulphuric acid to urine causes a violet-red color. We must be careful not to have the resulting elevation of temperature too high, at most not higher than about 50° C.

For various reasons this last reaction is uncertain. Its result is reliable only when the bile-acids, if present, have been isolated. At any rate, the bile-acids have only a slight diagnostic value: a trace sometimes occurs in normal urine, while we find in undoubted cases of jaundice due to engorgement of bile, often none, or only a trace, because frequently in the transmission it becomes broken up in the blood. Hence, we cannot account for the absence of the bile-acids in the urine in cases of icterus by the assumption that it is not an hepatogenous icterus. On the other hand, an abundance of bile-acids in the urine proves that the jaundice is due to engorgement of bile. Moreover, it is clear that if we wish to explain "hepatogenous" icterus by the idea of engorgement of bile in the liver, logically, we must assume an increase of the bile-acids in this jaundice also. As a matter of fact, this is found to be the case in toxic "hemato-hepatogenous" icterus (arseniuretted hydrogen, toluylendiamin, Stadelmann).

Grape-sugar. Pathologically, grape-sugar occurs in the urine:

1. In diabetes mellitus, usually in considerable quantity—as much as two to five per cent. (minimum one-half, maximum ten per cent.). The urine is increased in amount, is bright and clear, of higher specific gravity, as has already been mentioned.

2. As glycosuria (Frerichs), usually in small quantity. It is almost always temporary after poisoning with carbonic oxide, curare, amyl nitrite, turpentine; sometimes with mercury, morphia, chloral, prussic acid, sulphuric acid, alcohol; again, in acute infectious diseases (typhus, scarlet fever, diphtheria, etc.; in diseases of the oblongata (but here it is more lasting); and from other neurotic causes, as excessive mental exertion, neuralgia, injuries to the central nervous system, concussion of the brain, etc.; also, after epileptic convulsions and *apoplexia cerebri*.

It is to be remarked that the urine is always to be examined for sugar when it has a decidedly high specific gravity; but particularly if it is clear and abundant, and, at the same time, has a high specific gravity.

Qualitative Tests for Sugar.

Bismuth test (with Nylander's modification). For this purpose, we employ Nylander's reagent: 2 parts basic nitrate of bismuth and 4 parts soda tartrate, to 100 parts of an 8-per cent. solution of caustic soda. Of this we take 1 part to 10 of urine, and boil them together. After a few minutes, if there is only a little sugar—sometimes only after it has cooled—it becomes black from the reduction of the contents of the reagent-glass with the formation of the oxide of bismuth, if the urine contains as much as one per cent. of sugar.

It is evident that this is a very distinct test. It is only uncertain when there is albumin in the urine (arising from the black sulphuret of bismuth); here it had better not be employed.

Trommer's test. To a given quantity of urine we add about one-third as much liq. potassæ, and to this, drop by drop, of a 10-per-cent. solution of the sulphate of copper, as long as it is held in solution by mixing; then it is heated. A precipitate of yellowish-red hydrated cupric suboxide, which may appear even before the fluid has been boiled, shows the presence of sugar with the greatest probability. The yellow color of the liquid, or a precipitate that takes place later, may be caused by a very small amount of sugar, but also by uric acid and creatinin. Thus, the test is uncertain when the quantity of sugar is small; hence, in brief, it is not a sharp one.

Phenyl-hydracin test (von Jaksch). About two grains of muriate of phenyl-hydracin and three of acetate of soda are put into a reagent-glass which is filled half-full of water. After heating, the glass is to be filled with the urine to be tested. It is allowed to stand for fifteen or twenty minutes in boiling-water, then it is put into a beaker-glass filled with cold water. When there is a large amount of sugar, there is formed a macroscopically visible deposit. With a small amount of sugar, after standing, there is a deposit, which can be seen with the microscope, of yellow needles, single and in druses—phenyl-glucosazon. Yellow plates and brown balls prove nothing. Albumin that may be present must previously be removed by boiling the urine.

Jaksch urges this test because it is a very exact one. Its difficulty consists in this, that the needles of phenyl-glucosazon are sometimes not alike clearly characteristic in distinction from the yellow plates, etc., which prove nothing, these latter not being crystallizable in alcohol. Nevertheless, the test seems to be a very sharp one.

Of the other very numerous tests for sugar we only mention the following :

Moore's liq. potassæ and boiling test, which causes urine that contains sugar to become brown—not a very certain and sharp test ; and the test with diazo-benzol-sulphuric acid and potash, recommended by Penzoldt.

One test, of great importance and highly recommended on account of its absolute certainty, is somewhat troublesome :

Fermentation test. This rests upon the peculiarity that yeast has of separating sugar into alcohol and carbonic acid (succinic acid, etc.). The test may be made in a simple way, as follows : Three perfectly clean reagent-glasses are filled about two-thirds full of mercury. The first is then to be filled with some of the urine to be tested and a little yeast ; the second is to be filled with normal urine and some yeast ; the third with a thin, watery solution of sugar and yeast. It is well to add to each a drop of a solution of tartaric acid. All three tubes are now placed upside down in a tray of mercury, by covering the opening with the thumb as we invert them. The second tube should not show any development of carbonic acid, but if it should do so the yeast was not perfectly free from sugar, and the experiment must be repeated with yeast that is perfectly pure. The third glass should show the development of carbonic acid, otherwise the yeast has become inactive. The first tube shows carbonic acid or not, according to the state of the urine under examination in respect to its containing sugar. The development of carbonic acid is recognized by the existence of gas in the upper part of the inverted tube. Its presence is made certain by its being absorbed when potash-lye is introduced into the tube.

Fermentation-tubes are very helpful in employing the fermentation test (see Salkowski-Leube, Penzoldt).

Quantitative Determination of Sugar.

This is indispensable, if a case of diabetes is to be carefully observed, particularly for determining its severity, its course, especially the effect of treatment. From the qualitative examination we cannot draw satisfactory conclusions as to the amount of sugar, except by a comparison of the specific gravity of the urine with its quantity.

We make use of the urine that is passed in exactly twenty-four hours.

1. *Estimating it with Fehling's solution* (after Salkowski-Leube, Penzoldt). The principle is that in Trommer's test, the oxide of copper in an alkaline solution of grape-sugar is reduced to a lower state of oxidation: five parts of anhydrous grape-sugar will reduce 34,639 parts of pure sulphate of copper to protoxide. The problem is to determine how much of a specimen of urine is necessary to reduce a certain amount of sulphate of copper.

Solution I. 34,639 grammes of pure sulphate of copper are, by warming, dissolved in about 100 grammes of water, and the solution is then diluted to 500 c.c. It is to be set away well corked.

Solution II. 173 parts of tartrate of soda and 100 parts of officinal solution of caustic soda of the specific gravity of 1034, dissolved in water to 500 parts. This is to be kept in a well-stoppered bottle; but it must not be allowed to become too stale.

Mode of procedure: Equal parts of I. and II. are mixed together. The mixture (Fehling's solution) must not, when boiled, separate any oxydul. 10 c.c. of the mixture and 40 c.c. of water are placed in a deep porcelain saucer. Thoroughly mixing the urine of twenty-four hours, we take a portion of this and dilute it with 9 parts of water (urine 1, water 9), and with this we fill a burette. The mixture in the saucer is brought to the boiling-point, and into this the urine in the burette is allowed to flow: there occurs a separation of oxydul and oxydul-hydrate, and the blue color of Fehling's solution disappears. The instant when the fluid (if we incline the saucer) first loses its color, shows the completion of the reduction. We allow the amount of urine necessary to complete the reduction to flow from the burette.

Calculation: Since 0.05 gramme of grape-sugar reduces 10 c.c. of Fehling's solution, therefore the quantity of the mixture which has escaped from the burette contained 0.05 gramme of grape-sugar. We represent that quantity of the mixture by "q," then the mixture in the burette contains $\frac{0.05 \times 100}{q} = \frac{5}{q}$ per cent. of sugar. And, since the mixture of urine was diluted tenfold, the urine itself contains $\frac{5 \times 10}{q} = \frac{50}{q}$ per cent. sugar—that is, 5 times the amount diluted, divided by the quantity of the mixture in the burette that was used.

The dilution of the urine is to be varied according to the amount of sugar it contains.

2. *Determining the sugar by circumpolarization.* This depends upon the property of sugar to turn the plane of polarization to the right. Recently, the method has come somewhat into discredit, or it has been shown to be exact only when we exclude oxybutyric acid and any levulose that may be present (which, according to Kulz, sometimes occurs in severe forms of diabetes). Regarding complicated methods (complete fermentation, etc.), see hand-books upon Urinary Analysis.

We do not give a description of the method by polarization, as a description of its use always accompanies the different apparatus sold. (We recommend particularly the simple apparatus made by Zeiss.)

Other Soluble Constituents of the Urine.

Levulose sometimes occurs in the urine, in addition to grape-sugar, in cases of diabetes mellitus. It gives the chemical reaction of the latter, and for this reason it cannot, without complicated methods, be recognized, chiefly on account of a striking difference between the quantitative determination by Fehling's solution, on the other side, and the polarizing apparatus on the other. Levulose turns it to the left; but we must be on guard with reference to oxybutyric acid.

Lactose, occurring in puerperal patients, *inosite* in diabetes insipidus, *albumin*, can only be demonstrated in the urine when they are isolated.

Lipuria, as has been already mentioned, occurs in chyluria. It has, in one instance (Ebstein), been found in pyonephrosis: small quantities of fat occur, with large white kidney (see Sediments), in poisoning by phosphorus, and in diabetes mellitus, but also in health after taking very much fat, as cod-liver oil. The proof is by shaking it up with ether. *Lapaciduria* (fugitive fatty acids in the urine) has recently been much studied, but thus far, from the standpoint of diagnosis, without significance.

Diaceturia, resulting from acetoacetic acid in the urine (Jaksch), never occurs under physiological conditions. It is observed (always with a simultaneous abundance of acetone, see below) in diabetes, and especially in the severe forms, which then sometimes end in coma; also in fever and as an independent disease (Jaksch); and both are apt to occur in children. *Diaceturia*

is generally, especially if it occurs in adults, associated with severe symptoms, particularly nervous, which are to be regarded as signs of auto-intoxication [poisoning]; hence it may result in deep coma and be the direct precursor of death. As to its significance when it occurs in children, Jaksch, by recent investigations, arrives at the supposition that the convulsions which so frequently occur with them in acute diseases are explained by diaceturia.

Test. Some solution of chloride of iron is slowly added to the urine; sometimes there occurs a precipitate of phosphates, which must be removed by filtration; then more iron chloride must be added. If glacial acetic acid is present, the urine becomes a Bordeaux-red. Then the test must be repeated with urine that has been boiled. Further, a portion of urine must be mixed with sulphuric acid, extracted with ether and repeated with the extract; lastly, it must be examined for acetone (see below). Diaceturia is present if, in the presence of the chloride-of-iron reaction of the fresh urine, 1, the boiled urine shows no, or only a slight, chloride-of-iron reaction; 2, if the ether extract shows a chloride-of-iron reaction which fades in the course of twenty-four hours at the longest; 3, if acetone is present at the same time (Jaksch).

Acetonuria, in contradistinction from the preceding, is, it seems, in most cases a phenomenon without significance. It occurs in health (a trace), in fever, in diabetes, with inanition, but also without these in carcinoma, in psychoses. There also seems to be an auto-intoxication [poisoning] with acetone (v. Jaksch), which accompanies symptoms of cerebral irritation (also epileptic convulsions), states of depression. The cases hitherto observed have ended in recovery. Thus, an abundance of acetone is found in the urine, but no glacial acetic acid (see above).

The exact test is complicated. Several methods have been given, which, if one wishes to be certain, it is best to employ simultaneously: 1. Distil the urine with some phosphoric acid. Several cubic centimetres of this distillate are mixed with a few drops of solution of iodine and iodide of potassium; an immediate precipitate of iodoform-crystals proves acetone (Lieben). 2. We add to the urine some freshly-prepared oxide of mercury, obtained by mixing an alcoholic solution of potash with chloride of mercury. Filter it, and cover the filtrate with sulphate of ammonium: a black ring of sulphate of mercury shows acetone (Reynolds). Legal (cited by Jaksch) has devised

a test for acetone which is a useful preliminary one: Several cubic centimetres of urine are treated with a few drops of a concentrated solution of sodium nitroprusside and somewhat concentrated liquor potassæ. If acetone be present, a bright red color is seen, which quickly fades, but upon the addition of some acetic acid changes to purple or violet-red.

Acetone is a product of normal decomposition of albumin. If this body is abundant in the urine it indicates an increased decomposition of albumin. It is worthy of note that acetic acid easily breaks up into acetone and carbonic acid, and that acetic acid, in turn, is a product of oxidation of β -oxybutyric acid. This acid is found in diabetic coma, as it seems, exceptionally in very large quantities in the urine (Stadelmann, Minkowski); and it becomes more and more probable that it, in union with other fatty acids, must be regarded as the cause of diabetic coma, as the pupils of Naunyn, mentioned above, have for years maintained. Hence, in diabetic coma we have to deal with an acid-intoxication of the organism, in which it is to be assumed that the given acids only *as acids* are poisonous—that is, by the withdrawal of alkalies from the blood.

In close relation with the withdrawal of the acids stands (according to Hallervorden, Stadelmann) the separation of a substance with which the organism, as long as possible, attempts to neutralize the pernicious acids: the separation of *ammonia in the urine*. We cannot go into the subject here, for the reason that the quantitative determination of ammonia does not come within the province of this work.

[The Translator adds here a summary of Stadelmann's observations upon "Diabetic Coma," as given in the *American Journal of the Medical Sciences*, taken from *Deutsch. med. Wochenschrift*, 1889, No. 46:

"1. Diabetic coma, apart from accidental coma due to other causes, occurs only in the case of diabetic patients whose urine contains oxybutyric acids.

"2. Almost equivalent in value with the recognition of oxybutyric acid is the determination of the amount of ammonia in the urine; while it is also far easier of performance.

"3. Diabetic patients with an excretion of ammonia of more than one and one-tenth grammes per day, are in danger of becoming severe cases of the disease.

“4. Patients excreting two, four, six, and more grammes of ammonia daily, need constant watching by the physician, and are in constant danger of passing into diabetic coma.

“5. If the determination of the presence of oxybutyric acid, or the estimation of the amount of ammonia, cannot be carried out, at least the chloride-of-iron test should be made. If this gives a more positive reaction, oxybutyric acid is present in the urine, and the cases answer to the statements made in the third and fourth conclusions. The converse of this, however, is not always true, for there are cases of diabetes with oxybutyric acid in the urine, and even suffering from diabetic coma, the urine of which does not give the chloride-of-iron reaction.”]

Regarding the occurrence of the two compounds of sulphuric acid or of the products of their decomposition (here also belong indican, which has been previously mentioned, indoxylsulphuric acid), also of ptomaines, ferments (especially pepsin), see the various special works upon these subjects.

The Urine as Affected by Medicines.

The determination as to whether a medicine has been taken or not may often be of diagnostic importance. A number of medicines may be directly detected in the urine; to those not easily, or not at all, demonstrable to a slight extent, according to Penzoldt's recommendation of a particular case, we can add one easily demonstrable.

If we find in the urine the reaction of demonstrable medicines that have been given, then we can naturally assume that any other which was mixed with it has been taken.

Iodide of potassium. Add a couple of drops of red fuming nitric acid and about one-quarter as much chloroform as there is of urine; shake it; the chloroform gradually settles down, colored reddish-violet.

Bromine. The same method; chloroform colors it brown-yellow.

Salicylic acid. The urine is made a blue-violet by the chloride of iron (not Burgundy-red, see Diaceturia). When the amount of salicylic acid is small, we shake up the urine (to which some sulphuric acid has been added) with ether and then apply the test.

Rhubarb and senna, see p. 411.

Carbolic acid, also *naphthalin*, *resorcin*, etc. Upon standing, the urine becomes olive-green to brown-black, even black (hydrochinon). Exact determination requires particular methods.

Salol. Urine containing this, as well as carbolic acid, becomes green to black, and, at the same time, responds to the tests for salicylic acid.

Antifebrin. Add one-fourth volume of a concentrated solution of hydrochloric acid in a reagent-glass; boil for a few minutes; cool; add a few c.c. of a three-per-cent. solution of carbolic acid and a drop of dilute solution of chromic acid. The mixture becomes red; after the addition of ammonia up to an alkaline reaction, a beautiful blue. (After Müller.)

Antipyrin, *thallin*. Red coloration with chloride of iron; moreover, thallin urine is green-brown.

Works upon Chemical Analysis and Toxicology give further information.

CHAPTER VIII.

EXAMINATION OF THE NERVOUS SYSTEM.

ANATOMY; NORMAL AND PATHOLOGICAL PHYSIOLOGY.

ONLY a sketch of what is most important can be given here. For further particulars, see the special text-books upon the subject.

1. THE CORTICO-MUSCULAR TRACT (THE PYRAMIDAL TRACT, FLECHSIG).

It has its origin in the so-called psycho-motor centres of the cortical substance of the cerebrum. These lie in the motor-cortical

FIG. 139.

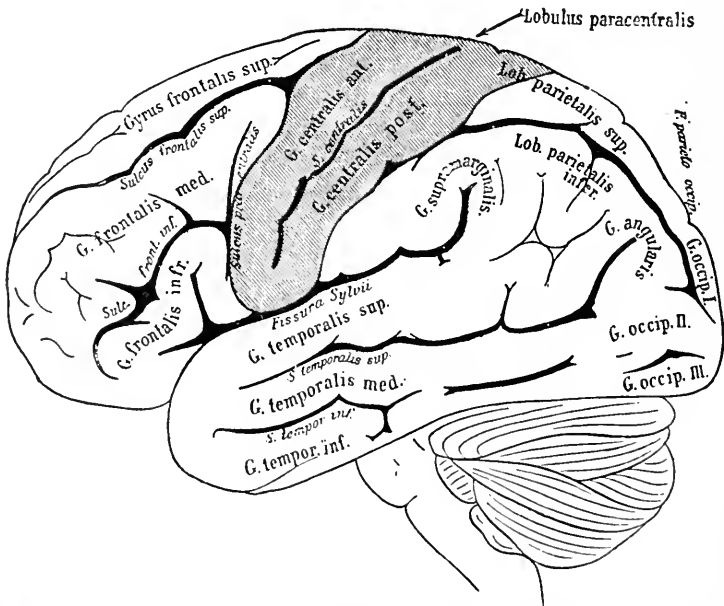

Lateral view of the brain. (Combined from ECKER.) Gyri and lobuli marked with antique type, the sulci and fissures with italic type.

FIG. 140.

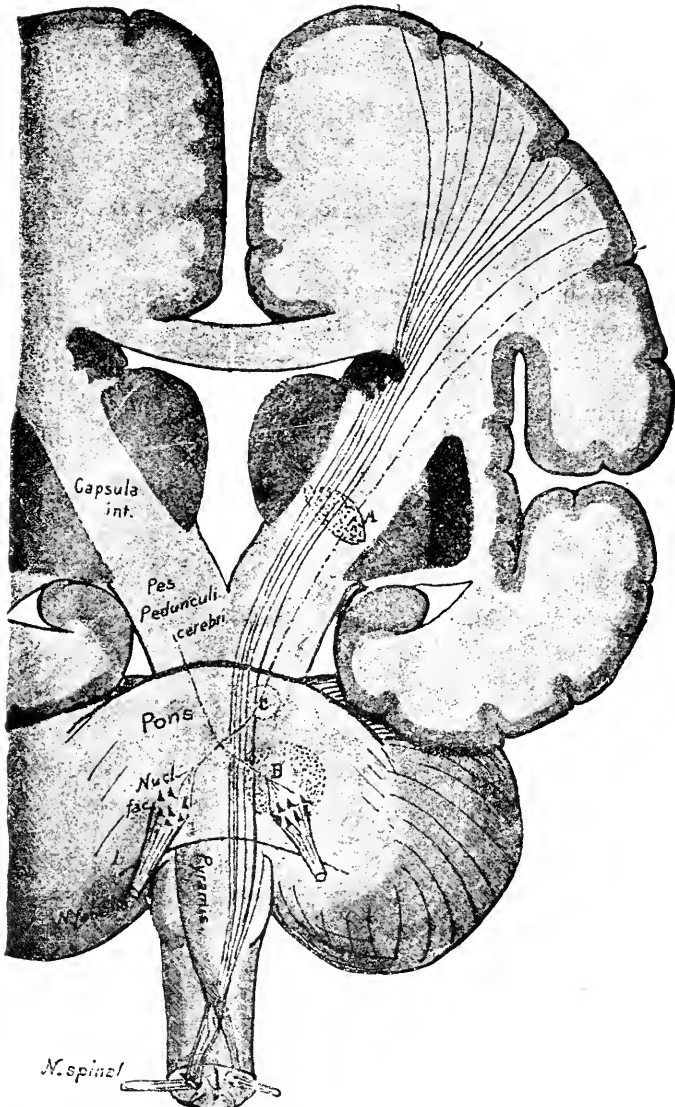

Diagram of the motor tracts of the facial nerve and of the nerves of the extremities. (EDINGER.) At *A, B, C*, are indicated supposed local diseases. *A*, lesion of the left side of the internal capsule, causing right hemiplegia on the right side; *B*, lesion of the left half of the pons, touches the pyramidal tract of the extremities of the right side and of the left facial, causing crossed paralysis; *C*, shows the rare condition of uncrossed facial paralysis and paralysis of the extremities from lesion in the pons.

region, which includes the anterior and posterior central convolutions and the lobus paracentralis of each hemisphere. It has been found that the centre for the lower portion of the face (the countenance, excluding the forehead), and the tongue, is from the lower section of the anterior rather than the posterior central convolution.

FIG. 141.

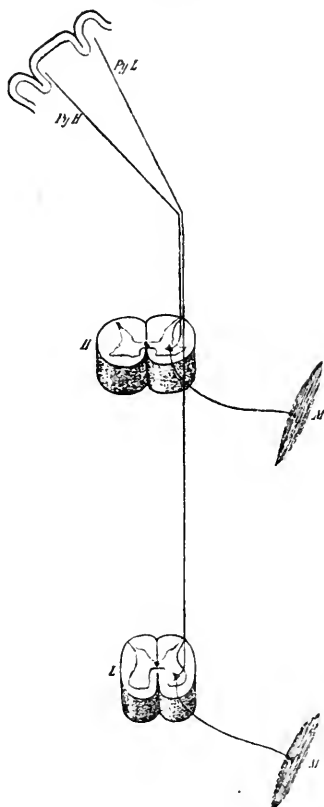

Diagram of the innervation of the muscles. (Partly from EDINGER.) The radiation of the *Py*-tracts varies at different portions of the cortex (see p. 452). *Py-II*, pyramidal tract for the cervical spinal cord; *Py-L*, pyramidal tract for the lumbar portion of the cord; *II*, cervical cord; *L*, lumbar cord; *Py-V* is omitted. Notice that down to the lumbar portion of the cord *Py-L* passes in the lateral column.

The centre for the arm is in the middle portion of the anterior central convolution.

The centre for the leg is in the lobus paracentralis and the upper section of both central convolutions.

Thus, the centres of the cortex lie tolerably wide apart.

The tracts course from there, and next converge in the corona radiata, in a fan-shape, to the internal capsule, where they lie close together in its anterior segment, hence between the lenticular nucleus and optic thalamus. They lie close behind a point midway between these [but do not connect with them]. From thence they go to the foot of the crus cerebri, passing about in the middle of it. In the pons, the pyramidal tracts are split up by transverse fibres. They unite again to form pyramids at the anterior portion of the medulla oblongata, and here the pyramidal tracts of the two sides lie very close together. [From the circumstance that they form the anterior pyramids of the medulla, they receive their name, "pyramidal tracts."] At the lower end of the medulla the right

(see below) and transpose them into motor stimuli, which they convey to the anterior roots.

But both central apparatuses also have trophic influences--that is, they preside over the nutrition of a certain section of the cortico-muscular tract. The cortical centres preside over the nutrition of the fibres until they enter the ganglia of the anterior horn. These latter control the nutrition of the peripheral nerve-fibres and of the muscles.

Paralysis is produced by any lesion (local disease: hemorrhage, softening, inflammation, tumor) at any point in the cortico muscular tract which disturbs the central ganglia or interrupts the course of the tract. According to the location of the lesion, this paralysis shows different characteristics; and these may primarily be studied from three points of view:

1. If the lesion is located in the cortex, or affects the tracts above the point of decussation, then the paralysis is upon the opposite side of the body; on the contrary, lesion below the decussation produces paralysis of the same side. If located in the pons, it may happen, for example, that besides the pyramidal tract, which as yet has not decussated, it affects the fibres of the facial, which have already crossed over (see above), it then causes paralysis of the opposite side of the body and of the same side of the face, hence these two cross each other--*hemiplegia cruciata seu alterans*.

2. If the lesion affects a cortical centre, or a point in the pyramidal tract in the brain, the pons, the oblongata, the spinal cord above the point of entrance of the particular tract into ganglia of the anterior horn (or the analogous gray nuclei of the oblongata or of the pons), then, because the trophical influence of the cortical centre from above ceases at that point, the affected tract degenerates just up to the corresponding cells of the anterior horn, while these and the peripheral nerves and the muscles do not degenerate. This degeneration of the pyramidal tract does not in itself cause any further clinical phenomena. On the other hand, if the lesion is in the anterior horn, or downward from there in the motor tract, there is degeneration downward of the nerves and muscles supplied by the portion which is the seat of the lesion. In the latter case, we have the clinical evidences of degeneration (rapid diminution in volume, diminution or loss of electrical reaction, and other signs of degeneration, see below).

3. Since the centres and tracts in the different sections in some instances lie wide apart and in others close together, a certain extent of lesion, according to its location, will cause a paralysis widely different in its extent :

(a) A lesion of considerable extent located in the cortex, or in the corona radiata, just under it, generally affects the centre for one-half of the countenance, or an arm, or a leg (monoplegia).

(b) If located in the internal capsule, then the lesion need not be so very large in order to produce a paralysis of the whole of the opposite side of the body—hemiplegia. This points to the *crus cerebri*.

(c) If the lesion is in the cord, where the motor organs and all the other nervous organs of the body lie close together, it easily causes paralysis of both sides: thus, lesion of the dorsal portion of the cord produces paralysis of both lower extremities, or paraplegia inferior; lesion of the cervical portion of the cord sometimes causes paralysis of both arms and both legs, or only the former—paraplegia superior seu brachialis.

To the above statements we may add still another :

(d) If the lesion is in the pons and oblongata, it may easily affect to a considerable degree the centres that are very essential to life, as the respiratory-centre, vagus-centre for the heart, and death may soon follow. Often, if there is hemorrhage or softening, it may take place immediately.

A local disease at the base of the brain injures the cranial nerves which go off from that point. If it is located in the anterior cranial fossa, the olfactory nerve will be affected; if in the middle cranial fossa, it may cause disease of the opticus, oculomotorius, trochlearis, abducens, sometimes also the olfactorius; if in the posterior fossa, the trochlearis, abducens, facialis, acusticus, glosso-pharyngeus, vagus, accessorius, come under consideration. The disease may be bilateral. See the illustration, which shows how the different nerves come together at the base of the skull. From simultaneous injury to the *crus cerebri*, pons, and oblongata, the pyramidal tracts may become affected, and paralysis of the extremities results. In basilar affections, this is generally less marked than is the paralysis of the cranial nerves.

The foregoing contains only the introduction to the points of diagnosis in these directions. We must refer for particulars to the

FIG. 143.

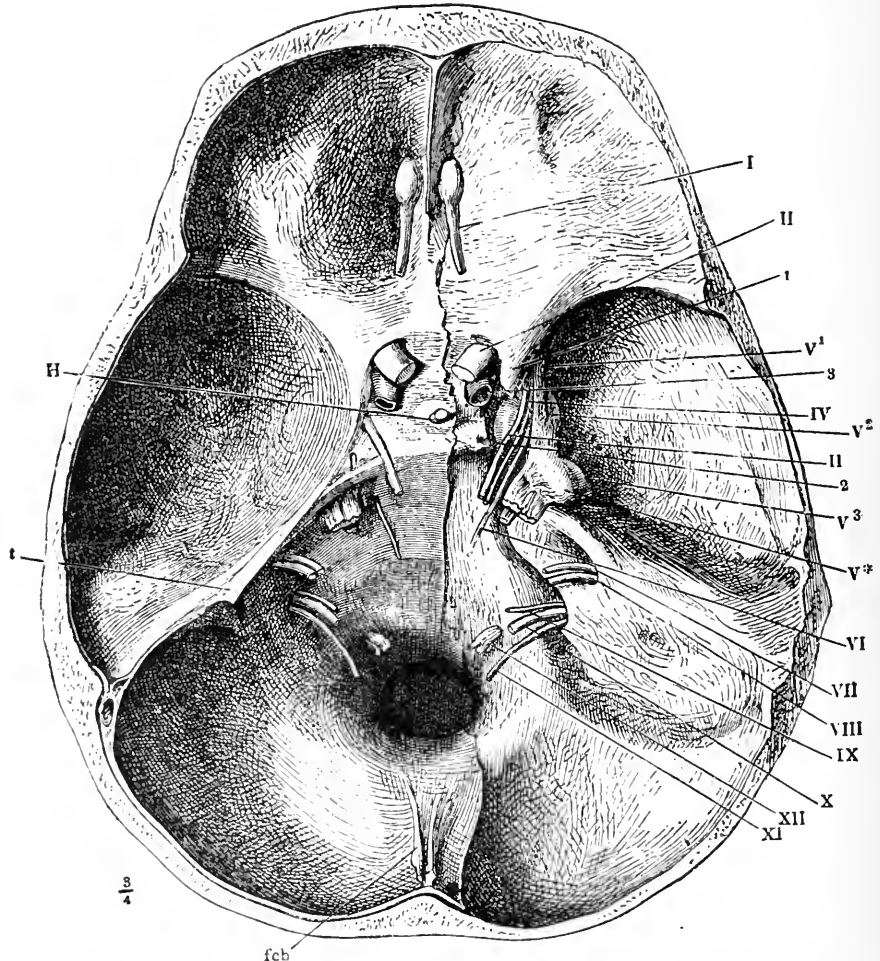

Points of exit of the cranial nerves from the skull (HENSEL.) The Roman figures indicate the cranial nerves; V¹, V², V³, first, second, and third branches of the trigeminal; V⁴, Gasserian ganglion.

clinical text-books. We refer here to text-books upon clinical medicine, and particularly to the second edition of Edinger's book on the

Structure of the Central Organs of the Nervous System, the second edition of which has just appeared.

2. THE SENSITIVE OR CENTRIPETAL TRACTS.

The tract of the sensibility of the skin of the trunk and of the extremities passes from the sensitive terminal fibres of the skin in the mixed nerves, then into the posterior root to the cord. From there it, for the most part, enters the posterior horn (it is doubtful whether a small portion may not enter the lateral column); it decussates soon after its entrance into the cord—how, we do not know. Above the cord we do not know the behavior of this tract till it reaches the *tegumentum cruris cerebri*, into which it passes. Then it enters the inner capsule behind the pyramidal tract—that is, in the posterior third of the posterior peduncle. Beyond this, we do not exactly know its course.

The tract of deep sensibility (usually called the muscular sense) probably has the same course as that we have just described. Most probably it ends in the motor cortical zone of the central convolutions and the lobus paracentralis.

An important centripetal, but not in the strict sense a sensitive, tract, are the columns of Goll, which likewise arise from the posterior roots, which, moreover, only from the upper part of the dorsal portion of the cord, and above that point, form a compact bundle in the median portion of the posterior column. We know nothing positive of their function. Also, the lateral column of the tract of the cerebellum is centripetal, which, in the upper portion of the cord, springing from the columns of Clarke, goes into the cerebrum. Its function, also, is not entirely clear; probably it is of service in preserving equilibrium.

Severe lesions, or complete interruption of the tract of sensibility of the skin in the peripheral nerves, or in the cord, or in the internal capsule, cause total anæsthesia of the skin. If the lesion is not severe, there is diminution of the sense of touch or a partial loss of sensibility—a partial paralysis of sensibility, as the sense of pain—and this latter is frequent, especially in disease of the spinal cord. Anæsthesia from local disease of the internal capsule, or of the spinal cord, manifests itself upon the opposite side.

3. CENTRES AND TRACTS OF THE SPECIAL SENSES.

(a) Sight. This tract passes from the retina in the eye to the chiasm. Here occurs a peculiar partial decussation (semi-decussation), which is reproduced in Fig. 144: the optic nerve-fibres belonging to the outer half of the retina do not cross, those belonging to the inner half do. Then it passes in the optic tract to the anterior corpus quadrigeminum, and from there in the posterior third of the posterior limb of the internal capsule entering into relation with the pulvinar of the optic thalamus and the corpus geniculum ext., and then spreads out obliquely backward and upward in the cortex of the occipital lobe. The most important points in relation to this nerve are the following:

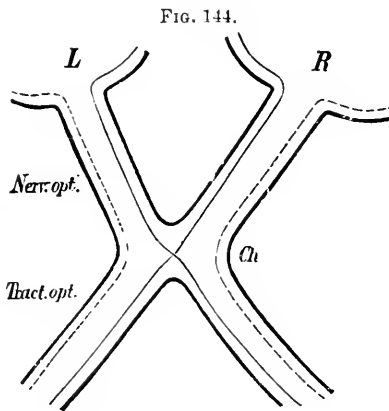

Diagram of the optic nerve-fibres in the chiasm.

1. That pathological processes at the base of the brain, and lesions in the posterior end of the inner capsule (causing a simultaneous hemianæsthesia), of the pulvinar of the optic thalamus, or of the occipital lobe, produce disturbances of vision.

2. That every complete destruction of the cortical centres in the occipital lobes, as well as of the tract from there to the chiasm, cuts off the impressions of sight from the outer half of the retina of the same side and the inner half of the opposite side, thus from synonymous halves of the two retinae. Thus, hemiopia and hemianopsia are produced (see under Eye).

(b) Hearing. The acoustic nerve passes, together with the facial,

to the oblongata, to the acoustic ganglion, in regard to which we cannot here enter into further detail. In its central course it comes into relation with the cerebrum, and then appears, probably, in the most posterior, sensitive portion of the internal capsule, whence it spreads out in the cortex of the temporal lobe (see Word-deafness).

(c) Smell. Of the olfactory nerve perhaps nothing more is to be said than that its centripetal tract seems to pass through the posterior portion of the internal capsule.

(d) Taste. The sense of taste is located [chiefly] in the glosso-pharyngeus nerve, distributed to the palate and the posterior third of the tongue, by which nerve it is conveyed to the oblongata. The course for the anterior two-thirds, however, is complicated: as the chorda tympani, it first passes in the lingual nerve, but leaves this and goes to the facial, leaves this again at the geniculate ganglion, and probably extends, as the greater superficial petrosal nerve, Vidian, and the sphenopalatine ganglion, to the trigeminus (second branch), going toward the centre with this. We again meet the fibres of taste in the posterior portion of the inner capsule.

It is very important to note the participation of the sense of taste at the anterior portion of the tongue in peripheral paralysis of the facial, and also (according to Erb and others) in disease of the trigeminus situated high up, as well as in lesions of the posterior portion of the inner capsule (hemiæsthesia).

Until we come to the symptomatology, we delay speaking of all other points regarding localization of the brain, especially regarding aphasia and the phenomena associated with it, and regarding the origin of certain forms of convulsions, of vertigo, coördination, etc.

4. REMARKS UPON THE VESSELS SUPPLYING THE BRAIN.

The brain is supplied with blood from the two internal carotids and from the vertebral artery. The right and left vertebral unite at the basilar surface of the pons to form the basilar artery; this, again, divides at a point corresponding to the anterior inferior border of the pons into the two posterior cerebral arteries, which, by the posterior communicating arteries, form a connection with the carotids (the circle of Willis). Besides the ophthalmic and the posterior communicating, the carotid gives off the anterior communicating, which, with its opposite fellow, completes the circle of Willis. There also arises from

the carotid the middle cerebral, the [largest, and] most important vessel of the brain.

Of these vessels the greatest interest attaches to those which supply the pons and medulla, and the most important part of the cortex and the internal capsule.

The pons and medulla are chiefly supplied by the basilar and vertebrals. The branches of these are terminal arteries—that is, they do not anastomose with each other, or with other branches in their neighborhood. Hence, thrombosis or emboli of such branches, or, for instance, of a part of the basilar, immediately produces arrest of function, and, besides, unless the stoppage is again removed, produces anæmic necrosis of the affected portion of the pons or medulla.

The region of next importance is that supplied by the middle cerebral artery (the artery of the fissure of Sylvius). This, as well as the regions of the cerebrum supplied by each of the two other arteries supplying portions of the cerebrum, divides distinctly into two parts, which do not anastomose with each other, into an inner and a cortical portion. The inner region, supplied by the middle cerebral artery and its branches, embraces the internal capsule, with the exception of its posterior section (sensory tract), the lenticular nucleus, the greater part of the caudate nucleus, and a part of the optic thalamus. This internal region of the middle cerebral artery (artery of the fossa of Sylvius) is sharply distinguished from the neighboring regions of the other arteries of the brain: there are no anastomoses; hence, continuous occlusion of this vessel at its root must inevitably result in softening of the above-named central portion of the brain. The cortical region of the middle cerebral artery extends over the third frontal convolution, the anterior central convolution (with the exception of the upper portion, which belongs to the anterior cerebral artery), the posterior central convolution, the superior and inferior parietal lobes, the whole region in the neighborhood of the fissure of Sylvius, lastly, the second and third temporal convolutions. This cortical portion of the artery of the fossa of Sylvius seems to anastomose, in individual instances, with the neighboring cortical regions in a great variety of ways; for this reason, occlusion of the artery in only a part of the cases results in softening of this cortical portion of the brain.

The optic centre of the occipital lobe, the corpora quadrigemina,

and the posterior portion of the internal capsule are supplied by the posterior cerebral artery.

The prominence of the middle cerebral artery consists not only in the fact that it supplies the most important portion of the cerebrum, but also because it is within this region that both hemorrhages and emboli most frequently occur. These two disturbances chiefly affect the internal region of the artery—the hemorrhages, probably, because the pressure is highest in the branches that go directly off from its root, or that here is felt most strongly the rapid changes in the power of the heart; but emboli much more frequently disturb the inner territory than the cortical, because, as was mentioned before, there are no anastomoses in the former region, while in the cortical there are. In the relation of the left carotid to the aorta (going off at a very acute angle) seems to lie the explanation as to why emboli are much more frequent in the left middle cerebral artery than in the right.

SYMPTOMATOLOGY AND METHODS OF EXAMINATION.

EXAMINATION OF THE SEAT OF DISEASE.

We learn from the physiological properties of the nervous system that when affected by disease there is little or nothing to be seen at the seat of the disease, while the symptoms are manifest at other portions of the body often quite distant from it. Besides, the brain and spinal cord are almost entirely removed from the possibility of being examined, on account of their bony casements. Lastly, very often a local disease of the nervous system, although it causes pronounced phenomena, is locally very indistinct. For all these reasons, the local examination of the nervous system, in a number of its diseases, is quite subordinate. Still, we place its consideration first, because in a systematic examination it belongs there, and because the expression of our opinion cannot at all affect the value which it, nevertheless, in many respects possesses.

The Skull.—The majority of the diseases of the brain and its coverings run their course without any manifest effect upon the skull; indeed, there is no disease of that organ in which it may not more or less frequently happen that alterations in the skull were entirely wanting. If there are such alterations in a portion of the cases,

they are secondary in their nature, dependent upon disease on the inner surface: in other, more rare cases, the alterations of the skull are the cause of the disease of the brain.

As methods of examination, we mention inspection, palpation, and measuring or tracing the shape of the cranium upon paper.

The Size of the Cranium.—Generally this is determined by the circumference of the head over the glabella and the occipital protuberance, and by estimating the relation between the brain-case proper and the face. This latter can be measured simply by the eye. In the newly born the circumference of the head is 39 to 40 cm. (according to others somewhat less). In the course of the first year it increases to about 45 cm., and from then to the beginning of the twelfth year to 50 cm.; in adults it amounts to about 55 cm. (in women it is generally somewhat less than in men).

Marked enlargement of the cranium, macrocephalus (to 80 cm. and more in circumference), occurs with hydrocephalus, if the fontanelles have not yet closed. Then the frontal bones particularly project; the countenance is proportionally too small, the eyes are directed downward, the expression is often peculiarly staring; the fontanelles are very large and remain open for a long time; the cranial bones are thin. Hydrocephalus which occurs later, when the skull has already closed, causes little or no enlargement of the head.

Moreover, a somewhat considerable macrocephalus is peculiar to the rachitic skull, and is here dependent upon thickening of the bones of the skull. But it is generally somewhat angular (*caput quadratum*). There is no notable recession of the bones of the face as in the former; the bones give the impression of being dense, only the occipital bone is sometimes very thin, even as paper, sometimes upon pressure crackling like parchment (be careful!). Here, too, the fontanelles remain open abnormally long—sometimes into the third year. The distinction from hydrocephalus is made in the first place by an examination of the nervous system, which in this disease is almost always injuriously affected (as respects its psychic, intellectual, and motor functions), while in rachitis it is normal; also the evidences of rachitis are to be sought at other points (the inferior maxilla, the thorax, the bones of the extremities). Moreover, we may have a combination of hydrocephalus and rachitic thickening of the cranium.

Abnormally small skull, microcephalus, is naturally connected with abnormally small brain, thus necessarily with idiocy (see).

Form of the Skull.—Departures from the typical form. Here belong dolichocephalus, brachycephalus, and other forms of head which are often met with without any pathological condition of the brain, but also in congenital malformation of the brain, as in idiots. Asymmetry of the skull likewise occurs with this condition, but also not infrequently with persons who are perfectly healthy and intelligent. We discover the asymmetry of the skull by viewing it from above or by tracing it upon paper: measuring the sagittal and the large transverse diameters of the cranium with the calipers, and making an outline with a strip of lead as was described upon page 163, in the examination of the form of the thorax.

Circumscribed projections and depressions have much greater pathological significance, the latter, however, very frequently not with reference to disease of the brain but as signs of a general disease. Projections occur in disease of the cranial walls and of the dura mater,¹ and these are chiefly syphilitic gummata, carcinoma, and sarcoma. Sinking-in, depressions, impressions, may be traumatic. If there is defect of the bony wall the defect may feel like a fontanelle. Soft and slightly depressed [or depressible] round spots are sometimes present in carcinoma of the cranial vault. Very important, lastly, are scar-like, round depressions over which the scalp is adherent, and which often contain an actual scar: these occur as the result of healed syphilitic gummata or deep ulcerations. All these appearances, but especially the traumatic and syphilitic depressions, are of the greatest diagnostic importance. When the skull is thickly covered with hair they may be easily overlooked, if we do not examine it with the greatest care by feeling all points.

In making the examination of the cranium, it is of the greatest importance that we should have a clear conception of the location of the brain and its different parts with reference to its bony casement. We cannot here go into particulars, but attention is called to Fig. 145, from which we especially learn the relation of the so-called motor cortical regions of the temporal and occipital lobes to the cranium.

¹ The knowledge and significance of tumors of the cranium caused by meningocele and cephalocele are taught in works upon surgery.

The most important point is that the motor cortical region lies just in front of a vertical line drawn through the external orifice of the auditory canal.

FIG. 145.

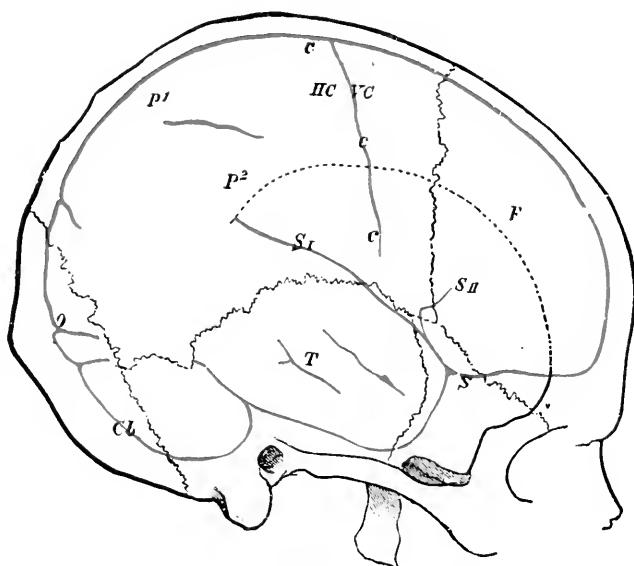

Explanation of the topographical relation between the surface of the brain and the skull. *c*, fissure of Rolando; *HIC* and *VC*, posterior and anterior central convolution; *S, S, S*, fovea of Sylvius; *P, P*, upper and lower parietal lobes; *O*, occipital lobe; *Cb*, cerebellum; *T*, temporal lobe; *F*, Frontal lobe. (STRUMPELL FROM ECKER.)

Sensibility of the Cranium to Pressure.—This is ascertained by pressure with the finger or by gentle stroke with the tip of the finger or the percussion hammer. General sensibility to pressure occurs in nervousness, especially nervous pain in the head. We also sometimes meet with circumscribed sensibility to pressure in nervousness, also in hysteria; but sometimes the latter corresponds with a circumscribed meningitis, as this may be caused chiefly by tumors, abscess of the brain, etc. If there are other signs of a disease of this character present, then its topical diagnosis may be aided by palpation and percussion; by itself its results must be received with caution.

Regarding the significance of dilatation of the veins of the skull, see page 260.

Suppuration of the ear and nose (the latter seldom) plays an important part as causes of meningitis and abscess of the brain.

THE SPINAL COLUMN.

Form. The significance of the expressions scoliosis, kyphosis (lateral and posterior curvature of the spine) and kyphoscoliosis have already been referred to on page 88. Lordosis is an abnormal curvature forward. If these curvatures are obtuse-angled, none of them have a deleterious effect upon the spinal cord, or at least only exceptionally. Acute-angled kyphosis (gibbous), as is usually caused by caries of the vertebræ, also by fracture of a vertebra, is of much greater importance, [causing] compression of the cord. It is to be remarked that in order to recognize slight lateral curvature it is desirable to mark the spines of the vertebræ, without moving the skin, with a blue crayon, and then to observe carefully the line that is thus formed. Any weakness or paralysis of the muscles of the spine on one or both sides may lead to secondary curvature of the spine, especially to scoliosis and lordosis; see still further regarding this under Function of the Muscles.

Diminished mobility of the spinal column, if it occurs with respect to the whole length in persons of mature years, is often not pathological. Complete general stiffness occurs, also, in arthritis deformans. If the stiffness is limited to a certain portion, while the rest of the vertebræ have free motion, this is of pathological significance (almost always due to caries, and here we sometimes have stiffness without curvature of the spine). Forcible bending is then generally painful. The spinal column is abnormally mobile when there is weakness or paralysis of its extensor or flexor muscles in young persons. This is especially marked in juvenile muscular atrophy, often in connection with habitual curvature.

Sensitiveness of the vertebral column to pressure (especially of the spines of the vertebræ) may have a great variety of significance. There may be palpable disease, especially caries, but also tumors of the vertebræ, of the spinal meninges, spinal meningitis, or tabes; but it may likewise occur with spinal irritation (particularly in the neck and between the shoulder-blades), as well as in hysteria, and here it may be excessive. We discover this sensibility by strong pressure,

or by striking the spines of the vertebræ. Often, but by no means always, there is at the same time painful sensibility when a hot sponge or the cathode of the galvanic current is passed over it.

Here, also, belongs the rigidity of the neck in meningitis, particularly basilar—an important sign of this disease; also, the rigidity of the whole spinal column in spinal meningitis. With the former, by the contraction of the cervical extensors of the head, the latter is often bent back to a marked degree, “boring into the pillow.” Backward bending of the vertebral column—opisthotonus—likewise occurs with attacks of tetanus; with epileptic, and especially hysterical, convulsions. With the latter, as the “arc de cercle,” there are sometimes incredible distortions.

The anatomical relation of the cord to the spinal column is as follows: the cervical enlargement of the cord corresponds about with the third cervical or the first dorsal spine, the lumbar enlargement about on the level with the ninth dorsal to the first lumbar vertebral spine; the *conus terminalis* begins at the first or second lumbar vertebra.

THE PERIPHERAL NERVES AND THEIR SURROUNDINGS.

The nerves, as the seat of disease, come into consideration in all peripheral paralyses and in neuralgias (also among others, in reflex epilepsy). In order directly to examine a nerve-trunk, an exact knowledge of its course is necessary, and also of the organs that surround it, from which an injurious effect upon the nerve may proceed.

By the examination of a nerve we learn its anatomical condition: any possible symmetrical thickening, with neuritis or perineuritis, unequal thickening or tumors in the nerve, with neurofibroma, neuroma; also any possible sensibility to pressure, as occurs with neuritis along the whole length of the diseased nerve, although this may be entirely absent. Finally, here belong the sensitive points in neuralgias (see below).

Moreover, a special examination must be made of certain points, which, from any cause whatsoever, may easily be the starting-point of a disease of a peripheral nerve. These are: (*a*) those points where a nerve is especially exposed to traumatism, because it lies near the

surface of the body (especially if it at the same time lies over a bone). These situations essentially coincide, in part, with the electro-motor points to be mentioned later. Severe injuries, deep punctures, etc., of course, may destroy a nerve at any point. They are: (*b*) neighborhoods where a nerve may be exposed to injury from other organs. Here belongs compression by development of callus about the seat of fracture, especially of the bones of the extremities; also compression and sometimes inflammatory irritation from glandular tumors (axilla, neck, etc.), aneurism, hernia (crural nerve); lesion of the facial nerve caused by caries of the petrous portion [of the temporal bone], etc. Indeed, in case of lesion of a peripheral nerve we are frequently able to find the seat of the disease in this sense; but in every single case it must be looked for.

An extremely instructive case from the standpoint of diagnosis of the *locus morbi* was observed by Erb, which was reported by the author. It was a case of ulnar neuritis resulting from exposure of the ulnar nerve from the fracture of the internal condyle of the humerus. The author has recently seen a similar case: both internal condyles of the humerus projected; the sulcus ulnaris was broad and shallow. In the first case there was a unilateral, in the second a bilateral, ulnar neuritis resulting from frequent injury to the nerve at its exposed point.

EXAMINATION OF THE CONDITION OF THE MIND.

In this section, which touches upon a territory foreign to this work,—the mental state—we must, of course, limit ourselves to a brief mention of what is necessary in making a medical examination.

Mode of examination. An attentive observation of the behavior of the patient in bed, the expression of his countenance, his position, the reaction to external impressions, give many disclosures regarding the faculty of perception, and of his sensibility [or well-being]. By engaging the patient in conversation (taking the anamnesis, page 18), we are able to discover more regarding these points, and to judge of the intellectual activity: memory, imagination, possible delusions, the ability to think logically. In testing the memory, we take notice of the recollection of things that are long past, as well as of more recent events, or of what has taken place during the present illness. The

test of the power of thought and of the imagination is made by more or less simple arithmetical problems and by questions which are suitable to the social position and the occupation of the patient. We observe the great difference which various degrees of education produce in patients affected with the same disease, and we also take into consideration the age of the patient. We observe any possible diminution or increase of action, both instinctive, as the taking of food, or sexual indulgences, and of actions with conscious purpose.

This expresses in general terms the course of the examination. To be sure, we shall very frequently be obliged, in order to recognize the first traces of a mental disorder, to take into consideration whether the patient has changed in his nature or behavior. Thus, for example, if a person becomes suddenly forgetful, careless, and disorderly, this will have quite a different significance than if he had always from his youth been so. Of course, in regard to these things we must chiefly rely upon the statements of his relatives.

In what follows is given the explanation of the terms that have been adopted in the medical clinic, and the phenomena that accompany the several conditions :

Disturbances of consciousness are designated, according to their severity, as: *stupor*, also somnolence (sleepiness, lethargy, from which the patient can easily be awakened); *sopor*, in which the patient can only be awakened by decided appeals to his senses; *coma*, or complete loss of consciousness, in which the patient cannot be awakened in any way. The slightest degree of obtunded consciousness manifests itself in the scarcely noticeable trouble which it costs the patient to collect himself in order to answer a question, or by his indifference with respect to being sick—a subjective sense of well-being. Further, there is an indication given by the sensibility to pain, and the arbitrary or involuntary voidance of the stools and urine. In this respect, the sensibility to pain often does not coincide with the other manifestations of consciousness.

Disturbance of consciousness occurs: in acute infectious diseases; especially in typhoid fever (see more below), where the early manifestation of dulness has diagnostic value; but it may accompany any infectious disease, and may pass into deep coma; in acute poisoning of various kinds, especially from narcotics; as uræmic, diabetic, carcinomatous coma; as epileptic, apoplectic coma; in meningitis; in the

most varying diseases of the brain, especially in tumors of the brain and its meninges. In the different forms of meningitis, however, consciousness may be retained for a remarkably long time. In tumors of the brain there is often for a long time a slight obscuration. It occurs also in injuries and concussion of the cranium; in large hemorrhages; in all chronic cachexia at the end of life, at any rate in the last moments.

A patient who is in deep coma when he comes under the eye of the physician always causes great difficulty in diagnosis, the greatest when he can make no inquiry in regard to the patient. Systematic examination of the whole body is to be made: of the cranium for wounds; of the heart and vessels; for evidences of apoplexy, meningitis; for signs of poisoning; of the urine, which is to be drawn with the catheter (for sugar, reaction for chloride of iron, for albumin, casts; for certain poisons or as evidence of certain poisons, hæmoglobin); lastly, of the stomach by evacuation (poisons).

SPECIAL PHENOMENA OF OBTUNDED CONSCIOUSNESS.

Delirium, that is, talk and gesticulations arising from delusions. It may follow any disturbance of consciousness, but it occurs especially frequently with acute infectious diseases; with severe cachexia, often as the end of life approaches; finally, as *delirium tremens seu potatorum*, in chronic alcoholic poisoning. The latter manifests itself by talkativeness, restlessness, rapid alternations between passion and great anxiety, fear, hallucinations of sight (small black animals, especially mice, etc.), loss of sensibility to pain and cold; besides alcoholic trembling (*sec*).

The expression "muttering delirium" is used to designate a low murmuring with profound disturbance of consciousness. It is always a serious indication of great weakness and occurs particularly with typhoid fever.

Hysterical delirium forms a transition to the true psychoses, which cannot be treated here.

Spasms, vomiting, see below.

Loss of consciousness, which quickly passes off, occurs as "syncope," "dizziness." This may be very benign, as in anæmia and chlorosis, nervousness, great excitement, or severe pain. But it may have a serious significance in elderly people as precursors of apoplexy, or as slight epileptic attacks (*petit mal*); lastly, it occurs in all possible chronic diseases of the brain, but especially in progres-

sive paralysis. All of these conditions must be thought of when attacks of dizziness occur frequently in the same individual.

Dizziness, vertigo. In many respects this is to be looked upon as a slight, temporary loss of consciousness, or connected with it (see above). But it only indicates a disturbance of the sense of equilibrium and occurs as such most purely as a swimming of the eyes in diplopia (see Eyes) from deception regarding the location of objects in space and regarding the level of the floor. It also occurs in affections of the ear (*vertigo ab aure læsa*); in tumors of the brain, especially of the vermiform process of the cerebellum; in multiple sclerosis; with diseases of the stomach (*vertigo a stomacho læso*); in anæmia, and in cerebral neurasthenia.

Pathological depreciation of the power of the mind to perform its functions is designated as *imbecility*. It occurs in all gradations from moderate diminution in the perceptive faculties, to a complete animal condition. Congenital imbecility is designated *idiocy*, when accompanied with certain physical manifestations as *cretinism*. As an acquired condition it occurs as dementia senilis, also in organic diseases of the brain, especially tumors, apoplexy, multiple sclerosis; but also, as a temporary condition in convalescence from severe diseases, there is a slight imbecility. Imbecility with delusions of greatness is a tolerably characteristic sign of progressive paralysis.

Of disturbances of volitional impulses are to be mentioned: *abulia* (hypochondria, drunkenness, indulgence in morphia); loss of desire for food: *anorexia*; certain forms of pathological excesses: *boulimia* (a morbidly great and unnatural appetite for eating all sorts of things), *nymphomania* and *satyriasis* (abnormal sexual desires).

DISTURBANCES OF SENSIBILITY.

1. SENSITIVENESS TO PERIPHERAL IRRITATION.

The determination of the sensibility which a patient has for irritations applied from the periphery (by the physician) is made difficult by the fact that the estimation of them must rest with the patient, who is the subject of the experiment. Subjective sensibility, especially to pain, without doubt varies with individuals: with "torpid" persons

and with the aged it is depreciated. Moreover, in a varying degree, it is diminished with persons who are unconscious to the point of entire loss of sensation. Further, it will be influenced, when the irritation is slight, by the attentiveness of the person examined. The report of what is discovered in such examinations depends wholly upon the sincerity and good-will of the patient. We must always think of the possibility of simulation and concealment, and the absence of favorable intention.

Very little weight must be given to the statements of the patient as to his capacity to feel. The most brief examination is best, as securing the most exact answers, for we very often meet with erroneous conceptions of the condition of the sensibility of the skin.

Whenever we are testing the sensibility, it is advisable to prevent the patient from seeing what we are doing. If the disease is unilateral, it is desirable to make use of this circumstance to compare the diseased with the healthy side. How we are to guard against deception by simulation, see below.

Finally, it is most emphatically recommended that the individual should employ the utmost similarity possible in the methods of making his examinations; for only in this way is it possible constantly to sharpen his own judgment. Moreover, every record of an examination should contain a statement of how the result was obtained.

Passing over the higher senses, the sensibility to peripheral irritation is divided into (a) cutaneous sensibility, (b) the so-called deep sensibility.

(a) *Cutaneous Sensibility.*

This again is divided into a number of qualities whose relation to each other and distinction one from the other is not yet entirely clear. We avoid any discussion of disputed points, and treat the qualities from the stand-point of clinical interest.

1. *The sense of touch*, sensibility to contact. We test this by gently touching the skin with the tip of the finger, the patient keeping his eyes closed, and whenever he feels the touch saying "now"; it is better if he will also say "on the hand," or on the given finger, etc. Thus we approximately test the sense of locality (see below). And it is also recommended, in order to shorten the examination, to test the

latter immediately more exactly by having the patient designate with the tip of the finger the spot that is touched. If he is able to do this then his sense of touch and of locality is normal; if he cannot, there may be several reasons for his inability, as disturbance of the sense of touch and of locality, sometimes of the muscular sense (see below). Then we must endeavor to separate the sense of touch from the sense of locality.

In many cases of slight disturbance the patient is able to feel the contact, but it is duller and different from what it is in normal places. Then we often obtain more exact information if we touch him with rough and soft materials, and the like. In other cases this procedure is unnecessary.

2. *The local sense*, the power of localization, is tested by having the patient tell exactly where he has been touched. A healthy person can tell this with different degrees of accuracy, according to the portion of the body which is touched. This about corresponds with the distances on the body which the related sense of space has been found to give. (See below.)

Testing the sense of space (only required when from any reasons the sensibility must be tested with the greatest exactness) is best done with Sieveking's æsthesiometer: by means of two sliding points we are able to measure the shortest distance at which the two points can be recognized as two separate objects. In health the minimal distance, on the average, is as follows:

At the tip of the finger	2.5 to 5 mm.
In the palm of the hand	8 to 12 "
On the back of the hand	31 "
The forearm and the leg	about 40 "
The back	40 to 70 "
The upper arm and thigh	about 75 "

Analogous, although in its results not wholly corresponding to those of the above-mentioned method, is that of testing the sensation of movements (Leube): it relates to the power to distinguish points and the shortest lines that can be drawn upon the skin.

3. *The sense of pressure* residing in the skin is tested by the ability of the patient to determine the smallest differences between weights

placed upon the skin. The limb must lie firmly, so that the muscular sense (see) is excluded. It is best to take blocks of wood of the same size (instead of metal), but made of different weight by being loaded with lead. The healthy person perceives differences of weight which are equal to about $\frac{1}{20}$ to $\frac{1}{30}$ of the absolute weight of the bodies employed. Partial paralysis of the sense of pressure is frequently observed, especially in tabes.

4. *The sense of warmth and cold.* This is most quickly and simply tested by breathing and blowing upon the skin. Healthy persons distinguish the first from the second perfectly well. This method, however, is entirely unsatisfactory, because the finer disturbances of the sense of cold and heat are not revealed by it. Somewhat more exact is the test made by means of two test-tubes filled with water at different temperatures. We must select a difference of temperature which we ourselves distinctly recognize, as, for instance, by passing the hand over them. If, with one of these methods, we find a disturbance of one of the two temperature-senses, then we can more exactly determine the degree of this disturbance by employing temperatures which vary still more; hence, very low or very high (ice, hot water). At the same time we can thus determine the temperature at which cold- or heat-pain begins.

A finer test of the sense of heat is made by the aid of the thermæsthesiometer. We recommend Nothnagel's—two cylindrical wooden vessels, with metal bottoms, into each of which is dipped a thermometer to test the temperature of the water that is poured into them. In a very imperfect way we may make a substitute for this thermæsthesiometer by using two reagent glasses half filled with water. In these are placed thermometers surrounded by pledgets of wadding. The temperature of the glasses is varied by dipping them into vessels of cold or hot water. The thermæsthesiometer enables us to determine exactly the fineness of the sensibility to heat and cold. The normal fineness of the sensibility to heat differs with the absolute height of the temperature which we select. The temperatures between 27° C. and 33° C. are most delicately distinguished. Here the recognizable differences in health average 0.5° C., except over the legs, where the number may be somewhat larger, and on the back, where it is about 1° C. On the cheeks it is about 0.25° C.

5. *Sensibility to pain.*¹ We recommend to test exclusively by pinching a fold of skin between two fingers, because in this way, with

FIG. 146.

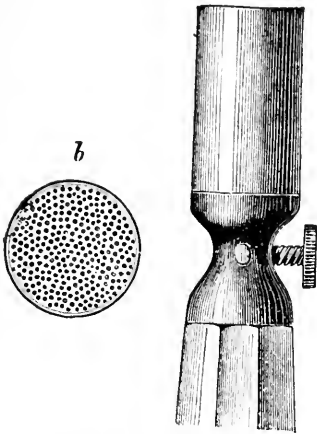

Erb's electrode for testing the sensibility of the skin. *a*, tube of hard rubber; *b*, free surface of the electrode. (ERB.)

some practice—it depends very much upon the size of the fold of skin that is taken, and it is recommended always to press the rounded portion of the skin—we can best attain some uniformity in regard to the amount of irritation employed each time. (Regarding pain caused by faradization, see below.) With patients who are unconscious it very often happens that the sensibility to pain is the only quality of sensation that is accessible to examination. When there is very decided unconsciousness we are made aware of it by the possible distortion of the countenance on account of pain or even a withdrawing of an extremity (not to be confounded with reflex of the skin, see below).

6. *Electric sensibility.* By the galvanic as well as the faradic current we can develop an objectively-visible as well as subjectively-painful sensibility of the skin. We confine ourselves to the description of the farado-cutaneous sensibility.

It is best obtained by employing Erb's electrode for testing farado-cutaneous sensibility (made by Stöhrer, in Leipzig), which is a cable of insulated copper wires cut at right angles with its axis. We mount this electrode upon the cathode of the opening current of a Dubois's induction-coil (the other electrode may stand anywhere upon the body), and notice the distance of rotation when the point of the skin under examination becomes sensitive (minimum of sensation), and also where it stands when pain is produced. Then, besides, we are to test the galvanic resistance at each point tested (see under Electrical Examination for Motility), in order to have an approximate guide as to how strong a current, furnished by Dubois's apparatus, is

¹ Corresponding with the mode of procedure in making an examination, this is included here, although it properly belongs with common sensation (which see).

exhausted by the resistance of the body (or of the skin) at the individual points; hence, how much of it is used up each time in producing the irritation of the skin. The following table gives the average figures of health as found by Erb, but we remark that the figures change according to the strength and construction of the induction apparatus employed, and also that the deviation of the needle (for testing the galvanic resistance) was attached to an old galvanometer without absolute divisions. For both of these reasons the relation of the figures from each other, rather than the absolute variation of the needle indicated by them, is of value :

Points of resistance.	Minimum.	Pain.	Deviation of the needle with 8 elements; conduction resistance 150.
Cheeks	200-220	130	26°
Neck	180-200	120	22°
Upper arm	200	120	21°
Forearm	190	115	18°
Back of the hand	175	110	15°
Tip of the finger	125	90	2°
Abdomen	190	120	20°
Thigh	180	115	21°
Lower leg	170	110	19°
Back of the foot	175	110	10°
Sole of the foot	110	80	5°

The method is further liable to error, regarding which we cannot speak here.

Farado-cutaneous sensibility does not go entirely parallel with any other quality of sensibility. Most frequently, but not always, the sensations of pain produced by pinching, and the minimal sensations of pain produced by the faradic current, correspond with each other (this is especially the case in tabes). The method has not yet been sufficiently studied to be of independent diagnostic significance, and particularly to have a value for special diagnosis. Its application is chiefly to be recommended in unilateral slight disturbance of sensibility, from the possibility of making a comparison with the sound side, which cannot be quite certainly established when there is normal irritability of the skin. (Regarding stereognosis, see p. 481.)

Now, if by testing the sensibility we find it diminished, we speak of *hypæsthesia*, often incorrectly spoken of as anæsthesia. If none is found—that is, if the strong or maximal irritation employed, which

is always to be stated as accurately as possible, meets with no response—then we speak of loss of sensibility, or anæsthesia. Heightened sensibility is *hyperæsthesia*, or sensibility to variations of temperature and to pain. In many cases, especially in diseases of the peripheral nerves, the sensibility is equally altered in all its qualities; in others, and especially in diseases of the spinal cord, in cerebral anæsthesia, and not infrequently in hysteria, there exists a partial paralysis of sensibility. Of this, the most frequent form is the diminution or absence of sensibility to pain—analgesia.

When sensibility is slowly conducted (“*delayed sensibility*”), it is recognized by requiring the patient, with his eyes closed, to call out “now” the instant he has a sensation. Sometimes, the pause can be measured by seconds (ten seconds, and more). This phenomenon is most frequently observed with reference to pain, as in tabes and in peripheral paralysis. If we take hold of the skin, to pinch it, the patient will often call out “now” twice, because he felt the touch, and then, later, the pinch: there is double sensibility. For this reason, it is best to take up the skin first, without pressing it, and then suddenly to pinch it.

Gradual increase of the sensibility to pain, when inflicted, so that just at the moment of being pinched it is inconsiderable, and, later, the pain increases markedly, appears by its phenomena and occurrence to be related to delayed communication of the pain.

Perverse sensibility to changes of temperature (Strümpell) consists in cold being experienced as heat. According to our recent views of the complete opposition of the sensibility to heat and the sensibility to cold, this disturbance is not, as yet, explicable. Yet it has an analogy in those rare anomalies of sensibility where a gentle touch is felt as cold.

After-sensibility (Naunyn) is a term used to describe a pain that, when first inflicted, immediately subsides, but for some time after returns, and, indeed, with increase of intensity.

Polyæsthesia (Fischer): when one point of the æsthesiometer is placed upon the surface, it feels as if there were two.

Allochiria (Obersteiner): when the right extremity is touched, it is referred to the left, and *vice versâ*, as in tabes, myelitis, hysteria, multiple sclerosis.

Local manifestations of disturbed sensibility. Of course, these

are to be determined as accurately as possible. This is very easily done when the disturbance of sensibility is sharply bounded; however, not infrequently the region of disturbed sensibility of the skin passes very gradually and indistinctly into the normal portion. Total anæsthesia is a curiosity. Unilateral anæsthesia, or *hemianæsthesia*, not passing beyond the middle line of the body, sometimes affecting the head, trunk, and extremities (including the mucous membrane), in a similar way, occurs with certain deposits in the internal capsule (in the posterior third of its posterior limb), and in hysteria. In the latter, and (it is said) also in the first case, there is simultaneously exact unilateral disturbance of all the higher senses. *Para-anæsthesia* is anæsthesia of both lower or both upper limbs. A zone of disturbed sensibility, a territory of any extent, may exist in all imaginable parts of the body. If it is small, it may easily be overlooked, unless the search for it is very carefully made; this is particularly apt to be the case in the extremities. Here, especially (but also on the trunk), we must carefully determine whether the anæsthesia corresponds with the region of distribution of a cutaneous nerve or of a mixed nerve-trunk (see p. 484), or whether it is not confined to such a territory—that is, “diffuse” or “washed out.” In the first case it would indicate an isolated disease of that particular nerve. Anæsthesia (analgesia) affecting an extremity which is limited to the portion distributed about a joint (say, as far as the wrist, or up as far as the elbow-joint, etc.), has been met with in certain functional neuroses, especially of the so-called hysterotraumatic neuroses of the French.

It may happen—indeed, it very frequently does—that an anæsthetic territory does not really comprise the limits of a nerve of the extremities, but the inner half of it is wanting. Thus, in a radial paralysis, there may be an anæsthetic zone (easily overlooked) confined to a small part of the dorsal side of the forearm. This results, either because the nerve is not interrupted throughout its whole transverse section, or because we have that very puzzling phenomenon, the “vicarious” participation of a neighboring nerve.

(b) *Deep Sensibility.*

This is divided into the less important categories of the dynamic sense, the sensation of spasm of the muscles, and the important

so-called muscular sense, which is a generic name for a series of sensations.

Dynamic sense is the capacity to recognize the weight or the difference of weight between different bodies which one lifts. It may be exactly tested only with the upper extremities, and even here it is not wholly separable from the pressure-sense of the skin. Different weights are placed in a cloth-sling pulled over the hand on to the wrist. A healthy person will recognize differences of one-tenth.

Sensation of spasm is the unpleasant sensation or pain which is experienced in very strong contraction of the muscles, as in cramp in the calf of the leg, or strong faradic muscular stimulus with anæsthesia of the skin.

Muscular sense. By this we understand the ability to recognize, with the eyes closed, the position a limb is in (conception of location), and the active and passive motions of a limb. It is due to the sensibility of the muscles, joints, and their ligaments, by the feeling of varying tension of the skin in flexion and extension of a joint, by the impressions of touch which come from portions of skin being in contact, as in the axilla and elsewhere. We test the sensation of location and of motion in the arm (with the eyes closed), in persons with unilateral disease very simply: we place the diseased arm in different positions, and have the patient with the sound hand take hold of the wrist of the diseased arm. The same method may be employed in unilateral disease of the leg. Besides, it is well, when there is disease of the legs and bilateral affection of the arms, to have the patient describe the positions in which they are placed or the passive motions of the joint that are made. We can also have the patient describe and represent numbers in the air with his hands.

Romberg's symptom. The patient places his feet close together, and as soon as he closes his eyes he begins to reel, sometimes he may fall down. The phenomenon is dependent upon anæsthesia of the soles of the feet and disturbance of the muscular sense of the legs, which is no doubt increased by the existing ataxia (which see), because in this condition the motions to correct the swinging are too violent; this is especially characteristic of tabes dorsalis. [But something of this symptom may be present in health, owing to the lack of vision to correct incipient lateral movements. This may be made clear by closing the eyes and then attempting to stand on one foot.]

A finer test of the muscular sense may be made by placing before the patient a table with numbered squares like a chess-board, each square measuring about 10 cm. on a side, and having him point them out with the eyes open until he has them all in his head, and then with closed eyes to touch them with the hand; or, on the other hand, the patient moves his hand about the squares and names the fields as he comes to them. With the legs, the same test may be made with cubes measuring 10 cm. on a side, placed one on top of another and then side by side. This test, however, requires a certain degree of intelligence on the part of the patient.

Conception of space ("finding one's position in space") can be tested by placing substances of different thicknesses between his thumb and forefinger to ascertain the smallest perceptible differences of thickness.

In testing the conceptions of active motions, we see that it is very much disturbed in paralysis, ataxia, and chorea; regarding these, see below.

The Knowledge of Form (Stereognosis).

We recognize the form of bodies partly by the sensibility of the skin and partly by deep sensibility. The former is employed more for very small bodies (which we are able to grasp with the hand; here, indeed, the hand is the chief means), the latter more for large substances. Thus far only the recognition of small bodies has been sought, especially in an exact way by Hoffmann.

To make this test he selected a ball, half-ball, segment of a ball, a cone, a three-cornered pyramid, a regular octahedron, and a dodecahedron—all of a size for the hand to grasp. He chiefly tested the hand of persons in health and sick people as regards their ability to recognize these bodies (to which popular names were given).

Hoffmann and others have found that the recognition of small bodies was principally made by the skin and sense of space and of pressure of the skin, and to a less degree by the sense of motion in the joints and the power of determining the location in space. Also, that the active to-and-fro motion of the body in the hand, for a different reason, comes into consideration: if the active motion is wanting, then the stereognosis is hindered, but not abolished.

Formerly the examination of stereognosis did not have an inde-

pendent value; testing the separate qualities of sensation is superior to it. According to our experience, the most important result of Hoffmann's examination is the knowledge that the separate factors of stereognosis may very perfectly act one for another when there are pathological disturbances.

2. SENSIBLE PHENOMENA OF IRRITATION AND PAIN FROM PRESSURE UPON NERVES.

1. *Paræsthesia.*

This occurs as a subjective sensation of touch, like fur, creeping of ants, creeping of insects, falling asleep; also as a subjective sensation of pain, as a fine stinging or pricking, and also a severe pain; lastly, as a subjective sensation of cold and heat or painful burning.

The so-called feeling of constriction, which occurs most frequently upon the trunk in the region of the thoracic vertebra, especially in tabes, but also in local disease of the spinal cord and its meninges, belongs here. Generally it is a sensation of tension, but it also occurs in all stages of transition to genuine neuralgic pains, when it is deeply located (see Neuralgia).

2. *Spontaneous Pain.*

Headache (cephalalgia). This, according to the manner of its occurrence as well as its significance, may be extremely varied in its character. Its chief forms are:

(a) Headache produced by palpable disease of the meninges in the different forms of meningitis; in all those diseases of the cranium and the brain which accompany meningitis. If the affection is circumscribed, the headache may likewise be so, and it then sometimes indicates the location of the disease; but, also, often enough in this case it is not located.

Related with this are the nocturnal headaches of syphilis.

(b) The headache of neurasthenia is quite various in its onset. Sometimes it appears as a painful pressure in the head, sometimes as extremely severe pain; again it is diffuse, then localized, especially at the crown of the head. There is the hysterical headache, not infrequently circumscribed at the crown (*clavus hystericus*).

(c) *Migraine.* This is generally an unilateral headache occurring with pauses of extremely varied duration, with disturbances of the stomach, scintillations (see the eye), tinnitus aurium, dilatation or contraction of the pupil of the affected side, accompanied with other pains. The condition is idiopathic or symptomatic, especially in tabes, tumors of the brain, also sometimes in diseases of the nose, etc.

(d) *Neuralgia in the head,* see below.

(e) *Toxic headache* occurs particularly in chronic poisoning with lead, mercury, alcohol, nicotine. Here, also, belongs the headache of uræmia.

(f) There is a headache which occurs in the beginning and during the course of acute infectious diseases, especially intense and long continued in typhoid fever.

(g) *Anæmic headache;* headache with gastric dyspepsia; abdominal diseases of all kinds, especially diseases of the female sexual organs.

(h) The so-called habitual headache. Often there is an hereditary disposition to headache, which occurs with exertion, excitement, bodily disturbance, as catching cold, etc., and the disposition generally lasts during the greater part of one's life.

Pain in the spine may concern the vertebræ, as in chronic rheumatism, arthritis deformans, caries; the spinal muscles, as in muscular rheumatism; the spinal cord or its meninges, especially in meningitis and in tabes with tumors. But it occurs very frequently, and is especially torturing, in neurasthenia and spinal irritation. (See, also, what was previously said regarding the vertebræ.)

Neuralgia. This is generally a severe paroxysmal pain occurring in the region of one or more distinct nerves. It may be idiopathic or result from catching cold, but it may also be symptomatic, with the greatest variety of significance. The principal varieties of neuralgia are those produced by mechanical irritation (pressure of a tumor, aneurism, periostitis, etc.); sequela of inflammation of the affected nerve; neuralgia dependent upon infectious or toxic influences (malaria, syphilis, lead, mercury, nicotine, etc.); or accompanying constitutional diseases, as diabetes, gout, phthisis. In every neuralgia, we are to keep in mind the whole course of the affected nerve, and consider where and how it may be injured, and how such a local injury may directly or indirectly be discovered.

Of special importance are the neuralgic, lightning, lancinating

pains, in the initial stage of tabes dorsalis. They occur very much more frequently in the lower extremities and the trunk in the region of the intercostal nerves, and nowadays are not infrequently confounded with rheumatism. Also in the beginning of multiple neuritis there are neuralgic pains, although generally of moderate intensity.

We have previously mentioned the pain produced by pressure upon the head and upon the vertebræ. The peripheral nerve are sensitive to pressure in neuritis whenever this is accompanied by actual inflammatory phenomena in the nerve, or there is perineuritis. Very frequently there is especially pronounced tenderness of the nerve during an attack of neuralgia, but also often, although to a slighter degree, in the intervals. This tenderness is very great at certain points of the nerves, especially where the nerve can be pressed against the bone (Valleix's points) [points douloureux].

Tenderness and spontaneous pain in the joints, without anatomical changes, and generally very changeable in severity, are characteristic of articular neuralgia.

3. DISTRIBUTION OF THE SENSORY CUTANEOUS NERVES.

It is recommended that the accompanying figures [Figs. 147 and 148] be studied, in connection with which we will draw attention to a few points which seem to us to be especially important.

1. *The nerves of the head.* It is to be noticed that the nerve V_1 also supplies the conjunctiva and a portion of the mucous membrane of the nose; further, that when it is paralyzed, we observe severe inflammation and ulceration of the eye (ophthalmia neuroparalytica), which, until recently, were regarded by most persons as arising from lesions, as by dust, etc., which were not warded off because they had not been seen. The author inclines to the old view that the disturbance of nutrition forms the starting-point of the trouble. Nerve V_2 supplies the mucous membrane of the superior maxilla, a part of the gums and of the nose, the upper teeth, and the chorda [tympani]; hence sometimes there is disturbance of the taste at the anterior portion [two-thirds] of the tongue. Nerve V_3 supplies a portion of the tongue and the mucous membrane of the cheek, and presides over the secretion of saliva. It contains motor fibres, of which the most im-

portant are those distributed to the muscles of mastication (masseter, temporalis, pterygoideus ext. et int.)

2. *Nerves of the neck and trunk.* These do not require any further explanation.

3. *Nerves of the shoulder, arm, and hand.* Here we are especially to note the smallness of the cutaneous filaments of the radial nerve that supply the dorsal side of the forearm. Anaesthesia here may

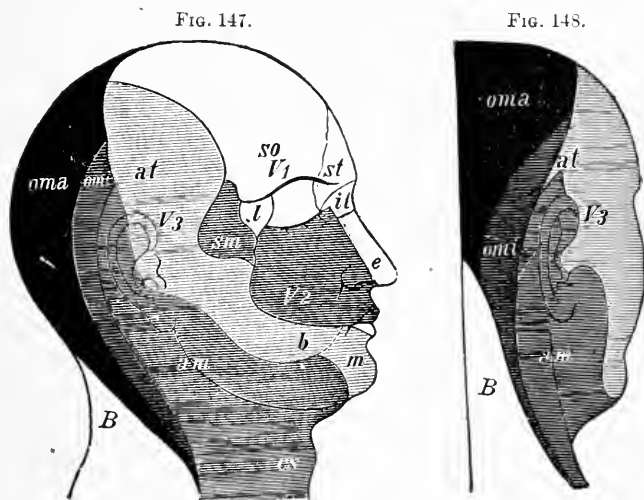

Figs. 147 and 148. Distribution of the cutaneous sensitive nerves upon the head (SEELIGMUELLER). *oma, omi*, N. occipit. maj. and minor (from the N. cervic. II. and III.); *am*, N. auricular. magn. (from N. cervic. III.); *cs*, N. cervical, superfic. (from N. cervic. III.); V_1 , first branch of the fifth (*so*, N. supraorbit.; *st* N., supratrochl.; *il*, N. infratrochl.; *e*, N. ethmoid; *l*, N. lachrymal); V_2 , second branch of the fifth (*sm*, N. subcutan. malæ seu zygomaticus); V_3 , third branch of fifth (*at*, N. auriculo-tempor.; *b*, N. buccinator.; *m*, N. mental); *B*, posterior branches of the cervical nerves.

easily be overlooked. It is to be remarked, also, that the distribution of the cutaneous nerves to the fingers, and also to the hand, is subject to some changes, so that slight variations from the arrangement usually described ought not to lead to mistake. Lastly, very often on examination of a peripheral paralysis it is found that the extension of the sensory disturbance lags behind that of the motor. The phenomenon is largely explained by a vicarious participation of neighboring cutaneous nerves in a portion of the territory affected (not-

FIG. 149.

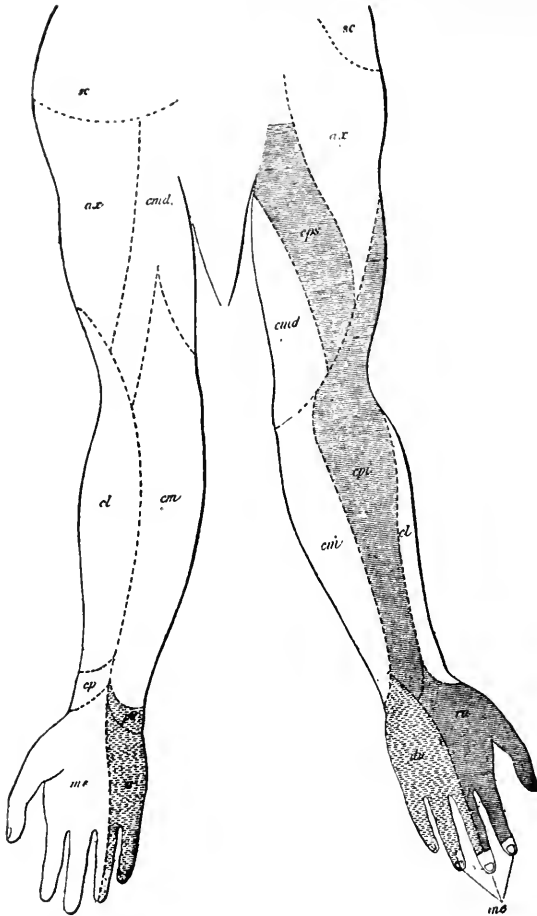

Distribution of the cutaneous nerves to the shoulder, arm, and hand (HENLE). The region of the *N. radialis* is represented by the unbroken hatched line, that of the *N. ulnaris* by the broken hatched lines. *a*, anterior, *b*, posterior surface; *sc*, *Nn.* supra-scapular (plexus cervicalis); *ar*, chief branch of *N. axillar*; *eps*, *cpi*, *Nn.* cutanei post. sup. and inf. (from *N. radialis*); *ra*, terminal branches of *N. radialis*; *em*, *cl*, *Nn.* cutanei medius (also to the plexus) and lateralis (chiefly to the *N. medianus*); *cp*, *N.* cutan. palmar., *N. rad.*; *cml*, *N.* cutan. medialis; *mc*, *N.* medianus; *u*, *N.* ulnaris; *epu*, *N.* cutan. palm. ulnaris.

withstanding the many investigations regarding its existence, this idea of vicarious action has not yet been as clearly explained as is desirable).

FIG. 150.

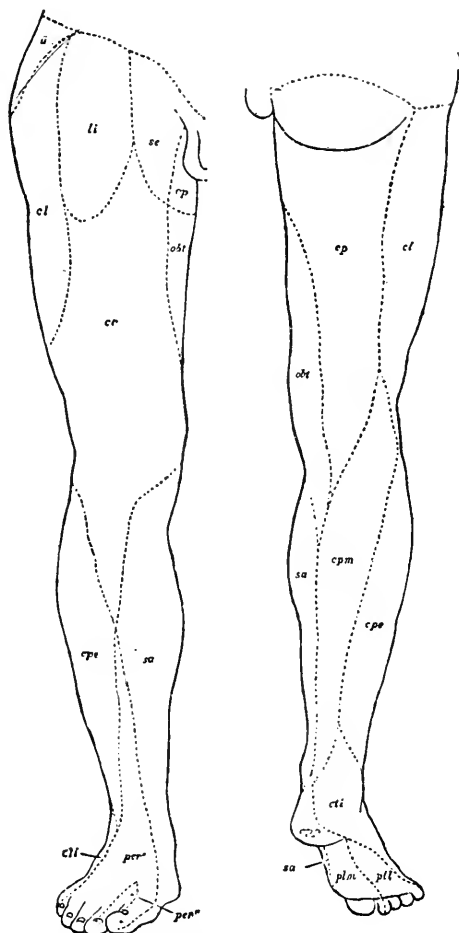

Distribution of the cutaneous nerves of the lower extremity. (HENLE.) *ii*, N. ileo-inguinal (plex. lomb.); *li*, N. lumbo-inguinal (to the genito-crural. plex. lumbal.); *se*, N. spermat. ext. (to the genito-crural.); *cp*, N. cutan. post. (plex. ischiad.); *cl*, N. cutan. lateral. (plex. lomb.); *cr*, N. cruralis (plex. lumbal.); *obt*, N. obturator. (plex. lomb.); *sa*, N. saphen. (plex. lumbal.); *cpc*, N. commun. peron. (N. peron. tibial.); *cti*, N. commun. tibial.; *per'*, *per''*, N. peronæi ram. superfic. et prof.; *cpm*, N. cutan. post. med. (plex. ischiad.); *cpp*, N. cut. plant. propr. (N. tib.); *plm*, *pll*, N. plantar. medial. et lateral. (N. tib.).

Paralysis of the brachial plexus at Erb's point (see Electrical Examination) sometimes causes anæsthesia in the region of the median nerve. Paralysis from compression of the radial [musculo-spiral] at

the point where it passes around [the humerus] causes sensory disturbance only at the hand (see Electrical Examination), because the posterior cutaneous nerves [internal, supplying the posterior and internal aspects of the arm as far as the elbow; and external, arising from the nerve on the outer border of the arm, is distributed to the back of the forearm] are given off above the point of circumflexion. On the other hand, compression of the radial in the axilla (crutch-paralysis) often causes anaesthesia of the forearm.

4. *Nerves of the lower extremities.* (See the accompanying figure—Fig. 150.)

DISTURBANCES OF MOTILITY.

In this connection we consider not alone the disturbances of muscular action in the strict sense, but also the manifestations as respects *tonus* and the nutrition of the muscles, the coördination of their actions, their electrical and mechanical irritability, and their reflex manifestations.

1. PARALYSIS.

By paralysis of a voluntary muscle, we understand a condition in which, by the action of the will, it can only to a diminished extent, or cannot at all, be made to contract. If there is complete absence of voluntary contraction, we call the condition *paralysis*; if the power of voluntary contraction is only diminished, it is called *paresis*. Paralysis is the result of some anomaly of the muscular nervous system or of its motor terminal apparatus.

The loss of motion due to stiffness of the joint has nothing to do with paralysis. Such inability to move a joint is especially frequent in the extremities, and may lead the inexperienced into error. If there is simultaneous stiffness of the joint and paralysis, it may be extremely difficult to determine the existence of the latter. Diminution of power of motion caused by pain has nothing to do with paralysis when there is only a want of self-control on the part of the patient. However, very severe pain may cause a local restriction of movement, which is, in fact, to be considered as a paralysis.

Phenomena of paralysis; methods of examination. Paralysis is recognized by the complete absence of the power of motion in the sense of action of the affected muscles, and, as regards the muscle

itself, by the absence of contraction that can be seen or felt. An extensive paralysis, if it causes the muscles to be lax (see below), produces a characteristic atonic behavior of the affected limb: if we take it up and then let go, it falls down—an important symptom of loss of consciousness. As regards those muscles, and there are many such, whose failure does not in a very noticeable degree affect the motion of a limb, because their actions are replaced by others, we recognize the paralysis by observing and feeling the muscles during active movements of the joint which would likely call them into action; among such belongs the supinator longus. Paresis is recognized by the diminution of “native vigor” when resistance is called for; and also, supposing the joint to be free and an absence of tension on the part of the antagonizing muscles, by diminished freedom and rapidity of motion. Again, we sometimes resort to an attentive examination and careful feeling of the body of the muscle. On the other hand, we may be deceived by the statement of the patient that he has a feeling of lassitude.

Extent of the paralysis. Paralysis of one-half of the body, with or without paralysis of the corresponding side of the face, is called *hemiplegia*. Paralysis of one side of the face, of an arm, a leg, is called *monoplegia facialis*, *brachialis*, *cruralis*. We also speak of *monoplegia brachio-facialis*. *Paraplegia inferior* is paralysis of both legs; *paraplegia superior*, of both arms. *Hemiplegia cruciata* signifies paralysis of the arm of one side and the leg of the opposite side; *hemiplegia alternans*, or likewise *cruciata*, paralysis of an extremity of one side and of the facial or oculomotorius of the other side.

The extent of the paralysis is an extremely important aid in diagnosis, as follows from the anatomical remarks made at the opening of this section. For anatomical diagnosis, see further below.

2. DISTURBANCE OF THE NUTRITION AND TONE OF THE MUSCLES.

Nutrition shows manifest differences that are very striking, and of the highest diagnostic importance. It is determined by the volume of the muscle and by its electrical behavior (see Electrical Examination). More or less symmetrical diminution in the volume of the muscles of a portion of the limb is designated as diffuse *atrophy*; when it affects a single muscle, as circumscribed atrophy. A corresponding

increase in the volume is called *hypertrophy* or pseudo-hypertrophy (see below). The existence of atrophy, and its extent, are determined by inspection and palpation; if possible, also, by measuring. Whenever one side alone is affected, we are always to compare it with the healthy side. Requiring the patient to make active motion, by which the muscle under examination is made to contract, or which causes contraction in the surrounding muscles, often makes the impression much clearer. We can easily combine testing of the strength with the examination of the state of nutrition.

The volume of an extremity is measured with the tape-measure while the limb is extended at rest (both arms and both legs are to be in exactly the same position), and it is best done at certain points of election.

We measure the upper arm at the point of its greatest circumference; the forearm, 2 to 3 cm. below the lower margin of the inner condyle of the humerus; the thigh, 15 cm. above the upper edge of the patella; the calf of the leg, at its greatest circumference.

Thus, in measuring the forearm and the thigh, we must first fix the point where we are going to take the measure, and mark it with a blue pencil.

Atrophy is divided into the following varieties, which are to be very sharply distinguished from each other:

(a) *Atrophy of inactivity*. This consists of a diminution in the volume of the muscles, which is very slight and which very slowly develops in the course of months of inactivity. Almost without exception, it supervenes in cases of paralysis, and also in any long-continued inaction of the muscles, as in surgical diseases which require the limb to be kept at rest. In this form of atrophy, as will be shown later, the electrical sensibility of the muscles is qualitatively unchanged.

(b) *Degenerative atrophy*, with the so-called atrophic paralysis. This quickly leads to a high degree of atrophy of the affected muscles, and to a qualitative change in their electrical sensibility—the reaction of degeneration (see below). This degenerative atrophy only occurs if the centre which presides over the nutrition of the muscle, hence that portion of the gray matter of the anterior horn corresponding to the affected muscle, is disturbed or is separated from the muscle; therefore, in all primary and secondary diseases of the anterior horns,

in local separations or interruptions of the connection with the anterior roots or peripheral nerves, in peripheral neuritis.

Here belong: poliomyelitis acuta, subacuta, chronica; progressive muscular atrophy of spinal origin; amyotrophic lateral sclerosis; all processes within and of the spinal cord which destroy the gray substance (tumors, hemorrhages, softening); compression of the anterior roots and the peripheral nerves; traumatic complete separation, severe contusion; pressure-necrosis of these; and all forms of acute and slow degeneration or degenerative neuritis.

Also, it will be understood (see above, p. 456) that the motor nerves below the seat of the lesion, as far as the muscle, atrophy; see also Electrical Examination.

On the other hand, degenerative atrophy is wanting in all paralyses which are due to a disease of a motor tract above the anterior horn ganglia—that is, in the pyramidal tract of the spinal cord, of the brain, in the cortex of the brain. Therefore, in these cases, we only have the atrophy of inactivity. Moreover, degenerative atrophy is wanting in paralyses of myopathic origin (see below) and in functional paralyses.

Nevertheless, degenerative atrophy in many diseases occurs in such a way as to cause great clinical difficulties: the rapid (developing within fourteen days) diminution in the volume of a muscle, of course, can only occur when the whole of the affected muscle, or a large compact portion of it is suddenly, at an approximately definite time, completely paralyzed by disease of the anterior horn or of a peripheral nerve (poliomyelitis acuta, section of a nerve, rheumatic facial paralysis, etc.). A disease developing slowly, in the course of weeks and months, causes slowly progressive atrophy, at first disseminated in the separate muscular fibres, only gradually becoming general. There are also difficulties in determining the reaction of degeneration in such slowly extending degenerative atrophy (see below). We have the greatest difficulty in making out degenerative atrophy when the disease is a disseminated one, in which bundles of muscular fibre that are still normal are distributed everywhere between diseased bundles. (Regarding this, see further under Electrical Examination.)

It is to be remarked that all cachexias cause general atrophy, as well as atrophy of the muscles. But it is worthy of still further note that, under the influence of a general atrophy, the paralyzed muscles

often become excessively atrophied, even when the atrophy is not a degenerative one. In cases of myelitis transversa and simple atrophy of inactivity of the legs, when there comes to be a general atrophy, we have often seen the legs become extremely atrophied, quite out of

proportion to the volume of the arms. But there is no reaction of degeneration, and this fact furnishes diagnostic assistance.

It is often extremely difficult for the beginner to form a conception of the behavior of the anterior gray columns when there is disease of a transverse section of the spinal cord, and to answer the question in connection with it, what sort of paralysis will result from such disease. For this reason two examples are presented :

In a severe contusion of the prominence of the neck (fracture of a cervical vertebra, for instance) it may happen that the whole section of the anterior gray columns, which innervates the arms, is disturbed, and that simultaneously the pyramidal-tract fibres for the muscles of both legs are unbroken (at *H* in the figure): there follows a degenerative atrophic paralysis of the arms and a non-atrophic, "simple" (spastic, see under Tonus) paralysis of the legs. The pyramidal-tract fibres of the latter degenerate as far as the lumbar portion of the cord (as far as *L*), but the degeneration stops here: the anterior horn ganglia remain normal, and hence the peripheral nerve and muscle also.

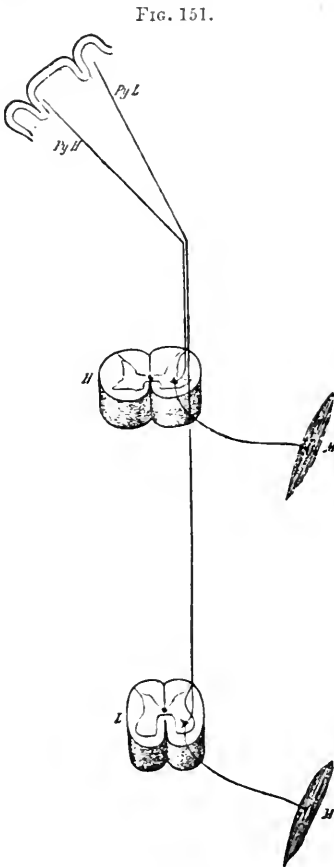

Schema of the innervation of the muscles (partly from EDINGER). The radiation of the *Py*-tracts varies at different portions of the cortex (see p. 454).

A myelitis transversa of the dorsal portion of the cord interrupts the pyramidal tracts to the legs: these become simply (spastically)

paralyzed; a myelitis transversa of the lumbar portion of the cord disturbs the anterior horn ganglia of the legs: these are affected with atrophic paralysis.

(c) *Primary myopathic atrophy.* This is a disease of the muscle, the nervous system being intact. It manifests itself by the fact that, in this disease, the muscle gives less response, corresponding to a simple diminution in its volume: or, if it becomes completely shrunken, there is complete paralysis; and further, by the fact that the electrical examination, as a rule, does not exhibit any trace of the reaction of degeneration. This kind of atrophic paralysis occurs in two quite dissimilar forms:

(a) In muscular dystrophia (Erb), the myopathic form of progressive muscular atrophy (here often combined with hypertrophy or pseudo-hypertrophy) (see below).

(b) In severe chronic diseases of the joints.

The parallelism between atrophy and paralysis mentioned above is, moreover, generally present also in degenerative-atrophic paralyses, provided they develop gradually (subacute and chronic). A distinct disunion of atrophy and paralysis occurs only in acute degenerative-atrophic paralysis (poliomyelitis acuta, injury, etc., of the nerve, acute degenerative neuritis): here the paralysis develops more or less rapidly, but atrophy only becomes manifest in the course of weeks.

Charcot has recently discovered, in certain hystero-traumatic paralyses, a functional paralysis with more marked atrophy, but without the reaction of degeneration. But the atrophy here is not so decided as degenerative atrophy, being rather between this and the atrophy of inactivity.

In very exceptional cases, when there is disease of the cerebrum, particularly of its cortex, there has been found a considerable muscular atrophy, which appears early, sometimes even before the occurrence of paralysis, without the reaction of degeneration. In individual cases of this character, contractures were completely wanting, and tendon-reflex was not increased.

Genuine hypertrophy of muscles occurs in Thomsen's disease [general myopathic spasm]; also sometimes in individual muscles, especially the gastrocnemius muscle, in dystrophia musculorum; here, also, belongs the muscular hypertrophy which develops in the sound leg when one is paralyzed (as in long-standing infantile paralysis).

Genuine hypertrophy is recognized by the increased volume, great hardness, and especially by the increased vigor of the muscle.

Pseudo-hypertrophy, on the other hand, shows increased volume, but diminished power. This occurs in dystrophia musculorum much oftener than genuine hypertrophy, but it may be developed from the latter.

Tonus of paralyzed muscles, active spasm, rigidity of muscles. An increased tonus of the muscles that are paralyzed (rigidity, active spasm) is a characteristic, though sometimes absent, sign of those paralyzes which are of cerebral or spinal origin above the anterior horn. This tonus may be so slight that the examiner will only notice it as a slightly increased resistance during passive motion. But it may also be so strong that even when perfectly at rest a muscle is as hard as a board, and that motion of a joint, in which the muscle would be extended (that is in which the muscle would act as an antagonist), is entirely impossible. Thus spasm of the quadriceps prevents bending of the knee, not only passive, but also active bending, which, probably, if the flexing muscles were intact or were only paretic, would take place (spastic pseudo-paralysis). Patients also, even in slight degrees of rigidity, experience great difficulty in making active motions. That these spasms are not due to permanent anatomical changes in the muscles, only to muscular contraction, is proved by the fact that they are sometimes subject to striking change. If the paralyzed muscles are spastic to a high degree, often for a long time there does not develop any atrophy of inactivity.

Paralyzes due to affections of the cortex of the brain usually manifest themselves by very early spasms. In hysteria, also, very decidedly active spasms occur. (Regarding increased tendon reflex as an attendant phenomenon of spasms, see p. 497.)

Atonic paralysis. This is characterized by diminution or loss of muscular tonus, in consequence of which there is abnormal passive mobility of the joints. This laxness is present in recent paralyzes, in which the atrophic, acutely degenerative condition has not yet developed ("atonic atrophic paralysis"). It is also found in cases of chronic and long-standing degenerative paralysis (see also under Contractures). Cerebral paralyzes, as hemiplegia, in rare cases, may also manifest decided atony. There is a tolerably marked laxness of the muscle, without paralysis, in tabes.

Contractures. In long-continued paralyses, both degenerative and simple, there develops in the paralyzed limbs a constant anatomical shortening of individual muscles, and, indeed, just the muscles that are chiefly spastic often shorten in spastic paralysis, but not always. On the other hand, in degenerative paralysis, it is more the antagonizers of the paralyzed muscles, or those of the paralyzed muscles that are strongest. Thus, from the moment of paralysis, the prevailing position, the posture of the affected limb, gives the first indication of the development of contracture. These contractures do not change. The motions of the limb that oppose the contracture, and the stretching of the affected muscles caused by this motion, are very painful.

3. THE REFLEXES.

1. *Skin Reflex.*

By this we understand the quickly passing contractions of the muscles which are caused by an irritation applied to the skin. The stimulation of the skin usually recommended is tickling or stroking it with the blunt end of a pencil or the handle of the percussion hammer. It is well from the beginning to aim at a certain symmetry in the methods we employ; only in certain cases, especially if there is diminution of the reflex, we may endeavor to call it forth by pricking with a needle or touching it with a piece of ice. The skin reflexes about to be mentioned in detail are, even in health, very different in different individuals (the cremaster reflex relatively varies least); but upon the two halves of the body they are always alike. Therefore, where there are unilateral anomalies of it, the most certain results of trial of the skin reflex are obtained by a comparison with the sound side. If we have like results upon both sides of the body, then it has only a doubtful diagnostic value.

We are not to confound with skin reflexes those motions that are voluntarily made. With some practice they are readily distinguished.

In the face and the upper extremities, the skin reflexes are of no importance; on the other hand, the three reflexes upon the legs and abdomen are of especial diagnostic significance:

(a) The reflex of the sole of the foot. This is produced by irritating the skin of the sole of the foot, and in health consists either in a dorsal flexion of the toes or of the whole foot, or even in motion of

the hip-joint and knee. Pathologically, the reflex may be absent (weakened on one side and increased upon the other). It may be increased with reference to the amount of the contraction, with reference to its extent, as in simultaneous contraction of the other leg, motion of the pelvis or of the whole body, for instance, as shorter opisthotonus; or it may occur slowly, or only after repeated and continued application, or summation of a strong irritation. It would be influenced in its form by the tonus of the muscles of the legs: in spasm of the extensor, for instance, often, instead of a single motion of flexion, there occurs repeated trembling.

(b) The cremaster reflex in men consists of a prompt upward motion of the testicle from the contraction of the cremaster which follows irritation upon the inner surface of the thigh. It is not to be confounded with the indolent contraction of the tunica dartos of the scrotum, which follows somewhat later. Sometimes the cremaster reflex is extended to the muscles of the abdomen, causing the backward drawing-in of the abdomen.

(c) Abdominal reflex. This is a contraction of the muscles of the abdomen [chiefly the rectus] from irritation of the skin of one side of the abdomen [stroking downward from the edge of the ribs], which is recognized by an unilateral or a bilateral drawing-in of the abdomen; when the irritation is weak, by a slight displacement of the navel toward the side irritated.

The figure explains the mechanism of the skin reflex: the sensible irritation proceeding from the skin is conveyed by the motor fibres to the anterior horn; but the anterior horn itself is influenced by the reflex retarding fibres which pass in the pyramidal tract. It is clear that the skin reflex must be lost by an interruption of the reflex arc at any point, or by the unsusceptibility of the skin, or by myopathic paralysis: that it must be increased with any increased excitability of the anterior horn, or removal of the restraining reflex from the brain, also in hyperæsthesia of the skin. Recently, an increase of the abdominal reflex upon one side has been observed in intercostal neuralgia (Seeligmüller).

We have not mentioned a number of other skin reflexes, since they are not important: for pupillary reflex, the reflex closure of the lids, see under Examination of the Eye.

Of the reflexes of the mucous membrane, the choking reflex when the mucous membrane of the pharynx is tickled has diagnostic sig-

nificance: its absence is a frequent occurrence in hysteria (anæsthesia of the mucous membrane), also in bulbar paralysis (nuclear paralysis).

Of very much greater diagnostic importance are the

2. *Tendon Reflexes (periosteal, fascial reflex).*

These reflexes are likewise short contractions. They are produced by taps upon the tendons of muscles, upon the bones and fascia, also by sudden tension of a tendon by a quick passive movement (in which, however, the muscle itself is also stretched). Both the short movement of the limb and the momentary hardening of the muscle may be made an object of examination. In order to develop the tendon reflex it is necessary to have the limb perfectly relaxed, and it is well, also, to divert the attention of the patient.

FIG. 152

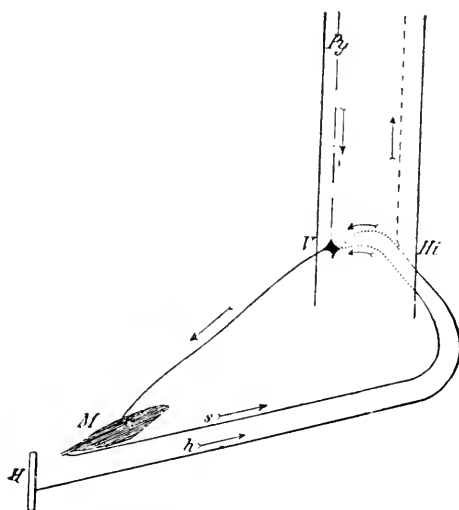

Diagram of the course of the cutaneous and tendon reflexes. *H*, skin; *M*, muscle; *V*, anterior horn; *Hi*, posterior horn; *s*, the tract of the tendon reflexes; *h*, the tract of the cutaneous reflexes.

Whenever it is possible, a comparison is to be made between the right and left limbs, but even where this cannot be done, as when the disturbance is bilateral, or the two sides are disturbed in a similar way, the greatest importance can be attached to the result of the test, because here the individual variations are not prominent, as they are

in the reflexes of the skin; hence the tendon reflexes are much more important aids in diagnosis than the skin reflexes.

Tendon and skin reflexes may be confounded. In a doubtful case, this can be avoided by comparing irritation of the skin alone at the given points, by means of pinching, pricking a fold of skin, or by direct mechanical muscular irritation (see below, Biceps-tendon Reflex); lastly, as in the skin reflexes, by having the patient take part in the examination by making voluntary contractions; these take place later, and, hence, can only deceive the inexperienced. We may be very easily misled into supposing that there is an absence of tendon reflex, if the muscles under examination are not perfectly relaxed.

We enumerate the tendon reflexes according to their importance:

(a) *Patellar reflex* (Erb; knee-phenomenon, Westphal), consists in a contraction of the quadriceps. It is caused by striking with a percussion hammer, with the tips of the semi-flexed fingers, or with the rim of the ear-plate of a stethoscope, upon the patellar tendon. Often we must carefully seek the most susceptible point.

Sometimes we may first make the test with the leg covered; but if the result is in any way doubtful, then the knee must be uncovered. Whenever a very exact examination is to be made, the latter must always be done. In order to get the muscles completely relaxed, we must select certain positions: a favorable position is to have the limb extended at rest, with the feet resting upon the floor; another position is with the leg crossed over the other in the sitting position; a third is to have the patient sit upon a table with the legs hanging down; with the patient in bed, we pass the hand under [the thigh just above] the knee and gently lift it up. As a means of inducing patients to relax the limb, they are to be diverted by conversation, or they may be directed to close the fist as tightly as possible, or sometimes we may have them grasp the left hand of the examiner or press the hand of someone else.

Not only active contraction, but possibly also increased tonus of the quadriceps, disturbs the exhibition of the reflex. Even a pathologically increased patellar reflex may thus be hindered by spasm, which must be carefully guarded against. Hence, as far as is possible, we must prevent any active spasm by the position (particularly

by a cautious passive motion) of the knee-joint. It may also be interfered with by deformity and stiffness of the joint.

With very rare exceptions, the patellar tendon reflex is always present in health, and both sides are equally strong.

The author cannot forbear saying that he regards as impracticable the designation "Westphal's sign" for the *absence* of patellar reflex—notwithstanding his very high regard for the meritorious investigator, who is deserving of the honor—because this designation could easily be confounded with the opposite (as, that Westphal's sign meant patellar reflex).

(*b*) *Tendo-Achillis reflex and foot-phenomenon.* Striking upon the tendo Achillis, and often only on a very limited portion of it, in health, generally causes a reflex contraction of the gastrocnemius (and soleus) with slight plantar flexion of the foot. In doing it, it is best to lift up the foot by taking the malleoli with the left hand (the foot of course being bare).

By foot-phenomenon we designate the contraction of the same muscles if there is a continuous contraction, a passive dorsal flexion of the foot, often best excited by a quick passive motion (stretching the tendons, also the muscles); a reaction then takes place in a series of rhythmical contractions of the plantar flexors, or a long series of contractions: foot clonus, foot-phenomena, dorsal clonus. This latter phenomenon is not really a pure tendon-reflex, rather in part it is dependent upon direct irritation of the muscles as a result of stretching. But it has exactly the same diagnostic significance as increased tendon-reflex, for it does not at all occur in health, or, at most, only temporarily, as when one is very tired.

(*c*) *Tendon reflex of the upper extremities.* Here they do not have the same diagnostic importance [as those under (*a*) and (*b*)], particularly because they are very often absent in health. Striking the flexor tendons at the wrist-joint, the biceps at the bend of the elbow, the triceps tendon close above the olecranon, generally causes a slight reflex contraction; in the two latter we must be careful not to strike the muscle itself. (See Mechanical Irritation.)

(*d*) *Periosteal and fascial reflexes* are elicited by striking the latter and the bones—the tibia: patellar reflex; bones at the wrist-joint: biceps, even pectoralis reflex. We not infrequently observe them in health, but very particularly when there is increased tendon reflex.

Not wholly unimportant, also, are the bone reflexes which are manifest in the muscles of the face from blows upon the knee—upon the nose; they are absent in bulbar paralysis, and are present in paralysis of the facial tract above the bulb.

The mechanism of the tendon reflex is made clear by Fig. 152, p. 497. We see that for its production it is necessary to preserve the integrity of the reflex arc: (*a*) tendons; (*b*) sensitive (that is, centripetal) nerve; (*c*) posterior root; (*d*) anterior horn; (*e*) motor nerve; lastly, (*f*) muscle. But we take note of the influence upon these of restraining fibres in the pyramidal tract, which may be cut off, and also may possibly be temporarily irritated. Interruption of the pyramidal tract (which is manifest by its secondary degeneration as far as the anterior horn) or cutting off of the pyramidal tract by primary degeneration, causes increase, therefore, of tendon reflex, as in cerebral paralyse, spinal paralyse from disease of the pyramidal tract, in myelitis transversa, amyotrophic lateral sclerosis, spastic spinal paralysis; but also increased irritability of the spinal cord itself, as in strychnia poisoning, tetanus, lyssa, neuroses, and particularly sometimes in hysteria. On the other hand, the tendon reflexes are diminished or are lost: in disease of the anterior horns, of the peripheral nerves, of the posterior roots or their connection with the anterior horns (poliomyelitis, spinal progressive muscular atrophy; any disease of the peripheral nerves; tabes dorsalis—here diagnostically very important; myelitis, tumors, hemorrhages, if in certain locations—that is, if they disturb the gray substance for the arm or leg).

It follows from what precedes that the increase, and also in many respects the diminution, of the tendon reflexes, goes parallel with increased or diminished tonus of the muscles. And, in fact, tonus seems to be genetically related to tendon reflexes. In this sense it is also of interest that the predominant reflexes of the arm are the flexors, of the leg the extensor of the knee, reflex of the foot, the plantar flexor tendo-Achillis, and that exactly corresponding with a recent spastic paralysis of the arm, we are apt to have flexor spasm of the arm and extensor spasm with paralysis of the leg at the knee and ankle.

Westphal's view [p. 499] that the "tendon reflexes" are not reflexes, but that they are always, when elicited by the prescribed methods of testing, due to the direct irritation of the muscles by stretching and concussion, is to be regarded, especially as respects

patellar reflex, as definitely refuted. Nevertheless, we must still agree that the ordinary method of examination for the foot-phenomenon in this respect is not free from objection (as has been urged by others also, as Jendrassik): the brusque dorsal flexion of the foot must necessarily stretch the gastrocnemius—here it may be due to the effect of stretching of the muscle added to that of the tendon.

Mixture of tendon reflex and direct muscular irritation from stretching the muscle probably also occurs in executing “brusque passive motion” of the limb (very quickly bending it, and extending the knee-joint, etc.), which is very strongly to be recommended for determining a slight degree of increased tonus of the muscles.

4. ELECTRICAL EXAMINATION OF THE NERVES AND MUSCLES.¹

Regarding the Physics, and the Instruments Employed.

For the electrical examination we employ the secondary or induction current of the faradic battery and the constant current of a galvanic battery. We graduate the strength of the faradic current by the extent to which we withdraw the outer coil from the inner, which is reckoned by centimetres and millimetres from the point where one coil is completely enclosed by the other, or the distance between the coils \times cm.; the strength of the galvanic current is changed by immersing a different number of elements, sometimes more delicately by a rheostat. [The galvanic batteries now made in the United States and England usually have a rheostat as a part of the outfit. It is much better to use it, for two reasons: all the cells of the battery are drawn from alike, since all can be thrown into the current at the beginning of each sitting; the gradations in the strength of the current are made without shock to the patient.]

The current is conveyed to the body by an electrode, previously moistened with warm [preferably salt] water. In making the examination, one of these is always the indifferent one—that is to say, it merely serves to close the current that is flowing through the body; the other is the “differentiating” or examining one. The first must be as large as possible, in order to spread out the current

¹ Of course it is not necessary here to go into particulars. Hence we refer the reader to special works, particularly to Erb's classical presentation in his *Electro-Therapy*.

over as large a surface as possible at the point where there is much the greatest resistance, namely, at the skin. The resistance is inversely proportional to the cross-section. Usually, the indifferent electrode is placed upon the sternum. For examining nerves and small muscles, the examining electrode must be quite small, in order to convey the current as closely as possible to the structures, which all lie near the skin; we cannot examine those lying deeper. For this reason, in making the faradic examination, it is best to select the so-called "fine" electrode of Erb (see Fig. 153). But in employing the galvanic current, such a small electrode would so concentrate the current by its small cross-section that its passage through the skin would be too irritating, and hence we must select for this

FIG. 153.



"Fine" electrode of Erb (natural size).

current one somewhat larger. The size of the electrode is, as already said, of important influence upon the intensity of the current in its transit through the skin and a short distance beyond it, hence, also, in that to the stimulating nerves. It is likewise not unimportant, for it is very desirable to know, at least approximately (why, see below), with how strong a current we touch the nerves beneath the skin. For this reason, and in order that the conditions under which the examinations, conducted by different persons, may be as nearly as possible alike, it is strongly recommended to employ a so-called "normal electrode." Unfortunately, we have several, of which we consider only the following: one devised by Erb, of 10 sq.cm. diameter (either square, 3.3 cm. on a side, or round with a diameter of 3.5 cm.); and one by Stintzing, round and somewhat convex, 3 sq.cm. in cross-section and 2 cm. in diameter. With every record of an examination there should always be a statement of the size of the electrode employed.

We have no absolute measure for the total strength of the faradic current in making examinations. Here we note the distance of the coils, but this, according to the construction and power of the

apparatus, may indicate different strengths of current; nevertheless, this has value for comparison where the examinations are made each time with the same apparatus (see below). For the galvanic current

we have an absolute measure: the milliampère (M.-A.), $= \frac{1 \text{ volt}}{1000 \text{ ohms}}$.

(See text-books upon Physics.) To ascertain the number of milliampères used, we employ a so-called absolute galvanometer. The total strength of current as given by the galvanometer is then divided by the transverse section of the examining electrode in such a way that, for example, with a total strength of 2.5 M.-A. and an electrode of

12 sq.cm. transverse-section to a sq.cm., a current of $\frac{2.5}{12}$ M.-A. is given

off (N. B., to a sq.cm. of the skin); the density of the current in the nerves examined is not exactly proportional to that in the skin (see below). Hence, this fraction has no exact value as such—rather only as a brief expression of the two figures which we have to consider.

If we employ a normal electrode, then we can note: Norm. electrode Erb (10 sq.cm.) 2.5 M.-A., or $\frac{2.5}{10}$ M.-A. (N. el. Erb).

This comparison of the total strength of the current with the absolute measure is nowadays indispensable; it has, it is true, only a value which is, in a certain sense, circumscribed. A difficulty which at present is tolerably successfully overcome, consists in the fact that the conducting resistance of the skin, for various reasons, declines, and with it, although only in a slight degree, the strength of the current increases, while the electrodes rest upon the body, and hence, also, from the moment when the galvanometer is switched-in to the instant when the needle comes to rest. This space of time in the new galvanometers (especially Edelmann's horizontal galvanometer, but also with the instruments of Böttcher-Stöhrer and Hirschmann), by appropriate checks, is satisfactorily shortened. Stintzing is to be credited with very exact examinations regarding these points.

A much more considerable difficulty, and one which probably will never be entirely overcome, consists in the fact that we cannot concentrate our current upon the nerve (muscle) to be examined, because it lies in tissue which itself is a good conductor, and that from the total strength of the current and the cross-section of the conductor of

the current into the skin we can only approximately determine the current which enters the nerve (muscle) itself. For this, there are two chief reasons: first, because the situation of the nerve with reference to the skin varies with each individual (layer of fat, anatomical peculiarities); and because, from the situation of the nerve, the fraction of the current which enters it is intrinsically changed. (Even the quality of the contractions caused by the current will be influenced by the relation of the nerve to the skin.—Erb.) Further, since the nerve offers a quite considerably stronger resistance to the current if it enters it at a [right] angle to its axis, than if it flows along its axis, the angle at which the current enters the nerve will considerably affect the strength of the current; and we cannot accurately measure this angle in the case of all nerves.

There follows from the foregoing, first of all, the practical point that, in spite of our ability to measure the strength of the total current, we are taught to bear in mind the individual peculiarities of the nerves (muscles) to be examined, in their relation to the skin, in interpreting the results of the examination, so as to supply, as far as possible, the want of exactness in our calculation; and it follows, further, that it is superfluous, and even a source of error (because it withdraws our attention from the more important points of view), if we strive after exactness in electrical examination by the fineness of the apparatus, especially of the galvanometer—an exactness which, let it be said once for all, the examination cannot have. Of what use is it exactly to determine the strength of the total current to within one-tenth of a M.-A., when we do not exactly know how much of the total strength the real objects of our examination—the nerves—receive?

How to distinguish the poles quickly. In the faradic current the poles come but little into consideration, namely, only so far as to know that the cathode (negative pole) of the opening current of the secondary coil has a stronger irritating effect than the anode. In the galvanic current, the poles are widely different, and hence it is important to distinguish them quickly upon the apparatus. The simplest way is to employ a very mild current, and then to place the two electrodes upon the cheeks; upon the side of the anode we experience a peculiar indefinable taste upon the tongue and the mucous membrane of the cheek of that side; or we place the wires

of both poles about 1 cm. apart upon a piece of wet blue litmus paper: the anode colors it red.

By a current-changer we are able to reverse the poles—that is, to quickly make the anode the cathode, and *vice versa*.

METHODS OF EXAMINATION AND THEIR PHYSIOLOGICAL RESULTS UPON THE LIVING HUMAN BODY.

As a foundation to what is here to be spoken of, we refer most urgently to the text-books upon physiology or upon electro-therapeutics, especially to what is taught regarding electrotonus and the laws of contraction (Pflüger). Unfortunately, we cannot enter upon these subjects here; only remarking that the results of the examination upon uninjured animals and men differ from the physiological results, and for physiological reasons, which cannot here be explained. [The student is referred to Landois and Stirling's *Physiology*, section 336, for an excellent presentation of Electrotonus—law of contraction.]

The electrical examination consists of an irritation of a nerve (indirect irritation) as well as of the muscle (direct irritation), one of which, indeed, takes place with both kinds of current, and in observing the effect of the irritation, as it is manifest by muscular contraction. Thus, we have to make use of an indirect faradic and galvanic and a direct faradic and galvanic examination. As previously stated, the extent of the irritation is always a matter of uncertainty to us (distance of the coils; total strength of the galvanic current in M.-A.). We draw our conclusions from the results of the examination:

(a) From the degree of excitability of the nerve (muscle), by determining with what strength of current there follows the first, smallest, just noticeable, or minimal contraction; or also by determining the extent of irritation which is necessary with the galvanic examination to cause a tetanic contraction. The minimal contraction is observed at the muscle, or by the movement of the joint. The comprehension of these minimal contractions (still more of galvanic tetanus—see below) by the individual examiner is, to a certain extent, variable, and a source of inexactness.

(b) With reference to the quality of the reaction in the direct irri-

- (b) Stronger current : strong CaSC,
 CaO : negative,
 AnSC,
 AnOC.
- (c) Very strong current : CaSTe,
 feeble CaOC (not always),
 strong AnSC,
 strong AnOC.

That is, with a weak current there is only CaSC, with a strong one also AnSC, and about at the same time AnOC, with very strong, CaSTe, and sometimes CaOC.

The contractions are, all of them, short, lightning-like.

2. *Muscle*, irritated at a place where there is no nerve, or, at least, irritated as little as possible (at a distance from the "motor point," the place where the nerve enters, see below):

Moderate current : CaSC,
 Only a little stronger : AnSC.

The contractions of opening the current are subordinate, often entirely wanting. The contractions mentioned as occurring at the closure are, indeed, short, but yet not so lightning-like as those from an exposed nerve.

Method of Examination in Detail. Normal Condition.

Preliminary remarks. In examining individual nerves and muscles we must strive most earnestly to employ exactly similar methods. In the first place, in examining nerves, we should use Erb's fine electrode for the faradic current, and either Erb's or Stintzing's normal electrode for the galvanic current. With the galvanic current, especially, we should always make about the same pressure upon the electrode, increasing the pressure only when there is a very firm layer of fat (in order, in this way, to equalize, to some extent, the effect of the fat layer). We are always to examine homonymous parts together, that is the right, then the left radial, the right, then the left median, or, when the disease is unilateral, the nerve (muscle) of the sound side always first.

1. *Points of Stimulation.*

In what follows we give the points of stimulation of the nerves and the so-called motor points of the muscles (studied by Duchenne, Ziemssen, Erb—the illustrations from Erb's *Electro-Therapeutics*), which chiefly correspond to the points where the nerves enter the muscles, and hence are essentially also the nerve-points. In examining the muscles themselves we place the electrode upon the fleshy part of the muscle, avoiding, as far as possible, both of these related points.

FIG. 154.

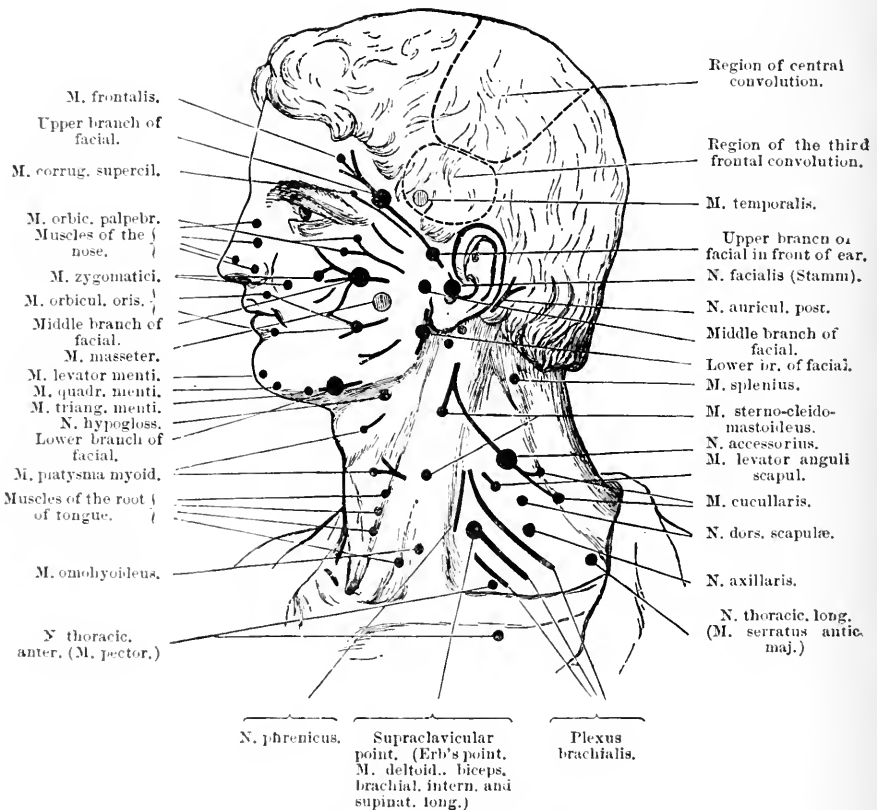

Points of Electrical Irritation upon the Head and Neck. (ERB.)

The points most distinct in the figure correspond to the chief places for applying the stimulation. In the faradic examination, we seek

carefully in the course of the nerve for these most excitable points (that is, of course, for those places where they lie nearest the skin).

Remarks regarding Fig. 154: We observe particularly the upper,

FIG. 155.

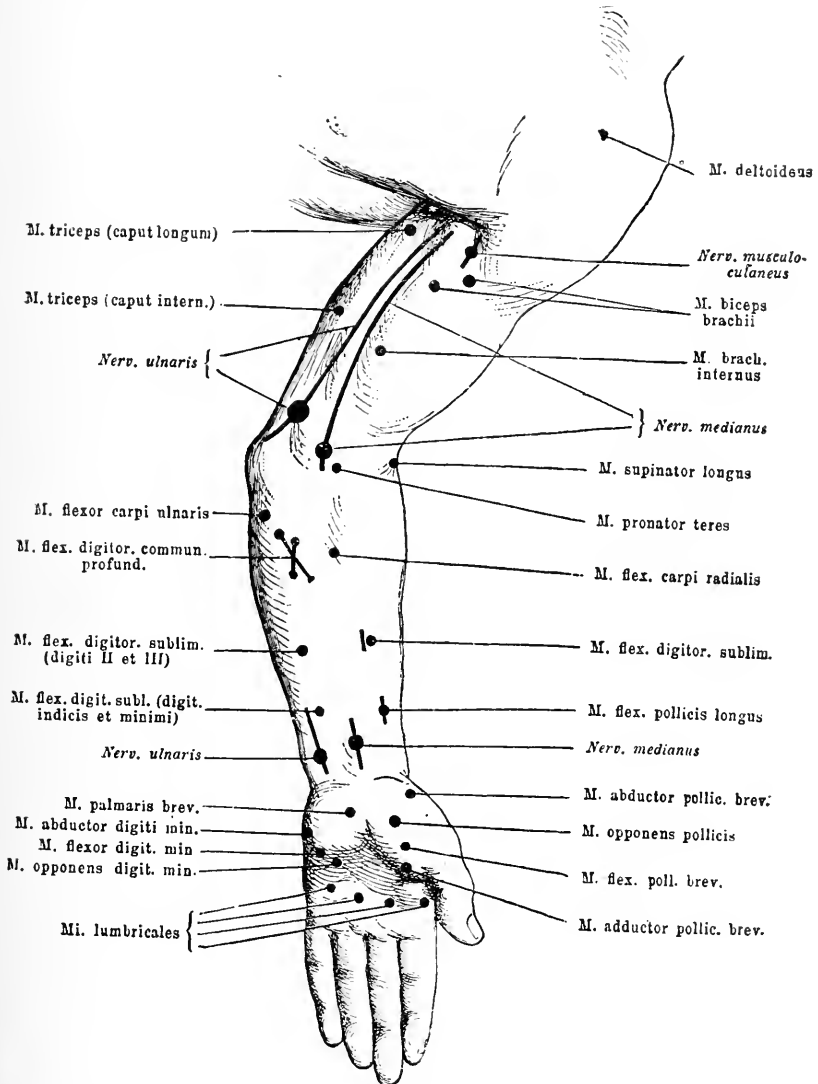

Points of Electrical Irritation upon the Arm. (ERB.)

middle, and lower facial (the three most distinct points upon the face). At the brachial plexus we notice Erb's point [the supra-clavicular point].

FIG. 156.

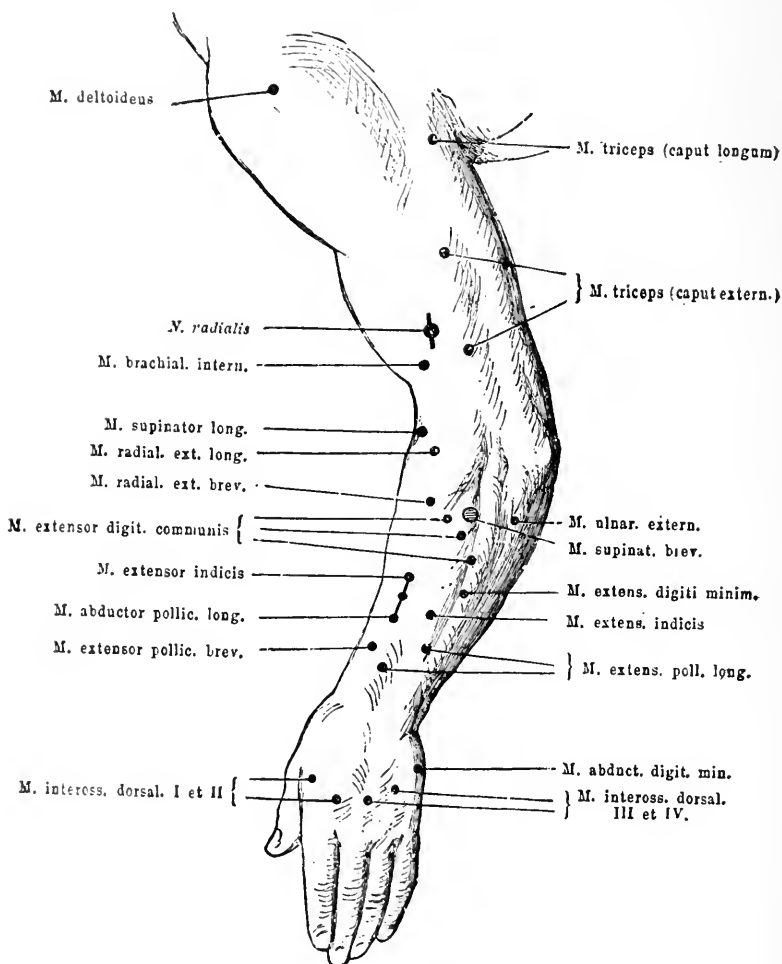

Points of Electrical Irritation upon the Arm. (ERB.)

2. Examination.

The tongue and soft palate will be best directly irritated with an electrode that is isolated as far as to the end (which may be done by

simply winding it with adhesive plaster). A strong galvanic current should never be used upon the head.

Remarks regarding Figs. 155 and 156: We examine the arm in the position of moderate flexion and slight pronation, but the muscles are to be relaxed (hence, the arm must rest upon something).

The radial nerve lies deep, especially if the muscles are well developed. We can generally follow with the finger the ulnar nerve upward from the sulcus of the internal condyle of the humerus.

Remarks upon Figs. 157, 158, 159 (pp. 511-514): It is very difficult to stimulate the ischiatic nerve. It can only be done by

FIG. 157.

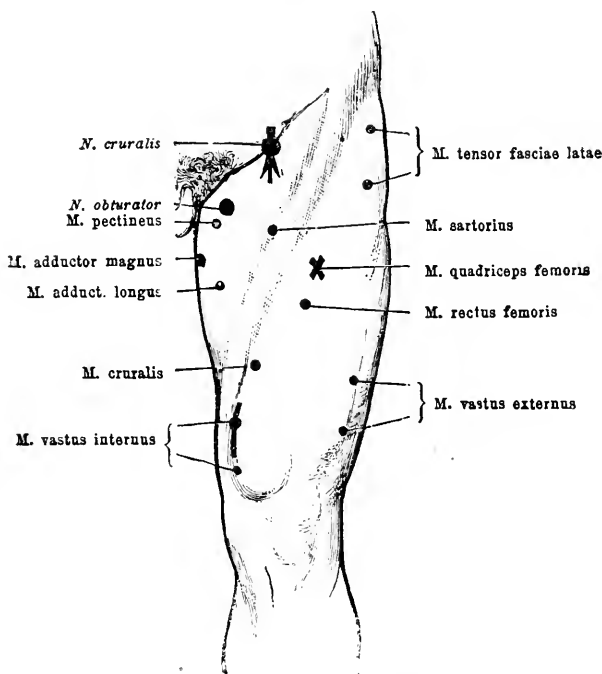

Points of Electrical Irritation upon the Upper Part of the Thigh. (ERR.)

pressing the electrode in deeply and employing a strong current. We can easily find the peroneus nerve, if we feel for the head of the fibula and go inward and upward from this.

Upon the back, since the nerves almost nowhere lie sufficiently

near the surface to permit of the indirect examination, we have to do almost exclusively with direct muscular irritation. It is superfluous to make more exact statements regarding the simple topographical relations.

We demonstrate this upon a single nerve-muscle, and for this we take the radial. We always begin with the faradic current, and this for good reasons, which have recently been made more strong (relations of the "resistance to conduction"—Stintzing), which we cannot enter upon here.

(a) *Faradic Examination.*

(a) *Nerve.* The indifferent electrode is placed upon the sternum, the examining electrode (the fine one of Erb), held as a pen in writing, is placed upon the radial nerve [musculo-spiral], where it turns around the humerus at the middle of the arm: here tolerably deep pressure is necessary. The induction-coil is to be pulled out till the minimal contraction is produced, and the distance to which it is removed is read off and noted. Thus will we feel for the nerve with the electrode: the minimal contraction takes place at the instant we pass over the nerve. Next, there is to be determined the "conductive resistance" at that particular spot: we employ the galvanic current; we apply a well-moistened normal electrode; a definite number of elements of the battery is inserted; we read off and note down the figures of the galvanometer in M.-A. The galvanometer is to be read when the electrode has been upon the nerve for just thirty seconds.

It is necessary, in our opinion, to determine the "conductive resistance" exactly in the manner described by Erb. The fluctuations in the conductive resistance, and with it (in an opposite sense) the strength of the total current, are in fact, during the examination, very slight, and can ordinarily, as has been shown most accurately by Stintzing, be neglected. But, in some cases, it happens that at the point of examination the skin is very tender, or abnormally dense; in which case, of course, with the same separation of the coils of the same apparatus, we have relatively a stronger or relatively a weaker current; and we obtain a minimal contraction with a large, or with only a very slight, conductive resistance. This result we would

refer to an increased or diminished irritability of the nerve if we had not ascertained by the galvanic determination of the "conductive resistance" that the skin was the cause of the variation. Extremely instructive examples illustrating this point are given by Erb in his *Electro-Therapeutics*.

FIG. 158.

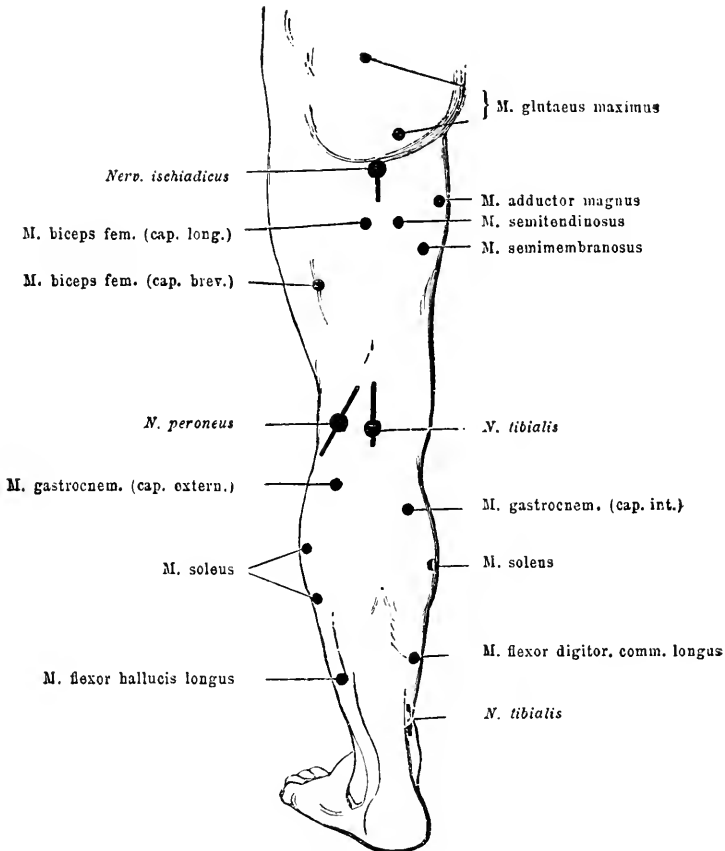

Points of Electrical Irritation upon the Back of the Lower Extremity. (ERB.)

In other words: whenever we are making an electrical examination, we must know what strength of total current we are employing. Since we are not able to determine this directly with reference to the

faradic current, we must endeavor to form an opinion of the total strength of the faradic current (with a certain definite separation of the coils) by bearing in mind the total strength of the galvanic current which is caused by a certain number of elements (always the same).

FIG. 159.

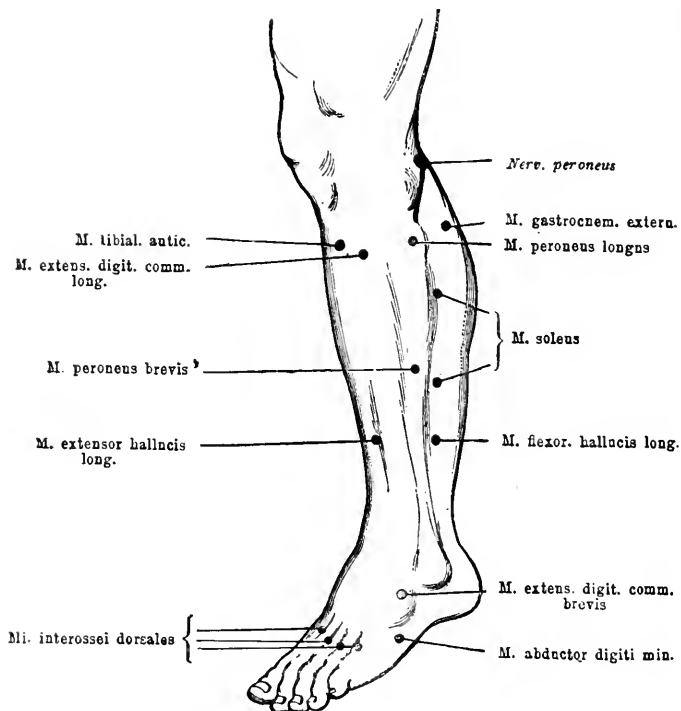

Points of Electrical Irritation upon the Leg. (ERR.)

If we examine at the same time a number of nerves, we first determine the minimal contraction for all, and then the conductive resistance; and, after we have examined the nerves, we can at once make the faradic examination of the muscles.

It is always well to follow the faradic examination with the galvanic, and in this way, with a good deal of practice, we can form an opinion regarding the relation of the conductive resistance at the different points of stimulation of the nerves, and can make a counter judgment regarding the faradic result by a comparison of the number of ele-

ments used each time, and the absolute strength of current that is obtained. But, then, there must always be given in the record of the galvanic examination both the number of elements and the strength of the current in M.-A.

We wish that the direction given above, that the galvanometer should be read when the electrodes have been in place just thirty seconds, could be carried out in all efforts at electro-diagnosis, because otherwise the marked increase of the current at the beginning, just after the electrodes have been applied, could easily occasion great inequalities.

(β) *Muscles supplied by the radial [musculo-spiral] nerve.* We use a somewhat larger electrode, stimulate the fleshy part of the individual muscles, and, lastly, determine the minimal contraction; the determination of the conductive resistance is not necessary.

Under some circumstances, there comes into consideration the quality of the muscular contraction in indirect and direct faradic stimulation. (See under Reaction of Degeneration.)

(b) *Galvanic Examination.*

(α) *Nerve.* Place the indifferent electrode upon the sternum and the examining electrode (with somewhat strong pressure) upon the radial [musculo-spiral] nerve where it passes around the humerus; close the cathode three times; if the result is negative, increase the number of elements; again close the cathode three times, and so on until the minimal contraction is found. Then switch-in the galvanometer and read off the strength of the total current. (Galvanometers that have a very good arrangement for damping the vibration of the needle can remain switched-in during the examination.) Now determine the minimal AnSC in the same way (but it may be omitted). Usually we may be satisfied with this. The next point of interest would be the determination of CaStE. (Regarding variations in the quality of the reaction, see under Reaction of Degeneration.)

(β) *Muscles of the radial.* We proceed as in the case of the nerves, but sometimes we may place the indifferent electrode upon the wrist, dorsal side, etc. It is always necessary to determine the minimal CaSC and minimal AnSC; but before all, the most exact observance

of the character of the contraction (see under Reaction of Degeneration), whether it is "lightning-like" or "slow," and in this direction we not only observe the minimal contraction, but also whether it is a stronger, or a strong, contraction.

Summarized, the scheme of examination would be as follows :

(a) Faradic examination :

(α) nerve

(β) muscle

(b) Galvanic examination :

(α) nerve

(β) muscle.

3. What to Observe in Determining the Electrical Reaction.

We examine in two main directions: (a) the quantitative excitability, or degree of excitability of the nerves and muscles; (b) the qualitative excitability of the muscles under galvanic stimulation.

(a) *Quantitative excitability.* Its diminution in the most marked degree, namely, loss of excitability, is easily recognized. To the record is always to be added: "lost when the coils of the induction apparatus were separated to a distance x , or for a current of x M.-A." On the other hand, it is difficult to define the limits between the normal and pathological in simple diminished or increased excitability, particularly of the nerves. We can take different ways to arrive at a conclusion in this regard :

(a) We compare the two halves of the body—very much the most certain way, but of course only applicable in cases of unilateral disease. Normally, the difference between the two halves of the body is very slight. The maximal differences (for the nerves and with the galvanic current, according to Stintzing (58 healthy persons; Stintzing's normal electrode of 3 sq.cm.), are :

Ram. frontal. N. VII.	0.7 M.-A.	N. radialis	1.1 M.-A.
N. accessorius	0.15 "	N. peroneus	0.5 "
N. medius	0.6 "	N. tibialis	1.1 "
N. ulnaris 2" above the olecranon	0.6 "		

For faradic excitability the difference for the two sides of the body, at least for the four pairs of nerves that come especially into consideration, rami frontal. (facial.), N. accessorius, ulnaris, peroneus (see below) is, according to Erb, scarcely ever greater than 10 mm. separation of the coils of his Dubois induction apparatus; according to

Stintzing the maximal difference of all the pairs of the body that are accessible for examination is 15 mm.

A difference which approaches this maximal difference must lead one to think of a pathological condition; a difference that is materially greater is certainly pathological. But whenever a difference is found, we must always consider whether the two homonymous nerves are situated exactly alike (malformation of the bones, etc., see above).

(β) We are to observe the relation which exists between the irritability of the N. frontalis (facialis), accessorius, ulnaris (at the elbow), peroneus: according to Erb's method.

These nerves, but especially the ulnaris and peroneus, show only slight differences in health, as the following table, taken from Erb's *Handbook*, shows:

Faradic Current.

1. Healthy person, mechanic, age thirty-eight years.

	Distance of coils in mm., minimal contractions.		Variation of galvanom. (old one), 10 elements.	
	r.	l.	r.	l.
N. frontalis	165	166	18°	19°
N. accessorius	172	177	16°	15°
N. ulnaris	159	158	6°	6°
N. peroneus	160	163	7°	9°

2. Healthy person, laborer, age twenty-four years.

	Distance of coils in mm., minimal contraction.		Variations of galvanometer (old one), 10 elements.	
	r.	l.	r.	l.
N. frontalis	195	192	17°	17°
N. accessorius	187	182	10°	9°
N. ulnaris	135	185	6°	10°
N. peroneus	180	180	5°	5°

Galvanic Current.

Healthy men, thirty-eight to twenty-four years of age. (Normal electrode, 10 sq.cm.)

	Occurrence of the first CaSE.		Occurrence of the first CaStE.	
	r.	l.	r.	l.
N. frontalis	1.4 M.-A.	1.2 M.-A.	8.0 M.-A.	8.0 M.-A.
N. accessorius	0.5 "	0.5 "	4.0 "	4.0 "
N. ulnaris	0.4 "	0.4 "	6.0 "	5.5 "
N. peroneus	1.5 "	1.5 "	7.0 "	7.0 "

By studying these tables we ascertain from them the relation between these four pairs of nerves as to the extent of their irritability, and it is possible to recognize with greater certainty a bilateral variation, especially of the ulnar or peroneus nerves.

(*γ*) Lastly, Stintzing has given us in a very exact way the "limits of value" for the irritability of nerves ascertained in the case of fifty-eight healthy persons (Edelmann's galvanometer, normal electrode 3 sq.cm.). But these figures are only of value for Stintzing's normal electrode:

R. front. N. fac.	0.9—2.0 M.-A.	N. ulnaris	0.2—0.9 M.-A.
R. zygomat. N. fac.	0.8—2.0 "	2" above the olecr.	
R. ment. N. fac.	0.5—1.4 "	N. radialis	0.9—2.7 "
N. accessorius	0.1—0.44 "	N. peroneus	0.2—2.0 "
N. medianus	0.3—1.5 "	N. tibialis	0.4—2.5 "

In individual cases, however, Stintzing has found still smaller or larger figures. These extreme values are exceptions, possibly, of a pathological nature.

Except in the reaction of degeneration, the quantitative irritability of the muscles very often goes quite parallel with that of the nerves. We can endeavor to determine this by estimating it. For its relation to the reaction of degeneration, see under the latter heading.

(*b*) *Qualitative irritability of muscles from galvanic stimulation.* Although, with respect to the nerves in general, we are only interested in the strength of current required to produce the first occurrence of CaSC and CaSTe, since the law of contraction of the nerves is that normally the character is almost always lightning-like, in the direct galvanic stimulation of the muscles, two important variations come into consideration: *the character* of the contraction (whether lightning-like or slow, vermiform, wave-like), and further, *the law of contraction*, and particularly *the relation between CaSC and AnSC*. But the first point of view is much the more important.

There are two classes of pathological galvanic muscular reactions: 1, the reaction of degeneration (EaR), the exclusive attribute of degenerative-atrophic paralysis; 2, the myotonic reaction, which occurs solely in Thomsen's disease.

1. *The Reaction of Degeneration (EaR).**(a) Complete EaR.*

The electrical examination gives the following results :

Faradic :

nerves : $I = 0$, that is, irritability (I) lost,

muscles : $I = 0$, that is, irritability lost.

Galvanic :

nerves : $I = 0$, that is, lost,

muscles : slow, tonic, vermiform contractions :

the quantitative irritability, about normal, or increased or diminished; AnSC occurs with a less strong current than the CaSC, and with a less strength of current from which both take place, AnSC is greater than CaSC: $AnSC > CaSC$.

(b) Partial EaR.

Faradic :

nerves : diminution of I,

muscles : diminution of I;

Galvanic :

nerves : diminution of I,

muscles : EaR as above.

For more ready comprehension we add here two curves from Kast, which graphically exhibit the normal muscular reaction and the EaR.

FIG. 160.

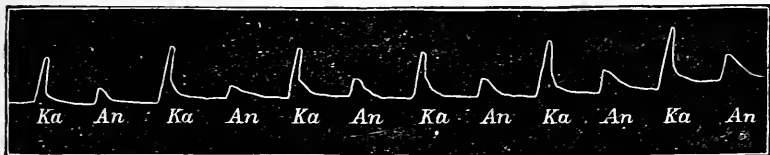

Diagrammatic representation of the normal galvanic muscular reaction. Healthy young girl. Stimulation of the muscles in the region of the peroneus. 33 cells. Ka = CaSC; An = AnSC. (After KAST.)

FIG. 161.



Diagrammatic representation of the reaction of degeneration (EaR). (After KAST) Case of poliomyelitis anter. chronic. Same muscles as above. 40 cells. Contractions tardy, AnSC > KaSC.

Course of EaR. EaR is the pathognomonic sign of those changes which take place in muscle, or motor nerves and muscle, when they cease to stand under the peculiar trophic influence of their anterior horn ganglia—those alterations we designate as degeneration of the nerves and muscles. This degeneration can be most beautifully studied by the electrical phenomena if a nerve trunk is, at some place, suddenly interrupted throughout its whole transverse section. Whenever there is such an interruption there is manifest a complete separation of the portion of the nerve of the muscles located peripherally from the anterior horn, which must inevitably lead, not only to paralysis, but also degeneration of the portions cut off, and with it EaR. But now the case can either proceed so far that there is a permanent interruption at the injured spot, which results in complete atrophy of the nerves and muscular fibres, or, after a time, the conduction at this place may be restored; and in the latter case there is a return of the tissues of the nerves and muscles to the normal condition—that is, there is regeneration of them. Now, according as the degeneration of the nerve (muscle) results in atrophy (*i. e.*, transformation into connective tissue), or again regenerates and returns to its normal condition, the EaR shows a definite result as such, and also in its temporary behavior with reference to the ability to use the muscles. This result of EaR may, of course, be made use of in drawing a conclusion as to the condition of the nerves and muscles.

Erb has investigated these facts in regard to rheumatic facial paralysis, and by experimental examinations, in a classical manner. He has given representations for the course of rheumatic facial paralysis, which we here insert.

Fig. 162 gives a representation of complete EaR with reference to motility, and faradic and galvanic irritability of the nerves and muscles;

and over it are given the designations of the simultaneous histological changes. The line of galvanic muscular irritability is wavy so long as the qualitative changes (slowness of contraction and preponderance of AnSC) continued.

1. *Paralysis with relative early return of motility.* The first trace of motility appears at a time when there is still complete EaR. One week later the faradic and galvanic irritability of the nerves reappears;

FIG. 162.

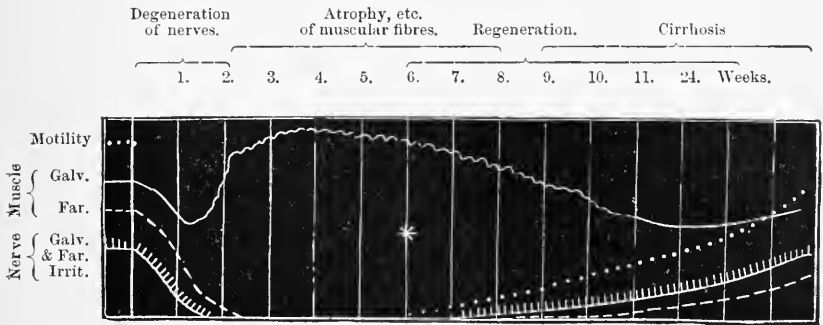

Complete EaR with reference to motion. Faradic and galvanic stimulation of the nerves and muscles. Paralysis with early return of motility. (ERB.)

hence there now is partial EaR; three weeks later, the slowness of the contractions begins to disappear. Diminished irritability of the nerves and motility continues a still longer time.

2. *Paralysis with later return of motility.* Temporarily the condition is like that in Fig. 162. Here, also, there is for some

FIG. 163.

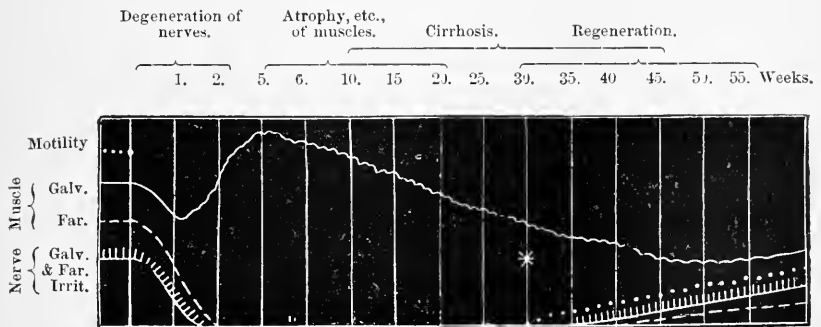

Paralysis with later return of motility. (ERB.)

time a partial EaR. All the evidences of regeneration return again later.

3. *Permanent paralysis.* Motility, irritability of the nerves, and faradic muscular irritability do not return. The galvanic muscular

FIG. 164.

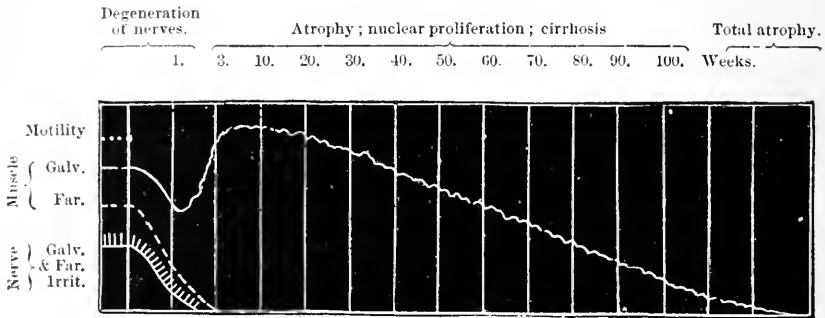

Irremediable paralysis. (ERR.)

irritability in the course of some months becomes *nil*; the contractions, so long as they are still possible, are slow.

FIG. 165.

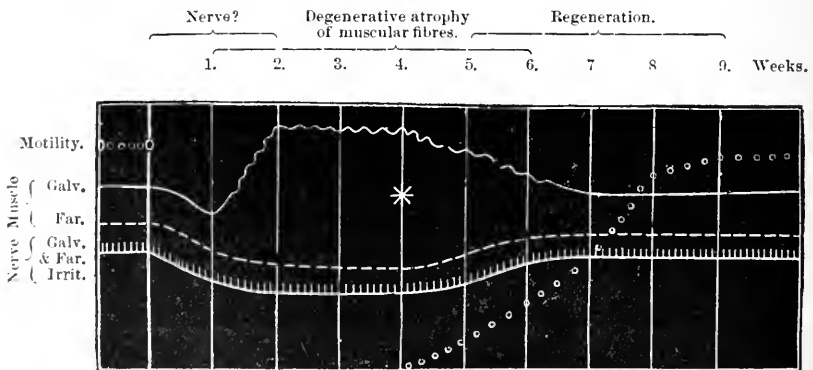

Paralysis in which there is only partial EaR. (ERR.)

4. *Paralysis in which there is only partial EaR.* The faradic and galvanic irritability of the nerves and faradic irritability diminishes only to a slight degree. Motility returns again quite early.

Varieties of EaR.

(a) Partial EaR is necessarily accompanied with slowness of contractions (which are also indirect—Erb). Not only the contractions which occur with direct galvanic irritation of the muscles, but all contractions, including those, also, which occur with galvanic and faradic stimulation of the nerves and faradic stimulation of the muscles, are slow in their character. [“The faradic excitability of the paralyzed muscle undergoes a diminution corresponding to that of the nerve, but the galvanic excitability of the muscles manifests the quantitative and qualitative changes which are characteristic of the severer forms of the reaction of degeneration.”]

(b) The AnSC of the nerves is slow, the CaSC is not (Löwenfeld), or, the muscle has a slow faradic reaction, while the nerve does not respond at all (Stintzing); or, the muscle has a slow, the nerve a prompt faradic reaction, etc.

Stintzing, with the greatest pains, has recently undertaken to bring order out of this confusion with remarkable, although with few, results. Probably it is well to allow the material to still further accumulate before we undertake to interpret it, diagnostically or pathologically.

(c) *Mixed Electrical Reaction.* We thus designate those electrical reactions which occur when a muscle is partly degenerated and partly normal, and a corresponding portion of the nerves is also sound and another portion degenerated. Then we find a diminution, but never a loss, of faradic and galvanic excitability of the nerves and of faradic excitability of the muscles. But the direct galvanic muscular reaction causes the greatest difficulties: the contractions are not exactly short, not altogether slow, AnSC=CaSC, here and there also shorter: it is hard to discover its significance. All of this is not easy to understand, because normal contractions are mixed with EaR; especially difficult is it, if, as is almost always the case, the excitability is lowered. The object is sometimes attained by making repeated, indeed, daily tests (when it seems that EaR often becomes more distinct), by thorough examination of every part of the muscular system with weak as well as with moderately strong currents, frequently changing the location of the indifferent electrode (which must always be done in such a way as to avoid exciting the nerves). A

single clearer manifestation of EaR in one muscle, or in a bundle of muscular fibres, will usually serve as an indication of the whole disease as degenerative atrophic paralysis. It is true that EaR has twice been found in myopathic muscular atrophy in single muscles (Schulte and Zimmerlin). We (with Erb) do not share the opinion of Wernicke that this mixture is the single cause of every case of partial EaR.

2. *Myotonic Reaction* (Erb).

Myotonia congenita occurs in the very powerful (hypertrophic) muscles which always exist with this disease: they show increased irritability and continuance of the contraction with the faradic current; with the galvanic test, likewise, there is increased irritability, but only contractions as the current is closed, and then extremely slow and continuing contractions with peculiar formation of furrows and depressions. Stable acting currents (the stimulating electrode placed not upon the muscle, but on the vasti, for instance, near the patella) produce rhythmical, wave-like contractions from the cathode toward the anode.

The relation of EaR to the so-called mechanical EaR is not unimportant. (See, regarding this, on p. 526.)

3. *Diagnostic Value of the Electrical Condition.*

The reaction of degeneration (EaR) occurs: 1. In all paralyses produced by disease of the ganglion cells of the gray anterior columns of the spinal cord, or of the motor nerves of the bulb. 2. In all paralyses produced by disease of the anterior roots and of the peripheral nerves, where the trophic influence of the anterior horn ganglia fails on account of the interruption of the conduction, peripherally, in the nerve and muscle.

The reaction of degeneration (EaR), therefore, is closely connected with degenerative atrophy of the muscles. Thus, it occurs: in poliomyelitis acuta, chronica, spinal progressive muscular atrophy, amyotrophic lateral sclerosis, lesions of a section of the gray anterior horns from hemorrhage, tumors, etc.; bulbar paralysis; in traumatic lesion of the peripheral nerves; in neuritis of all kinds; in "rheumatic" paralyses; in primary multiple neuritis; in toxic paralyses, and those that occur after infectious diseases.

The presence of EaR points directly in opposition to: cerebral paralysis, paralysis from lesion of the pyramidal tract in the spinal cord; further, against myopathic paralysis; lastly, against functional or hysterical paralysis.

Of course, the EaR is to be regarded as contra-indicating the diseases last named, only with the reservation that there is no complication with the conditions first named. Of this character we, with others, consider also the condition of EaR found by Schulte and Zimmerlin with myopathic progressive muscular atrophy [see previous page].

In harmony with the above principles, partial EaR has exactly the same significance as complete. It occurs: 1. In slight affections (as slight forms of rheumatic facial paralysis, slight paralysis of the arm from pressure). 2. In atrophic paralysis, which only affects a portion of the bundles of the muscular fibres, it is disseminated (especially frequent in spinal progressive muscular atrophy, amyotrophic lateral sclerosis, multiple neuritis), and, hence, as a mixed reaction. (See above, p. 523.)

When EaR is absent, sometimes it does not strictly show that there is no affection of the anterior horns or of the peripheral nerves—that is to say, it does not do so if we have to do with a disseminated disease (see Mixed Reaction). EaR may be wanting when there is an existing peripheral paralysis, if it is very slight (very slight pressure-paralysis of the N. radialis, which heals in three to four weeks).

EaR in muscles that are not paralyzed is seen by itself in lead-paralysis and traumatic paralyses.

Lessened excitability, especially of nerves, without EaR, occurs chiefly in myopathic muscular atrophy (*dystrophia muscul.*, Erb), in muscular atrophy from disease of the joints, and in lesions of the spinal pyramidal tracts, especially if recent and very severe. Moreover, it is observed with multiple neuritis, arsenic-paralysis, alcohol-paralysis, bulbar paralysis, amyotrophic lateral sclerosis, etc., and here it is probably to be counted as mixed reaction.

An intermitting general paralysis at intervals of one to four weeks, which lasts for twenty-four hours, with complete or almost complete loss of all electrical reaction, has been observed by Westphal. Its nature is very problematical.

Increased excitability as manifested by early occurrence of CaSC and CaSTe, occurrence of AnOTe, is an extremely important sign of tetanus. Slight increase is observed in cerebral, spinal, recent neuritic paralyses, in progressive muscular atrophy of spinal origin (here a more considerable increase, and this in muscles that are still performing their function).

The increase of galvanic excitability of the muscles with EaR, as well as of the faradic and galvanic irritability of the muscles with myotonic reaction, does not belong here. (For myotonic reaction, see above, p. 524.)

4. *Mechanical Excitability of Muscles and Nerves.*

1. Upon striking a muscle with a percussion-hammer, we see that a short contraction occurs, like a CaSC with a tolerably weak current. We find these contractions increased and usually quite decidedly slow in those muscles which show electrical EaR: "mechanical EaR." If distinctly present, this shows the same thing as the electrical EaR; but, often enough, it either fails or is not distinct, while the electrical examination proves the existence of EaR.

Increased mechanical excitability with energetic, but slowly declining and prolonged contractions (to as much as thirty seconds, Erb), are peculiar to myotonia congenita. [See p. 524.]

For those who are experienced, mechanical excitability is not without its value as a preliminary starting-point. But it cannot be a substitute for the electrical test.

2. Idiomuscular contractions are transverse prominences which appear locally at the spot where the muscle is struck—thus far without any diagnostic significance.

3. Mechanical excitability of the nerves (striking upon the trunk of the nerve at the point of electrical stimulation) has individual differences. In many healthy persons mechanical irritation does not cause any contraction at all. The mechanical excitability of the nerves—but not of the muscles—is very much increased in tetanus (especially in the branches of the N. facialis).

4. Charcot has discovered that a peculiar form of over-excitability of the nerves and muscles is characteristic of the lethargic stage of hypnosis in very hysterical persons: pressure upon the nerve or muscle causes contracture.

We mention here, further, the peculiar and obscure phenomenon of paradoxical contractions (Westphal): In passive dorsal flexion of the foot there occurs a tetanic contraction of the tibialis anticus which lasts from a few seconds to several minutes; the tendon of the muscle becomes prominent, the foot—even when it is no longer held—remains dorsally flexed. It frequently occurs in connection with increased tendon reflex.

5. *Coördination and Ataxia.*

In all motions there is necessarily a more or less complicated concurrent action of a number of muscles. For example, in order to seize anything with the hand, not only are a series of muscles of the arm, hand, and finger moved, but at the same time, or a minimum of time before, the scapula, as a fixed point for the arm, must be steadied; moreover, from the free attitude of the body, the shifting of the centre of gravity, brought about by the motion of the arm, must be equallized by the contraction of the muscles of the trunk and legs, and the equilibrium must be maintained—a proceeding which, it is evident from what has just been said, cannot be sharply defined. Hence, in order that the hand may attain its object, and in order that it may attain it in the shortest way and with a steady motion, a very exactly defined number of muscles must contract at the right instant and with the finest adjustment of energy. This correct selection of muscles, and their regulation as to time and gradation of activity, is called *coördination*. It is acquired by practice by means of conscious and unconscious direction of our motions; and it is preserved by an oversight which is continually becoming less conscious and more unconscious, and which all our motions acquire.

Children at first are ataxic in grasping things as well as in walking. The acquired coördination in walking can be partly lost again from long-continued severe sickness.

The processes for acquiring and for maintaining coördination are certainly very diversified. Coördination will be acquired by the corrections which will be suggested by sensible irritations of all kinds, caused by the motions that are made and conducted to the central organs: the eye sees, the ear (as of the violinist and others) hears—the motion itself or its effects, the sensibility of the skin, the whole

totality of deep sensibility furnishes information—and the correction depends upon the sense of power of the muscles, which gives unconscious information regarding the intensity of the work accomplished each time by the muscle. In this acquisition of coördination the conscious will participates in many ways: in maintaining coördination it recedes very extraordinarily, and gives place to an unconscious influence of the motions by centripetal influences. But, if necessary, it may at any moment take hold, and even with a contrary effect to that intended, in that the unusual, new agent of the regulation of the will disturbs the coördination which went on successfully before unconsciously. A person says, "I will make it particularly beautiful," and just at that instant he becomes awkward. This happens, not only with nervous and embarrassed people, but also with those who are very calm: under the control of the will, they suddenly perform a motion which has long been automatically made.

Now there is scarcely any doubt as to the nature of the centripetal influences, but where and how they bring their influence to bear upon the motor tract is very far from being clear. Voluntary motions certainly proceed to a certain extent from regulation derived from the cortex (where the complex motions, like those for speech, must exist), but certainly still other portions of the brain, which probably act as reflex centres, have an influence upon this regulation (thus especially the cerebellum for the motions of the trunk and legs); and lastly, no doubt the gray anterior horns have a part in directing the continuity of motion: they preside over the tonus of the muscles, the antagonizing tension constantly in action during activity; they are the seat of tendon and skin reflexes. That all these things have an influence upon the continuity of motion seems to us (as well as to many others) cannot be doubted. But, likewise, there is no doubt that the various centripetal influences upon coördination, to a very great extent, may act vicariously for one another: when there is the loss of the conscious skin and muscular sensibility, in the disappearance of centripetal stimulation, they call forth the muscular tonus, the more attentive regulation of the cortical innervation (with the assistance, for example, of the eyes) replaces the loss of constancy; that, on the other hand—for instance, in the case of the blind—the exquisite superficial and deep sensibility (conscious as well as unconscious) must become prominent. But now,

if coördination can no longer be maintained, then with its disturbance there occurs *ataxia*. It is clear from the foregoing that *ataxia* may exist at the same time with perfectly normal vigor; indeed, it has nothing whatever to do with native strength.

Ataxia shows itself according to its degree only with delicate, or it may even with gross, functions. It usually occurs as an excess of innervation in the sense of directing motion, or as a want of restraint (*tabes*): swing of the legs in walking, putting the feet down as if stamping, or only a clumsy way of moving the feet when turning around (as in closing the door of one's room); thus, on account of the uncertainty, the legs are spread out in standing and walking; impossibility of describing a circle with the foot when lying in bed, inability to exactly place the heel upon the knee of the other leg; when endeavoring to take hold of anything, the hand misses it, as in the effort to take hold of one's own nose, in executing with the hand the finer movements of all kinds. In other kinds of *ataxia* there are other kinds of uncertainty, without this character of missing the mark, or the *ataxia* of the legs and trunk manifests itself by reeling. The control of the eyes sometimes diminishes the *ataxia*, sometimes not; the first is often the case in *tabes*. Most *ataxic* patients accordingly show a noticeable inward consciousness with every ordinary voluntary motion (as walking), quite in contrast with persons in health [see p. 480].

Ataxia occurs: (*a*) In cerebral affections, and particularly those of the cortex; here with paresis, confined to a limb or one-half of the body; with lesions of the vermiform process of the cerebellum, of the crura cerebelli, and of the pons and the corpora quadrigemina; and lastly, in individual cases in ordinary hemiplegia, if there is slight spasm. (*b*) Especially in *tabes*, where *ataxia* is the most important symptom, sometimes after disease involving the whole thickness of the spinal cord. (*c*) Rarely, and generally to a slight degree, in diffuse peripheral neuritides. (*d*) Rarely as a highly developed disturbance after acute infectious diseases. On the contrary, traces of *ataxia* after long confinement to the bed, especially after acute diseases, are not at all rare. Coördination is then temporarily and only partly lost.

For details regarding the different theories of *ataxia*, especially those in regard to *tabes dorsalis*, see the different special works. It is our

opinion that only one source of coördination has always been assumed, in a somewhat one-sided way, by the advocates of the several views.

6. *Spasms of the Voluntary Muscles.*

We gather together under this designation all those pathological motions existing outside of the influence of the will, so we must go very much beyond the popular literal idea of "spasms." But this cannot very well be avoided unless we purposely wish to divide the subject very minutely. First, then, a few general remarks:

Tonic spasms are those lasting some time—from minutes to days and weeks—and are symmetrical. *Clonic spasms* are contractions of short duration, followed by relaxation of the affected muscles. All, with the exception of some forms of trembling, are phenomena of irritation derived from the nervous system; and, in fact, chiefly from the cortex, pyramidal tracts, the anterior horns of the spinal cord, some probably also from the peripheral nerves (also from the muscles themselves: paralysis agitans, contractions of fibrillæ). The pathological irritation is probably generally a direct one, but certainly also partly reflex; and, indeed, there is no doubt that the same kind of spasm may be caused by direct as well as reflex influences—as partial traumatic and reflex epilepsy. Many kinds of spasm consist of motions that are always similar—many combined from a few, and sometimes from a great many.

Spasms are partly the intrinsic element of the given disease, the thing of which the disease consists; partly they are a symptom; and then again they may be a local sign, that is, they may point directly to the seat, or point of origin, of the disease. Often we must determine other phenomena (as paralysis, etc.) for the purpose of discovering the point of origin.

With certain spasms, especially those that are paroxysmal and general, the condition of self-consciousness at the time of the attack is of great diagnostic importance. Also we often have to consider the general mental condition, for many cases of convulsions lead us over into the territory of psychiatria.

We now only mention the different kinds of spasm:

Trembling (tremor) consists of unproductive motions, often only to be seen by close observation, rapidly following one another. We

recognize them partly by observing the limb when at rest, partly when the hand is stretched out, or is holding a glass of water, and also by the handwriting.

Graphic representation shows that the different forms of tremor differ in the form, frequency, and rhythm of the contractions. Trembling is physiological with bodily exertion, and with mental excitement, and it is sometimes constant, even with persons in good health. Upon the borders of the normal stand the tremors of the aged, *tremor senilis*. *Alcoholic tremor*, especially of the extremities and tongue, occurs with the passing away of the effects of the indulgence, or when it is declining; the *tremor saturninus*, the tremor which affects morphia-habitues when they abstain from it, that with *morbus Basedowii* (generally very fine, rapid movements, sometimes also coarser contractions), and the tremors of nervous individuals, are the finer kinds of tremors.

The tremor of *paralysis agitans* (especially of the extremities, but also of the head) manifests itself by a symmetrical rhythm, by a very characteristic position of the hand and fingers ("pill-maker"). It ceases when voluntary motions are made, especially if vigorous, but sometimes even when writing.

On the other hand, the intention tremor occurs only with voluntary motions, in that toward the end of the motion it becomes stronger; it stops as soon as the patient is quiet. It is an important symptom of multiple sclerosis; it occurs, however, as tremor mercurialis. In many cases it is difficult to distinguish it from ataxia (which see).

Between "tremor" and "clonic spasms" it is not possible to draw a precise distinction. The designation *shaking-spasm* is used for the transition forms of both. The prominent transition forms of this kind of tremor are those shiverings which begin with fine tremors, becoming constantly coarser with cooling off, and with rapidly-rising fever; with hysteria there are conditions that resemble tremor. Likewise is to be mentioned the quaking which occurs with marked active spasm of the legs, as especially takes place sometimes after mechanical irritation; foot clonus, particularly, often shows these transition forms very beautifully.

In the foregoing we have not distinguished between the tremors of spasm and those of paralysis, because in regard to most kinds of tremors it is not yet clear to which of the two classes they belong.

For further points regarding this subject, see the several special works.

Fibrillary contractions are contractions in individual coarse or fine bundles of muscular fibres which do not produce motion in the limb. In individual cases, however, we can observe a very diminutive motor effect. They are easily recognized by observing the muscle. In health they are often excited (with great individual differences) by the cooling of the skin; but they also occur with atrophic paralysis, and very abundantly, and hence are not without diagnostic value, in spinal progressive muscular atrophy.

Clonic spasms rarely occur by themselves, but they more frequently accompany epileptic and other attacks of convulsions (see below). We sometimes observe them isolated in local affections of the cortex of the brain (see below, Partial Epilepsy); but also in other localized cerebral diseases, and in myelitis transversa, as single brusque bending motions of the legs, generally both legs together—probably of reflex origin.

Tonic spasms, by themselves, occur most frequently in the form of active spasms (see above, p. 494), in lesions of the pyramidal tracts, and with hysteria. Moreover, they occur in tetanus, and in these forms: as masseter spasms in trismus; this latter also by itself; as rigidity of the face, *risus sardonicus*; extension of the vertebræ with rigidity of the neck and opisthotonus, and in spasms of the legs in the state of extension. Moreover, tonic spasm of the muscles occurs when first moving them after long rest, and as a prolonged condition after voluntary contractions in myotonia congenita; also, occasionally, as bending and adduction spasms of the arm and hands in tetanus; as the tonic form of writers' cramp, although seldom purely as such, generally with slight contractions mixed with tremor; and in the first stage of epileptic attacks (see below).

Epileptic spasms, in genuine epilepsy, generally pursue a typical course: after certain subjective warnings (aura), or without these, there is a sudden loss of consciousness, ushered in with a cry, and immediately the patient falls down. Then there is a short tonic spasm of all of the voluntary muscles (more especially of the extensors of the arms, legs, vertebræ, but the hands are closed and the thumb is grasped by the fingers); then there is clonic spasm, with frightful vigor, of all the muscles of the body, including the muscles of the eyes, tongue, etc.; after a few minutes there follows, either gradually or

suddenly, a period of relaxation with continued loss of consciousness—post-epileptic coma. During the attack, the tongue is often bitten, involuntary discharges take place, and, from the interference with respiration, marked cyanosis often occurs.

It is very important to make a differential diagnosis between genuine epilepsy and symptomatic, which often very much resembles the former. The latter occurs in all manner of anatomical diseases of the brain (regarding partial epilepsy in disease of the cortex of the brain, see below), as traumatic and reflex epilepsy, as epileptiform spasms in uræmia, these latter also as eclampsia gravidarum.

There occur in children, upon slight provocation, epileptiform or eclamptic attacks during dentition, from intestinal irritation from worms, in the beginning of acute infectious diseases, as scarlet fever, measles, pneumonia, and in the beginning stage of acute poliomyelitis and encephalitis.

It is generally very difficult to form an opinion regarding spasms from the anamnesis. Here we must be very cautious in arriving at a diagnosis.

Partial epilepsy (Jackson's or cortical). In this there are epileptiform convulsions which are limited to an extremity or to the facial muscles of one side. They are an almost infallible sign of disease located in a corresponding part of the cortex of the brain, and also are connected with or followed by paresis, increased tendon reflex, and sometimes by disturbance of the sensibility of the affected limb (monoplegia). The convulsions may be unilateral or even general, but they manifest themselves as originally partial epileptic, by beginning in the affected limb.

Hysterical convulsions (attacks of hystero-epilepsy) sometimes have a great likeness to epilepsy; yet almost always the motions may be distinguished in that they are more wide-reaching [and tumultuous], and more than all by the fact that they partly manifest coördinated motions, or remind one of them. Motions such as we see made by a person senselessly furious, or an unruly child, are not at all infrequent; especial manifestations are fits of laughing, shouting, weeping, coughing.

The most important mark of difference between hysterical and epileptic spasms, in doubtful cases, is that in the former there is almost never an entire loss of consciousness; very often it remains quite

intact; and the absence of involuntary discharges (urine, stool, in males also of semen), as is not infrequent with genuine epilepsy; lastly, the tongue is not bitten, and there is reaction of the pupil during the attack.

Gross [severe] hysteria. The attack of hysterico-epilepsy may pass into a second stage [“phase des grand mouvements” of the French] of contortions, and excessive movements—among others, especially that of the “arc de cercle” (head bent backward, boring into the pillow; the trunk bent as in opisthotonus)—which may last for hours, are characteristic manifestations; then there may follow a third stage, which is either quiet or may be excited (delirium)—the stage of hallucinations and of emotional attitudes. The stages may occur singly.

Besides what has already been described, it is important for diagnosis that there should be present *hysterical signs* (stigmates hystériques), manifested by the patient in the form of sensory anæsthesia, especially a concentric limitation of the field of vision; also, hemianæsthesia; hysterogenous zones—that is, hyperæsthetic regions of the body (ovaries, testicles, circumscribed portions of the skin), the irritation of which by pressure sometimes causes an attack or is associated with one.

Constrained positions and motions. To the former belong the drawing of the head or trunk to one side, so that the patient assumes the side position in bed (sometimes with the eyes fixed; *déviacion conjugée* occurs with the other manifestations); to the latter belong the involuntary forward, backward, and movement in a circle (*manègegang*). Both phenomena indicate a lesion of the vermiform process of the cerebellum or of the median crus cerebri.

With the constrained motions, or the “coördinated spasms,” are also to be reckoned the gross motions previously mentioned under hysteria, as laughing, screaming, etc.

Chorea minor. This is the designation given to the very rapid, lightning-like, entirely irregular muscular contractions, which, on the one hand, produce restlessness of the limbs and of the face; and, on the other, disturb and divert the regular voluntary motions. They affect the head (face, tongue, masticating muscles) of the trunk, especially of the shoulders and legs, and sometimes the glottis. They occur in all degrees of severity, from single weak jerks to the most extravagantly confused strong movements (*folie musculaire*). If the

subject is embarrassed, especially if observed, frequently the contractions are increased. During sleep (but there may be difficulty in getting to sleep), the convulsions entirely disappear, excepting in particularly severe cases.

Chorea minor is not often purely one-sided, or hemichorea. Hemichorea may occur either as the forerunner or as the result of hemiplegia, when it indicates a lesion of the posterior section of the inner capsule or of the optic thalamus. Especially frequent are choreic or athetose motions (which see), with declining acute encephalitis in children (poliencephalitis, Strümpell) in the paralyzed limbs. Quite recently, Flechsig has found both internal segments of the lenticular nucleus diseased in several cases of severe general chorea with delirium.

Athetosis [described by W. A. Hammond]. This designates peculiar, slow, and at the same time tolerably energetic motions, particularly of the hands, arms, shoulders, but also anywhere else. If the motions are somewhat quicker than, but resembling, those of chorea, they then form a transition to the latter. Athetosis, as well as chorea, is a disease in itself; hemiathetosis is observed in the same cerebral locations as hemichorea (which see). In the cerebral paralyses of children it is more frequent than hemichorea.

Associated movements are abnormal involuntary motions, which take place with the performance of voluntary motions by the contractions of muscles in regions which have nothing to do with the motions desired. We find them especially in cerebral, but also in spinal, and even in peripheral, paralyses; hence they cannot be made use of as an aid in diagnosis. Sometimes we see them in muscles of the same limb as that put in motion. Particularly frequent is a dorsal flexion of the foot when the leg is drawn up to the abdomen, as in hemiplegia, spastic spinal paralysis (Strümpell), or in unilateral affections, as synonymous associated movements of the sound side with those of the diseased side, or of the diseased side with the sound side.

Catalepsy, cataleptic rigidity, flexibilitas cerea, is a peculiar increase of the tonus of the voluntary muscles, of such a character that the limbs not only offer only a very slight or feeble resistance in passive motion, but also remain in a given position, even when it is opposed to gravity, and this sometimes for an hour and more at a

time. Catalepsy very rarely occurs in anatomical diseases, as tumors of the brain and meningitis; more frequently in hysteria, especially in hypnosis, and in certain psychoses, as in *melancholia attonita*.

7. *Voluntary Muscles, their Innervation, their Function, and the Diseases that Disturb Them.*

1. *Muscles of the eye* (see Examination of the Eye).

2. *Muscles of the face*, supplied by the N. facialis:

M. frontalis draws up the brow and causes wrinkles across the forehead.

M. corrugator supercil. draws the skin of the forehead over the roots of the nose into folds.

M. orbicularis palpebrarum closes the eyes.

M. depressor nasi seu dilator narium dilates the nostrils.

M. levator lab. super. (propr.) and M. levator anguli oris lift up the upper lip and the corner of the mouth.

M. zygomaticus major raises up and draws out the angle of the mouth.

M. buccinator makes the cheeks tense, holds open the pouch of the cheek when eating, prevents the distention of the cheeks when blowing or when whistling (to a slight extent supplied by the trigeminus?).

M. orbicularis closes the mouth; is the chief factor in whistling, pronouncing the consonants b, f, m, p, v, w, the vowels o, u (greatly assisted by the levator menti).

Paralysis of the facial: The forehead is smooth and remains so upon the affected side when the effort is made to wrinkle it; the eye remains open and cannot be closed (lagophthalmus); the naso-labial furrow is obliterated; the angle of the mouth hangs down; the mouth, and often also the tip of the nose, are drawn toward the sound side; the effort to expose the teeth, as in cleansing the teeth, makes very plain the defective elevation of the upper lip and distortion of the mouth. When blowing, the affected cheek is distended; on attempting to whistle, the lips are drawn to the sound side; if the paralysis is unilateral, the labials are generally, except in recent paralyse, pronounced distinctly; if bilateral, they cannot be. (See further, Soft Palate, Hearing, Taste.)

3. *Muscles of mastication, tongue, soft palate, pharynx.* Mm. temporalis and masseter (N. trigeminus branch III.) draw up the lower

jaw and press the teeth together. Mm. pterygoidei effect the sideways movement (rotation) of the lower jaw.

Paralysis of these muscles will be recognized by the absence, upon one or both sides, of these motions; bilateral paralysis of the temporalis and masseter, by the dropping down of the lower jaw. Palpation below the zygoma detects possible paralysis and atrophy of the masseter; above the zygoma, paralysis and atrophy of the temporalis by its laxity.

We pass over the complicated arrangement of muscles which draw down the lower jaw, because their paralyse have not yet been sufficiently studied.

The tongue is stretched out—that is, it is drawn forward by the two Mm. geniohyoglossi, which act somewhat convergently, and is drawn back chiefly by the two Mm. styloglossi; M. hypoglossus principally draws it down. These, and the inner lingual muscles, produce the changes in the form of the tongue.

Unilateral hypoglossal paralysis: When the tongue is protruded it deviates toward the paralyzed side, because the genioglossus of the sound side pushes it that way. Bilateral paralysis (generally atrophic) causes diminution of all the motions, even to their complete obliteration; difficulty in mastication and swallowing; and in the formation of the consonants c, d, g, k, l, n, r, s, sch, x, z, and of the vowels i [e], e [ā]. Unilateral paralysis produces all these disturbances to a slight degree, and they become less with habit. Atrophy, seldom unilateral, will be recognized by diminution in the volume, by wrinkles, and sensible thinness.

The soft palate derives its principal innervation from the sphenopalatine ganglion (N. petrosus superfic. maj., and from the ganglion geniculi of the facial nerve. The fifth and the tenth and eleventh ganglia also take part).

Examination: by inspection and phonation—i. e., by observing the voice and inspection, and by the swallowing of fluids.

Unilateral paralysis of the soft palate in paralysis of the facial located high up, shows deviation of the uvula toward the healthy side and depression of the arch of the paralyzed soft palate, both more distinctly in phonation. In the passive state, the relaxed uvula may hang to one side, even when there is no paralysis. Sometimes the speech is nasal, and fluids may escape from the nose in attempting to

swallow. Both symptoms are due to ineffectual closure between the nose and the mouth: pharyngeal space. In bilateral paralysis, especially with bulbar paralysis and as diphtheritic paralysis, the soft palate hangs down without any power to contract; and nasal utterance and the difficulty in swallowing are increased.

The pharyngeal muscles (N. X.-XI.), with the aid of the tongue, accomplish the act of swallowing. When they are palsied, this act is disturbed, and, from the lack of vigor and promptness in passing the food along, it easily enters the larynx: thus, there is coughing in connection with swallowing. But if the patient is unconscious, or there is at the same time disturbance of the sensibility of the larynx (N. laryngeus super. vagi), there may be no cough.

4. *Laryngeal muscles.* The muscles supplied by the laryngeus super. vagi are: depressors of the epiglottis; Mm. thyreoepiglott., aryepiglottici (paralysis: difficulty in swallowing), and the M. cricothyreoides, tensors of the vocal cords by movement of the thyroid cartilage toward the cricoid cartilage (paralysis: hoarse voice).

N. laryngeus inferior (recurrent branch of the N. X.-XI.): Mm. crico-arytænoïd. postici dilate the glottis (bilateral paralysis: inspiratory dyspnoea, sometimes of the severest kind, with the voice unchanged or very slightly impure). Mm. thyreo-arytænoïdei are the most important tensors of the vocal cords (paralysis: loss of voice and hoarseness).

Musculi arytænoïdei transversi et laterales: they narrow the posterior portion of the glottis (in isolated paralysis: the voice is very hoarse, as in catarrh, hysteria). Mm. crico-arytænoïdei laterales: in connection with the preceding they narrow the glottis.

Complete paralysis of the recurrent: (a) unilateral (compression by aortic aneurism, carcinoma of the œsophagus, mediastinal tumors; bulbar paralysis): voice hoarse, easily changing to the falsetto, or little or even not at all altered; (b) bilateral (rare): complete aphonia, inability to cough.

(Regarding the laryngoscopic examination, see Appendix.)

5. *Muscles of the throat and neck.* M. sterno-cleido-mastoideus (N. XI.) draws the head and face toward the opposite side and looking upward; both together somewhat bend the neck and push the head forward: or, if the head is the fixed point, they lift up the sternum or the clavicles, as in emphysema. The test of their function and

recognition of their paralysis and spasm is easy. When both are paralyzed, the neck, and with it the head, incline backward.

The muscles that stretch, bend, twist the neck or the head (nervi cervical. I.–IV.), maintain the head in the upright position. If they are weak or paralyzed, it is impossible to hold the head up: it falls forward, if it is not exactly balanced. This happens, if the head is too heavy (hydrocephalus). Defective mobility of the head is more frequently caused by spasm or inflammation (stiff-neck, caries of the cervical vertebræ), than by paralysis.

6. *Muscles of the trunk.* Muscles that move the vertebræ (innervated by Nn. dorsales and lumbales).

Lumbar extensors and extensors of the lower vertebræ: M. erector trunci (sacro-lumb. et longissim.) with bilateral action.

Bending forward: the abdominal muscles.

Bending of the lower vertebræ sideways: quadrati lumborum.

Twisting the trunk: semispinalis and multifidus.

Paralysis of the erector trunci: (a) bilateral: the body is bent backward (lordosis of the lumbar, kyphosis of the upper thoracic, vertebræ, in such a way that the latter overhangs the sacrum; a plumb-line held from it falls behind the sacrum); the pelvis is tilted up, the knees are bent. (b) Unilateral: in standing, a scoliosis of the lower vertebræ is convex toward the diseased side; on the other hand, there is a compensatory scoliosis of the thoracic vertebræ.

Paralysis of the abdominal muscles: marked lordosis of the lumbar and lower thoracic vertebræ, compensatory kyphosis of the upper thoracic vertebræ, but these are exactly vertical over the sacrum. There is marked inclination of the pelvis.

In paralysis of the extensors, it is impossible to place the bent trunk in an unsupported upright position; it is accomplished by placing the hands upon the knees and thighs. If, in addition, there is paralysis of the glutei, especially of the gluteus maximus, then the patient can only rise from the floor by first getting down on "all fours," then pushing himself up with the hands from the floor, in order immediately to put them upon the knees and thus further support the body: this is his way of standing up. In paralysis of the flexors, it is impossible to sit up from the dorsal position without assistance.

Opisthotonus is produced by spasm of the extensors, *emprosthotonus*

by spasm of the flexors: unilateral spasm of the extensors causes scoliosis, convex toward the diseased side.

7. *Muscles of the thorax, diaphragm, and abdomen.* Here belongs most of what has already been said upon p. 81ff. There we learn regarding the ordinary and the auxiliary muscles of inspiration and the auxiliary muscles of expiration.

Paralysis of the diaphragm (phrenic nerve, chiefly from the fourth nerve of the [deep] cervical plexus) in perfect quiet, may be entirely compensated by the thoracic muscles of inspiration; but otherwise every increased requirement for breath produces marked dyspnoea; and this is exactly the case with respect to the vicarious action of the diaphragm when there is defective thoracic breathing. It will be understood, then, that paralysis of the auxiliary muscles of respiration has only a bad outlook for the breathing when it comes to such a pass that they must be called upon (see p. 96).

Tonic and clonic spasm of the thoracic muscles of inspiration in tetanus and epilepsy at once cause severe cyanosis; in the first disease it may be fatal; also tonic spasm of the diaphragm interferes very much with breathing and may be dangerous to life. Clonic spasm of the diaphragm (singultus, hiccough), in a mild form, is not infrequently seen; if it continues for hours and days, as it sometimes does in abdominal and cerebral affections, then from the disturbance of the rest, and severe pain along the line of insertion of the diaphragm, it may bring about a serious condition.

By the contraction of the abdominal muscles the anterior abdominal wall is flattened, and thus the abdominal cavity is lessened; by the simultaneous contraction of the diaphragm there arises "the abdominal pressure," which is important in defecation and emptying the bladder, and the expulsion of the child in labor. The rôle of the rectus and obliquus externus, as flexors of the vertebral column (when those of one side act alone, the trunk is bent laterally forward over on one side), has been already mentioned, as well as their function in active expiration.

8. *Muscles of the upper extremity.*

(a) Muscles which move the shoulder-blade or fix it: M. trapezius (N. accessorius for the most part) raises the shoulder-blades and draws them toward the middle line, both of these by the middle and posterior parts. The former chiefly lifts up the acromion, the latter the inner

upper angle. With its anterior clavicular portion it inclines the head obliquely backward and at the same time lifts up the acromion. *Paralysis* of the trapezius permits the scapula to drop down, to be drawn away from the middle line, and at the same time to turn round so that its apex moves toward the spinal column (because the levator scapulæ holds up the upper inner angle). The shoulder sinks downward and forward; there is difficulty in raising the upper arm, because the scapula is not so perfectly fixed, and shrugging of the shoulders is restricted. From what has been said the test of its function is easy.

M. levator anguli scapulæ (N. dorsalis scapulæ from the cervical plexus) lifts up the scapula by its inner upper border, with the tendency to turn the right scapula in the direction of the hands of the clock, and the left in the opposite direction. Its *paralysis* can only be recognized when the trapezius is paralyzed at the same time, by the complete inability to lift the shoulder.

Mm. rhomboideus major et minor (N. dorsalis scapulæ) draw the shoulder-blades toward the spinal column, and thus lift them in the same way as the levator scapulæ and turn them in such a way that the lower angle of the scapula is nearest the spinal column. They fix the scapulæ, especially in backward motions of the arms and legs, and when lifting weights. *Paralysis* [of these muscles] moves the scapula, and particularly its lower angle, away from the spinal column. Moreover, it is difficult to detect paralysis of these muscles when the trapezii are normal.

M. serratus anticus (N. thoracicus longus seu posterior, Henle, from the brachial plexus) turns the scapula in such a way that the lower angle moves outward, draws it somewhat away from the spinal column, and presses it against the thorax: it is an important fixation-muscle of the scapula when the arms are lifted. When the scapula is fixed (by the rhomboidei) it is a muscle of inspiration. *Paralysis* of the serratus, in the condition of rest, causes a slight elevation and rotation of the scapula, so that the lower angle stands out a little from the thorax and is (slightly) drawn toward the spinal column. The arm can be lifted up to the horizontal sideways: this moves the inner border of the scapula close up to the vertebral column. It can only be raised higher by fixing the scapula in the same way as would be accomplished by the serratus. When the arm is moved forward, the inner border of the scapula stands out like a wing.

(b) Muscles of the trunk and of the scapula [attached] to the upper arm :

M. deltoïdes (N. axillaris at the infraclavicular portion of the brachial plexus); the middle portion extends the arm outward from the body, the anterior portion raises it obliquely forward, the posterior portion obliquely backward. It raises it as far as the horizontal, beyond which, the arm being fixed by the deltoid against the scapula, it is raised by the rotation of the scapula. *Paralysis* is easily recognized: If the muscle is relaxed, there is subluxation of the humerus, particularly if at the same time the supraspinatus is paralyzed; if the deltoid is atrophied, the contour of the bones at the shoulder shows plainly.

M. supraspinatus (N. suprascapularis from the supraclavicular portion of the brachial plexus) assists the deltoid in raising the arm outward toward the front, rolls it inward, it is also said to hold the head of the humerus in its socket when the arm is raised.

Mm. infraspinatus (N. suprascapularis) and the teres minor (N. axillaris) roll the upper arm outward.

M. subscapularis (N. subscapularis from the brachial plexus) is a rotator inward. *Paralysis* of a rotator allows the arm to rotate in the opposite course; in testing, we first make passive rotation, and letting the arm fall, allow it actively to do the same thing, while we oppose the rotation.

M. pectoralis major (N. thoracic. anti. of the brachial plexus) adducts the upper arm; when the arm is raised up, it moves it forward in the horizontal plane, draws the arm down when it is raised. *Test*: Have the upraised arm moved forward in a horizontal plane while we offer resistance.

M. latissimus dorsi (N. thoracico-dorsalis from the brachial plexus) draws down the arm when it is raised up in exertion, [it depresses it] and draws it backward. When the arm hangs down it draws it backward and inward [toward the buttock]. *Test*: The arm is raised to the horizontal and the effort is made to lower it while the movement is opposed. The teres major materially assists the latissimus; it is at the same time a rotator inward.

Mm. coraco-brachialis (N. musculo-cutaneous of the median) and anconeus longus (cap. long. tricipitis; N. radial.), when the arm is

drawn down by the latissimus and pectoralis, hold the head of the humerus up and firmly in its socket.

(c) Muscles from the upper arm to the forearm :

M. triceps (N. radialis) is an extensor of the forearm.

M. brachialis internus (N. musculo-cutaneus) is a simple flexor.

M. biceps (N. musculo-cutaneus) flexes and supinates.

M. supinator longus (N. radialis) flexes and pronates. This is proved by having the moderately pronated forearm flexed while the movement is resisted. If it is healthy, it rises up like a hard roll on the outer side of the elbow-joint.

We here next mention the pronators: the pronator teres (it is at the same time a flexor) and quadratus, both supplied by the median nerve.

(d) Muscles which extend from the condyles of the humerus and the bones of the forearm to the hand and fingers, and the small muscles of the hand :

The extensor carpi radialis longus and brevis (N. rad.) + extensor carpi ulnar. (N. rad.) are elevators of the hand. The flexor carpi radialis (N. median) + flexor carpi ulnaris (N. ulnar.) are volar flexors of the hand; the palmaris longus (N. median.) assists in this action.

The extensor carpi radialis longus + flexor carpi radialis adduct the hand in the direction of the radius. Extensor carpi ulnaris + flexor carpi ulnaris adduct the hand on the ulnar side. If the extensor carp. rad. long. acts alone, it raises the hand obliquely on the radial side, as the ext. carp. uln. does on the ulnar side.

Paralysis of the extensors of the hand (or especially lead-paralysis, also sleep-paralysis of the N. radialis) allows the hand, when the forearm is pronated, to hang loosely down. Paralysis of the abductors and adductors and also paralysis of the extensores c. radial. long. and carpi ulnaris alone, produces oblique position of the hand [paralysis from the former giving a position opposite to that of the latter]. We test the individual movements by successively opposing them.

M. extensor digitorum (communis indicator, exte. digiti V., all from the N. radial) extend the first phalanges.

M. flexor digitor. comm. sublim. (N. median.) flexes the middle phalanges; M. flexor digitor. comm. prof. (N. media, the two ulnar bellies from N. ulnar.) flexes the terminal phalanges. Mm. inteross. dors. + volares (N. ulnar.) and Mm. lumbricales (N. med. and ulnar.)

flex the first phalanx and at the same time extend the middle and terminal phalanges.

Mm. inteross. dors. alone abduct (spread apart), volares alone adduct the (middle: third) finger.

Movements of the thumb: extensor pollic. long. (N. rad.) is essentially an extensor of both phalanges; extens. poll. brev. (N. rad.) is an extensor only of the first phalanx. Adductor poll. long. (N. rad.) abducts the metacarpus. Flexor poll. long. (N. med.) flexes the terminal phalanx. At the thenar are the opposing muscles—abductor poll. brevis, outer head of the flexor brevis, and the opponens poll. (all from the N. med.). Adductors: adductor pollicis and the inner deep head of the flex. brev. (both N. ulnar.) These two and the abductor brev. flex the first and extend the terminal phalanx.

The adductor, flexor, and opponens act at the hypothenar, their names indicating their action. All are innervated by the N. ulnaris.

Characteristic positions of the hand and fingers: 1. In paralysis of the ulnar there is the clawing, clutching hand, *main en griffe*: the first phalanges are extended, the middle and terminal ones flexed (paralysis of the interossei), the thumb hangs helpless over the hand (paralysis of the adductor); the fingers are easily spread out (action of the extensores digit.). Thus the interosseal spaces on the dorsum are deepened, likewise the groove between I. and II. metacarpal bones (atrophy of the adductor pollicis, deep head of the flexor brevis and inteross. dorsi I.). The hypothenar is atrophic. 2. In paralysis of the thenar (deep median paralysis) there is the ape-hand: the thumb does not stand out opposing, but is parallel with, the other fingers.

Paralysis of the extensors of the hand causes apparent weakness of the long flexors of the fingers, because the origin and insertion of the flexors are brought near together by the flexion of the hand at the wrist. Hence, we must passively extend the wrist and then test the flexion of the fingers. For the same reason it is necessary, when there is paralysis of the long extensors of the fingers, to passively extend the first phalanx before testing the flexion of the middle and terminal phalanges.

Examination. We observe the position of the hand for possible atrophy. Then we test extension, flexion, abduction and adduction at the wrist—sometimes all of these—by resisting these motions; then the extension of the fingers; next the long flexors by “hooking” of

the fingers; then let the patient make the separate motions of the interossei muscles; flex the first phalanx with the middle and end phalanges extended; then spread out and close the fingers; test the muscles of the thenar and hypothenar by bringing the thumb and little finger into contact; lastly, the examiner places his own index finger in the saddle between the thumb and the second metacarpus, while the patient makes simple adduction of the thumb, thus testing the power that is manifested. Pressure of the hand is a very practical way of making a general test of the long flexors and the small muscles of the hand.

For such paralyses as are not wholly diffuse, but rather confined to individual muscles or groups of muscles, peripheral and certain spinal paralyses, it has value only as a preliminary examination. For various reasons we consider the dynamometer as an unnecessary apparatus and one that does not accomplish its purpose.

It cannot be sufficiently insisted upon that in order to establish the diagnosis exactly in the upper extremity, and particularly in the hand, beside a clear conception regarding the location and physiological action of the muscles, there must be a knowledge of their innervation. We observe, especially, how the ulnar and median are distributed in the small muscles of the hand. The former innervates the hypothenar, interossei, the two ulnar lumbricales, and the adductors of the thenar, adductor pollicis, and the deep head of the flexor brevis; the latter, the remaining muscles. In the hand, the radial only supplies branches to the skin.

9. *Muscles of the lower extremity.*

(a) Muscles from the pelvis to the thigh:

M. ileo-psoas (N. crural from the lumbar plexus) flexes the hip-joint; it is assisted (and in the sense of pure flexion) by the action of tensor fasciæ latæ (N. gluteus super from ischiadic plexus). In paralysis of the psoas, or of this and the tensor fasciæ, it is not possible to flex the thigh either in walking or in bed; paralysis of the tensor fasciæ alone permits the pure psoas action to take place: flexion with rotation outward.

M. gluteus max. (N. glut. inferior or plexus ischiad.) extends the thigh; when the thigh is fixed, it brings the pelvis to the horizontal position, and thus the trunk to the vertical (into the upright from the stooping posture, standing upright, etc.). When it is paralyzed, there

is the peculiar kind of action in rising from the floor described on page 539, with paralysis of the extensors of the trunk.

M. gluteus medius (N. glut. sup. from the plexus ischiad.), abductor; *M. gluteus minim.* (same nerve) rotates the thigh inward. The three glutei are the most important supporters of the pelvis.

M. pyriformis (plex. ischiad.), *M. obturator, int.* (N. ischiad.), *M. gemelli* (N. ischiad.), *M. obturator exter.* (N. obturat., plex. lumbal.), *M. quadrat. femor.* (N. ischiad.), are all, in reality, out-rotators.

M. adductor long., brev., magn., pectineus and *gracilis* (N. obturat., plex. lumb.), are, for the most part, adductors, at the same time partly flexors. The effect of their paralysis is clear.

(*b*) Muscles from the pelvis and the femur to the leg:

M. quadriceps (N. crural.) extends the leg; its long head, the rectus, arises from the pelvis (anter. infer. spine), and hence acts with more power when the thigh is in a position of extension with reference to the pelvis. In paresis of the quadriceps, the leg (or possibly both legs) in walking are frequently set forward, flexed more markedly at the knee-joint (the leg during the forward movement of the limb hangs vertically down), and this is true also when it is set down quickly, so that there is a sort of snapping of the knee-joint into the position of extension. The examination is best made by endeavoring to flex the limb when it is actively extended.

M. sartorius (N. crural.) is probably chiefly an inward rotator of the flexed leg.

Mm. biceps fem., semitendinos., and *semimembranos.* (N. ischiad.) flex the knee-joint; the first rotates the flexed leg outward, the second inward. If the limb is powerfully extended by the quadriceps, then these flexors, as well as the *gluteus max.*, act: they place the pelvis in the horizontal position (important in walking).

(*c*) Muscles from the leg (or the condyles of the femur) to the foot and toes:

M. gastrocnemius, soleus, plantaris (N. tibial.) are extensors; that is, are plantar flexors of the foot, and, at the same time, adductors of the extended foot.

Mm. peroneus long. and brev. (N. peroneus) are extensors (chiefly the first) and adductors of the foot, lift up the outer border of the foot. In paralysis of the peronei muscles (by "peroneus-paralysis" we mean paralysis of the whole peroneus nerve: see below, under *M. tibialis*

antic.); the foot in extension, as well as flexion, stands in the position of adduction and the outer border of the foot is deeper; the foot becomes flat. It is not easy to test the activity of the peronei: we must first show the patient the movements of abducting and lifting up the outer border of the foot by passive movements, and then have him repeat them; besides, we have the patient extend the foot: in paralysis of the peroneus longus decided adduction then takes place.

M. tibial. ant. (N. peroneus) flexes; that is, dorsally flexes and adducts the foot; M. extensor digit comm. and extens. halluc. long. (N. peron.) flexes and adducts the foot, extends the toes. Paralysis of the dorsal flexors causes the point of the foot to drop when the foot is lifted from the floor. If the peronei are likewise paralyzed (peroneal paralysis; that is, paralysis of the peroneus nerve), then the foot is lax at the ankle-joint; the point of the foot hangs down, with inclination to adduction. In walking we observe that the foot, as it is raised from the floor, makes a peculiar shuffling motion inward, and it is set down in a fumbling manner. Persons with unilateral, isolated peroneal paralysis are always inclined to take a longer step with the disabled limb in order to obtain the sweeping motion required for the awkward placing of the foot upon the floor.

M. tibial. postic. (N. tibial.) is an adductor.

Mm. flexor digitor. comm. long. and brev. (N. tibial.) are flexors of the middle and terminal phalanges of the toes; Mm. interossei externi interni (N. tib.) are flexors of the first, extensors of the middle and terminal phalanges—interossei externi. [The outer three muscles are abductors of the second, third, and fourth toes, respectively, while the first is an adductor of the second toe, and assists the plantar interossei.]

Paralysis of the interossei causes a peculiar kind of claw-position exactly analogous to that of the fingers (see p. 544).

M. extensor halluc. longus (N. peron.) extends the first phalanx of the great toe; Mm. adductor, flexor brevis, abductor hallucis (N. tib.) act essentially in accordance with their names: they produce simultaneously flexion of the first and extension of the terminal phalanx. Paralysis of the flexor of the great toe hinders one in walking, but especially in springing.

DISTURBANCES OF SPEECH (LALOPATHY).

I. *Dysarthria and Anarthria.*

By these expressions we understand those disturbances of speech in which we see it altered in the same way as the activity of a joint is distributed as to its motility: by paresis, paralysis, trembling, spasm, and even ataxia of the vocal muscles.

Unilateral paralysis of the muscles of speech occurs in unilateral affections of the pyramidal tract above the medulla oblongata, or of the cortical centre of the motor speech muscles; likewise in peripheral paralysis of the hypoglossus and facial nerves. At first the speech is decidedly disturbed; if these affections continue, there occurs a considerable improvement in the speech, as if it were re-acquired by practice. Bilateral paralyzes generally occur from the bulbus of the oblongata (bulbar paralysis), and are then, if they are ganglion paralyzes, degenerative-atrophic. It is rare to have bilateral speech paralysis from bilateral cortical or pyramidal lesion (pseudo-bulbar paralysis). We also rarely have a bilateral paralysis of the hypoglossus or facial nerves of peripheral origin.

For the muscles that produce speech and their innervation, see above, pp. 536 and 537. Depending upon which muscles are paralyzed, the disturbance of speech may vary with different letters, as mentioned at the above-named place. We recognize slight anarthritic disturbances of speech by requiring the patient to pronounce difficult words quickly, especially such as contain many consonants. Simultaneously with this disturbance of speech, the voice, from paralysis of the palate, is often nasal (or also a kind of "clod-voice"), or the voice has a monotone, or it is inclined to change to a falsetto. (Regarding swallowing, see p. 537.)

Scanning speech: sounding like the speech of a rider of a horse that is trotting; there are sharp changes of rhythm, unnatural pauses, sudden, "explosive," and then, again, snapping pronunciation of words. It is particularly characteristic of multiple sclerosis.

Hysterical dumbness is a complete loss of speech and generally also of the voice, which occurs suddenly, and generally after an attack of hysteria, which lasts anywhere from days to years, and may suddenly disappear. The mobility of the tongue is normal.

II. *Aphasic Disturbances, Disturbance of Graphic Communication (of Mimicking, of Singing).*

In order to understand these conditions it is necessary to make some explanations regarding the acquisition and use of speech, of writing, etc.

Speech and its related functions have their foundation in the cultivated memory, which is acquired by much practice, and for the mother tongue in childhood. We acquire such a development of the memory:

1. For speech in the narrow sense, and it comprises:

(a) Cultivation of acoustic memory, acquaintance with the sound of words by hearing letters, words, and sentences spoken by others.

(b) Cultivation of the motor memory, the complex motions used in speaking words, by imitating what we hear, trying to produce the same by correcting what the organs of speech produce until we attain the desired degree of perfection, and we treasure up [in the memory] the complex motions which are required for accomplishing what is desired.

2. The memory for writing comprises the cultivation of the optic memory, the acquisition of writing, and the complex motor writing-motions—again by imitating what we see.

Likewise, we develop the comprehension and reproduction of music, a very individual faculty; of mimicry, and of gestures, varying according to the nationality.

Simultaneously with speech, or always somewhat later than imitation of what is heard, ideas develop—the concrete first; upon the foundation of the concrete, the abstract.

Now, we suppose that the cultivation of the *sound of words*, and of their *form*, also the *complex motions for speaking* as well as *writing* them, these four to be accumulated each at its own place in the brain-cortex; but that, presiding over all, yet not concentrated at one place, but as the result of innumerable functions, with numberless tracts connected with the cells of the brain-cortex, is the mind—*intelligence*. The representations of memory, and the complex motions (which are likewise representations of memory), can only functionate the nervous tissue—that is, can only be represented as tones, chords, a series of tones and chords of a violin.

And in fact they can be innervated:

1. From the representations of the sound of words: these come from the periphery through the sense of hearing. If we hear the mother tongue (or any other language which we know), from the conception, we inwardly pronounce the words.

2. From the written representation: from the periphery—that is, from the organ of sight, if we read in a known language; and from the conception, if we inwardly represent to ourselves the printed or written word.

3. From the complex motions of speech: from the centre representing the sound of words by virtue of the imitative instinct—repetition; and from the mental conceptions—*independent utterance of thought.*

4. From the complex motions of writing: from written words, by virtue of our imitative instinct—*copying*; from mental conceptions—*writing out the thought.*

But still, this is not all: the impulse to produce the complex motions of speech may come from the written or printed representation—we read aloud. On the other hand, the impulse to make the complex motions of writing may come from what is heard—we write from dictation. Further, while we are speaking or writing, there comes along the muscular sense an innervation (going in a centripetal direction) of the complex motions of speech or writing. We can make this clear if, with the eyes closed, we have someone else move our hand, as if writing a word: by this means, without other assistance, we can recognize simple words. In a still higher degree, also, in the *active motions* of writing and speaking the report of what is written or spoken—that is, the contractions of the muscles taking part in these acts, and the motions produced by them, go centripetally to the brain.

The conceptions of musical notes seem to coördinate those of word-sounds, while the complex motions for producing speech and those which produce music (melody and rhythm)—that is, for singing—are co-ordinated with the larynx and mouth. The conceptions of musical sounds are intimately connected with those of word-sounds, and the complex motions required in singing are connected with those required in speaking. The intimateness of this association appears very distinctly in the fact that when a melody happens to come to mind we hum the words belonging to it; or, if the words come first, then we hum the

melody. Sometimes this humming is a purely automatic act, for both the text and the melody are articulated involuntarily together. But, again, sometimes the internal re-sounding follows the articulation or act of listening, and from this internal impression the articulation is first produced.

Now, to these innervations there belong tracts of communication. Those conducting from the periphery to the "sensory" centres, leading to the centres for conceptions of sound and writing, we understand very well—the acoustic and optic nerves. Further, there must exist very manifold combinations between the conception and the four different centres themselves [mentioned on p. 550], but it is very difficult to obtain an exact presentation of these combinations.

For instance, Kussmaul supposes that the tract from the centre of ideas to that for the complex motions of speech goes through the portion which takes note of the sound of the word; hence he assumes no direct innervation of the centre of the complex motions of speech from that of ideas. Likewise, there is a dispute whether there is a direct communication from the written representation, or whether there is a communication with the centre for the complex motion of writing, etc., only through another centre. We will only bring forward one instance, for the sake of illustration. The following acts, done without understanding by persons in health as well as by sick persons—repeating, reading aloud, copying, or writing from dictation—make it plausible that direct communication exists between the sensory and motor centres, which, therefore, do not go through the centre for ideas. But there is no doubt that, in regard to this, there are very considerable individual differences, particularly dependent upon the degree of cultivation and the intelligence.

Of course, we also understand the tracts which peripherally lead from the "motor speech- and writing-centres"—they go through the pyramidal tracts, the bulbar nucleus, to the individual motor nerves; and, finally, we have a general presentation, at least, of the tracts which pass centripetally from the muscles and joints.

These very different qualities, acquired by practice, may each singly or several together be lost. When the organ of hearing remains perfectly intact, the innervation from the periphery of the conception of the sound of words—that is, the ability to understand the words of one's native tongue—may be lost: there is *word-deafness* ["inability to

understand spoken words, although they are heard as sounds, while printed or written words are understood"—Billings], loss of intellectual perception of sounds. Even when the muscles of speech are perfectly normal, the ability to employ language, to express one's ideas through the innervation which results in the complex motions necessary to make use of the appropriate word in the native language, may be lost: motor or ataxic aphasia (or, as Kussmaul designates it, "the purest form of ataxic aphasia"). The arm may be in perfect condition, and yet we may not be able to write; or the eyes may be intact, and yet we cannot read—*agraphia*, *alexia*. But since the different capacities under consideration—the understanding and formation of words, the understanding and production of writing—are in a very manifold way connected with each other, these disturbances almost never occur singly, but as a complex of disturbances.

The expressions—"acoustic amnesia" for word-deafness, "*visual amnesia*" for loss of intellectual perception of sounds—seem to us to be very useful, more so than the German designations formed upon a different principle. The only objection is that these expressions may be confounded with the idea of amnesia discussed later on (p. 554).

The study of these things has proceeded from the observations of the disturbances of speech in the narrowest sense, that is, of speaking (Boilliaud, M. Dax, Broca). For this reason, and because all disturbances that come under consideration apply to speech in the broader sense (spoken and written speech, with reference to its comprehension and production), we class together, not at all incorrectly, all the conditions under consideration, by the designation of *aphasia*, *aphasic disturbances*.

We only mention now those two manifestations which may be most sharply distinguished, while for all the details we refer to the special works (see, also, the "schema" of Lichtheim).

1. *Word-deafness* (Kussmaul), *sensory aphasia* (Wernicke). The two ideas are not wholly identical. Special works show this more at length. The patient hears every word, but it sounds to him as any healthy person hears a word that belongs to a language which is wholly strange to him. The mother tongue, so far as the understanding of the hearer is concerned, has become a foreign, unknown tongue; also, ability to repeat and to write from dictation is wanting.

But, again, sometimes the understanding of writing may fail (*alexia*), and with it the ability to read aloud (see p. 558).

But, in opposition to this, the power of volitional writing and to copy written characters, and further, volitional speech, is preserved. Nevertheless, we generally observe a disturbance in this also: very often the wrong words are used, because words that are related by sense or sound are, from unrestrained association, pronounced and strung together (*paraphasia*); or, it may be distinctly noticed that the correct words are employed, but they are distorted by repetition of syllables, dropping of syllables, transposition of letters or syllables (*literal aphasia, syllable-stumbling*). Moreover, both conditions sometimes have relation with amnesia ("*amnesic aphasia*," see p. 556).

2. *Atactic aphasia* (Broca's *aphemia*, Wernicke's *motor aphasia*) consists in this, that the patient is unable to communicate his thoughts by words: he cannot name objects presented to him, although he promptly shows that he recognizes what they are in that he knows how to use them correctly; at the same time there is diminution of the power to voluntarily write, or to write down what is heard (or write from dictation): *agraphia*, with the exception of the ability to transcribe from copy, which is usually retained. Thus, in pure cases, there is perfect understanding of what is said and also of what is written, and hence there is neither word-blindness nor word-deafness.

But in one respect the condition of most patients of this character is still somewhat obscure: with reference to the question whether they are able to produce the sound of the word mentally, to conceive of its sound, *i.e.*, to mentally sound the word. According to Lichtheim, it is probable that in most or in all such cases this capacity has also been completely lost. But regarding this point it is very difficult to form a positive opinion with respect to these patients.

We cannot refrain from dwelling a little upon this question. (For further regarding the examination of patients with aphasia, see below.) We must confess that, in these cases, we have found that the method employed by Lichtheim, though it is ingenious, is very uncertain. Lichtheim, in order to determine whether the word which designates the given object is mentally correctly sounded, requires the patient to tell how many syllables there are in the word, or to press the hand as many times as it contains syllables. It is assumed that when an object

is presented to a patient there arises in his mind a conception of the sound. What designation does he think of? I hold up a knife before him—does he think “a pocket-knife” or “knife?”—a drinking-glass: “a drinking-glass” or a “glass?”—“handkerchief” or a “sackcloth?” I admit that there are substances about which there is no doubt, but one would be easily inclined to hold that the number of syllables was wrong, and yet the patient thought he had understood and had spoken correctly.

Slighter forms of atactic aphasia manifest only a slight defect in the command of language: single words are omitted or single words are defectively pronounced: “doltor,” “dolner,” for doctor; “lit,” for lip; I am “benter,” for better, etc.—that is, there is a literal ataxia, syllable-stumbling. But often the patient dwells upon only a few words, or only one, or even a single syllable, which is constantly employed for everything, as was the case with a patient reported by Strümpell, and whom we have watched for years, who could only say, “bibbi, bi-bi-bi-bi.” We also have cases of paraphasia.

An atactic-aphasic patient who, before becoming affected, was a good singer, may lose the power of singing as well as of speaking, and yet the “ear” may be retained: he hears when he himself or some one else sings a false note. But though the speech may be lost, he may still retain the power to sing the melody of a song, and then it may happen that with the melody he may automatically articulate the words to which it belongs, although he cannot articulate them without the melody. In connection with this the reader is referred to p. 550 for what was said regarding the connection between the complex motions of speaking and singing.

There is another disturbance which plays an important part in all forms of aphasia and which presents a special group of symptoms: it is *amnesia, amnesic aphasia*.

The patient presents a perfect picture of a person who is endeavoring to speak a foreign language which he only slightly or very imperfectly understands. An object is held up before him: he is not able to name it; he repeats it without understanding it, or he remarks: “Yes, certainly, that is the word;” or he hits upon the correct word through association, as upon the number of fingers held up before him by counting—“One, two, three, four—correct: four.” This amnesia manifests itself only with reference to certain kinds of words, as for

proper names, or chiefly for those representing the most concrete ideas (Kussmaul).

Amnesia can be mixed with the different forms of aphasia; the former may be very indistinct—even for a time, or continuously, may predominate over the aphasia; but it also occurs in all possible conditions that do not at all belong here: senile dementia, disease of the brain of all kinds, in convalescence from any very severe illness, etc. With Lichtheim we do not count these cases as aphasia.

Localization of the aphasic disturbances. The exact localization of the two important centres of the understanding and use of language is one of the greatest attainments of recent times.

The centre for the complex motions employed in the formation of words, the motor speech-centre, is located in the left third frontal convolution (Broca); lesion of this point causes atactic aphasia. The centre for the formation of sounds, the centre for acoustic recollections, is located in the left anterior central convolution (Wernicke). The right hemisphere has nothing to do with speech, except when the left side is mutilated, when it contains these centres instead of the left.

Further, it is extremely probable, though it cannot be regarded as certain, that the centre for the conception of writing is to be looked for in the optic portion of the cortex of the occipital lobe (both sides or only the left?), and the motor centre for writing in the left second frontal convolution.

Hence, all these centres could lie within the given motor and sensory portions of the cortex: what relation they sustain to these we do not exactly know. We may always conceive of them as groups of cells which are brought into connection by tracts especially “smoothed” by repetition—that is, tracts with peculiarly slight resistance.

Mode of Procedure in Testing for Aphasic Disturbances.

We look for any possible aphasic symptoms whenever there is disease of the brain, but especially with any patient who has had an attack of apoplexy, and particularly when there is right-sided hemiplegia.

It is evident that the examination of these patients is often interfered with, either because of their mental hebitude—dimness of

perception—or the inability to think, and the loss of memory which they exhibit. Those patients can only be exactly examined in whom the general effect of the injury has passed off; and the most interesting cases are those where, after the indirect collective symptoms (see, respecting this, the last section of this chapter) have disappeared, an aphasic assemblage of symptoms remains behind as a unilateral disturbance.

In the first place, we ascertain whether there is amnesia: if the patient can, we have him count, but further we test him by requiring him to name objects placed before him. If he fails to do this, we give him the name of the object and have him repeat it. If he can do so (either with or without apparent understanding), he is not atactic-aphasic, but amnesic. It is to be remarked that occasionally amnesia may simulate all: atactic aphasia, word-deafness, word-blindness, agraphia.

We now proceed to test for possible word-deafness: by conversation, by requiring the patient to do something, as to touch his nose, or by directing him to take something in his hand—a knife, pocket-handkerchief, etc. We must be careful to avoid making any kind of gesture, also looking in the direction of the object named.

Hereupon we look for signs of atactic aphasia: requiring him to speak and to repeat; further for evidences of paraphasia, literal aphasia. If the patient is atactic-aphasic, then we must always make the effort to discover whether he has the internal sense of words (see above).

After these things, we conclude the test by having him read (that is, read with understanding), read aloud, have him write, compose, write from dictation, copy. With persons who were formerly known to have had a musical ear, or could sing, it will be well to inquire whether they retain or have lost these powers, or, especially, what is the relation of the singing of the air and hearing the music to the understanding and speaking of the words that belong to it.

The diagrams serve to display the mutual relations of the four centres to each other and to the so-called “centre of perception.” Many forms have been prepared, of which we mention those of Wernicke, Kussmaul, Charcot, Lichtheim.

These diagrams are very useful for studying this subject (and we especially recommend Lichtheim’s). They are a very excellent guide

for examination, for the clear understanding of the different functions, and as a stimulus to independent thought. But they do not exhibit the actual facts. As a rule, these can never be represented; the individual differences are too great. Charcot rightly distinguishes persons as those in whom either the conception of sound or the conception of writing, or even the mechanical representation of speech or of writing, whichever may be predominant, serves as a guide for speech and writing (and likewise for understanding as well as the production of them). We assume that in speaking as well as writing

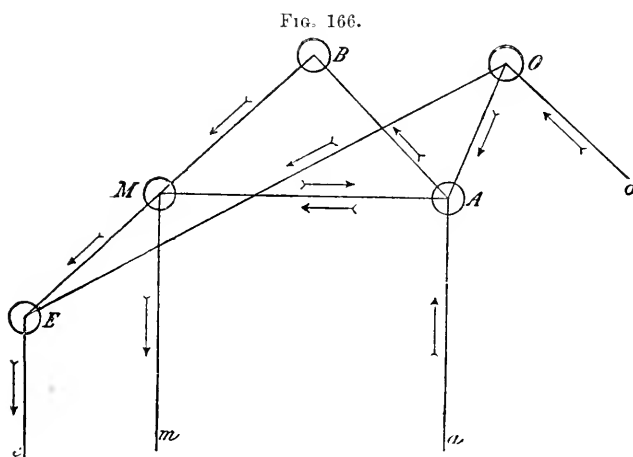

Lichtheim's diagram of aphasia. *A*, centre for conception of the formation of sound (*a A*, conducting tract); *O*, centre for conception of written characters (*o O*, conducting tract); *M*, centre for the motions of speech (*Mm*, the centrifugal motor tract); *E*, centre for the motions of writing (*Ee*, the corresponding motor tract); *B*, centre for conception of ideas. The arrows indicate the direction of innervation.

the mental conception causes an innervation of the centre for sound first, and then this innervates the centre for the complex motions required in producing the effect [of speech or writing]; and further, that, when writing is seen, it must first innervate the centre for sound. Thus there results the understanding of the writing, and hence we can form a conception of what is the significance, to such a person, of the loss of the centre for the conception of sound: a lesion of the temporal lobe. Hence, in our opinion, if we add to Charcot's diagram the centre of cognitions, with its manifold relations, it is the most plausible: it includes all tracts that can possibly exist, and in most

cases of aphasia we must assume that in each individual, while in health, some of the tracts did not exist. Hence, it follows that, from the character of the disturbance, whose location we can know nothing of without an autopsy, much less locate simply from the symptoms, we must draw a conclusion regarding the tract from that one which the patient has made use of in health for the purposes of speech (in its widest sense); and further, from this we must ascertain what centres or tracts are now cut off.

It is plain from this how difficult it often is to judge of these things in an individual case.

First we give Lichtheim's and then Charcot's diagram. After Lichtheim's we add his brief summary of the possible disturbances and their phenomena. This summary does not by any means give an idea of Lichtheim's work upon aphasia. Attention is here urgently called to the special works, particularly to the classical writings of Charcot, Wernicke, Kussmaul, or their pupils, and Lichtheim.

1. Interruption in *M*, the centre for the conceptions of motion or the motor speech-centre (atactic aphasia).

Lost: (a) volitional speech ;
 (b) ability to repeat ;
 (c) " to read aloud ;
 (d) " to write volitionally ;
 (e) " to write from dictation (*e* [in the figure],
 the internal conception of the word-sounds).

Retained: (f) understanding of speech ;
 (g) " of writing ;
 (h) ability to write from copy.

2. Interruption in *A*, the centre for the conceptions of the sounds of words (sensory aphasia).

Lost: (a) understanding of speech ;
 (b) " of writing ;
 (c) ability to repeat after one ;
 (d) " to write from dictation ;
 (e) " to read aloud.

Retained: (f) " to write volitionally ;
 (g) " to write from copy ;
 (h) " to speak volitionally.

3. Interruption of *MA*.

Intact: (a) understanding of speech;
 (b) " of writing;
 (c) ability to write from copy.

But there is (a) paraphasia;
 (b) paraphagia (the same disturbance in voluntary
 writing);
 disturbance of the same kind in—
 (f) repeating after one;
 (g) reading aloud;
 (h) writing from dictation.

4. Interruption of *MB*: modification of motor aphasia.

Lost: (a) power of voluntary speech;
 (b) " " writing;
 —as in atactic aphasia.

But intact are not only

(c) understanding of speech;
 (d) " of writing;
 (e) ability to write from copy;
 but besides (f) " to repeat what is said;
 (g) " to write from dictation;
 (h) " to read aloud.

5. Interruption of *Mm*: modification of motor aphasia.

Lost: All speech; everything else intact.

6. Interruption of *AB*.

Lost: (a) understanding of speech;
 (b) " of writing.

Disturbed: (c) volitional speech: paraphasia.

Retained: (d) " writing;
 (e) ability to repeat what is said;
 (f) " to read aloud;
 (g) " to write from dictation.

7. Interruption of *Aa*.

Lost: (a) understanding of speech;
 (b) ability to repeat what is said;
 (c) " to write from dictation.

Retained: (d) power of volitional speech;
 (e) " " writing,

- (f) understanding of writing;
- (g) ability to read aloud;
- (h) " " to write from copy.

We now introduce Charcot's diagram without further explanation. Apply Lichtheim's Case 1 to it: it will be seen that in those cases which show that representation of symptoms perfectly (Broca's aphasia), it must be assumed that *M* is diseased; but further, that in

FIG. 167.

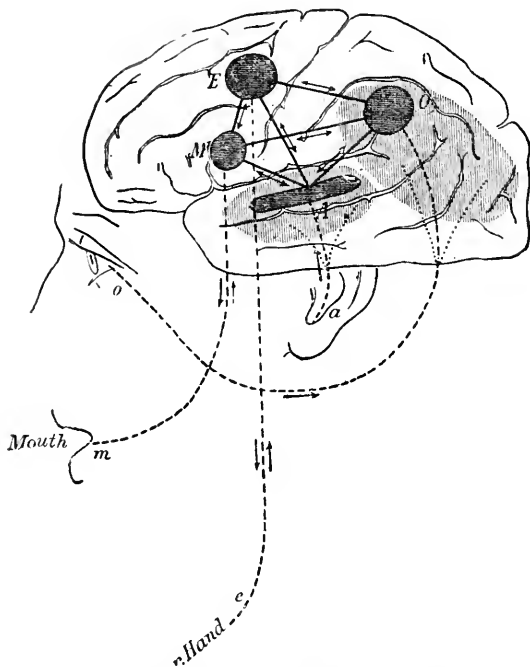

Charcot's diagram of aphasia. Drawn by Marie (*Prog. méd.*, 1883). The designations are the same as in Lichtheim's diagram. The centres are represented as being in those centres of the cortex where they are to be looked for; the light hatching around *A* and *O* indicate the general acoustic and optical field in the cortex. Notice the double arrows upon all connecting lines between *A*, *O*, *E*, *M*. Also notice the arrows pointing centripetally toward *M* and *E*, where the stimulation going to *M* and *E* cause the motions of speech and writing. In our opinion there is to be added the centre for ideas, which should have a twofold connection with *A*, *O*, *E*, *M*.

health the connection had passed from *E* to *A* only through *M*; and still further, that for arbitrary innervation of *E* it must have previously gone from *M*, or from *A* through *M*.

As an addendum, we add here a few remarks upon the diagnostic value of the character of the writing :

(a) Writing is the expression of thought, and in so far as this is the case it is a very fine test for recognizing psychical disturbances of all kinds. (See the text-books upon Psychiatria.)

(b) As was mentioned above, agraphia belongs to the group of aphasic symptoms, and, in fact, it occurs in those forms which are completely analogous to disturbances of speech in the narrow sense: as total, as partial agraphia, as paraphagia, or literal agraphia. Likewise, it was previously stated that a sharp distinction was to be made between volitional writing, writing from dictation, and copying. Also, the loss of the capacity to form strictly grammatical sentences, to make a correct sequence of words (agrammatismus, akataphasia), shows itself in the writing also, or still better than, in speaking.

(c) Motor disturbance of the right upper extremity manifests itself in many cases in a very characteristic way in the handwriting: the different kinds of trembling, ataxia, the different varieties of writers' cramp. It is also worthy of note that patients with paralysis agitans very frequently write naturally because, as is well known, their trembling ceases when making intentional motions.

The value of the handwriting for diagnosis here consists chiefly in the fact that we may recognize early slight disturbances (the contour wavy): ataxia manifested by the strokes going beyond bounds, especially by the imperfections of the large letters.

In paralytic dementia the writing, as well as the speech, is extremely copious. This shows the psychical disturbances: delirium with exaltation or dementia; there is agrammatismus, akataphasia, paraphagia, especially literal paraphagia in an extraordinarily high degree; lastly, there may be motor disturbances of the upper extremities, trembling, ataxia.

SENSE ORGANS.

The Eye.—In considering the relations of the diseases of the eye to internal diseases, those in connection with the diseases of the nervous system are of very much the greatest importance.

We find the eyes, or the function of sight, sympathetically affected in diseases of the nervous system in a great variety of ways. We

observe disturbances which exhibit the more or less direct results of disease of the nerves or of the brain. They are: paralyzes (less frequently spasms) of the outer and inner muscles of the eye; disturbances of the different qualities of vision itself, from lesion of the sensory tract at any point from the optic nerve to the cortex; neuritis optica (choked disk), which, on the other hand, may itself cause disturbance of vision. Other conditions, which are coördinate to the diseases in which they occur, oppose these conditions. They are of extremely varied character. We mention, as examples: atrophy of the optic nerve in tabes dorsalis, multiple sclerosis, embolus of the central artery of the retina with simultaneous embolus of the fossa of Sylvius, syphilitic iritis or retinitis in syphilis of the brain.

Likewise, the disturbances of the apparatus of vision, occurring with any other internal diseases, may be either coördinated conditions or sequent phenomena of those diseases. Of the former category we name as examples: choroidal tuberculosis in acute miliary tuberculosis, retinal hemorrhage in general hemorrhagic diathesis (sepsis, pernicious anæmia), the various manifestations of syphilis, etc. As a sequent phenomenon we have embolus of the retinal artery in endocarditis aortæ or mitralis, possibly cataract with diabetes mellitus, etc.

We give these instances in order to show in how great a variety of ways the disturbances of vision may occur as symptoms of other diseases. In what follows we cannot classify the subject-matter according to the points of view mentioned above. We rather proceed in accordance with the course of an examination of the eye.

1. *Movements of the eye.*—As is well known, these take place, in part at least, in a very complicated way, by the coördinate action of the muscles of the eye. Paralysis or spasm of the outer muscles of the eye causes a defective motion of the eye and disturbs its binocular motion, which we designate as *strabismus*. If the strabismus is due to spasm, it is present in all positions of the eye; but if dependent upon paralysis, then it has a different relation. In slight paralysis (paresis) of a muscle, strabismus only occurs when a motion of the eye is made which is in a considerable degree dependent upon the co-operation of the muscle paralyzed; on the other hand, in more marked paralysis, strabismus may be almost always present. It is only absent when the eyes are brought into a position which corresponds with an especially marked relaxation of the paralyzed muscle.

In long-continued paralysis of one or more muscles of the eye, contracture of the antagonizing muscles also takes place; in consequence of which condition, strabismus is always, or almost always, present. *Lateral strabismus* is designated as *divergent* or *convergent*, according as there is a divergence, or an abnormal convergence, of the axis of vision.

The direct result of strabismus is double-vision, or *diplopia*. This results from the fact that, in fixing an object whose image only falls upon the macula of the normal eye, it falls, in the one whose muscle or muscles are paralyzed, to one side of the macula, and at varying distances from it, according to the degree of the strabismus and the distance of the fixed object from the eye. In consequence of the double image, the determination of the position of an object in space, and with it the judgment of the patient with reference to his own position, is disturbed. Hence, primarily there is difficulty in taking hold of objects and in walking; there is dizziness (vertigo of the eye), and this is most marked when there is diplopia in looking downward (paralysis of a rectus inferior, of an obliquus superior). But after long-continued strabismus double vision disappears, for the patient learns to voluntarily shut out the abnormal eye.

If it happens to be a case where there is paralysis or spasm of the muscles of both eyes which effect the conjugate motions of the eyes (as the rectus internus of the right and the rectus externus of the left eye), then we speak of paralysis of the conjugate muscles of the eyes (or spasm of these muscles); for the position of the eyeball we employ the designation *conjugate deviation*.

Paralysis of all or of almost all of the muscles of an eye results in protrusion of the ball—*exophthalmus paralyticus*. Marked or total paralysis of the oculomotorius produces, beside the paralysis of the eye (see below), also *ptosis* (depression of the upper lid), dilatation of the pupil, paralysis of accommodation (paralysis of the levator palpi sup., of the sphincter of the iris, of the muscle of accommodation).

Deviation of the eye in which the paralysis or spasm is located is termed the primary deviation. In cases of paralysis there occurs in the normal eye a so-called secondary deviation, if we have the patient cover the normal eye and then have him look with it at an object which has been fixed by the diseased one. (Upon this subject, see works upon the Eye.)

We employ our own individual judgment in determining a paralysis of the muscles of the eye, by controlling the position of the eye of the patient while he is looking at a distant object and from the accommodation, also, especially by motions of the ball sideways, upward and downward; moreover, we test the patient by having him look at objects in different directions, and then question him as to double vision and in what relation the objects stands to one another.

Mode of procedure in determining double vision. We hold up a finger about a metre from the patient, move it up and down, to the right and then to the left, and hold the finger steadily in the position in which the patient has a double image, and then have that position described by him. Then we suddenly close one eye: the patient now declares which image has disappeared. In this way we determine to which eye each one of the double image belongs. Or, we take a lighted candle as the object of vision, and alternately cover an eye with a piece of colored glass, and then, of course, the image presented to this eye is colored. (For further regarding this subject see works upon the Eye.)

In regard to the significance of double vision, it is first to be stated that when the balls diverge the images are crossed; when there is abnormal convergence, they are on the same side (on the side of the convergence). All the rest follows from what will now be said where we collate the function of individual muscles of the eye and the effects of paralysis.

M. rectus externus (N. abducens), rolls the eye outward. Its paralysis, according to its degree, produces convergent strabismus, which is manifest either in looking straight ahead, or in looking only toward the side whose external rectus is affected. The double vision is also upon that side.

M. rectus internus (N. oculomot.), rolls the eye inward, antagonizing the preceding. When it is paralyzed the in-rotation of the ball is imperfect; there is divergent strabismus, crossed double vision.

M. rectus super. (N. oculomot.), rolls the eye upward and at the same time a little inward. Rectus super. + obliq. infer. together cause upward motion of the ball. Paralysis of the rectus sup., limits the motion upward; the abnormal eye stares downward and a little outward: there is double vision when looking upward; the image of the paralyzed eye is superimposed upon that of the other.

M. rectus inferior (N. oculomot.), rolls the ball downward and slightly inward; acting with the obliq. sup., there is simple downward motion. Paralysis of the rectus infer.: in looking down, the paralyzed eye does not move, but remains directed upward and a little outward; there is double vision, with one image above the other, the lower being that of the abnormal eye.

M. obliq. infer. (N. oculomot.), if it is paralyzed, in looking upward we have the action of the rectus sup. alone: the eye turns somewhat inward. There is double vision upon the same side, one image is above the other or they are side by side, particularly in looking upward.

M. obliq. super. (N. trochlearis), if this is paralyzed, then in looking down the rectus inferior acts alone, turning the eye somewhat inward. There is double vision upon the affected side, especially when looking downward.

Some of these paralyses, if they occur singly, can be easily recognized, and this is especially true of those of the recti. But when several are combined, particularly if the obliqui are involved, there is often the greatest difficulty in making out the exact lesion. A combination which may occur frequently is a paralysis of all the muscles supplied by the oculomotorius, with which we may then also have the internal muscles of the eye involving the levator palp. sup. With this total paralysis of the oculomotorius the eye is rotated outward (the action of the abducens), there is some exophthalmia, the pupil is dilated and remains so in the presence of light, and there is absence of power of accommodation.

By *nystagmus*, or oscillation of the eyeball, we understand very slight clonic jerking motions of the ball. They are generally conjugate. If they take place in a horizontal direction, then we speak of horizontal nystagmus. It is often most distinct in fixing the eyeball, but particularly with marked rotation movements of the balls sideways or in a vertical direction.

The diagnostic significance of paralysis of the muscles of the eye varies very much: paralysis of several muscles of only one eye always points with considerable probability to the base of the brain, or to the orbital fissure and orbit, and this is particularly apt to be the case if, at the same time, there is evidence of a lesion of the optic nerve (disturbance of vision, unilateral choked disc). Progressive paralysis of

the muscles of both eyes, sometimes ending in total paralysis of these muscles, indicates a progressive nuclear paralysis (ophthalmoplegia externa). It is difficult to estimate the symptomatic value with reference to the topical diagnosis of conjugate deviation. When it is present we should always first think of the possibility of a lesion of the posterior corpus quadrigeminum or its neighborhood; but aside from this, conjugate deviation occurs with all kinds of local disease of the brain, especially if recent. Hence, if the deviation is due to paralysis, we infer that the line of vision is toward the same side, but if it is a conjugate spasm, the line of vision is toward the opposite side. In the latter case the head is very often drawn to that side. Paralysis of the oculomotorius of one side and of the extremities of the opposite side (crossed paralysis) points with great certainty to a lesion of the crus cerebri, and this corresponds with paralysis of the third nerve. We can immediately understand this fact if we recollect that the N. oculomotorius dexter passes to the right crus cerebri at its base—that is, it passes alongside of the pyramidal tract belonging to the left side of the body.

2. *The pupils.*—We do not concern ourselves with those changes of the pupil which belong wholly in the province of diseases of the eye (especially in connection with iritis).

We are to consider the size, or the changes in the size, which result from certain circumstances. When the iris is normal, the size is regulated by the action of two antagonizing muscles: the sphincter pupillæ (N. oculomotorius) and the dilator pupillæ (N. sympatheticus).

(a) The size of the pupil. Contracted pupil, *myosis*, occurs in health during sleep, likewise in old age. Otherwise myosis is always a sign which must awaken suspicion, and indeed is especially frequent in tabes dorsalis (see below, Reflex rigid pupil); and, also, although more rarely, in progressive paralysis. The degree of the illumination also has a marked effect upon the size of the pupil (if from reflex action it is not rigid, see below under *c*). Hence, it is to be examined under moderate illumination. Dilatation of the pupil, *mydriasis*, occurs with marked disturbances of consciousness, severe pain (see below under *c*), with atrophy of the optic nerve, paralysis of the M. oculomotorius; lastly, sometimes with tabes and progressive paralysis.

Effect of poisons. Atropine, duboisin, cocaine, dilate the pupil; eserine, pilocarpin, morphia, contract it. These effects upon the pupil are, in connection with other symptoms, employed for diagnosis in cases of poisoning with any of these substances.

(b) Inequality of the pupils sometimes occurs with persons in health, also in people with unequal refraction in the two eyes (with myopia: mydriasis; in hypermetropia: myosis); but, otherwise, inequality of the pupils is a suspicious symptom. It occurs in unilateral affections of the brain of all kinds (thus, especially with hæmatoma of the dura), with unilateral paralysis of the oculomotorius, of the opticus (dilatation), and in tabes; besides, it frequently occurs in attacks of migraine (irritation, paralysis of the sympathetic of the affected side).

(c) Reflex changes in the size of the pupil. The pupil contracts in the presence of light from the contraction of the sphincter (the reflex arc [composed as follows]: (a) the optic nerve; (b) optic tract; (c) probably the anterior corpus quadrigeminum; (d) oculomotorius). The test is made either in a light room by covering the eye with the hand and then suddenly withdrawing it, or in a room with a dim light by quickly going to the light (more certain). In either case the patient must not employ any accommodation, hence must look at a distant object (see below, converging motion). It is best to test each eye singly by alternately closing one. Sometimes there is an indication for testing the crossed ("consensual") reaction: we observe the changes in the pupil of the right eye, while we vary the light which enters the left, and *vice versâ*. (Regarding hemiopic pupillary reaction, see below.) In old age the reaction of light is physiologically slow.

Pain, as painful irritation of the skin (pinching, Faradic brush), dilates the pupil through the action of the dilator. The reaction is slower and less marked than from light.

Absence of reaction is the term used for "reflex rigid pupil" (Erb), both "to light" and "to pain." This absence of both reactions often goes hand-in-hand, especially in tabes, where Erb in 84 cases found 59 instances (= 84.5 per cent.) of absolutely rigid pupils, or (more rarely) very feeble reaction. At the same time there was always reflex rigidity with reference to pain; and, further, in 37 cases (= 52 per cent.) simultaneous myosis. Reflex rigidity is less frequent in progressive paralysis; but there rarely ever occurs any other abnor-

mality of the pupils (myosis, mydriasis, inequality, slow reaction of rigidity) in this condition.

The reaction of light also fails in atrophy of the optic nerve, and in complete paralysis of the oculomotorius. But it does not fail *in central blindness*, hence not in cortical hemianopsia. Moreover, when testing in this case, the light from the side where the field of vision is defective must be brought nearer, so that it may only fall upon the half of the retina which is cut off from the centre (see p. 569). Reaction of light takes place in the diseased eye in unilateral optic atrophy when the normal eye is illuminated; on the other hand, reaction of light is not retained in the diseased eye in unilateral complete paralysis of the oculomotorius, as is evident from the course of the reflex arc.

(d) Contraction of the pupil in convergence of the eyes, or from accommodation, may not take place in paralysis of accommodation (this most frequently after acute diseases, particularly diphtheria), but it may also be retained. This contraction of the pupils during accommodation has its chief diagnostic significance in the fact that it must be avoided when testing for the reaction to light or pain—that is, it is generally retained with reflex rigidity of the pupils.

3 *Testing for the central sharpness of vision, the color-sense, and the field of vision.*

(a) We test the sharpness of vision by means of Snellen's plates, which contain test-letters of different sizes, the number of which is represented by the distance in metres at which a normal eye can read the type. After correcting any possible anomaly of refraction in either eye, they are placed at a distance at which it can read the test-letter X. The sharpness of vision is expressed by a fraction whose denominator is the number on the plate, and whose numerator is the distance at which it can be read. According to the above, in normal vision the denominator and numerator must be alike: the fraction then is always equal to 1 ($\frac{6}{6}$, $\frac{5}{5}$, etc.); instead of this [the sharpness of vision represented by] $SV. = \frac{6}{6}$, in case the eye is diseased we have $SV. = \frac{3}{6}$, etc. (For particulars, see text-books on the Eye.)

As a matter of course, if we discover a diminution in the sharpness of vision, before we conclude that it is due to a disease of the nervous system we must exclude any disease of the refractive apparatus. (Here, also, the reader is referred to special works upon the Eye.)

(b) Testing the field of vision, FV., the "peripheral sight." The most exact way to do this is to employ a perimeter. A substitute for this expensive instrument, which can be recommended to one who is not a specialist, is the field-of-vision chart, which has six straight lines intersecting each other at a point making angles of 45 degrees. Starting from the point of intersection, these lines are divided into centimetres. At the point of intersection a rod of definite length stands perpendicular to the chart (it is screwed into the chart); upon this upright is a hoop into which the person to be examined places his head. It is used in the same way as a perimeter. The normal size of the field of vision for three or four healthy persons, with a definite length of the upright, is placed upon the chart. (It will be shown that on the outer side the field of vision is endless, because the angle is less than 90 degrees to the direction of the line of sight—but of this no account is taken.) The pathological result is drawn upon a diagram which represents the chart and the normal field of vision on a smaller scale.

We recognize very decided disturbances by steadily holding a finger about a half metre from and in front of the eye, and then moving the other hand, or a light held by it, in every direction in the field of vision. Of course, in this case, as in all others, we are to test each eye singly. The great difficulty is in having the patient hold the eye fixed immovably.

Concentric narrowing of the field of vision rarely occurs in organic diseases of the brain. It oftener occurs with multiple sclerosis, usually from atrophy of the optic nerve (see below), more frequently in neuroses; and it is an especially important symptom in hysteria, "traumatic hysteria," but also in "railroad neurosis," which is closely related to this. With atrophy of the optic nerve there likewise occurs narrowing of the field of vision, which is concentric, more rarely in the form of a sector. Central scotoma occurs particularly in alcohol- and tobacco-amblyopia.

The result of semi-decussation of the optic in the chiasm is the peculiar symptom known as *homonymous hemianopsia*—a defect in the field of vision, involving about half of it, upon the same side of the body in both eyes. Fig. 168 explains this condition: a complete interruption of the optic tract or of the path centrally from it, or, lastly, a total destruction of the sight-centre in the cortex of the

occipital lobe, from which there must result hemianopsia; and, too, the centripetal conduction of the half of the retina corresponding to the side of the lesion will be interrupted, consequently the half of the field of vision opposite the lesion will be defective. Thus, homonymous hemianopsia indicates a lesion which affects the tract of sight between

FIG. 168.

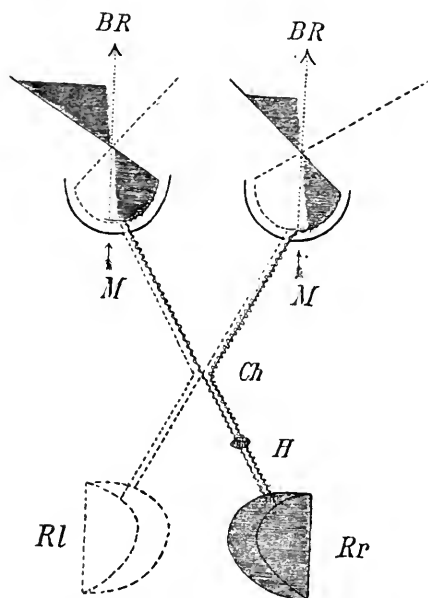

Schematic drawing for explaining the relation of the eyes to vision, and representing hemianopsia. The direction of vision of the two eyes *BR* is very nearly parallel (the eyes being fixed upon a distant object). *M*, macula lutea; *Ch*, chiasm; *Rr*, *Rl*, right and left cortical field of sight (occipital cortex). Notice a kind of semi-decussation in the chiasm, the division of the fibres in the retinae, and the character of the images as they appear in the cortex. *H*, a local disease behind the chiasm; it causes hemianopsia. The portion of the field of vision which disappears, and the cortical field which does not perceive the object, are hatched. The corresponding tracts are represented by a wavy line.

the chiasm and the cortex. Without doubt, this tract also passes through the posterior portion of the posterior crus of the inner capsule, and with equal certainty is in relation with the anterior corpus quadrigeminum of the affected side, for from here also hemianopsia may arise, or, when there is lesion of the corpora quadrigemina of both sides, there is blindness. Lesion of a tract as far as to the affected corpus

quadrigenum causes hemianopic rigidity of pupil with respect to light (see above, Hemianoptic reaction of the pupils—Wernicke).

Hemianopsia is sometimes made manifest by the patient not noticing when some one comes to his bed from that side; by his not being startled when a light is quickly brought near him from the affected side; or, in writing, he does not see what he has written upon one side of a sheet of paper, etc.

A bilateral dropping out of the nasal half of the retina, with bilateral temporal (hence, not homonymous) hemianopsia, may be caused by a tumor which is situated close in front of or behind the chiasm. In this case the two eyes in some degree may compensate, by mutual action, for the defect, though, of course, very imperfectly—for binocular sight is no longer possible. There occur other difficulties whose description does not belong here.

Subjective sensations of vision occur in severe diseases of the eyes of all kinds, but especially in anæmia (flimmering), with nervous subjects. Temporary partial amaurosis has great significance: a strong shining, generally pronounced unilateral subjective sensation of light, which, in some of the cases, is markedly present in migraine (*migraine ophthalmique*), sometimes, during the attack, passing into hemianopsia.

(c) *The color-sense.* The central perception of color is tested by means of skeins of woollen yarns of as pure colors as it is possible to obtain. The color-sense within the limits of the field of vision—in other words, the size of the field of vision for the individual colors—is ascertained in the same way as that of pure white (see above). It is not without importance (see text-books upon diseases of the Eye).

(d) The results of the ophthalmoscopic examination which are here of interest to us will be found in the Appendix.

The diagnostic value of the electrical reaction of the retina cannot be determined, hence we pass it over here.

Hearing.—Functional test. We ascertain the distance at which a whisper can be heard (a healthy person in a closed room can catch it at a distance of about twenty-five metres). We also employ the tick of a watch, which has previously been tested upon healthy persons, to ascertain the distance at which it can be heard. As a matter of course each ear is to be examined separately, and the ear not being examined is to be closed. To this also extends the testing of the behavior of the conductivity of the bones: a normal person does not at all or

only barely hears a watch held near to the closed ear, but hears it distinctly when it is brought in contact with the skull in the neighborhood of the ear. Persons with disease of the outer ear-passage and of the middle ear are in the same condition as those with normal ears when more or less completely closed: at a distance they hear poorly or not at all, but by the conduction of the bones they can hear excellently well. On the other hand, when the acoustic nerve or its terminations in the tympanic cavity are diseased (nervous deafness), hearing at a distance and through the bones are both alike diminished.

The examination with the ear-mirror cannot be described here. It naturally comes into consideration for the differential diagnosis of nervous deafness and of affections of the middle ear or of the external ear passages. (Regarding this and its detailed use, see the text-books upon diseases of the Ear.) We call especial attention, from the fundamental scientific points of view, to the important electrical examination of the acoustic nerve (Brenner); it is true that, in its diagnostic relations, it has no independent significance.

Apart from the special aural point of view, the determination of a disease of the ear or of the sense of hearing is of importance for various reasons: (*a*) for recognizing constitutional affections (caries of the petrous bone in scrofula, tuberculosis, middle-ear catarrh in syphilis; see p. 286); (*b*) for recognizing any other local disease of the cranium, or within the cranium (at its base), or of the brain, which injures the acoustic nerve or the central conduction of hearing; lastly, with reference to further resulting phenomena of a disease of the ear or the petrous bone, if they exist: purulent (sometimes, also, tuberculous) meningitis, abscess of the brain, and facial paralysis.

It is further to be mentioned that, on the other hand, in a normal condition of the hearing apparatus a functional disturbance may be caused by a rheumatic facial paralysis, if it is located high up: from paralysis of the stapedius muscle, supplied by the facial, and predominant development of the tensor tympani, there may arise a morbid acuteness of hearing, especially for deep tones.

Subjective sensibility of hearing (tingling, ringing, buzzing, roaring in the ear, etc.) occurs in anæmia, nervousness; further, in diseases of this organ of any kind; but, lastly, also in palpable nervous diseases. The latter are then generally affections of the acoustic nerve,

as compression or neuritis, or of its terminations in the labyrinth. Subjective auditory sensations, as signs of disease of the acoustic nucleus of the oblongata, or of the auditory tract in its central course, or of the auditory centre of the cortex in the temporal lobe, are very rare, if not unreliable. It is very worthy of note that tinnitus aurium may sometimes introduce an attack of migraine, apoplexy, or, as an aura, an epileptic attack.

Tinnitus aurium may occasionally be combined with dizziness (*nervus vestibularis*); this is much the most pronounced in Menière's disease. Marked ringing in the ears may become the source of psychical disturbance.

In order to make a diagnosis of word-deafness, or of sensory aphasia, it is, of course, necessary, as a preliminary condition, to determine whether the hearing is good.

Lastly, attention must be especially called to the fact that a unilateral disturbance of the hearing may have entirely escaped the attention of the patient.

Smell.—Testing its function. For this purpose we may employ camphor, petroleum, perfumed spirit, and, as disgusting material, asafoetida; but not ammonia or acetic acid, because even a very slight amount of the vapor of these substances may irritate the trigeminus. We first test one side and then the other. We do not here describe the examination of the nose with the nasal speculum.

Anosmia [loss of the sense of smell] of neuropathic origin is not very frequent. It occurs in processes in the anterior cranial fossa and the anterior portion of the brain which lead to compression of the olfactory, as from tumors, meningitis, hydrocephalus; and here it is also due to compression of the olfactory. Unilateral anosmia has been observed as an associated phenomenon of total hemianæsthesia in lesion of the posterior portion of the internal capsule—of course, on the side opposite to that diseased. But in exactly the same way we may have unilateral anosmia with hysterical hemianæsthesia.

It is rare to have anosmia from lesion of the nerves passing off from the bulb in the ethmoid bone, when this bone is fractured. But it is always to be remembered that the most frequent cause of loss or diminution of the sense of smell is disease of the nasal mucous membrane. It is further to be noticed that in old age anosmia some-

times occurs without any notable pathological cause (atrophy of the olfactory).

In very isolated cases the disturbance is to be referred to paralysis of the trigeminus; that is, to the dryness of the nasal mucous membrane due to the paralysis.

Hyperosmia and osmic paræsthesia (parosmia) occur in hysteria and insanity, and as an aura in genuine epilepsy.

Regarding the significance of the nose as a point of departure in disease within the cranium, compare further, pp. 358-9.

Taste.—Testing its function. We test it for the recognition of salt, sugar, vinegar, and quinine. We also make a test by retaining the same order of succession of all these substances when suitably diluted. Then follows the testing of a circumscribed portion of the tongue, as first one and then the other half of the tongue, then the anterior two-thirds as compared with the posterior one-third, because the former portion is supplied by the chorda, the latter by the glosso-pharyngeus. For this purpose we wipe the tongue somewhat dry, apply to it a very little of the [test] fluid with a glass rod, remove any surplus and have the tongue simply drawn back, but without any further motion. Although this method is somewhat doubtful, since a portion of the hard and soft palate, which cannot be exactly defined, also possesses the sense of taste, yet it seems practicable, as follows from its positive results in certain cases of facial paralysis. The more exact method of not drawing the tongue back into the mouth after the test substance has been put upon it, thus to eliminate the assistance of the palate, has the disadvantage that then even persons in health can only imperfectly taste.

Ageusis [loss of the sense of taste] on one side of the tongue is observed with total hemianæsthesia. Unilateral ageusis of the anterior portion of the tongue occurs also from peripheral chordal paralysis, and this is the case whether it involves injury of the branch of the trigeminus as far as the Gasserian ganglion, or of the second branch from there to the sphenopalatine ganglion, or of the facial between the geniculate ganglion and the point where the chorda is given off, or of the commissural portion between the fifth and seventh nerves, the N. petrosus superf. major. Total ageusis points to hysteria.

Moreover, the fineness of the taste, as well as of smell, varies much with the individual.

DISTURBANCES OF THE VEGETATIVE SYSTEM IN NERVOUS DISEASES.

We must here limit ourselves to a brief enumeration of the most important points.

1. *General Phenomena.*

The apoplectic habit (short, thick neck, red face, full chest, abundant layer of fat) decidedly predisposes to hemorrhage of the brain, but this also occurs very frequently even in very lean and anæmic subjects. In other respects the general habit does not predispose individuals to diseases of the nervous system.

Nervous diseases affect the nutrition in a great variety of ways, sometimes, for a long time, not at all, and again very decidedly. It depends chiefly upon the accompanying vegetative disturbances: fever, decubitus (which see) and the various disturbances of individual internal organs to be mentioned.

A tuberculous nature of a local disease of the brain, or of a meningitis may be suspected (aside from possible tuberculosis of the lungs, scrofula, hectic fever) when the nutrition is decidedly poor. The same thing is true with respect to carcinoma.

Fever occurs in diseases of the nervous system: (*a*) if the disease itself is of an inflammatory or infectious nature; (*b*) if it causes vegetative disturbances, as decubitus, cystitis, etc., which in turn give rise to fever; (*c*) in many cases where the elevation of the temperature is supposed to be of a neurotic character: in progressive paralysis, in injury of the cervical spinal cord, which is not fatal (here, according to Naunyn and Quincke, the increase in the production of heat rises to 44 C. [=112° F.]), in tetanus, in severe epileptic attacks.

Diminution of temperature is likewise seen in progressive paralysis, and with injuries of the cervical spinal cord.

2. *Disturbances of the Respiratory Apparatus.*

Nose. Certain affections of the nose (nasal polypi, enlargement of the turbinated bones, chronic catarrh) stand in a peculiar, often causal relation to various neuroses, especially to bronchial asthma, to nervous affections of the heart. The nose, through the ethmoid bone, may be

the gate of entrance for meningitis or abscess of the brain ; also, it is to be mentioned that the nose comes especially under consideration in the diagnosis of syphilis.

Larynx. The larynx may be paralyzed. When there is anæsthesia of the larynx we investigate its nerves and their centres in the bulb : further, hysteria sometimes comes into consideration. See some additional remarks regarding the larynx in the Appendix. We have a nervous cough from simple nervousness, also in hysteria. Laryngeal spasm is an attack of nervous cough, which may occur in decidedly varying severity from slight irritative cough to attacks resembling whooping-cough of the severest character. It is produced by irritation of the vagus by tumors of the bronchial glands, or it occurs in tabes and hysteria.

Dyspnœa : see what was said regarding asthma in connection with the nose. It occurs also in uræmia, and is sometimes the most prominent symptom in chronic uræmia, and in diabetes. Lastly, dyspnœa is caused by functional and true paralysis of the respiratory muscles. With the latter we take into consideration the tracts of the nerves, the nerve centres, especially the respiratory centre in the bulb. Dyspnœa is caused also by tonic and rapidly recurring clonic spasms of these muscles. In hysteria there is great disturbance of the breathing : extremely rapid superficial, or labored, deep, panting breathing, and temporary fixation of the diaphragm. (Regarding Cheyne-Stokes phenomenon, see p. 92.)

The condition of the lungs and the character of the sputum are chiefly regarded from two points of view : the determination of a tuberculosis ; and, because a connection between fetid bronchitis, abscess or gangrene of the lungs, emphysema, and purulent meningitis and abscess of the brain has recently been recognized.

3. *Disturbances in the Circulatory Apparatus.*

Heart. This has most important relations to hemorrhages and embolic softening of the brain : hypertrophy of the left ventricle favors the occurrence of hemorrhage (contracted kidney) and valvular endocarditis. In case of weak heart, thrombi existing within the heart (the auricular appendix), may cause emboli. Atheroma of the vessels likewise may cause hemorrhage, emboli, and local thrombosis of the

vessels of the brain. But often aneurism of the minute arteries of the brain causes hemorrhages without there being any atheroma of the vessels of the body. Whenever there is loss of consciousness, but especially in every case of apoplexy, and of paralysis, which is to be referred to the brain, the heart and vessels are to be most carefully examined.

Palpitation and pain (angina pectoris) occur in organic disease of the heart, in simple nervousness (heart neuroses), in hysteria, in Basedow's disease, and in nicotine poisoning. Hence these phenomena may have great diversity of significance.

Much has already been said (p. 237ff.) regarding the anomalies of frequency of the pulse. Temporary, seldom continuous, quickening of the pulse occurs in neuroses; but, besides, paralysis of the vagus or the vagus nucleus (neuritis, bulbar paralysis) quickens the pulse, often, also, causes a gallop-rhythm (see p. 220).

The vasomotor disturbances are extremely manifold and interesting, but, according to our present knowledge, are seldom of diagnostic importance. There must be mentioned the unilateral paleness or redness of the head in many cases of migraine (hemisrania, sympathetica spastica and sympathetica paralytica); unilateral paleness in hysterical hemianæsthesia. We observe cyanosis, coldness, œdema, especially frequently in cerebral, sometimes also in spinal (poliomyelitis acut.) and in peripheral paralyses, and in hysteria. Sensations of heat of the skin in Basedow's disease—perhaps, also, in paralysis agitans—are to be referred to vasomotor influences. Regarding the secretion of perspiration, see p. 36f.

Local asphyxia (cyanosis, coldness) and spontaneous symmetrical gangrene is observed in general neuroses, peripheral neuritis, but also in acute infectious diseases, diabetes, and ergotism.

4. *Disturbances of the Digestive Apparatus.*

Very much has already been said upon this point, hence reference is made to p. 284ff.

Anæsthesia of the pharynx may, exceptionally, be evidence of a palpable disease; it is a much more frequent and important symptom of hysteria.

Increase in the secretion of saliva occurs in psychoses, idiotism, also in bulbar paralysis; in all three cases—in the first from inattention,

in the latter from simultaneous paralysis of the lips, tongue, and muscles of deglutition—the secretion sometimes runs out of the mouth. But, for the same reason, in bulbar paralysis the secretion escapes from the mouth, although it is not increased in amount. Diminished secretion of saliva is seen chiefly in facial paralysis (secretory fibres in the chorda tympani).

We are also to bear in mind the nervous dyspepsias, which may be divided into psychological disturbances, as dyspeptic difficulties with perfectly normal digestion, and nervous disturbances of secretion or of the motor function of the stomach. The diagnosis is to be determined by an examination of the contents of the stomach.

As was previously mentioned, vomiting takes place in all kinds of disease of the brain, especially in those that develop rapidly; further, very especially in the course of diseases of the cerebellum. It is also to be mentioned that there is vomiting with migraine and hysteria. *Gastric crises* are attacks of very severe, often widely-radiating cardialgia, associated with vomiting (hyperacidity); they are a peculiarity of tabes, and not infrequently they are for a long time misunderstood. Intestinal crises (attacks of colic), and those involving the rectum (severe tenesmus), are rare occurrences in tabes.

With a number of nervous disturbances, especially in children, we must think of intestinal parasites. They may cause nervous agitation, marked nervousness, attacks like migraine, and spasms. It is not unimportant, although very infrequent, that the *tænia solium* may infect the subject who has it with *cysticercus* [cellulosæ]: thus, sometimes, *cysticerci* may develop in the brain, in the eye.

Habitual constipation is especially frequent in all kinds of diseases of the spinal cord. Marked *retentio alvi* is very often dependent upon weakness or paralysis of the abdominal muscles, perhaps from abdominal pressure.

Incontinentia alvi is partly the result of inattention on the part of idiots, the insane, those who are unconscious; on the other hand, it is evidence of paralysis which either only manifests itself by the fact that the stool cannot be retained long after the first sense of desire, or that only the fluid stool cannot be held back; lastly, that solid as well as thin stool passes each time. This disturbance may occur from interruption of the reflex arc centripetally from the rectum to the lumbar portion of the spinal cord, and thence again to the sphincter muscles,

or by interruption of the tracts, centripetal and centrifugal, between the lumbar cord and the brain (voluntary defecation). Involuntary discharge of the stool likewise takes place, particularly in spinal diseases both of the lumbar cord and of the portion above it. In the latter case the discharge seems to be regulated by the absence of reflex, but without the influence of the will; on the other hand, in destruction of the lumbar cord, the reflex as well as the voluntary influence is annulled: the sphincter is relaxed, the scybala escape as they are carried down from the intestine. The same thing is also observed in very great prostration.

5. *Disturbances of the Urinary Apparatus.*

Oliguria, anuria, also polyuria, may temporarily affect hysterical patients. Polyuria (diabetes insipidus) and also glucosuria are observed temporarily or continuously with local diseases of the oblongata, for a very short time in tabes, and when there is considerable increase of the intracranial pressure. On the other hand, in genuine diabetes mellitus there are observed a number of nervous disturbances; neuralgia, neuritis, deep disturbances of the nutrition of the skin and the subcutaneous cellular tissue, and coma which appears either slowly or suddenly like apoplexy.

Cystitis, from the slightest to the most severe form, is observed when there is difficulty in emptying the bladder (which see), and especially (but not exclusively) after the use of the catheter. It is particularly an important and frequent complication of myelitis transversa and of tabes.

Further particulars regarding the condition of the urine are given in connection with the urinary apparatus itself.

Involuntary passage of the urine occurs in the insane, with idiots, in the state of unconsciousness, in severe diseases of any sort; further, as a special form of disease in enuresis nocturna.

Retentio et incontinentia urinae, however, have an especial rôle. With the former, the patient, when urinating, must press or wait a little, when the urine gradually comes in the ordinary way, or else it escapes very slowly in a small stream, or the bladder cannot empty itself at all and the catheter must be used. Incontinence often first manifests itself as under reflex control, but the urine is passed inde-

pendently of the will, or simultaneously with retention there is an after-trickling, or an escape of the urine while laughing, coughing, or in severe cases, as ischuria paradoxa: the bladder is not completely emptied, sometimes remains always abnormally full, but from time to time some of its contents escape; in the most severe cases the urine trickles continually from the constantly-full bladder. In the latter cases there is complete paralysis of the bladder (generally of the detrusor as well as of the sphincter).

An involuntary passage of urine which is under reflex control requires an intact reflex arc: (*a*) healthy mucous membrane of the bladder; (*b*) sensitive muscle; (*c*) nerves; (*d*) lumbar spinal cord; (*e*) muscles of the bladder—hence it occurs with an intact lumbar cord, but one which is cut off from the brain: myelitis transversa dorsalis, cervicalis, or traumatic and other spinal transverse lesion. We meet with complete paralysis of the bladder chiefly in lesions of the lumbar cord. All kinds of bladder disturbance occur, from the slightest to the most severe, in tabes. Differential diagnosis comes chiefly into consideration from the fact that disturbances of the bladder are absent in multiple neuritis (as against tabes); further, in amyotrophic lateral sclerosis, polio-myelitis (as against myelitis).

We have still to mention the [frequent, but not invariable] involuntary passage of urine in attacks of genuine epilepsy; it is wanting in hystero-epilepsy, and so it is important for differential diagnosis.

Bladder crises (painful tenesmus) are observed in tabes.

Lastly, it is to be cited that the most varied conditions of irritation of the penis (especially phimosis) may lead to enuresis, pollution, other nervous disturbances of various kinds.

6. *Disturbances of the Genital Apparatus.*

The various anomalies of the male genital function may be almost entirely (with the exception of azoö spermia and aspermatism) functional and organic, and in the latter case again may rest upon a nervous as well as some other form of disease. From the standpoint of diagnosis of nervous diseases the decline of the genital function is chiefly of importance in tabes, as against chronic multiple neuritis. On the other hand, differential diagnosis from neurasthenia spinalis is often necessary, and it is to be remembered that in the latter disease

there may also be long-continued marked functional disturbance of the activity of the sexual function.

Of the female genital apparatus very little needs to be said here. An energetic reaction has taken place against the etiological relation, formerly very strongly claimed, between anatomical disturbances and hysteria, which reaction, in turn, is going too far. In our opinion, there is no doubt that in women diseases of a sexual character may cause hysteria, certainly more than other conditions which tend to weaken the nervous system do.

The so-called painful ovary or ovarian hyperæsthesia, sensitiveness of the hypogastric region, especially on the left side, to pressure upon this spot (which has nothing to do with the ovary) is not unimportant in hysteria and sometimes causes an hysterical spasm; also [pressure] sometimes arrests an existing attack [Charcot]. Similar hysterogenous zones may exist in other regions of the body in hysterical subjects.

7. *Disturbances of the Skin.*

A number of diseases of the skin, apart from the special province of dermatology, rest upon a neurotic basis, as herpes, sometimes probably also pemphigus; further, the so-called glassy skin; at any rate, each of these may be regarded as a disease of the peripheral nerves. *Herpes zoster*, especially when it involves the intercostal nerves, has a special significance: it has its origin in compression of the spinal cord, in tabes, meningitis spinalis (here probably entirely from the roots of the nerves), in disease of the spinal ganglion, and in peripheral neuritis, in all these cases generally associated with neuralgic pains. But herpes also occurs in the region of any other nerves, as the trigeminus.

Regarding herpes labialis, etc., see under acute general diseases, p. 50.

In all diseases of the nervous system we must search carefully for any evidences of syphilis, not only upon the skin but also in the other organs which come under consideration.

Regarding local perspiration (see p. 38) we sometimes, although rarely, have local anidrosis. Among the laity the loss of perspiration of the feet plays an important part as the supposed cause of a number of diseases, particularly spinal, as tabes; it is probably a consecutive, and in itself an indifferent, phenomenon of this disease.

Hemorrhages of the skin occur spontaneously in hysteria, as curi-
osities; punctiform ecchymoses may be observed upon the face, chiefly
in the neighborhood of the eyes after epileptic attacks. Here, also,
we more frequently have hemorrhages in the conjunctiva. Hemor-
rhages into the subcutaneous tissues take place after injuries received
during an epileptic attack. The significance of hemorrhages into the
skin and subcutaneous cellular tissue of the head (especially about the
eyes, and of the nose in fracture of the base of the skull), is treated
of in the works upon Surgery.

Decubitus is an ulceration of the skin, then of the subcutaneous
tissue and sometimes of the deeper tissues, and even of the bone
itself. It occurs in dependent portions of the body upon which the
patient's weight rests, and particularly where the skin covers bony
prominences, as the sacrum, the heels, the scapulæ. Want of clean-
liness, and lying upon the sacrum, especially when there is incontinen-
ence of stool and urine, are very marked exciting causes.

1. *Decubitus acutus* (malignus). It at first manifests itself as an
erythema exudativum, then vesicles are generally formed, whose bases
become necrotic, from which the destruction proceeds rapidly both in
area and depth. Pressure and filth are marked causes, but pressure
alone may produce the ominous exudative erythema, as on the inner
sides of the knees when pressed together in cases of adduction con-
tracture, where we once saw an enormous *decubitus acutus* form in a
few days. *Decubitus acutus* has been seen by Chareot in hemiplegia
upon the posterior portion of the paralyzed side two to four days after
an attack of apoplexy. We have observed it only in severe diseases
of the spinal cord.

2. *Ordinary decubitus* occurs only when the body lies so that pres-
sure is made upon one place and with the concurrence of uncleanness;
it may be entirely prevented by proper care. It also begins as an
erythema, or in the form of a few pustules, or a cutaneous hemor-
rhage. It occurs in all organic paralyses, also in any kind of cachexia,
if care is not taken to prevent it.

Mal perforant [perforating disease of the foot] is a destruction of
the skin and deeper parts of the foot, especially of the heel [sole?].
It occurs in tabes, in progressive paralysis, also in diabetes. Recently
ulcerations of the skin, or subcutaneous tissues in syringo-myelitis of
the cervical cord have been observed (Schultze).

Growth of hair is a very notable anomaly dependent upon a neurosis. But these changes have no independent diagnostic significance.

The nails readily become claw-like, angular and brittle in long-continued severe peripheral paralysis.

8. *Bones and Joints.*

We observe the arrest of growth of bones after severe central paralysis during the period of childhood, and, likewise, after polio-myelitis acuta it is generally more marked than after encephalitis. Abnormal brittleness of the bones is frequently seen in tabes. In severe syringomyelitis of the cervical cord, there are severe trophic disturbances of the bones, as fractures, periosteal inflammations with separation of sequestrum.

Arthropathia of all kinds are to be observed in diseases of the nervous system: 1. Organic arthropathia, seldom in recent hemiplegia, occurring more frequently as stiffness of the joints, is easily confounded with stiffness and sensibility from contracture. It occurs in old hemiplegias, and is also to be observed as serous effusion with periarticular swelling or as severe deforming arthritis, also causing new formation; both the latter occur in tabes.

2. Joint neuroses occur as painful, occasionally exacerbating affections of the joint, sometimes with points of pressure, stiffness, and contracture, the two latter disappearing under narcosis, but without any sign of organic disease.

Under the name of *acromegalia*, Marie has recently described a peculiar disease, which consists in a giant-like enlargement of the feet, hands, nose, inferior maxilla, and certain parts of the skeleton, dependent entirely or chiefly upon hypertrophy of the bones.

THE DIAGNOSTIC VALUE OF THE SYMPTOMS IN NERVOUS DISEASES.

In diseases of the nervous system the individual phenomena combine to form complexes of symptoms in so manifold a way (much more than in the diseases of any other organ-system), that the representation of only the most important possible combinations would very much exceed the limits of a brief work upon diagnosis. Moreover, for the introductory study of individual diseases, we must confess that we

think the method of special pathology which compactly presents the picture of disease on the lines of etiology, anatomy and symptoms is far preferable to the introduction of such minutiae into a text-book upon diagnosis, as, if this and that phenomena is present, then the disease is so-and-so; but if we have this and that other phenomena, then it is some other disease. For this reason we add here only a few general remarks.

In diseases of the nervous system much more than in those of the rest of the organism, the impression stands out distinctly that we in reality have to estimate the phenomena found in a patient in two ways. We must ask ourselves:

(a) What are the portions of the nervous system whose disease, judged by their nature and location, has caused or can cause the present phenomena? This proceeds upon our knowledge of the anatomy, physiology and pathological physiology of the nervous system, which we must acquire as perfectly as possible.

(b) Does the picture formed by all the symptoms correspond with any disease with which we are now acquainted? Then comes the further question:

(c) What light does the etiology, development, and course of the disease throw upon its nature, and sometimes also upon its location?

The lines of thought designated by (a) and (b) closely interlock; generally both are employed in a single case. In certain diseases, indeed, we are wholly or almost wholly directed to the latter, (b), which is, so to speak, unscientific, particularly in certain general neuroses or functional diseases (regarding which, see below). On the other hand, we are fortunately able, in local diseases of the brain, of the spinal cord and of the peripheral nerves, to proceed upon an almost purely anatomico-physiological basis.

In order to make a diagnosis of the location of a local disease, besides the special knowledge requisite for such a discrimination, one must have a certain amount of practice in making combinations, of which the ability to keep in mind the topography must form the basis. (Let it be here once more repeated that our preliminary anatomical remarks do not, by any means, contain all that has been positively determined and is interesting to know, but are rather for the purpose of instruction in topographical thinking). We advise the beginner, who wishes to train himself in this department, to begin

with the study, for instance, of peripheral facial paralysis, the different combinations of paralysis of cranial nerves at the base of the brain, and then to study the group of symptoms in the cerebral centres.

In order to arrive at a conclusion regarding the location of a local disease it is recommended, as the result of experience, that we should always attempt to trace the different phenomena back to a focus; but it is evident that sometimes there will be several foci. Moreover, the probability that there is only one focus varies with the supposed nature of the disease; thus, for instance, a glioma almost always occurs as a single tumor, while metastatic cerebral abscesses are generally, and thrombotic foci of softening very often, multiple.

In regard to local diseases of the brain we are to distinguish between the general phenomena as respects the brain, and the local symptoms. The general brain symptoms are essentially those relating to increased intracranial pressure, and may comprise :

(a) Psychical disturbances (affecting the clearness of consciousness, of intelligence, the subjective condition).

(b) Pain in the head; dizziness; rigidity of the pupils; spasms; certain phenomena of organic life, as diminution of the pulse, vomiting, etc.

Affections that develop rapidly and are of limited extent, especially hemorrhages, also other disturbances occurring suddenly, as emboli, usually produce the most pronounced general phenomena. We call the sudden loss of consciousness, sometimes combined with one or other of the phenomena mentioned above, an *apoplectic attack*.

The local symptoms are divided into direct and indirect: the former are dependent upon disturbances of the centre and the tracts which are regarded as irremediable, the latter are caused by all sorts of disturbances (commotion, "collateral œdema," anæmia, etc.) in the neighborhood of the elements that are really injured—disturbances which may again disappear, and which, after a hemorrhage or emboli, always disappear in the course of months, so that only the direct local symptoms caused by the disturbance itself then remain. With local growths which develop slowly, as tumors, these indirect local symptoms may often change, or they may permanently remain. In the spinal cord, when there are local diseases, the general phenomena do not usually play such an important rôle, and we may not here be able sharply to separate the direct and indirect local symptoms.

But in all diseases of the nervous system all possible disturbances in the rest of the organism contain diagnostic points, and come especially under consideration in local diseases of the brain and spinal cord for forming a judgment as to the nature of the local trouble. We compare what was said upon this point in the chapter on vegetative disturbances; but, especially, we must never fail, in every disease of the brain and spinal cord, to take into consideration the possibility of the syphilitic nature of the disease (when there is the slightest suspicion of syphilis the treatment is to conform to it).

Under the anatomical diseases of the nervous system, in every respect the so-called systemic diseases have a special place. In these conditions the disease in the nervous substance is, with more or less regularity, always concerned only with certain elements, which systematically (in Flechsig's sense, see below) belong together, while other portions, even lying very close to the diseased ones, remain entirely healthy: the disease does not lay hold of the entire region, and thus it stands in sharp distinction from the inflammatory diseases and all new formations. But even though the systemic disease lays hold upon elements of the same function (and indeed always the symmetrical portions of the two sides; and these are generally, although not always, of the same severity upon both sides), it always produces, at least in its main features, a like combination of symptoms. If several systems are affected with disease at the same time, then we speak of the combined system-disease. Amyotrophic lateral sclerosis furnishes the most clear picture of a combined system-disease which may affect the whole cortico-muscular conducting tract from the cortex to the muscles, but always leaves all the rest entirely intact. We advise every one to begin the study of the system-diseases with this remarkable one.

Recently, aside from the systematic nerve-trunk degenerations, we speak, also, of systematic nuclear degeneration, in that we have somewhat modified the idea of the system which was employed by Flechsig only for the bundles of fibres which showed similarity by the point of time when their medullary sheath was formed (and which "appeared to be intercalated between apparatus having objects of equal value"). Hence, and not incorrectly, we designate the disease itself as systematic when it involves "apparatus having objects of equal value."

In conclusion, we make a few further remarks regarding the differential diagnosis of functional and anatomical diseases of the nervous system; this differential diagnosis is often so extremely easy that the question does not arise at all, but sometimes it is extremely difficult. The points of departure for the differential diagnosis are arranged in four categories:

1. The first question always is whether the general picture entirely corresponds with a local disease, or an anatomical or functional disease. It is to be remarked, however, that hysteria may sometimes exactly simulate a local disease of the brain.

2. There are certain symptoms of palpable disease that are entirely unmistakable. These are: the reaction of degeneration (or rapidly developed and very decided atrophy and laxness of the paralyzed muscles (compare, further, what was said on p. 493 regarding atrophy in hysterical paralysis); choked disc and reflex rigidity of pupils are also symptoms. Not absolutely certain, although pointing quite decidedly to a palpable disease, are: absence of tendon reflex; in unilateral affections, the unilateral absence of abdominal reflex, and very marked disturbance of the bladder.

3. There is one almost certain sign of functional disease: a sudden return to a perfectly normal condition after long persistence of a diseased condition, or the sudden occurrence of new and different phenomena with the disappearance of those previously existing. There are other signs of functional (hysterical) diseases which, in combination, cannot mislead; these are the *stigmates hysteriques* (Charcot): hysterical hemianæsthesia, concentric limitation of the field of vision, characteristic spasms, sometimes hysterogenic zones.

4. As regards cerebral symptoms, marked development, or, on the other hand, the absence, of a disturbance of the sensorium and the intelligence, decides the question. Also, continuous fever and rapid decline of strength indicates an anatomical disease.

APPENDIX.

WE present here a very brief sketch regarding the examination of the larynx with the mirror and the revelations of the ophthalmoscope, so far as they are related to internal diseases, especially to the diseases of the nervous system. Lastly, there follows a review of the life history of those pathogenic bacteria which have any part in the diagnosis of internal diseases.

We pass over entirely the examination, with the mirror, of the nose and ears, because these pertain chiefly to the diseases of these organs themselves, and are very rarely of significance for recognizing any other diseases. Besides, with reference to the latter view, we have already (pp. 573 and 575) referred to the diseases of the nose and ears which do sometimes come under consideration.

1. *Laryngoscopic Examination of the Larynx.*¹

Instruments and sources of light. Türk's reflector with a head-band is most frequently recommended for illuminating the throat. As the laryngeal mirror we employ a round mirror, with a diameter of 20 to 25 mm., fixed to a staff at an angle of 120 to 125 degrees. The staff is fixed to a handle or it is screwed into a handle prepared for it.

For a source of light we may employ any sufficiently powerful oil- or gas-lamp. The lamp is placed close to the head of the person to be examined, so that the light from the reflector is thrown at the smallest possible angle into the throat of the person being examined. If it can be had, sunlight is better than artificial light. It is employed either in such a way that the patient sits, with his eyes closed, facing the sun, and the light is allowed to fall directly into the throat or so that the sunlight is thrown by the reflector into the throat. If the

¹ Let it be distinctly understood that the above only contains the most essential points which are of use in the examination itself. They cannot and should not take the place of the study of these subjects in a medical course.

sunlight is glaring, we employ a special mirror with a longer focus (or a plane mirror), because the ordinary reflector would make a too glaring light, and sometimes even produce an uncomfortable sense of heat in the throat. Electric, magnesium, and other lights are at present too expensive to take the place of sunlight.

In making the examination we sit directly in front of the patient, have him open his mouth, set the reflector at the proper angle, then warm the laryngeal mirror a little over a spirit-lamp (testing its temperature by placing it against the back of the hand), have the patient put out the tongue, seize it with a napkin or handkerchief and draw it out [as far as possible. It is well to have the head thrown quite well back.]. Holding the mirror as one would a pen, it is to be slowly and carefully introduced into the mouth, and then the patient required to distinctly pronounce "æ," at the same time giving the proper direction to the mirror as it is pushed as far back as possible into the pharyngeal cavity, slightly pressing up the soft palate. The parts are now brought into view by elevating the mirror, depressing it, turning it

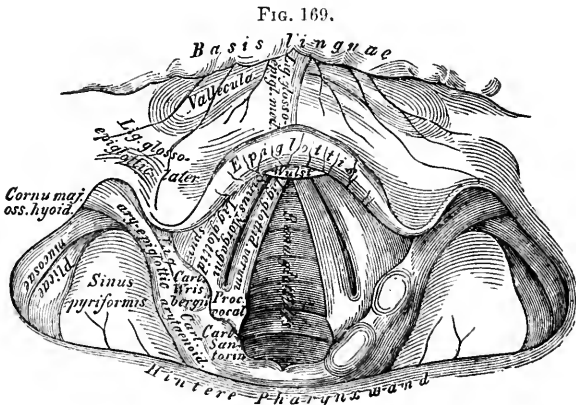

Laryngoscopic view of the larynx during quiet breathing (after HEITZMANN), double size.

now to the right, then to the left, and revolving it, both during quiet respiration and phonation.

The mirror must be most scrupulously cleaned with every examination. It is not necessary to employ a special mirror with patients who are manifestly syphilitic.

Irritability of the pharynx (strangling, vomiting) may, with prac-

tice, be avoided. In very obstinate cases we can employ cocaine. (See the special text-books regarding other obstacles and the ways of meeting them.)

In the laryngoscopic image the parts that are anterior appear as the posterior; on the other hand, what is upon the right hand of the patient remains upon the right; the examiner has, of course, the right vocal cord of the patient upon his left side.

We observe (see Fig. 169): 1. The base of the tongue, the glosso-epiglottic ligaments, the epiglottis, lig. aryepiglottica with the cartilages of Wisberg. 2. The arytenoid cartilage, or the cartilage Santorini, the false vocal cords, the sinus Morgagni. 3. The ligamenta glottidis vera, with the vocal process of the arytenoid cartilage. 4. The region between the arytenoid cartilages, pars interarytænoidea (the posterior wall of the larynx); the subcordal region, or the foreshortened trachea. The illumination must be strong.

It is advisable for those who have had but little experience to first fix the landmarks by the shining white prominent true vocal cords, and from thence to examine the individual parts of the laryngeal picture one after the other.

The examination with the laryngeal mirror is directed to three things: the form and the color of the parts of the larynx, and the position, or motion of those that move.

As to the form of the several portions of the inside of the larynx it is to be remembered that the representation given in Fig. 169 is, of course, only schematic. Repeated examinations of normal larynges will show the variations and fix them in mind. The form of the epiglottis varies very much; this is also true of the arytenoid cartilage and the false vocal cords or the opening of the ventricle of the larynx.

The color of the mucous membrane of the larynx, with the exception of the true vocal cords, is tolerably uniform and corresponds somewhat with that of the hard palate. Very often the upper border of the epiglottis, and sometimes its upper surface, is lighter, even yellowish-red. Above the arytenoid cartilages, the color of the mucous membrane varies considerably: sometimes it is exactly like the other parts, sometimes darker, again lighter, and then yellowish. The true vocal cords are shining white; in individual cases, with the function perfectly normal, they are slightly rosy. At the vocal process there is a circumscribed yellowish spot.

We must be on guard against being misled by deposits of mucus or of pus from the lungs. These deposits may be superficial, or may conceal deep ulcerations, loss of substance, croupous deposits. If in doubt, require the patient to cough. If still uncertain, have the patient inhale the vapor of steam for a few minutes, and then repeat the examination.

Normally the positions and movements of the portions of the larynx are perfectly symmetrical, although it is to be remarked that if the mirror is not properly held in position, the parts may easily appear to be unsymmetrical. During quiet respiration, the rima glottidis is tolerably widely opened—at least so that the whole breadth of the true vocal cords is visible; the arytenoid cartilage (cartilage of Santorini) can be seen between the pars interarytænoidea (posterior wall of the larynx); with active deep inspiration, the vocal cords separate from each other still more, so that they almost or quite disappear under the false vocal cords (which likewise stand apart. During phonation, the vocal cords come so closely together that either no slit between them, or scarcely any, can be seen. Generally their median edges form a perfectly straight line. But in individual cases, only the pares ligamentosæ close so sharply, and posterior to the process. vocales (that is, the pars cartilaginea), the vocal cords remain somewhat more apart, leaving a triangular space between them.

When the glottis is closed the arytenoid cartilages come near together and the pars interarytænoidea disappears; on the other hand, the false vocal cords leave a tolerably broad space between each other, through which we see the true vocal cords.

Pathological conditions. Since we here come upon a subject that has already been frequently referred to, in what follows we bring forward only those conditions which have relations to other internal diseases, and treat of them in the briefest way.

We do not meet with paleness of the mucous membrane of the larynx as a local condition. Also, it is no longer of importance in the recognition of a general anæmia, because this is much easier determined by the paleness of the skin, lips, etc. Only one circumstance needs mention, that tuberculous infiltration and ulceration, in contrast with other kinds, as syphilitic, often accompanies a very striking general paleness of the mucous membrane of the larynx. Abnormal redness of the mucous membrane of the larynx, without other changes,

occurs in febrile hyperæmia of all the mucous membranes and in general or local engorgement (the latter caused by pressure upon the larynx by tumors, from engorgement in the region of the cava superior). Also, whenever there is any redness of the larynx it must, as a matter of course, lead us to examine most carefully for any possible other changes (ulcerations, swellings, etc.).

Redness, swelling, and sometimes secretion, are the signs of *catarrh*. Acute, as well as chronic laryngeal catarrh may involve various locations: for example, it may attack the upper portion of the larynx, leaving the glottis free; it may also attack only the glottis. A simple catarrh is always symmetrical. Acute, as well as chronic catarrh may cause motor disturbances: on the one side this may be due either to the swelling of the mucous membrane (especially of the incisura interarytænoidea, preventing the closure of the glottis), or, to paralysis of the tensor of the vocal cords or the adductors.

Acute laryngitis, especially in children, may give rise to apparent stenosis by reason of the swelling.

It is to be especially remembered that chronic and recurrent acute catarrh, and likewise, no doubt, simple catarrh, are very frequent in all chronic diseases of the lungs and especially in tuberculosis. It is further, important to remember that behind a chronic catarrh a tuberculous or syphilitic (or lupous) new formation may for some time be concealed. A swelling which is limited to or elects the interarytænoïd region is always very highly suspicious of tuberculosis.

Laryngitis hypoglottica (von Ziemssen) is an especially severe form of acute, as well as chronic, catarrh. In this disease we see beneath the vocal cords sometimes merely a soft rosy border, which can only be seen during inspiration; sometimes a firm, grayish-red, smooth or uneven lump (see Fig. 170). It is almost always present upon both sides. These subcordal swellings appear to vary a good deal as to their nature: sometimes they are simply due to œdema; in other cases, to a simple catarrh; in still others, to submucous infiltration. Further, such a subcordal laryngitis may be or may become tuberculous in its nature; more rarely it is syphilitic. From the condition of the larynx alone it is extremely difficult to make the

FIG. 170.



Swelling below the vocal cords from laryngitis hypoglottica chronica (after ZIEMSEN).

differential diagnosis of these specific diseases from simple catarrh, as well as between syphilis and tuberculosis. There may, however, be other alterations of the larynx present, or unquestionable signs in other organs, which throw light upon the matter. The serious character of laryngitis hypoglottica is manifested by the fact that very frequently, and sometimes very suddenly, it causes severe stenosis.

Marked swelling of the whole larynx or of certain portions of it indicates œdema or phlegmon—that is, severe submucous inflammation which ends in abscess. Both of these will chiefly be distinguished by the color of the mucous membrane, which is pale when there is non-inflammatory œdema, even yellowish and often shaking like jelly, while in phlegmonous inflammation it is deep red. Midway between these two conditions stands inflammatory œdema, which pathologico-anatomically and genetically cannot be sharply distinguished from phlegmonous infiltration. Severe phlegmon may lead to decided disfigurement of the larynx (see Fig. 171). This may also be true of œdema, as is shown in Fig. 172. Circumscribed laryngitis phlegmonosa usually results in the formation of abscess, or it may occasion a submucous or perichondrial formation of pus.

FIG. 171.

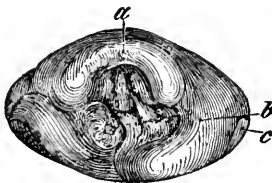

Phlegmonous laryngitis, with phthisical ulcer. *a*, epiglottis; *b*, left aryepiglottic fold; *c*, left pyriform sinus. (From ZIEMSEN after TÜRK.)

FIG. 172.

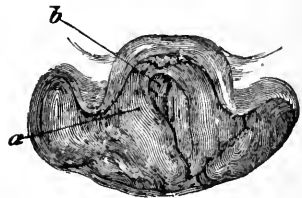

Extensive phthisical ulceration of the larynx, marked stenosis of the larynx from œdema. *a*, right aryepiglottic fold; *b*, anterior portion of the right cord. (From ZIEMSEN after TÜRK.)

Both these conditions are extremely dangerous, because they very easily result in stenosis, and sometimes, if they are acute, with remarkable suddenness. Phlegmonous laryngitis sometimes results in the formation of pus in the larynx (especially perichondritis), or its neighborhood (as *angina Ludovici*). Laryngeal catarrh very seldom terminates as a phlegmon; foreign bodies, and substances that irritate chemically and as escharotics, may produce it; and lastly, it occurs in

various acute infectious diseases, either resulting in catarrhal or ulcerative processes, or, it would seem, as independent metastatic diseases. Inflammatory œdema may be the result in all of these cases, besides or instead of phlegmon. Simple œdema is rare and chiefly occurs with general dropsy of all kinds, and in local obstruction (as in struma, mediastinal tumors).

Ulceration seldom occurs in the larynx with simple catarrh, more frequently in acute infectious diseases, especially in typhus abdominalis [typhoid fever] and variola, but most frequently in syphilis and tuberculosis. We limit ourselves to a description of the two last-named forms.

Syphilitic ulceration in the larynx occurs almost exclusively in connection with pharyngeal syphilis. It, by preference, attacks the upper section of the larynx, but it may appear in the glottis. In the majority of cases a single ulcer is observed. The ulcers have reddened edges, with a more or less shallow, whitish deposit upon a vocal cord, or the epiglottis, or there is a very deep crater-like cavity with a whitish deposit and sharp or swollen border. By the absence of knotty elevations of the border they are sharply distinguished from carcinomatous ulcers. On the other hand, it is often difficult to distinguish them from tubercular ulcerations. Here the differentiation is made by other signs of syphilis or tuberculosis that may be present.

Regarding gummata of the larynx, see below. Syphilitic infiltration without ulceration and without other associated signs of syphilis are very difficult to diagnose. These slighter syphilitic changes, moreover, very seldom come under examination, because they do not usually cause any inconvenience. See special works regarding them.

Tubercular ulceration develops from tubercular infiltration. The principal location to be mentioned is the region of the interarytenoid space. The regions next most frequently attacked are the arytenoid cartilages and the false vocal cords. Tuberculous ulcers, with the exception of those upon the glottis, are more frequently multiple than are syphilitic. They are either very superficial and yellowish in color, or deep with swollen edges, sometimes, especially in the interarytenoid space, with papillomatous mucous proliferations. Although not pathognomonic (Gottstein), the latter form is in the highest degree characteristic of tuberculosis. Further, a pale œdematous condition of the rest of the mucous membrane points to tuberculosis. The most important factor is the discovery of tubercle bacilli in the sputum. These

may come from the larynx or from the lungs, which latter are always, or almost always, the first to be attacked.

Deep ulcerations may lead to perichondritis laryngea. The most frequent form is perichondritis arytaenoidea. Perichondritis causes a very marked swelling and redness, generally over quite a large area. It very easily passes from this condition of swelling or collateral œdema into stenosis. If it ruptures into the larynx, then the necrotic pieces of cartilage will be coughed out, and sometimes, when examining with the laryngeal mirror, we see them lying loose.

Scars are found in the larynx, as elsewhere, after healing from loss of substance. Those that chiefly interest us are the syphilitic. These, more than others, are inclined to retract, and hence they not infrequently result in stenosis. We either find a partial adhesion of the vocal cords or extensive cicatricial adhesions of the true and false vocal cords, with a funnel-shaped narrowing downward, etc. It is generally impossible to form any conclusion as to the nature of the antecedent processes from the scar. Only this, further, is to be said, that most laryngologists now agree that tubercular ulcers may cicatrize.

Excepting the syphilitic gummata, new formations in the larynx have only a local significance. Gummata are either solitary nodules or a group of individually small nodules, at first red in color, with a crinkled contour. They are inclined to break up rapidly, and then to be replaced by deep ulcers.

FIG. 173.

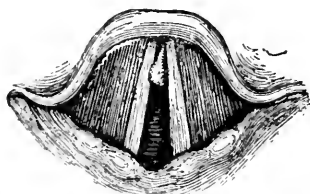

Pedunculated fibroma upon the under surface of the left vocal cord; position during inspiration (ZIEMSEN).

FIG. 174.

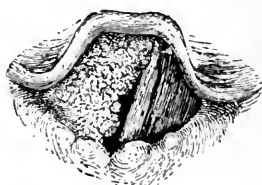

Epithelial carcinoma of the right vocal cord (ZIEMSEN).

The other new formations may be divided into benign and malignant. Of the former, very much the most frequent are the papilloma; more rare are the fibroma. Both, but especially the latter, are generally located upon the vocal cords. Papilloma are sometimes flat,

wart-like, sometimes regular papules, often multiple, cauliflower-like. The fibroma are generally pedunculated; the surface is usually smooth, while that of the papilloma is uneven or villous. All the other benign new formations (lipoma, cysts, etc.) are extremely rare.

The malignant new formations are, in the great majority of cases, carcinoma. They, like the papilloma, generally develop from the vocal cords; next in frequency, from the false vocal cords. They manifest great inclination to necrosis and ulceration. The differential diagnosis of carcinoma, so long as there is no ulceration, is to be made from papilloma, after the occurrence of ulceration from tuberculosis and syphilitic ulceration: generally this is not easy. For particulars, we must refer to special works. Sarcoma of the larynx is much more rare than carcinoma.

In reference to the more unusual diseases of the larynx, like lupus and lepra, we refer to special works.

Spasms of the muscles of the larynx are, for the most part, not at all, or only exceptionally, observed with the laryngoscope. We here only mention phonic and inspiratory functional spasm of the glottis in adults. The former takes place at the instant when the effort at phonation is made, when a decided closure of the glottis takes place, as can be recognized with the laryngoscope; on the contrary, in the latter the vocal cords close at the instant of inspiration, hence, at the time when they ought to separate. During expiration the glottis is normal, or almost normally open, in opposition to paralysis of the [crico-arytænoidei] postici muscles (see below), in which they are very close together during expiration also.

As disturbances of coördination, both of these conditions will be understood from their analogy to the neuroses caused by certain occupations affecting the upper extremity (writers' cramp, etc.), and are to be accounted for by over-strain.

Paralysis of the Muscles of the Larynx.

Paralysis of all the muscles that close the larynx (the crico-arytænoideus lateralis, arytænoideus transversus, thyreo-arytænoideus ext. et internus—all supplied by the recurrent nerve): during phonation the vocal cords do not come close together, but remain in the position of inspiration. Complete aphonia is thus produced. The paralysis

is generally bilateral, and is almost always due to hysteria as a basis. Hence, it is often combined with anæsthesia of the larynx.

Paralysis of the arytenoideus transversus: during phonation the most posterior portion of the glottis (the pars cartilaginea) does not close. As a result we have hoarseness, even to complete aphonia. It not infrequently occurs with acute laryngitis. (See Fig. 175.)

Paralysis of the thyreo-arytenoideus intern., one or both sides, causes imperfect closure of the glottis; when both sides are paralyzed there is a very narrow, symmetrical oval fissure (see Fig. 176); with

FIG. 175.

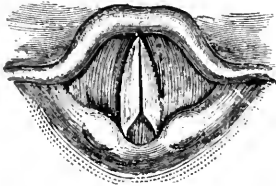

Paralysis of the arytenoideus in acute laryngitis (after ZIEMSEN). The posterior portion of the glottis remains open during phonation.

FIG. 176.

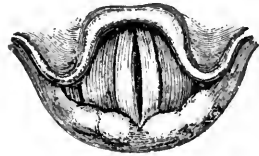

Paralysis of both thyreo-arytenoidei interni, resulting from acute laryngitis (ZIEMSEN). Position during phonation.

unilateral paralysis, a correspondingly narrow, unsymmetrical fissure. It occurs in laryngitis, but, also, often in hysteria.

Paralysis of the crico-arytenoidei postici muscles, the openers of the glottis (recurrent nerve); posticus paralysis: the vocal cords in bilateral paralysis, during expiration, stand near together, and during inspiration still closer, sometimes in apposition; phonation may be quite normal. Hence, there is inspiratory dyspnoea, with inspiratory stridor. The dyspnoea may increase until there is asphyxia. In unilateral posticus paralysis the paralyzed vocal cord is motionless and lies near the middle line, while upon the sound side there are normal motions.

In its etiology, posticus paralysis is in many cases obscure. Sometimes it forms the beginning of a bilateral recurrent paralysis; in other cases it seems to have a muscular origin (gumma in the muscle, laryngitis with atrophy, etc.).

Recurrent paralysis—that is, paralysis of all the muscles supplied by the recurrent nerve—causes the vocal cords to assume the so-called

cadaver position—the position with reference to each other that they have during quiet breathing. In severe paralysis, the vocal cords are entirely stationary in this position. In incomplete paralysis, they still make slight motions outward and also show an inclination to assume the position of adduction, for which there is, as yet, no undisputed explanation. When the paralysis has continued for a long time the vocal cords become atrophied.

Bilateral recurrent paralysis produces bilateral cadaver-position of the vocal cords, and thus complete aphonia, with inability to cough.

FIG. 177.

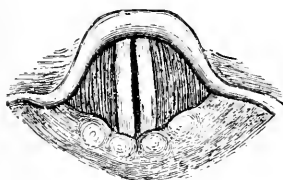

Bilateral complete posticus paralysis (paralysis of the crico-arytenoidei postici, dilatation of glottis) at the moment of inspiration (ZIESSSEN).

FIG. 178.

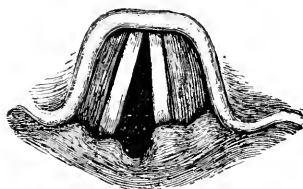

Position during inspiration in paralysis of the left vocal cord, or recurrent conduction paralysis (after ZIESSSEN). Position and immobility of the left vocal cord, as in the cadaver.

This is caused by compression of both recurrent nerves from aneurism of the aorta, carcinoma of the œsophagus, and enlarged glands. It will be readily understood that this bilateral paralysis from peripheral causes is much more rare than unilateral. Complete or incomplete bilateral paralysis of the recurrent nerve has been observed with bulbar paralysis, tumors, softening of the medulla, and compression of the vagi after their exit from the medulla.

Unilateral recurrent paralysis is much more frequent. It may be easily overlooked, because the voice is often clear, although weak, for the reason that the sound vocal cord during phonation reaches beyond the middle line. The paralyzed vocal cord during quiet breathing stands in the cadaver-position, the sound one in the position of rest—that is, somewhat more widely abducted than the other. During phonation the necessary closure of the glottis takes place, because the healthy vocal cord overreaches; but then the glottis is necessarily askew. Unilateral paralysis of the recurrent nerve is almost always due to compression of the nerve in the neck or as it passes into the thorax;

this will be brought about by the same causes as bilateral peripheral recurrent paralysis. Thus, recurrent paralysis may be an important corroborative symptom of aneurism, of carcinoma of the œsophagus, or of any other kind of mediastinal tumor. When there is a suspicion of one of these conditions, we may almost regard a recurrent paralysis as decisive; at any rate, the existence of a recurrent paralysis has often given the first suggestion that led to a discovery of an aneurism or of carcinoma of the œsophagus.

Paralysis of the tensor of the vocal cords (crico-thyreoidei muscles, superior laryngeal nerve) is very seldom observed, and then it is always combined with anæsthesia of the mucous membrane and paralysis of the epiglottis. It is a tolerably dangerous condition, because of the accompanying difficulty of swallowing and the risk of deglutition-pneumonia. The glottis is not exactly steady, but oscillating. In unilateral paralysis the normal vocal cord stands higher.

Paralysis of the tensor of the vocal cords takes place most frequently in diphtheria, but then it is always accompanied with paralysis of other muscles.

2. *Examination with the Ophthalmoscope.*

This method of examination strictly belongs in the province of ophthalmology. Therefore we limit ourselves simply to its use for the purpose of diagnosis, where we observe a connection between certain changes of the fundus oculi and an internal disease.

(a) *Changes in the fundus oculi in nervous diseases.* All diseases which lead to a general increase of the intracranial pressure may cause choked disc (neuritis optica). It is then always bilateral. At the same time choked disc may be absent in all these conditions, but its presence is of the highest diagnostic significance, and particularly in tumors and meningitis. Hydrocephalus is more rarely, and abscess of the brain very rarely combined with choked disc. Unilateral choked disc is only caused by local pressure (a tumor, etc.) upon one optic nerve.

The extent to which vision is disturbed when we have choked disc varies very much; there may be none, or almost none. Disturbance of vision in choked disc usually occurs very early and markedly if the disease-process causes pressure upon the chiasm or the beginning of the optic nerve, as in tumors of the hypophysis cerebri, or if

there is hydrocephalus which presses inward upon the third ventricle (Wernicke). There must, of course, be disturbance of vision if the choked disc is followed by atrophy.

Pronounced choked disc is very easily recognized (only take care: neuro-retinitis Brightii is exceptionally very much like it); but the exact recognition of a slight neuritis optica is very difficult. Whenever there is such a possibility an ophthalmologist should always be called in.

It seems that neuro-retinitis is particularly apt to be present in meningitis when there is a basilar exudation. Neuro-retinitis is said to occur also with encephalitis.

Primary atrophy of the optic nerve takes place (by the intraocular portion of the nerve changing into a white disc with a sharp boundary) especially in tabes, then sometimes in multiple sclerosis, dementia paralytica; lastly, it occurs from pressure upon the chiasm. [The capillary circulation ceases, and hence the disappearance of the normal rosy hue.]

Finally, it is to be mentioned that retinal apoplexy has been observed as the forerunner of cerebral hemorrhage, emboli of the central retinal artery as the precursor of cerebral embolism. Regarding the changes of the fundus oculi in syphilis, see below.

We hardly ever find choroidal tubercle in tubercular meningitis. (But with reference to acute general milliary tuberculosis, see below.)

(b) *Changes in the fundus oculi in other internal diseases.* Retinitis or neuro-retinitis albuminurica, with white specks, often arranged as radiating lines around the macula, sometimes confluent, thickening of the walls of the vessels and hemorrhages, occurs particularly frequently in contracted kidney, also often in subchronic and chronic nephritis, but very seldom in acute nephritis. The disturbance of vision is greater or less according as the macula is attacked or not. Uræmic amaurosis has nothing to do with this condition, but as a matter of fact this form of retinitis often occurs in uræmia (and this is important for the diagnosis).

In constitutional syphilis (hence also in syphilis of the brain) we sometimes observe syphilitic changes in the fundus oculi: retinitis syphilitica, retinitis pigmentosa, choroiditis syphilitica.

We not infrequently find tubercle of the choroid in acute general

tuberculosis, especially in the region of the macula; the tubercular deposits are generally very difficult to see.

In diabetes there occurs a peculiar so-called diabetic neuro-retinitis and atrophy; in leucæmia, hemorrhages and whitish exudate; in pernicious anæmia, but also in simple, severe anæmia, hemorrhages (generally easily seen).

Further, retinal hemorrhages are not unimportant diagnostic signs of pyæmia, particularly pyæmic endocarditis. They are not an absolutely fatal sign, as I myself saw in one case of puerperal pyæmia: this undoubted case of pyæmia, where besides the hemorrhages there were chills and slight icterus, recovered and the effused blood disappeared, leaving clear specks behind.

We have still to mention:

Pulsation of the retinal arteries in aortic insufficiency, embolus of the central artery in endocarditis (also frequently observed in chorea); lastly, after severe hemorrhages (particularly of the stomach, also of the intestine, and uterus) there occurs sudden amaurosis, not infrequently at first without any ophthalmoscopic condition, afterward usually with distinct atrophy of the optic nerve.

Alcoholic amblyopia shows a negative condition, or else hyperæmia, neuritis, atrophy; tobacco amblyopia shows a normal fundus optica, or atrophy; in amblyopia or amaurosis saturnina either there is nothing, or else there is hyperæmia and neuritic atrophy.

3. *Bacteria which come under Consideration in the Diagnosis of Internal Diseases.*

The object of the following sections is to summarize the notable peculiarities of the different microorganisms which have already been mentioned in different parts of the work. But this pertains not only to the characteristics of the different organisms and their appearances when stained, but also to the much more important phenomena of their growth in cultures and under animal experimentation. In regard to the methods of procedure we must refer to the text-books upon bacteriology, and particularly to the instruction in the bacteriological courses.

Staphylococcus pyogenes consists of small round cells which are usually found in irregular masses, but are never arranged in chains. The

spores of this, as of all other micrococci, have not yet been discovered. It grows upon gelatin even without much air, in the temperature of the room, still more rapidly and luxuriantly in a higher temperature. The gelatin becomes liquefied. Scratch cultures are either gold-yellow (*Staph. pyogen. aureus*), or white (*Staph. pyogen. albus*), or clear yellow (*cereus*), or citron yellow (*citreus*). Upon a surface it grows in round, light-brownish colonies looking like dots, which lose their sharp contour in the centre of the fluid. Mice, guinea-pigs, and rabbits die in from two to nine days after intravenous and peritoneal injections. Mice are killed with certainty only after the subcutaneous injection of a large amount, but none of the other animals named are killed by subcutaneous inoculation.

It can be stained by all of the aniline stains, also by Gram's method. It is the most common excitor of suppuration. It is found in abscesses, furuncles, in many cases of empyæma, purulent peritonitis; also in ulcerative endocarditis, etc., upon the valves of the heart; in pyæmia and acute osteo-myelitis, in the suppuration which complicates typhoid fever, etc.

Streptococcus pyogenes, resembling the first named by its round cells, forms chains by progressive portions pushing out in the same direction, which sometimes twist around each other. The separate ones often vary in size. It grows slowly upon gelatin, better upon agar, in the temperature of the room, but more rapidly in an incubator at a temperature of 27° C. [=98.6 F.]. It does not render gelatin fluid. The cultures upon a plate are extremely small, $\frac{1}{2}$ mm. diameter, yellowish to yellowish-brown in color. When inoculated by puncture it develops slowly and does not spread out upon the surface of gelatin. It is stained like the preceding. It is fatal to animals only when they have been previously weakened; it causes redness and swelling of the rabbit's ear. There is frequently found a pus coccus which particularly inhabits the lymph tracts, and causes progressive phlegmon; it is also found in pyæmia, especially puerperal pyæmia, likewise frequently in endocarditis.

Streptococcus erysipelatosus, morphologically and as regards its staining qualities, is like the preceding, but from the culture has thus far not with certainty been distinguished from it. In the rabbit's ear it causes a somewhat less active and extensive inflammation than

the streptococcus pyogenes. The inflammation has the symptoms of erysipelas.

Micrococcus gonorrhæus (gonococcus, compare Fig. 131, p. 427) usually occurs in the form of diplococci (roll-form), which often appear as tetrads in that the single coccus has a bright stripe, as the beginning of a new portion. It is difficult to breed, but is best done upon coagulated blood-serum, in a moist room at 32° C. [= 90° F.] (Bumm). It is stained with all of the aniline dyes, best with a concentrated watery solution of methylene-blue, stained after the method of Gram. It seems that it is pathognomonic of gonorrhœa if found within the pus-corpules. Outside of the pus-corpules, and even in epithelial cells, there also occur other diplococci of like form and staining qualities.

Bacillus anthracis (see Fig. 78, p. 280) is a rod, on an average about 5–10 μ long, 1–1.25 μ wide, with an abrupt end, often somewhat concave, with the inclination to develop into threads, without peculiar motion. It develops upon gelatin, potatoes, in alkaline urine at the ordinary temperature of the room, better at 36° C. [= 97° F.]. Sometimes there develop spores within spores (endogenous formation of spores). Gelatin is rendered fluid; when the amount of air is limited it develops poorly. Plate-cultures, after twenty-four hours, can be seen, when slightly magnified, as round grayish-black spots, or wavy, as if curled; upon potatoes the cultures are gray-white, somewhat elevated. It is fatal to susceptible nursing animals (mice, rabbits, guinea-pigs, certain kinds of sheep), even with the most minute inoculation and in a very short time. They are found in capillary blood and in all organs richly supplied with blood, particularly the spleen; with living bodies they do not develop spores, likewise usually no long threads. They are stained by all basic aniline coloring-matters, but they are easily spoiled if the covering-glass is made too hot; they become non-transparent if too strongly stained. They can also be stained by Gram's method.

Bacilli of malignant œdema are 3–3.5 μ long, 1–1.1 μ wide (Flügge), hence thinner and shorter than the anthrax bacilli, from which they are also distinguished by the rounded ends. They form rigid threads, often of considerable length. The individual bacillus forms spores, and these are so large that they distend the bacillus. In the dependent drops they manifest peculiar motions. They only grow

when oxygen is excluded, hence are anærobia. They develop in a reagent glass, best in gelatin to which is added a $\frac{1}{2}$ per cent. solution of grape sugar (Flügge). They flourish best at the temperature of the body. But they only grow at the lower end of a deep, very fine canal formed by sticking in a needle, and this canal is to be again closed. It fluidizes the gelatin and forms an offensive-smelling gas. It is stained by all the aniline dyes, but poorly after the Gram method. It is found in garden soil, in muddy water, in the blood of asphyxiated animals, etc. A little of the soil taken up on the point of a penknife and put under the skin of the abdomen of a guinea-pig or rabbit generally kills it by the invasion of the bacilli in one to two days (but sometimes, during this experiment, tetanus develops). In man it causes œdema and sometimes emphysema of the skin (see p. 55).

Typhus abdominalis bacilli (see Fig. 121, p. 391) are short, slender rods with rounded ends, thrice as long as broad, one-third as long as the diameter of a red blood-corpuscle. They have active motions (hanging drops). They form threads in cultures and hanging drops, but not in living animal bodies. It is questionable whether they form spores. They develop, at the temperature of the room, upon gelatin, agar, potatoes, without the character of the growth being characteristic. On the other hand, the potato culture is characteristic: for some days after the inoculation it would seem as if nothing had grown—at most that the surface of the potato around the inoculating scratches has a moist shimmer; in the whole circumference of this shimmer a very thick resisting turf of bacilli is present. But this peculiarity of behavior is not always manifest. Upon some potatoes it is not visible. Only that culture in which it is visible is demonstrative. It is best stained with carbol-fuchsine or Löffler's alkaline methylene-blue solution;¹ it is be washed only with water. It is stained after Gram's method. It regularly occurs in the intestine, spleen, liver, kidneys, also in the stools, and now and then in the blood in abdominal typhus [typhoid fever].

Tubercle bacilli (compare Fig. 40, p. 184, and Fig. 130, p. 426) are thin rods, 1.5–3.5 μ long (Flügge), frequently slightly curved or somewhat broken; they often form threads, and sometimes two or

¹ 30 c.cm. of concentrated alcoholic solution of methylene-blue, 100 c.cm. of one per cent. solution of potassium.

more lie close together. Very often they contain a number of egg-shaped spaces (spores), and then, when stained and slightly magnified, they sometimes look like chain micrococci. They have no independent motion. They grow best in a reagent glass upon an oblique coagulated, sterilized blood-serum and glycerin-agar, at a temperature of 37.5° C. (min. 30, max. 42). At best they grow very slowly, and hence the strictest care is necessary that it may not develop excessively. (For the technique, see special works.) In fourteen days there appear small, dull-white scales and specks, which, when slightly magnified, show an arrangement that reminds one of a tangled braid of hair (compare Fig. 130, p. 426). We can have it develop upon a covering-glass and then stain it by the method described on page 185. The experiment of inoculation is best made upon guinea-pigs, by placing some sputum, for instance, in the abdominal cavity. Generally, there is no reaction in the peritoneum. After two to three weeks the glands swell, and in four to eight weeks the animal dies.

Lepra bacilli, resembling small tubercle bacilli, are stained with aniline in the usual way, but also like tubercle bacilli; hence, like the former, there may be a double staining. They are found in leprous skin, in the glands, in the tissue-juices, in the nerves, also said to be found in the blood, etc., mostly in small and large cells resembling giant-cells. Cultures have not yet been successfully made.

Anthrax bacilli are like tubercle bacilli, only somewhat broader. They are stained with Löffler's potassic methylene-blue. Stain very carefully, then wash with dilute acetic acid. They are often easier and more certainly demonstrated by culture than by animal experimentation. They develop rapidly upon slices of potato at 35° C. [= 97° F.], as a brownish, slimy mass. It can be inoculated upon guinea-pigs; some maintain that puppies are better. Death follows after an indefinite time, and nodules occur in various organs (one of the first symptoms is a swelling of the testicles).

The *cholera bacillus* (see Figs. 117, 118, p. 389, and Fig. 119, p. 390) has been very fully described upon p. 389f. It has there been pointed out that the certain proof is only made by culture. A mucous floccule from the stools or from the linen is taken, placed in a small glass with a fluid five to ten per cent. culture-gelatin, from which plate cultures are prepared. After standing

one to two days in an ordinary temperature, small white points are seen at the bottom which gradually reach the top, and, by rendering the gelatin fluid, form deep, funnel-like depressions. At the bottom of the funnel lie the whitish cultures, not larger than a pin-head. By making an inoculation-puncture in the reagent glass there is also produced a funnel, which, from the rapid thinning of the fluidized gelatin, contains a large bubble of air. The lower part of the inoculation-puncture resembles a thin thread, which in some places is as clear as glass, and looks like an empty capillary tube, while in other places the culture, sunk together, consists of gray and whitish threads. In the dependent drops there is active motion, like a swarm of gnats, and the bacilli strive to reach the border. Larger plate-cultures, under a slight magnifying power, show a peculiar lustre and an arrangement as if they were a collection of shivered glass. The inoculation is made upon guinea-pigs, the contents of whose stomach is made alkaline by 5 c.cm. of a five per cent. solution of soda (using an œsophageal catheter); the intestine is made quiet by injecting into the peritoneum 1 c.cm. tinct. opium for each 200 grammes weight [of the animal]; then, by means of the œsophageal catheter, there is introduced 10 c.cm. of the deposit of the cholera bacilli in bouillon. After two days the animal dies (often without diarrhœa, always without vomiting): the condition of the intestine is found to be exactly like that in cholera. In the intestines are abundant cholera bacilli.

Bacilli of Finkler-Prior (see Fig. 120, p. 391) resemble cholera bacilli, but are thicker and plumper; but in the colored preparations they cannot certainly be distinguished from Koch's comma bacillus. Plate-cultures develop remarkably rapidly, and render gelatin fluid in much larger quantity than cholera bacilli. This difference in the rapidity of development is the best mark of distinction. When slightly magnified, the cultures seem to be very finely and uniformly granular, of a yellowish-brown color. The inoculation-puncture, likewise, shows a much more rapid fluidization, but not the clear threads beneath the upper "air-bubble," but an irregularly wide canal, which reminds one of a stocking. After a week the whole test-tube becomes fluid. Also, the inoculation of animals gives a different result—stinking intestinal contents, while in cholera they smell stale.

INDEX.

- A** BBEÉ, reference to, 185
- Abdomen, distention of, from inflammatory exudation, 314
 distention of, causes of, 309
 drawing-in of, causes of, 309
 inspection of, 313
 sound on percussing, 109
 topography of, 297
 tumors of, dullness over, 306
 value of measuring circumferences of, 316
- Abdominal affections, severe hiccough in, 540
 breathing disappears in paralysis of diaphragm, 90
 contents, position of, illustrated, 298
 diseases, headache with, 483
 distention, effect on diaphragmatic breathing, 90
 inflammation, restricting action of the diaphragm, 90
 organs, irritative cough from, 165
 pressure, importance of, in defecation, urination, and labor, 540
 reflex defined, 496
 increase of, in intercostal neuralgia, 496
 unilateral, absence of, 587
 swellings, solid, feeling of resistance with, 116
 typhus. *See* Typhoid Fever.
 wall in emphysema, 84
- Abnormal constituents of urine, section on, 435-442
 sounds over lungs, 125
- Abscess, deep, revealed by œdema, 54
 due to dentition, 286
 irregular enlargement of liver from, 322
 large, peptonuria with, 439
 of abdominal wall, pain from, 309
 case of, which simulated meteorism, 309
 of chest, wall, weakened vocal fremitus with, 158
- Abscess of liver, prominences on liver from, 326
 tenderness with, 324
 of lung, effect of, on thorax, 87
 elastic threads in sputum of, 177
 hæmatoidin in sputum in, 172
 lung tissue in sputum in, 172
 purulent sputum in, 169
 of spleen, unequal enlargement with, 335
 of tonsil, 290
 perinephritic, cause of pus in urine, 419
 retro-pharyngeal, cause of cyanosis, 43
- Abscesses, staphylococcus pyogenes found in, 603
- Absolute deadness, 108
- Abulia defined, 472
- Accidental murmurs, 229
- Accommodation in breathing, 95
 of valvular deficiency, 195
 paralysis of, 563, 568
- Acetic acid, excess of, in stomach, 345
- Acetone, a product of decomposition of albumin, 449
 diaceturia with, 447
 odor of breath in diabetes, 285
 of urine from, 414
 source of, in urine, 449
 test for, 414, 449
 when occurs, 414
- Acetonuria, test for, 448
 when occurs, 448
- Acholic stools, color of, 373
 odor of, 371
- Achorion Schönleinii, in vomit, 366
- Achroödextrin, from starch, 353
- "Acid curve" of urine in twenty-four hours, 404
 intoxication in diabetic coma, 449
 reaction of urine, usual, 403
 urine, calculi found in, 433
- Acids, fatty, needles of, in sputum, 180

- Acids, salivation caused by, 289
- Acoustic amnesia, 552
 ganglion, 461
 nerve, 551
 disease of, 572
 injury of, 572
- Acromegalia, defined, 583
- Actinomyces in pleural exudation, 161
 in sputum, 175
 described, 189
 with inflammation of mouth, 290
- Acuoxylon, 140
- Acute diseases not recurrent, 22
- Adaptation in breathing, 95
- Addison's disease described, 48
- Egophony described, 159
- Æsthesiometers, Sieveking's, use of, 474
- After-sensibility, defined, 478
- Age, location of heart in, 192
 lung boundary differences due to, 125
 old, area of heart dulness in, 205
 position of apex beat in, 198
 variations of percussion note by, 120
 of pulse affected by, 234
- Aged, venous thrombosis in marasmus of the, 268
- Agcuis, with total hemianæsthesia, 574
- Agrammatismus defined, 561
- Agraphia, 552, 553
 amnesia may simulate, 556
 an aphasic symptom, 561
- Air in peritoneal cavity, auscultation and percussion of, 318
 in peritoneum, a cause of diminished area of liver-dulness, 331
 -passages, stenosis of, inspiratory pressure diminished in, 164
 sound of, on percussing over cavity containing, 109
- Akataphasia defined, 561
- Albumin, acetone a product of decomposition of, 449
 boiling and nitric acid test, 436
 -curve, 437
 decomposition of, leucin and tyrosin products of, 432
 ferrocyanide of potassium test, 436
 Geisler's test papers, 436
 in pleural fluid, 160
 in serous sputum, 169
 in sputum, 190
 in urine, 435, 439
- Albumin in urine after exertion, 437
 makes the bismuth test for sugar uncertain, 444
 significance of, according to amount, 420
 must be removed in determining nitrogen and urea, 434
 physiological, small amount in urine, 405
 picric acid test, 436
 qualitative tests for, 435
 quantitative tests for, 437
 rare forms of, 439
- Albuminous bodies, digestion of, 345
- Albuminuria, a cause of dropsy, 53
 casts scanty in physiological, 422
 cyclic, 435, 437
 œdema with, 54
 renal casts in urine, diagnostic value of, 422
 retinitis with, described, 601
 when occurs, 435
- Alcohol amblyopia, central scotoma in, 569
 formation of, in stomach, 345
 headache in poisoning with, 483
 paralysis, lessened excitability in, without EaR in, 525
 poisoning, odor of breath in, 285
 uses of, effect on disease, 21
- Alcoholic amblyopia, 602
 poisoning, delirium tremens from, 471
 tremor, 531
- Alcoholism, trembling of tongue of, 287
 lipæmia in, 280
- Alderton, reference to, 199
- Alexia, 552
- Alkalies, salivation caused by, 289
- Alkaline fermentation in urine, from micrococci and bacilli, 425
 odor of, 404
 turbid urine from, 412
 reaction of urine, sometimes in health, 403
 urine, simple, distinguished from urine alkaline from fermentation, 426
- Allochiria defined, 478
- Amaurosis after severe hemorrhages, 602
 saturnina, 602

- Amaurosis, temporary partial, significance of, 571
 uræmic, 601
 with albuminuria, 441
 Amblyopia, alcohol, 569
 alcoholic, and tobacco, 602
 Ammoniacal fermentation of urine, 402
 odor of stool from urine, 372
 Ammoniaco-magnesian phosphate in urine described, 431
 Ammonio-magnesian phosphates in urine, 402
 Amnesia, 554, 556
 acoustic and visual, 552
 may simulate atactic aphasia, word-deafness, word-blindness, agraphia, 556
 mixed with aphasia, 555
 Amnesic aphasia, 553, 554
 Amœba coli, 391
 Amphoric breathing, 159
 corresponds with metallic râles, 153
 defined, 148
 with cavities in lungs, 147
 Amphoteric reaction of urine, 404
 Amyloid degeneration of intestines, fats poorly absorbed in, 371
 disease of spleen, 335
 kidney, albuminuria with, 435
 casts in urine of, 422
 liver, surface of, 325
 Amylolysis, disturbed in super-acidity of stomach, 356
 incomplete, shown by microscopical examination of vomit, 365
 Amyolytic period of digestion, 342, 343
 shortened, 346
 Amyotrophic lateral sclerosis, 580, 586
 EaR with, 524
 increase of tendon reflex in, 500
 lessened excitability without EaR in, 525
 partial EaR with, 525
 An, an abbreviation for anode, 506
 Anæmia, absence of pulse with, 243
 a cause of dropsy, 53
 albuminuria with, 435
 alkalescence of blood diminished in, 283
 caused by anchylostoma duodenale, 382
 color of blood in cases of severe, 271
 Anæmia, diminished hæmoglobin in, 275
 dizziness with, 471
 due to bothriocephalus lata, 380
 to tapeworm, 377
 headache with, 483
 heart-sounds often strengthened in, 217
 in contrast with chlorosis as regards diminution of red corpuscles, 276
 leucocytosis in, 278
 may be concealed by redness of face, 42
 microcytes and macrocytes in, 276
 microcythæmia with, 276
 murmurs heard in, 229
 oligocythæmia in, but not in chlorosis, 274
 peculiarities of blood in, 275
 pernicious, leucin and tyrosin in urine of, 432
 retinal hemorrhages in, 562
 uric acid increased in, 434
 poikilocytosis with, 277
 polyuria in, 406
 progressive venous pulse with, 268
 red corpuscles diminished and paler in, 275
 retinal changes in, 602
 splenic, enlargement of spleen in, 335
 stools to be examined for parasites in, 377
 subacidity of stomach in, 356
 subjective sensations of vision in, 571
 sensitivity of hearing in, 572
 tracing of pulse of, 248
 urine of, very pale, 408
 should be examined for bacillus tuberculosis, 426
 venous humming in, 269
 vertigo with, 472
 Anæmic heart-murmurs, explanation of, 230
 propagated from venous trunks in chest, 269
 murmurs, 229
 necrosis of pons and medulla, 462
 Anæsthesia, cause of, 459
 defined, 477
 important distinction with reference to distribution of nerve, 479
 of dorsum of forearm, caution regarding, 485

- Anæsthesia of mucous membrane in
 hysteria, 497
 partial, cause of, 459
 sensory, in gross hysteria, 534
 total, rare, 479
- Analgesia defined, 479
- Anamnesis defined, 17
 mode of taking, 19
 scheme for, 26
 unreliable regarding spasms, 533
 what it comprises, 19, 20
- Anarthria defined, 548
- Anasarca. *See* Edema.
- Anatomical disease, symptoms of, 587
 divisions of the chest, 76
 variations, cause of unequal pulse
 in symmetrical vessels, 257
- Anatomy of heart, 191
 of liver, 319
- Anchylostoma duodenale, described
 and illustrated, 382
- Anchylostomen in vomit, 364
- Anchylostomiasis, 382
 feces of, contains Charcot's crystals,
 388
- Aneurism, absence of pulse with,
 243
 aortic, pulsation in, 204
 blood in sputum from rupture of,
 167
 caution regarding, when making
 exploratory puncture, 162
 difficulty in distinguishing from
 apparent enlargement of heart,
 210
 effect of, upon pulse in one of two
 symmetrical vessels, 257
 increased circumference of thorax
 in, 163
 near œsophagus, caution regard-
 ing sounding œsophagus, 294
 neuralgia from pressure of, 483
 of abdominal aorta, 255
 of aorta, and other arteries, effect
 on pulse, 245
 crystals in sputum in hemor-
 rhage into lungs, 180
 cyanosis from, 43
 description of, 254
 how distinguished from em-
 pyema pulsans, 102
 pressing on the larynx, 75
 pressure by, upon recurrent
 nerve, 296, 599
 of arch of aorta, affects vessels of
 left side, 255
- Aneurism of ascending aorta, affects
 vessels of right side, 254
 of descending aorta, 255
 of innominate artery, 255
 of minute arteries of brain a cause
 of hemorrhage, 577
 of pulmonary artery, 255
 phenomena of, 40
 pressing heart forward, 203
 pressure on nerves from, 469
 pulsation of, near stomach, 302
 recurrent paralysis a symptom of,
 600
 simulates enlarged heart, 209
 systolic pulsations at base of heart
 in, 203
- Angina, cause of enlargement of
 tongue, 286
 hepatica, herpes with, 50
 Ludovici, 594
 cause of cyanosis, 43
 necrotica, tonsils in, 290
 pectoris, in organic disease of the
 heart, 577
 pulse in, 240
- Angle, epigastric, 82
 in emphysematous thorax, 83
 of Louis, 84
 in phthisical thorax, 84
- Angulus Ludovici defined, 76, 78, 81,
 82
- Anhidrosis, sudamina after long-con-
 tinued, 50
- Anidrosis, 38, 581
 defined, 37
- Anilin, color of blood in poisoning by,
 270
- Animal parasites, examination of stool
 for, 377
 exotic, 21
 in sputum, 182
 in urine, section on, 424
 section on, 377
 two found in blood, 283
- Ankylostoma, 41
- Ankylostoma-anæmia, 54
- Anodal closure, result of, 506
- Anode, at the, contraction only at the
 opening of the current, 506
 colors blue litmus red, 505
 positive pole, 504
- Anomalics of breathing, 89
- Anorexia, defined, 472
- Anosmia, when it occurs, 573
 unilateral, associated with hemi-
 anæsthesia, 573

- AnOTe, occurrence of, important sign in tetanus, 526
- AnSC, 518, 519, 520, 521, 523
minimal, determination of, 515
- Anterior column of spinal cord, 455
cranial fossa, effect of lesion of, 457
gray columns, 492
disease of, EaR with, 524
horn, characteristic sign of cerebral and spinal paralysis above, 494
excitability of, increases skin reflex, 496
ganglia, 455, 456, 492
part in skin reflex, 496
results of disease of, 490
horns, disease of, tendon reflex diminished in, 500
effect of lesion of, 456
gray, EaR with lesions of, 524
preside over muscular tonus, 528
office of, 455
pyramids, 454
roots of spinal nerves, 455
compression of, results of, 491
- Anthrax bacilli, cultures, 606
described, 280, 606
illustration of, 280
- Antifebrin, urine after taking, 451
- Antiperistalsis of stomach, 303
- Antipyrine, urine after taking, 451
- Anuria from obstruction by echinococcus, 425
in acute nephritis, 407
in hysteria, 579
- Anxiety, effect of, on amount of urine, 401
pulse frequent in, 240
subjective expression of, in dyspnoea, 99
- Aorta, anatomical relations of, 254
aneurism of, pulsation in, 204
paralysis of recurrent nerve by pressure from, 538
pressure by, upon recurrent nerve, 296
relation of left carotid to, clinical importance of, 463
sclerosis of, shown by stronger aortic second sound, 217
stenosis of, commencement of, absence of apex-beat in, 202
- Aorta, stenosis of, from enlarged retroperitoneal glands, 341
murmur of, where heard, 224, 225
pulse in, 252
tracing of pulse in insufficiency and stenosis of, 249
various phenomena of, 253
- Aortic and tricuspid insufficiency, combined arterial and venous crural sounds with, 269
first sound, softest heart sound, 217
insufficiency, 194, 195
and stenosis, effects of, 195
opposite condition of pulse in, 252
arterial liver pulse in, 257
capillary pulse in, 256
double sound over crural artery in, 259
effect upon second sound, 258
increased arterial pulsation with, 257
murmur of, where heard, 224, 225
progressive venous pulse with, 268
pulsating splenic tumor with, 335
pulsation in aorta with, 254
of retinal arteries in, 602
pulse in, 251
with, 253
tracing of pulse of, 249
weakening of first sound at apex in, 219
- stenosis, 194
absence of pulse with, 243
paleness in, 41
pulse with, 242, 244
sounds with, 258
weakening of aortic second sound in, 219
- valve, insufficiency of, sounds in, 217
valves, where best heard, 213, 214
- Ape-hand in paralysis, 544
- Apex-beat of heart, examination of, 197
absent in pericardial adhesion, 202
and heart-beat not to be confounded, 201, 203
causes of, 198
change in width and strength of, 200

- Apex-beat coincides with systole of heart, 212
 displaced by retraction of lung, 209
 displacement of, 199
 doubling of, 202
 in determining apparent enlargement of heart, 210
 in dislocation of heart, 211
 position of, in children, 198
 with pericardial exudation, 202
 strength and breadth of, a sign of hypertrophy, 200, 201
 weakening of, causes, 201
- Apex, first sound at, strengthened in mitral stenosis, 218
 sounds of heart heard at, 214
 mitral murmurs at, 224
 murmur of stenosis of left auriculo-ventricular opening, heard at, 224
- Aphasia, with albuminuria, 441
 atactic, 552, 553, 554, 559
 cause of, 555
 phenomena of, 558
 Charcot's diagram of, 560
 Lichtheim's diagram of, 557
 localization of, 555
 mixed with amnesia, 555
 mode of procedure in testing for, 555, 556
 motor, 559
 sensory, phenomena of, 558
- Aphasic disturbances, 549
- Aphonia, 74
 a result of recurrent paralysis, 599
 how caused, 597
 in paralysis of recurrent nerve, 538
 tone of cough in, 166
- Aphonic patients, 159
- Aphthæ, in vomit, 366
- Apices of lungs, 81, 82
 boundaries, 122
 caution regarding slight deadening over, 126
 cavities in, 131
 diminished in phthisis, 137
 disease of both, comparative percussion in, 125
 dry râles with catarrh of, 150
 large râles in, a sign of cavity, 152
- Apices of lungs, percussion note over, 120
 position of, changed by diseased condition in neck, 137
 relatively deadened sound over, 114
 shrunken, open tympanic sound over, 110
 sometimes enlarged, 136
 systolic subclavian murmur at, 259
 tuberculosis of, increased vesicular breathing in, 144
 deadened sound with, 129
 pain with, 102
 prolonged expiration in, 145
 tympanic resonance over, in beginning, 127
 tympanic sound over, in beginning tuberculosis, 112
 upper limits of, 125
- Aplasia of lung, deadened sound over, 114
- Apnœa, 92
 contracted pupils in, 93
 jerking of muscles in, 93
- Apoplectic attack, defined, 585
 habit, 575
- Apoplexy. *See* Cerebral hemorrhage.
 aphasia after an attack of, 555
 decubitus after, 582
 disturbance of consciousness in, 470
 glycosuria with, 443
 heart and vessels to be examined, 577
 pulse in, 245
 syncope as a precursor of, 471
 tiinnitus aurium sometimes a precursor of, 573
 transitory albuminuria with, 435
- Arc de cercle, 468, 534
- Area of heart dulness, enlargement of, 208
- Areometer, use of, in determining specific gravity of urine, 403
- Arm, motor centre for, 454
 nerves of, 485
 paralysis of the muscles of, 542
 points of electrical irritation upon, illustrated, 509, 510
 position during electrical examination, 511

- Arsenic, poisoning by, cause of hæmato-jaundice, 47
 -paralysis, lessened excitability in, without EaR, 525
- Arterial liver-pulse, when liver enlarged, 322
 pulse, propagated through the capillaries, 268
 sclerosis, abnormal pulsations in arteries in, 256
 condition of arteries in, 256
 gallop rhythm of heart with, 221
 pulse with, 244, 245
- Arteries, examination of, 234
- Artery, basilar, 461
 middle cerebral, 462
 hemorrhages and emboli most frequent in, 463
 largest and most important of the brain, 462
 ophthalmic, 461
 posterior cerebral, portion of brain it supplies, 462
 communicating, 461
 vertebral, 461
- Arthritis deformans, 467, 583
 pain in spine with, 483
- Arthropathia in nervous diseases, 583
- Articular neuralgia, 484
- Arythm of pulse, 241
- Arythmic breathing, 92
- Ascarides in ductus choledochus, a cause of jaundice, 47
- Ascaris lumbricoides described, and symptoms of, 380
 eggs of, 381
 illustrated, 381
- Ascites, abdominal veins enlarged with, 314
 associated with cirrhosis of liver, 325, 326
 cause of diminished area of liver dulness, 331
 caused by stasis, 314
 chylous, 318
 defined, and diagnosis of, 313
 due to venous engorgement, 260
 effect on form of chest, 86
 employment of deep breathing in, 323
 may cause venous stasis, 262
 press diaphragm up, 322
 tympanitic sound with distention of abdomen from, 130
 value of tapping for diagnosis, 318
- Asiatic cholera: *See Cholera Asiatica*
- Aspergillus fumigatus (mould) in sputum, 175, 190
- Aspermatism, 580
- Asphyxia, local, in neuroses, 577
- Associated movements in paralysis, defined, 535
- Asthma, bronchial, expiratory dyspnoea peculiar to, 99
 rapid breathing in, 94
 relation of Curschmann's spirals to, 180
 casts in sputum of, 173
 cause of cyanosis, 43
 Charcot-Leyden's crystals in, 182
 in sputum of bronchial, 174
 in connection with disease of the nose, 575
 oxalate of lime in sputum of, 182
 simulation of, 19
 spirals in sputum of, 175
 uræmic, 440
- Asymmetry of breathing described, 91
 of pulse, 245
 of skull, 465
- Ataxia defined, 527
 and explained, 529
 difficulty of distinguishing, from tremor, 531
 of upper extremity, 561
 when it occurs, 529
- Ataxic aphasia, 552, 553
 cause of, 555
- Atelectasis in children, 98
- Atelectatic crepitation, inspiratory, defined, 154
- Atheroma of aorta, systolic murmurs with, 254
 of vessels a cause of hemorrhage of brain, 576
- Athetosis defined, 535
- Atonia in paralysis, 489
- Atonic atrophic paralysis, 494
 paralysis, 494
- Atrophic paralysis, 490
 fibrillary contractions in, 532
 partial EaR in, 525
 two forms of, 493
- Atrophy and paralysis, parallelism between, 493
 disunion of, 493

- Atrophy defined, 35
 disturbance of vision from, 601
 of inactivity, 491, 494
 of muscles, 489
 varieties of, 490
- Atropine, effect of, on pupil, 567
 poisoning, red skin in, 41
- Auenbrugger, reference to, 104, 105
- Aura, a prelude of epileptic convulsion, 532
- Auricle, its relation to venous pulse, 264
 left, location of, 191
 right, location of, 191
- Auricular semi-lunar murmur, where heard, 224
- Auricularis magnus nerve illustrated, 485
- Auriculo-temporal nerve, illustrated, 485
- Auscultation of heart, 211
 points of election for, 213, 214
 of intestine, 312
 of lungs, 138
 to be *after* percussion, 140
 of peritoneal cavity, 318
 of pulse, 257
 of stomach, 307
 of veins, 268
 of voice, 156
 when it may be omitted, 158
 of whispered voice, 159
 results of, in aneurism of aorta, 254
 value of, when small surface of lung is involved, 126
- Autocthonous clots, effect on pulse, 245
- Auto-intoxication,
 by acetonuria, 448
 by diaceturia, 448
- Auxiliary muscles of inspiration and expiration, 540
 named, 96
 of respiration, aid in thoracic breathing, 99
- Axillary lines defined, 76
 nerves illustrated, 486
- Azoöspemia, 580
- B**AAS, reference to, 151
 Baccilli, reference to, 159
- Bacillus of anthrax, illustrated and described, 280
- Bacillus described, cultures of, 604
 distinguished from Koch's comma bacillus, 607
 in sputum from mouth, 188, 289
 in urine, 425
 resembling tubercle bacillus, 400
 of Finkler-Prior described, cultures of, 390, 607
 of glanders, found in blood, 282
 of malignant œdema described, 604
 of tuberculosis, absence of, 187
 discovery of, made elastic threads in sputum less valuable, 177
 found in blood (rare), 281
 in sputum, 175
 in urine, sign of tuberculosis of urinary passages, 426
- Back, nerves of, too deep for electrical examination, 511
- Bacteria, casts of, in pyæmia, 424
 found in hyaline casts, 423
 intestinal, in stools, value of, 388
 in urine, 399
 of nephritis, 427
 section on their diagnostic value, 602
 urine made cloudy by, 402
 turbid from, 413
- Bälz, reference to, 174, 183
- Bamber, reference to, 191
- Band-box note with emphysema, 135
- Barrel-shaped chest, 83
- Bartels, reference to, 395
- Basch, reference to, 245
- Basedow's disease, blowing murmurs over lymphatic glands in, 259
 heart-beat in, 201
 hemidrosis in, 38
 increased strength of heart-sounds in, 216
 palpitation of heart in, 577
 pulse in, 240
 tremor of, 531
- Basilar artery, 461
- Baths, cold, value of pulse in showing result of, 253
 induce perspiration, 37
- Baumann, reference to, 432
- Berger, reference to, 190
- β -oxybuteric acid in urine of diabetic coma, 449

- Biceps reflex**, 499
 -tendon reflex, 498
- Biedert**, reference to, 164, 186
- Bienstock**, reference to, 388
- Biermer**, reference to, 104, 135, 136
- Bile-acids in urine**, diagnostic value of, 443
 small amount of, in normal urine, 405
 value of, in jaundice, 46
 coloring matter of, in urine, 410
 deficiency of, effect on absorption of fat, 371
 effect of, on color of stools, 373
 not usually found in watery stools, 374
 -pigment in sputum in icterus, 172
 -pigments and bile-acids, section on tests for, in urine, 442
 vomiting of, 361
- Biliary colic**, vomiting in, 358
 engorgement, tenderness with, 324
- Bilirubin**, 46
- Bismuth test for sugar in urine**, 444
 uncertain if there is albumin, 444
- Bizzozero**, reference to, 271
- Black color of vomit**, from ingestion of iron, and in acute lead-poisoning, 360
- Bladder**, alkaline fermentation in, cause of turbid urine, 412, 413
 carcinoma villosum of, particles of tissue in urine from, 421
 completely emptied by act of urination, 408
 crises (painful tenesmus) in tabes, 580
 depot of pus in the neighborhood of, cause of hydrothionic urine, 415
 distended, diagnosis of, 398
 disturbance of, 587
 examination of, 398
 importance of emptying in examining abdominal organs, 341
 paralysis of, 590
 position of, 398
 retention of urine in, a cause of diminution of secretion, 408
 tenesmus of, causes of, 400
- Blindness**, central, 568
 result of lesion of corpora quadrigemina, 570
- Blood**, abnormal additions to, 280
 alkalescence of freshly drawn, 283
- Blood**, arterial, brighter in color than venous, 270
 bacillus of typhoid fever found in, 281
 -casts in urine, sign of renal hæmaturia, 424
 chemical examination of, 283
 color of, in cases of poisoning by various substances, 270
 coloring matter of, in urine, when occurs, 410, 441
 corpuscles, change in form and size of red, in anæmia, 275
 counting of, 274
 destruction of in intermittent fever, 434
 in stools, 387
 normal proportion of white to red, 278
 pathological diminution of red, 275
 proportion of white to red increased in anæmia, 275
 red, number of, in a cubic millimetre of blood, 275
 crystals in, in leukæmia, 279
 diseases of, cause of paleness, 40
 entire amount equals about one-thirteenth weight of body, 270
 examination of, 270
 from nose and throat, diagnosis of, 171
 in sputum from rupture of aneurism, 167
 intensity of color of, 270
 in urine, form and appearance of, 412, 416
 causes albuminuria, 435
 -jaundice, 46
 large effusions of, urobilin in urine with, 409
 -making organs, development of fat in disease of, 41
 microscopical examination of, 273
 mode of examination of, for microorganisms, 282
 morphological constituents of, importance of, in diagnosis, 270
 movement of, in heart, 193
 murmurs, 229
 normal structures of, 273
 pathological conditions of, as revealed by the microscope, 273
 -pressure, diminished amount of urine when reduced, 407
 how measured, 245

- Blood, pure, changed by gastric juice
 in stomach, 362
 seldom vomited, 362
 spectroscopic condition of, 272
 examination of, valuable in
 three classes of cases, 272
 time it takes to coagulate after
 withdrawn, 283
 tracing of pulse after loss of, 248
- Bloody sputum described, 169
 vomit (hæmatemesis), 361
- Blushing, 42
- Boas's test for free muriatic acid, 351,
 367
- Boiling and nitric acid test for albu-
 min in urine, 436
- Boilliaud, reference to, 552
- Bone reflexes, 500
- Bones and joints in nervous diseases,
 section on, 583
 arrest of growth of, in paralysis,
 583
 sound on percussion of, 109
- Borborygmi, 312
- Border of lungs, abnormal position of,
 125
- Bornhardt, reference to, 35
- Bothriocephalus lata described, 379
 illustrated, 379
- Böttcher, reference to, 503
- Boulimia defined, 472
- Boundaries of lungs changed, 136
 method of determining, 117,
 119
 parietal, of organs, 116
 of liver, spleen, and kidneys
 illustrated, 321
- Bowels, disturbance of, from venous
 engorgement, 261
 obstruction of, peculiar grass-
 green vomit with, 361
 vomiting of feces in occlusion of,
 364
- Brachial plexus, Erb's point, 510
 paralysis of, cause of anæ-
 sthesia of the region of the
 median nerve, 487
- Brachycardia, 238
- Brachycephalus, 465
- Brain, abscess of, from disease of the
 nose, 576
 hearing in, 572
 relation of, to disease of the
 lungs, 576
 sensibility of cranium to pres-
 sure with, 466
- Brain, absence of cough in disease of,
 165
 aneurism of minute arteries of, a
 cause of hemorrhage, 577
 bloodvessels supplying, section on,
 461-463
 concussion of, glycosuria after, 443
 cysticerci in, from tænia solium,
 578
 difficulty of local examination of,
 463
 diseases of, anomalies of breath-
 ing in, 91
 dyspnoea in, 94
 headache with, 482
 inherited, 20
 disturbance of vision by lesion at
 base of, 460
 effect of local disease at base of,
 457
 habit which predisposes to hemor-
 rhage of, 575
 hearing in local disease of, 572
 hemorrhage and softening of, re-
 lation to diseases of the heart,
 576
 inequality of pupils in unilateral
 affections of, 567
 lateral view of, 452
 lesion at base of, paralysis of mus-
 cles of one eye in, 565
 local diseases of, diagnosis of, 586
 hemidrosis in, 38
 thrombosis of vessels of, 576
 paralysis of cortex of, early spasms
 in, 494
 postures assumed in diseases of, 33
 retinitis in syphilis of, 562
 slight amount of vomit in diseases
 of, 360
 slow pulse in diseases of, 237
 symptomatic epilepsy in anatomi-
 cal diseases of, 533
 symptoms, general, enumerated,
 585
 syncope in chronic diseases of, 471
 syphilis of, changes in fundus
 oculi in, 601
 tuberculous nature of diseases of,
 if nutrition is poor, 575
 tumors of, disturbance of con-
 sciousness with, 471
 migraine with, 483
 vertigo with, 472
 value of pulse in showing com-
 plicating disease of, 253

- Brain, vomiting from irritation of, 358
 in rapidly developing diseases
 of, 578
 occurs suddenly in diseases of,
 359
- Breath, odor of, importance of, 285
 short, in deformity of chest, 88
- Breathing. *See also* under Respiration.
 abdominal, 90
 disappears in paralysis of
 diaphragm, 90
 anomalies of, 89, 91
 from CO₂ in blood, 92
 asymmetry of, described, 91
 costal type of, in women, 90
 deep, during auscultation, 141
 diaphragmatic, interfered with,
 86
 irregularity of, 92
 obstructed, 74
 of compression defined, 147
 painful, effect of posture upon,
 32
 thoracic, replaced by diaphrag-
 matic, 90
 transition, explained, 149
 undefined, explained, 148
- Brenner, reference to, 572
- Brick-dust sediment in urine ex-
 plained, 402, 429, 430
- Brieger, reference to, 356, 372, 432
- Bright's disease, choked disc with,
 601
 dropsy of, explained, 440
- Broca, reference to, 552, 553, 555
- Bromine, urine after taking, 450
- Bronchi, epithelium in sputum from,
 176
- Bronchial asthma, casts in sputum of,
 173
 Charcot-Leyden's crystals in
 sputum of, 174, 182
 relation of Curschmann's
 spiral to, 180
 breathing, how conducted to the
 ear, 143
 difficult to distinguish from
 vesicular, 143
 normal, described, 141
 not to be confounded
 with pathological,
 141
 pathological, explained,
 164
 difficulty of, weakened in case
 of filled cavity, 147
- Bronchial catarrh, 94
 cause of diminished vesicular
 breathing, 145
 kind of râles with, 150
 tubes, closure of, weakened vocal
 fremitus with, 158
 pieces of, in sputum, 172
 rapid breathing in diseases
 of, 94
 sensitiveness of, a cause of
 cough, 165
- Bronchiectasis, 131
 amount of expectoration in, 168
 friction sounds with, 156
 odor of sputum in, 171
- Bronchiectatic cavities, micrococci in
 sputum from, 189
 ringing râles with, 153
- Bronchitis, acute, mucus in first stage
 of, 168
 a ferment in sputum of, 190
 alveolar epithelium in sputum of,
 177
 amount of expectoration in, 168
 capillary in children, 98
 caused by dust, 21
 Charcot Leyden's crystals in spu-
 tum of, 174, 182
 chronic, morning cough of, 165
 cyanosis in, 43
 diffused, râles with, 150
 fetid, crystals in sputum of, 181
 micrococci in sputum in, 189
 odor of sputum in, 171
 relation of, to brain disease,
 576
 sputum in three layers in,
 169, 174
 fibrinous tubes in sputum of acute
 and chronic croupous, 172
 increased vesicular breathing in,
 144
 jerking, inspiration in, 145
 metallic râles with, 150
 non ringing râles with, when
 there is a broncho-pneumonic
 deposit, 153
 prolonged expiration in, 145
 purulent, coin-shaped sputa in,
 169
 putrid, leptothrix buccalis in spu-
 tum of, 184
 tyrosin in sputum of fetid, 182
 vital capacity of lungs in, 164
- Bronchophony described, 158
- Broncho-pneumonia in children, 98

- Bronchus, primary, when open tympanitic sound is heard over, 111
stenosis of, 98
- Bronze skin, 48
- Bruit de pot fêlé* described, 134
where it occurs, 134
- Bubbling râles, 154
- Buccinator nerve, illustrated, 485
- Bulb, EaR with disease of the motor nerves of, 524
- Bulbar paralysis, absence of bone reflex in, 500
of reflex of pharynx in, 497
cyanosis in, 43
EaR with, 524
increased secretion of saliva in, 577, 578
lessened excitability in, without EaR in, 525
paralysis of diaphragm in, 90
of recurrent nerve with, 538, 599
position of the soft palate in, 538
power to cough lost in, 165
quick pulse with, 577
rigid thorax in, 91
salivation in, 289
speech in, 548
pulse (bulbus jugularis), 265
- Bulbus jugularis, 263, 265
murmur at, in tricuspid insufficiency, 268
- Bumm, reference to, 604
- Bursa omentalis, 299
- Butyric acid, formation of, in stomach, 345
- Buzzing felt near the heart, 204
- C** abbreviation for contraction.
- Ca, abbreviation for cathode, 506
- Cachectic conditions, chloride of sodium in urine diminished in, 434
- Cachexia, chronic, disturbance of consciousness in, 471
defined, 35
delirium in, 471
diminished volume of abdomen in, 309
general atrophy in, 491
indican in urine of severe, 409
leucocytosis in, 278
malarial, 41
oxaluria in, 430
- Cachexia, poikilocytosis in, 277
severe, ecchymosis in, 51
state of skin in, 36
temperature in, 64
urea diminished in all kinds of, 434
- Cadaveric odor of breath, 285
- Cæcum, to be examined in sudden obstipation, 369
- Calcifications in pericardium, friction sounds from, 232
- Callus, cause of pressure on nerves, 469
- Camman, reference to, 140
- Cancer. *See also* Carcinoma.
cachexia of oxaluria with, 430
poikilocytosis in, 277
of head of pancreas, a cause of jaundice, 47
of rectum, pain at stool in, 370
of stomach, alkaline vomit in, 366
palpation of, 303
use of sound in, 302
navel on liver in carcinoma of liver, 325
paleness in, 41
- Cancerum oris, description of, 288
- Cantani, reference to, 430
- Cantharides, fibrin in urine in poisoning by, 439
- Capillaries, arterial pulse propagated through, 268
- Capillary pulse described, 256
- Capsule, inner, lesion of, with hemichorea, 535
internal, 454, 461
- Caput Medusæ defined and explained, 262
quadratum, 464
- Carbolic acid, color of urine after taking, 411, 435, 451
- Carbonate of lime in urine, 431
illustrated, 431
- Carbonic acid, accumulation of, a cause of cyanosis, 42
diagnostic importance of, 270
effect of poisoning by, upon color of blood, 270
in blood, cause of, 43
increased exhalation of, in fever, 60
oxide poisoning, absorption bands in blood in, 272
- Carcinoma. *See also* Cancer.
acetonuria in, 448

- Carcinoma**, delay in absorption from stomach in case of, 355
 disturbance of consciousness in, 470
 effect of, on consistence of liver, 326
 epithelial, in larynx, illustrated, 596
 inherited, 20
 irregular enlargement of liver with, 322
 nutrition poor in, 575
 of gall-bladder, 326
 of kidney, palpation of, 395
 of larynx described, 597
 of liver, change in shape of, 325
 difficult to distinguish from that of omentum, 340
 with and without tenderness, 324
 of lung, deadened sound over, 127
 of œsophagus, 292, 294, 296
 affecting the larynx, 75
 of pancreas, diagnosis of, 340
 of peritoneum, 315
 of skull-wall, 465
 of spleen, unequal enlargement from, 335
 of stomach, absence of free muriatic acid in, 356
 hypersecretion in cases of, 357
 local increased resistance with, 302
 pain of, 304
 of tongue, 286
 shreds of tissue in stools in, 377
 ventriculi, hemorrhage from, 362
 peptonuria with, 439
Carcinomatous pleuritis, cells in exudation of, 161
 ulceration of rectum, hemorrhage from, 375
Cardia of stomach, position of, 298, 299
Cardiography of apex-beat, 202
Caries of rib, pain in, 101
 cause of pleurisy, 102
 of vertebræ, tenderness with, 467
Carotid artery, left, relation to aorta, clinical importance of 463
 pulsation of, in health, 255
 pulse in aneurism of aorta, 254
Carotids, internal, supply the brain, 461
Cartilage, sound on percussion, 109
CaSC, 518, 519, 523
 determination of minimal, 515
 early in tetanus, 526
Case-taking, value of, 25
CaTe, 518
 determination of, 515
 early in tetanus, 526
Casts, epithelial, forms of, in urine, 424
 in urine, the infallible signs of nephritis, 420
 of red blood-corpuscles, illustrated, 424
 renal, kinds of, 422
 preparation of, for examination, 422
Catalepsy defined, 535
 rarely occurs with anatomical diseases, 536
Cataract with diabetes mellitus, 562
Catarrh, acute nasal, a sign of various diseases, 74
 chronic nasal, cause of neuroses, 575
 nasal, 73
 of intestine, meteorism with, 309
 of large intestine, stool of, 373
 of larynx, signs of, 593
 of stomach, delay in absorption in case of, 355
 hypersecretion in cases of, 357
 pain with, 303
Catheter, always to be used to draw urine in cases of unconsciousness, 401
 cystitis excited by, 425
 to be used to avoid contamination of urine, 399
 use of, a cause of cystitis, 579
 shows residual urine, 408
Cathodal closure, result of, 506
Cathode (negative pole), 515
 at the, contraction at the closing of current, 506
 of galvanic current, use of, in testing sensibility of spinal column, 468
 of the opening current of secondary coil stronger than anode, 504
Caudate nucleus, blood-supply of, 462
Causes of disease, exciting, 21
 predisposing, 21

- Cavities, bronchiectatic, micrococci in sputum from, 189
 cylindrical, effect of length upon pitch of sound, 110
 experiment to illustrate, 110
 in apex revealed by loud râles, 152
 in lungs, amount of expectoration from, 168
 bronchial breathing over, 146
 coin-shaped sputa from, 169
 containing air, closed-tympanic sound from, 110
 open or closed, tympanic resonance over, 131
 plegaphonia over, 159
 large parietal, noise of spun-top over, 134
 with smooth walls, 136
- Cavity in lung, if filled, weaker bronchial breathing over, 147
 increased vocal fremitus with, 158
 metamorphosing breathing a sure sign of, 148
 purulent sputum from, 169
 ringing râles with, 152
- Celli, reference to, 282
- Celsius' thermometer, 57
- Central convolution, 459
 anterior, blood-supply of, 462
 left anterior, centre of acoustic recollections, 555
 posterior and anterior, illustrated, 466
 blood-supply of, 462
 thread of Curschmann's spirals described, 179
- Cephalalgia, significance of, 482
- Cercomonas (infusorium) in sputum, 183
- Cerebellum ataxia in lesions of the vermiform process, 529
 illustrated, 466
 vermiform process of, lesion of, 534
 vertigo with tumor of, 472
 vomiting in diseases of, 578
- Cerebral abscesses, 585
 affections, ataxia in, 529
 artery, middle, hemorrhages and emboli most frequent in, 463
 largest vessel of brain, 462
 posterior, portion of brain it supplies, 462
- Cerebral blowing sound in children with systole of heart, 258
 congestion, with albuminuria, 441
 disease, absence of cough in, 165
 severe hiccough in, 540
 diseases, clonic spasms in localized, 532
 hemorrhage, Cheyne-Stokes respiration in, 92
 irritation, acetonuria with, 448
 paralysis above the anterior horn, characteristic sign of, 494
 EAr not present in, 525
 in children, hemiathetosis in, 535
 increase of tendon reflex in, 500
 symptoms, significance of, 587
 tumors, Cheyne-Stokes respiration in, 92
- Cerebro-spinal meningitis, herpes with, 50
- Cerebrum, 461
 blood-supply of, in the region of fissure of Sylvius, 462
 disease of, muscular atrophy with, 493
 relation of acoustic nerve to, 461
- Cervical enlargement of cord, location of, 468
 nerves, illustrated, 485
 vertebrae, caries of, 539
- Chain-coccus in urine, 426
- Change of respiratory sound, Friedrich's, defined, 113
 of sound, tracheal, Williams's, 121, 130
 Wintrich's, described, 111
- Charcot, reference to, 279, 493, 526, 556, 557, 558, 560, 581, 582, 587
- Charcot's crystals, 387
- Charcot-Leyden's crystals, 179
 described, 181
 in asthma, 388
 in sputum, 174
- Cheek, nerve-supply of, 484
- Cheese-spirals, 391
- Chemical examination of blood, 283
- Chemistry of digestion, 348
- Chest, asymmetry of, 82
 circumference of, in relation to weight and height, 35
 dimensions of, 82
 form of, in relation to disease, 81
 lagging behind of, 86
 pathological form of, 82

- Chest**, sides of, percussion note over, 120
 -wall, affections of, which cause
 deadened sound, 130
 inflammatory diseases of,
 weaken apex-beat, 201
 thickening of, a cause of
 diminished vesicular
 breathing, 145
 weakened vocal fremitus
 with, 158
- Cheyne-Stokes** respiration described,
 91, 92, 93
 dyspnoea in, 94
 increased vesicular
 breathing in, 144
 with uræmia, 440
- Chiasm**, pressure upon, atrophy of
 optic nerve from, 601
- Children**, area of heart-dulness in, 205
 arrest of growth of bone in paral-
 ysis of, 583
 at first naturally ataxic, 527
 cancrum oris in, 288
 capillary bronchitis in, 152
 cerebral blowing sound with sys-
 tole of heart in, 258
 choreic motions in encephalitis
 in, 535
 color of stool in, 373
 cracks in lips of, a sign of heredi-
 tary syphilis, 285
 diaceturia in fever of, 447
 as an independent disease in,
 447
 ease with which they vomit, 358
 edge of liver distinct in, 323
 effect of severe diarrhœa in, upon
 amount of blood in the body,
 270
 elasticity of thorax in, effect on
 râles, 153
 epileptiform attacks from various
 causes, 533
 examination of, for eruption of
 teeth in, 285
 expansion of lungs in, after
 whooping-cough, 136
 frequency and character of stools
 in, 368
 gallop rhythm a sign of heart-
 failure in, 221
 heart-sounds in, 216
 hemiathectosis in cerebral paral-
 ysis in, 535
 how to examine mouth of, 284
- Children**, kinds of fungus spores in
 stools of, 388
 laryngitis in, 593
 lientery stools in, 372
 meat-juice stools in catarrh of
 large intestine in, 375
 nervous disturbances from intes-
 tinal parasites in, 578
 nursing, sour odor of stool nor-
 mal in, 371
 percussion note in, 120
 position of apex-beat in, 198
 of heart in, 192
 pulse in, with febrile disease, 239
 rapid breathing in fever of, 94
 reaction of stool in, 372
 relative heart-dulness in, 207
 retro-pharyngeal abscess in, 290
 round worms in, 380
 size of liver in, 320
 sounding œsophagus of, 293
 thrush in, 288
 yielding thorax of, permits pro-
 jection in enlargement of liver,
 321
- Chill** described, 62
 with rise of temperature, signifi-
 cance of, 64
- Chittenden**, reference to, 439
- Chlorate** of potash, color of blood in
 poisoning by, 270, 271
 poisoning by, causing hæma-
 to-jaundice, 47
- Chloride** of calcium, poisoning by,
 methæmoglobin in blood in,
 272
 of iron reaction, test for acetone,
 414
 of sodium, amount of, in urine
 405
 in urine, 434
- Chlorides** usually diminished in fever,
 60
- Chloroform** poisoning causing hæma-
 to-jaundice, 47
 odor of breath in, 285
- Chlorosis**, blood-corpuscles markedly
 pale in, 275
 color of blood in, 271
 dizziness with, 471
 Egyptian, 41
 heart-sounds strengthened in, 217
 murmurs heard in, 229
 no notable diminution of red cor-
 puscles in, in contrast with
 anæmia, 276

- Chlorosis, paleness in, due to loss of hæmoglobin, 41
 red blood-corpuscles not diminished in, 274
 use of Fleischl's hæmometer in, 276
 venous humming in, 269
- Choked disk, 562, 587
 absence of, in bulbar paralysis, 496
 from intra-cranial pressure, 600
 recognition of, 601
 unilateral, 565
- Cholæmia, 47
- Cholera Asiatica, alkaline vomit in, 366
 anuria with, 407
 bacillus, cultures of, 607
 described and illustrated, 389
 mode of preparation of, 389
 necessity of pure culture of, 390
 color of stool in, 373
 effect of discharges in, on amount of blood in the body, 270
 examination of, 606
 increased peristalsis in, 366
 indican in urine of, 409
 great quantity of stool in, 370
 mucus in stools of, 374
 odor of stools in, 372
 peculiar vomit of, described, 361
 saliva diminished in, 289
 severest diarrhœa with, 369
 sweat in, 38
 watery stools in, 371, 374
 morbus, mucus in stools of, 374
- Cholesterine, crystals of, in sputum, 181
- Chorda tympani, 461, 484
- Chorea minor described, 534
 significance of, 535
- Choroid, tubercle of, 601
- Choroidal tuberculosis, 562
- Choroiditis syphilitica, 601
- Chronic diseases, development of, indicated by weight of body, 35
 outbreaks of, 22
- Chyluria, fibrin in urine in, 439
 lipæmia in, 280
- Chyluria, lipuria in, 447
 produced by filaria sanguinis, 425
 rare, 412
- Ciliated epithelium, transfer of mucus by, 167
- Circle of Willis, 461
- Circulation, disturbance of, causing paleness, 40
 through lungs, 44
- Circulatory apparatus, examination of, 191
 disturbances of, 576
- Circulus vitiosus, in stomach, 345
- Circumference of thorax increased in inspiration, 163
 where measured, 162
- Circumpolarization for determining presence of sugar, 447
- Cirrhosis of liver, ascites with, 314
 bloody vomit in, 361, 362
 consistence of liver in, 326
 diminished area of dulness with, 331
 enlargement of spleen with, 335
 made out after tapping abdomen, 318
 surface of, 325
 urine of, dark, 408
 venous engorgement caused by, 262
- Clarke, columns of, 459
- Clavicular depressions deepened, 87
- Clavus hystericus, 482
- Clear sound defined, 106, 109
 from closed air-cavity, 110
- Clinical study, value of case-taking in, 25
- Clonic spasms, 530
 when occur, 532
- Closed tympanitic sound defined, 110
 heard over stomach, 111
- Clothing, effect of, on disease, 21
- CO₂ in blood, effect of, on breathing, 93
- Coagulation of blood slower when nutrition is disturbed, 283
- Coal-dust in epithelial cells in sputum, 177
 -soot in sputum, 171, 176
- Cocaine, effect of, on pupil, 567
- Cocci in urine, 425
- Cod-liver oil, lipuria when taking, 447
- Coffee-grounds-stool, in gastric hæmorrhage, 375
 -vomit explained, 363
- Cohnheim, reference to, 53, 54, 407

- Cohnheim's hypothesis regarding dropsy of kidney disease, 440
- Cold baths, value of pulse in showing result of, 253
catching, disposition to headache with, 483
- Colic, abdominal, from passage of gall-stones, 376
- Collapse, cold sweat of, 33
described, 63
from hemorrhage in cases of ulcer of stomach, 362
shown by fall of temperature, 65
weakness of apex-beat in, 201
- Colon, boundary between, and small intestine 312
distention of, for purposes of diagnosis 311, 312
fecal masses in, increases the area of dulness near the spleen, 338
position of, illustrated, 298
relation of, to spleen, 336
transverse, scybala in, 303
tumors of transverse and descending, confounded with those of spleen and kidney, 311
- Color of expectoration, 168
of skin, 38
of tongue, 287
of urine, 401
-sense, testing the, 568, 571
- Columns of Clarke, 459
of Goll, 459
of Türk, 455
- Coma defined, 470
diabetic, 579
acetone odor of urine in, 414
 β -oxybutyric acid in urine of, 449
diaceturia in, 447
odor of breath in, 285
difficulties of diagnosis in, 471
from diaceturia, 448
post-epileptic, 533
uræmic, 440
with diabetes mellitus, 579
- Comma bacillus, Koch's, distinguished from Finkler-Prior's bacillus, 390, 607
- Communicating artery, posterior, 461
- Comparative percussion, 118, 121, 125
- Compensation of heart disease, pulse in arrested, 240
of valvular deficiency, 195
- Compensatory hypertrophy of one division of heart, 219
- Complementary pleural sinus, 80
exudation into, 306
space, 192
- Complication of disease shown by temperature, 65
- Complications, value of pulse in, showing beginning of, 253
- Concealment of disease, 19
- Concentrated urine, appearance of, 402
- Conception of space, how tested, 481
- Concretions in urine, 433
- Concussion of cranium, disturbance of consciousness in, 471
- Conduction, resistance to, 512
- Conductive resistance, 514
variations of, due to thickness of skin, 513
- Confinement to bed, ataxia after, 529
- Confluent sputa, 169
- Congenital drawing in of thorax, 89
- Conjugate deviation, 566
of the eye, 563
- Conjunctiva, color of, 39, note.
nerve supply of, 484
- Consciousness, change of, in Cheyne-Stokes's breathing, 93
diseases in which disturbances of occur, 470
disturbances of, terms used for, 470
loss of, 40
sign of, 489
mydriasis with marked disturbance of, 566
never an entire loss of, in hysterical convulsions, 533
obtunded, phenomena of, 471
when there is loss of, heart and vessels to be examined, 577
- Consensual reaction of pupils, 567
- Consistence of expectoration, 168
- Consonance increases vocal fremitus, 158
- Consonant râles, 152
- Constipation, 368
alternating with diarrhoea, 369
and severe obstruction to be sharply distinguished, 369
habitual, in diseases of spinal cord, 578
- Constrained positions and motions defined, 534
- Constricted liver from tight lacing, 323
- Constriction, feeling of, about thorax, 482

- Contagion distinguished from infection, 22
- Continued fever, range of temperature of, 62
- Continuous fevers, red skin in, 41
- Contracted kidney, casts in urine of, 422
diminished urine with, 407
polyuria with, 406
retinitis in, 601
pupil, 566
- Contraction, character of, 518
laws of, 505
normal, with galvanic stimulation, 506
minimal, 505, 515, 516
quality of, sometimes important, 515, 516
tetanic, 505
- Contractions, idio-muscular, defined, 526
lightning-like, 507
of fibrillæ, 530
paradoxical, defined, 527
quality of, depends upon relation of the nerve to the skin, 504
slowness of, in partial EaR, 523
- Contracture due to over-excitability of nerves and muscles, 526
of muscles in paralysis, 495
- Contractures wanting, 493
- Conus aortæ, 193
arteriosus, sound caused by filling of, 213
terminalis of cord, location of, 468
- Convalescence indicated by weight of body, 35
perspiration in commencement of, 38
pulse in, 235
temporary imbecility in, 472
- Convolution, anterior central, 454
left anterior central, centre for acoustic recollection, 555
second frontal, motor centre for writing, 555
third frontal, motor speech-centre, 555
posterior central, 454
- Convulsions of brain, anterior and posterior central, blood supply of, 462
posterior and anterior central, illustrated, 466
- Convulsions. Also see Spasms
clonic spasms in, 532
- Convulsions, difference between hysterical and epileptic, 533
due to eruption of teeth, 286
epileptic and hysterical, opisthotonus with, 468
hysterical, tetanic, perspiration in, 37
in children, diaceturia thought to be the cause of, 448
produce cyanosis, 42
sign of nervous disease, 22
simulation of, 19
with uræmia, 440
- Cooing in intestine, value of, 312
- Coördinated motions in hystero-epilepsy, 533
spasms, 534
- Coördination defined and explained, 527
disturbances of, in the larynx, 597
how acquired, 527
of muscles, 488
temporary loss of, 529
- Copaiva, odor of urine after taking, 414
- Copper, condition of teeth in poisoning by, 286
- Copying, power of, 550
- Cord, compression of spinal, 467
spinal, effect of lesion of, 457
- Corona radiata, 454
effect of lesion of, 457
- Corpora quadrigemina, ataxia in lesions of, 529
blood supply of, 462
- Corpulence, 35
increases area of dulness near the spleen, 338
- Corpus quadrigeminum, lesion of posterior, 566
- Corpuseles, mucous, in sputum, 175
- Cortex of brain, clonic spasms in
local affections of, 532
effect of lesion of, 457
partial epilepsy a sure sign of disease of, 533
spasms from irritation of the, 530
- Cortical centres, lesion of, results of, 456
where their trophic influence ceases, 456
- Cortico-muscular tract, 452, 456
- Corvisart, reference to, 104
- Costal breathing, absence of, how met, 91

- Costal breathing absent in emphysema, 84
 defined, 83
 how changed, 90
 in place of diaphragmatic, 95
 often wanting in women, 85
- Costo-abdominal breathing, how changed, 90
- Cough, diseases and conditions in which it is absent, 165
 dry, defined, 166
 frequency of, and time of day of, significance of, 165
 moist, described, 166
 nervous, 576
 parts of mucous membrane from which it arises, 165
 phenomena of, explained, 164
 power to, when lost, 165
 spontaneous, or reflex, 165
 suppression of, from pain, 165
 tones of, described, 166
 vomiting from violent, 358
- Coughing, effect on venous circulation, 263
 produced by attempts at swallowing in paralysis of pharyngeal muscles, 538
 removes râles, 149
- Coupland quoted, 26
- Covering of body, effect on vocal fremitus, 157
- "Cracked-pot" sound, described, 134
 where heard, 134, 135
- Cranial fossa, anterior, middle, posterior effect of lesion of, 457
 nerves, nuclei of, illustrated, 455
 points of exit from skull, illustrated, 458
 walls, disease of, 465
- Cranium, diseases of, headache with, 482
 examination of, 465
 local diseases of, hearing in, 572
 rachitic thickening of, 464
 sensibility of, to pressure, 466
 size of, at different ages, 464
- Creasote, color of urine after taking, 411
- Cremaster reflex, defined, 495, 495
- Crepitant râles defined, 154
 in capillary bronchitis, 152
- Crepitation, non-uniform, 154
- Crepitations in mediastinal emphysema, 233
- Cretinism defined, 472
- Cretins, skeleton of, 33
- Crisis defined, 67
 signs of, 63
- Critical sweat in various diseases, 37
- Crossed paralysis (oculomotorius) of one side and extremity of other, 566
- Cross-section of chest, 163
- Croup, 75, 98
 casts in sputum of, 172
 cause of cyanosis, 43
 dyspnoea in, 93, 94
 severe cough of a cause of emphysema of skin, 56
 tone of cough in, 166
- Croupous pneumonia, one-sided expansion of chest in, 86
- Crura cerebelli, ataxia in lesions of, 529
- Crural arterial and venous sounds combined, 269
 artery, double murmurs in, 259
 nerve, illustrated, 487
 vein, double sound over, how distinguished from that over crural artery, 268
- Crus cerebri, 454, 457
 injury of, 457
 lesion of, crossed paralysis with, 566
 median, lesion of, 534
- Crutch paralysis, 488
- Crystals, fat, distinguished from elastic threads in sputum, 177
 in sputum, 174
 in blood in leukæmia, 279
 in feces, 387
 in sputum, kinds of, 180
 of cholesterine in sputum, 181
 of fatty acids in sputum described, 181
- Cubebs, odor of urine after taking, 414
- Current-changer, 506
 use of, 505
 density of, in nerves and skin, 503
 electric, cannot be concentrated on nerve, 503
 reasons why, 504
 strength of, as affected by the angle of entrance of, 504
 increases, while electrodes are on the body, 503
 of total, 512
 of total, must be known, 513

- Curschmann, reference to, 179, 180
 Curschmann's spirals in sputum, 178
 Curvature, greater, of stomach, anatomical relations of, 299
 boundary of, 305
 in distention, 301
 position of, 298
 when dulness over, 306
 lesser, of stomach, anatomical position of, 298
 relations of, 299
 Curve, Damoiseau's, 129
 Cutaneous nerves of lower extremity illustrated, 487
 of shoulder, arm, and hand, distribution of, illustrated, 486
 veins, enlargement of, 262
 Cyanosis, a result of general venous engorgement, 261
 causes of, 43
 described, 42
 from interference with respiration during an attack of epilepsy, 533
 from poisons. *See* Examination of Blood.
 from severe coughing, 166
 in paralysis, 577
 in tetanus and epilepsy, 540
 of newborn, 42
 sometimes absent in tuberculosis pulmonum, 44
 with dyspnea, 99
 Cyclic albuminuria, 435, 437
 Cylindrical cavities, effect of length of, upon pitch of sound, 110
 experiment to illustrate, 110
 Cylindroids in urine not to be confounded with casts, 424
 Cystic hemorrhages, very free, characteristics of, 418
 Cystin in urine, significance of, 432
 -calculi, 432, 433
 Cystitis, alkaline urine with, 413
 caused by cystin, 432
 by ptomaines, 432
 from use of catheter, 579
 hæmaturia from, 417
 hydrothionic urine with, 414
 micrococci and bacilli in urine of, 425
 mucus in urine of, 416
 odor of urine in, 415
 sediment in urine in, 419
 signs of, 400
 Cystitis, turbid urine with, 412
 with a nervous disease, 575
 Cystometer, Woillez's, 163
 Cystopyelitis, 398
- D**AMOISEAU'S curve, 129
 Dax, M., reference to, 552
 Deadened resonance, 125
 sound associated with feeling of strong resistance, 116
 defined, 109
 from thick skeletal covering, 114
 relatively, where occurs, 114
 where heard, 109, 113
 Deadening, relative heart and liver, 112
 Deadness applied to sound, 106
 area of, increased with extent of exudation, 128
 of sound over pleural thickening, 148
 relative, of sound defined, 107
 Deafness, absolute and relative, 108
 nervous, 572
 Decomposition of intestinal contents, vegetable parasites in feces in, 388
 Decubitus acutus defined, 582
 described, 582
 disturbance of nutrition with, 575
 Deep breathing, employment of, in examining the abdomen, 323
 lung sound, 108
 sensitivity, 473
 part of, in recognizing the form of bodies, 481
 section on, 479
 Defecation, assisted by abdominal pressure, 540
 Defervescence, stage of, 65
 Deformity of chest, 81
 Degeneration, character of, as determined by location of lesion, 456
 funnel-breast a sign of, 89
 of hypertrophied heart, weak apex beat in, 201
 of nerves and muscles, 520
 primary and secondary, increase of tendon reflex in, 500
 reaction of, complete and partial, 519
 Degenerative atrophic paralysis, 492, 493, 518
 atrophy, 490, 493
 difficulty of diagnosis in, 491

- Degenerative atrophy, when wanting, 491
paralysis, 495
- Deglutition-pneumonia, 600
- Dehio, reference to, 143
- Delayed sensibility, 478
- Delirium, defined, and the diseases in which it occurs, 471
in gross hysteria, 534
-muttering in typhoid fever, 471
tremens in alcoholic poisoning described, 471
with uræmia, 440
- Dementia paralytica, atrophy of optic nerve in, 601
character of the writing of, 561
senile, mixed aphasia and amnesia in, 555
senilis, 472
- Deneke, reference to, 391
- Dentition, cause of epileptiform attacks in children, 533
disturbances due to, 286
- Deposits, pyæmic, in lungs, friction-sounds with, 156
- Depression, clavicular, 81, 82, 84
Morenheim's, defined, 76
states of, acetonuria in, 448
- Desaga, spectroscope devised by, 272
- Descendants divided by heredity, 20
- Desquamation of renal epithelium in acute nephritis, 424
- Detritus in stools, 387
- Development, errors of, funnel-breast a sign of, 89
- Deviation, conjugate, 534
primary, secondary, 563
- Diabetes, acetone odor of breath in, 285
alkalescence of blood in, diminished in, 283
diminished sweat in, 38
disturbance of consciousness in, 470
dyspnœa in, 576
gangrene in, 577
insipidus, 579
inosite in urine in, 447
lipæmia in, 280
mal perforant in, 582
mellitus and insipidus, polyuria with, 406
apple odor of urine in, 414
caries of teeth in, 285
cataract with, 562
- Diabetes mellitus, character of urine in, 443
contradictory character of urine in, diagnostic value of, 409
diaceturia in, 447
effect of, on weight of body, 36
levulose in, 447
lipuria in, 447
oxalate of lime in urine of, 430
percentage of sugar in urine of, 443
polyuria of, secondary to polydipsia, 407
specific gravity of urine in, 412, 413
thirst in, 23
various nervous disturbances with, 579
neuralgia in, 483
ocular changes in, 602
oxalate of lime in sputum of, 182
saliva diminished in, 289
thrush with, 288
- Diabetic coma, acetone odor of urine in, 414
 β -oxybuteric acid in urine of, 449
odor of breath of, 285
sometimes increased vesicular breathing with, 144
Stadelmann's observations on, 449
- Diaceturia, an independent disease in children, 447
comparison of color of urine, with test for salicylic acid, 450
in adults, when occurs, 448
in children the cause of convulsions, 448
test for, 448
when occurs, 447
- Diagnosis defined, 17
- Diameter of thorax, how measured, 162
- Diaphragm, action of, in stenosis of upper air-passage, 98
interfered with, 90
tested by palpation, 103
adjacent to fundus of stomach, 299
depressed by exudation, 128
in exudative pleuritis, 330
depression of, from emphysema, 199

- Diaphragm, effect of paralysis of, 540
 of position of, on relative liver dulness, 332
 of pressure upon, may interfere with action of heart, 40
 elevation of, causes dislocation of heart, 200
 fixation of, in hysteria, 576
 high position of, 87, 130
 due to abdominal distention, 317
 diminishes area of spleen dulness, 339
 from paralysis, in peritonitis, 317
 increased parietal area of heart with, 211
 liver moves with, 320
 in inspiration, 322
 low position of, renders spleen accessible, 335
 paralysis of, inspiratory dyspnœa from, 99
 position of, 80
 aids diagnosis between pleural exudation and thickened pleura, 130
 changed with diminished volume of lungs, 137
 in children, 192
 of the heart changed by depression of, 204
 pressed upon by meteorism, 309
 upward by enlarged liver, 322
 pressure upon, a cause of paleness, 40
 pushed up by subphrenic abscess, 322
 rapid breathing in diseases of, 94
 relation of spleen to, 332
 to liver, 320
 with other organs, 312
 spasm of, 94, 540
 trichinosis of, pain in, a cause of cyanosis, 44
 upward displacement of liver in paralysis of, 323
 pressure of, cyanosis from, 43
 vesicular breathing increased on account of high position of, 145
- Diaphragmatic breathing, 83
 in place of costal, 95
 friction sounds, 233
 peritonitis, simulates pleuritis, 161
 pleurisy, tympanitic sound in lung over, 130
- Diarrhœa, alternating with constipation, 369
 brick-dust sediment in urine of, 430
 causes diminished sweat, 38
 color of stool in, 373
 defined, 368
 due to eruption of teeth, 286
 effect of severe, on the amount of blood in the body, 270
 foul-smelling stool in severe, 372
 infusoria found in stools of, 383
 less amount of urine in, 407
 quantity of stool increased in, 376
 saliva diminished in, 289
 watery stools in, 374
- Diastole of heart, sound of, what due to and where best heard, 213, 214
 sound with, 212
 venous humming louder during, than in systole, 269
 of ventricle, movement of blood in, 193
- Diastolic collapse of cervical veins, 267
 murmur at aorta, 251
 murmurs, 222, 225
 how distinguished from systolic, 226
 sound over large arteries in health, 257
- Diazo-benzol-sulphuric acid test for sugar, 445
- Dicrotic pulse, tracings of, 248
- Dictation, writing from, 550
- Diet, coating of tongue from articles of, 287
 effect on disease, 21
- Differential diagnosis between peri- and endo-cardial murmurs, 232
- Differentiating electrode, 501
- Difficult breathing, 93
- Digestion, aided by mechanical action of stomach, 347
 amyolytic period of, 342
 bacteria in feces in anomalies of, 388
 character of stools in disturbance of, 372
 chemical action during, 347
 duration of, 347
 examination of process of, 342
 intestinal, shown by stools, 367
 mode of procedure in examining, 350

- Digestion, normal, test of, 348
 particles of food found in stools
 in disturbed, 386
 period of, prolonged, 356
 shortened, 356
 prolonged in dilated stomach, 346
 study of process of, 341
 washing out the stomach in dis-
 turbance of, 357
- Digestive apparatus, change in weight
 in diseases of, 35
 examination of, 284
 section on disturbances of,
 577
- Dilatation of heart, a cause of insuf-
 ficiency, 194
 area of dulness enlarged in,
 208, 209
 cause of projection of region
 of heart, 202
 eccentric, 195
 in anæmia, 229
 simple, 196
- of stomach, 345, 348
 absence of free muriatic acid
 in, 356
 infrequency of the attacks of
 vomiting in, 359
 with fermentation, recog-
 nized by seething sound,
 308
- Diphtheria, acute nasal catarrh in, 74
 appearance of tonsils in, 290
 death after examination of throat,
 284
 examination of mouth in cases of,
 284
 gallop rhythm a sign of heart-
 failure in, 221
 glands of neck enlarged in, 291
 glycosuria in, 443
 may cause cyanosis, 43
 microscope an aid in diagnosing,
 from benign necrosis, 291
 paleness from, 40
 paralysis of tensor of vocal cords
 from, 600
 sequelæ of, 22
 sometimes no contraction of pupil
 after, 568
 tone of cough in, 166
- Diphtheritic paralysis, position of the
 soft palate in, 538
- Diplococci in purulent pleural exu-
 dation, 161
- Diplococcus in urine, 399
- Diplopia defined and when occurs,
 472
 mode of determining, 564
 result of strabismus, 563
 significance of, 564
- Direct percussion defined, 104
- Discharges, in voluntary, during attack
 of epilepsy, 533, 534
- Disease, first appearance of, 23
 location of, sometimes indicated
 by headache, 482
 simulation of, 19
- Diseases, acute, power of resistance
 to, 33
 sometimes no contraction of
 pupil after, 568
- ataxia after acute, 529
 concealed, 19
 course of, 23
 directly inherited, 20
 exciting causes of, 21
 internal, and form of thorax, 81
 names of, misused, 19
 predisposing causes of, 21
 tracing of pulse in wasting, 248
 wasting, hæmic murmurs in, 229
- Displacement of apex-beat, 199
- Disposition to disease inherited, 20
 of lungs, 81
 emphysema, with full chest, 34
 tuberculosis, 34
- Distention of stomach, 300, 301
 artificial, methods of, 301, 302
 Ferich's formula for, 301
 Ziemssen's formula for, 302
- Distoma hæmatobium, cause of hæma-
 turia, 283, 425
 eggs of, in urine, 425
 illustration of, 282
 hepaticum and distoma lanceo-
 latum described, 383
 illustrated, 384
 pulmonum, eggs of, in sputum, 183
 in sputum, 174
- Disturbances of speech, 548
- Disturbed sensibility, local manifesta-
 tions of, 478
- Dizziness, also *see* Vertigo, from the
 eye, 563
 combined with tinnitus aurium, 575
 significance of, 471
- Dock, reference to, 282, 391
- Dolichocephalus, 465
- Dorsal clonus, 499
 position for inspection and palpa-
 tion of heart, 197

- Double murmur from pressure, 259
 vision, mode of determining, 564
 result of strabismus, 563
 significance of, 564
- Drawing-in, circular, of chest, 88
 inspiratory, 97, 98
 of abdomen, causes of, 309
 of one side, 86
- Drinks, certain ones which cause
 polyuria, 406
- Dropsy, anidrosis with, 38
 of kidney disease, cause of, 440
 orthopnoea with, 33
 three causes of, 53
 urea diminished in cachexia with,
 434
- Drunkards, lipæmia in, 280
- Dry cough defined, 166
 râles explained, 149
- Duboisin, effect of, on pupil, 567
- Dubois's induction coil, 476
- Duchenne, reference to, 508
- Ductus choledochus, 46
 compression of, 340
 Wirtungianus, 387
- Dull, as a term for sound, avoided, 108
 sounds, 107
- Dura mater, disease of, 465
- Duration of digestion, 347
 of lung sound, 108
- Duroziez's double murmur, 259
- Dust, inhalation of, cause of bron-
 chitis, 21
 of pneumonia, 21
- Dwarf, skeleton of, 33
- Dynamic sense, 479
 defined, 480
- Dynamometer, uselessness of, 545
- Dysarthria defined, 548
- Dysentery, amœba coli in stools of, 391
 blood in stools of, 373
 catarrhal, mucous stool in, 374
 color of stool in, 373
 consistence and form of stool in,
 371
 feces of, contains Charcot's crys-
 tals, 388
 meat-juice stools in, 375
 odor of stools in, 372
 pain and straining at stool in, 370
 in left iliac fossa with, 308
 shreds of mucous membrane in
 stool in, 377
 watery stools in, 374
- Dyspepsia, acute, paleness in, 40
 coated tongue of, 287
- Dyspepsia due to diseased teeth, 286
 following healed ulcer of stomach,
 vomiting with, 361
 foul odor of breath in, 285
 gastric, headache with, 483
 intestinal, fungus spores in stools,
 388
 nervous, 578
 has marked subjective symp-
 toms but no physical signs,
 308
 subacidity of stomach in, 356
 watery vomit of, 361
 stools in, 372
 superacidity of stomach with, 357
 symptoms of, with displacement
 of right kidney, 396
 time when vomiting occurs in, 359
- Dyspnoea, 32, 74
 active expiration of, 97
 caused by emphysema of skin, 57
 color of blood in, 270
 described, 93
 expiratory relation to emphysema,
 85
 from drawing up of diaphragm, 86
 from uræmia, 440
 in Cheyne-Stokes breathing, 94
 in connection with nervous dis-
 eases, 576
 in diseases of the lungs, 95
 in emphysema, 84
 in heart disease, 96
 in paralysis of the diaphragm, 540
 inspiratory, 74, 598
 from paralysis of the laryn-
 geal muscles, 538
 mixed, when exists, 100
 of fever, 94
 sometimes increased vesicular
 breathing with, 144
 usually accompanied by perspira-
 tion, 37
- Dystrophia musculorum, 493, 494, 525
- E**AR, affections of, in diseases of the
 nervous system, 572
 catarrh of middle, a sign of con-
 genital syphilis, 286
 importance of determining dis-
 ease of, 572
 subjective sensibility of hearing
 in diseases of, 572
 suppuration of, cause of menin-
 gitis and abscess of brain, 467

- Ear, vertigo in diseases of, 472
- EaR (reaction of degeneration), 518
 diseases which are excluded when it is present, 525
 in myopathic muscular atrophy, 524
 partial, 522, 525
 relation of, to mechanical EaR, 524
 significance of its absence, 525
 varieties of, 523
 when wanting, 525
 with reference to motion, 521
- Ebstein quoted, 89
 reference to, 205, 208, 447
- Ecchymoses, 51
- Echinococcus bladders in sputum, 174, 182
 change in shape of liver from, 325
 in urine, 424
 irregular enlargement of liver with, 322
 membranous rags of, in vomit, 364
 of kidney, palpation of, 395
 of liver a cause of jaundice, 47
 depression of liver from, 330
 no tenderness with, 324
 of omentum is rare, 340
 prominences on liver from, 326
 unequal enlargement of spleen from, 335
- Ecker, reference to, 452, 466
- Eclampsia gravidarum, 533
- Ectasia of stomach, 345
- Edelmann, reference to, 518
- Edelmann's horizontal galvanometer, 503
- Edinger, reference to, 453, 455, 458
- Effusion in abdominal cavity, 313
 into cavities a result of general venous engorgement, 261
 into pleural cavity, serous, purulent, ichorous, complicating pneumothorax, diagnosis of, 129
 percussion of, in abdominal cavity, value and method of, 316
- Effusions into pleural sacs, 80
 large, in abdomen, effect of, 317
- Egyptian chlorosis, 382
- Ehrlich, reference to, 185, 279
- Eichhorst, reference to, 154, 164, 208, 247, 248, 249, 302, 424
- Elastic fibres a sediment in sputum, 186
 threads described, 177
- Elastic threads, how distinguished from leptothrix buccalis, 184
 how to obtain, for examination, 178
 importance of, in sputum, 177
- Electric sensibility, 476
- Electrical condition, diagnostic value of, 524
 examination, details of method of, 507
 methods of, 505
 of nerves and muscles, 501
 what it consists of, 505
- irritation of arm, 509, 510
 points of, upon the head and neck, illustrated, 503
- reaction, mixed, defined, 523
 what to observe in determining, 516
- sensibility unchanged in atrophy of inactivity, 490
- Electro-diagnosis, reading the galvanometer in, 515
 -motor points, 469
- Electrode always to be applied with the same pressure, 507
- Erb's fine, for faradic current, 502, 512
- examining and indifferent, 512
 for testing sensibility of skin illustrated, 476
- indifferent, 523
 and differentiating, 501
 where placed and size of, 502
- place of, in galvanic examination, 515
 relation of size of, to intensity of current, 502
- Electrotonus, 505
- Elements, galvanic, number of, 514, 515
- Emaciation cause of narrow chest, 85
 how detected, 35
 produced by disease of internal organs, 36
- Emboli, effect of, on pulse, 245
 region of brain where most frequent, 463
 result of atheroma of vessels, 576
 from thrombi in weak heart, 576
- Embolism, local, low temperature in, 71
- Embolus of the central artery of the retina, 562

- Emesis, induction of, when contra-
indicated, 342
intentional, for diagnosis, 305
- Emotions causes of disease, 21
- Emphysema, 80, 82
a cause of hypertrophy of right
ventricle, 196
action of muscles of neck in, 538
and form of thorax, 81
band-box note with, 135
case of pernicious anæmia com-
plicated by, 230
cause of emphysema of skin, 56
of expiratory dyspnœa, 99
of hypertrophy of right ven-
tricle, 210
causes diminished parietal area of
heart, 197
clavicular depression in, 84
cyanosis in, 43
diaphragmatic breathing in, 91
diminished amount of urine with,
407
expiratory pressure in, 164
disposition to, with full chest, 34
distinguished from œdema, 55
disturbs circulation through the
lungs, 44
downward displacement of liver
with, 322
dyspnœa in, 95
effect of, on relative liver-dulness,
332
on upper boundary of liver,
330
effects of, upon venous circulation,
263
enlargement of liver with, 322
expiratory bulging in, 98
extension of boundaries of lungs
in, 136
"gallop rhythm" of heart in,
221
heart-dulness diminished in, 210
inspiratory dyspnœa with, 100
local expansion of chest in, 86
mediastinal, 57, 210, 233
muscular aid in, 84
non-ringing râles with, 153
non-tympanic sound with, 112
of lungs, 204
a cause of displacement of
heart, 199
conceals apex-beat, 201
the action of pulmonary
valve, 203
- Emphysema of lungs diminishes area
of spleen-dulness, 339
of skin, 55
in connection with diseases
of œsophagus, 296
weakens apex-beat, 201
peptonuria with, 439
prolonged expiration in, 145
râles with, 150
sequela of whooping-cough, 22
tough expectoration with, 166
value of pulse in cases of, 253
venous engorgement from, 261
vesicular breathing diminished in,
145
vicarious, 85
downward displacement of
lung boundary in, 136
how developed, 87
no expiratory dyspnœa with,
100
on left side, difficulty in de-
termining location of heart
in, 211
vital capacity of lungs in, 164
weakening of heart-sound in,
219
with pleuritis, friction-sounds
with, 156
- Emphysematous thorax, 83, 85
- Emprosthotonus, 539
- Emptying of stomach, dangers of, 357
- Empyema, amount of expectoration
in, 168
crystals in sputum of, 180
hæmatoidin in sputum of, 172
necessitatis, 102
pulsans, 102, 204
difficulty in distinguishing
from apparent enlargement
of heart, 210
pulsation in, near the heart, 204
purulent sputum in, 169
staphylococcus pyogenes found in,
603
tuberculous, 161
tyrosin in sputum of, 182
- Encapsulated pleurisy defined, 129
- Encephalitis in children, choreic
movements with, 535
neuro-retinitis with, 601
ushered in by epileptiform spasm,
533
- Encysted inflammatory exudation in
abdomen, 317
- Endemic diseases, 21

- Endocardial murmurs, loudness of, to what due, 223
sounds felt, 204
whizzing, 227
- Endocarditis a cause of insufficiency, 194
of stenosis, 194
aorte, embolus of retinal artery in, 562
embolus of central retinal artery in, 602
hæmaturia with, 417
retinal hemorrhages in, 602
sequela of scarlet fever, 22
streptococcus pyogenes with, 603
ulcerative, staphylococcus pyogenes in, 603
valvular, relation of, to disease of the brain, 576
- Engorgement, dropsy of, 440
of kidney, hæmaturia with, 417
of liver, surface of, 325
of spleen, 335
venous, effects of, 260
thrombosis in œdema of, 268
- Enteralgia, simulation of, 19
- Enteritis, amœba coli in stools of, 391
color of stool in, 373.
consistence and form of stool in, 371
forms of fat found in feces in, 386
mycotic, ptomaines in intestine in, 432
poor absorption of fat in, 371
- Enteroliths, from vermiform appendix, 376
- Enuresis from phimosis, 580
nocturnal, 400, 579
- Eosin, staining of white corpuscles of blood with, 279
- Eosinophile white corpuscles in leucæmia, 279
- Epigastric angle, 82
in emphysematous thorax, 83
in phthisical thorax, 84
pulsation not to be confounded with simple aortic pulsation, 204
- Epigastrium defined, 297
illustrated, 298
portion of liver in, 320
projection of, in enlargement of liver, 321
protrusion of, in inspiration, 90
pulsation in, 204
- Epilepsy, acetonuria after attacks of, 448
- Epilepsy, albuminuria with, 435, 441
clonic spasms in, 532
convulsions of, 37
cutaneous hemorrhages from attacks of, 582
cyanosis in, 44
differential diagnosis between genuine and symptomatic, 533
disturbance of consciousness in, 470
dyspnœa in, 95
fever with attacks of, 575
glycosuria after attack of, 443
hyperosmia and parosmia as an aura in, 574
involuntary passage of semen in, 534
of urine in, 580
Jackson's (partial or cortical), 533
described, 533
opisthotonus with convulsions of, 468
(petit mal) syncope with, 471
spasm, or convulsion, described, 432
spermatozoa in urine after attacks of, 421
tinnitus aurium sometimes as an aura a precursor of, 573
tonic and clonic spasm of thoracic muscles in, 540
traumatic and reflex, 530, 533
wounding of tongue during attacks of, 287
- Epistaxis, 73
- Epithelial casts, forms of, in urine, 424
illustrated, 424
- Epithelium, ciliated, transfer of mucus by, 167
in sputum, 176
in urine, kinds and significance of, 420
renal, illustrated, 421
- Equilibrium, an act of coördination, 527
- Equinia, acute nasal catarrh in, 74
- Erb, normal electrode of, 502
reference to, 461, 469, 476, 498, 501, 504, 508, 509, 510, 511, 512, 514, 516, 517, 520, 521, 523, 524, 525, 567
- Erb's fine electrode, 507
point in brachial plexus, 487
supra-clavicular point, 510
- Ergotism, gangrene in, 577
- Eruetation, odor of, 359

- Erysipelas, coccus of, 161
 enlargement of spleen in, 335
 fever in, 65
 leucoeytosis in, 278
 recurrence of, 22
 resembles inflammation of streptococcus erysipelatosus, 604
 vomiting in, 358
- Erythro-dextrin from starch, 353
- Esbach's albuminometer described and illustrated, 438
- Escherich, reference to, 388
- Eserine, effect of, on pupil, 567
- Ether poisoning, cause of hæmato-jaundice, 47
- Ethmoid nerve, illustrated, 485
- Etiology, value of, 20
- Ewald, reference to, 349, 351, 354
- Exacerbation of febrile disease shown by temperature, 65
- Examination, electrical, details of, 507
 general, divisions of, 31
 method of, in diseases of nervous system, 463
 of patients 24
 of the blood, 270
 special, scheme for, 27
- Examining electrode, size of, 502
- Exanthemata from poisons, 50
- Exanthematous diseases, 49
 fevers, enlargement of spleen in, 334
- Excesses, venereal, cause of disease, 21
- Excitability, bilateral variations of, 518
 increased in tetanus, 526
 lessened, when it occurs, 525
 mechanical, of muscles and nerves, 526
 of nerve (muscle), degree of, 505
 quantitative and qualitative, of nerves and muscles, 516
- Excitement, effect of, on amount of urine, 401
 on heart-sounds, 216
 on pulse in fever, 240
 upon pulse, 235
 headache after, 483
 induces perspiration, 37
 mental, effect of, on heart, 198
 heart not to be examined after, 201
 syncope from, 471
- Exciting causes, effects of, on chronic diseases, 21
 of disease, 21, 22
- Exclusion, determining limits of liver by, 328
- Exertion, albumin in urine after, 437
 effects of, in auscultation of heart, 211
 on action of heart, 198
 on pulse in fever, 240
 upon pulse, 235
 headache after, 483
 heart not to be examined after, 201
 mental, glycosuria after, 443
 muscular, a cause of idiopathic hypertrophy, 196
 over-, weakness of heart-sounds from, 218
 severe, a cause of emphysema of skin, 56
- Exhaustion which accompanies vomiting, 359
- Exophthalmia, 565
- Exophthalmus paralyticus, 563
- Exotic diseases, 21
- Expectoration absent when there is no cough, 167
 defined, 167
 examination of, 167
 general characteristics of, 168
 kinds of, 168
- Experiment to illustrate effect of length of cylindrical cavities upon pitch of sound, 110
- Experimental meal, Ewald's, 349
 Jaworski's, 349
 Leube's, 347
 relative merits of each, 349
- Expiration, bronchial breathing usually most distinct with, 147
 effect of, on circulation in jugular vein, 262
 in emphysema, 84
 muscles of, 97
 position of liver during, 320
 pressure of respiratory air in, 164
 prolonged, in commencing tuberculosis of apices an important sign, 150
 when occurs, 145
 rôle of the abdominal muscles in, 540
 sound of, bronchial in character, 142
- Expiratory bulging, 98
 dyspnoea in emphysema, 84
 relation of, to emphysema, 85
 to inspiratory, 100

- Expiratory dyspnoea, when exists, 99
 pressure greater than inspiratory, 164
 valvular sound in the crural vein in health, 269
- Exploratory puncture, directions regarding, 162
 of abdomen, value of, 318
 of pleura, how performed, 160
 of the heart, 234
 use of, 130
- Exposure a cause of disease, 21
- Extra-pericardial friction sounds, 233
- Extremities, nerves of, motor tracts of, illustrated, 453
- Extremity, lower, muscles of, 545
 muscles of the upper, 540
- Exudation depressing the diaphragm, 128
 diagnosis of, from transudation, 160
 extent of, shown by area of deadness, 128
 in abdomen, value of measuring circumference of, 316
 increase of chloride of sodium in urine with, 434
 inflammatory, in abdomen, 317
 kinds of, in pleural cavity, 161
 plegaphonia over, 159
 pleural, encapsulated, 128
 measurement of thorax in, 163
 pleuritic, effect of, on vocal fremitus, 157
 or pericardial, conceals apex-beat, 201
 purulent, in sputum, 167
- Eye, affections of, in diseases of the nervous system, 561
 cystercerci in, from *tœnia solium*, 578
 determining paralysis of muscles of, 564
 function of individual muscles of, 564
 inflammation and ulceration of, from paralysis of nerve, 484
 movements of, paralysis of muscles, 562
 muscles of, 536
 significance of paralysis of, 564
- Eyelids, dropsy of, in kidney disease, 440
- Eyes, how closed, 536
- Eyes, relation of, to vision, illustrated, 570
 unequal refraction of two, 567
- F**ACE, motor centre for lower portion, 454
 muscles of, 536
 three most distinct points upon, 510
- Facial nerve, chorda tympani nerve joins the, 461
 effects of paralysis of, 536
 increased mechanical excitability of, in tetanus, 526
 lesion of, from caries of petrous portion of temporal bone, 469
 motor tracts of, illustrated, 453
 paralysis of, 548
 paralysis, diminished secretion of saliva in, 578
 effect upon taste in, 574
 hearing in, 572
 reflex, 497, 499
 rheumatic, partial EaR in, 525
 rheumatic paralysis, 520
 sense of taste in anterior portion of tongue affected in paralysis of, 461
 tract, paralysis of, bone reflex present in, 500
- Faradic battery, secondary or induced current, for examining nerves and muscles, 501
 current causes tetanic contraction, 506
 comparative unimportance of the poles, 504
 Erb's fine electrode for, 507
 relation of total strength to galvanic current, 514
 strength of, how measured, 502
 examination of nerve-muscle, described, 512
 to be followed by galvanic, 514
 excitability of the two sides of the body, 516
- Farado-cutaneous sensibility, 476.
 477
- Fasting stomach, gastric secretion in, 346

- Fat, absence of, 34
 development of, in diseases of
 blood-making organs, 41
 drops of, in urine, significance of,
 420
 effect of, on extent of abdomen, 309
 in conjunctiva not to be con-
 founded with jaundice, 45
 in urine after fatty food, 405
 lumps, needle-shaped crystals in
 stools, significance of, 386
 people, veins of, 260
 striae produced by accumulations
 of, 52
 variations in amount of, 34
- Fatigue a cause of disease, 21
- Fatty acids, crystals of, in sputum,
 184
 in sputum of gangrene, 190
 degeneration of heart, paleness in,
 41
 of kidney, epithelium found
 in urine of, 421
 heart, Cheyne-Stokes respiration,
 92
- Fauces, vomiting from tickling of, 358
- Favus in vomit, 366
- Fear produces perspiration, 36, 37
- Febrile diseases cause change in
 weight, 36
 exacerbation shown by tem-
 perature in, 65
 hæmic murmurs in, 229
 perspiration in, 37
 pulse in, 239
 subnormal temperature in, 63
 value of pulse in, 253
 weakness of heart-sounds in,
 218
- Febris hepatica, herpes with, 50
 recurrens, 37
- Fecal accumulation in stenosis of in-
 testine, 369
 odor of stool masked by other sub-
 stances in, 372
 vomiting not always fatal, 364
 when occurs, 364
- Feces, balls of, in intestine, diagnosis
 of, 310
 Charcot-Leyden's crystals in, 181
 in urine, 315
 involuntary discharge of, in at-
 tacks of epilepsy, 534
 microscopical constituents of, il-
 lustrated, 385
 examination of, method of, 385
- Feces mixed with blood, significance
 of, 375
 physical and chemical peculiari-
 ties of, 370
 section on, 367
- Feculent exudation in pleural exuda-
 tion, 161
 odor of urine, 414
- Fehleisen, reference to, 427
- Fehling's solution, estimating amount
 of sugar by, 446
 test for sugar, compared with
 polarizing method 447
- Female sexual organs, headache with
 diseases of, 483
- Ferment, in gangrene of lungs and
 bronchitis, 190
- Fermentation, alkaline, in urine, from
 micrococci, 425
 ammoniacal, of urine, effect of, 402
 increased formation of lactic acids
 in subacidity of stomach, with,
 356
 in dilated stomach, 346
 in intestinal canal, acid reaction
 of stool in, 372
 alkaline reaction of stool
 in, 372
 microorganisms that excite, in
 stomach, 343
 of contents of stomach with dila-
 tation of stomach, 308
 of urine in bladder, cause of turbid
 urine, 412, 415
 test for sugar, 445
- Ferrocyanide of potassium test for
 albumin in urine, 436
- Fetor of breath, 285
- Fever. Also *see* Temperature.
 acetonuria in, 448
 albuminuria with, 435
 alkalescence of blood diminished
 in, 283
 anidrosis of, resists therapeutic
 measures, 38
 brick-dust sediment in urine of,
 430
 casts in, 422
 cause of increased dyspnoea, 96
 chill of, phenomena of, 40
 chloride of sodium in urine dimin-
 ished in, 434
 chlorides diminished in, 60
 coating of tongue in, 287
 continued, sweat diminished in,
 38

- Fever, continued, urine in, 426
 continuous, significance of, 587
 critical perturbation in, 68
 curve, effect of antipyretics on, 67
 dark color of urine of, 408
 defervescence of, 67
 defined, 60
 delay in absorption from stomach
 in cases of, 355
 diaceturia in, 447
 diminished amount of urine in,
 407
 disturbed nutrition in, 575
 effect of, upon heart's action, 201
 exacerbation of, 62
 frequent pulse with, 238
 heart sounds strengthened in, 217
 hectic, 68
 hyaline casts in urine of, 423
 in connection with nervous dis-
 eases, 575
 increase of urea in, 433
 urobilin in urine in, 48
 increased frequency of respiration
 in, 94
 formation of CO₂ in, 93
 intermittent destruction of red
 corpuscles in, 434
 herpes with, 50.
 malarial, defined, 70
 irregular in various diseases, 71
 lips in, 285
 mucus in urine of, 416
 of pus formation in, 68
 pulse in, 240
 recurrence of, 66
 recurrent, microorganisms of,
 found in blood, 281
 red skin in, 41
 tongue in, 287
 relapsing, leucocytosis in, 278
 section on, 57
 slow pulse in critical decline of,
 237
 sound heard over crural artery in
 high, 259
 subacidity of stomach in, 356
 subnormal temperature in crisis,
 63
 three types of, 62
 thrush in, 288
 tracing of pulse of, 247
 trembling of tongue in, 287
 tremor with rapidly-rising, 531
 typical course of, 64
 uric acid increased in, 434
- Fever, urinary products increased in,
 60
 urobilin in urine in, 409
 variations of temperature in, 63
 with albuminuria, 441
 Fibres-elastic in sputum, 175
 Fibrillary contractions, 530
 defined, 532
 Fibrin, floccules of, in the fluid from
 puncture of pleura, 160
 in urine in hæmaturia, 439
 Fibrinous tubes in sputum, 172
 Fibroma of larynx described, 597
 pedunculated, in larynx, illus-
 trated, 596
 Fifth nerve illustrated, 485
 Filaria sanguinis hominis, cause of
 hæmatochyluria, 283
 effects upon the urine and
 urinary passages, 425
 illustration of, 282
 Filehne, reference to, 190, 198
 Finger-percussion, 105
 advantages over hammer per-
 cussion, 116
 how done, 118
 -pleximeter percussion, 105
 Fingers, characteristic positions of the
 hand and, in paralysis, 544
 distribution of nerves to, 485
 paralysis of the muscles of, 543
 Finkler and Prior's spirals, 390, 607
 how distinguished from
 cholera bacillus, 391
 illustrated, 391
 Fischer, reference to, 478
 Fischl, reference to, 177
 Fissure of anus, pain at stool in, 370
 of Rolando illustrated, 466
 of Sylvius, artery of, 462
 effect of occlusion of, 462
 Flechsig, reference to, 452, 535, 586
 Fleisch's hæmometer recommended,
 271, 276
 Flexibilitas cerea defined, 535
 Fluctuation in abscess of liver and
 echinococcus, 326
 sign of fluid, 315
 Flügge, reference to, 184, 289, 604, 605
 Fluid, nature of, in plural cavity, by
 puncture, 160
 Fluids, effect of drinking, on color of
 urine, 402
 Folie musculaire, 534
 Fontanelle, cerebral blowing sound
 heard while still open, 258

- Food, albuminous, source of uric acid in urine, 405
 certain ones which cause polyuria, 406
 character and amount of stool affected by, 370
 color of the vomit from kinds of, 360
 effect of, upon color of stool, 372
 oxalate of lime in urine after certain foods named, 430
 particles of, in stools, 386
 tests of rapidity of passage of, from the stomach, 354
 when in sputum, 167
- Foot clonus, 499
 quaking with, 531
 paralysis of muscles of, 547
 phenomenon, defined, tested, significance of, 499
 objection to ordinary method of examination, 501
 sole of, reflex, 495
- Foramen ovale, open, systolic venous pulse with, 267
- Forearm, paralysis of muscles of, 543
- Forehead, how wrinkled, 536
- Form, knowledge of, section on, 481
 of expectoration, 168
 of spinal column, 467
- Fossa infra-spinata, 77
 deadened sound over, 114
 of Sylvius, illustrated, 466
 supra-spinata, 77
- Fossæ on front of thorax, 76, 81
- Fourth ventricle, 455
- Fränkel, A., pneumonia coccus of, 188
 reference to, 161
- Fränkel, B., reference to, 297
- Frédéricq, reference to, 286
- Frémissement cataire, 227
- Fremitus, laryngeal, 75
 vocal, palpation of, described, 156
- Frequency of breathing, anomalies of, 91
- Frerichs, reference to, 301, 443
- Frey, reference to, 246
- Friction, sensible, how recognized, 155
 -sounds, extra-pericardial, 233
 felt near heart, 204
 not heard if fluid is present, 156
 not to be confounded with moist râles, 155
 over peritoneum, 318
 pericardial, 230
- Friction-sounds, pleuritic, described, 155
 sometimes a favorable sign, indicating absorption of fluid, 156
 when occur, 156
- Friedländer, pneumonic coccus of, 188
- Friedreich, reference to, 180, 191, 267, 268, 269
- Friedreich's change of sound described, 113, 133
- Frontal convolution, left third, motor speech-centre, 555
 third, blood supply of, 462
 lobe illustrated, 466
- Frothy sputum, 169
- Fruity odor of urine, 414
 - when occurs, 414
- Fuliginous deposit on lips in fevers, 285
- Fulness of veins increased, 260
- Functional disease of nervous system, sudden return to normal condition, a certain sign of, 587
 neurosis, analgesia in, 479
- Fundus oculi, changes in, in diseases other than nervous, 601
 changes of, in nervous diseases, 600
 of stomach, anatomical relations of, 299
 position of, 298
- Fungi found in urine, 425
 in sputum, 174, 183
 pathogenic, section on, 389
 spores of, in feces, when found, 388
- Funke, reference to, 429
- Funnel-breast, cause of, 89
 described, 88
- Fürbringer, reference to, 182
- Furuncles, staphylococcus pyogenes found in, 603
- G**ABETT, reference to, 187
- Galacturia, 412
 produced by filaria sanguinis, 425
- Gall-bladder, distended, when felt, 322
 emptying of, by pressure, 326
 enlargement of, 331
 normal and pathological condition of, 326
 obstruction of, a cause of enlarged liver, 322
 position of, 320

- Gall-bladder, supuration of, gall-stones in stools from, 376
 -stones a cause of jaundice, 47
 accompanied by chill and fever, 64
 appearance of, described, 376
 in feces, how to find, 376
 sometimes can be felt, 326
- Gallop rhythm of heart described, 220, 221
- Galvanic battery, constant current of, for examining nerves and muscles, 501
 current, a strong, should never be used upon head, 511
 effect of, only at closing and opening of current, 506
 how to distinguish the poles of, 504
 measure for strength of, 502
 must not have too small an electrode, 502
 normal electrode for, 507
 quality of reaction with, 506
 relation of, to total strength of faradic current, 514
 used in determining the conductive resistance, 512
- examination, how conducted, 515
 methods, and explanation of terms used, 506
 should always follow the faradic, 514
- muscular reaction, normal, diagrammatic representation of, 519
 resistance, 476
 stimulation, qualitative irritability of muscles, 518
 tetanus, 505
- Galvanometer, absolute, 503
 damping of vibrations of, 515
 Edelmann's, 518
 limits of exactness of results from, 504
 time when to be read, 512, 515
- Ganglia of anterior horn, 456
- Ganglion, acoustic, 461
 geniculate, 461
 spheno-palatine, 461
- Gangrene, infusoria in sputum of, 183
 odorless, 171
 of lung, crystals in sputum of, 180, 181
 effect on thorax, 87
- Gangrene of lung, elastic threads in sputum of, 177, 179
 fatty acids in sputum of, 190
 ferment in, 190
 fetid sputum in, described, 174
 micrococci in sputum of, 189
 mucus in three layers in, 169
 odor of sputum in, 171
 relation of, to brain disease, 576
 rupture into œsophagus, 296
 spontaneous, in neuroses, 577
 starch corpuscles in sputum of, 180
- Gärtner, reference to, 389
- Gas in stomach and intestines sometimes gives a lung-sound, 113
 intestinal, effect on movements of diaphragm, 90
 sound on percussing over cavity containing, 109
- Gastric crises defined, 578
 juice, coagulating effect of, 353
 secretions, accumulation of, 346
- Gastritis, vomiting of pus in phlegmonous, 364
- Gastro-duodenal catarrh, 46
- Gastroxia, 361
- Gastroxynsis, 361
- Geigel, reference to, 267
- Geisler, reference to, 436
- Geniculate ganglion, 461
- Genital apparatus, disturbance of, section on, 580
- Gerhardt, reference to, 125, 132, 191, 259, 414
- Gerhardt's change of sound described, 133
- Gestures an acquired faculty, 549
- Glanders, bacilli of, found in blood, 282
- Glands, enlarged, compression of bronchi by, 43
- Gleet, diplococcus in urine, 427
 may be due to tuberculosis, 426
- Glioma, usually single, 585
- Glossitis cause of enlargement of tongue, 286
- Glosso-pharyngeus nerve, 461
- Glossy skin, 581
- Glottis, dilators of, paralysis of, 99
 spasm of, cause of cyanosis, 43
 due to eruption of teeth, 286
 muscles of, 597
 vibrations of, in phonation, 157

- Glycosuria, after poisoning with various substances named, 443
 in disease of oblongata, 579
 when occurs, 443
- Glykæmia, polyuria due to, 407
- Gmellin's test for bile in urine, 442
- Goll, columns of, 459
- Gonococci illustrated, 427
 in pus of gonorrhœa, 427
 stains of, 427
- Gonorrhœa, coccus of, 604
 hæmaturia from, 417
- Goose's throat, a condition of arteries, 256
- Görges, reference to, 404
- Gottstein, reference to, 595
- Gout, neuralgia in, 483
 uric acid found in blood in, 283
 often diminished during attack of, 434
- Gouty diathesis, increase of uric acid in, 434
- Gram, reference to method of staining, 188, 189, 190, 282, 603, 604, 605
- Granular casts, generally are hyaline, 424
 illustrated, 424
- Grape sugar in urine, when it occurs, 443
- Graphic communication, disturbances of, 549
- Gray substance of spinal cord, destruction of, results of, 491
- Greater circulation, perspiration in engorged condition of, 37
 slowing of, a cause of cyanosis, 44
- Griesinger, reference to, 382
- Guaiac, tincture of, test for bile pigment, 441
- Gummata, change in shape of liver from, 325
 of larynx, 595
 syphilitica, in larynx, 596
- Gums and teeth, examination of, 285
- Günzburg, reference to, 352
- Gutbrod, reference to, 199
- H**ABITATION, a cause of disease, 21
- Habits, a cause of disease, 21
- Habitual headache, hereditary, 483
- Hæmatemesis described, 361
 diseases with which it occurs, 362
- Hæmatin, absorption bands of, 272
- Hæmatin in solution, test for, 441
- Hæmatoidin, 46
 casts mixed with, in urine, 424
 crystals of, in sputum, 180
 in urine, 432
 in lungs of patients who have died from heart disease, 177
 in sputum, 172, 176
- Hæmato-jaundice, 47
- Hæmatoma of dura mater, inequality of pupils in, 567
- Hæmaturia, 410, 416
 albumin with, 441
 due to strangulus gigas, 425
 fibrin in urine in, 439
 from distoma hæmatobium, 425
 produced by filaria sanguinis, 425
 use of microscope in, 418
 when occurs, 417
- Hæmic murmurs, 229
- Hæmin, crystals of, illustrated, 363
 test for, 363, 364, 375, 442
- Hæmochromometer, instrument for estimating number of red corpuscles in blood, 271
- Hæmoglobin, absorption band of, 273
 amount of, diminished in anæmia and chlorosis, 275
 diagnostic importance of, 270
 appearance of, as a sediment in urine, 419
 approximative determination of amount of, 271
 casts of lumps of, 424
 diminished in blood in oligocythæmia, 275
 poikilocytosis with, 277
 exact quantity of, only determined by quantitative spectrum analysis, 272
 in separate corpuscles may be increased, 277
 loss of, cause of paleness, 46
 scale for estimating percentage of, in blood, 272
 tests for, 441
 urine to be examined for, when no corpuscles are found, 418
- Hæmoglobinæmia, 46, 410
 color of blood in, 271
 examination of blood in, 271
 value of spectroscopic examination of blood in, 272
- Hæmoglobinuria, 410, 419
 albumin with, 441

- Hæmometer, Fleischl's, recommended, 271, 276
- Hæmophile, hæmaturia in, 417
- Hæmoptysis, caution against speaking in, 159
- Haeser, reference to, 412
- Hair, growth of, 583
- Half-moon-shaped space (Traube) defined, 127, 128, 137, 299, 300, 306, 329, 333
diminished by enlarged spleen, 339
by exudation, 307
encroached upon by enlarged liver, 331
in examining the spleen, 337
outer boundary of, found by spleen, 333
- Hallervorden, reference to, 449
- Hallucinations of sight in delirium tremens, 471
- Hammer-pleximeter percussion, 105
- Hammond, W. A., reference to, 535
- Hand and fingers, characteristic positions of, in paralysis, 544
distribution of nerves to, 485
importance of knowledge of muscles of, and their innervation, 545
mode of examination in paralysis, 544
nerves of, 485
paralysis of muscles of, 543
- Harnack, reference to, 175, 181, 185, 281
- Hauser, reference to, 184
- Hawking described, 166
- Hayem's counting chamber described, 274
- Head and neck, points of electrical irritation upon, illustrated, 508
a strong galvanic current should never be used upon, 511
distribution of cutaneous sensitive nerves upon, illustrated, 485
nerves of, 484
nervous pain in, 466
- Headache, circumscribed, when disease causing it is so, 482
from uræmia, 440
significance of, 482
unilateral (migraine), 483
- Health, patellar tendon reflex always present in, 499
- Hearing, centre of, 460
- Heart, action of, increases perspiration, 37
interfered with by pressure on diaphragm, 40
rapidity and strength of, 212
anatomy of, 191
apparent enlargement of, 209
auscultation of, 211
-beat not to be confounded with apex beat, 201, 203
boundary between, and lung illustrated, 304
caution regarding, when making exploratory puncture, 162
change in form of, 196
in systole, 198
chronic diseases of, paleness in; 41
subnormal temperature with, 64
-deadness, boundaries of, 124
diminished with extension of lung boundaries, 136
small when lungs are expanded, 136
degeneration of, weakens apex-beat, 201
diminished work of, weakens apex-beat, 201
disease, Cheyne-Stokes breathing in, 92
development of fat in, 41
dyspnœa in, 96
effects of, on circulation through lungs, 44
hæmatoidin in the lungs of patients who have died from, 177
importance of second pulmonary sound in; 218
infarction of spleen from, 335
inherited, 20
pulse in, 239
with effusion, 33
with slight compensation, gallop rhythm with, 221
dislocation of, 199
displaced by exudation, 128
displacement of, by tumors, 255
disturbed in chronic jaundice, 47
-dulness, absolute, 205
area of, enlarged, 208
diminished, 210
displacement of, 210
parietal area of heart, 204
relative, defined, 205, 207, 208

- Heart-dulness, size and diagnostic value of, 207
 enlarged, larger parietal area with, 197
 enlargement of, cause of expansion of chest, 86
 diagnosis of, 200
 effect on apex, 199
 left, makes the half-moon-shaped space smaller, 306
 pulsations at base of, in, 203
 simulated, 197
 examination of, 191
 excited action of, in Basedow's case, 201, 259
 in nicotine poisoning, 201
 exploratory puncture of, 234
 failure. *Also see* Heart, weak.
 Cheyne-Stokes breathing in, 92
 confused sounds in, 212
 diagnostic value of heart-sounds in, 217
 due to disease of its muscle, 40
 dyspnœa in, 96
 gallop rhythm a sign of, 221
 pulse in, 240
 lowering of temperature in, 71
 first sound a mixed one, 214
 doubled, 216
 hæmatoidin in sputum in disease of, 172
 hypertrophy and dilatation, area of dulness enlarged in, 208
 of, pulse in, 244
 or dilatation of, not to be mistaken in retraction of lung, 137
 other than valvular, 196
 increased labor of, measured by specific gravity of urine, 413
 inspection and palpation of, 197
 -liver boundary of, 329
 location of, in side position of patient, 193
 mechanical displacement of, 87
 method of percussing, 208
 movement of blood in, 193
 murmurs, localization of, 223
 organic distinguished from inorganic, 230
 endocardial, defined, 221
 relation of, to time of action of the heart, 224
 transmission of, 228
 when heard, 222
- Heart muscle, diminished amount of urine in diseases of, 407
 weakness of sounds in paralysis of, 218
 nervous affections of, in connection with disease of the nose, 575
 neuroses, 577
 normal percussion figure of, 205
 organic disease of, palpitation and pain with, 577
 murmur of, 219
 paleness a symptom of disease of, 40
 palpitation of, in mitral defects, 240
 nervous, 201
 parietal area of, changed by dislocation of, 211
 percussion of, 204
 physical phenomena of, 193
 place of, makes asymmetry of sound on right or left side of chest, 121
 points of election for auscultating, 213, 214
 position of, 191
 in children, 192
 powerful action of, a cause of thoracic pulsation, 102
 pressed upon by meteorism, 309
 projection of neighborhood of, 202
 pulsations at base of, 203
 of, palpation of, 102
 pulse in valvular disease of, 240
 relation between size and energy of action of, 201
 of, and area of dulness, 205
 of, and parietal portion, 196
 of, to diseases of the brain, 576
 of, to lungs, 79
 relative deadness of sound over, 124
 representation of action of, 215
 resistance of, 205, 208
 simple dilatation of, 196
 slow pulse in certain conditions of, 237
 -sound, metallic, in pneumo-pericardium, 210
 -sounds doubled, 219
 metallic, explained, 221
 normal, described, 212
 variations of, 216
 origin of, 212

- Heart-sounds, pathological changes in, 216
 strengthened, heard over larger area, 217
 tone of, variations of, 216
 weakening of individual, 219
 when weakened, 218
 strength of, estimated by pulse, 240
 value of absolute dulness, 207
 of pulse in displacement of, 253
 in showing complicating disease of, 253
 valvular disease of, enlargement of liver with, 324
 sequela of rheumatism, 22
 venous engorgement from defect of right, 261
 weak. *Also see* Heart failure.
 area of dulness enlarged in, 209
 murmurs indistinct in, 223
 thrombi in, a cause of emboli, 576
 with dilatation, a cause of insufficiency, 194
 weakness, character of pulse in, 243, 244
- Hearing, importance of, determining disease of, 572
 morbidly acute, 572
 place of, in speech, 550
 subjective sensibility of, when occurs, 572
 testing of, 571
- Heat induces perspiration, 37
 sensations of, 577
- Heaving, strong apex-beat, 200, 201
- Hebetude, tongue often left protruding when there is, 287
- Hectic fever, 68
 in tuberculosis, 42
- Hegar, reference to, 311, 398
- Height, relation of, to weight, 35
- Heitzmann, reference to, 590
- Heller, reference to, 378, 379, 383, 384
- Heller's test for blood pigment, 441
 for hæmin, 364
- Hematemesis with pulmonary hemorrhage, 167
- Hemialbuminose in urine, 435, 439
- Hemialbumose, a rare constituent of urine, 439
- Hemianæsthesia, 460, 461
 associated with unilateral anosmia, 573
- Hemianæsthesia defined, and when occurs, 479
 in gross hysteria, 534
- Hemianopsia, 460
 cortical, 568
 homonymous, defined, 569
 illustrated, 570
 phenomena of, 571
- Hemiathetosis occurs in same locations as hemichorea, 535
- Hemichorea, 535
- Hemicrania, one-sided redness of face in, 42
 unilateral redness of head in, 577
- Hemidrosis defined, 37
 in Basedow's disease, 38
- Hemiopia, 460
- Hemiplegia, 457, 494
 arthropathia in old, 583
 ataxia in some cases of, 529
 cruciata, 456, 489
 decubitus in, 582
 defined, 489
 dorsal flexion of foot with, 535
 hemichorea a forerunner or result of, 535
 right, illustrated, 453
 -sided, aphasia with, 555
- Hemisphere, right, has nothing to do with speech, 555
- Hemisystole, double positive venous pulse in, 267
 explained, 202
- Hemoptysis defined, 170
- Hemorrhage, bloody color of sputum from, 170
 cause of urobilin-icterus, 48
 cerebral, effect on breathing, 91
 most frequent in the region supplied by the middle cerebral artery, 463
 slow pulse in, 237
 cutaneous, contrasted with hyperæmia, 42
 effect of, on amount of blood in the body, 270
 internal, shown by temperature, 65
 sudden fall of temperature with, 63
 long-continued, a cause of dropsy, 53
 microcythæmia after, 276
 of lungs caused by distoma pulmonale, 183

- Hemorrhage of lungs, diagnosis from hemorrhage of stomach, 170
 starch corpuscles in sputum, 180
 of pons or oblongata, effect of, 457
 of stomach, 40
 microscope useless in, 365
 rectal, stools of, described, 374
 retinal, in hemorrhagic diathesis, 562
 slow pulse with, 237
 source of, in hæmaturia, diagnosis of, 417
 subnormal temperature with, 63
 sudden amaurosis after severe, 602
 symptoms of, 40
- Hemorrhages, cutaneous, 51
 distinguished from inflammations, 51
 in jaundice, 47
 when occur, 582
- Hemorrhagic diathesis, hemorrhage of stomach in, 362
 in chronic jaundice, 47
 retinal hemorrhage in, 562
 exudation with tubercle and carcinoma of pleura, 161
 infarction of kidney, hæmaturia with, 417, 418
- Hemorrhoids, hemorrhage from, 375
 pain at stool with, 370
- Henle, reference to, 421, 486, 487, 541
- Hepatitis cause of enlarged liver, 322
 interstitial, surface of liver in, 325
- Hepaticization of lung, deadened resonance over, 126
- Hereditary disposition to headache, 483
 taint shown by funnel-breast, 89
- Heredity, 20
- Hering, spectroscope devised by, 272
- Hernia, examination of seats of, 308
- Hernia cause of pressure on nerves, 469
- Hernial orifices to be examined in sudden obstipation, 369
- Herpes facialis, 50
 labialis and nasalis, 50
 zoster, relation to nerves, 581
- Herringham, reference to, 437
- Heubner, reference to, 112, 135, 317
- Hiccough defined, 540
 severe in abdominal and cerebral affections, 540
- High lung sound, 108
- Hildebrand, reference to, 356
- Hippocrates, reference to, 138, 156
- Hippocratic succussion confounded with splashing from stomach or colon, 156
 described, 156
- Hirschmann, reference to, 503
- History, clinical, defined, 17
 previous, what comprises, 20
- Hoarseness, how caused, 598
- Hollmann, reference to, 481, 482
- Homonymous parts to be tested together, 507
- Hooke, reference to, 138
- Hoppe, reference to, 190
- Horseshoe kidney, 393
- Hour-glass stomach, 302
- Huber, reference to, 428
- Hüfner, reference to, 434
- Hutchinson's spirometer, 164
 teeth, sign of congenital syphilis, 286
 triad, signs of syphilis, 286
- Hyaline casts described, and when occur, 422
 granular forms, 424
 illustrated, 423
 various additions to, 423
- Hydatid vibration with echinococcus of kidney, 396
 of liver, 326
- Hydræmia, albuminuria with, 435
 cause of œdema, 53, 54
 color of blood in, 271
 leucocytosis in, 278
 peculiarities of blood in, 275
 polyuria in, 406
- Hydrocephalus, anosmia with, 573
 choked disc with, 600
 head unevenly balanced in, 539
 how distinguished from rhachitis, 464
 pressing upon third ventricle, 601
 slow pulse with, 237
 with macrocephalus, 464
- Hydrocyanic acid, color of blood in poisoning by, 270
- Hydronephrosis, palpation of, 395
 tenderness in inflammatory, 395
- Hydropericardium, cause of weakened heart-sounds, 219
 increases area of heart-dulness, 209
- Hydroperitoneum. *See* Ascites.
- Hydro-pneumothorax, splashing in, 233
- Hydrops vesicæ felleæ, 326
- Hydrothionic urine, 415

- Hydrothorax, diagnosis by exploratory puncture, 129, 160
- Hypæsthesia defined, 477
- Hypacidity of gastric juice, effect of, 344
- Hyperacidity of gastric juice shown by microscopical examination of vomit, 365
- Hyperæsthesia defined, 478
- Hyperidrosis defined, 37
- Hypermetropia, 567
- Hyperosmia in hysteria and insanity, 574
- Hyperpyrexia, 61
- Hypersecretion of gastric juice with vomiting in nervous dyspepsia, 361
- of stomach juices, diagnosis of, 355
- with hyperacidity of stomach, 361
- Hypertrophic liver, surface of, 325
- Hypertrophy combined with atrophy, 493
- compensatory of one division of heart, 218
- idiopathic, of heart, 196
- of a ventricle shown by strengthening of the sound of corresponding valve, 217
- of heart, area of dulness enlarged in, 208
- cause of projection of region of heart, 202
- compensatory, 195
- degeneration of, weak apex-beat in, 201
- not to be mistaken in retraction of lung, 137
- other than valvular, 196
- right and left, 251
- (with dilatation), diagnosis from simple dilatation, 196
- of left ventricle, 252
- aortic second sound felt in, 218
- pulsation with, 253, 254
- apex-beat, when absent in, 202
- capillary pulse in, 256
- heart-sounds strengthened in, 217
- polyuria with, 406
- pulsations in arteries in, 256
- pulse with, 242
- slow pulse with, 237
- Hypertrophy of muscles, 490, 493
- how recognized, 494
- of right heart, venous engorgement with, 261
- ventricle caused by emphysema of lungs, 210
- pulmonary second sound felt in, 218
- with emphysema of lungs, 204
- Hyphidrosis defined, 37
- Hypnosis, catalepsy with, 536
- over-excitability of nerves and muscles in, 526
- Hypochondria, oxalate of lime in urine of, 430
- phosphaturia in, 432
- Hypochondrium defined, 297
- illustrated, 298
- left, projection of, by enlarged spleen, 334
- spleen lies in, 332
- projection of right, in enlargement of liver, 321
- right, portions of liver in, 319
- Hypodermic syringe used in exploratory puncture of pleura, 160
- Hypogastrium defined, 297
- illustrated, 298
- Hypoglossal paralysis, unilateral, described, 537
- Hypoglossus, paralysis of the, 548
- Hysteria, absence of pharyngeal reflex in, 497
- allochiria in, 478
- anæsthesia of larynx in, 576
- of pharynx in, 577
- aphonia in, 598
- catalepsy with, 536
- disturbance of breathing in, 576
- dumbness after an attack of, 548
- epithelium in bloody sputum of, 176
- gross, described, 534
- headache with, 482
- hemianæsthesia with, 479
- hemidrosis in, 38
- hyperosmia and parosmia in, 574
- hypersecretion of stomach in, 357
- increased tendon reflex in, 500
- laryngeal spasm in, 576
- loss of voice in, 538
- narrowing of field of vision in, 569
- nervous cough in, 165
- opisthotonus with convulsions of, 468

- Hysteria**, palpitation of heart with, 577
 paralysis in, 75
 of diaphragm in, 90
 peculiar bloody sputum with, 171
 polydipsia and polyuria with, 406
 relations of, to sexual organs in women, 581
 sensibility of cranium to pressure in, 466
 spasms in, 37, 494, 581
 tenderness of vertebræ in, 467
 tonic spasms in, 532
 total ageusia points to, 574
 tremor with, 531
 unilateral elevation of temperature in, 71
 vomiting in, 358, 361, 578
- Hysterical and epileptic spasms**, difference between, 533
 convulsions, likeness of, to epileptic, 533
 hemianæsthesia, 587
 paralysis, EaR not present in, 525
 persons, over-excitability of, 526
 signs, 534
- Hystero-epilepsy**, 533
 cyanosis in, 43
 distinguished from epilepsy, 580
 stages of, 534
 tongue never bitten in attacks of, 287
 -traumatic neurosis, analgesia in, 479
 paralysis, 493
- Hystero-genous zones**, 581, 587
 in gross hysteria, 534
- ICTERUS**. Also *see* Jaundice.
 bile pigment in sputum in, 172
 catarrhal, oxalate of lime in urine of, 430
 hepatogenic, color of stool in, 373
 slow pulse in, 237
 neonatorum, 47
 urobilin with, 411
 with puerperal pyæmia, a case of, 602
- Idiocy** defined, 472
- Idio-muscular contractions** defined, 526
- Idiopathic migraine**, 483
 neuralgia, 483
- Idiotism**, increased secretion of saliva in, 577
- Idiots**, incontinentia alvi in, 578
- Idiots**, involuntary discharge of urine by, 579
 skeleton of, 33
- Ileo-cæcal region**, cooing in, in typhoid fever, 312
 illustrated, 298
 -inguinal nerve illustrated, 487
- Ileus**, when occurs, 364
- Iliac fossa**, left, pain in, with dysentery, 308
 right, pain in, with typhoid fever, typhlitis, disease of vermiform appendix, 308
 regions, pain in, due to inflammation, 309
 vein, œdema of legs from compression of, 314
 pressure upon, by enlarged retro-peritoneal glands, 341
- Imbecility** defined, 472
- Immediate percussion** defined, 104
- Inacidity of gastric juice**, 345, 346, 356
- Inactivity**, atrophy of, defined, a result of paralysis, 490
- Inanition**, acetonuria in, 448
 slow pulse in, 237
- Incisura cardiaca**, 192
 and parietal relation of heart, 197
 illustrated, 304, 327
 in deep inspiration, 125
 the lung-heart boundary, 122
- Incompensation**, difficulties in making diagnosis when present, 253
 of heart defined, 219
- Incontinence of urine**, 400, 579
- Incontinentia alvi**, when occurs, 370, 578
- Incubation**, period of, defined, 22
- Incubator**, testing digestive power of gastric juice in, 352
- Indican**, coloring pigment in urine, 402
 in urine, 435
 described, and tests of, 409, 435
 when occurs, 409
- Indifferent electrode**, 501
 where placed, 502
- Indirect percussion** defined, 104
- Inebriety** concealed, 20
- Infantile paralysis**, 493
- Infarction**, hemorrhagic, of kidney, hæmaturia with, 417, 418
 of lung, deadened sound over, 127
 mucous, mucus in feces in, 387

- Infarction of lungs, bronchial frothing**
 in, 146
 dyspnœa in, 95
 friction sounds with, 156
 weak percussion over, 115
 pulmonary, bloody sputum in, 170
- Infection distinguished from contagion,** 22
- Infectious diseases,** 20
 acute, delirium in, 471
 headache with, 483
 leucocytosis in, 278
 ataxia after acute, 529
 disturbance of consciousness in, 470
 Ear with paralysis in, 524
 enlarged liver with, 322
 enlargement of spleen in, 334
 epileptiform attacks in the beginning of acute, 533
 gallop rhythm a sign of heart failure in, 221
 glycosuria in, 443
 hæmato-jaundice in, 47
 hæmoglobin in urine with, 411
 indicated by high morning temperature, 64
 local gangrene in acute, 577
 position of patient in, 32
 respiration in, 91
 slight amount of vomit in, 360
 ulceration of larynx with acute, 595
 value of pulse in beginning of, 253
 venous thrombosis in severe acute, 268
 vomiting in beginning of certain, 358
 influence, neuralgia from, 483
- Inflammation, leucocytosis in all kinds of,** 278
 œdema in the neighborhood of, 54
 of chest, pain with, 101
- Infra-clavicular spaces, percussion note over,** 119, 120
- Infra-scapular space,** 77
- Infra-trochlear nerve illustrated,** 485
- Infusoria found in stools of diarrhœa,** 383
 in sputum, 183
- Inguinal region defined,** 297
 illustrated, 298
 pain in, from psoas abscess, 309
- Inhalation of dust a cause of disease,** 21
- Inherited diseases,** 20
 tendency, 20
- Injuries, scars from, important in nervous diseases,** 52
- Inner capsule, disturbance of vision by lesion of,** 460
- Inorganic murmurs,** 229
 sediments in urine, section on, 428-433
 most frequent forms in urine, 428
- Inosite in urine in diabetes insipidus,** 447
- Insane, incontinentia alvi in the,** 578
 involuntary discharge of urine by the, 579
- Insanity, hyperosmia and parosmia in,** 574
 superacidity of stomach in, 357
- Inspection of abdomen,** 313
 of intestine, method of, 308
 of kidneys, 394
 of stomach, 299
 of thorax, 81
 of veins, 260
 position of patient during, 81
- Inspiration, atelectatic crepitation in,** 154
 auxiliary muscles of, 96
 causes rapid emptying of veins, 262
 deep, effect on area of heart-dulness, 206
 forced, cause of, 100
 increased circumference of thorax in, 163
 in emphysema, 84
 jerking, when and where occurs, 145
 pressure of respiratory air in, 164
 relation to pulsus paradoxus, 263
 systolic subclavian murmurs heard at close of, 259
 tonic and clonic spasm of thoracic muscles of, in tetanus, 540
 variation of pressure during, in pleural and subphrenic cavity, 317
 vesicular breathing only heard in, 142
- Inspiratory dyspnœa, relation to expiratory,** 100
 when exists, 99
 with emphysema, 100

- Inspiratory pressure, in what diseases diminished, 164
- Insufficiency due to endocarditis, 194
 mitral, systolic venous pulse with, 267
 of aorta, cause of pulsation, 254
 255, 256
 of crural vein valve, murmur with, 268
 of tricuspid valve, positive venous pulse pathognomonic of, 264
 pulmonary second sound in, 218
 of valve, effect of, 194
 valvular, effects of, 193
- Intelligence, cloudiness of, in uræmia, 440
 development of, 549
- Intensity of lung sound, 108, 112
 of sound of organs containing air explained, 106
- Intercostal muscles, atrophied with lung cavities, 98
 pain in trichinosis of, 44
 paresis of, pulsation with, 102
- nerves, neuralgia of, in tabes, 484
- neuralgia, 101
 increase of abdominal reflex in, 496
- space, second, heart-sounds heard at, 214
- spaces, 82, 84
 in phthisical thorax, 84
- Intermittent fever, 69
 destruction of red corpuscles in, 434
 herpes with, 50
 increase of chloride of sodium in urine in, 434
 malarial, defined, 70
 range of temperature of, 63
 sweat in, 37
- Internal capsule, 454, 461
 blood-supply of, 462
 effect of lesion of, 457
 of local disease of, 459
 hemianæsthesia with deposits in, 479
- jugular veins, positive venous pulse in, 265
- organs, disease of, effect on weight of body, 36
 diseases of, effect on skin, 39
 effect of engorgement of veins on, 260
- Interscapular space, 77
 percussion note over, 120
- Intestinal bacteria in stools, value of, 388
 canal, portion of, in stool, from sloughing, 376
- catarrh, acid or alkaline stool in, 372
 bilious stool in, 373
 diffuse dull pain with, 308
 due to tape-worm, 377
 infusoria found in stools in, 383
 mucus in feces in, 387
 mucous stools in, 374
 particles of food in feces in, 386
- contents, decomposition of vegetable parasites from, 388
 crises defined, 578
 digestion shown by stools, 366
 discharges, frequency and character described, 367, 368
 diseases with diminished sweat, 38
- gas hinders action of diaphragm, 90
- hemorrhage, 65
 phenomena of, 40
- infarction defined, 374
- irritation from worms, a cause of epileptiform attacks in children, 533
- peristalsis sometimes can be seen, 309
- Intestine, amyloid degeneration of, forms of fat found in feces in, 386
 auscultation of, 312
 invagination of, character of pain with, 308
 percussion of, 311
 perforation of, cause of pneumothorax, 210
 resistance of fluid in, in comparison with air, 315
 small, mistaken for colon, 310
- Intestines, closed tympanitic sound heard over, 111
 disturbance of, from venous engorgement, 261
 examination of, 308
 points in, 370
 hemorrhage from, appearances of blood in, 375
 importance of emptying, in examining abdominal organs, 341

- Intestines, inflating, for purposes of diagnosis, 312
 lung-sound, when heard over, 113
 metallic sounds over, 112
 Invagination of intestine, character of pain with, 308
 Invalidism, venous thrombosis as a result of, 268
 Involuntary discharges during an attack of epilepsy, 533, 534
 of stool, 579
 Iodide of potassium found in saliva, 289
 in urine after taking, 450
 Iron colors the vomit black, 360
 -dust, detection of, 177
 in epithelial cells in sputum, 177
 in sputum, 171
 solution of chloride of, a test for salicylic acid in urine, 354
 in the presence of alcohol, sugar, and acid salts, 351
 Irrigation of rectum, 311
 Irritability, electrical and mechanical, of muscles, 488
 of nerves and muscles, faradic and galvanic, representation of, 521
 Irritation, direct, 505
 indirect, 505
 of nerves from pressure, 482
 peripheral, sensitiveness to, 472
 Ischiatic nerve, electrical examination of, 511
 Ischuria paradoxa, 580
 Itching in jaundice, 47
- JACKSON'S** epilepsy, 533
 described, 533
 Jaffé, reference to, 190
 Jaksch, reference to, 180, 272, 279, 282, 283, 381, 382, 384, 385, 388, 423, 424, 439, 444, 447, 448
 Jaundice, 45. Also *see* Icterus.
 gall-stones in stools with, 376
 itching in, 47
 sometimes caused by *ascaris* in ductus choledochus, 381
 sweat in, 38
 with engorgement from displacement of right kidney, 396
 with puerperal pyæmia, a case of, 602
- Jaworski's experimental meal, 349
 Jendrassik, reference to, 501
 Jerking breathing, where noticed, 143
 inspiration distinguished from interrupted inspiration, 146
 when and where occurs, 145
 Johnson, reference to, 436
 Joint neuroses, 583
 Joints, chronic disease of, atrophy with, 493
 muscular atrophy from diseased, lessened excitability without EaR, 525
 Jugular vein, right, shape of opening and its relation to venous humming, 269
 veins, phenomena of circulation in, 262
 Jurasz, reference to, 258
- K**AHLER, reference to, 439
 Kaltenbach, reference to, 398
 Kannenberg, reference to, 183, 427
 KaSC, 520
 Kast, reference to, 434, 519, 520
 Keratin, coating for pills, in testing rapidity of passage of food from the stomach, 354
 Keratitis, parenchymatous, a sign of syphilis, 286
 Kidney, amyloid, casts in urine of, 422, 423
 contracted, casts in urine of, 422
 diminished sweat in, 38
 gallop rhythm of heart in, 221
 œdema from, is fugitive, 440
 polyuria with, 406
 relation to heart disease, 576
 disease, alkaline vomiting in, 366
 dropsy of, disease of, 440
 engorgement of, casts in urine of, 422
 hyaline casts in urine of, 423
 lateritious sediment in urine, 430
 epithelium from in case of disease, 421
 fatty, fatty casts in urine of, 423
 hemorrhage of the pelvis of, diagnosis of, 418
 hemorrhagic infarction of, hæmaturia with, 417, 418
 horseshoe, 393
 large white, adipose white corpuscles in urine of, 420

- Kidney, large white, paleness in, 41
 left, adjacent to fundus of stomach, 299
 new formations of, when can be felt, 395
 position and relation of right and left, 392
 pulse in contracted, 244
 tenderness in tumor of, 395
 of region of, when occurs, 395
 tracing of pulse of contracted, 247
 tumors of, diagnosis of, 397
 value of percussion in, 397
 urine from only one, 400
 vicarious action of one, 408
 wandering, 395
- Kidneys, anatomical situation of, illustrated, 393
 anatomy and topography of, 392
 engorgement of, albuminuria with, 435
 examination of, section on, 392-451
 injury to, hæmaturia with, 417
 local examination of, 394
 location of, illustrated, 321
 pathological condition of, 394
 position of, 79
 value of pulse in showing complicating disease of, 253
- Klemperer, reference to, 354, 437
- Knee-phenomenon, synonym for patellar reflex, 498
- Koch, reference to, 185, 390, 391
- Koch's cholera bacillus, described and illustrated, 389
 comma bacillus distinguished from Finkler-Prior's bacillus, 607
- Kosselt, reference to, 190
- Kreatinin hinders examination for sugar in urine, 405
- Krehl, reference to, 246
- Kronecker, reference to, 297
- Kühne, K., reference to, 439
- Külz, reference to, 447
- Kusmaul, reference to, 263, 301, 303, 551, 552, 555, 556, 558
- Kypho-scoliosis, 467
 a cause of hypertrophy of right ventricle, 196
 cases in which spleen can be felt, 334
 deadened sound over, 114
 described, 88
- Kypho-scoliosis, dyspnœa from, 95
- Kyphosis, 467
 described, 88
 from paralysis of erector trunci, 539
- L**AACHE, reference to, 275, 429, 430, 431, 432
- Lachrymal nerve illustrated, 485
- Lacing, tight, constriction of liver from, 323
- Laetic acid, excess of, in stomach, 345, 346
 fermentation, effect of, 343
 tests for, in contents of stomach, 351
- Lactose in urine, when occurs, and when demonstrable, 447
- Laennec, reference to, 104, 138, 142, 191
- Laennec's pectoriloquy described, 159
- Lagging behind in paralysis of sensation, 485
 detected by palpation, 103
 in breathing described, 87, 91
 in stenosis of a bronchus, 98
- Lagophthalmus, 536
- Lalopathy, 548
- Lameness, simulation of, 19
- Landerer, reference to, 54
- Landois, reference to, 246
- Landois & Sterling's Physiology, referred to, 505
- Lardosis from paralysis of erector trunci, 539
- Laryngeal mirror, 591
 muscles, action of, and effects of paralysis of, 538
 spasm defined, 576
- Laryngitis, acute, 598
 circumscribed phlegmonosa, results in abscess, 594
 hypoglottica illustrated, 593
 serious nature of, 594
 in children, 593
- Laryngoscopic examination of the larynx, section on, 589
 image, reversal of parts in, 591
- Larynx, abnormal redness of mucous membrane of, 592
 casts of, in croup, 172
 color of mucous membrane of, 591
 evidence in, of pressure by tumors, 255
 examination of, 74
 for recurrent paralysis, 296

- Larynx**, inflammations near, cause of cyanosis, 43
 laryngoscopic examination of, section on, 539
 view of, 590
 local examination of, 75
 nervous diseases in which it is affected, 576
 normal sound over, 119
 open tympanic sound, when it is percussed, 110
 paralysis of various muscles of, and results, 598
 pathological condition of, 592
 position and movements of portions of, 592
 sensitiveness of, a cause of cough, 165
 spasm of muscles of, 597
 stenosis of, 97
 tone of cough in ulceration and stenosis of, 166
 tympanic sound over, 121
 ulceration of, a cause of emphysema of skin, 56
 what to observe in examining, 591
- Lateral column of spinal cord**, 455
- Lateritious sediment in urine**, 402, 429, 430.
- Laveran**, reference to, 282
- Law of contraction**, 518
- Lead colic**, drawing in of abdominal wall in, 309
 pulse with, 244
 tracing of pulse of, 247
- headache in poisoning with, 483
 neuralgia from poisoning by, 483
 paralysis, 543
 Ear in, 525
- poisoning, 21
 black vomit in acute, 360
 cause of paleness, 41
 condition of teeth in, 286
 double sound heard over crural artery in, 259
- Leanness**, significance of, 34
- Leg**, motor centre for, 454
 muscles of, and their paralysis, 546
 points of electrical irritation upon, 514
- Legal**, reference to, 448
- Length of Thorax**, 163
- Lenticular nucleus**, 454
 blood-supply of, 462
 disease of both internal segments, with chorea, 535
- Leo**, reference to, 344
- Lepra**, 21
 bacillus described, staining of cultures of, 606
- Leptothrix buccalis** illustrated, 289
 in urine, 428
 in sputum, 175, 184
 pharyngomycosis leptothricia, 291
- Lesion**, location of, in cortico-muscular tract, effect of, 456
- Lethargy**, defined, 470
- Letzerich**, reference to, 190
- Leube**, reference to, 302, 347, 355, 426, 434, 445, 474
- Leube's experimental meal**, 347, 348
- Leucin**, form of, in urine, 431, 432
 when occurs, 432
- Leuckart**, reference to, 379
- Leucocytes with large nuclei**, 279
- Leucocythæmia**, relative, 275
- Leucocytosis** a physiological condition during digestion, 278
 defined, 278
- Leukæmia**, 41
 albuminuria with, 435
 color of blood in, 271
 crystals in blood in, 181
 defined, 278
 greatest enlargement of spleen in, 335
 hæmaturia in, 417
 red corpuscles diminished and paler in, 275
 retinal changes in, 602
 uric acid increased in, 434
 use of microscope in, 279
 various forms of, 279
- Levulose**, in urine, when occurs, 447
- Lewis**, reference to, 391
- Leyden**, reference to, 174, 179, 182, 190, 202, 267, 388
- Lichtheim**, reference to, 53, 552, 553, 555, 556, 558, 560
- Lieben**, reference to, 448
- Liebermeister**, reference to, 58, 238, 356
- Liebig**, reference to, 434
- Lientery stools**, 372
- Life**, mode of, cause of disease, 21
- Light**, source of, for laryngoscopic examinations, 589
- Lime**, oxalate of, in sputum, 182
- Linea costo-articularis**, 332, 338
- Lines drawn on thorax**, 76
- Lingual nerve**, chorda tympani in, 461
- Lintels**, 185

- Lintels of tubercular sputum, 177
 Lipæmia defined and when occurs, 280
 Lipomatosis cordis, weak apex-beat in, 201
 Lips, color of, 285
 Lipuria, 412
 occurs in chyluria, 447
 Literal agraphia an aphasic symptom, 561
 aphasia, 553, 556
 paragraphia, 561
 Litten, reference to, 427
 Liver, acute yellow atrophy of, ecchymosis in, 51
 anatomy of, 319
 average boundary lines of, 329
 cancer-navel upon, in carcinoma, 325
 cirrhosis of, tender at first, 324
 venous engorgement caused by, 262
 consistence of, in various diseases, 326
 constricted, sometimes tender, 324
 deadness, absolute, 124
 illustrated, 304
 in right mammillary line, 108
 relative, small when lungs expanded, 136
 downward displacement of, 128, 321, 322, 324
 movement of, in inspiration, 322
 enlargement of, causes and signs of, 322
 displacement from, 330
 due to venous engorgement, 260, 261
 effect on form of chest, 86
 makes half-moon-shaped space smaller, 306
 projection of right hypochondrium in, 321
 examination of, 319
 granulated, surface of, 325
 inspection of, 320
 -kidney angle, 393
 location of, illustrated, 321
 lower border of, rarely felt, 321
 mobility of boundaries of, 329
 mode of palpating described, 266
 motions during breathing, 323
 organs that border it, 320-
 palpation and percussion of, 323
 value of, 332
 Liver, pathological conditions of, 324
 relations of its boundaries, 329
 percussion limits of, illustrated, 326, 327, 328
 position of, 78, 79
 and boundaries of, illustrated, 319
 as affected by pleurisy or pneumothorax on right or left side, 331
 pressure upon, from meteorism, 309
 proportion of, that is parietal, 320
 -pulse, 302
 arterial, 257
 venous, 266
 relative, deadness of sound over, 124
 size and form of, 324
 in children, 320
 slight projection of, in children, 320
 square position of, 330
 -stomach boundary, 329
 surface of, in various diseases, 325
 that is displaced downward not to be confounded with enlarged, 331
 tilting of, in pleurisy, 199
 tumor of, 306
 unequal enlargement of, 331
 wandering, position of, 322
 not in contact with diaphragm, 322
 Lobes of the brain, upper and lower parietal, temporal, and frontal, 466
 of the lungs, boundaries of, 80
 Lobulated liver, from deep syphilitic scars, 325
 Lobus paracentralis, 454, 459
 Local sense, how tested, 474
 Location of thoracic contents illustrated, 319
 sense of, 473
 Löffler, reference to, 605, 606
 Logwood, color of urine after taking, 411
 Lordosis, 467
 from weakness or paralysis of muscles of spine, 467
 Louis, angle of, defined, 76, 78, 81, 82, 84
 in phthisical thorax, 84
 Löwenfeld, reference to, 523

- Lower extremity, illustration of cutaneous nerves of, 487
 nerves of, 488
 points of electrical irritation upon the back of, illustrated, 513
- Ludovici, angulus, 76, 78, 81, 82
- Ludwig, reference to, 198, 246
- Lumbar enlargement of cord, location of, 468
- Lumbo inguinal nerve illustrated, 487
- Lung-cavities, atrophy of intercostal muscles in, 98
 bronchial breathing over, 146
 metallic sounds over, 112
 tympanic sound with, when communicating with air, 131
- compression of, against thoracic wall increases vocal fremitus, 158
 by large exudation, 128
 from high position of diaphragm, 317
- contraction of, differentiated from primary deformity of chest, 88
 diminishes area of spleen-dulness, 339
 left, effect on heart, 203
- emphysema of cellular tissue from perforation of, 56
- fistula, sound of, defined, 153
- gangrene of, mucus in three layers in, 169
- heart boundary, 122, 125
- kidney boundary, 123
- left, lower border of, boundary of, 125
- liver boundary, 122, 124, 125, 328, 329
- overlaps the spleen and diminishes area of dulness over, 339
- retracted, tympanic sound with, 111
- sequestra, 172
- shrinking of, 197
- sound defined, 108
- spleen boundary, 122, 124
- stomach boundary, 122, 124
- thickening of, ringing râles with, 152
- tissue, decreased tension of, 135
 in sputum in abscess of lung, 172
 no irritative cough from, 165
- Lung tissue, relaxation of tympanic sound with, 130
 retracted, noise of spun-top over, 135
 thickening of, bronchial breathing in, 146
- Lungs, abnormal sounds over, 125
 abscess and gangrene of, elastic threads in sputum, 177
 hæmatoidin in sputum, 172
 active mobility of, 125, 210
 amount of expectoration from cavities in, 168, 169, 175
 anatomical boundaries of, 78, 79
 auscultation of, 138
 borders of, 80
 boundaries of, changed, 136, 304, 319
 rules to be observed in determining, 124
- brown induration of, dyspnœa in, 96
- catarrh of larynx in disease of, 593
- chronic diseases of, subnormal temperature with, 64
- consolidation of, cyanosis in, 43
- contraction of, a cause of hypertrophy of right ventricle, 196
- difficulties in determining their boundaries, 123
- diminished volume of, how recognized, 137
- diseases of, form of thorax in, 81
 which cause dyspnœa, 95
- disposition to disease of, 81
- disturbances of the circulation through, 44
- dust diseases of, 21
- elasticity of, lost in emphysema, 84
- emphysema of, a cause of displacement of heart, 199
 weakens apex-beat, 201
- examination of, 76
- gangrene of. Also *see* Gangrene.
 odor of sputum in, 171
- hemorrhage of, in tuberculosis, 170
- large cavity in, metallic heart-sounds with, 221
- lobes of, boundaries of, 80
 location of, illustrated, 321
- lower border of, in children, 192
 relatively deadened sound over, 114
 boundary of, 122

- Lungs, normal percussion of, boundaries of, 121
 sound over, 119
 œdema of, bloody sputum with, 170
 dyspnoea in, 95
 serous sputum a peculiarity of, 169
 percussion of, described, 118
 posterior boundaries of, illustrated, 123
 pressure upon, by meteorism, 309
 rapid breathing in inflammation of, 94
 relation of disease of, to certain brain diseases, 576
 to diaphragm, 80
 retraction of, measure of thorax in, 163
 near the heart, 137
 upward displacement of liver with, 323
 shrinking of, a cause of displacement of heart, 199, 200, 211
 both pulmonary sounds strengthened in, 218
 pulsations at base of heart in, 203
 starch corpuscles in the sputum in hemorrhage of, 180
 symptoms of hæmatemesis in hemorrhage of, 167
 thickening of, deadened sound from, 114
 feeling of resistance with, 116
 metallic râles with, 150
 simulates enlarged heart, 209
 thoracic boundaries of, 77
 topographical anatomy of, 76
 tuberculosis of, *see* Tuberculosis
 tumor of, peculiar sputum in, 171
 tumors of, deadened sound over, 127
 value of pulse in showing complicating disease of, 253
 vital capacity of, relation to size of body, 164
 wounds of, a cause of emphysema of skin, 56
- Lupus, may be the cause of catarrh of larynx, 593
- Luschka, reference to, 78, 79, 192, 319, 321
- Lustgarten, reference to, 399, 427
- Lymphatic glands, blowing murmurs over, 259
 leucocytosis in swelling of, 278
- Lymphatic glands swollen in syphilis and diphtheria, 290
- Lympho-sarcoma of spinal cord, hemialbumose in, 439
- Lysis defined, 67
- Lyssa, increased tendon reflex in, 500
- M**-A (milliampères) strength of current measured in, 512, 515
- Macrocephalus with hydrocephalus, 464
- Macrocytes, defined, occur in anæmia and in pernicious anæmia, 276
- Maixner, reference to, 439
- Malaise, from uræmia, 440
- Malaria, bacillus of, 282
 diagnostic value of temperature in, 64
 hæmoglobin in urine of, 411
 melanæmia in, 280
 neuralgia from, 483
 spleen much enlarged in, 335
- Malarial cachexia, 41
 intermittent fever, 70
- Malignant growths cause of paleness, 41
 pustule, 21
 examining blood for microorganism of, 282
- Mal perforant, defined, 582
- Mammillary line corresponds with border of liver, 327
 edge of liver at, 323
 variations of, 77
 lines, 297
 defined, 76
- Manègengang, 534
- Mania, with uræmia, 440
- Manneberg, reference to, 399, 427
- Manometer, use of, in puncture of cavity, 318
- Marasmus defined, 35
- Marchiafava, reference to, 282
- Marching a cause of disease, 21
- Marey, reference to, 246
- Marie, reference to, 560, 583
- Martius, reference to, 199
- Masseter spasm in trismus, 532
- Mastication, difficulty of, in paralysis, 537
 muscles of, 536
- Matterstock, reference to, 259
- Maxilla, superior, nerve supply of mucous membrane of, 484
- Meals, effect upon pulse, 235

- Measles**, 49
 acute nasal catarrh in, 74
 coin shaped sputa in bronchitis of, 169
 epileptiform convulsions in the beginning of, 533
 inflammation of larynx in, 75
 petechiæ in, may be overlooked, 51
 recurrence of, 22
- Measurement of thorax in aneurism of aorta**, 254
- Measuring circumference of abdomen**, value of, 316
 the thorax, 162
- Meat-juice stools in dysentery**, 375
- Mechanical Ear**, 526
 irritation, neuralgia from, 483
- Median nerve**, anæsthesia in the region of, from paralysis of brachial plexus, 487
 distribution to hand, 545
 illustrated, 486
 paralysis of, 544
- Mediate percussion defined**, 104
- Mediastinal emphysema**, crepitations of, 233
 pericarditis, 204
 tumor, measurement of thorax in, 163
 producing pressure-paralysis of recurrent nerve, 538
 swelling of cutaneous veins over sternum sign of, 262
 venous engorgement from, 261
 tumors affecting larynx, 75
 displacement of the heart by, 199
 effect on heart, 201
- Mediastinitis**, callous, diastolic collapse of cervical veins in, 267
 effect upon venous circulation, 263
- Mediastinum displaced by exudation**, 128
 displacement of, how recognized, 137
 thickening of, simulates enlarged heart, 209
 tumors of, cyanosis an effect of, 44
- Medicines**, exanthem from use of, 50
 urine as affected by, 450
- Medulla**, anæmic necrosis of, 462
 blood-supply of, 462
 softening of, 599
- Melæna neonatorum**, hemorrhage of stomach with, 362
- Melanæmia defined**, and connection with malaria, 280
- Melancholia attonita**, 536
- Melanotic tumors**, color of urine with, 411
- Meltzer**, reference to, 297
- Menière's disease**, tinnitus aurium with, 573
- Meninges**, disease of, feeling of constriction about thorax in, 482
 tumors of, disturbances of consciousness from, 471
- Meningitis**, anosmia from, 573
 basilar, rigidity of neck in, 468
 slow pulse in, 237
 breathing in, 91
 cerebro-spinal, herpes with, 50
 irregular temperature with, 71
 Cheyne-Stokes respiration in, 92
 choked disc with, 600
 consciousness may be retained in, 471
 disturbance of consciousness in, 470
 drawing-in of abdominal wall in, 309
 from disease of the nose, 576
 headache with, 482
 irregular temperature in, 71
 neuro-retinitis with, 601
 pain in spine in, 483
 posture in, 33
 pulse in, 245
 purulent, affections of hearing with, 572
 relation of, to disease of the lungs, 576
 sensibility of cranium to pressure in, 466
 slow pulse with, 239
 spinalis, herpes zoster in, 581
 spinal, rigidity of spinal column in, 468
 tenderness of vertebræ in, 467
 tubercular, suspected when nutrition is poor, 575
 value of pulse in showing development of, 253
 vomiting in, 358
- Memory**, loss of, 556
 testing of, 469
- Mental condition**, during spasm, 530
 disease, first traces of, 470

- Mental diseases, hemidrosis in, 38
 disturbance due to fever, 60
 impressions produce perspiration, 36
 nerve illustrated, 485
- Mercurial poisoning, 21
 cause of paleness, 41
- Mercury, cocci in mouth in poisoning by, 289
 condition of teeth in poisoning by, 286
 headache in poisoning with, 483
 neuralgia from poisoning with, 483
 salivation caused by, 289
- Mesenteric glands, disease of, forms of fat found in feces, in, 386
- Mesocardia, 211
- Mesogastrium defined, 297
- Metallic after-sounds defined, 112
 associated sound accompanies bronchial breathing, 148
 heart-sound, 210
 murmurs, 227
 pericardial splashing, 233
 poisons from inhalation, 21
 râles, 150
 sound defined, 112
 with pneumothorax, 135
 with various conditions, 136
 tone over large cavities with smooth walls, 131
- Metamorphosing breathing defined, 148
- Meteorism cause of diminished area of liver-dulness, 331
 effect on extent of abdomen, 309
 on form of chest, 86
 employment of deep breathing in, 323
 intestinal, 313
 or peritoneal, metallic heart-sounds with, 221
 pressure by, upon liver, diaphragm, lungs, heart, 309
 with and without pain, value of, in diagnosis, 314
- Meteorismus peritonei defined, 313
 value of percussion in, 317
- Methæmoglobin, absorption band of, 273
 in the blood in poisoning by chloride of calcium, 272
 spectroscopic examination for, 442
- Methods of auscultation, direct and indirect, 138
- Methods of percussion of thorax, 118
- Methyl-violet test for free muriatic acid, 451
- Miasm, 21
- Microcephalus, 465
- Micrococci, casts of, in septic processes, 427
 in mouth, 289
 in purulent plural exudation, 161
 in sputum from mouth, 188
- Micrococcus gonorrhœus described, 604
 tetragenus, 184
 ureæ, 426
- Micro-millimetre, value of, 185, note.
- Micron, a measure, value of, 185, note.
- Microorganisms, examining blood for, 273
 in mouth, 289
 in sputum, 167
 in stomach, destroyed by anti-septic action of gastric juice, 343
 excess of, 345
 in the blood, 280
 in urine, staining of, 415
 mode of examining blood for, 282
 that excite fermentation, 342
- Microcytes, 276
 in anæmia, 276
 in pernicious anæmia, 276
- Microcythæmia, 274
 after hemorrhages in anæmia, 276
- Microscope, diagnosis of thrush by aid of, 288
 examination of contents of mouth by, 289
 generally useless in determining hemorrhage of stomach, 365
 magnifying power, use in examining the blood, 273
 use of, in diagnosis of diseases of palate and pharynx, 291
 in examining for cocci and bacilli in urine, 426
 urinary sediments, 415, 419
 in hæmaturia, value of, 418
- Microscopic appearance of uric acid, 428
 examination of blood, mode of procedure, 273
 value of, 271
 of urate of soda and lime, 429
- Micturition, difficult, a cause of diminution in amount of urine, 407

- Middle cranial fossa, effect of lesion of, 457
- Migraine defined, symptoms of, and when occurs, 483
 hemidrosis in, 38
 inequality of the pupils in, 567
 sometimes preceded by tinnitus aurium, 573
 temporary partial amaurosis in, 571
 unilateral redness of head in, 577
 vomiting with attacks of, 578
- Miliaria, 50
- Miliary tuberculosis affecting the choroïd, 562
- Milk, color of stool when the diet consists of, 373
 particles of, in sputum, 175
- Miller, reference to, 391
- Milliampère-meter, 503
- Mind, condition of, mode of examining, 469
- Minimal contraction, 512, 514
- Minkowsky, reference to, 449
- Miserere, when occurs, 364
- Mitral disease, enlargement of liver with, 322
 of heart, paleness in, 41
 venous engorgement in, 261
 first sound, the loudest heart-sound, 217
 insufficiency, 194, 195, 196
 and stenosis, effects of, 195
 color of skin in, 41
 dyspnœa in, 96
 murmur of, 224, 225
 pulse with, 242
 systolic venous pulse with, 267
 murmur heard at apex, 224
 stenosis, 194
 absence of pulse with, 243
 arhythm of pulse in, 241
 character of pulse with, 243
 division of second sound at apex in, 220
 double sound over crural artery in, 259
 first sound strengthened at apex in, 218
 pulse in, 251, 253
 weakening of aortic second sound in, 219
 valve causes a systolic sound, 213, 214
 where best heard, 213, 214
- Mobility of spinal column diminished, 467
 of spleen, 335
- Mode of life, effect on complexion, 39
- Moist cough described, 166
 râles, 149
 explained; when occur, 151
- Monoplegia, 457
 facialis, brachialis, cruralis, defined, 489
 with partial epilepsy, 533
- Monos (infusorium) in sputum, 183
- Moore's test for sugar, 445
- Morbus Addisonii, 48
 Basedowii, apex-beat with, 201, 216
 blowing murmur with, 259
 tremor of, 531
 Werlhofii, hæmaturia in, 417
- Morenheim's depression defined, 76
- Morgagni, sinus, 591
- Moritz, reference to, 132
- Morphia, effect of, on pupil, 567
 induces perspiration, 37
 poisoning by, Cheyne-Stokes breathing in, 92
 tremor from, 531
- Mosso, reference to, 93, note.
- Motility, disturbances of, 488
 of lungs, when diminished, 137
- Motion, loss of, from paralysis and stiffness not to be confounded, 488
- Motor aphasia, 553
 cortical regions, location of, 466
 of occipital and temporal lobes, relation to cranium, 465
 cranial nerves, 455
 memory, 549
 points, 508
 stimuli, 456
- Mould in sputum, 190
- Mouth, effect of opening and closing of, upon the pitch of sound, 111
 examination of, 284
 microscopical examination of contents of, 289
 odor from, importance of, 285
 open, tympanitic sound when it is percussed, 110
- Movements, associated, defined, 535
 sensation of, defined, 474
- Mucin in urine, test for, 441
- Muco-purulent sputum described, 168
- Mucor (mould) in sputum, 190
- Mucous colic, 374

- Mucous corpuscles in vomit**, 365
 deposits upon larynx, 592
 infarction, mucus in feces in, 387
 membrane of larynx, color of, 591
 reflexes of, 496
 sputum described, 168
 stool described, and significance of, 373
 threads in urine not to be confounded with casts, 416
- Mucus**, cloud of, in normal urine, 402
 in feces, 387
 in three layers described, 169
 in urine, 416
 causes it to be jelly-like, 419
 chemical proof of, 416
 threads of, in sputum, 175
- Muguet in sputum**, 175
- Mulberry tongue** a sign of scarlet fever, 287
- Müller**, reference to, 386, 387
- Müller, F.**, reference to, 371
- Multiple neuritis**, diagnosis from tabes, 580
 EaR with, 524
 neuralgic pain in, 484
 sclerosis, allochiria in, 478
 atrophy of the optic nerve in, 562, 661
 narrowing of field of vision in, 569
 scanning speech in, 548
 tremor with, 531
- Mumps** (inflammation of parotid gland), 288
- Muriatic acid**, excess of, in stomach, 345
 free, testing for, with phloroglucin-vanillin, 350
 with tropæolin paper, 350
 when wanting, 356
 in stomach, 344
 quantitative examination, 351
 relation to pepsin, 352
- Murmurs**, anæmic, 229
 blowing over lymphatic glands, 259
 characters of, 227
 combination of several, differentiation of, 228
 diastolic and systolic, 228
 differential diagnosis between peri- and endocardial, 232
 double, described, 259
 endocardial, loudness of, to what due, 223
- Murmurs heard over veins**, 268
 heart, when heard, 222
 metallic, 227
 pericardial, 230
 presystolic, 228, 251
 explained, 226
 normal venous pulse with, 263
 systolic and diastolic, 226
 subclavian, 259
 that can be felt, 227
- Muscles and nerves**, electrical examination of, 501
 mechanical excitability of, 526
 auxiliary, of inspiration, 96
 of respiration, 83, 541
 behavior of, when irritated, 507
 diagram of their innervation, 454
 disturbance of nutrition and tone of, 489
 EaR with degenerative atrophy of, 524
 increased tonus of voluntary, 535
 motor points of, 508
 nutrition of, nervous influence, 456
 of arm and hand, importance of a knowledge of, and their innervation, 545
 of the eye, action of, and paralysis of, 562
 function of individual, 564
 paralysis of, 562
 of the lower extremity, 545
 of the thorax, diaphragm and abdomen, 540
 effects of paralysis of, 540
 of the trunk, action of, and effect of paralysis of, 539
 of the upper extremity, 540
 spinal, pain in, 483
 tonus of, 528
 voluntary, innervation, function, and the diseases that disturb them, 536
- Muscular atrophy** from diseased joints, lessened excitability without EaR, 525
 spinal progressive, fibrillary contractions in, 532
 dystrophia, 493
 irritation, direct, on the back, 512
 rheumatism, pain in spinal muscles, 483
 sense, 474, 480
 defined, 480
 test for, 481

- Muscular sense, tract of, 459**
Musculo-spiral nerve, examination of, 512
 muscles supplied by, examination of, 515
 paralysis of, from compression, 487
Music an acquired faculty, 549
 power to produce, 550
Mydriasis, 566, 567
Myelitis, 580
 allochiria in, 478
 diminished tendon reflex in, 500
 transversa, 492, 493
 clonic spasms in, 532
 cystitis in, 579
 increase of tendon reflex in, 500
 involuntary passage of urine in, 580
Myocarditis, arhythm of pulse in, 241
 fibrinous, slow pulse in, 237
 pulse in, 252
 pulsus intercedens in, 241
 weak apex-beat in, 201
Myopathic muscular atrophy, EaR in, 524
 lessened excitability in, without EaR, 525
 paralysis, EaR not present in, 525
 skin reflex lost in, 496
 progressive muscular atrophy, 525
 spasm, 493
Myopia, 567
Myosis, 566, 567
Myositis ossificans, a cause of rigid thorax, 91
 cyanosis with, 44
Myotonia congenita, 532
 increased mechanical excitability in, 526
Myotonic reaction, described, 524
 in Thomsen's disease, 518
- NAILS, in peripheral paralysis, 583**
 Names of diseases, misuse of, 19
Naphthalin, color of urine after taking, 411, 451
Narcotics, disturbance of consciousness in poisoning by, 470
Nasal polypi, cause of neuroses, 575
Naunyn, reference to, 449, 478, 575
Neck and head, points of electrical irritation upon, illustrated, 508
Neck, nerves of, 485
Neelsen, reference to, 187
Negative venous pulse, 263
Neisser, reference to, 427
Nélaton's œsophageal catheter, use of, to wash out stomach, 347
 sound, use of, 302, 355
Nephritis a cause of cardiac hypertrophy, 196
 of dropsy, 53
 acute and chronic, albuminuria with, 435
 casts of albumin in urine of, 424
 hemorrhagic, desquamation of renal epithelium in, 424
 slow pulse with, 237
 amount of diminution of urine indicates severity of, 407
 bacteria in urine of, 427
 casts the infallible sign of, 420
 chloride of sodium in urine diminished, 434
 chronic, cause of paleness, 41
 hæmorrhagica, blood-corpuscles in casts in urine of, 423
 mucus threads in urine of, beside casts, 416
 œdema with, 54
 parenchymatous, pus-corpuscles in urine of, 420
 renal casts in urine of, 422
 epithelium in urine of, 421
 retinitis with, 601
 saliva contains urea in, 289
 sequela of scarlet fever, 22
 sometimes phosphates in urine are diminished in, 435
 sweat in, 38
 tenderness in acute, not chronic, 395
 tracing of pulse of, 247
 turbid urine in, 412
 urea diminished in, 434
Nephrolithiasis, 433
 hæmaturia with, 417
Nerve centres, vasomotor influences from, on pulse in symmetrical vessels, 257
 faradic examination of, described, 512
 lesion of, degenerative atrophy from, 491
 points, 508
 sensibility to pressure in neuritis, 468

- Nerve trunk, examination of, its course must be known, 468
- Nerves and muscles, electrical examination of, 501
- cutaneous, of the lower extremity illustrated, 487
- distribution of sensory cutaneous, 484
- individual peculiarities of, in relation to the skin, 504
- irritation and pain from pressure, section on, 482
- mechanical excitability of, 526
- neuralgia as sequela of inflammation of, 483
- of head, 484, 485
- of lower extremity, 488
- peripheral, and their surroundings, 468
- points of tenderness in, 484
- of stimulation, 508
- shoulder, arm, and hand, 485
- Nervous cough, a dry cough, 166
- during menstruation, 165
- disease of heart, increases strength of heart-sounds, 216
- diseases, diagnostic value of symptoms in, 583
- disturbances of the vegetative system in, 575
- importance of scars from injuries, 52
- local sweating in, 38
- patients, rapid breathing in fever, 94
- system, anatomical diseases of, 586
- anatomy of, 452
- central, injuries to, glycosuria after, 443
- chapter on examination of, 452-587
- convulsions in disease of, 22
- differential diagnosis of functional and anatomical diseases of, 587
- diseases of, diagnosis of, 586
- Nervousness, dizziness with, 471
- subjective sensibility of hearing in, 572
- Neubauer, reference to, 412
- Neukirch, reference to, 121
- Neuralgia, defined, cause of, 483
- glycosuria with, 443
- in head, 483
- intercostal, 101
- Neuralgia, sensitive points in nerves, 468
- simulation of, 19
- tenderness of nerves during, 484
- with diabetes mellitus, 579
- Neuralgic pain in connection with feeling of constriction, 482
- in herpes zoster, 581
- Neurasthenia, cerebral, with vertigo, 472
- headache of, 482
- pain in spine in, 483
- phosphaturia in, 482
- spinalis, 580
- Neuritis, acute degenerative, 493
- acoustic, subjective sensibility of hearing with, 573
- ataxia in diffuse peripheral, 529
- condition of nerve in, 468
- degenerative, 491
- EaR with, 524
- herpes zoster from, 581
- multiple, lessened excitability without EaR in, 525
- partial EaR in, 525
- nerve sensitive to pressure in, 484
- of phrenic nerve, effect on diaphragm, 90
- optica, 652
- from intracranial pressure, 600
- peripheral, cyanosis in, 43
- degenerative atrophy with, 491
- gangrene in, 577
- with diabetes mellitus, 579
- Neuro-fibroma, condition of nerve in, 468
- Neuroma, condition of nerve in, 468
- Neuro-retinitis Brightii, choked disk with, 601
- diabetic, 602
- when occurs, 601
- Neuroses, hypersecretion of stomach in, 357
- increased tendon reflex in, 500
- joint, 583
- local sweating in, 38
- narrowing of field of vision in, 569
- phenomena of pulse in, 577
- pulse in certain, 240
- sometimes inherited, 20
- vomiting in, 358
- Neurosis, slow pulse as a, 238

- Neurotic bronchial spasm, cause of dyspnoea, 94
causes for glycosuria, 443
- Newly-born, urate casts in urine of, 424
urine of, frequently contains albumin, 405
weight of, 35
- Nicotine, headache in poisoning with, 483
neuralgia from poisoning with, 483
poisoning, effect on heart, 201
palpitation of heart in, 577
- Niemeyer, P., reference to, 140
- Night-sweats in phthisis, 38
- Nitrate of silver, deposit of, 49
- Nitric acid test for albumin, 436
- Nitro-benzole, color of blood in poisoning by, 271
poisoning by, odor of bitter almonds in vomit, 366
- Nocturnal enuresis, 400
- Noise of spun-top described, 134, 135
where it occurs, 134
- Noma, description of, 288
- Non-tympanic sound caused by tension, 111
defined, 108
from closed air-cavity, 110
over sternum, 121
transition to tympanic, explained, 112
where occurs, 111, 112
- Noorden, reference to, 404
- Normal boundaries of lungs, 119
electrode, 502, 503, 506, 507, 512, 516
percussion boundaries of lungs, 121
- Nose, blood from, appears as hæmatemesis, 361
disease of, migraine with, 483
examination of, 73
fluids escape by, in paralysis of soft palate, 537
nerve-supply of mucous membrane of, 484
relation of diseases of, to nervous diseases, 575
suppuration of, cause of meningitis and abscess of brain, 467
- Nostrils, how dilated, 536
- Nothhaegel, reference to, 373, 374, 387, 388
- Nourishment, insufficient, a cause of drawing-in of abdomen, 309
- Nuclear paralysis, synonym for bulbar paralysis, 497
- Nursling. Also see Children.
- Nurslings, stomach-digestion in, 344
- Nutrition, disturbance of, cause of ophthalmia neuro-paralytica, 484
disturbed, blood coagulates slower in, 283
how to judge of, 34
of muscles, 488, 489
signs of, 489
variously affected in diseases of the nervous system, 575
- Nylander's reagent, 444
- Nymphomania, 472
- Nystagmus, horizontal and rotatory, defined, 565
- O** abbreviation for opening of current, 506
- Obermeier, reference to, 281
- Obersteiner, reference to, 478
- Oblongata, 455, 461
diseases of, glycosuria in, 443
effect of lesion of, 457
glycosuria in disease of, 579
- Obstipation (constipation), 369
increase of indican in urine in obstinate, 409
large stools after prolonged, 370
- Obturator nerve, illustrated, 487
- Occipital lobe, blood supply of, 462
centre for conception of writing in optic portion of cortex of the, 555
illustrated, 466
lobes, effect on vision of lesion of, 460
nerves illustrated, 485
- Occupation a cause of disease, 21
- Oculomotorius, absence of pupillary reaction of light in paralysis of, 568
inequality of pupils in unilateral paralysis of, 567
muscle, dilatation of pupil in paralysis of, 566
total paralysis of, 565
- Odor from mouth, importance of, 285
of expectoration, 168
of sputum described, 171

- Odor of urine, pathological, 414
 Odors of urine, normal and adventitious, 404
 Œdema, 52
 a result of general venous engorgement, 261
 cause of, explained, 54
 collateral, 54
 deceptive increase of weight, 35
 distinguished from emphysema of skin, 55
 due to ankylostomo-anæmia, 54
 from kidney disease, 440
 nephritis, 54
 in paralysis, 577
 may conceal venous stasis, 262
 near heart, weakens apex-beat, 201
 of chest-wall, cause of deadened sound, 130
 weakened vocal fremitus with, 158
 of engorgement, venous thrombosis with, 268
 of glottis, cause of cyanosis, 43
 of larynx, 594
 of legs, from compression of iliac veins, 314
 of lungs, albumin in sputum in, 190
 bloody sputum with, 170
 crepitant râles with, 154
 dyspnoea in, 95
 serous sputum a peculiarity of, 169
 tympanitic sound with, 111, 130
 showing deep abscess, 54
 slight, disappears between evening and morning, 54
 striæ from, 52
 Œdematous skin in empyema, 86
 Œsophagoscopy, 297
 Œsophagus, anatomy of, 291, 292
 auscultation of, 297
 carcinoma of, producing pressure-paralysis of recurrent nerve, 538
 compression of, 296
 congenital stenosis of, 292, 296
 danger of inducing emesis when it is eroded, 342
 dilatation of, 296
 disease of, a cause of drawing-in of abdomen, 309
 examination of neighborhood of, 291, 296
 Œsophagus, expectoration from, in hysteria, 171
 location of stricture of, 295
 obstruction of, 296
 percussion of, 296
 perforation of, cause of pneumothorax, 210
 pressure upon recurrent nerve from carcinoma of, 255, 599
 recurrent paralysis a symptom of carcinoma of, 600
 rupture of, a cause of emphysema of skin, 56
 sounding of, dangers of, 294
 difficulties of, 294
 method of, 293
 stenosis of, obstipation with, 369
 Oidium albicans, description of, 287
 Old age, anosmia in, 573
 nutrition of skin in, 36
 reaction of pupils to light, slow in, 567
 slow pulse in, 237
 Olfactory nerve, 461
 anosmia with compression of, 573
 Oligocythæmia, diminution of red corpuscles, 273
 hæmoglobin diminished in, 275
 occurs in anæmia, 274
 Oliguria in hysteria, 579
 Omentum, dulness over, from fat, 306
 examination of, 340
 shrinking of, in tuberculosis, 340
 Onanism concealed, 20
 One-sided action of diaphragm, 90
 Open pneumothorax, tympanitic sound, 110, 111, 113
 Ophthalmia, neuro-paralytic, 484
 Ophthalmic artery, 461
 Ophthalmoplegia externa, 566
 Ophthalmoscope, examination with, 600
 Opisthotonus, 496, 532, 534, 539
 defined, 468
 with meningitis and tetanus, 467
 Opium poisoning, Cheyne-Stokes breathing in, 92
 Optic nerve, 551
 absence of pupillary reaction in atrophy of, 568
 atrophy of, after severe hemorrhages, 602
 in diabetes, 602
 in tabes, 562
 course of, 460

- Optic nerve, dilatation of pupil in
atrophy of, 566
illustrated, 460
inequality of pupils in paral-
ysis of the, 567
lesion of, 565
narrowing of field of vision
from atrophy of, 569
primary atrophy of, when
occurs, 601
thalamus, 454
blood supply of, 462
hemichorea with lesion of, 535
- Organic heart murmurs explained, 221
- Orthopnea, 97
diseases in which it occurs, 32
effects of, 33
in heart disease, 197
- Oscillation of the eyeball, 565
- Osler, reference to, 282, 391
- Osmic paræsthesia in hysteria and
insanity, 574
- Osteomyelitis, staphylococcus pyogenes
in, 603
- Ostium venosum, 218
- Ovarian hyperæsthesia, 581
tumor, differential diagnosis from
tumor of kidney, 396
made out after tapping abdo-
men, 318
- Oxalate of lime, concretions of, 433
in sputum, 182
in urine, forms of, described,
429, 430
microscopic appearance of,
430
when it occurs, 430
- Oxaluria defined, 430
- Oxybutyric acid interferes with cir-
cumpolarization for sugar, 447
- Oxygen, deficiency of, a cause of cy-
anosis, 43
diagnostic importance of, 270
effect of deficiency of, on color of
blood, 270
- Oxyhæmoglobin, absorption band of,
271, 272, 273
effect of, upon color of blood, 270
- Oxyuris in vomit, 364
vermicularis, described, 382
found in urine, 425
illustrated, 381
- PAIN**, a cause of rapid breathing,
94
a cause of suppression of cough,
165
- Pain accompanies diseases of the ab-
dominal cavity, 314
after use of sound in œsophagus,
significance of, 294
cold- and heat-, test of, 475
dilatation of pupil with severe,
566
effect of, on reaction of pupils,
567
frequent pulse with severe, 240
from pressure on nerves, 482
in respiration, a cause of dimin-
ished vesicular breathing, 145
in spine, various causes of, 483
in swallowing, significance of, in
diseases of œsophagus, 292
produced by pressure on stomach,
299, 300, 303
produces perspiration, 37
restricting action of diaphragm,
90
sensitivity to, how tested, 476
spontaneous, section on, 482
syncope from, 471
tenderness of spleen, when occurs,
335
thoracic, produced by pressure,
101
with movements of bowels, when
occurs, 370
- Palate, examination of, 284
sense of taste in, 461
soft, electrical irritation of, 510
examination of, 290
innervation of, 537
muscles of, 536
- Pale skin, 39
- Paleness due to diminished hæmoglo-
bin, 40
unilateral, in hysterical hemi-
anæsthesia, 577
various causes of, 40
- Palpation above and below zygoma,
what it shows, 537
in disease of peritoneum, 314
in examining throat, 285
of arteries, 256
of intestine, 308
of kidney, importance of, 395
of liver described, 266
how performed, 323
value of, 332
of mouth, 288
of œsophagus, 292, 293
of peritoneum through vagina,
316
of pharynx, 290

- Palpation of pulse, how performed, 234
 of rectum described, 311
 of spleen, 334
 of stomach, 302
 of thorax, 100
 of veins, 260
 of vocal fremitus described, 156
 respiratory, how performed, 103
 use of, in heart-murmurs, 227
- Palpatory percussion of heart's resistance, 205, 208
- Palpitation in organic disease of heart, 577
 nervous, causes stronger heart-beat, 201
 of heart in mitral defects, 240
- Pancreas, anatomical relation of, 299
 cancer of, a cause of jaundice, 47
 examination of, 340
- Pancreatic juice, deficiency of, 371
- Panizza, reference to, 177
- Papilloma of larynx described, 596
- Para-anæsthesia defined, 479
- Paradoxical contractions defined, 527
- Paræsthesia defined, and when occurs, 482
 osmic, 574
- Paragraphia, 559
 an aphasic symptom, 561
- Parallelism between atrophy and paralysis, 493
- Paralyses, kinds of, in which there is *EaR*, 524
- Paralysis affecting the larynx, 75
 agitans, 530, 531
 and atrophy, parallelism between, 493
 the writing often good, 561
 associated movements in cerebral, spinal, and peripheral, 535
 atonic, characteristic of, 494
 atrophic, 490
 atrophy of inactivity, a result of, 490
 of muscles with, 491
 cerebral, *EaR* not present in, 525
 or spinal, above the anterior horn, characteristic sign of, 494
 contracture of muscles after, 495
 crossed, illustrated, 453
 degenerative atrophic, 492, 518
 determined by extent and location of lesion, 457
 extent of, 489
- Paralysis from pressure, partial *EaR* in, 525
 heart and vessels to be examined when there is, 577
 how produced, 456
 incontinentia alvi with, 370
 increased excitability in cerebral, spinal, and neuritic, 526
 intermitting, general, 525
 of arm, or one side of body, with albuminuria, 441
 of brachial plexus, cause of anæsthesia of the region of median nerve, 487
 of crico-arytenoid muscles, dyspnoea from, 75
 of diaphragm cause of inspiratory dyspnoea, 99
 cyanosis from, 43
 dislocation of heart in, 200
 of dilators of glottis, cause of inspiratory dyspnoea, 99
 of extensors of the trunk, effect of, 539
 of extremities, cause of, 457
 illustrated, 453
 of facial nerve, effects of, 536
 tract, bone reflex present in, 500
 of heart, pulse in, 240
 of intestine in peritonitis, 369
 of laryngeal muscles, dyspnoea from, 93
 of muscles concerned in cough, 165
 of arm, 542
 of eye, significance of, 564
 of head and neck, 539
 of inspiration, effects of, on thorax, 91
 of mastication, tongue, soft palate, and pharynx, 537
 of shoulders, 541
 of speech, 548
 of the lower extremity, 545
 of pharyngeal muscles, effect of, 538
 of phrenic nerve shown by palpation, 103
 of respiratory muscles, cyanosis from, 43
 dyspnoea from, 95
 of soft palate described, 537
 of various muscles of larynx, causes and results of, 598
 of voluntary muscle defined, 488

- Paralysis, peripheral, disturbance of sensation lags behind that of motion in, 485
 nails in, 588
 permanent, illustrated, 522
 phenomena, method of examination, 488
 progressive, imbecility with delusions in, 472
 signs of, 23
 syncope in, 471
 radial, anæsthetic zone with, 479
 rheumatic facial, 491, 520
 section on, 488
 tremors of, distinguished from spasm, 531
 varieties of, determined by location of lesion, 456
 with partial EaR, illustrated, 522
 return of motility, illustrated, 521
- Paralytic dementia, character of the writing of, 561
 thorax described, 84
- Paraphasia, 553, 559
 testing for, 556
- Paraplegia, inferior superior, 457, 489
- Parasites, animal, 21
 in sputum, 182
 in urine, 424
 intestinal, nervous disturbances in children from, 578
 vegetable, 425
 in feces, significance of, 388
- Parasternal lines, defined, 76
- Paresis defined, 488
 of detrusor urinæ, in tabes, 408
 of muscle of eye, 562
 of muscles of speech, 548
 of quadriceps muscle, 546
 symptoms of, 489
 with ataxia in cerebral disease, 529
 with partial epilepsy, 533
- Parietal area of heart changed by dislocation of, 211
 boundaries of organs, 116
 lobes of brain, superior and inferior, blood-supply of, 462
 upper and lower, illustrated, 466
 organs defined, 113
 tumors of chest, feeling of resistance with, 116
- Parosmia in hysteria and insanity, 574
- Parotid gland, inflammation of, 288
- Parturient patients, perspiration of, 38
- Passive mobility of lungs, 125
- Patellar reflex, absence of, name for, 499
 always present in health, 499
 synonyms defined, how tested, 498
- Pathogenic fungi, found in urine, varieties of, 427
 section on, 389
- Pathological odor of urine, 414
 respiratory sounds, 144
 urine, section on, 406-450
- Pathognomonic sign of tricuspid insufficiency, 264
- Patient, position of, during percussion of thorax, 118
- Pectoralis reflex, 499
- Pectoriloquy, Laennec's, described, 159
- Pediculi, marks of, 51
- Pel, reference to, 180
- Peliosis rheumatica defined, 51
- Pelvis, muscles attached to, 545
- Pemphigus, 581
- Penzoldt, reference to, 143, 198, 306, 354, 436, 445, 450
- Penzoldt's test for bile in urine, 442
- Pepsin, relation between, and muriatic acid in the stomach, 344, 345
- Peptone in sputum after crises in pneumonia, 190
 in urine, confounded with albumin, 437
 when occurs, 439
 test for, 353
- Peptones, 343
- Peptonizing of milk in stomach, 344
- Peptonuria distinguished from albuminuria, 435
 when occurs, 439
- Percussion, comparative, 118, 121
 for relative heart-dulness, 207
 depth to which it reaches, 113
 difference between weak and strong, 107
 different results of strong and weak over spleen, 338
 effect of feeble, 114
 foundation of, 106
 general remarks upon, 103

- Percussion, gentle and strong, illustrated, 115
 hammer, 104, 105, 120
 used in plegaphonia, 159
 use of, 116
 in testing mechanical excitability of muscles and nerves, 526
 history and methods of, 104
 light, in pleuritic exudation, 127
 metallic sound with, 112
 note, difference by volume of tissue, 107
 variations of, in individuals, by age, region, and sex, 120
 of abdominal cavity, 316
 of heart, 204
 methods of, 205
 of intestine, 311
 of kidney, 394
 of liver, 326
 mode of, 328
 value of, 332
 of lungs, boundaries upon the back illustrated, 123
 in front illustrated, 122
 of œsophagus, 296
 of spleen, 336
 of thorax described, 118
 over thick covering, representation of, 113
 results of, in aneurism of aorta, 254
 rod-pleximeter described, 135
 strong, of supra-clavicular fossa, 130
 when not to be used, 117
 value of, in locating deeply seated deposits, 116
 three methods of, 105
 topographical, defined, and uses of, 116
 value of, in tumors of kidney, 397
- Pericardial exudation, cause of weakening of heart sound, 219
 conceals apex-beat in dorsal position, 201, 202
 cyanosis from, 43, 44
 exudations, deadened sound over lung compressed by, 127
 friction sound, disappearance of, explained, 231, 232 233
 murmurs, 230
 changes in, in contrast with endocardial, 232
 sounds, felt, 204
- Pericardial splashing, metallic, 233
 Pericarditis adhesiva, a cause of systolic drawing-in, 204
 diastolic collapse of cervical veins in, 267
 divided second sound in, 220
 pulse with, 243
 diagnostic importance of pulse in, 253
 differential diagnosis from pleurisy and peritonitis, 233
 downward displacement of liver in, 322
 escape of fluid into œsophagus, 296
 externa, cause of diminished motility of lungs, 137
 friction sounds with, 156
 exudativa, causes projection of chest-wall, 203
 decreased tension of lung near, 135
 effects on position of liver, 331
 increased area of heart-dulness in, 209
 pulse in, 252
 tympanitic sound near, 130
 weak apex-beat in, 201
 friction sounds with, 231
 position of apex-beat in, 209
 pulse in, 253
 value of pulse in diagnosis of, 253
 of radial pulse in, 202
 venous engorgement from, 261
- Pericardium, diseases of, paleness of symptoms of, 40
 distention of, cause of expansion of chest, 86
 effusion into, 33
 fluid in, increases area of heart-dulness, 209
 tuberculosis of, friction sounds with, 232
- Perichondritis, 594
 laryngea, from deep ulcerations, 596
 of trachea and bronchi, 172
- Perinephritic abscess, cause of pus in urine, 419
- Perinephritis, palpation of, 395
 purulent, diagnosis of, 395
 tenderness with, 395
- Perineuritis, condition of nerve in, 468
 nerve sensitive to pressure in, 484

- Periosteal and fascial reflexes, 499
 reflex, 497
- Periostitis, neuralgia from, 483
 of ribs, pain with, 101
- Peripheral irritation, sensitiveness to, 472
 mixed nerves, origin of, 455
 nerves, disease of, diminished tendon reflex in, 500
 EaR with lesion of, 524
 examination of, 468
 nutrition of, 456
 neuritis, ataxia with, 529
 sight, testing, 569
- Peripleuritis, cause of deadened sound, 130
 effect of, on boundary of liver, 329
- Perisplenitis, cause of apparent enlargement of spleen, 335
 due to stenosis of intestine, 310
- Peristalsis, action of, in digestion, 343
 increased, character of stools with, 372
 effect on character of stools, 368
 of stomach, diminished, 348
- Peristaltic motions of stomach, in hypertrophy and dilatation, 302
- Peritoneal deposits, cause of apparent enlargement of spleen, 335
 effusion, a cause of cyanosis, 45
 alkaline urine with, 413
 exudation, diminished amount of urine with, 407
 fluid, encysted, 315
 friction sound, 233, 318
 sounds over spleen, 339
- Peritoneum, air in, a cause of diminished area of liver dulness, 331
 bands in, found after tapping abdomen, 318
 distention of abdomen in diseases of, 313
 examination of, 312
 fluid in, gives deadened sound, 114
 pain in disease of, interfere with circulation, 44
 rapid breathing in diseases of, 94
 sarcoma and carcinoma of, 315
 tenderness of liver, if involved in carcinoma of liver, 324
 value of percussion over peritoneal cavity, 316
 vomiting in inflammation of, 358
- Peritonitis, acute, pain of severe, 314
 cause of cyanosis, 43
 caution against talking in, 159
 Cheyne-Stokes breathing with, 92
 chronic, diagnostic points of, 315
 little or no pain with, 314
 diaphragmatic, interferes with action of diaphragm, 90
 simulates pleuritis, 161
 dislocation of heart with, 200
 effect on form of thorax, 86
 fecal vomiting in severe, 364
 general, cause of tympanitic sound with, 130
 grass-green bilious vomit in, 361
 indican in urine of, 409
 local, shown by palpation, 103
 meteorism with, 313
 obstipation an early sign of, 369
 pain and tenderness with, 308
 paralysis of diaphragm in, 90
 pulse in, 244, 253
 shrinking of omentum in simple, 340
 staphylococcus pyogenes found in purulent, 603
 subphrenic, defined, 317
 friction sound with, 233
 tenderness of liver with, 324
 time when vomiting occurs in, 359
 tuberculous, surface of liver in, 325
 tympanites with, 309
- Perityphlitis, palpation of abdomen with, 310, 315
- Pernicious anæmia, 41
 case of, with heart complications, 230
 microcytes and macrocytes in, 276
 poikilocytosis not pathognomonic of, 277
 red corpuscles diminished and paler in, 275
 retinal changes in, 602
 size and form of red corpuscles in, 276
- Peroneus nerve, electrical examination of, 511
 illustrated, 487
 -paralysis defined, 546
- Perspiration, 36. Also see Sweat.
 a cause of subnormal temperature, 63

- Perspiration alternates with amount of urine, 37
contains bile in jaundice, 46
insensible, 37
 greater at night, 37
local, 581
office of, 37
relation of, to amount of urine, 401
sudamina after profuse, 50
varieties of, 37
- Perverse sensibility to changes of temperature, 478
- Petechiæ, 49, 51
- Petrosal nerve, superficial, 461
- Pettenkofer's test for bile in urine, 442
- Petters, reference to, 414
- Pflüger, reference to, 189, 505, 506
- Pharyngomycosis leptothricia, description, of, 291
- Pharyngeal muscles, action of, and effect of paralysis of, 538
syphilis, usually with ulceration of larynx, 595
- Pharynx, anæsthesia of, 577
diseased condition of, 290
examination of, 284
expectoration from, in hysteria, 171
inflammation near, cause of cyanosis, 43
irritability of, how overcome, 590
muscles of, 536
reflex of, absence in hysteria and bulbar paralysis, 496
sound from, confusing to beginners, 142
- Phase des grand mouvements, 534
- Phenyl-hydracin test for sugar, 444
- Phimosis, results of, 580
- Phlegmon of larynx, 594
 progressive, streptococcus pyogenes in, 603
- Phlegmonous laryngitis, illustrated, 594
- Phloroglucin-vanillin test for free muriatic acid, 350
- Phonation described, 157
 in paralysis of soft palate, 537
 position of vocal cords during, 592
- Phosphate crystals in urine of cystitis, 419
 of lime illustrated, 430
 in urine, 402
- Phosphates, deposit of, in urine, 402
 in urine, diminished in rhachitis, 435
- Phosphatic calculi, 433
- Phosphaturia defined, 431
 when occurs, 432
- Phosphoric acid, salt of, in urine, 431
- Phosphorus, acute poisoning by, leucine and tyrosin in urine of, 432
 lipuria in poisoning by, 447
 odor of garlic in vomit in poisoning by, 366
 poisoning, a cause of jaundice, 47
 ecchymosis in, 51
 odor of breath in, 285
 peptonuria with, 439
- Phrenic nerve, paralysis of one, shown by palpation, 103
- Phthisical thorax described, 84
 ulcer of larynx, illustrated, 594
- Phthisis, absence of cough in, a bad sign, 165
 accommodation in, 96
 and form of thorax, 81
 asymmetry of breathing in, 91
 chronic, extension of area of heart-sounds in, 217
 cyanosis from severe cough of, 166
 diminished apex of lungs in, 137
 dry cough in beginning of, 166
 friction sound with, 156
 fungi in cavities of, 175
 importance and value of the examination of stomach digestion in, 356
 inspiratory pressure diminished in, 164
 lagging in, 103
 morning cough in, 165
 muco-purulent sputum in, 169
 neuralgia in, 483
 night-sweats of, 37
 orthopnea in, 32
 systolic subclavian murmurs with, 259
 tenderness with, 101
 undefined breathing in beginning of, 149
 vital capacity of lungs in, 164
 vomiting in, 358
- Pick, E., reference to, 357
- Picric acid, color of urine after taking, 411
 effects of, not to be confounded with jaundice, 45

- Picric acid test for albumin, 436
 Pigeon-chest described, 88
 Pilocarpin, effect of, on pupil, 567
 Pio Foà, pneumonia diplococcus of, 188
 Piorry, reference to, 104, 191
 Pitch, as affected by tension of walls, 110
 change of, in pneumothorax with fluid, 136
 over lung cavity, 131
 differences of, 107
 of closed air-containing cavities, how determined, 110
 of lung-sound depends on tension, 112
 of open tympanic sound, 111
 of vesicular breathing, 142
 Plantar nerve illustrated, 487
 Plasmodium malarie, 282
 Plegaphonia defined, 159
 Plethora distinguished from abnormal redness of skin, 41
 Pleura, diseases of, form of thorax in, 81
 rapid breathing in, 94
 with effusion, 33
 exploratory puncture of, 160
 exudation in left, diminishes the half-moon-shaped space, 307
 inflamed, a cause of cough, 165
 serous exudations of, whispered voice with, 159
 shrinking of, cause of displacement of heart, 211
 thick, feeling of resistance with, 116
 thickened, and pleural exudation, how distinguished, 129
 thickening of, deadened resonance with, 129
 diagnosis of, by puncture, 160
 simulates enlarged heart, 209
 tumors of, distinguished from pleuritic exudate, 160
 one-sided expansion of chest in, 86
 weakened vocal fremitus with, 158
 Pleural cough, a dry cough, 166
 effusions, 80
 deadened sound over, 114
 endothelium in exudation, 161
 exudation, effect on boundary of liver, 329
 Pleural exudation, effect of, on circulation through lungs, 44
 encapsulated, 128
 measurement of thorax in, 163
 exudations, a cause of diminished vesicular breathing, 145
 inflammations restricting the action of diaphragm, 90
 sacs, boundaries of, 80
 surface, growths on, conductors of vocal fremitus, 158
 Pleurisy, also *see* Pleuritis, asymmetry of breathing in, 91
 caused by caries of rib, 102
 differential diagnosis from pericarditis and peritonitis, 233
 downward displacement of liver in, 322
 due to fracture of rib, 102
 effect on position of liver whether on right or left side, 331
 effects of, on the chest, 87
 encapsulated, defined, 129
 exploratory puncture in, 162
 exudative, complicating pneumonia, character of bronchial breathing with, 147
 non-tympanic sound with, 112
 first symptom of, 137
 lagging in, 103
 paleness a symptom of, 40
 position in bed in, 32
 shrinking after, diminishes area of spleen dulness, 339
 tubercular, 161
 with exudation, dyspnoea in, 95
 with œdema of chest wall, 54
 Pleuritic effusion, alkaline urine with, 413
 exudation a cause of displacement of heart, 211
 conceals apex-beat, 201
 cyanosis from, 43
 deadened sound over lung compressed by, 127
 deadness and feeling of resistance with, 126
 diminished amount of urine with, 407
 displacement of liver by, 324
 expansion of chest with, 85
 pulse with, 245
 vocal fremitus increased above, 158

- Pleuritic exudation, with compression of lungs, bronchial breathing from, 147
 exudations, ægophony with, 159
 encapsulated, 86
 feeling of resistance with, 116
 with tumors of thorax, 129
 friction-sound, an extra-pericardial, 233
 sometimes heard when there is no inflammation, 155
 -sounds described, 155
 not to be confounded with humming râles, 150
 where most distinctly heard, 155
- Pleuritis, also *see* Pleurisy, adhesive, vital capacity of lungs in, 164
 carcinomatous, 161
 diagnosis by exploratory puncture, 160
 diaphragmatica shown by palpation, 103
 differential diagnosis from pneumonia, puncture in, 160
 exudative, displacement of apex-beat in, 199
 effect on liver-dulness, 330
 fixation of heart in, 200
 inspiratory pressure diminished in, 164
 tympanitic sound with, 111
 weak bronchial breathing with, 147
 pulse in, 253
 purulent, 102
 rupture of fluid into œsophagus, 296
 septic, 161
 sicca, 155
 friction-sound with, 156
 tenderness due to, 101
 with emphysema, friction-sounds with, 156
- Pleximeter defined, 104
 double, of Seitz, 105
 finger used as, in percussing intestine, 312
 hand as, how to be held, 119
 -rod, described, 135
 use in diagnosing venous pulse, 266
 used in plegaphonia, 159
- Pneumatometer, Waldenburg's, 164
 Pneumatometry described, 164
- Pneumonia, absence of cough a bad sign, 165
 acute and chronic, alveolar epithelium in sputum of, 177
 and pleurisy, differential diagnosis when in left chest, 307
 asymmetry of breathing in, 91
 bloody sputum of, 169
 bronchial breathing in, 146
 caused by dust, 21
 chlorides in urine in, 434
 coccus of, 188
 staining of, 188
 course of temperature in, 67
 critical sweat of, 37
 croupous, bloody sputum in, 170
 crepitant râles in, 154
 deadened resonance with, 126
 fever in, 65
 fibrinous tubes in sputum of, 172
 loud bronchial breathing with, 147
 tenderness with, 101
 tough expectoration with, 166
 tympanitic sound in stage of engorgement and resolution, 130
 with, 111
- Curschmann's spirals sometimes in sputum of, 180
 decided increase of urea after crisis of, 434
 deglutition, 600
 differential diagnosis from pleurisy, puncture in, 160
 dyspnœa in, 95
 effect on boundary of liver, 329
 extension of area of heart-sounds in, 217
 fibrinous tubes in sputum of croupous, 172
 friction-sounds with, 155
 hæmato-jaundice in, 47
 herpes facialis with, 50
 increase of urea in, 433
 increased vocal fremitus with, 158
 lobar, extent of deadening corresponds with lobe of lung in, 126
 lobular, thickening and deadening with, 127
 lagging in, 103
 massive, deadness and feeling of resistance with, 116, 126
 non-tympanitic sound from surrounding tissues, 112

- Pneumonia of left lower lobe, diminished half-moon-shaped space, 307
 extension of deadness in, 127
 peptone in sputum of, after crisis, 190
 peptonuria with, 439
 position in bed in, 32
 pulse in, 239
 rapid breathing with, 94
 reactive friction sounds with, 156
 recurrence of, 22
 ringing râles with, 151
 sometimes non-ringing râles with, 153
 spirals in sputum of, 173, 175
 undefined breathing in, 149
 unilateral elevation of temperature in, 71
 ushered in by epileptiform spasm, 533
 vomit in, 358
 with jaundice, bile-pigment in sputum of, 172
- Pneumonic deposits, catarrhal, tympanitic sound over, 130
 noise of spun-top over, 135
 thickening, weak percussion over, 115
- Pneumono-koniosis [disease from inhalation of dust], 155
- Pneumo-pericardium, closed tympanitic sound heard over, 111
 diminished area of heart-dulness with, 210
 metallic heart-sounds in, 221
 sounds over, 112
- Pneumo-thoracic cavity, rod-pleximeter percussion over, 136
- Pneumothorax, circumscribed, 86
 complicated by effusion in pleural cavity, 129
 cyanosis from, 43
 diminished vocal fremitus with, explained, 158
 displacement of the apex-beat in, 199
 downward displacement of liver with, 322, 331
 dyspnœa in, 95
 effect of, on relative liver-dulness, 332
 effect on position of liver, whether on right or left side, 331
- Pneumothorax, effect of, on upper boundary of liver, 330
 expansion of chest in, 85
 hydro-, diagnosis by exploratory puncture, 160
 lung-sound over, 113
 metallic heart-sounds in, 221
 râles with, 153
 sounds over, 112, 135
 non tympanitic sound with, 135
 of right side displaces mediastinum, 137
 one-sided expansion of lung with, 136
 open and closed amphoric breathing with, 148
 bronchial breathing over, 147
 tympanitic sound with, 111, 135
 water-whistling sound with, 153
 plegaphonia over, 159
 position in bed in, 32
 pulse with, 245
 sero- and pyo-, succussion with, 156
 tympanitic sound with, 134
 with fluid, change of pitch in, 136
 with open fistula, noise of spun-top over, 134
- Poikilocytes defined, 277
- Poikilocythæmia, 274
- Poikilocytosis defined, 277
 in leukæmia, 279
 not pathognomonic of pernicious anæmia, 277
- Poikilo-microcythæmia, 275
- Points douloureux, 484
- Points of electrical irritation upon the upper part of the thigh illustrated, 511
- Poisoning a cause of collapse, 40
 acute, disturbance of consciousness in, 470
 albuminuria in acute, 435
 animal, petechiæ, in, 50
 by atropine, red skin in, 41
 by carbonic acid gas, absence of cough in, 165
 weakness of heart-sounds in, 218
 oxide, absorption-bands in blood in, 272
 by copper, 286
 by inhalation, 21
 by lead, 286

- Poisoning, by mercury and lead, cause
 of paleness, 41
 cocci in mouth in, 289
 condition of teeth in, 286
 by nicotine, effect on heart, 201
 by opium or morphine, Cheyne-
 Stokes breathing in, 92
 color of skin in cases of, by va-
 rious substances, 271
 condition of mucous membrane
 of mouth from, 288
 lead, double sound heard over
 crural artery in, 259
 odor of breath in, value of, 285
 with carbonic acid, effect on color
 of blood, 270
- Poisons causing hæmato-jaundice, 47
 corrosive, hemorrhage of stomach
 from action of, 362
 effect of, upon the pupil, 567
 exanthemata from, 50
- Polarizing method for quantitative
 determination of albumin, 438
- Poles of battery, how to distinguish
 quickly, 504
- Polioencephalitis, choreic motions in
 paralyzed limbs, 535
- Poliomyelitis, 491, 493, 580
 acuta, chronica, EaR with, 524
 ushered in by epileptiform
 spasm, 533
 anterior, chronic, 520
 arrest of growth of bone in, 583
 diminished tendon reflex in, 500
- Pollution from phimosis, 580
- Polyæsthesia defined, 478
- Polydipsia, polyuria with, 406
 to make up loss of water, 407
- Polyuria (diabetes insipidus), 579
 in hysteria, 579
 when occurs, 406
- Pons, 454
 anæmic necrosis of, cause of,
 462
 ataxia in lesions of, 529
 blood supply of, 462
 effect of lesion of, 457
 lesion in, effect of, 456
 motor cranial nerves separate in,
 455
- Portal engorgement, hemorrhage of
 stomach in, 362
 vein, enlargement of spleen in
 occlusion of, 335
 obstruction of, a cause of
 ascites, 314
- Portal vein, scars of, effect on consist-
 ence of liver, 326
- Position, dorsal, atelectatic crepitation
 in, 154
 effect of change of, on pericardial
 friction sounds, 232
 of body, effect on pulse in, 235
 in examining kidney, 395
 of patient, 31
 during inspection, 81
 percussion of thorax, 118
 effect on heart-sounds, 220
 upon area of dulness in
 hydropericardium, 209
 in auscultation of heart, 211
 in examining heart, 206
 variations of lung border with
 change of, 125
- Positive venous pulse, systolic, 264
 tracing of, 265
- Posner, reference to, 405
- Posterior cranial fossa, effect of lesion
 of, 457
 cutaneous nerve illustrated, 487
 roots of spinal nerves, 455
- Posture, change of, effect of, on apex-
 beat, 198
 effect of, on area of dulness in
 exudation, 128
 in examining spleen, 336
- Potassium, iodide of, urine after
 taking, 450
 use of, in testing rapidity of
 passage of food from the
 stomach, 354
- Poupart's ligament, 297
- Predisposing causes, effects of, on
 chronic diseases, 21
 of disease, 21
- Pregnancy, double sound heard over
 crural artery in, 259
 scars of, 52
- Pressure, intra-abdominal, upon liver,
 319
 intra-cranial, polyuria and gly-
 cosuria with, 579
 on head and vertebra, pain from,
 484
 partial EaR in paralysis from, 525
 sensation of, 474
 sensibility of cranium to, 466
 -sound over large arteries, 258
 -tone over large arteries, 258
- Presystolic murmur, 228, 251
 murmurs, explained, 226
 normal venous pulse in, 263

- Previous history, what it comprises, 20
 Primary myopathic atrophy, a disease of muscle, 493
 Prior, reference to, 390, 607
 Profession, a cause of disease, 21
 Progressive muscular atrophy, 491, 493
 cyanosis in, 44
 spinal, EaR with, 524
 partial EaR in, 525
 nuclear paralysis, 566
 paralysis, contracted pupil with, 566
 diminution of temperature with, 575
 fever with, 575
 mal perforant, 582
 mydriasis in, 566
 reflex rigidity of pupil not frequent in, 567
 Propeptone, rare in urine, 439
 test for, 353
 Prussic acid poisoning, odor of breath in, 285
 Pseudo-bulbar paralysis, 548
 -crisis of fever, 67
 -hypertrophy, 493
 of muscles, 490
 how recognized, 494
 -leukæmia, 41
 Psoas abscess, pain in inguinal region from, 309
 Psychological condition of patient, 31
 disturbances, 585
 of respiration, 83
 Psycho-motor tract, 452
 Psychoses, acetonuria in, 448
 catalepsy with certain, 536
 increased secretion of saliva in, 577
 Ptomaines, connection between, and cystin, 432
 Ptosis, 563
 Ptyalism, 288
 Puerile breathing described, 142
 Puerperal fever, peptonuria with, 439
 patients, lactose in urine of, 447
 period, a cause of disease, 22
 pyæmia, retinal hemorrhage in, 602
 streptococcus pyogenes in, 603
 Pulmonary artery, aneurism of, 255
 heart-sounds, both strengthened from shrinking of lungs, 218
 hemorrhage described, 170
 Pulmonary insufficiency, 194, 195
 phthisis. *See* Tuberculosis
 semilunar murmur, where heard, 224
 stenosis, 194
 murmur of, where heard, 225
 weakening of pulmonary second sound in, 219
 Pulsating affections, difficult to distinguish from apparent enlargement of heart, 210
 splenic tumor, with aortic insufficiency, 335
 Pulsation, epigastric, 302
 near heart in empyema, 204
 Pulsations at base of heart, 203
 Pulse, absence of, 243
 affected by external temperature, 235
 by position of body, 235
 a measure of the work of left ventricle, 218
 arterial, at the spleen, rare, 257
 auscultation of, 257
 bulbar, jugular sound with, in tricuspid insufficiency, 268
 capillary, 256
 diagnostic value of, 251
 dirotic, tracing of, 247
 different forms of, 242
 double murmur with large and quick, 259
 effect of sleep upon, 235
 of meals upon, 235
 equal, 236
 felt later than heart systole, 204
 filiform trembling, 243
 frequent, when occurs, 238
 hard, not to be confounded with arterial sclerosis, 244
 importance of, in pericarditis, 209
 increased frequency of, in fever, 60
 in crises, 63
 in pyæmia, 69
 intermittent, 236, 241
 irregularity of volume of, 241
 its value in febrile diseases, 253
 method of observing, 235
 negative venous, 267
 of no value in distinguishing systolic and diastolic murmurs, 226
 pathological frequency of, 237
 phenomena of, in neuroses, 577
 quality of, 236, 241
 quickening of, in vomiting, 359

- Pulse, radial examination of, 234
 felt between the time of first
 and second sounds of heart,
 212
 in aneurism of aorta, 254
 value of, in pericarditis, 202
 in showing work of heart,
 202
 relation of, to temperature not
 constant, 61
 rhythm of, 236
 size of, not shown by sphygmo-
 graph, 250
 slow, in jaundice, 47
 then faster, with albuminuria,
 441
 when occurs, 237
 sphygmographic tracing of, ex-
 plained, 246
 symmetry of radial, 245
 tracing of, with temperature, 236
 unequal in symmetrical vessels,
 significance of, 257
 value of, in showing beginning
 complications, 253
 variation of its frequency with
 age, 234
 variations of, affected by sex,
 235
 venous, described, 263
 differential diagnosis of, 266
 want of rhythm of, 241
 wire, 244
- Pulsus alternans, 202, 243
 bigeminus, 241, 243, 252
 tracing of, 250
 celer, 253
 tracing of, 248
 deficient, 241
 dicrotus, 243, 244
 durus, 244
 incidens, 252
 inequalis, tracing of, 250
 intercidens, 243, 244
 intermittens, 241
 magnus, 244
 mollis, 244
 paradoxus, 243, 263
 tardus, 244
 tracing of, 249, 250
 vacuus, 244
- Pulvinar of optic thalamus, effect of
 lesion of, on vision, 460
- Puncture, explorative, use of, 130
 exploratory, of heart, 234
 of liver, 326
- Puncture, variations of pressure dur-
 ing, in subphrenic and pleural
 cavities, 317
- Pupillary reflex, 496
- Pupils always dilated in dyspnœa, 99
 as affected by poisons, 567
 changes of, 566
 contraction of, 568
 during accommodation, diag-
 nostic significance of, 568
 dilatation and contraction of, with
 migraine, 483, 563, 566
 hemianopsic rigidity of, 571
 inequality of, and conditions in
 which it occurs, 567
 reaction of, in hysterical spasms,
 534
 reflex changes in size of, 567
 rigidity of, 567, 587
 size of, affected by degree of illu-
 mination, 566
- Purpura hemorrhagica, 51
- Purulent exudation, examination of,
 161
 in sputum, 167
 sputum described, 169
 odor of, 171
 peptone in, 190
 white blood-corpuscles in, 176
 stools, when occur, 376
- Pus in urine gives a small amount of
 albumin, 435
 makes it turbid, 412
 when occurs, 419
 vomiting of, 364
- Pustule, malignant, 21
- Pyæmia, cutaneous hemorrhage in, 51
 enlargement of spleen in, 335
 hæmato-jaundice in, 47
 herpes with, 50
 intermittent fever in, 69
 pulse in, 239
 rash resembling scarlet fever in,
 50
 retinal hemorrhages in, 602
 staphylococcus pyogenes in, 603
 streptococcus pyogenes in, 603
 sweat in, 37
- Pyelitis calculosa, 398, 433
 stoppage of one ureter by, 400
- Pyelonephritis, hyaline casts, peculiar
 form with, 423
- Pyloric stenosis, 348
 a cause of diminished volume
 of abdomen, 309
 diagnosis of, 303

- Pyric stenosis, effects of, 345, 346
 obstipation with, 369
 Pylorus, demonstration that it does
 not close, 302
 in distention of stomach, 301
 position of, 298, 299
 scars and hypertrophy of, 303
 separation of fluid and solids at,
 343
 Pyonephrosis, lipuria in, 447
 palpation of, 395
 Pyo-pneumocardium, metallic splash-
 ing with, 233
 Pyramidal tract, 452, 454, 455, 456,
 492, 500
 above the oblongata, affec-
 tion of, 548
 injury of, 457
 in the spinal cord, EaR not
 present in lesion of, 525
 lateral, how found, 455
 lessened excitability in, with-
 out EaR, 525
 part in skin reflex, 496
 spasms from irritation of, 530
 tonic spasms in lesion of, 532
 Pyrosis hydrochlorica, 357
 Pyuria, due to strangulus gigas, 425
- QUALITATIVE** excitability of
 nerves and muscles, 516, 518
 Quality of contractions, depends upon
 the relation of the nerve to the
 skiu, 504
 of pulse, 236
 of sound, terms for, 108
 Quantity of expectoration, 168
 Quineke, reference to, 161, 267, 271,
 277, 575
 Quinsy (abscess of tonsil), 290
- RACHITIS**, diminution of phos-
 phates in urine in, 435
 Radial artery, abnormal course of, 242
 nerve, electrical examination of,
 511
 faradic examination of, 512
 illustrated, 486
 muscles supplied by, exami-
 nation of, 515
 paralysis of, from compres-
 sion, 487
 in axilla, 488
- Radial nerve, small cutaneous fila-
 ments to dorsum of fore-
 arm, 485
 pulse, asymmetry of, 245
 diagnostic value of, 251
 simultaneous on two sides,
 236
 sphygmographic tracing of,
 explained, 246
 Railroad neuroses, narrowing of field
 of vision in, 569
 Râles acquire a metallic tone, 148
 bubbling, 154
 crepitant, defined, 154
 sign of capillary bronchitis,
 152
 dry, explained, 149
 elasticity of thorax in children
 cause ringing, 153
 humming, hissing, whistling, so-
 norous, sibilant, 149
 loudness of, explained, 152
 metallic, 150
 moist, explained and when occur,
 151
 not to be confounded with
 friction sounds, 155
 palpation of, 100
 removed by coughing, 149
 ringing, in thickening of lungs,
 152
 sounds are rarely to be felt, 155
 the substances which cause, 165
 toneless, 146
 various sizes, 152
 Reaction of degeneration (EaR), 490,
 491, 492, 493, 518
 complete and partial, 519
 course of, 520
 diagrammatic representation
 of, 520
 diseases which are excluded
 when it is present, 525
 distinct symptoms of, 587
 mixed, 525
 partial, 525
 significance of its absence,
 525
 varieties of, 523
 when occurs, 524
 wanting, 525
 variations of, 403
 of expectoration, 168
 of urine, generally acid, 403
 quality of, with galvanic current,
 505

- Réaumur, thermometric scale, 57
 Records of cases, keeping of, 24
 Recti muscles, intestinal peristalsis seen when they are separated, 310
 Rectum, odor of stool in ulceration of, 372
 pain at stool, in various diseases of, 370
 palpation of, 311
 tumors of, examination for, 311
 Rectus abdominis muscle, dulness over, 328
 Recurrent fever, defined, 70
 enlargement of fever in, 324
 microorganism of, found in blood, 281
 nerve, compression of, 296
 effects of paralysis of, 538
 paralysis of, from pressure, 599
 pressure upon, 255
 paralysis, results of, 598
 what a symptom of, 600
 spirals, 281
 Red blood-corpuscles, alterations in size and form of, 276
 changes in the number and character of, 273
 decomposition of a cause of jaundice, 46
 increase of chloride of sodium in urine from destruction of, 434
 in sputum, 176
 nucleated, 279
 number of in a cubic millimetre of blood, 275
 seldom found in vomit, 365
 size of, 276
 variation in number of, 271
 Redness, local, when physiological, 42
 Reflector, Türck's, for examining the larynx, 589
 Reflex, abdominal, increase of, in intercostal neuralgia, 496
 unilateral absence of, 587
 arc, constituents of, 500
 biceps, 499
 -tendon, 498
 bone, absence of, in bulbar paralysis, 500
 Reflex bone present in paralysis of facial tract, 500
 changes in size of pupils, 567
 choking, absence of, in bulbar paralysis, 496
 cough 165
 cremaster, defined, 495, 496
 fascial, 497, 499
 increased, 496
 manifestations of muscles, 488
 may be absent, 496
 patellar, increased tonus of quadriceps disturbs the, 498
 name for absence of, 499
 synonyms, defined, how tested, 498
 tendon, always present in health, 499
 pectoralis, 499
 periosteal, 497
 pharyngeal, absence of, in hysteria, 497
 and bulbar paralysis, 496
 pupillary, 496
 rigidity of pupils, 567, 587
 skin, defined, how tested, 495
 increased by excitability of anterior horn, 496
 mechanism of, 496
 sole of foot, 495
 spinal centres, 455
 suppression of urine, 408
 from echinococcus, 425
 tendo-Achillis, and foot-phenomenon defined, how tested, significance of, 499
 tendon, 493
 an attendant phenomenon of spasm, 494
 diminished in spinal progressive muscular atrophy, 500
 in tabes dorsalis (very important), 500
 illustration of mechanism of explained, 500
 increase and diminution of, goes parallel with tonus, 500
 of, in cerebral paralysis, 500
 in primary degeneration, 500
 in secondary degeneration, 500

- Reflex tendon**, increase of, in spastic spinal paralysis, 500
 in spinal paralysis from disease of pyramidal tract, 500
 increased in hysteria, 500
 in strychnia poisoning, 500
 in tetanus, 500
 in the phenomenon of paradoxical contractions, 527
 mixture of, and direct muscular irritation, 501
 of upper extremities, 499*
 when diminished or lost, 500
 when increased, 500
- Reflexes**, bone, 500
 cutaneous and tendon, diagram of, 497
 predominant ones in arm and leg, 500
 seat of skin and tendon, 528
 skin, not so important an aid in diagnosis as tendon reflexes, 498
 tendon, aid in diagnosis, 498
 and skin, seat of, 528
 importance of, 497
 section on, 495, 497
- Regional difference of thoracic sounds**, 125
- Relapsing fever**, critical sweat in, 37
 hectic with, 69
 leucocytosis in, 278
- Relative deadness of sound**, 108
 heart-, liver-, spleen-deadness, 327
 liver dulness, 327
 variation in location of, 332
- Relaxed lung tissue**, tympanitic sound with, 112, 130
- Remission of temperature**, 62
- Remittent fever**, 62, 65, 70
 in other febrile diseases, 68
 range of temperature of, 62
 vomiting, an early symptom of, 358
- Remittent typhus fever**, hectic with, 69
- Renal calculi**, 398
 accompanied by chill and fever, 64
 colic, vomiting in, 358
 engorgement, hæmaturia in, 418
 epithelium in urine, forms of, and diagnostic value of, 421
 sand, 433
- Rennet ferment**, 343
- Rennet-zymogen test** for, 353
- Residence**, place of, cause of disease, 21
- Residual urine**, causes of, 408
 not normal, 408
- Resistance**, electrical, as affected by the angle of entrance of the current, 504
 inversely proportional to cross section of electrode, 502
 of skin, important point regarding its increase, 503
 feeling of, 109
 over hepatized lung, 126
 power of, 33
 sensation of, described, 116
- Resonance**, deadened, when developed, 126
- Resorcin**, test for muriatic acid in stomach, 351
 urine after taking, 451
- Respiration**. Also *see* Breathing.
 anomalies of, 89
 change of sound in, 113
 effect of, on apex-beat, 198
 forced, 97
 in dyspnœa, 96
 how palpated, 103
 increased, a cause of dyspnœa, 93
 frequency of, in fever, 60, 94
 in crisis, 63
 in relation to form of thorax, 81
 interference with during an attack of epilepsy, 533
 irregular, 83
 larynx during quiet, 592
 motions of, 81
 normal, 81
 described, 82, 141
 quiet, heart dulness in, 206
 relation of, to amount of urine, 401
 sighing, 92
 symmetrical, 83
 tumors of kidney do not move with, 395
 types of, 83
- Respirations**, number of, 82
- Respiratory apparatus**, disturbances of, in nervous diseases, 575
 centre, 457
 disturbance of, in Cheyne-Stokes breathing, 93
 irritation of, in fever, 94
 displacement of stomach, 303
 motions, effect upon circulation in jugular veins, 262

- Respiratory movements of thorax, pal-
pation of, 100
palpation of, 102
muscles, dyspnoea from paralysis
of, 576
organs, cough as a sign of disease
of, 165
disease of, perspiration in, 37
sound, metallic, 136
sounds, pathological, 144
- Restlessness from uræmia, 440
- Retentio alvi, 370
from paralysis of abdominal
muscles, 578
- Retention of urine, 400, 408, 579
- Retina, electrical reaction of, 571
embolus of the central artery of,
562
- Retinal apoplexy, a forerunner of cere-
bral hemorrhage, 601
arteries, pulsation of, when occur,
602
artery, emboli of the central, a
forerunner of cerebral embolism,
601
- Retinitis in syphilis of the brain, 562
syphilitica, 601
- Retraction of apex of lung in tuber-
culosis of, 127
of lung, increases area of heart
dulness, 209
of lungs, measurement of thorax
in, 163
tympanic sound with, 112
- Retro-peritoneal glands, enlargement
of, 340
confounded with aortic
aneurism, 341
-pharyngeal abscess, 290
a cause of cyanosis, 43
- Reynolds, reference to, 448
- Rhachitis, 464
forms of, 88
how distinguished from hydro-
cephalus, 464
- Rheumatic facial paralysis, 491
disturbance of hearing
with, 572
partial EaR with, 525
paralysis, EaR with, 524
- Rheumatism, articular, recurrence of,
22
chronic articular, phosphaturia
in, 432
pain in spine with, 483
inherited, 20
- Rheumatism, intercostal neuralgia not
to be confounded with, 484
occasionally slow pulse in, 237
of chest-muscles, pain in, 101
of thoracic muscles, rapid breath-
ing in, 94
peptonuria with acute, 439
perspiration of, 38
sequelæ of, 22
simulation of, 19
- Rhonchi, metallic sound with, 136
sibilant, 149
sonorous, 151, 153
- Rhubarb, color of urine after taking,
411, 450
- Rhythm of breathing, anomalies of, 91
of heart-sounds described, 212,
213, 220
of pulse, 236
tracing of, 250
- Ribs, character of in phthisical thorax,
84
deformity of, 82
form of, 81, 82
fracture of, diagnosis of, 102
how counted, 77
in emphysematous thorax, 83
markedly bowed, deadened sound
over, 114
pain in disease of, 101
rapid breathing in fracture of, 94
sharply bowed, causes deadening
of sound over, 126
- Rice-water stools defined, 374
vomit, in Asiatic cholera, de-
scribed, 361
- Richardson, reference to, 246
- Riegel, reference to, 153, 173, 182, 246,
250, 264, 265
- Riess, reference to, 208
- Rigidity of paralysed muscles, 494
- Rigors, in abscess of liver, 326
- Risus sardonius, tonic spasm of face,
532
- Rod-pleximeter percussion, 317
described, 135
metallic sound with, 112
use of, 306
- Rolando, fissure of, illustrated, 466
- Romberg's symptom, 480
- Rosenbach's test for bile in urine,
442
- Roseola, 49
- Round worms, described and symp-
toms of, 380
in vomit, 364

- S** abbreviation for *Schliesung*, closure of current, 506
- Saccharomyces* in diabetic urine, 428
- Sahli, reference to, 230, 269
- Salicylic acid, urine after taking, 450
- Saliva, acidity of stomach, stimulates secretion of, 346
- coloring matter of bile in, 46
- diminished in facial paralysis, 578
- increased secretion of, when occurs, 577
- nerve presiding over secretion of, 484
- various conditions of, 287
- when diminished, 289
- Salivary glands, examination of, 288
- Salivation, description of, 288
- Salkowski, reference to, 172, 181, 434, 445
- Salol, broken up in the intestine, made use of to determine rapidity of passage of food from stomach, 354
- urine after taking, 451
- Salzer, reference to, 125
- Sänger, reference to, 398
- Santonin, color of urine after taking, 411
- effects of, not to be confounded with jaundice, 45
- Santorini, cartilage of, 591, 592
- Sarcina in urine of alkaline fermentation, 428
- pulmonalis, in sputum, 184
- ventriculi described, 366
- in vomit, 365
- Sarcoma of kidney, palpation of, 395
- of larynx, 597
- of lung, deadened sound over, 127
- of peritoneum, 315
- of skull-wall, 465
- Satyriasis, 472
- Scale of Fleischl's hæmometer, 272
- Scanning speech, 548
- Scapula, paralysis of the muscles attached to, 541
- percussion note over, 120
- position of, 82
- Scapular line, 77, 333
- Scarlet fever, 49
- ecchymosis in, 51
- enlargement of spleen in, 334
- epileptiform convulsions in the beginning of, 533
- Scarlet fever, glycosuria in, 443
- hæmoglobin in urine, 411
- mulberry tongue in, 287
- recurrence of, 22
- red skin of, 41
- sequelæ of, 22
- slow pulse in nephritis of, 237
- value of pulse in showing complications of, 253
- vomiting in, 358
- Scars, 52
- in larynx, causes of, 596
- on tongue due to syphilis, 288
- Scherwald, reference to, 159, 434
- Schizomyces in mouth, 289
- in vomit, 365
- pathogenic, section on, 389
- the only microorganism found in blood, 280
- Schleroderma, on thorax, effects of, 91
- Schreiber, reference to, 346, 357
- Schulte, reference to, 524, 525, 582
- Scintillations with migraine, 483
- Sclerosis, multiple, allochiria in, 478
- vertigo in, 472
- of arteries, cause of hypertrophy of heart, 196
- Scoliosis, 467
- described, 88
- from paralysis of erector trunci, 539
- Scorbutus, cocci in mouth in, 289
- condition of teeth in, 286
- cutaneous hemorrhages in, 51
- hæmaturia in, 417
- peptonuria with, 439
- Scotoma, central, in alcohol and tobacco amblyopia, 569
- Serofula, caries of petrous bone in, 572
- chronic catarrh a sign of, 74
- nutrition poor in, 575
- Scrofulosis indication of tuberculosis, 22
- scars of, 52
- Scybala, diagnosis of, 310
- Sebatic acid, odor of, in vomit, 366
- of stool in infantile diarrhœa, 371
- Secretion of gastric juice, threefold importance of knowledge of, 342
- Sediment, kinds of, in urine, and significance of, 402
- Sediments in urine, in inflammation of urinary tract, 419
- urinary, of organic bodies, 416

- Seelegmüller, reference to, 485, 496
 Seitz, reference to, 105, 148
 Self-consciousness during attack of spasm, 530
 Semen, involuntary discharge of, in attacks of epilepsy, 534
 Semilunar valves cause diastolic sound, 213
 Senator, reference to, 177, 405
 Senile dementia, mixed aphasia and amnesia in, 555
 Senna, color of urine after taking, 411, 450
 Sensation of movements defined, 474
 Sense of heat and cold, how tested, 475
 of pressure, 474
 of space defined, how tested, 474
 of touch, how tested, 473
 Senses, organs of, 561
 special, centres and tracts of, 460
 Sensibility, deep, 459, 473
 part in coördination, 528
 part taken by, in recognizing the form of bodies, 481
 section on, 479
 disturbances of, section on, 472
 local manifestations of disturbed, 478
 of skin, 473
 use of, in recognizing form of bodies, 481
 superficial, part of, in coördination, 528
 to changes of temperature prevented, 478
 to pain, how tested, 576
 increase of, 478
 tract of, 459
 Sensitiveness of vertebral column to pressure, 467
 Sensory aphasia, 552
 condition of the hearing must be determined in, 573
 cutaneous nerves, distribution of, 484
 tract, blood-supply of, 462
 section on, 459
 Sepsis, enlargement of spleen in, 335
 rash resembling scarlet fever in, 50
 retinal hemorrhage in, 562
 Septic hemorrhage of kidney, hæmaturia with, 417
 Sequeche, 22
 Serous sputum, a peculiarity of œdema of the lungs, 169
 Serous sputum described, 169
 Sex, variations of pulse from, 235
 Sexual diseases concealed, 19
 Seyler, reference to, 190
 Shaking spasm, 531
 Shattuck, reference to, 282
 Shoemaker's breast, cause of, 89
 Shoulder, nerves of, 485
 Shrinking of one side, 86
 Sibillant râles, 149
 Sibson's furrow defined, 76
 Sieveking's æsthesiometer, use of, 474
 Sighing respiration, 92
 Sight, place of, in faculty of writing, 550
 tract of, 460
 Silver, nitrate of, deposit of, 49
 Simon, reference to, 398
 Simulation of disease, 19
 Singultus, defined, 540
 Sinus of peritoneal cavity, position of, 299
 phrenico-costalis, 80
 Situs inversus viscerum, 193
 position of liver, 331
 Size of body, relation to lung capacity, 164
 of communicating opening, effect upon pitch of sound, 109
 Skeleton, deformity of, effect on chest, 88
 Skin, appearance of, over the abdomen when latter is distended, 313
 bronze, 48
 color of, 38
 as affected by state of blood, 271
 characteristic in some diseases, 41
 cutaneous hemorrhages in, in jaundice, 57
 deep disturbance of nutrition of, in diabetes mellitus, 579
 diagnostic value of its appearance, 49
 disturbance of, section on nervous relation of, 581
 effect of thickness of, on conductive resistance of, 512
 emphysema of, 55
 weakens apex-beat, 201
 examination of, 39
 glassy, 581
 hemorrhages of, 51
 in cases of poisoning, 271

- Skin inspection of, with reference to
 condition of blood, 270
 nutrition of, 36
 œdema of, in perinephritis, 395
 œdematous, in empyema, 86
 of face, dropsy of kidney disease
 first in, 440
 pale, 39
 redness of, 41
 reflex, defined, how tested, 495
 increased by excitability of
 anterior horn, 496
 mechanism of, 496
 seat of, 528
 reflexes, not so important aid in
 diagnosis as tendon reflexes,
 498
 sensibility in, part in coördina-
 tion, 459, 527
 use of, in recognizing the form
 of bodies, 481
 state of, during a chill, 62
 various conditions of, 36
- Skoda, fundamental sentences from,
 109
 reference to, 104, 138, 152, 191, 199
- Skull, asymmetry of, form of, 455
 examination of, 463
- Sleep, effect of, on pulse, 235
 paralysis, 543
- Smallpox, 49. Also *see* Variola.
 cutaneous hemorrhage in, 51
 enlargement of spleen in, 335
 infectious in utero, 20
 larynx in, 75
 leucin and tyrosin in urine of, 432
 scars of, 52
 vomiting in, 358
- Smegma bacillus, 400
- Smell, section on sense of, 461
 testing the sense of, 573
- Smothered sound, 108
- Snellen's plates for testing vision, 568
- Sodium, chloride of, in urine, 434
- Softening of pons or oblongata, effect
 of, 457
- Sole of the foot, reflex of, how elicited,
 495
- Sommerbrodt, reference to, 246
- Somnolence defined, 470
 from uræmia, 440
- Sopor defined, 470
- Sound, abnormally loud and deep per-
 cussion, where occurs, 135
 Biermer's change of, described,
 136
- Sound, conditions that determine the
 quality of, 109
 dissimilarity of, on right and left
 sides of chest, 121
 Friedreich's change of respira-
 tory, defined, 113
 described, 133
 individual differences of, 120
 metallic, defined, 112
 moist cracked-pot, 135
 normal, over lungs, trachea, and
 larynx, 119
 of falling drops, 153
 qualities of, terms for, 108
 rectal, use of, 311
 regional differences of, 120
 Williams's tracheal change of, 121
 Wintrich's change of described,
 111
 explained, and when oc-
 curs, 138
- Sounds, centre for conception of, 557
 intellectual perception of, 552
 qualities of, explained, 106
- Space, conception of, test for, 481
 complementary, 192
- Spasm, active, of paralyzed muscles,
 494
 of muscles of speech, 548
 of thoracic muscles, dyspnœa
 from, 95
 sensation of, of muscles, 479
 defined, 480
- Spasms. Also *see* Convulsions.
 defined, 530
 from intestinal parasites, 578
 hysterical, 587
 voluntary muscles, 530
- Spastic paralysis, 492
 contracture after, 495
 pseudo-paralysis, 494
 spinal paralysis, flexion of foot
 with, 535
 increase of tendon reflex
 in, 500
- Special senses, centres and tracts of,
 460
- Specific gravity of urine, diagnostic
 value of, 413
 how measured, 403
 if high, sugar probably
 present, 443
 in disease, 412
 relation of color to, 408
- Spectroscopic examination of blood,
 270

- Spectroscopic examination, value of, 271
 urine, for methæmoglobin, 442
- Spectrum analysis, quantitative for determining amount of hæmoglobin in blood, 272
- Speech, an acquired faculty, 549
 -centre, motor, interruption of, 558
 location of, 555
 difficulty of in bilateral paralysis of the soft palate, 538
 disturbances of, 548, 549
 how acquired, 549
 in paralysis of soft palate, 537
 place of hearing in, 550
 right hemisphere has nothing to do with, 555
- Spheno palatine ganglion, 461
 supplies the soft palate, 537
- Spermatic nerves, illustrated, 487
- Spermatorrhœa, 421
- Spermatozoa, in urine, diagnostic value of, 421
- Sphincter vesicæ, spasm of, due to echinococcus, 425
- Sphygmograph, pathological forms of pulse shown by, 247
 tracing of radial pulse explained, 246
- Sphygmomanometer, use of, 245
- Spinal column, curvature of, effects of, 87
 diminished mobility of, 467
 section on, 467
 sensitiveness to pressure, 467
- cord, cervical, diminution of temperature in injuries of, 575
 injury to, fever with, 575
 difficulty of local examination of, 463
 disease of, feeling of constriction about thorax in, 482
 diseases of, diagnosis of, 586
 EaR not present in paralysis from lesion of pyramidal tract in, 525
 incontinencia alvi in disease of, 370
 increased irritability of, increased tendon reflex with, 500
- Spinal cord, lessened excitability in, without EaR, 525
 lumbar, residual urine in diseases of, 408
 lympho-sarcoma of, hemialbumose in, 439
 relation of, to spinal column described, 468
 spasm from irritation of the anterior horns of, 530
 curvature, 82
 irritation, pain in spine with, 483
 tenderness of vertebræ with, 467
 paralysis, above the anterior horn, characteristic sign of, 494
 from disease of pyramidal tract, increase of tendon reflex in, 500
 spastic, dorsal flexion of foot with, 535
 progressive muscular atrophy, diminished tendon reflex in, 500
 fibrillary contractions with, 532
- Spine, pain in, various causes of, 483
- Spinning-top, noise of, 128
- Spirals, Charcot-Leyden's crystals upon and in, 182
 Curschmann's, illustrated, 178
 described, 179
 Finkler-Prior's, 390, 607
 in sputum of croupous pneumonia, 173
 of pneumonia, 175
- Spirillum recurrens in hemorrhage of kidney, 427
- Spirochæta in mouth, 188, 289
- Spirometer, Hutchinson's, 164
- Spirometry described, 163
- Splashings in intestine, 312
- Spleen, adjacent to fundus of stomach, 299
 anatomy of, 332
 arterial pulse at, rare, 257
 auscultation of, 339
 boundaries of, 336
 consistence of, 335
 -deadness illustrated, 304, 337
 diseases in which it is enlarged, 334
 -dulness, enlargement of, difficulties in determining, 339
 enlarged, causes projection of left hypochondrium, 334
 enlargement of, diagnosis of, 339

- Spleen, enlargement of, due to venous engorgement, 260
 effect of, on form of chest, 86
 from venous engorgement, 261
 makes the half-moon-shaped space smaller, 306
 examination of, 332
 form and surface of, 335
 infarction of, cause of enlargement, 335
 inspection of, 334
 -kidney angle, 393
 leucocytosis in inflammation of, 270
 location of illustrated, 321
 -lung angle, 338
 defined, 333
 measuring the, 337
 mobility of, 335
 palpation of, 334
 pathological relations of, 338
 percussion of, 336
 portion that is parietal, 333
 position of, 79
 illustrated, 333
 relation to colon, 336
 to diaphragm, 332
 to lung, 333
 size of, in various diseases, 335
 tenderness of, diseases in which it occurs, 335
 topography of, 332
 tumor of, 306
 not diagnosticated from percussion alone, 338
 wandering, described, 336
 differential diagnosis of, 397
 when it can be felt, 334
- Splenic anæmia, enlargement of spleen in, 335
- Sponge, hot, use of, in testing sensibility of spinal column, 468
- Sputum, character of, with reference to certain brain diseases, 576.
 chemical examination of, 190
 crystals in, 174
 defined, 167
 fibrinous tubes in, 172
 importance of examining by naked eye, 171 note
 in three layers, fetid, described, 174
 microscopical examination of, 175
- Sputum, muco-purulent, crystals in, 181
 odor of, described, 171
 spirals in, 174
 substances visible in, by naked eye, 171
- Stadelmann, reference to, 443, 449
- Staphylococcus pyogenes, 602
 cultures of, 603
- Starch corpuscles in sputum, 180
 grains, in vomit, 365
- Starches, changed into erythro- and achroö-dextrin, 353
 interference with digestion of, 344
- Stenosis, auscultatory sounds of, 297
 of air-passage, inspiratory pressure diminished in, 164
 labored respiration in, 93
 of aorta, murmur of, when heard, 224
 pulse in, 240, 252, 255
 slow pulse with, 237
 of intestine, indicated by band-like, flat scybala, 371
 obstipation in, 369
 peristalsis to be seen with, 310
 tympanites with, 309
 of larynx, described, 75
 voice in, 74
 of left auriculo-ventricular opening, dyspnœa in, 96
 of œsophagus, 292
 of trachea, 97, 98
 of upper air-passages, cause of diminished vesicular breathing, 145
 diminished frequency of respiration in, 91
 of valves and effects of, 194
 weaken the sounds of, 219
- Stereognosis, defined, and test for, 481
- Sterility, 21
 due to syphilis, 21
- Sternal lines defined, 76
- Sternum, acts as a thick pleximeter, 121
 and ribs in emphysema, 83
 character of percussion-sound over, 123, 124
 heart-sounds heard over, 214
 non-tympanitic sound over, 121
- Stethography defined, 164
 of thorax, 162
- Stethoscope, double murmur from pressure with, 259
 in examining heart, 220

- Stethoscope, mode, use, and kinds of, 139
 use of, in auscultation of heart, 211
 of pulse, 257
 of veins, 268
 in cardiac murmurs, 232
 with venous humming, 269
 value of, in auscultating over spleen, 340
 when to be used, 140
- Stiff-neck, 539
- Stigmata hystériques, 534, 587
- Stimulation, points of, 508
- Stintzing, normal electrode by, 502
 reference to, 354, 502, 503, 512, 516, 517, 518, 523
- Stöhrer, reference to, 476, 503
- Stokes, reference to, 92, 142
- Stolnikow, reference to, 190
- Stomach, abscess of, circumscribed pain with, 314
 acute catarrh of, paleness in, 40
 alkaline urine with dilatation of, 413
 amyloid degeneration of mucous membrane of, 356
 anatomy of, 297
 atrophy of mucous membrane of, 356
 passage of oil into intestine in, 354
 auscultation of, 307
 blood from, in expectoration, 167
 boundary illustrated, 304
 cancer of, peptonuria with, 439
 catarrh of, absorption from, 354
 superacidity with, 357
 vomit in, 360, 361
 closed tympanitic sound heard over, 111
 coating of tongue in diseases of, 287
 decomposition of contents of, 356
 digestion described at length, 342
 duration of, 344
 how studied, 341
 mode of examining, 347
 pathological disturbance of, 344
 prolonged, 345
 value of results of examination of, 355
 dilatation of, 348
 absorptive power in, 355
 causes of, 345
- Stomach dilatation, indicated by sarcina and torulæ in vomit, 365
 infrequency of the attacks of vomiting in, 359
 symptoms of, with displacement of right kidney, 396
 with fermentation of contents, seething sound over, 208
 diseases of, in which there is diminished or absence of free muriatic acid, 356
 distensibility of, 300
 disturbance of, with migraine, 483
 examination of, 297
 extent to which it is parietal, 299
 fasting, value of examination of, 355
 great amount of vomit in dilatation of, 360
 -heart space, 306
 hemorrhage of, 40, 170
 acid reaction of blood in, 170
 distinguished from that from lungs, 362
 hour-glass, 302
 hypersecretion in ulcer of, 357
 hypertrophy of muscular coat of, 345
 inflated, metallic heart-sounds with, 221
 inflation for diagnosis, 300
 inspection and palpation of, 299
 mode of, 299
 -liver space, circular, 306
 -lung sound, when heard over, 113
 space, circular, tympanitic sound over, 306
 metallic sound over, 112
 method of examining fasting, 355
 movements of, part in digestion, 353
 normal cannot be defined through abdominal wall, 300
 percussion of, 304
 perforating ulcer of, stool of, 372
 cause of pneumothorax, 210
 position of, 78
 if dilated, 305
 illustrated, 319
 of lower border of, illustrated, 327
 of, when moderately full, 305

- Stomach-pump, use of, in washing out the stomach, 348
 purposes for which it is to be emptied, 357
 rapidity of passage of food from, tests for, 354
 resonance in region of heart dullness, 206
 rinsing out, in studying contents of, 341
 section of, examination of contents of, 341
 significance of acid secretion of, 357
 sudden amaurosis after severe hemorrhage of, 602
 superacidity with ulcer of, 357
 symptomatology of dilatation of, 346
 tests of absorptive power of, 354
 ulcer of, hemorrhage from, 362
 vertigo in diseases of, 472
 vomiting in diseases of, 358
 washing out of, 347, 357
- Stomatitis, cause of enlargement of tongue, 286
- Stone in pelvis of kidney, tenderness with, 395
- Stool, acholic, color of, 373
 odor of, 371
 bilious, described, 373
 bloody, described, 374
 color, constituents, and admixture of, 372
 fatty, described, 374
- Stools, consistence and form of, 371
 involuntary discharge of, 579
 in attacks of epilepsy, 534
 odor of, 371
 purulent, when occur, 376
 reaction of, 372
 watery, when occur, 374
- Strabismus, defined, 562
 lateral, divergent, convergent, defined, 563
- Strangling, from irritability of larynx, 590
- Strangury, causes of, 400
- Strength, rapid decline of, 587
- Streptococci, in purulent pleural exudation, 161
- Streptococcus erysipelatosus, described, 603
 in urine, 399
 pyogenes, 161
 description of, 603
- Striæ, 52
 from ascites, 313
 on abdomen, cause of, 314
- Stricture of œsophagus, location of, 295
- Stridor laryngeus vel trachealis, 97
- Strongylus gigas, cause of pyuria and hæmaturia, 425
- Structure of body, 33
- Struma, blowing murmurs over lymphatic glands in, 259
- Strümpell, reference to, 67, 178, 249, 250, 440, 466, 478, 535, 554
- Strychnia poisoning, increased tendon reflex in, 500
- Stupor defined, 470
- Subacidity in dilated stomach, 346
 of stomach, effect of, 344, 348, 356
- Subjective sensibility, 472
- Subphrenic abscess, downward displacement of liver from, 322, 330
 peritonitis, diagnosis of, 317
- Succession, Hippocratic, described, 156
 pathognomonic of hydro-pneumothorax, 156
- Sudamina, 50
- Sugar, determination of, by circum-polarization, 447
 in urine, 443
 qualitative test for, 444
 quantitative test for, 445
 often in urine of health, 405
 uric acid in urine hinders examination for, 405
- Sulphuric acid in urine, 435
- Superacidity. Also see Hyperacidity.
 of stomach, 348
 contents, when it occurs, 351
 diseases in which it occurs, 357
 effect of, 344
 free muriatic acid with, 346
 signs of, 356
- Supersecretion. Also see Hypersecretion.
 of gastric juice, what diseases it occurs with, 357
- Suppression of urine, due to venous engorgement, 260
 reflex, of urine, 408
- Suppuration, cause of paleness, 41
 of ear and nose, cause of meningitis and abscess of brain, 467

- Supraclavicular depression deepened from contraction of apex of lung, 87
 percussion of, 118, 130
- Supraorbital nerve, illustrated, 485
- Suprascapular nerve, illustrated, 486
- Supratrochlear nerve, illustrated, 485
- Swallowing, difficulty of, in bilateral paralysis of soft palate, 538
 difficulty of, in paralysis, 537
 pain in, 75
- Sweat. Also see Perspiration.
 accompanies remission of fever, 62
 alterations of, 38
 cold, with dyspnoea, 99
 critical, in recurrent typhus, 70
 diminished, 38
- Sweating, accompanies vomiting, 359
 cause of diminution of urine, 407
 effect of, on color and amount of urine, 402
 local, 38
- Syllable-stumbling, 553
- Sylvius, embolus of the fossa of, 562
 fissure of, artery of, 462
 fossa of, illustrated, 466
- Sympathetic paralysis, inequality of pupils in, 567
- Sympathetica spastica, unilateral vasomotor disturbances in, 577
- Symphysis pubis, significance of dulness above, 316
- Symptom, Romberg's, 480
- Symptomatic, migraine may be, 483
 neuralgia, 483
- Symptomatology of diseases of nervous system, section on, 463
 value of, 20
- Symptoms, concealment of, 19
 direct and indirect, in nervous diseases, 585
- Syncope defined, significance of, 471
- Syphilis, affecting larynx, 75
 liver, 324
 change in shape of liver from scars of, 325
 changes in fundus oculi with, 601
 chronic catarrh, a sign of, 74
 cicatrices of, dyspnoea from, 93
 concealed, 19
 congenital, Hutchinson's teeth a sign of, 286
 constitutional, paleness in, 41
 cracks in lips of children, a sign of hereditary, 285
 deformed nose from, 73
- Syphilis, diagnosis of, when brain and spinal cord are affected, 586
 glands of neck enlarged in, 291
 hæmoglobin in urine of, 411
 hereditary, early signs of, 22
 infectious in utero, 20
 inherited, 29
 irregular enlargement of liver with, 322
 may be a cause of catarrh of larynx, 593
 middle ear catarrh in, 572
 mucous patches in mouth in, 288
 nervous diseases from, 581
 neuralgia from poison of, 483
 nocturnal headache with, 482
 nose affected in, 576
 primary and secondary outbreaks of, 22
 scars of, 52
 on tongue from, 288
 sterility caused by, 21
 subcordal laryngitis from, 593
 tonsils in, 290
 ulceration of larynx with, 595
- Syphilitic formations of tongue, 286
 gummata on liver, 326
 on skull, 465
 infiltration and ulceration of larynx, 592
 difficulty of diagnosis of, 595
 iritis, 562
 scars in larynx, 596
- Syringo-myelitis of cervical cord, 582
 trophic disturbance of bone in, 583
- Systole of heart, collapse of veins with, 264
 movement of blood in, 193
 sound with, 212
- Systolic drawing-in, 267
 near apex of heart, 202, 204, 220
 heart-sound, what due to and where heard best, 213, 214
 murmur, 252
 at apex, 251
 heard with aortic stenosis, 258
 over pulmonary artery, when, 255
 with atheroma of aorta, 254
 murmurs, 222, 225
 how distinguished from diastolic, 226

- Systolic, positive venous pulse is, 264
 sound in health over large arteries, 257
 subclavian murmur described and explained, 259
 trembling and pulsation in epigastrium, 204
 true venous pulse, rare in facial veins, 267
 venous pulse, 266
 with mitral insufficiency, 267
 vesicular breathing, 143
- T** abbreviation for tetanic contraction.
- Tabes, allochiria in, 478
 arthropathia in, 583
 atrophy of optic nerve in, 601
 bladder crises (painful tenesmus) in, 580
 disturbance in, 580
 brittleness of bones in, 583
 cystitis with, 579
 decline of genital function in, 580
 dorsalis, ataxia the most important symptom of, 529
 atrophy of optic nerve in, 562
 contracted pupil with, 566
 diminished tendon reflex (very important), 500
 mydriasis in, 566
 feeling of constriction about thorax in, 482
 gastric crises with, 578
 herpes zoster with, 581
 hypersecretion of stomach in, 357
 inequality of the pupils in, 567
 intestinal crises with, 578
 laryngeal spasm with, 576
 laxness of muscles in, 494
 location of, 484
 mal perforant in, 582
 migraine in, 483
 neuralgia in initial stage of, 483
 pain in spine with, 483
 polyuria and glucosuria in, 579
 residual urine with, 408
 tenderness of vertebræ in, 467
 vomiting in, 361
- Tables of comparison of the two sides of the body, with faradic and galvanic current, 517
- Tænia cucumerina, described and illustrated, 380
- Tænia mediocanellata described, 378
 illustrated, 379
 solium, cysticerci in brain from, 578
 described, 377
 eggs of, described, 378
 parts of, illustrated, 378
 poikilocytosis in, 277
- Talma, reference to, 151
- Taste, mode of testing the sense of, 574
 sense of, location of, 461
- Teale, reference to, 62
- Teeth and gums, examination of, 285
 caries of, in diabetes mellitus, 285
 condition of, in poisoning by mercury, lead, copper, 286
 in scorbutus, 286
 diseased, a cause of dyspepsia, 286
 disturbances which accompany eruption of, 286
 Hutchinson's sign of congenital syphilis, 286
- Temperament, effect upon pulse, 235
- Temperature. Also *see* Fever
 an index of severity of disease, 61
 chart, value of pulse record on, 253
 course of, 62
 daily variations of, 60
 dangerous to life, 61
 diagnostic value of, section on, 64
 diminution of, when occurs, 575
 effect of, on perspiration, 36
 exacerbation of, 62
 complication shown by, 65, 67
 fall of, collapse with, 70
 sign of collapse, 67
 frequency of taking, 59
 highest observed, 62
 local, 71
 lowering of, 71
 normal, variations of, 59
 relation to pulse not constant, 61
 remission of, 62
 section on, 57
 subnormal, section on, 63
 table of, 61
 taking of, methods, 58
 tracing of, with pulse, 236
 unilateral elevation of in hysteria, 71
 variations of pulse due to external, 235
- Temporal artery, pulsation in, 256
 convolutions, second and third, blood supply of, 462
 lobe, 461

- Temporal lobe, illustrated, 466
- Tenderness of intestine, kinds of, and diseases with, 308
 of liver, when manifest, 324
 of nerve during neuralgia, 484
 of region of kidney, when occurs, 395
- Tendo-Achillis reflex and foot phenomenon defined, how tested, significance of, 499
- Tendon reflex, 493
 an attendant phenomenon of spasms, 494
 increase and diminution of, goes parallel with tonus, 500
 increased in the phenomenon of paradoxical contractions, 527
 in partial epilepsy, 533
 mechanism of, illustration explained, 500
 mixture of, and direct muscular irritation, 501
 of upper extremities, 499
 seat of, 528
 when increased, 500
 reflexes, aid in diagnosis, 498
 importance of, 497
 section on, 497
 when diminished or lost, 500
- Tenesmus at stool, 370
 of bladder, cause of, 400
- Tension diminished, gives deep non-tympanitic sound, 112
 of lung tissue diminished, 135
 effect on pitch, 112
 of wall of closed air cavity, effect on pitch of sound, 110
 of walls, effect upon change of pitch of sound, 111
- Terminal arteries, defined, 462
- Test papers, Geisler's albumin, 436
- Testing the sensibility to irritation, 473
- Tetanus, cyanosis in, 44
 dyspnoea in, 95
 fever with, 575
 galvanic, 505
 increased excitability in, 526
 tendon reflex in, 500
 opisthotonus with, 468
 tonic and clonic spasm of thoracic muscles in, 540
 spasms in, 532
- Thallin, urine after taking, 451
- Thermæ-thesiometer, use of, 475
 Nothnagel's, described, 475
- Thermometer, selection of, 58
- Thermometers, scales of, 57
- Thermometric scales, comparison of, 61
- Thigh, points of electrical irritation of, illustrated, 511
 -sound, 109
 associated with feeling of strong resistance, 116
 defined, 106
 term used for dull, 108
 when heard, 113
- Third nerve, paralysis of, 566
- Thirst, in febrile diseases, 287
- Thoma-Zeiss's apparatus for counting blood corpuscles, 274
- Thompson, reference to, 286
- Thomson's disease, 493
 myotonic reaction in, 518
- Thoracic breathing aided by auxiliary muscles, 99
 conditions that abolish it, 91
 replaced by diaphragmatic, 90
 diseases, position in bed in, 32
 duct, compression of, a cause of chylous ascites, 318
 organs and deformities of chest, 81
 pain produced by pressure, 101
 viscera, position of, 78, 79
- Thorax, anatomical prominences of, 76
 circumference of, increased in inspiration, 163
 where measured, 162
 covering of, effect of, on heart-sounds, 216
 cross-section of, 163
 deformity of, a cause of dislocation of heart, 199
 larger parietal area of heart, 200
 effect of elasticity of, on heart-sounds, 216
 emphysematous, 85
 examination of, in connection with disease of œsophagus, 296
 flexibility of, 83
 flexible projection of, in diseases of the heart, 203
 form of, 81
 important, 33
 frequent measurements of, value of, 163
 inspection of, 81
 inspiratory enlargement of, 83
 length of, 163

- Thorax**, local expansions of, 86
 measurement of, 162
 one-sided extension of, 85
 palpation of, 100
 paralytic, described, 84, 85
 pathological forms of, 83
 percussion of, described, 118
 phthisical, often absent in phthisis, 85
 right side measures more than left, 163
 rigid, causes of, 91
 diaphragmatic breathing with, 91
 prevents projection in enlargement of liver, 321
 short, position of apex-beat in, 198
 tympanic resonance in region of heart-dulness in, 206
 sound on percussing, 109
 tumors of, measurement of thorax in, 163
 value of pulse in deformity of, 253
 repeated measurement of, in aneurism of aorta, 254
 wall of, dulling effect on heart-sounds, 217
 yielding, in children, 98
- Throat and neck**, muscles of, 538
- Thrombosis**, effect upon pulse in one of two symmetrical vessels, 257
 local low temperature in, 71
 of large veins of lower extremities, 268
 of veins a cause of cyanosis, 45
 renders deep veins accessible, 260
 venous, effects of, 262
 when and where it occurs, 268
- Thrombus**, closure of venous trunk by, 261
- Thrush**, description of, 287
 in children, spores in feces, 388
 microscopic appearances of, 290
 stenosis of œsophagus from, 296
- Tinnitus aurium**, sometimes a precursor of migraine, apoplexy, or epilepsy, 573
 with migraine, 483
- Tobacco amblyopia**, 602
 central scotoma in, 569
 use of, effect on disease, 21
- Toes**, paralysis of muscles of, 547
- Toluyldiamin**, poisoning by, causing hæmato-jaundice, 47
- Tone**, as applied to heart-sounds, 212
 of heart-sounds, variations of, 216
 pitch of, how effected, 109
- Tongue and soft palate**, electrical irritation of, 510
 coating of, 287
 color of, 287
 dryness of, 287
 enlargement of, 286
 examination and conditions of, 286
 in typhoid fever, 287
 motor centre for, 454
 muscles of, 536
 that move it, and effect of their paralysis, 537
 nerve-supply of anterior two-thirds of, 484
 normal mobility of, in hysterical dumbness, 548
 not bitten in hysterical spasms, 534
 often bitten during attack of epilepsy, 533
 sense of taste in, 461
 anterior two-thirds from the chorda, and posterior one-third from glosso-pharyngeus, 574
 taste in the anterior portion of, affected in paralysis of facial nerve, 461
 trembling of, in alcoholism, fevers, and typhus, 287
 wounds of, 287
- Tonic spasms**, 530
 when occur, 532
- Tonus of muscles**, 488, 496, 528
 disturbance of, 489
 method of testing when only slightly increased, 501
 of paralyzed muscles increased, 494
 of quadriceps, increased, disturbs patellar reflex, 498
- Tonsils**, condition of, in tonsillitis, syphilis, diphtheria, etc., 290
 crystals in sputum from inflamed, 181
 offensive plugs from lacunæ of, 171, 174
- Tooth-mucus bacillus**, like comma bacillus, 391
- Topographical percussion** defined, and uses of, 116
 relation between surface of brain and skull, illustrated, 466
- Topography of abdomen**, 297

- Torula cerevisiæ*, in fever, 388
 in vomit, 365
 with normal digestion, 366
- Touch, sense of, how tested, 473
- Toxic headache, causes of, 483
 influences, neuralgia from, 483
 paralyses, EaR with, 524
- Trachea, casts of, in sputum of croup, 172
 change of sound in, 130
 distance of bifurcation of, from incisor teeth, 291
 epithelium in sputum from, 176
 mucous râles in, 165
 normal sound over, 119
 open tympanic sound, when it is percussed, 110
 sensitiveness of, a cause of cough, 165
 stenosis of, 97
 inspiratory drawing-in of chest wall in, 98
 tympanic sound over, 121, 130
 ulceration of, a cause of emphysema of skin, 56
- Tracheal change of sound explained, 132
 sequestra of, in sputum, 172
 tone, Williams's, described, 111, 131
- Transfusion of blood, hæmoglobin in urine after, 411
- Transition breathing, 148, 149
 corresponds to hinted râles, 153
- Transparency of expectoration, 168
- Transudation, diagnosis of, from exudation, 160
- Transudations, effect of absorption of, on reaction of urine, 413
 increase of chloride of sodium in urine with, 434
- Trapezius muscle, paralysis of, effect of, 541
- Traube, reference to, 104, 151, 179, 259, 306, 440
- Traumatic hemorrhages, 51
 hysteria, narrowing of field of vision in, 569
 paralysis, EaR in, 525
- Traumatism, exposure of nerves to, 468
- Treatment, value of pulse in, showing result of, 253
- Trembling (tremor), 530
- Tremor, graphic representation of, 531
- Tremor, mercurialis, 531
 saturninus, 531
 senilis, 531
 with hysteria, 531
- Trichina spiralis* described, 383
 importance of, 383
 illustrated, 384
- Trichinæ in stools, 383
 in vomit, 364
- Trichinosis, 383
 cyanosis with, 44
- Trichomonas vaginalis*, found in urine, 425
- Tricocephalus dispar*, described and illustrated, 383
- Tricuspid insufficiency, 194, 195
 case of relative, referred to, 266
 double sound with, over crural vein, 268
 murmur of, where heard, 225
 positive venous pulse pathognomonic of, 264
 relative, pulmonary second sound in, 218
 venous murmur with, 268
 murmur, where heard, 224
 stenosis, 194
 venous engorgement from, 261
 valve, causes a systolic sound, 213, 214
- Trigeminus nerve, 461
 anosmia due to paralysis of, 574
 sense of taste in anterior portion of tongue affected in disease of, 461
- Triple-phosphates, deposit of, in urine, 402
 illustrated, 430
 in sputum, 182
 in urine described, 431
- Trismus, masseter spasm in, 532
- Trommer's test for sugar, 444
 used in estimating amount of sugar, 446
- Tropæolin-paper, use of, in testing for free muriatic acid, 350
- Trophic influences of the cortical centres, 456
- Trunk, muscles of, and effect of their paralysis, 539
 nerves of, 485
- Tubercle bacilli, illustration of, 184
 in sputum in tuberculosis of larynx, 595

- Tubercle bacilli**, mode of examination, 185
 only present with disintegration, 161
 staining of, 186, 187
- bacillus**, cultures of, described, 605
 in blood, rare, 281
 in feces, presence explained, 391
 in pleural exudation, 161
 in sputum, 175
 in urine, illustrated, 426
 sign of tuberculosis of urinary passages, 426
- Tubercular cachexia**, 41
 deposits, small tympanitic sound over, 130
 peritonitis, 315
 enlargement of spleen in, 335
 surface of liver in, 325
 • tenderness of the liver with, 324
 ulceration, result of infiltration in larynx, 595
- Tuberculosis**, 82. Also see Phthisis
 acute miliary, of lung and pleura, friction sounds with, 155
 pulse in, 239
 affections of ear with, 572
 cachexia of oxaluria with, 430
 catarrh of larynx in tuberculosis of lungs, 593
 Charcot-Leyden's crystals in sputum of, 182
 choroidal, 562, 601
 chronic, Curschmann's spirals in sputum of, 180
 remittent fever of, 68
 color of face in, 42
 crystals of cholesterin in sputum of, 181
 deepening of clavicular depression in, 87
 diagnosis of, by aid of microscope, 291
 disposition to, with narrow chest, 34
 dyspnoea in, 95
 effect on weight, 36
 elastic threads in the sputum of, 177
 fever in, 65
 fibrin in urine in, 439
 forms of fat found in feces in, 386
- Tuberculosis in apices of lungs**, with cavities, 131
 indicated by scrofulosis, 22
 infections *in utero*, 21
 inherited, 20
 intestinal, feces contain Charcot's crystals, 388
 infusoria found in stools of, 384
 tenderness with, 308
 miliary, petechiæ in, 50
 of apex of lung, increased vascular breathing in, 144
 prolonged expiration in, 145
 of apices, pain with, 102
 of larynx, 75
 of lungs, 22
 disturbance of the circulation through them, 44
 night-sweats of, 38
 shown by tubercle bacillus, 187
 of lymphatic glands, effect on absorption of fats, 371
 of pericardium, friction sounds with, 232
 of peritoneum, little or no pain with, 314
 of pleura, a cause of tenderness, 101
 of tonsil, 290
 of urinary apparatus, 398, 426
 shreds of tissue in urine of, 421
 passages, 400
 pulmonary hemorrhage in, 170
 red border upon gum in, 286
 shrinking of omentum in, 340
 thrush with, 288
 tracing of pulse of, 248
 tympanitic sound over apices of lungs in beginning of, 112
 ulceration of larynx with, 595
 weight of body in, 35
 with paralytic thorax, 85
- Tuberculous and syphilitic laryngitis**, differential diagnosis of, 593
 infiltration and ulceration of larynx, 592
- Tumor of kidney**, tenderness with, 395
 of liver or spleen, 306
 of lungs, peculiar sputum of, 171
- Tumors, abdominal**, effect on form of thorax, 86
 tympanitic sound near, 130
 cause of venous stasis, 262

- Tumors, cause of inspiratory dyspnoea,** 99
 cerebral, slow pulse with, 237
 conceal apex-beat, 201
 glandular, cause of pressure on nerves, 469
 in chest cavity, dyspnoea from, 95
 in lungs, weak percussion over, 115
 intestinal, percussion of, 312
 intra-tracheal, dyspnoea with, 93
 neuralgia from pressure of, 483
 of brain, disturbance of consciousness with, 471
 sensibility of cranium to pressure with, 466
 of chest cavity, bronchial breathing from, 146
 diagnosis of, by puncture, 160
 wall, cause of deadened sound, 130
 pulse in, 253
 of intestine, diagnosis of, 310
 kinds of, 310
 of kidney, described, 394
 diagnosis of, 397
 value of percussion with, 397
 of pleura, one-sided expansion of chest in, 86
 of stomach, dullness over, 306
 and spleen, respiratory motion of, 322
 pulsation with, 302
 of thorax, irregular boundary of, 129
 measurement of thorax in, 163
 of tongue, a cause of enlargement, 286
 of transverse and descending colon easily confounded with those of spleen or kidney, 311
 of vertebrae, tenderness of, 467
 of wall of stomach, 300
 near stomach not felt, 303
 pressure of, a cause of jaundice, 46
- Turbinated bones, enlargement of, a cause of neuroses,** 575
- Türk, reference to,** 594
- Türk's reflector,** 589
- Turpentine, odor of urine after taking,** 414
- Tympanites, effect of, upon extent of abdomen,** 309
- Tympanitic deadened sound,** 131
 resonance in region of heart-dullness, 206
 near an infiltrated lung, 126
 near heart, when, 210
 open or closed, over lung cavities, 131
 over lung containing scattered deposits, 127
 with high tension of lung-tissue, 135
 sound further defined, 109
 intensity of, 109
 just above large exudation, 128
 musical pitch of, 109
 occurs with lack of tension of lung-tissue, 110
 on right side of chest over stomach or colon, 121
 over apices in beginning tuberculosis, 112
 diseased lungs, causes of, 130
 larynx and trachea, 121
 where heard, 109
 with pneumothorax, 154
 with retracted lung, 111, 112
 sounds, 107
- Typhlitis described,** 315
 recurrence of, 22
 tenderness in iliac fossa with, 308
- Typhoid fever, *vel* Typhus abdominalis**
 abscess of abdominal muscle in, 309
 of muscles in, 54
 bacillus of, cultures of, 605
 described and illustrated, 391, 605
 found in blood in, 281
 staining of, 605
 consciousness, disturbance of, in, 470
 cough, absence of, 165
 feces of, contain Charcot's crystals, 388
 glucosuria in, 443
 hæmoglobin in urine of, 411
 headache in, 483
 hemorrhage in, shown by temperature, 65
 subcutaneous in, 51
 ileo-cæcal cooing in, 312
 infusoria in stools of, 384

- Typhoid fever**, intestinal hemorrhage in, 375
 tenderness in, 308
 leucin and tyrosin in urine of, 432
 leucocytosis in, 278
 mental condition in, 32
 paralytic chest from, 85
 peptonuria in, 439
 posture in, 32
 pulse in, 238, 239
 tracing of, 247
 rash of, resembling scarlet fever, 50
 recurrence of, 50
 roseola in, 49
 spleen, enlargement of, in, 334
 spermatozoa in urine in, 421
 staphylococcus pyogenes in the suppuration which accompanies, 603
 stools thin in, 371
 sweat in remittent stage of, 38
 temperature, course of, 65
 variation of, in, 66
 tongue, state of, in, 287
 tympanitis in, 309
 ulceration of the larynx in, 595
- Typhus abdominalis.** *See* Typhoid Fever
 fever, cutaneous hemorrhages with, 51
 eruption of, 49
 typical course of fever in, 65
- Tyrosin**, form of, in urine, 432
 in sputum, 182
 in urine, illustrated, 431
 when occurs, 432
- UFFELMANN'S** test for lactic acid, 351
- Ulcer of stomach**, blood in stool from, 375
 hemorrhage from, 362
 pain in, 303
 superacidity with, 357
 supersecretion of stomach with, 357
- Ulceration of larynx**, seldom with catarrh, 595
- Ulceration of larynx**, voice in, 74
 of trachea and bronchi, 172
- Ulcerations**, deep, of skull wall, 465
 internal, a cause of emphysema of skin, 56
- Ulnar nerve** illustrated, 486
 distribution to hand, 545
 electrical examination of, 511
 position of the hand in paralysis of, 544
 neuritis from fracture of internal condyle of humerus, case of, 469
- Ultzmann**, reference to, 429
- Umbilical region**, illustrated, 298
- Unconsciousness**, catheter always to be used to draw the urine, 401
 faradic test of, 476
 involuntary discharge of urine during, 579
- Undefined breathing** explained, 148
- Unequal pulse** in symmetrical vessels, significance of, 257
 respiration, 92
- Ungar**, reference to, 182
- Unilateral convulsions** in partial epilepsy, 533
 skin reflex, 495
- Unverricht**, reference to, 153, 154
- Upper extremities**, tendon reflex of, 499
- Uræmia**, ammoniacal odor of vomit in, 366
 Cheyne Stokes breathing in, 92
 coma from, 440, 470
 defined, 440
 dyspnœa in, 576
 epileptiform spasms in, 533
 headache with, 483
 slight amount of vomit with, 360
 symptoms of, 440
 urea diminished in, 434
 vomiting in, 358
- Uræmic amaurosis**, 601
- Urate of ammonia**, form of, in urine, 432
 illustrated, 430
 in urine, 402
 of soda and lime, described, 429
- Urates**, precipitation of, by albumin test-papers, 437
- Urea**, amount of, in twenty-four hours, 405
 cannot be determined from specific gravity of urine, 412
 increase of, 433

- Urea in saliva in nephritis, 289
 method of determining amount of, 434
 quantitative determination of, value of, 413, 434
- Ureter, obstruction in, a cause of diminished secretion of urine, 407
 one, stopped up in tuberculosis, 400
- Ureters, examination of, 398
- Urethra, diminished amount of urine from stricture of, 408
- Uric acid as a urinary sediment described, 423
 concretions of, 433
 crystals of, illustrated, 429
 diathesis, increase of uric acid in, 434
 found in blood in gout, 283
 hinders examination for sugar, 405
 salts, separation of, from cooled urine, 402
 source of, in urine, 405
 when increased, 434
- Uridrosis defined, 38
- Urinary apparatus, chapter on examination of, 392
 disturbances of, section on, 579
 examination of, what it comprises, 392
 calculi, cause of, 429
 casts, most important element in pathological urine, 421, 422
 constituents in solution, 433
 anomalies in amount of, 433
 diseases, sweat in, 38
 passages, deep-seated inflammation of, fibrin in urine of, 439
 products in fever, 408, 416, 422, 423
 sediments, 404
 examination of, 415
 of organic bodies, 416
- Urination, assisted by abdominal pressure, 540
 frequent causes of, 400
- Urine, acidity of, how determined, 414
 affected by medicines, 450
 always to be drawn with catheter when there is unconsciousness, 401
 amphoteric reaction of, 404
 anomalies in amount of, 406
 causes of diminution of (anuria), 407
- Urine, clear, to be tested for sugar if specific gravity is high, 443
 color and transparency of, in disease, 401, 408
 complete diminution of (anuria), 407
 concentrated, appearance of, 402
 effects of, 400
 concretions in, 433
 contains bile in jaundice, 46
 contamination of, how to avoid, 399
 daily average amount of, 401
 determining amount of nitrogenous material in, value of, 434
 diminution of, in fever, 60, 407
 discoloration of, causes of, 410
 examination of, section on, 399
 fermentation of, effect of, on its appearance and character, 402
 increase in pigments of, 409
 in uro-genital tuberculosis, 426
 involuntarily discharged in attacks of epilepsy, 534
 involuntary discharge of, when occurs, 579, 580
 mode of procedure in examining, 400
 normal, section on, 401
 odor of, 404
 due to medicines, 414
 pathological odor of, 415
 section on, 406-450
 reaction of, generally acid, 403
 in disease, 413
 retention and incontinence of, 400
 rule for approximation of solid constituents from specific gravity, 412
 secretion of, less at night, 401
 soluble constituents of, named and described, 404
 specific gravity of, how measured, 403
 when diminished, 413
 staining of, from medicines, 411
 suppression of, causes of, 407
 due to venous engorgement, 260, 261
 table of colors of, useless, 408
 turbidness of, when passed is pathological, and when occurs, 411
- Urobilin, coloring pigment in urine, 402, 409
 -icterus, 48, 409

- Urobilin, tests for, 410
 origin of, 48
- Urobilinuria, 46
- Urometer, requisites of, 403
- Uterus, diseases *in utero*, 20, 21
- Uvæ ursi, color of urine after taking, 411
- Uvula, position of, in paralysis of soft palate, 537
- V**AGI, compression of, 599
- Vagina, taking temperature in, 58
- Vaginal mucus in urine, 416
- Vagus centre, 457
 slow pulse in irritation of, 237
 irritation of, by bronchial tumors, 576
 nerve, weakness of heart-sounds in paralysis of, 218
 paralysis of, pulse in, 240
 quick pulse in, 577
- Valleix's points of tenderness, 101, 484
- Valve, insufficiency of, effect of, 194
 stenosis of, effect of, 194
- Valves of heart, part taken by, in the heart-sounds, 213
 where best auscultated, 213, 214
- Valvular defects revealed by murmurs, explanation of, 221
 deficiency a cause of cyanosis, 44
 compensation for, 195
 disease of heart, hæmaturia with, 417, 418
 enlargement of liver with, 324
 incompenation in, a cause of diminished amount of urine, 407
 value of pulse in, 252
 insufficiency and its effects, 193
 relative, murmurs with, 230
 sound in jugular vein, 265
- Varicella, 49
- Variola. Also *see* Smallpox.
 ulceration of larynx with, 595
- Vasomotor centre, pulse in irritation of, 245
 disturbances, when occur, 577
 influences upon pulse in symmetrical vessels, 257
- Vegetable parasites in urine, 425
- Vegetative system, disturbance of, in nervous diseases, section on, 575
- Vein, portal, enlargement of spleen in occlusion of, 335
- Veins, auscultation of, 268
 examination of, 260
 of abdomen, enlarged with ascites, 314
 of skin enlarged in aneurism of aorta, 254
 phenomena of circulation in, 267
- Vena cava inferior, pressure upon by enlarged retro-peritoneal glands, 341
- Veneral excesses, cause of disease, 21
- Venous engorgement, effect on color of the blood, 270
 effects of, 260
 enlargement of spleen with, 335
 of tongue, 286
 humming explained, 269
 louder on right side, 269
 synonyms for, 269
 when occurs, 269
- liver pulse, 266
 with enlarged liver, 322
- pulse described, 263
 double positive, in hemisystole, 267
 positive, tracing of, 265
 progressive, in aortic insufficiency, 267
 in veins of hand and back of foot, 268
 tracing of, 264
- stasis a cause of jaundice, 47
 a cause of œdema, 54
 ecchymosis from, 51
- thrombosis, when and where occurs, 268
- Ventricle, contraction of, causes a systolic heart-sound, 213
 hypertrophy of, shown by strengthened sound of corresponding valve, 217
 left, hypertrophy and dilatation of, shown by displacement of apex, 200
- Vermiform appendix, 317
 inflammation of, Cheyne-Stokes breathing in, 92
 tenderness in disease of, 308
 usually no tumors with inflammation of, 316

- Vertebrae, spines of, sensitive to pressure, 467
- Vertebral artery, 461
column, section on, 467
- Vertigo, also *see* Dizziness
defined, and when occurs, 472
from the eye, 563
- Vesicular breathing described, 142
diminished, causes of, 145
origin of, 142
pathological changes of, 144
special peculiarities of, 143
- Vicarious action of centripetal influences in coördination, 528
of diaphragm in defective thoracic breathing, 540
of kidney, 408
participation of neighboring nerves, 485
of nerve, 479
- Vidian nerve, 461
- Vierordt, C., reference to, 275
- Vierordt, H., reference to, 35, 217, 283
- Vierordt, K., reference to, 246, 272
- Vierordt, O., reference to, 154, 180
- Virchow, reference to, 177
- Vision, concentric limitation of, 587
of the field of in gross hysteria, 534
narrowing of field of, 569
disturbance of, from choked disc, amount of, 600, 601
disturbances of, in diseases of the nervous system, 562
in uræmia, 440
subjective sensations of, 571
testing field of, 568, 569
for central sharpness of, 568
- Visual amnesia, 552,
- Vocal cords, position of, during phonation, 592
in paralysis, 599
fremitus, aid in determining apparent enlargement of heart, 210
aids in diagnosis between pneumonia and pleuritic exudation, 158
increased, when, 158
palpation for, 100
described, 156
technique of, 157
variations of, 157
weakness or suppression of, when occurs, 157
- Vogel, reference to, 408
- Voice, character of, in paralysis of muscles of speech, 548
effect upon, from paralysis of laryngeal muscles, 538
in disease, 74
- Voit, C., reference to, 434
- Volume of air cavity, effect upon pitch of sound, 109
of an extremity, measurement of, 490
of cavity, effect upon change of pitch of sound, 111
if closed, effect on pitch, 110
of muscles, diminution of, 491
- Voluntary motion, 455
muscle, spasms of, 530
- Vomicae, 131. Also *see* Cavities in Lungs.
- Vomit, chemical examination of, 359
coffee-ground, test for hæmin in, 363
color of, 360
comma bacilli in, in cases of cholera Asiatica, 390
microscopical appearance of, 360
examination of, 364
odor of, value of, 366
quantity of, 360
reaction of, in various conditions, 366
section on, 359
watery, watery-mucous, and mucous, significance of, 360
- Vomited material illustrated, 365
- Vomiting, act of, described, 358
central, diseases in which it occurs, 358
due to round-worms, 380
frequency of, 359
from irritability of larynx, 590
from severe coughing, 166
from uræmia, 440
in diseases of abdominal organs other than the stomach, 358
induction of, when contra-indicated, 342
kinds of, clinically distinguished, 358
of use in obtaining contents of stomach, 341
phenomena associated with, 359
reflex, 358
section on, 358
time when it begins, 359
ways in which it occurs, 358

- Vomiting, when it occurs in nervous diseases, 578
- Vomitus matutinus potatorum, 359, 361
amount of vomit in, 360
- W**AGNER, E., reference to, 171
Waldenburg, reference to, 164
- Wandering kidney, 395
diagnosis of, 396
differential diagnosis of, 397
liver, 331
signs of, 324
spleen, 335
described, 336
differential diagnosis of, 397
- Wasting diseases, hæmic murmurs heard in, 229
significance of, 34
- Water-brash of drunkards, 361
-whistling defined, 153
- Waxy casts, a form of hyaline, 423
illustrated, 423
- Weichselbaum, reference to, 427
- Weigert, reference to, 185
- Weight, loss of, a sign of disease, 23
of body, increase and diminution, 34, 35
relation to height, 35
- Weil, Handbook of Topographical Percussion, quoted, 112
-Luschka, quoted, 78, 79
quoted, 113, 122, 123, 125
reference to, 116, 121, 130, 132, 133, 192, 206, 207, 259, 304, 306, 312, 319, 321, 327, 332 (note), 333, 336, 338, 393
- Wernicke, reference to, 552, 553, 555, 556, 558, 601
- Westphal, reference to, 498, 499, 525, 527
- Westphal's view of tendon reflexes, 500
- Whispered voice, auscultation of, 159
- White blood-corpuscles in sputum, 176
increased proportion of, to red, in anæmia, 275
in urine of cystitis, 419
normal proportion of, to red, 278
with hæmatoidin needles, 432
corpuscles, increase of, in leukæmia shown by microscope, 279
- White kidney, large, fatty casts in urine of, 423
dropsy with, 440
form of epithelium in urine of, 421
lipuria in, 447
- Whooping-cough, effect of, on venous circulation, 263
expansion of lungs after, 136
expiratory bulging in, 98
microbe of, 190
phenomena of, described, 166
relation to emphysema, 22
severe cough of, a cause of emphysema of skin, 56
vomiting in, 358
- Will, conscious, participation in co-ordination, 528
- Williams's tracheal tone described, 111, 121, 131, 132
- Willis, circle of, 461
- Wintrich, reference to, 104
- Wintrich's change of sound described, 111, 132, 159
- Woillez's cystometer, 163
- Wolf, reference to, 246
- Women apt to conceal disease, 20
- Word-blindness, testing for, 556
-deafness, 55, 461
defined, 552
testing for, 556
the condition of the hearing must be determined in, 573
- Worms, a cause of epileptiform attacks in children, 533
- Wrisberg, cartilages of, 591
- Writer's cramp, 532, 561
- Writing, an acquired faculty, 549
centre for, 557
diagnostic value of the character of, 561
disturbances of power of, 549
how acquired, 549
- Wunderlich, quoted, 65, 68, 69, 70
Wunderlich's table of temperatures, 61
- X**ANTHIN crystals, 433
- Y**EAST cells in sputum, 190
fungus in urine, important when there is sugar, 428
- Yellow atrophy of liver, acute, diminution of phosphates in urine with, 435

- Yellow atrophy of liver, acute, leucin
and tyrosin in urine
of, 432
acute, urea diminished
in, 434
diminished area of dul-
ness with, 331
fever, hæmato-jaundice in, 47
hemorrhage of stomach in,
362
- Z**EISS' apparatus for polarization,
447
reference to, 175, 274, 281, 447
Zenker, reference to, 179
Ziehl, reference to, 187
Ziemssen, reference to, 164, 302, 508,
593, 594, 596, 598, 599
Zimmerlin, reference to, 524, 525
Zygoma, what palpation above and
below shows, 537
Zygomatic nerve illustrated, 485

STANDARD Medical and Surgical Works

PUBLISHED BY

W. B. Saunders, 925 Walnut Street,
Philadelphia.

MR. SAUNDERS, in presenting to the profession the following list of publications, begs to state that the aim has been to make them worthy of the confidence of medical book-buyers by the high standard of authorship and by the excellence of typography, paper, printing, and binding.

The works indicated in the Index (see next page) with an asterisk (*) are sold by subscription (*not by booksellers*), usually through travelling solicitors, but they can be obtained *direct* from the office of publication (charges of shipment prepaid) by remitting the quoted prices. Full *descriptive circulars* of such works will be sent to any address upon application.

All the other books advertised in this catalogue are commonly for sale by *booksellers* in all parts of the United States; but any book will be sent by the publisher to any address (post-paid) on receipt of the price herein given.

CONTENTS.

	PAGE		PAGE
Anatomy.			
Haynes, Manual of Anatomy	24	Saunders' Pocket Medical Formulary	17
Nancrede, Anatomy and Manual of Dissection	16	Stevens, Manual of Therapeutics	17
Nancrede, Essentials of Anatomy	26	Thornton, Dose-Book and Prescription-Writing	24
Bacteriology.			
Ball, Essentials of Bacteriology	26	*Warren, Surgical Pathology and Therapeutics	11
Frothingham, Laboratory Guide	20	Medical Jurisprudence.	
McFarland, Text-Book of Pathogenic Bacteria	13	Chapman, Medical Jurisprudence and Toxicology	24
Botany.			
Bastin, Laboratory Exercises in Botany	20	Semple, Essentials of Legal Medicine, etc.	26
Chemistry and Physics.			
Brockway, Essentials of Physics	26	Medicine.	
Wolf, Essentials of Chemistry	26	*An American Text-Book of Practice	7
Children.			
*An American Text-Book of Diseases of Children	8	Gould and Pyle, Anomalies and Curiosities of Medicine	27
Griffith, Care of the Baby	21	Lockwood, Manual of the Practice of Medicine	24
Powell, Essentials of Diseases of Children	26	Morris, Essentials of the Practice of Medicine	26
Clinical Charts, Diet, and Diet Lists.			
Hart, Diet in Sickness and in Health	22	Saunders' American Year-Book of Medicine and Surgery	28
Keen, Operation Blank	19	Stevens, Manual of the Practice of Medicine	16
Lainé, Temperature Chart	16	Nervous Diseases and Insanity.	
Meigs, Feeding in Early Infancy	14	Burr, Manual of Nervous Diseases	24
Starr, Diets for Infants and Children	22	Shaw, Essentials of Nervous Diseases and Insanity	26
Thomas, Detachable Diet Lists, etc.	22	Nursing.	
Diagnosis.			
Cohen and Eshner, Essentials of Diagnosis	26	Griffith, Care of the Baby	21
MacDonald, Surgical Diagnosis and Treatment	27	Hampton, Nursing: its Principles and Practice	21
*Vierordt and Stuart, Medical Diagnosis	12	Stoney, Practical Points in Private Nursing	10
Dictionaries.			
*Keating and Hamilton, New Pronouncing Dictionary of Medicine	12	Obstetrics.	
Morten, Nurses' Dictionary of Medical Terms	22	*An American Text-Book of Obstetrics	5
Saunders' Pocket Medical Lexicon	17	Ashton, Essentials of Obstetrics	26
Ear.			
Gleason, Essentials of Diseases of the Ear	26	Boisliniere, Obstetric Accidents	20
Electricity.			
Stewart and Lawrence, Essentials of Medical Electricity	26	Dorland, Manual of Obstetrics	24
Embryology.			
Heisler, Text-Book of Embryology	27	Jewett, Outlines of Obstetrics	18
Eye, Nose, and Throat.			
Corwin, Essentials of the Physical Diagnosis of the Thorax	27	Norris, Syllabus of Obstetrical Lectures	19
*De Schweinitz, Diseases of the Eye	14	Pathology.	
Jackson and Gleason, Essentials of Diseases of Eye, Nose, and Throat	26	Semple, Essentials of Pathology and Morbid Anatomy	26
Kyle, Manual of Diseases of Nose and Throat	24	*Senn, Pathology and Surgical Treatment of Tumors	11
Genito-urinary.			
Hyde, Syphilis and the Venereal Diseases	24	Stengel, Manual of Pathology	24
Martin, Essentials of Minor Surgery, Bandaging, and Venereal Diseases	26	*Warren, Surgical Pathology and Therapeutics	11
Gynecology.			
*An American Text-Book of Gynecology	9	Pharmacy.	
Cragin, Essentials of Gynecology	26	Sayre, Essentials of Pharmacy	26
Garrigues, Diseases of Women	18	Physiology.	
Long, Syllabus of Gynecology	19	*An American Text-Book of Physiology	3
Histology.			
Clarkson, Text-Book of Histology	15	Hare, Essentials of Physiology	26
Life Insurance.			
Keating, How to Examine for Life Insurance	21	Raymond, Manual of Physiology	24
Materia Medica and Therapeutics.			
*An American Text Book of Applied Therapeutics	4	Skiagraphy.	
Butler, Text-Book of Materia Medica, Therapeutics, and Pharmacology	27	Rowland, Archives of Clinical Skiagraphy	15
Cerna, Notes on the Newer Remedies	17	Skin.	
Griffin, Manual of Materia Medica and Therapeutics	24	Pictorial Atlas of Skin Diseases	16
Morris, Essentials of Materia Medica, etc.	26	Stelwagon, Essentials of Diseases of the Skin	26
Urine.			
Miscellaneous.			
*Gross, Autobiography of 13			
Saunders' New Aid Series of Manuals 23, 24			
Saunders' Question Compends 25, 26			
Thrush, Water and Water Supplies 15			

A TEXT-BOOK OF HISTOLOGY, DESCRIPTIVE AND PRACTICAL. For the Use of Students. By ARTHUR CLARKSON, M. B., C. M., Edin., formerly Demonstrator of Physiology in the Owen's College, Manchester; late Demonstrator of Physiology in the Yorkshire College, Leeds. Large 8vo, 554 pages, with 22 engravings in the text, and 174 beautifully colored original illustrations. Price, strongly bound in Cloth, \$6.00 net.

The purpose of the writer in this work has been to furnish the student of Histology, in one volume, with both the descriptive and the practical part of the science. The first two chapters are devoted to the consideration of the general methods of Histology; subsequently, in each chapter, the structure of the tissue or organ is first systematically described, the student is then taken tutorially over the specimens illustrating it, and, finally, an appendix affords a short note of the methods of preparation.

In the descriptive portion of the work the writer has avoided, as much as possible, the discussion of disputed points and contending views of only historical value. In the practical part also the same principle has been followed—only the well-known and well-tried methods are given; and, throughout, the object has been, while placing before the reader all that is necessary for his equipment as an histologist, to avoid withdrawing his mind from the salient facts of the science by the introduction of a number of comparatively unimportant ones, of main interest to the specialist.

ARCHIVES OF CLINICAL SKIAGRAPHY. By SYDNEY ROWLAND, B. A., Camb., late Scholar of Downing College, Cambridge, and Shuter Scholar of St. Bartholomew's Hospital, London; Special Commissioner to "British Medical Journal" for the Investigation of the Applications of the New Photography to Medicine and Surgery. A series of collotype illustrations, with descriptive text, illustrating the applications of the New Photography to Medicine and Surgery. Price, per Part, \$1.00. Parts I. and II. now ready.

The object of this publication is to put on record in permanent form some of the most striking applications of the new photography to the needs of Medicine and Surgery.

The progress of this new art has been so rapid that, although Prof. Röntgen's discovery is only a thing of yesterday, it has already taken its place among the approved and accepted aids to diagnosis.

WATER AND WATER SUPPLIES. By JOHN C. THRESH, D. Sc., M. B., D. P. H., Lecturer on Public Health, King's College, London; Editor of the "Journal of State Medicine," etc. 12mo, 438 pages, illustrated. Handsomely bound in Cloth, with gold side and back stamps. Price, \$2.25 net.

This work will furnish any one interested in public health the information requisite for forming an opinion as to whether any supply or proposed supply is sufficiently wholesome and abundant, and whether the cost can be considered reasonable.

The work does not pretend to be a treatise on Engineering, yet it contains sufficient detail to enable any one who has studied it to consider intelligently any scheme which may be submitted for supplying a community with water.

THE PICTORIAL ATLAS OF SKIN DISEASES AND SYPHILITIC AFFECTIONS (American Edition). Translation from the French. Edited by J. J. PRINGLE, M. B., F. R. C. P., Assistant Physician to, and Physician to the department for Diseases of the Skin at, the Middlesex Hospital, London. Photo-lithochromes from the famous models of dermatological and syphilitic cases in the Museum of the Saint-Louis Hospital, Paris, with explanatory wood-cuts and text. In 12 Parts, at \$3.00 per Part. Parts 1 to 4 now ready.

"The plates are beautifully executed."—JONATHAN HUTCHINSON, M. D. (London Hospital).

"I strongly recommend this Atlas. The plates are exceedingly well executed, and will be of great value to all studying dermatology."—STEPHEN MACKENZIE, M. D. (London Hospital).

"The plates in this Atlas are remarkably accurate and artistic reproductions of *typical* examples of skin disease. The work will be of great value to the practitioner and student."—WILLIAM ANDERSON, M. D. (St. Thomas Hospital).

ESSENTIALS OF ANATOMY AND MANUAL OF PRACTICAL DISSECTION, containing "Hints on Dissection." By CHARLES B. NANCREDE, M. D., Professor of Surgery and Clinical Surgery in the University of Michigan, Ann Arbor; Corresponding Member of the Royal Academy of Medicine, Rome, Italy; late Surgeon Jefferson Medical College, etc. Fourth and revised edition. Post 8vo, over 500 pages, with handsome full-page lithographic plates in colors, and over 200 illustrations. Price: Extra Cloth (or Oilcloth for the dissection-room), \$2.00 net.

No pains nor expense has been spared to make this work the most exhaustive yet concise Student's Manual of Anatomy and Dissection ever published, either in America or in Europe. The colored plates are designed to aid the student in dissecting the muscles, arteries, veins, and nerves. The wood-cuts have all been specially drawn and engraved, and an Appendix added containing 60 illustrations representing the structure of the entire human skeleton, the whole being based on the eleventh edition of Gray's *Anatomy*.

A MANUAL OF PRACTICE OF MEDICINE. By A. A. STEVENS, A. M., M. D., Instructor of Physical Diagnosis in the University of Pennsylvania, and Demonstrator of Pathology in the Woman's Medical College of Philadelphia. Specially intended for students preparing for graduation and hospital examinations. Post 8vo, 512 pages. Illustrated. Price, \$2.50.

FOURTH EDITION, REVISED AND ENLARGED.

Contributions to the science of medicine have poured in so rapidly during the last quarter of a century that it is well-nigh impossible for the student, with the limited time at his disposal, to master elaborate treatises or to cull from them that knowledge which is absolutely essential. From an extended experience in teaching, the author has been enabled, by classification, to group allied symptoms, and by the elimination of theories and redundant explanations to bring within a comparatively small compass a complete outline of the practice of medicine.

TEMPERATURE CHART. Prepared by D. T. LAINÉ, M. D. Size 8 × 13½ inches. Price, per pad of 25 charts, 50 cents net.

A conveniently arranged chart for recording Temperature, with columns for daily amounts of Urinary and Fecal Excretions, Food, Remarks, etc. On the back of each chart is given in full the method of Brand in the treatment of Typhoid Fever.

MANUAL OF MATERIA MEDICA AND THERAPEUTICS. By A. A. STEVENS, A. M., M. D., Instructor of Physical Diagnosis in the University of Pennsylvania, and Demonstrator of Pathology in the Woman's Medical College of Philadelphia. 435 pages. Price, Cloth, \$2.25.

This wholly new volume, which is based on the 1890 edition of the *Pharmacopœia*, comprehends the following sections: Physiological Action of Drugs; Drugs; Remedial Measures other than Drugs; Applied Therapeutics; Incompatibility in Prescriptions; Table of Doses; Index of Drugs; and Index of Diseases; the treatment being elucidated by more than two hundred formulæ.

NOTES ON THE NEWER REMEDIES: their Therapeutic Applications and Modes of Administration. By DAVID CERNA, M.D., PH.D., Demonstrator of and Lecturer on Experimental Therapeutics in the University of Pennsylvania. Post 8vo, 253 pages. Price, \$1.25.

SECOND EDITION, RE-WRITTEN AND GREATLY ENLARGED.

The work takes up in alphabetical order all the newer remedies, giving their physical properties, solubility, therapeutic applications, administration, and chemical formula.

SAUNDERS' POCKET MEDICAL FORMULARY. By WILLIAM M. POWELL, M. D., Attending Physician to the Mercer House for Invalid Women at Atlantic City. Containing 1750 Formulæ, selected from several hundred of the best-known authorities. Forming a handsome and convenient pocket companion of nearly 300 printed pages, with blank leaves for additions; with an Appendix containing Posological Table, Formulæ and Doses for Hypodermic Medication, Poisons and their Antidotes, Diameters of the Female Pelvis and Fœtal Head, Obstetrical Table, Diet List for Various Diseases, Materials and Drugs used in Antiseptic Surgery, Treatment of Asphyxia from Drowning, Surgical Remembrancer, Tables of Incompatibles, Eruptive Fevers, Weights and Measures, etc. Third edition, revised and greatly enlarged. Handsomely bound in morocco, with side index, wallet, and flap. Price, \$1.75 net.

"This little book, that can be conveniently carried in the pocket, contains an immense amount of material. It is very useful, and as the name of the author of each prescription is given is unusually reliable."—*New York Medical Record*.

SAUNDERS' POCKET MEDICAL LEXICON; or, Dictionary of Terms and Words used in Medicine and Surgery. By JOHN M. KEATING, M. D., Editor of "Cyclopædia of Diseases of Children," etc.; Author of the "New Pronouncing Dictionary of Medicine," and HENRY HAMILTON, Author of "A New Translation of Virgil's *Æneid* into English Verse;" Co-Author of a "New Pronouncing Dictionary of Medicine." A new and revised edition. 32mo, 282 pages. Prices: Cloth, 75 cents; Leather Tucks, \$1.00.

"Remarkably accurate in terminology, accentuation, and definition."—*Journal of American Medical Association*.

"Brief, yet complete . . . it contains the very latest nomenclature in even the newest departments of medicine."—*Medical Record*.

DISEASES OF WOMEN. By HENRY J. GARRIGUES, A. M., M. D., Professor of Obstetrics in the New York Post-Graduate Medical School and Hospital; Gynæcologist to St. Mark's Hospital, and to the German Dispensary, etc., New York City. One octavo volume of nearly 700 pages, illustrated by 300 wood-cuts and colored plates. Prices: Cloth, \$4.00 net; Sheep, \$5.00 net.

A PRACTICAL work on gynæcology for the use of students and practitioners, written in a terse and concise manner. The importance of a thorough knowledge of the anatomy of the female pelvic organs has been fully recognized by the author, and considerable space has been devoted to the subject. The chapters on Operations and on Treatment are thoroughly modern, and are based upon the large hospital and private practice of the author. The text is elucidated by a large number of illustrations and colored plates, many of them being original, and forming a complete atlas for studying *embryology* and the *anatomy* of the *female genitalia*, besides exemplifying, whenever needed, morbid conditions, instruments, apparatus, and operations.

EXCERPT OF CONTENTS.

Development of the Female Genitals.—Anatomy of the Female Pelvic Organs.—Physiology.—Puberty.—Menstruation and Ovulation.—Copulation.—Fecundation.—The Climacteric.—Etiology in General.—Examinations in General.—Treatment in General.—Abnormal Menstruation and Metrorrhagia.—Leucorrhœa.—Diseases of the Vulva.—Diseases of the Perineum.—Diseases of the Vagina.—Diseases of the Uterus.—Diseases of the Fallopian Tubes.—Diseases of the Ovaries.—Diseases of the Pelvis.—Sterility.

The reception accorded to this work has been most flattering. In the short period which has elapsed since its issue, it has been adopted and recommended as a text-book by more than 60 of the Medical Schools and Universities of the United States and Canada.

"One of the best text-books for students and practitioners which has been published in the English language; it is condensed, clear, and comprehensive. The profound learning and great clinical experience of the distinguished author find expression in this book in a most attractive and instructive form. Young practitioners, to whom experienced consultants may not be available, will find in this book invaluable counsel and help."

THAD. A. REAMY, M. D., LL.D.,

Professor of Clinical Gynecology, Medical College of Ohio; Gynecologist to the Good Samaritan and to the Cincinnati Hospitals.

OUTLINES OF OBSTETRICS: A Syllabus of Lectures Delivered at Long Island College Hospital. By CHARLES JEWETT, A. M., M. D., Professor of Obstetrics and Pediatrics in the College, and Obstetrician to the Hospital. Edited by HAROLD F. JEWETT, M. D. Post 8vo, 264 pages. Price, \$2.00.

This book treats only of the general facts and principles of obstetrics: these are stated in concise terms and in a systematic and natural order of sequence, theoretical discussion being as far as possible avoided; the subject is thus presented in a form most easily grasped and remembered by the student. Special attention has been devoted to practical questions of diagnosis and treatment, and in general particular prominence is given to facts which the student most needs to know. The condensed form of statement and the orderly arrangement of topics adapt it to the wants of the busy practitioner as a means of refreshing his knowledge of the subject and as a handy manual for daily reference.

SYLLABUS OF OBSTETRICAL LECTURES in the Medical Department, University of Pennsylvania. By RICHARD C. NORRIS, A. M., M. D., Demonstrator of Obstetrics in the University of Pennsylvania. Third edition, thoroughly revised and enlarged. Crown 8vo. Price, Cloth, interleaved for notes, \$2.00 net.

"This work is so far superior to others on the same subject that we take pleasure in calling attention briefly to its excellent features. It covers the subject thoroughly, and will prove invaluable both to the student and the practitioner. The author has introduced a number of valuable hints which would only occur to one who was himself an experienced teacher of obstetrics. The subject-matter is clear, forcible, and modern. We are especially pleased with the portion devoted to the practical duties of the accoucheur, care of the child, etc. The paragraphs on antiseptics are admirable; there is no doubtful tone in the directions given. No details are regarded as unimportant; no minor matters omitted. We venture to say that even the old practitioner will find useful hints in this direction which he cannot afford to despise."—*Medical Record*.

A SYLLABUS OF GYNECOLOGY, arranged in conformity with "An American Text-Book of Gynecology." By J. W. LONG, M. D., Professor of Diseases of Women and Children, Medical College of Virginia, etc. Price, Cloth (interleaved), \$1.00 net.

Based upon the teaching and methods laid down in the larger work, this will not only be useful as a supplementary volume, but to those who do not already possess the Text-Book it will also have an independent value as an aid to the practitioner in gynecological work, and to the student as a guide in the lecture-room, as the subject is presented in a manner systematic, succinct, and practical.

A SYLLABUS OF LECTURES ON THE PRACTICE OF SURGERY, arranged in conformity with "An American Text-Book of Surgery." By NICHOLAS SENN, M. D., PH. D., Professor of Surgery in Rush Medical College, Chicago, and in the Chicago Polyclinic. Price, \$2.00.

This excellent work of its eminent author, himself one of the contributors to "An American Text-Book of Surgery," will prove of exceptional value to the advanced student who has adopted that work as his text-book. It is not only the syllabus of an unrivalled course of surgical practice, but it is also an epitome of, or supplement to the larger work.

AN OPERATION BLANK, with Lists of Instruments, etc. required in Various Operations. Prepared by W. W. KEEN, M. D., LL.D., Professor of Principles of Surgery in the Jefferson Medical College, Philadelphia. Price per pad, containing Blanks for fifty operations, 50 cents net.

SECOND EDITION, REVISED FORM.

A convenient blank (suitable for all operations), giving complete instructions regarding necessary preparation of patient, etc., with a full list of dressings and medicines to be employed. On the back of each blank is a list of instruments used—viz. general instruments, etc., required for all operations; and special instruments for surgery of the brain and spine, mouth and throat, abdomen, rectum, male and female genito-urinary organs, the bones, etc. The whole forming a neat pad, arranged for hanging on the wall of a surgeon's office or in the hospital operating-room.

LABORATORY EXERCISES IN BOTANY. By EDSON S. BASTIN, M. A., Professor of Materia Medica and Botany in the Philadelphia College of Pharmacy. Octavo volume of 536 pages, with 87 plates. Price, Cloth, \$2.50.

This work is intended for the beginner and the advanced student, and it fully covers the structure of flowering plants, roots, ordinary stems, rhizomes, tubers, bulbs, leaves, flowers, fruits, and seeds. Particular attention is given to the gross and microscopical structure of plants, and to those used in medicine. The illustrations fully elucidate the text, and the complete index facilitates reference.

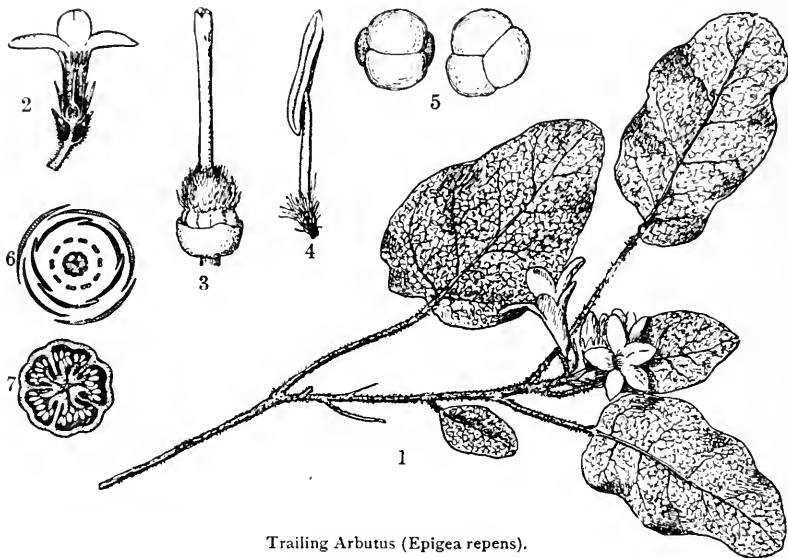

Trailing Arbutus (*Epigaea repens*).
Specimen Illustration.

LABORATORY GUIDE FOR THE BACTERIOLOGIST. By LANGDON FROTHINGHAM, M. D. V., Assistant in Bacteriology and Veterinary Science, Sheffield Scientific School, Yale University. Illustrated. Price, Cloth, 75 cents.

The technical methods involved in bacteria-culture, methods of staining, and microscopical study are fully described and arranged as simply and concisely as possible. The book is especially intended for use in laboratory work.

OBSTETRIC ACCIDENTS, EMERGENCIES, AND OPERATIONS. By L. CH. BOISLINIERE, M. D., late Emeritus Professor of Obstetrics in the St. Louis Medical College. 381 pages, handsomely illustrated. Price, \$2.00 net.

“For the use of the practitioner who, when away from home, has not the opportunity of consulting a library or of calling a friend in consultation. He then, being thrown upon his own resources, will find this book of benefit in guiding and assisting him in emergencies.”

HOW TO EXAMINE FOR LIFE INSURANCE. By JOHN M. KEATING, M. D., Fellow of the College of Physicians and Surgeons of Philadelphia; Vice-President of the American Pædiatric Society; Ex-President of the Association of Life Insurance Medical Directors. Royal 8vo, 211 pages, with two large half-tone illustrations, and a plate prepared by Dr. McClellan from special dissections; also, numerous cuts to elucidate the text. Price, in Cloth, \$2.00 net.

"This is by far the most useful book which has yet appeared on insurance examination, a subject of growing interest and importance. Not the least valuable portion of the volume is Part II, which consists of instructions issued to their examining physicians by twenty-four representative companies of this country. As the proofs of these instructions were corrected by the directors of the companies, they form the latest instructions obtainable. If for these alone the book should be at the right hand of every physician interested in this special branch of medical science."—*The Medical News*, Philadelphia.

THE CARE OF THE BABY. By J. P. CROZER GRIFFITH, M. D., Clinical Professor of Diseases of Children, University of Pennsylvania; Physician to the Children's Hospital, Philadelphia, etc. 392 pages, with 67 illustrations in the text, and 5 plates. 12mo. Price, \$1.50.

A reliable guide not only for mothers, but also for medical students and practitioners whose opportunities for observing children have been limited.

"The whole book is characterized by rare good sense, and is evidently written by a master hand. It can be read with benefit not only by mothers, but by medical students and by any practitioners who have not had large opportunities for observing children."—*American Journal of Obstetrics*, July, 1895.

"The best book for the use of the young mother with which we are acquainted. . . . There are very few general practitioners who could not read the book through with advantage."—*Archives of Pediatrics*, Aug., 1895.

"No better book of its kind has come under our notice for some time. Although intended primarily for mothers and nurses, it will well repay perusal by medical students."—*Birmingham Medical Review*, Oct., 1895.

"This is one of the best works of its kind that has been presented to the people for many a day."—*Maryland Medical Journal*, Aug. 13, 1895.

NURSING: ITS PRINCIPLES AND PRACTICE. By ISABEL ADAMS HAMPTON, Graduate of the New York Training School for Nurses attached to Bellevue Hospital; Superintendent of Nurses, and Principal of the Training School for Nurses, Johns Hopkins Hospital, Baltimore, Md.; late Superintendent of Nurses, Illinois Training School for Nurses, Chicago, Ill. In one very handsome 12mo volume of 484 pages, profusely illustrated. Price, Cloth, \$2.00 net.

This original work on the important subject of nursing is at once comprehensive and systematic. It is written in a clear, accurate, and readable style, suitable alike to the student and the lay reader. Such a work has long been a desideratum with those intrusted with the management of hospitals and the instruction of nurses in training-schools. It is also of especial value to the graduate nurse who desires to acquire a practical working knowledge of the care of the sick and the hygiene of the sick-room.

NURSE'S DICTIONARY of Medical Terms and Nursing Treatment, containing Definitions of the Principal Medical and Nursing Terms and Abbreviations; of the Instruments, Drugs, Diseases, Accidents, Treatments, Physiological Names, Operations, Foods, Appliances, etc. encountered in the ward or in the sick-room. Compiled for the use of nurses. By HONNOR MORTEN, Author of "How to Become a Nurse," "Sketches of Hospital Life," etc. 16mo, 140 pages. Price, Cloth, \$1.00.

This little volume is intended merely as a small reference-book which can be consulted at the bedside or in the ward. It gives sufficient explanation to the nurse to enable her to comprehend a case until she has leisure to look up larger and fuller works on the subject.

DIET IN SICKNESS AND IN HEALTH. By MRS. ERNEST HART, formerly Student of the Faculty of Medicine of Paris and of the London School of Medicine for Women; with an INTRODUCTION by Sir Henry Thompson, F. R. C. S., M. D., London. 220 pages; illustrated. Price, Cloth, \$1.50.

Useful to those who have to nurse, feed, and prescribe for the sick. . . . In each case the accepted causation of the disease and the reasons for the special diet prescribed are briefly described. Medical men will find the dietaries and recipes practically useful, and likely to save them trouble in directing the dietetic treatment of patients.

"We recommend it cordially to the attention of all practitioners; . . . both to them and to their patients it may be of the greatest service."—*Medical Journal*, New York.

DIETS FOR INFANTS AND CHILDREN IN HEALTH AND IN DISEASE. By LOUIS STARR, M. D., Editor of "An American Text-Book of the Diseases of Children." 230 blanks (pocket-book size), perforated and neatly bound in flexible morocco. Price, \$1.25 net.

The first series of blanks are prepared for the first seven months of infant life; each blank indicates the ingredients, but not the *quantities*, of the food, the latter directions being left for the physician. After the seventh month, modifications being less necessary, the diet lists are printed in full. *Formulæ* for the preparation of diluents and foods are appended.

DIET LISTS AND SICK-ROOM DIETARY. By JEROME B. THOMAS, M. D., Visiting Physician to the Home for Friendless Women and Children and to the Newsboys' Home; Assistant Visiting Physician to the Kings County Hospital; Assistant Bacteriologist, Brooklyn Health Department. Price, \$1.50. Send for sample sheet.

There is here offered, in portable form, as an efficient aid to the better practice of Therapeutics, a collection of detachable Diet Lists and a Sick-room Dietary. It meets a want, for the busy practitioner has but little time to write out *Systems of Diet* appropriate to his patients, or to describe the preparation of their food. Compiled from the most modern works on dietetics, the Dietary offers a variety of easily-digested foods.

"A convenience that will be appreciated by the physician."—*Medical Journal*, New York.

"The work is an excellent one, and ought to be welcomed by physician, patient, and nurse alike."—*Indian Lancet*, Calcutta.

Practical, Exhaustive, Authoritative.

SAUNDERS'

NEW AID SERIES OF MANUALS.

FOR

STUDENTS AND PRACTITIONERS.

MR. SAUNDERS is pleased to announce the successful issue of several volumes of his **NEW AID SERIES OF MANUALS**, which have received the most flattering commendations from Students and Practitioners and the Press. As publisher of the **STANDARD SERIES OF QUESTION COMPENDS**, and through intimate relations with leading members of the medical profession, Mr. Saunders has been enabled to study progressively the essential *desiderata* in practical "self-helps" for students and physicians.

This study has manifested that, while the published "Question Compends" earn the highest appreciation of students, whom they serve in reviewing their studies preparatory to examination, there is special need of thoroughly reliable handbooks on the leading branches of Medicine and Surgery, each subject being compactly and authoritatively written, and exhaustive in detail, without the introduction of *cases* and foreign subject-matter which so largely expand ordinary textbooks.

The Saunders Aid Series will not merely be condensations from present literature, but will be ably written by well-known authors and practitioners, most of them being teachers in representative American Colleges. This *new series*, therefore, will form an admirable collection of advanced lectures, which will be invaluable aids to students in reading and in comprehending the contents of "recommended" works.

Each Manual will further be distinguished by the beauty of the *new* type; by the quality of the paper and printing; by the copious use of illustrations; by the attractive binding in cloth; and by the extremely low price at which they will be sold.

Saunders' New Aid Series of Manuals.

VOLUMES PUBLISHED.

- PHYSIOLOGY**, by JOSEPH HOWARD RAYMOND, A. M., M. D., Professor of Physiology and Hygiene and Lecturer on Gynecology in the Long Island College Hospital; Director of Physiology in the Hoagland Laboratory; formerly Lecturer on Physiology and Hygiene in the Brooklyn Normal School for Physical Education; Ex-Vice-President of the American Public Health Association; Ex-Health Commissioner, City of Brooklyn, etc. Illustrated. \$1.25 net.
- SURGERY**, General and Operative, by JOHN CHALMERS DaCOSTA, M. D., Demonstrator of Surgery, Jefferson Medical College, Philadelphia; Chief Assistant Surgeon, Jefferson Medical College Hospital; Surgical Registrar, Philadelphia Hospital, etc. 188 illustrations and 13 plates. (Double number.) \$2.50 net.
- DOSE-BOOK AND MANUAL OF PRESCRIPTION-WRITING**, by E. Q. THORNTON, M. D., Demonstrator of Therapeutics, Jefferson Medical College, Philadelphia. Illustrated. Price, cloth, \$1.25 net.
- SURGICAL ASEPSIS**, by CARL BECK, M. D., Surgeon to St. Mark's Hospital and to the New York German Poliklinik, etc. Illustrated. Price, cloth, \$1.25 net.
- MEDICAL JURISPRUDENCE**, by HENRY C. CHAPMAN, M. D., Professor of Institutes of Medicine and Medical Jurisprudence in the Jefferson Medical College of Philadelphia; Member of the College of Physicians of Philadelphia, of the Academy of Natural Sciences, of the American Philosophical Society, and of the Zoological Society of Philadelphia. Illustrated. \$1.50 net.
- SYPHILIS AND THE VENEREAL DISEASES**, by JAMES NEVINS HYDE, M. D., Professor of Skin and Venereal Diseases, and FRANK H. MONTGOMERY, M. D., Lecturer on Dermatology and Genito-Urinary Diseases, in Rush Medical College, Chicago. Profusely Illustrated. (Double number.) \$2.50 net.
- PRACTICE OF MEDICINE**, by GEORGE ROE LOCKWOOD, M. D., Professor of Practice in the Woman's Medical College of the New York Infirmary; Instructor of Physical Diagnosis of the Medical Department of Columbia College; Attending Physician to the Colored Hospital; Pathologist to the French Hospital; Member of the New York Academy of Medicine, of the Pathological Society, of the Clinical Society, etc. Illustrated. (Double number.) \$2.50 net.
- MANUAL OF ANATOMY**, by IRVING S. HAYNES, M. D., Adjunct Professor of Anatomy and Demonstrator of Anatomy, Medical Department of the New York University, etc. Beautifully Illustrated. (Double number.) Price, \$2.50 net.
- MANUAL OF OBSTETRICS**, by W. A. NEWMAN DORLAND, M. D., Asst. Demonstrator of Obstetrics, University of Pennsylvania; Chief of Gynecological Dispensary, Pennsylvania Hospital; Member of Philadelphia Obstetrical Society, etc. Profusely illustrated. (Double number.) Price, \$2.50 net.

VOLUMES IN PREPARATION.

- MATERIA MEDICA**, by HENRY A. GRIFFIN, A. B., M. D., Assistant Physician to the Roosevelt Hospital, Out-patient Department, New York City.
- NOSE AND THROAT**, by D. BRADEN KYLE, M. D., Chief Laryngologist of the St. Agnes Hospital, Philadelphia; Bacteriologist of the Orthopædic Hospital and Infirmary for Nervous Diseases; Instructor in Clinical Microscopy and Assistant Demonstrator of Pathology in the Jefferson Medical College, etc.
- NERVOUS DISEASES**, by CHARLES W. BURR, M. D., Clinical Professor of Nervous Diseases, Medico-Chirurgical College, Philadelphia; Pathologist to the Orthopædic Hospital and Infirmary for Nervous Diseases; Visiting Physician to the St. Joseph Hospital, etc.
- MANUAL OF PATHOLOGY**, by ALFRED STENGEL, M. D., Instructor in Clinical Medicine, Medical Department University of Pennsylvania, etc.

. There will be published in the same series, at close intervals, carefully-prepared works on the subjects of Children, Gynecology, Hygiene, etc., by prominent specialists.



SAUNDERS' QUESTION COMPENDS.

Arranged in Question and Answer Form.

THE LATEST, CHEAPEST, AND BEST ILLUSTRATED SERIES
OF COMPENDS EVER ISSUED.

Now the Standard Authorities in Medical Literature

WITH

Students and Practitioners in every City of the United States
and Canada.

THE REASON WHY

They are the advance guard of "Student's Helps"—that DO HELP; they are the leaders in their special line, *well and authoritatively written by able men, who, as teachers in the large colleges, know exactly what is wanted by a student preparing for his examinations.* The judgment exercised in the selection of authors is fully demonstrated by their professional elevation. Chosen from the ranks of Demonstrators, Quiz-masters, and Assistants, most of them have become Professors and Lecturers in their respective colleges.

Each book is of convenient size (5 × 7 inches), containing on an average 250 pages, profusely illustrated, and elegantly printed in clear, readable type, on fine paper.

The entire series, numbering twenty-three volumes, has been kept thoroughly revised and enlarged when necessary, many of them being in their fourth and fifth editions.

TO SUM UP.

Although there are numerous other Quizzes, Manuals, Aids, etc. in the market, none of them approach the "Blue Series of Question Compends;" and the claim is made for the following points of excellence:

1. Professional distinction and reputation of authors.
2. Conciseness, clearness, and soundness of treatment.
3. Size of type and quality of paper and binding.

**** Any of these Compends will be mailed on receipt of price (see over for List).**

Saunders' Question-Compend Series.

Price, Cloth, \$1.00 per copy, except when otherwise noted.

1. **ESSENTIALS OF PHYSIOLOGY.** 3d edition. Illustrated. Revised and enlarged. By H. A. HARE, M. D. (Price, \$1.00 net.)
2. **ESSENTIALS OF SURGERY.** 5th edition, with an Appendix on Antiseptic Surgery. 90 illustrations. By EDWARD MARTIN, M. D.
3. **ESSENTIALS OF ANATOMY.** 5th edition, with an Appendix. 180 illustrations. By CHARLES B. NANCREDE, M. D.
4. **ESSENTIALS OF MEDICAL CHEMISTRY, ORGANIC AND INORGANIC.** 4th edition, revised, with an Appendix. By LAWRENCE WOLFF, M. D.
5. **ESSENTIALS OF OBSTETRICS.** 3d edition, revised and enlarged. 75 illustrations. By W. EASTERLY ASHTON, M. D.
6. **ESSENTIALS OF PATHOLOGY AND MORBID ANATOMY.** 6th thousand. 46 illustrations. By C. E. ARMAND SEMPLE, M. D.
7. **ESSENTIALS OF MATERIA MEDICA, THERAPEUTICS, AND PRESCRIPTION-WRITING.** 4th edition. By HENRY MORRIS, M. D.
- 8, 9. **ESSENTIALS OF PRACTICE OF MEDICINE.** By HENRY MORRIS, M. D. An Appendix on URINE EXAMINATION. Illustrated. By LAWRENCE WOLFF, M. D. 3d edition, enlarged by some 300 Essential Formulæ, selected from eminent authorities, by WM. M. POWELL, M. D. (Double number, price \$2.00.)
10. **ESSENTIALS OF GYNÆCOLOGY.** 3d edition, revised. With 62 illustrations. By EDWIN B. CRAGIN, M. D.
11. **ESSENTIALS OF DISEASES OF THE SKIN.** 3d edition, revised and enlarged. 71 letter-press cuts and 15 half-tone illustrations. By HENRY W. STELWAGON, M. D. (Price, \$1.00 net.)
12. **ESSENTIALS OF MINOR SURGERY, BANDAGING, AND VENEREAL DISEASES.** 2d edition, revised and enlarged. 78 illustrations. By EDWARD MARTIN, M. D.
13. **ESSENTIALS OF LEGAL MEDICINE, TOXICOLOGY, AND HYGIENE.** 130 illustrations. By C. E. ARMAND SEMPLE, M. D.
14. **ESSENTIALS OF DISEASES OF THE EYE, NOSE, AND THROAT.** 124 illustrations. 2d edition, revised. By EDWARD JACKSON, M. D., and E. BALDWIN GLEASON, M. D.
15. **ESSENTIALS OF DISEASES OF CHILDREN.** 2d edition. By WILLIAM M. POWELL, M. D.
16. **ESSENTIALS OF EXAMINATION OF URINE.** Colored "VOGEL SCALE," and numerous illustrations. By LAWRENCE WOLFF, M. D. (Price, 75 cents.)
17. **ESSENTIALS OF DIAGNOSIS.** By S. SOLIS-COHEN, M. D., and A. A. ESHNER, M. D. 55 illustrations, some in colors. (Price, \$1.50 net.)
18. **ESSENTIALS OF PRACTICE OF PHARMACY.** By L. E. SAYRE. 2d edition, revised and enlarged.
20. **ESSENTIALS OF BACTERIOLOGY.** 2d edition. 81 illustrations. By M. V. BALL, M. D.
21. **ESSENTIALS OF NERVOUS DISEASES AND INSANITY.** 48 illustrations. 2d edition, revised. By JOHN C. SHAW, M. D.
22. **ESSENTIALS OF MEDICAL PHYSICS.** 155 illustrations. 2d edition, revised. By FRED J. BROCKWAY, M. D. (Price, \$1.00 net.)
23. **ESSENTIALS OF MEDICAL ELECTRICITY.** 65 illustrations. By DAVID D. STEWART, M. D., and EDWARD S. LAWRANCE, M. D.
24. **ESSENTIALS OF DISEASES OF THE EAR.** By E. B. GLEASON, M. D. 89 illustrations.

**PLEASE DO NOT REMOVE
CARDS OR SLIPS FROM THIS POCKET**

UNIVERSITY OF TORONTO LIBRARY

BioMed

