

TJ
7
M3
v.77

UC-NRLF



B 3 018 804

5 CENTS

PRINCIPLES AND APPLICATIONS OF
ELECTRICITY

PART V—TELEGRAPH AND TELEPHONE

SECOND EDITION

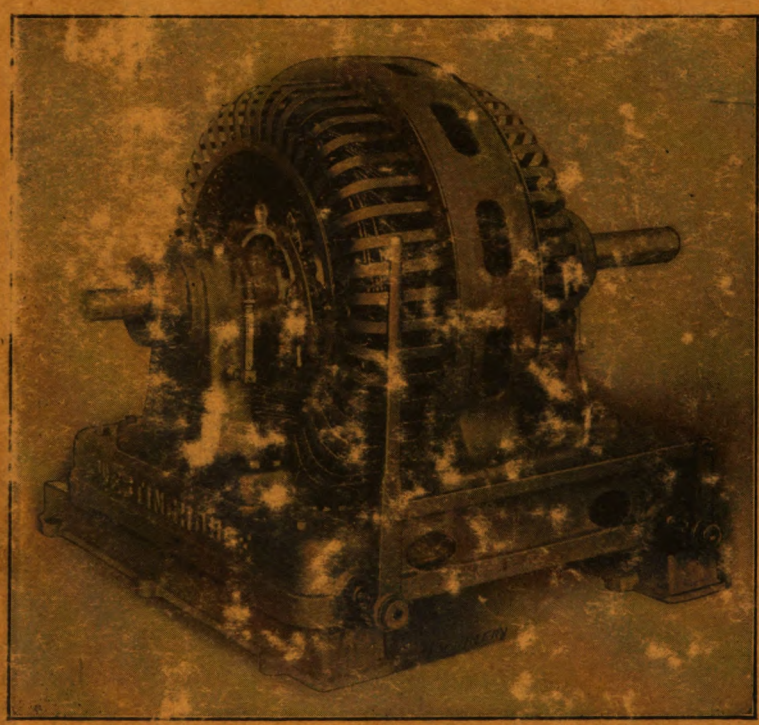

MACHINERY'S REFERENCE BOOK NO. 77
PUBLISHED BY MACHINERY, NEW YORK

MACHINERY'S REFERENCE SERIES

EACH NUMBER IS A UNIT IN A SERIES ON ELECTRICAL AND
STEAM ENGINEERING DRAWING AND MACHINE
DESIGN AND SHOP PRACTICE

NUMBER 77

PRINCIPLES AND APPLICATIONS OF ELECTRICITY

PART V

TELEGRAPH AND TELEPHONE

SECOND EDITION

CONTENTS

The Telegraph - - - - -	3
Wireless Telegraphy - - - - -	16
The Telephone - - - - -	25
Wireless Telephony - - - - -	40

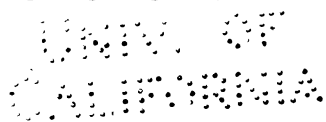

CHAPTER I

THE TELEGRAPH

The first attempts to transmit messages by the aid of the electric current were made as early as in the eighteenth century. According to the authorities on the history of telegraphy, Le Sage of Geneva produced a simple system of telegraphy as far back as in 1774. His methods, however, proved impractical, except for demonstration purposes. Other early inventors in the field of telegraphy were Lomond and Cavallo, whose inventions date back to 1787 and 1795, respectively, Ronalds, Soemmering, Ampere, Henry, Schilling, Weber, Cooke and Wheatstone all produced different apparatus, with more or less success, during the early part of the last century. The first permanently practical success, however, was attained by Morse in 1837. Since the time of Morse a number of improvements have been made, and various systems known as the diplex, duplex, quadruplex and multiplex have been developed. The names connected with the invention and development of these systems are Gintl, Stearns, Stark, Bosscha, Heaviside, Edison and Delany. In addition to these inventors should be mentioned the names of Hughes, Cowper and Elisha Gray, and especially Lord Kelvin, to whom a great deal of the success of cable telegraphy is due. Among all the various systems for transmitting messages by wire by means of the electric current, the only one, however, which calls for an extended description in an elementary treatise, is the Morse system. Wireless telegraphy will be treated in detail in the following chapter.

Two successful methods, known as the open-circuit and the closed-circuit systems are at the present time in use for telegraphy with wires. The closed-circuit system is used almost entirely in the United States, while the open-circuit system is used largely in Europe. The difference between the two systems, in principle, consists simply in the fact that when the apparatus is not in use for sending messages, a switch is connected, or "closed," in the closed-circuit system so that the current flows continually through the line, while in the open-circuit system no current is consumed from the batteries except when signals or messages are actually being transmitted. This is the chief advantage of the open-circuit system. The closed-circuit system, however, has other advantages which off-set this. The two systems call for a different arrangement of batteries.

A diagrammatical sketch of the arrangement of a closed-circuit system of telegraphy is shown in Fig. 1. In its simplest form this system contains three principal parts, key, sounder and battery, connected in series in the circuit. When a message is to be sent, the switch, already mentioned, is disconnected or "opened," thus opening the circuit. The message or signal is then sent by means of a telegraph key, which, when operated, closes the circuit. When the circuit is thus closed, an

instrument receiving the message or signal, and consisting primarily of an electromagnet with spring-balanced armature, is thrown into operation, this instrument, giving a loud click, being called a sounder. A battery or series of batteries is used for furnishing the current for

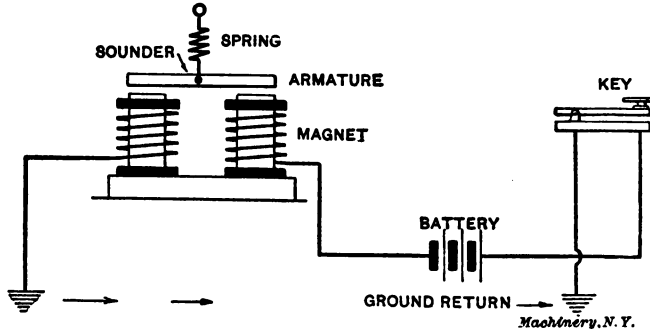

Fig. 1. Diagrammatic View of the Arrangement of a Closed Circuit System of Telegraphy

operating the system. Only one wire is used, the system being connected to the ground at each end, and the earth being used for the return.

The Sounder

The sounder consists of a pair of vertically mounted electromagnets which attract an armature against the tension of a spring. The open-

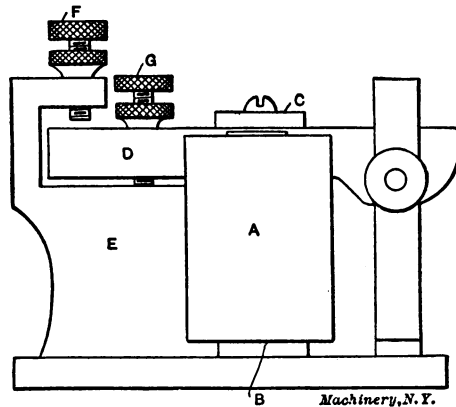

Fig. 2. Elements of the Sounder

ing or closing of the circuit by means of the telegraph key either releases or attracts this armature. A simple construction of the sounder is shown in Fig. 2. At A is shown one of the electromagnets, the other being directly behind it. The electromagnet is made up of two cores and a yoke B. At C is shown an armature of soft iron, this armature being attached to a lever D made of a non-magnetic material. This lever is controlled by a spring not shown in the illustration, so

that the armature is held away from the electromagnet, whenever a current does not pass through the coils around the latter. When, however, a current passes through the coils of the electromagnet, the cores are magnetized, and the armature is attracted or held by the magnetic action. The armature, however, does not touch the end of the cores, because the instrument is so adjusted that immediately before the armature would touch the end of the core, a stop-screw *G* through the lever *D* strikes the bracket *E* and a click is heard. When the current ceases to flow, that is, when the key at the sending end is released so as to open the circuit, the magnetic force of the cores of the electromagnet ceases to exist, and the armature is thrown upwards by means of the spring, as already mentioned. The lever then strikes a stop-screw *F* and another click is heard. It is this succession of clicks that make an intelligent transmission of messages possible. When the time during which the current flows is very short the interval of time between the two clicks will be correspondingly short, and the signal in that case is a "dot." If the interval between the two clicks is longer the signal is called a "dash." The telegraphic code ordinarily called the Morse code is made up of various combinations of dots and dashes, each combination signifying a certain letter or figure, as shown below:

A	. —	J	— . — .	S	... 1	. — — .
B	— . . .	K	— . —	T	— 2	. . — . .
C	. . .	L	— — —	U	. . — 3	. . . — .
D	— . .	M	— —	V	. . . — 4
E	.	N	— .	W	. — — 5	— — —
F	. — .	O	. . .	X	. — . . 6
G	— — .	P	Y 7	— — — .
H	Q	. . — .	Z 8	—
I	. .	R	0	— — — 9	— . . — .

The system as outlined above is called the American Morse code. There is also an International code which differs to some extent from the American Morse code. Both, however, are founded on exactly the same principle of combination of dots and dashes. When a message is sent an interval is introduced between each letter and a longer interval between each word. In the original system the instrument was combined with a writing apparatus which recorded the dots and dashes, and entire reliance was not placed on the ear of the operator in taking the message directly from the sounder. This recording system is still in use to a considerable extent in Europe, but hardly used at all in America. It has been found that the ear is more reliable than the eye, that a simple sounder, therefore, is preferable to a recording mechanism.

The two systems used for recording the messages are called the embosser and the ink-writer systems. In the embosser system a sharp pointer fastened to the armature lever cuts dots or dashes in a strip of paper moved past it by means of an automatic apparatus operated by clockwork. In the ink-writer system, the dots and dashes are recorded on a moving strip of paper by an inked wheel or pointer.

The key or sending apparatus of the Morse telegraphic system is shown in Fig. 3. In its simplest form it consists of a lever *A* pivoted a certain distance past its center, at *B*. The hand or fingers of the operator rest at *C*. At *E* is a binding screw, securing the instrument to its base; this screw also acts as an electrical connection to the main body of the key and lever *A*. At binding screw *F* is a connection to platinum tip *G*, which is insulated from the rest of the apparatus. Another platinum tip *H* is placed on lever *A*, which makes contact with

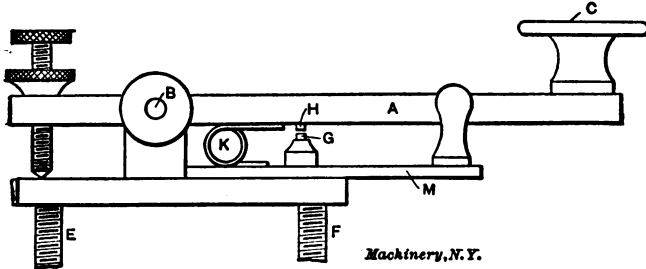

Fig. 3. The Key or Sending Apparatus

G when the lever is pressed down, thus completing the circuit through the key. When the key is not used, the lever is kept in a proper position by a spring *K*. When the instrument is not in use, switch *M* is used for closing the circuit. This completes the simple arrangement of the key or sending apparatus.

The Relay

Although the chief constituents of a simple telegraph system consist of a sounder, battery, key and line, another important adjunct in the shape of a relay becomes necessary when the telegraph system comprises a long line having many instruments in series. In this case the

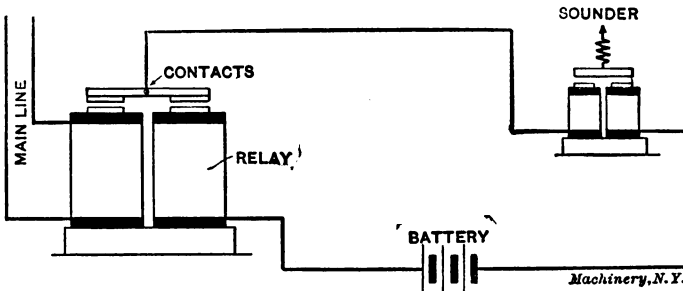

Fig. 4. Diagrammatical View showing Action of Relay

main current is not strong enough to operate the sounder at the receiving station directly, and a device called a relay is then resorted to. This instrument is employed for the purpose of receiving the incoming signal and for throwing into action a new set of local batteries which supply the current for reproducing the signal with greater emphasis. In other words, when the armature of the magnet constituting the re-

lay is attracted by the magnet, it closes a new local circuit in which is a sounder, as indicated in the diagrammatical view in Fig. 4.

When a receiving apparatus is provided with a relay the instrument is usually provided with a horizontal electromagnet having a large number of turns in its coils, and an armature arranged practically the same as in the ordinary simple sounder. The coils in the electromagnet mentioned are in series with the main line current. The armature of this electromagnet is very carefully balanced, so that a very small electromotive force will attract it. In this way a very small current will be sufficient for producing a contact through which can flow a local circuit supplied with current from a sufficient number of batteries and operating an ordinary Morse sounder.

From this it will be understood that the ordinary telegraph station contains a connection to the main line and in addition to this it has its own local circuit by means of which it is able, so to speak, to reinforce the current of the main line so as to deliver the messages in an intelligent form. The reason why the main line current cannot be used directly is due to the conditions of the line. Leakage occurs to some extent so that the current becomes too weak to produce an effective signal. The leakage may be due either to the length of the line or to defects in the insulation.

The sounder is provided with two binding posts or electrical contacts which connect one directly with the battery, and one with the battery *via* the relay. The relay possesses four binding posts, two of which connect with the incoming line and two of which complete the circuit of the sounder and its battery. The sounder, relay and key are generally mounted on one board for convenience. The relay, for its operation, takes only about one-tenth of the current that would be required for the sounder. In fact, the relay current is so small that it cannot be measured by the ordinary electrical measuring instruments. Its strength is estimated in thousandths of an ampere. The relay usually requires 0.010 ampere (10 milliamperes) if well adjusted, and sometimes the current required may be even less than this.

Adjustments

The adjustment of the armature of the relay, and of the sounder as well, is of great importance. If the armature is properly adjusted, it will require a smaller volume of current to operate than otherwise. It is evident that the closer the armature lies to the iron cores of the magnet, without actually touching them, the stronger will be the magnetic force by which it is attracted, and as regards the sounder, the louder will be the click that results from the closing of the circuit. The best way to adjust the sounder armature is to first insert a thin piece of paper between the armature and the iron pole-piece of the electromagnet, and then let the lever down until it touches and holds the paper while the key is closed. The adjusting screw is then manipulated until the paper can be just pulled out, the adjustment then being made permanent by means of the locknut shown in the illustration, Fig. 2. The other screw is then adjusted so as to give the proper dis-

tance or play for the lever. The spring in the sounder, not shown in Fig. 2, is also provided with an adjusting screw regulating its tension, so that a certain relation between the strength of the up and down stroke of the lever can be produced in order to make the signals received easily audible or "read."

Referring to Fig. 1 it will be seen that the sending and receiving apparatus are connected only by one line of wire, the instruments being connected to the ground at each end of the line, as already mentioned, and the return being through the ground. By this means it is possible to transmit messages without having a return wire, a single line

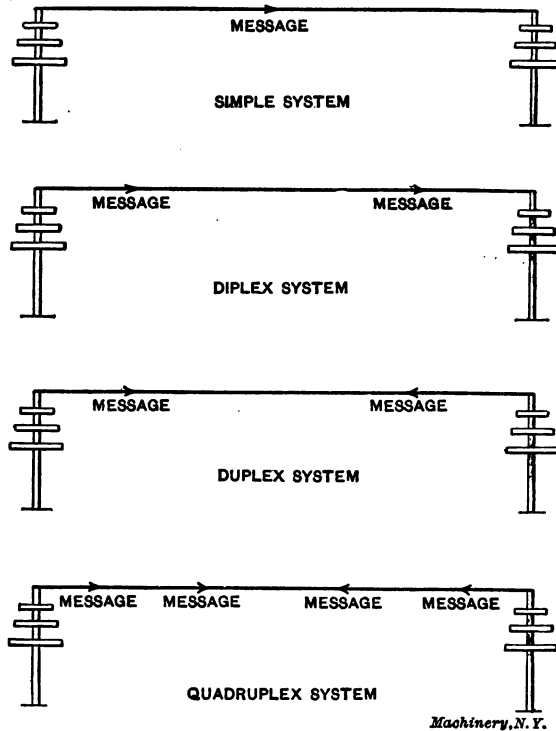

Fig. 5. Graphical Illustrations of Principles of Various Systems of Telegraphy

only being necessary. The batteries may all be placed at one end of the circuit if preferred, or may be divided and placed half at each end. The arrangement of the batteries is immaterial as far as the principle of action is concerned. The batteries for operating the sounder in the local circuit connected by the relay are, of course, placed in the local stations.

Number of Messages Sent Over One Wire

The number of messages that may be sent over one wire at the same time depends upon the character of the apparatus at the ends of the

line. With regard to the number of messages that may thus be sent, a number of systems have been developed, known as the simple, the diplex, the duplex, the quadruplex, and the multiplex systems.

The simple system merely permits the transmitting of a signal, one at a time, over the wire.

A diplex system is one by means of which two distinct signals may be sent at the same time *from one end* of the wire without confliction and be received at the other end without trouble. These signals or messages both travel in the same direction.

A duplex system permits a message to be sent from each end of the line at the same instant without confusion. It differs from the diplex

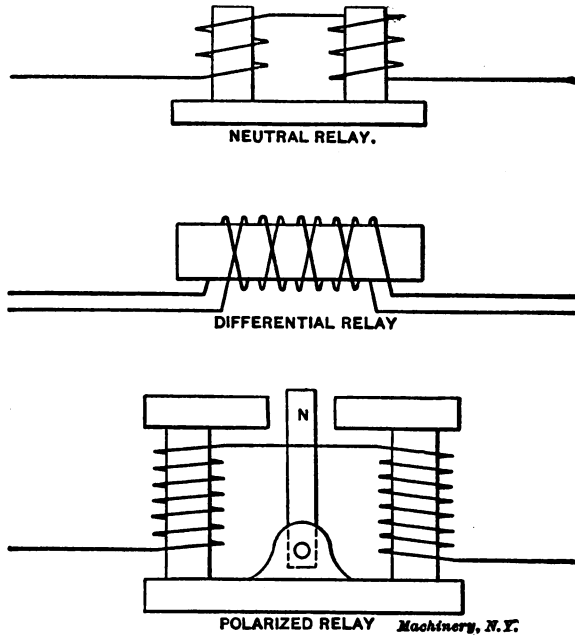

Fig. 6. Windings of Different Types of Relays

as regards the direction of the messages. The diplex sends both one way, the duplex both in opposite directions at the same time.

A quadruplex system is one in which two messages may be sent from each end of the line at the same instant, making four in all, two moving in one direction, and two in the opposite direction. This system might be called either a double diplex, a double duplex, or a combination of a diplex and duplex system. The latter idea is carried out in practice, in that devices are used by which the line is both "diplexed" and "duplexed" for the purpose of conveying four messages at one time. The principle of the various systems is graphically illustrated in Fig. 5.

This principle can be carried out beyond the point of the quadruplex system, in fact, to such an extent that eight messages may be trans-

mitted simultaneously, in which case, octuplex, or, simply, multiplex, is the name given to the system; but a development of this kind would naturally call for the use of a more and more complicated system of devices. Patrick B. Delany invented a system in which complications of this kind are avoided. His system is known as the Delany synchronous system of multiple telegraphy.

The Diplex System

The practical principle employed in telegraphy for the purpose of obtaining different sets of signals over the same line is that of using certain keys to operate certain relays—one key, for instance, sending over the line a powerful current which actuates one relay, and another key controlling the direction of the current and, therefore, operating another type of relay. In other words, the keys are selective with respect to the relays. It is necessary to examine the types of relays before the subject can be properly comprehended.

The relays may be classified, according to the character of the current which will actuate them, as neutral relays, differential relays, and

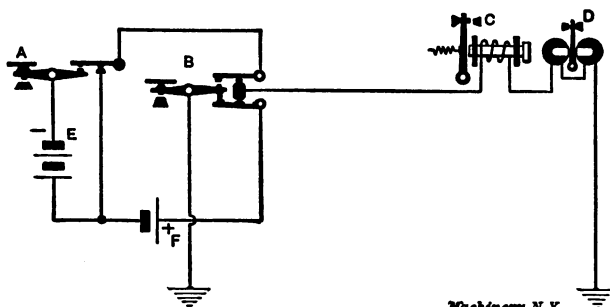

Fig. 7. Arrangement of Keys for Diplex System of Telegraphy

polarized relays. The principles of winding these various relays are diagrammatically illustrated in Fig. 6.

The neutral relay is, as its name implies, a relay operated by an ordinary current irrespective of its direction. The current must be of sufficient strength to cause emphatic movement of the relay armature.

The differential relay is an electromagnet possessing two distinct windings, each wound opposite to the other and each of exactly the same number of turns and resistance. The equivalence of the turns makes the magnetic effects alike; therefore, the passage through the coils of two equal currents would leave the relay inoperative.

The polarized relay is supplied with a permanently magnetized armature. One pole of this armature lies between the two poles of an electromagnet. When this magnetized armature moves decidedly in one direction or the other it is because the current in the electromagnet is flowing in a certain direction. The armature is polarized for the purpose of making the relay sensitive to changes in the direction of current.

In Fig. 7 two keys are shown. The first, A, as indicated, will have

the effect of sending into the line the current of three cells of battery. The key, it should be noted, has no control over the direction of the current. When it is moved down it operates the first relay *C*, a neutral relay of the type previously described. The current passing through the second polarized relay *D* is ineffective because it lacks the direction required to throw the armature on the particular side which closes the contacts governing the local circuit and its sounder.

The second key *B* is a reversing key, or pole-changing transmitter. Its only function is that of sending a relatively weak current into the line, which is either positive or negative, depending upon the position of the key. This weak current cannot affect the neutral relay which remains unresponsive to the currents passing through it unless sent by the first key *A*. The batteries *E* and *F* will act in combination when key *A* is pressed, giving, therefore, a high electromotive force. When the key *B* is pressed to operate the relay *D* only one cell of battery *F* is in action. Hence, key *B* sends a weaker current into the line, but varies its polarity with reference to the line, and therefore actuates the more delicately adjusted relay previously mentioned. Each relay, it must be remembered, is attached to a separate local circuit containing battery and sounder. Therefore, if one operator presses key *A*, a sounder in circuit with relay *C* gives its message. If another operator presses key *B* a sounder in circuit with relay *D* will deliver its message. It should be understood that if both keys are worked simultaneously, the direction of the current can be reversed at will by the operator at *B*. As this is the only influence which effects the polarized relay at *D*, the system as thus presented is one in which two messages can be sent forward along the line at the same instant. This is the fundamental principle of the duplex system. Examination of key *B* will show that if the operator at *A* is holding his key and the operator at *B* reverses the current to actuate the relay at *D* the continuity of the line is not destroyed, but the relay *C* will relax for an instant, causing what is familiarly known as a *clip*. This is almost eradicated by the aid of special devices in practical telegraphy.

Duplex System of Telegraphy

In the duplex system of telegraphy it is possible to send two messages over the line, each traveling in the opposite direction. This system possesses certain essential and characteristic features which might be enumerated as follows:

- 1.—A differentially wound relay.
- 2.—An artificial line.
- 3.—A transmitter.

The principle involved in this system is to be able to send a message out of the station without affecting the relay installed there, yet permitting it to respond to the influence of a message or signal sent in. This seemingly difficult and paradoxical task is accomplished by the proper co-operation and relationship of the three devices mentioned above in conjunction with a storage battery.

The differential relay, being an electromagnet with two opposite and equal windings, cannot be affected magnetically if each winding carries an equal current. If, therefore, when a signal is sent out of the station, the current it represents passes through this differential relay, then the problem resolves itself into that of securing an equal flow of electricity through each of the windings of the relay. If means are employed, through which one-half of this current goes out over the line, and the other half is directed into the earth, then the difficulty has been removed and the object of keeping the relay inoperative under these circumstances secured.

The artificial line now comes into play. It consists of a resistance equal to that of the line, and a condenser of a capacity also equal to that of the line. The current from the station is led to the point at which the two windings of the electromagnet begin, as shown in Fig.

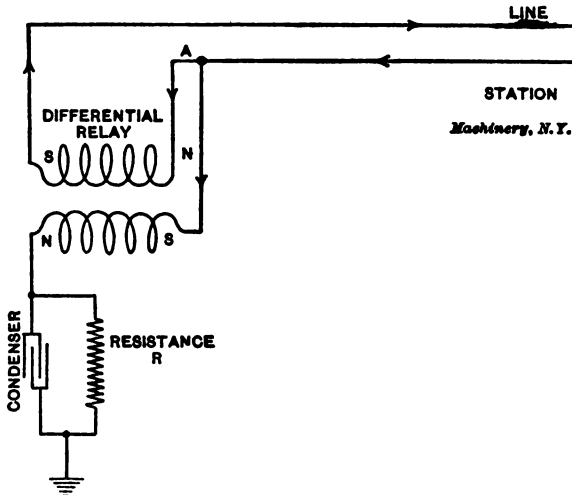

Fig. 8. Arrangement of Artificial Line in Duplex Telegraphy

8 at A. If resistance R and the capacity of the condenser are exactly equal to those of the line, then the current will divide equally at A. One-half will go through the relay winding and over the line. The other half will go through the relay winding into the earth. The currents being equal in each winding of the relay, it will remain unaffected when an outgoing signal is sent.

The transmitter employed in duplex telegraphy is so arranged that when the key is pressed, as shown in Fig. 9, the magnet S will pull the lever D , and thus produce a contact with lever N at O . This enables the current from the battery B to pass into the differential relay, one-half to the line and one-half to the earth. If at this moment, the distant telegrapher presses his key, then one of the coils of the differential relay will be supplied with more current than the other, and as a natural consequence of this, the relay will be operated. Its operation means the throwing in of the local circuit, and as a result the

click of the sounder is heard. Hence, it will be seen that by means of this construction it is possible to accomplish the desired results, that is, making the relay inoperative by the outgoing current and making it responsive to the incoming signal.

The diagram in Fig. 9 should be examined in order to fully understand the paths of the various currents. When the key *K* is pressed, as already described, a negative current passes from the battery *B* through the levers *D* and *N* into the differential relay only to divide equally into the line and earth *via* the two opposite windings of the relay. A signal sent in, however, means a current in only one winding of the relay, which, of course, will force it to operate, or it means a current superposed upon the other already passing through. This last condition only exists when both keys are pressed in each station at the same time. The wire grounded at *A* serves the purpose of allowing an incoming current, whether positive or negative, to pass into

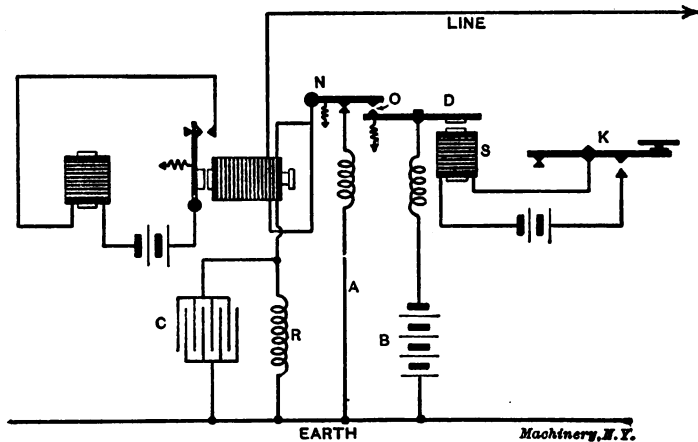

Fig. 9. General Arrangement of Duplex System of Telegraphy

the earth after magnetizing the relay. The diplex and the duplex therefore differ from each other fundamentally in the respect that in the first case both the direction and the strength of the current are controlled to operate two relays adjusted to them; while in the second case, messages are transmitted in opposite directions, by having a relay in action sensitive only to the incoming impulse, and remaining unaffected by the outgoing signals through the influence of the artificial line.

Purpose of Condenser

The introduction of the condenser in duplex telegraphy was the idea of Joseph B. Stearns, who thus, by its practical application, removed from the apparatus the false signal its absence produces. The resistance of the artificial line and line proper may be the same, but this alone would not fulfill the purpose desired. It is obvious that as the line must be charged when signalling, it is bound to discharge itself

later and affect the service, that is, the line will act as a condenser, the charging of the line when signalling presupposing a subsequent discharge through the instruments. In order to balance its effect, it is necessary to place a condenser in the artificial line as well as the resistance. The capacity of the condenser and the ohmic resistance of the artificial line must at all times be equal to the capacity and the resistance of the line proper, if the sending of messages is to be made possible with equal facility from each end of the line. As the capacity and the resistance of the line proper differ with the weather condi-

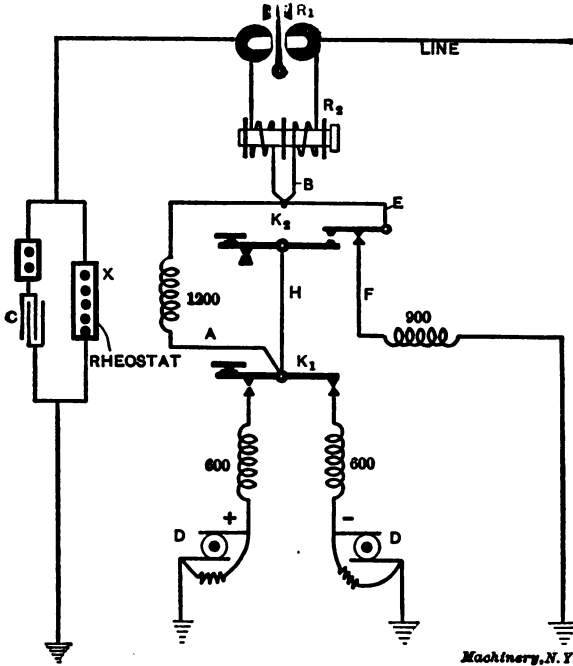

Fig. 10. General Arrangement of Quadruplex System of Telegraphy

tions, adjustment must be made of the resistance and capacity of the condenser in the artificial line. The term applied to these adjustments is "balancing." The adjustments must be made every day, particularly if the weather is changeable.

Quadruplex Telegraphy

By means of quadruplex telegraphy, two messages can be sent from each end at the same time. Altogether, four different signals traverse the wire at one time without interference. The accomplishment of this, it is evident, means the use of two relays at each of the stations receiving the signals. It is also obvious that when two signals are sent simultaneously from one station the relays of said station must not be actuated by the current. This proposition is carried out in practice by the use of two differential relays at each station. These relays

are, respectively, neutral and polarized, and operate in conjunction with an artificial line. In addition each station is provided with two keys of the characters previously described in connection with duplex telegraphy. One is used for sending a comparatively powerful current into the line, the other for reversing the polarity of the line.

In Fig. 10 the quadruplex system is shown operated by means of currents generated by dynamos *D*. These take the place of the batteries, and have proved themselves to be far more convenient. At the dynamos opposite poles are connected to the line with two 600 ohm resistances in circuit. The description referring to this diagram, as given by Franklin Leonard Pope in his work entitled "Modern Practice of the Electric Telegraph," is as follows: "*K*₁ is the pole changing transmitter and *K*₂, the single current transmitter, which for simplicity are shown in the diagram as keys, but which are in practice operated by electromagnets, local batteries and independent keys. When the apparatus is at rest, the current from the negative dynamo traverses a resistance coil of say 600 ohms, inserted to avoid danger of short circuit, to the rear contact of the pole changing key *K*₁; thence through wire *A* and the 1200 ohms resistance to point *B*, where it divides into three portions; the first portion going to the line and distant station, the second through the artificial line, including rheostat *X* to the earth, and the third through the wire *E*, the normally closed rear contact of the single current key *K*₂, and a rheostat of say 900 ohms to the earth. If, for example, therefore, we assume the resistance of the main and artificial line to be 3600 ohms each, it follows from the law of the distribution of currents in branch circuits that two-thirds will return to earth through wires *E* and *F*, one-sixth will go to the main line and one-sixth to the artificial line.

"If now the key *K*₂ be depressed in order to send a signal, a direct connection will be formed between key *K*₁ and the point *B* through wires *H* and *E*, shunting the 1200 ohm coil in wire *A*. At the same time the wire *F* will be opened, and the whole current will divide at the point *B*, half going to the main line and half to the artificial line. It follows, therefore, that with the several resistances in the ratios shown, the current sent to line by the key *K*₁ when key *K*₂ is depressed will be three times as strong as when the latter is raised, and this will be equally true whether the current sent by key *K*₁ be positive or negative. A computation of the effects of the several resistances will also show that when an arriving current reaches the point *B*, the resistance which it has to encounter in passing thence to the ground is the same whether the key *K*₂ be depressed or raised. When the key is depressed the resistance is only that of one or the other of the 600 ohm coils between the key *K*₁ and the dynamos; when raised, it is the joint resistance of one coil of 600, plus the coil of 1200 (a total of 1800) in one branch, and the coil of 900 in the other branch, the joint resistance of the two being 600, the same as in the first instance. The relays *R*₁ and *R*₂ at each station, being both differential, are not affected by outgoing currents, whatever may be the strength or the polarity of such currents."

CHAPTER II

WIRELESS TELEGRAPHY

In speaking of the origin of wireless telegraphy, it is necessary to begin at that point in the history of the discoveries in electricity which might be properly called the first suggestion. On this score many arguments may arise, presented on the one hand by the scientist and mathematician, and on the other hand by the practical inventor. It is generally acknowledged, however, that the first correct analysis of the conditions and phenomena which gave rise to what was later called wireless telegraphy was made by Hertz of Karlsruhe, Germany, who in 1888 succeeded in producing electric waves which followed the known laws of light waves. The theoretical system of Maxwell, who determined mathematically the relations between the varied phenomena produced by electric and magnetic forces guided Hertz in his experiments; and then again, the basis of Maxwell's mathematical investigations was a long series of epoch-making experiments made by Faraday, who in 1845 demonstrated experimentally that electric and magnetic forces were transmitted through the same medium as light. Going still further back, we find that the primary principle upon which the modern invention of wireless telegraphy is based was announced in 1678 by Huygens, of Holland, who first voiced the idea that all space not taken up by matter was filled by a subtle substance which he called ether, and which made it possible to account in a logical manner for the various phenomena of light.

It is quite evident that while the study of wireless telegraphy is a practical proposition, it is necessary to examine to some extent the principles involved in the experiments which led up to its practical application, in order to understand more fully the conditions and limitations of this new art of transmitting messages by means of electricity. During experiments conducted for the purpose of ascertaining the laws according to which electric waves move through space, Hertz discovered sparks at various points in his circuits which were strongest where a wall seemed to act as a reflector. He was able to trace the reflected waves and to measure them, and arrived at the astounding conclusion that conductors carrying an oscillating current were throwing out into space waves in every respect similar to light waves, although invisible. The reason why these waves are not visible to the eye is because they are longer than the light waves and, therefore, do not affect the eye. They are propagated through space, however, at a velocity equal to that of light.

A diagrammatical view embodying the main features of the apparatus which Hertz used in producing and demonstrating the existence of electric waves is shown in Fig. 11. The main apparatus shown is the wave-producing or sending apparatus, while the ring shown at *H*

WIRELESS TELEGRAPHY

is the receiver, commonly called resonator. The set consists of an induction coil *A* receiving its current from the battery *B*. The circuit can be closed and opened at will at *C*. The primary of the induction coil at *D* are connected to two brass spheres *E*. The secondary turn are attached to the metal sheets *F* by means of brass rods *G*. This latter part of the instrument is called the oscillator, and the electric waves are propagated. In order to produce electric waves it is necessary to discharge static electricity from the oscillator by the oppositely located metal conductors *F*, separated by a spark gap at *K*. The oscillator is charged by the current from the induction coil when the circuit is closed at *C*. When sparking takes place between the metal spheres *E*, the opposite sides of the oscillator discharge into each other, thus equalizing their difference of potential. When sparking occurs, electric waves are produced which are propagated through space. As soon as a series of sparks have been emitted, the oscillator must be recharged before another set of sparks and waves

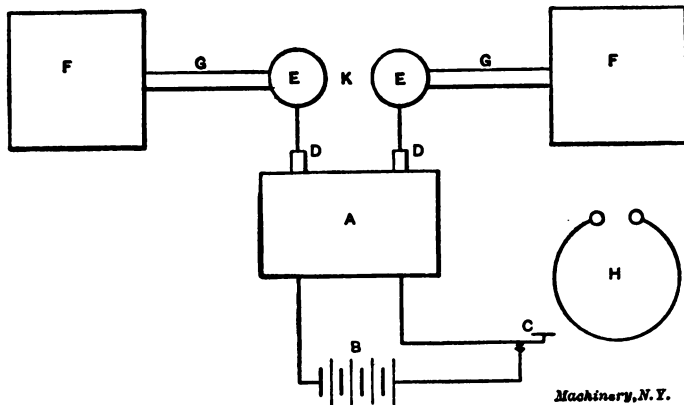

Fig. 11. Main Features of Hertz Apparatus

can be produced. The charging of the oscillator is done automatically through the induction coil connections. As soon as the oscillator has been discharged through the spark gap, the high tension current from the induction coil immediately recharges the oscillator to its maximum capacity, and the cycle of operation is repeated.

When the apparatus is operated, that is, when the circuit is closed at *C*, thus charging the oscillator, the presence of electric waves can be shown by the resonator already mentioned. When the electric waves impinge upon this resonator, the passage of a small spark across the air gap between the small knobs indicates the presence of electric waves. The simple apparatus described contains the primary and necessary elements of a wireless telegraph outfit. Improvements were made upon this apparatus by Branly, of Paris, who found in 1890 that metal filings enclosed in a tube were extremely sensitive to the pres-

17—PRINCIPLES OF ELECTRICITY

electric waves, and based the construction of the coherer
 "detector" (which will be described in detail later) on this
 instrument was further improved upon by Popoff, a Russian

The principle of the Popoff apparatus is shown in Fig. 12. At *A* is
 a coherer or wave detector and an electric bell, the hammer *B*
 of which serves the purpose of tapping the wave detector after it has
 been influenced by the electric waves, thus neutralizing it so that it
 can again be ready to fill its purpose when the next signal is received.
 A sensitive relay is placed at *C* and a local battery at *D*. It will be
 seen that one of the terminals of the coherer is connected to a metal
 rod *E* which extends into the air, while the other terminal is con-
 nected at *F* with the earth. This apparatus contains all the elements
 of the wireless telegraph receiver.

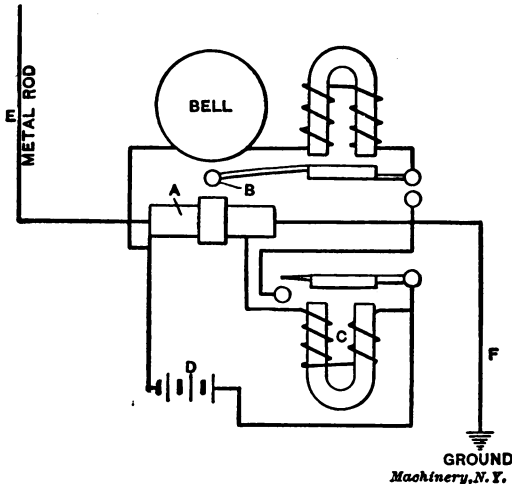

Fig. 12. Principal Features of the Popoff Apparatus

Finally Marconi in 1895 began experiments with the apparatus thus far developed, with a view to long-distance transmission of messages. He attained a considerable degree of success, so that in 1897 wireless telegraphy might be said to have entered upon its commercial stage. Since that time many improvements have been made by a great number of scientists and practical inventors. These improvements, however, have introduced no new principles, but merely have been concentrated upon eliminating such defects as were apparent in the earlier efforts. With due respect for all the workers who have aided in developing wireless telegraphy to its present day state, however, the honor of the most important scientific discovery is due to Hertz, and the credit for the development of his idea in a practical manner, making commercial application possible, belongs to Marconi.

The principal advantage of the Marconi system, as compared with those that had been previously devised was that in his transmitter he

connected one end of the oscillator to a wire suspended in the air, and the opposite end of the oscillator to the earth, as indicated in Fig. 13. He found that in doing so the electric energy was radiated in the form of electric waves over much greater areas than was possible when using an oscillator of the Hertz type. The receiver of the Marconi system also had one of the connections extending into the air and one leading to the ground, the same as already shown in Fig. 12, illustrating the Popoff instrument.

Fundamental Principles of Wireless Telegraphy

The fundamental principles of wireless telegraphy may be summed up as follows: The transmission of messages is accomplished over long distances by the projection of electric waves through space. These

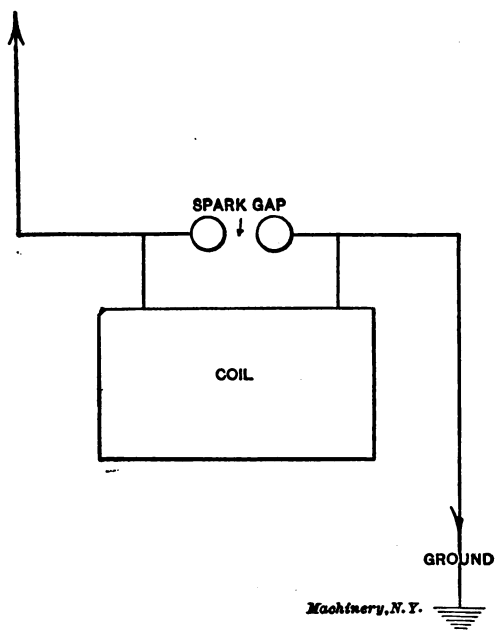

Fig. 13. Arrangement of Marconi Oscillator

electric waves are produced between the discharge knobs of an induction coil. The principle of electric magnetic induction is employed in creating the high pressure or voltage required for this apparatus. The waves sent out may in many respects be likened to the sending out of a powerful beam of light from a search lamp of great capacity. The waves projected from the electrical apparatus in this case, however, are not visible. They are transmitted through the ether, a substance of which practically nothing is known, but the existence of which is acknowledged because through it all energy is transmitted. In this respect it is of particular interest to electricians, because it seems particularly adapted for carrying electrical energy. The electric waves thus sent out are received by an apparatus consisting of a coherer, or

wave detector, a relay, and a sounder or writing apparatus, the latter of which details are constructed practically on the same lines as the ordinary mechanism for receiving telegraphic messages transmitted by wire.

A mistaken conception seems to exist regarding the employment of electric waves for signalling purposes in wireless telegraphy. It should be understood that the electric wave itself does not give the direct signal. This is impossible on account of the exceptionally delicate nature of the electrical manifestations of the electric wave at the receiving station. For this reason a device is added to the devices in use for ordinary telegraphy in the form of an electric wave detector or coherer. The function of the electric wave is simply to act as a primary means for setting into operation the apparatus which gives the actual signals through the aid of a more powerful current than that transmitted through the ether. In a sense, the wave-detector may be considered as filling the same function with relation to the relay of the wireless receiving station, as the relay itself fills with relation to the sounder in the ordinary telegraph station.

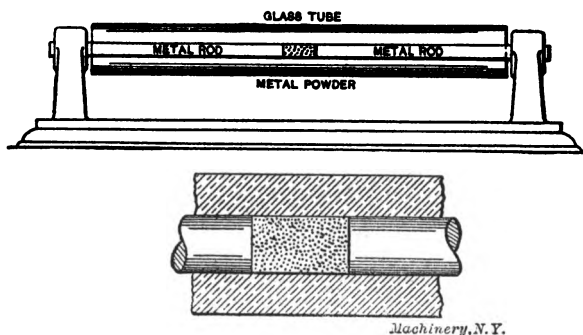

Fig. 14. General Arrangement of Coherer

The coherer generally consists of a tube of glass with a metal plug at each end, as indicated in Fig. 14. A small amount of metallic powder or filings is enclosed between the plugs. The theory upon which the application of this device is based is that the conductivity of finely granulated conducting substances is very high under certain conditions. Referring to this S. P. Thompson says: "The conduction of powdered metals is remarkable. A loose heap of filings scarcely conducts at all, owing to the want of cohesion, or to the existence of films of air or dust, but it becomes instantly a good conductor if an electric spark is allowed to occur anywhere within a few yards of it. The resisting films of air are broken down by minute internal discharges in the mass. A very slight agitation by tapping at once makes the powder non-conductive."

This condition has been made use of for producing one of the most important parts of the wireless telegraph outfit. A small amount of metallic powder, usually nickel with a touch of silver, is contained

within a small glass tube with metal pins at the ends, as mentioned. The device is placed in series with a few cells of battery and a telegraphic relay. The coherer will not operate under normal conditions, but the presence of electric waves sets it immediately into action. The electric waves impinge upon the metallic filings producing between them minute sparks. Over the paths thus provided the battery current instantly passes and actuates the relay. The relay then in turn operates the sounder, and thus a signal is transmitted through the air without the aid of a transmitting wire.

The current would continue to flow and the relay would remain in action if some means were not provided by means of which the metallic powder in the coherer is disarranged so as to cease to act as a conductor. This process is called de-cohering, and consists simply of tapping the coherer after the receipt of a signal so as to make the metallic powder non-conductive. This tapping is done automatically by means of a small vibrating hammer similar to that used in an electric bell. In fact, a small bell without the gong will perform this function satisfac-

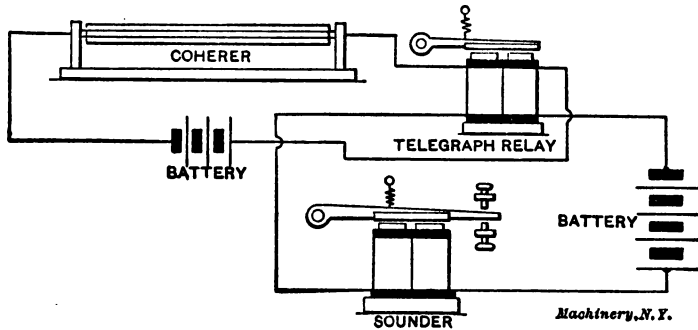

Fig. 15. Arrangement of Receiving End

torily if so connected that its hammer just touches the glass tube of the coherer. In Fig. 15 is shown a diagrammatical view of the receiving end of a wireless telegraph outfit. The coherer, the telegraph relay, the sounder, and the two sets of batteries, are clearly indicated.

A diagrammatical sketch of the apparatus for producing the waves is shown in Fig. 16. This apparatus consists primarily of a spark or induction coil. The spark coil is made up of primary and secondary windings as shown, and provided with a vibrator by means of which the current in the primary coil is interrupted, and a condenser. The primary coil receives the electrical energy and transforms it into magnetic energy. The vibrator interrupts the current entering the primary coil, thus permitting induction to take place between it and the secondary coil. The secondary coil has magnetic energy induced in it by the primary and transformed into a high-pressure current. A condenser is used as shown, made in the customary manner of tin-foil and paraffine paper. It is placed in the break of the vibrator for the purpose of taking up the energy that would otherwise be wasted in self-induction.

When the spark coil is set into operation, what might be termed a torrent of sparks passes between the discharge knobs. The size of the knobs, the gap between them and the dimensions of the coil determine the reaching power of the waves. When a signal is to be sent the sparks are allowed to pass between the knobs by closing a switch. Then at the receiving end the coherer is affected by the waves propagated. The signals sent are either long or short, representing dashes and dots the same as in the regular Morse code, the sounder or ink-writer ultimately delivering the message. To receive the waves towers or metallic poles are employed. These are usually called antennae. The coherer is attached to the top of these and is, therefore, made more readily sensitive to the electric vibrations in the ether.

The devices described above constitute the very first and simplest types of wireless telegraph outfits. Of course, the wireless telegraph is constantly being improved upon, and a number of features have been introduced which were not used in the first apparatus. The principles, however, are more clearly exhibited in this apparatus, and for the elementary purpose of this treatise it would not be advisable to con-

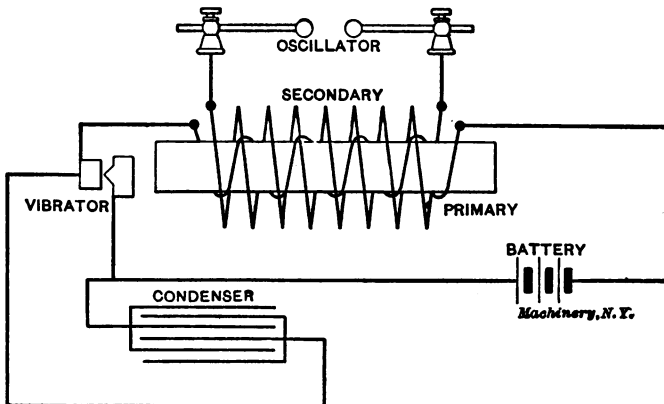

Fig. 16. Wave Producing Apparatus

fuse the subject by introducing descriptions of the many different systems that have been proposed and introduced from time to time. Among the most successful systems containing improvements on the original Marconi system may, however, be mentioned Oliver Lodge system, the Slaby-Arco system, the Braun-Siemens system, the Fessenden system, the American De Forest system, the Branly-Popp system, the Lodge-Muirhead system, and the Bull system.

Having described the principal features and action of the wireless telegraph system it may not be out of place to describe more in detail some of the more important parts of the sending and receiving apparatus.

The Induction Coil

The purpose of the induction coil is to receive a low-voltage direct current and transform it into a high-voltage current. The induction

WIRJ

coil is made up of an iron core
of soft iron. Around the core
called the primary winding is
directly with the secondary winding
while at the other end of the
ranged for auto transformer
in turn is connected to the
dynamo. A vibrator in
closed the primary winding
open the secondary winding
16.) The secondary winding is
insulated from the primary
wire. The secondary winding
oscillates. When the
interrupter is closed the
coil. The secondary winding
eral transformer. The
interconnected with the
the secondary winding
freq. The secondary winding
of the secondary winding
sec. The secondary winding
tr. The secondary winding
c. The secondary winding
,

ELECTRICITY

per cent of nickel and 10
termed the auto-coherer,
ing to return it to its
the action of electric
to their non-con-
previous chapter
for long-distance

coherer to
y electric
as rapid.
e stroke

receiver

CHAPTER III

THE TELEPHONE

The transmission of speech by electricity is one of the most interesting exhibitions of the law of the conservation of energy. The common popular idea that the sound produced at one end of the telephone circuit actually travels over that circuit in order to be heard at the other end is, of course, erroneous. In fact, the actual sound produced at one end of a telephone circuit travels no farther than it would if the telephone apparatus were not present, but the energy produced by the sound is changed or transformed in the telephone apparatus into electrical energy which travels over the wire and which again is re-transformed by the apparatus at the other end of the line into sound. When speaking, a series of vibrations in the vocal chords create sound waves or, rather, air waves, which represent the energy that is to be transformed into electrical energy in order to permit of transmission over a long distance. The actual telephoning, hence, consists of three processes, first, the directing of the voice into a sending instrument, second, the conducting of the voice equivalent transformed into electrical energy over the line, and, third, the receiving of the voice equivalent in the form of electrical energy and transforming it into sound energy at the end of the line. The sending instrument is called the transmitter, the conducting circuit or wire is called the line, and the instrument which changes the electrical energy into sound at the further end of the line is called the receiver, these names indicating clearly the functions of the various devices. It is the object of the present chapter to describe the apparatus by means of which the transmission of speech by electricity is accomplished.

Historical

In 1868 Philip Reis, of Friedrichsdorf, Germany, invented the first apparatus by means of which sound could be transmitted to a distant point by the aid of the electric current. The name telephone was given to this apparatus by the inventor. His invention, however, was not of so practical a nature as to become commercially useful. In 1876 patent specifications were filed simultaneously at Washington by Alexander Graham Bell and Elisha Gray, for a speaking telephone, and in February, 1876, a patent was granted to Bell. The question of the priority of the two inventors caused litigation which ended in a compromise, consisting in the forming of a company which brought out the inventions of both the inventors. The invention of the telephone, however, is generally credited to Bell, and apparently justly so, both from a legal and a scientific point of view.

Principle of Transmission of Sound by the Telephone

As already mentioned, when sound is produced, vibrations are set up in the air. The simplest kind of vibration, and one the nature of

which is most easily understood, from the fact that it is most commonly produced by the vibrations of a metal string, is that of a musical tone. As an example, it may be mentioned that the musical tone known as middle C is produced by 256 vibrations per second. The vibrations produced by the human voice are much more complicated in their nature than those of a musical instrument, and due to this fact, the very earliest attempts for transmitting sound by means of a telephone apparatus were capable of reproducing musical tones, but could not transmit and reproduce the sounds of the human voice.

The simplest form of telephone, the form, in fact, in which the original invention of Bell was founded, is illustrated diagrammatically in Fig. 17. In this simple type, the principle of transmission depends exclusively upon electromagnetic induction. The instruments at each end of the circuit are the same, so that in this case there is no difference in construction between transmitter and receiver. Assume, however, for purposes of explanation that *A* is the transmitter and *B* the receiver. At *C* and *D* are shown two permanent bar magnets, wound on their ends with a number of coils of fine insulated copper wire, as shown at *E* and *F*. At *G* and *H* are shown elastic disks made of very thin sheet iron. These disks vibrate when

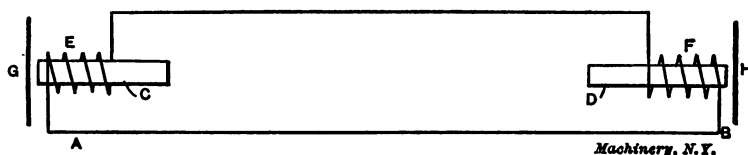

Fig. 17. Principle of Simplest Form of Telephone

sound or air waves strike them, due to the voice being directed into the instrument holding them. These disks are commonly known as the diaphragms.

Now assume that sound is to be transmitted from *A* to *B*. The permanent magnet *C* sets up a magnetic field or lines of force, and as the diaphragm *G* offers a path for these lines of force having less resistance than the surrounding air, a great number of the lines of force will pass through it. Now when the voice is directed against the diaphragm *G*, the vibrations in the air will cause the thin sheet steel disk to vibrate. When the disk during its vibrations comes closer to the end of the magnet, a greater number of lines of force pass through it, and when it recedes from the magnet, a smaller number of lines will pass through it. By means of this action a less or greater number of lines of force will pass through the coil *E*, and due to this, an alternating current will be induced in it, the strength of which will be proportional to the rate of change in the number of lines of force. The alternating currents produced in coil *E* pass through the line to the coil *F* wound around the magnet *D*, at the receiving end *B* of the line. Due to electromagnetic action, the currents set up will either add to or subtract from the original strength

of the magnet *D*. When they add to the strength of the magnet, the diaphragm *H* will evidently be attracted, and when they subtract from or decrease the strength of the magnet, the diaphragm moves away. It is obvious that on account of this action the diaphragm *H* will be caused to vibrate exactly in accord with the diaphragm at the transmitting end *A*, and as in this manner similar vibrations are set up in the air, the sounds producing the vibrations at the transmitting end will be reproduced by the diaphragm at the receiving end, although not with the same strength.

The simple arrangement described has been somewhat modified in the modern commercial telephone. The principal differences are that there is a special transmitter at each end of the line, separate from

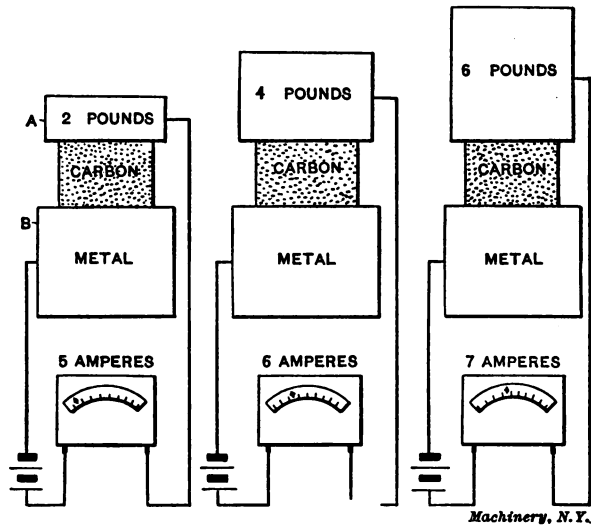

Fig. 18. Diagrammatical Illustration of the Effect of Pressure on the Resistance of Carbon

the receiver, and that this transmitter is constructed on a principle entirely different from the receiver. The principle of the modern receiver, however, is essentially the same as that explained above.

The Telephone Transmitter

In a telephone based on the simple principles just outlined, where the same instrument is used for transmitter and receiver, and the whole action is due to electromagnetic induction, the strength of the current for lines of even moderate length is so diminished, due to the line resistance, that satisfactory results are not obtainable. For this reason it was found necessary to devise an instrument which would vary the current in exact accord with the sound waves and which current could, through the means of an induction coil, induce such a current in the coil of the receiving telephone that the sound would be distinctly reproduced at the other end of the line. Edison, in 1877,

conceived the idea of utilizing carbon as an element in transmitter construction, basing his investigations along these lines upon the fact that the resistance of carbon to the flow of electric current depends upon the mechanical pressure exerted upon the carbon.

The effect of pressure on the electric resistance of carbon is diagrammatically illustrated in Fig. 18, where an electric circuit is shown connected to two metal blocks separated by a piece of carbon. The metal block on the top exerts a different pressure on the carbon in the three instances shown, and as the electric resistance decreases with increasing pressure, a current of different strength will flow through the line in each case. The action of the telephone transmitter or microphone depends upon the same fact: if the resistance of the circuit is increased, the current will decrease, and if the resistance is decreased, the current will increase, the variations in resistance being produced by varying the pressure on the carbon placed between the electrodes, that is, the terminals or parts to which the ends of the electric current carrying wire are connected, as *A* and *B* in Fig. 18. On this basis three different types of transmitters have been constructed. In one type only one carbon contact is employed for varying the resistance; in another type a number of contacts are used; and in a third type granulated carbon is employed, thus producing a very large number of individual contacts.

The Blake Transmitter

In Fig. 19 is shown a diagrammatical section of the Blake telephone transmitter, which is an example of the type of transmitter using a single carbon contact for varying the resistance. In this device the diaphragm is shown at *A*. This diaphragm is similar to that used in the receiver in the original type of telephone. All transmitters, of whatever type, use a diaphragm of practically the same kind. *B* and *C* are two flat springs, and *D* is a piece of carbon, usually called a carbon button, which rests in holder *E*. The diaphragm *A* is supported by a rubber ring. It is held in place by two springs called damping springs, which are not shown in the illustration. The object of these springs is to check the vibrations of the diaphragm as soon as the vibrations have filled their purpose of producing undulations in the electric current. On the spring *B* is mounted one of the electrodes, in this case a platinum pin. One end of this pin rests against the center of the diaphragm, and the other end rests against the carbon button *D*, which forms the other electrode, and which together with its holder *E* is mounted on spring *C*. The springs are so adjusted that the carbon button bears lightly against the end of the platinum pin. The spring *B* acts in the direction of spring *C*, that is, it has a tendency of pulling the platinum pin away from the diaphragm, but this tendency is counteracted by spring *C*, which is stronger, and which exerts a force in the opposite direction and thus keeps the platinum pin in contact with both the diaphragm and the carbon button.

Being mounted on springs, it is evident that both the electrodes

can move freely when the diaphragm vibrates. The carbon button, however, being mounted on a stiffer spring and being held in a comparatively heavy socket, cannot respond as quickly to the vibrations as does the platinum pin mounted on a very sensitive spring. Vibrations in the diaphragm, therefore, produce a variation in the pressure between the platinum pin and the carbon button, thus varying the resistance at the point of contact and permitting a current of varying strength to pass through. The two springs *B* and *C* are insulated from each other, so that the current is led into the platinum electrode by the one and from the carbon electrode by the other. The ends of the springs, of course, are connected to the wires passing through the batteries which furnish the current, and around the induction coil where the current passing through the line, and to the receiving end,

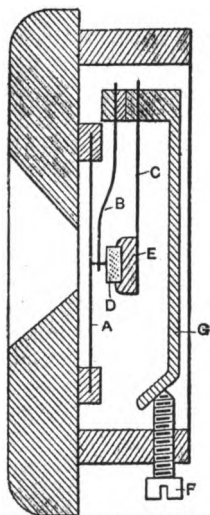

Fig. 19. The Blake Transmitter

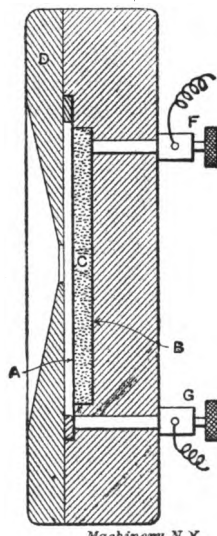

Fig. 20. The Hunnings Transmitter

is induced, as will be described later. The mechanical pressure between the platinum pin and the carbon button can be adjusted by means of screw *F*, which bears against the bent-up end of a lever *G*.

The Blake transmitter is used to some extent at the present time and works fairly satisfactorily on lines of moderate length. Its disadvantages are that it is difficult to keep in adjustment, and that it is not adapted for long-distance work, because of not being sensitive enough. The type of transmitter mentioned above which uses several carbon button contacts is not used very much, and is, therefore, of no specific interest. The third form employing granulated carbon, however, is rapidly replacing the other types and must be accorded an extended description.

The Hunnings Transmitter

A diagrammatical section of the Hunnings transmitter is shown in Fig. 20. In its simplest form this transmitter consists of two insu-

lated plates *A* and *B* of conducting material, these plates forming the electrodes of the transmitter and having a space between them which is filled with granular carbon as shown at *C*. The plate *A* serves also as the diaphragm, and is clamped between the body of the transmitter and the cap *D*. The two electrodes are connected to the wires of the battery circuit by binding posts *F* and *G*, as indicated. When sound waves impinge upon the diaphragm, vibrations are set up, and the pressure upon the great number of contact points between the granular carbon and the metal plates causes a current of varying strength to flow from one electrode to the other. A greater variation of resistance is produced in this type of transmitter than in the Blake transmitter previously described, and heavier currents can also be used.

Improvements have been made on this transmitter, but the improved types work on the same principle as that described, the improvements being merely in details. The Hunnings transmitter operates in a satisfactory manner over long distances. The only disadvantage with granular carbon transmitters is that there is a decided tendency on the part of the granular carbon to pack together. The packing in transmitters is due to the expansion of the carbon granules by the heat generated by the current and also by the heat of the breath of the user of the instrument. It is evident that if the granules have no space in which to expand, and particularly if the expansion of other parts as well tends to decrease the space in which they are contained, then they will pack solidly together. When in this condition the sensitiveness of the device is seriously impaired. In fact, when the carbon becomes solidly packed together the transmitter is useless for its purpose. This packing can be overcome by striking the side of the transmitter a sharp blow by the hand, but this practice cannot be recommended, because, as one authority on this subject says: "The lands of the layman are not conducive to the longevity of the instrument."

In modern transmitters the tendency to packing is, therefore, reduced to a minimum by the design of the device itself, the "solid back" transmitter being devised for this purpose. The principle by means of which packing is prevented in this instrument is as follows: An annular space is provided between the periphery of the electrodes and the inside surface of the chamber in which the electrodes are contained. A certain number of the carbon granules are contained in this annular space, but it is not quite filled to its full capacity. The granules in the annular space are not heated when the current passes, and hence do not expand. When the granules which are located directly between the electrodes become overheated, they can expand into the annular portion, hence preventing packing between the electrodes. The transmitters used at the present time are nearly all made according to the principles outlined for the solid back type of transmitter.

The Receiver

The telephone receiver, of practically the same type as the one now used, except for improvements in details, was first exhibited publicly

at the Centennial Exposition in Philadelphia in 1876 by Alexander Graham Bell. As already mentioned, speech can be both transmitted and received by this instrument, but it is not satisfactory when used as a transmitter. The essential parts of the receiver are a magnetized steel bar, a coil of fine copper wire, and a diaphragm of thin sheet steel. Two forms of receivers are in common use, one being termed a single-pole and the other the bi-polar type.

The single-pole type is represented by the Bell type of receiver shown in Fig. 21. The outer casing of the receiver is made of hard rubber, so as to be thoroughly insulating. Inside of this casing is placed a laminated bar magnet *A*. At one end of the magnet is a pole piece of soft iron *B* and at the other end a block *C*. On the pole piece *B* is placed a coil *D* of fine insulated copper wire, which is connected with the line through wires *F* leading to the binding posts *G* at the end of the receiver. On the other end of the receiver is a cap *H* which supports the diaphragm of the instrument; as indicated, this is placed immediately in front of the pole piece of the magnet so that the part of it which is opposite the pole piece is free to vibrate. The coil *D*

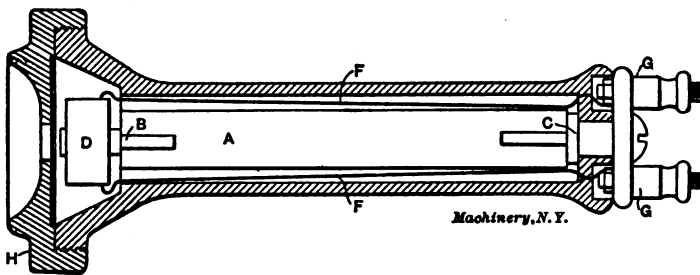

Fig. 21. Single-pole Type Receiver

on the pole piece at the front end of the receiver is made of a great many turns so as to be sensitive to the slightest change in the current passing through it.

When the induced current in the line passes through the coil, it increases or decreases the magnetism of the bar magnet as already described in the first part of this chapter, thus producing vibrations in the diaphragm on account of the greater or less force by means of which the diaphragm is attracted to the magnet, the result of it all being the duplication of the sounds of the voice entering the transmitter at the other end. The whole telephone system has been likened to an electric power transmission plant. At the transmitting end the mechanical energy in the form of air vibrations is absorbed and transformed into electrical energy. This electrical energy is conducted to another point and finally there retransformed into mechanical energy. Of course, with the transmitter of the modern type, the primary current is supplied by a battery and not produced directly by the energy of the impinging air waves.

The single-pole receiver is at the present time being more and more replaced by the bi-polar receiver, which does not differ from the other

in principle, but simply in the fact that the permanent magnet of the receiver instead of being straight is constructed as a horse-shoe magnet. In this way both poles of the magnet are placed in a position where they can act on the diaphragm, thus increasing the strength of the magnetic field and consequently producing an instrument which is more sensitive and efficient. A pole piece of soft iron is fastened to each end of the horse-shoe magnet and a coil of insulated copper wire is placed on each pole piece. The bi-polar receiver is always used in long-distance telephone systems, and to a considerable extent for local systems.

The Induction Coil

The success of the telephone system depends upon the employment of the induction coil, by means of which the voltage of the out-going current is raised above that of the transmitter, and its character changed from that of a direct-current into an alternating wave of electricity. The transmitter is mounted in series with a local circuit, containing a battery, and passing around the induction coil as the primary winding. The receiver is placed in the circuit containing the line, and the fine wire secondary winding of the induction coil. The principle of the action of the induction coil was described in the previous chapter: two coils are mounted on a soft iron core; one of the coils carries the current which is produced by the local battery and passes through the transmitter; the current in the other coil results from the pulsating movement of the current in the first coil.

The principle of the induction coil in telephony was first introduced by Elisha Gray, the object being to avoid the necessity of using too powerful a current in the transmitter. In this way the transmitter can be used in series with a low-pressure current, produced either by a battery or obtained from a storage battery charged by a dynamo. As the current which proves most satisfactory in the receiver is an alternating current, the use of the induction coil fills the requirements very satisfactorily, because by means of the induction coil the direct current of the primary circuit containing the transmitter is changed into an alternating current. The ordinary induction coil for telephone use consists of 200 turns of No. 20 Brown & Sharpe gage wire, wound in two layers around the core. This wire constitutes the primary coil, and around this is wound the secondary coil, which consists of about 1,500 turns of No. 34 Brown & Sharpe gage wire, also wound in a double layer. By this means the electromotive force of the induced current in the line is raised to a considerable height, so that the resistances are more easily overcome and the effect in the receiver becomes great enough to distinctly reproduce the speech.

The Complete Telephone Circuit

Having described the various instruments used for a telephone system of a simple type, we are now ready to examine the condition of a complete telephone circuit. A diagrammatical view of a complete circuit is shown in Fig. 22, where the various elements are indicated in a manner making it easy to trace the different circuits. The cir-

cuits consist of a transmitter and receiver at the end of each line, the transmitters being in a local circuit supplied with current from batteries *A*, while the receivers are on the line circuit, the current of which is produced entirely by induction in the induction coils *B* and

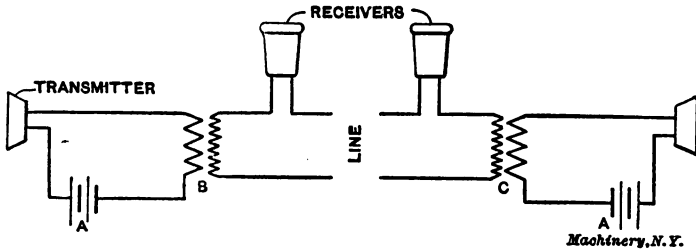

Fig. 22. Diagrammatic View of Complete Telephone Circuit

C. From what has previously been said about the construction and action of the various instruments making up the complete system, its action is easily understood without further explanation.

While, however, an arrangement such as shown will serve to transmit and receive messages, it would not make it possible to call the person or station one desires to speak to, and for this reason it is also necessary to equip the installation with some kind of a calling device. For this purpose the magneto-generator is ordinarily used. Although the telephone systems in large cities, for example in New York, dispense with the necessity of employing a magneto for ringing up a

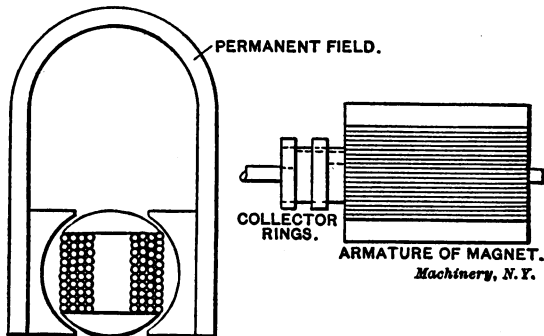

Fig. 23. Principle of Magneto-generator

subscriber, still the magneto call-bell is required for signalling from the exchange itself to a subscriber. In this case the subscriber signals "central" by merely lifting the receiver off the switch-hook, but "central" signals the desired number by ringing the subscriber's bell.

The magneto-generator usually consists of a generator having permanent field magnets and a small shuttle armature wound with many turns of fine copper wire (as shown diagrammatically in Fig. 23) and producing an alternating current. The armature of the magneto-generator can be rotated at a very high speed by means of a small

pinion mounted directly on the armature shaft, and meshing with a larger gear mounted on a shaft on which in turn the hand-crank for the operation of the instrument is placed. The magneto-generators used are constructed so as to ring through 1000, 5000, 10,000 or even 50,000 ohms of resistance. The magneto-generator is of exceptional importance and of great advantage in telephone service. It is of a

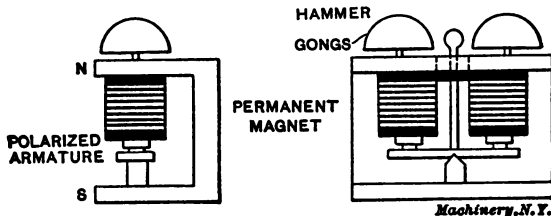

Fig. 24. Principle of Construction of the Call-bell

simple and cheap construction, it is always ready to produce an alternating current by a few turns of the handle, and is able to ring through high resistance with comparative ease. At exchange stations it is a common practice to use a magneto-generator driven by power. In some cases current for ringing purposes is supplied by an ordinary generator.

A diagrammatical view of the construction of the call-bell is shown in Fig. 24. The armature and cores are so situated in respect to

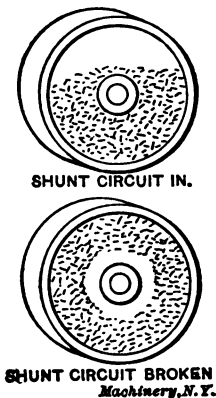

Fig. 25. Means used for Producing a Shunt Circuit

each other that when an alternating current passes through the coils of the magnets, the armature is alternately attracted and repelled rapidly; the bell hammer then strikes the two small gongs violently. The attractions and repulsions are the results of a permanent magnet being utilized to act both as a support for the magnet cores and as a pivot for the armature. The two cores are thus magnetized by one pole and the swinging armature by the other. It is obvious that an alternating current passing through the windings of the magnets will alternately weaken or strengthen their polarities, so as to cause the armature to oscillate rapidly between the poles and thus ring the bells by the hammer attached to it.

If the current entering the subscriber's call-bell from a distance had to traverse the winding of the magneto-armature it would be weakened to a point that would probably render it useless for ringing the bell. To avoid this difficulty, a shunt or side path for the current is supplied in cases where a hand-operated magneto is used for signalling. This shunt in its simplest form consists of a round box-like device attached to the shaft as shown in Fig. 25. It is partly filled with small pieces of metal which are normally at rest as shown in the upper

view, thus providing a path for the incoming current which cuts out the magneto. When the magneto handle is turned, however, the small metal pieces fly away through centrifugal force and thus break the shunt circuit otherwise formed by their being at rest and providing a contact with the shaft. When they are at rest the armature is, so to speak, short-circuited by them, but when they are thrown against the side of the box the magneto is restored to its normal condition and may be used for signalling.

The Switch-hook

One device which is part of the telephone apparatus remains to be described. The device representing the connecting link between the two important parts of the telephone system, namely the speaking and signalling circuits, is called the switch-hook, or, sometimes, the hook-switch. It is an automatic device by means of which the receiver, when in use, cuts out the signalling circuits, and when not in use, by resting on the hook, throws them into circuit again. The principle of action is shown in Figs. 27 and 28. When the weight of the receiver is placed on the switch, it is pulled downward so that

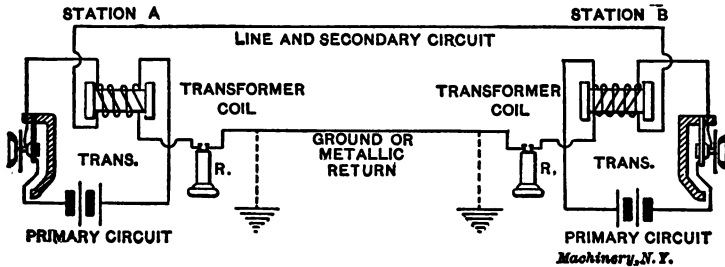

Fig. 26. Simple Two-station Telephone System

the speaking circuit composed of the battery, transformer and primary of the induction coil is cut out. When the receiver is removed, the switch-hook cuts out the circuit containing the magneto and call-bell, and produces contact with the remainder of the apparatus.

Simple Two-station Telephone System

In Fig. 26 is shown a simple two-station telephone system. In the illustration the line is shown as consisting of two metallic wires drawn with full lines, but the dotted lines indicate the possibility of grounding the ends of the circuit at each station so as to transmit the current over only one metallic circuit. The battery circuits at each end are local and operate independently of each other, and have no direct connection with the line. The battery must receive attention if its strength diminishes.

Complete Telephone Systems

Summarizing, it will now be understood that a complete telephone system consists of three distinct parts, a calling apparatus, a transmitting apparatus, and a receiving apparatus, each of these having a

complete electric circuit. The calling apparatus consists of the magneto-generator and the call-bell, the transmitting apparatus consists of the transmitter, the batteries and the primary winding of the induction coil, while the receiving apparatus and circuit consists of the secondary of the induction coil, the line and the receiver.

Distinction is made between two types of telephones, differing as to the details of the connections between these various fundamental constituents, the two types being known as the series telephone and the bridged telephone. A diagrammatical sketch showing the connections of a series telephone is shown in Fig. 27, and of the bridged telephone system in Fig. 28.

Series Telephone System

In the illustration Fig. 27, when the receiver is placed on the hook *A*, the switch is in the position shown, the magneto-generator *B* and the call-bell *C* being connected in series with the line through the contact at *D*. The magneto-generator is automatically cut out by the method just described. If the receiver is now removed from the hook, then, due to the action of a spring, the left-hand end moves upward and the right-hand end moves down, and the contact at *D* is broken, while a contact is made at *E* and *F*. The primary circuit containing the battery and transmitter is then closed, and the secondary circuit containing the receiver and the induction coil is connected to the line, *G* and *H* being the line terminals. This type of telephone is used only where not more than two telephones are connected on a line.

The reason why the series telephone cannot be used if several telephones are connected on a line is that with series telephones ringers of from about 80 to 120 ohms resistance are used, and on account of this comparatively low resistance, it would be impossible to ring a number of the call-bells in multiple. In addition, since all the bells would be constantly in the circuit, it would interfere with the use of the instruments.

Bridged Telephone System

In Fig. 28 the call-bell is permanently bridged across the line, and the magneto-generator is also bridged, the circuit through it being open when it is not in use, and automatically closed when operated, as already described. In this system, when the receiver is lifted from its hook, a contact is produced at *A* and *B* for the primary and secondary circuits, the same as in the series telephone. The advantage of this system, however, is that the call-bell does not interfere with the action of the receiving circuit, since in this case the call-bells have a resistance of about 1600 ohms, and are wound so that their self-induction is large. With this system several telephones can be bridged upon one circuit.

Three methods are in use for constructing lines, these being the ground circuit, the metallic circuit, and the common return. In the grounded circuit but one wire is used, the other terminals being connected to the ground. In the metallic circuit two wires are used, one

for the incoming current and one for the return. In the common return, the circuit is completed through a common copper wire, thus differentiating it from the metallic circuit where each separate circuit has a return of its own.

The telephone systems in vogue may also be classified in three general divisions, as follows:

1. The party line and intercommunicating system.
2. The central station, or central exchange system.
3. The automatic central station system, or automatic exchange.

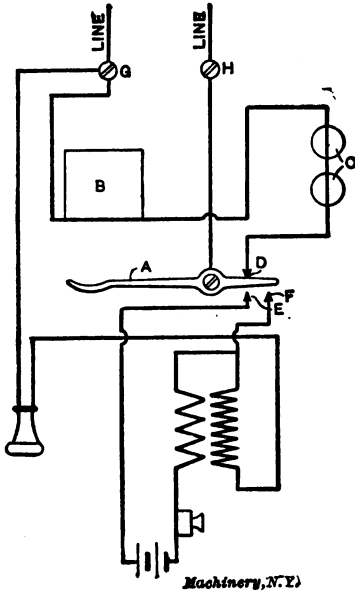

Fig. 27. Series Telephone System

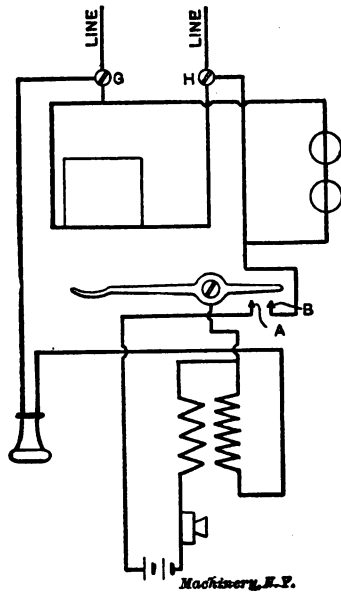

Fig. 28. Bridged Telephone System

The intercommunicating system is of great service where the number of telephones is not too great. It finds its best application in hotels, factories and houses employing many telephones. By this system of telephoning, any one in the system may be reached and spoken to readily, this object being generally accomplished by means of a specially constructed switch. The party line or common circuit system is open to objections, among which the chief one might be regarded as lack of privacy. The central station system is by far the most important.

The Central Station and Its Switchboard

Where more than 20 or 30 subscribers are dependent upon a telephone system for business or social purposes, any other than a system employing a switchboard is out of the question. In detail it consists of an apparatus so equipped that two subscribers may be readily placed in communication with each other when one "rings up" and

asks for the other. This apparently simple requirement is accomplished by means of a switchboard, whose devices are adapted to this purpose, and whose functions may be classified under the following heads:

1. For notifying "central": Drops are employed.
2. For connecting subscribers: Spring jacks are used.
3. For line terminals of subscribers: Plugs with flexible cords are used.
4. For listening and ringing up subscribers: Keys or switches are used.

The switchboard is so constructed that the operator or "central" can readily see and manipulate at the same time. The drops occupy the upper portion of the switchboard, as indicated in the diagrammatical sketch, Fig. 29, and may run up in numbers corresponding to the number of subscribers' wires. Beneath these drops are the spring jacks, then on the horizontal portion of the switchboard are the plugs and keys, as indicated.

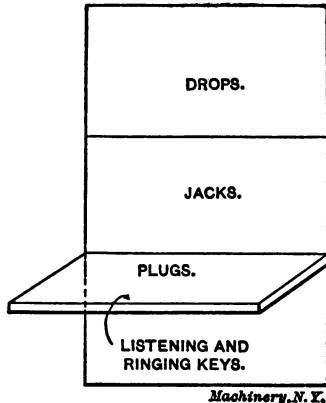

Fig. 29. General Arrangement of Switchboard
Machinery, N. Y.

The switchboards in use for city subscribers are necessarily very large and complicated. The smaller type of switchboard, serviceable for 50, 100, 200 or 300 subscribers, would not be satisfactory to cope with a system having subscribers running into the thousands. Confusion and consequent delay would be the certain cause of failure. The operators are therefore given a certain number of subscribers apiece to take care of, with the means as well, in the switchboard construction, of connecting them to any other subscriber who is attached to the same board. Thus the labor is subdivided without any resulting delay

or confusion, and each operator only takes care of 100 or 200 subscribers.

Now, when a number of small switchboards were employed, and an operator with such a switchboard desired to connect a subscriber to another on a switchboard at the other end of the room, difficulty would naturally result if no special means were provided for this contingency. To obviate this the subscribers are grouped into sections, and their lines brought to one large multiple switchboard, in which not only are the subscribers' lines in each section of easy access to the operator, but the connection permits the operators to connect the subscribers of the section in their individual charge to any other on the switchboard. This arrangement is shown in principle in Fig. 30, where the employment of local jacks simplifies the proposition. Here the jacks of all subscribers on the multiple board are found in each section of the board. Each operator can therefore connect a sub-

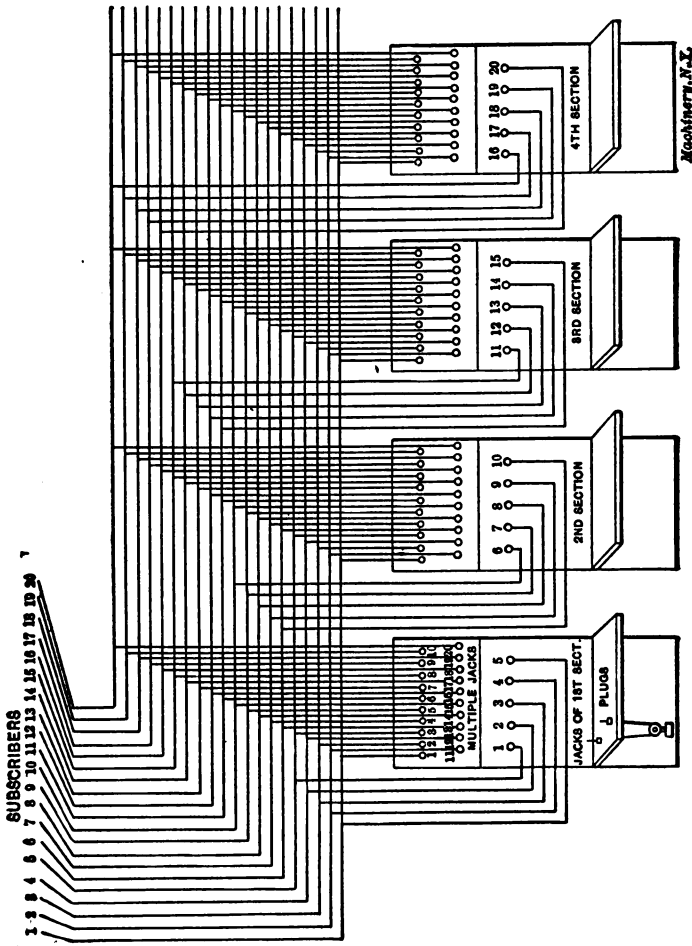

Fig. 30. Arrangement of a Multiple Switchboard

scriber with the utmost readiness with whosoever they may desire. In a multiple board, consisting of four sections of five subscribers each, if the operator in charge of section No. 1 ranges from 1 to 5, and No. 2 from 6 to 10, then they can manipulate as follows:

- Operator No. 1 from 1 to 5, and to any one from 1 to 20.
- Operator No. 2 from 6 to 10, and to any one from 1 to 20.
- Operator No. 3 from 11 to 15, and to any one from 1 to 20.
- Operator No. 4 from 16 to 20, and to any one from 1 to 20.

A study of the diagram will show the meaning of this important principle in multiple switchboards.

CHAPTER IV

WIRELESS TELEPHONY

The name of wireless telephony is given to that system for the transmission of intelligence in which the human voice is transmitted, without a visible conductor, by means of electrical or ether waves, which are again transformed into audible speech. The waves are produced at one point, radiated, and received at another point. The electrical waves are noiseless, because they do not in any way affect the ear drum; but they can be transformed into air vibrations by means of suitable apparatus, and thus audible and intelligent speech be created, corresponding to the sounds that have produced certain conditions of the waves at the transmitting end.

The history of the invention of wireless telephony is one of the most interesting chapters in the history of invention. More than twenty years ago it was demonstrated that it was possible to transmit the sound of the voice by means of a flickering beam of light controlled by the sound waves of the human voice. But this method did not, of course, permit of the transmission of messages over very great distances, and the principle of wireless telephony as applied to-day is entirely different. The origin of the present method of wireless telephony may be traced back to the arc-light method employed by Elihu Thomson for producing a very rapid series of electrical impulses. By this means Prof. Fessenden was able in 1902 to transmit speech without the means of transmitting wires.

The progress from that time up to the present moment has been rapid. In 1906 Fessenden was able with an apparatus reasonably simple, considering the object to be secured, to transmit speech over a distance of eleven miles. Later he has been using an alternating current dynamo having a frequency of from 50,000 to 80,000 cycles per second. With this machine as the source of electrical waves, wireless telephony has become possible over distances of several hundred miles. In this connection the experiments of Prof. Poulsen, a Danish inventor, should be mentioned. He has achieved considerable success along the lines of wireless telephony. Other inventors which may be mentioned are Majorana, of Italy, and De Forest, an American.

High-frequency Waves Used in Wireless Telephony

The primary requirement in wireless telephony is to produce electric waves having a very high frequency, that is, moving through space at very short intervals. The simplest method by means of which waves can be produced is by means of an alternating current dynamo so constructed that it creates 100,000 alternations per second, more or less. This wave action may be considered as a kind of background on which the specific waves, due to the sound, are impressed. This background

is called the wave train. There are three methods of producing electric waves or wave trains of high frequency. They are as follows:

1.—The spark-break method, in which a circuit containing capacity, inductance and resistance is used for producing a series of sparks and consequent waves. Any circuit consisting of a condenser, resistance and induction coils and supplied with electrical energy at high pressure will produce electric waves by this method. It is, however, not considered a practical method for wireless telephony.

2.—An alternating current generator or some equivalent device, capable of producing 20,000, 50,000 or 100,000 cycles per second.

3.—The arc light as modified by capacity and inductance by Elihu Thomson in 1893, and W. Duddell in 1900. The latter discovered the properties of the so-called singing arc, produced by shunting a circuit having a condenser and inductance in it, as indicated at *B* and *C*, Fig. 31. High frequencies can be obtained in this manner at an estimated rate of 300,000 to 3,000,000 per second.

Each of these methods requires consideration in the construction of a practical wireless system. The main point to remember, however, is that there are two sets of waves utilized, one called the wave train, and produced by the means just mentioned, and a second set of waves that is impressed upon the wave train by the voice or sound waves to be transmitted.

Comparison Between Methods Used for Producing High Frequency

In the alternator used for producing a high frequency it is necessary to use from 200 to 300 magnetic poles on the machine, and the armature must be revolved at a very high rate of speed. The number of alternations of the current is directly depending upon the number of poles and the number of revolutions per minute, the number of alternations being the product of these two latter numbers. The difficulties of the method are, first, that the revolutions per minute of the armature are limited by the strength of the moving parts, as these would burst, due to the centrifugal force, if revolved at too high a rate of speed, and, second, that the magnetic poles must be placed very close together, which is unsatisfactory from an electrical point of view. On account of this, and also on account of the expense of machines of this type, the singing-arc method has been employed for producing the waves required.

In this method two solid conductors are used, one of carbon and one of copper, with a short gap filled with air or other gas between the conductors, as shown at *A*, Fig. 31. The electric resistance of the air gap varies the strength of current flowing through it, and on this depends the principle of the device. When cold, the resistance of the air space is very great, but when heated by the flow of the current across it, the resistance falls to a very low value, and a very small variation in the strength of the current will cause a corresponding change in the resistance opposing it in the space between the electrodes. The ends of the electrodes are connected to a system of conductors which determines the frequency of the electrical vibrations.

The action is in main as follows: When a direct current from a dynamo or a battery is sent through the air gap *A* as shown in Fig. 31, the electricity in the circuit attached to it commences to alternate at a rate controlled mainly by the condenser and resistance shown at *B* and *C*. Hence, we have here a simple method of obtaining alternating currents of high frequency by a direct current. In order that the variations of the resistance at *A* may be as sensitive as possible, it is important that the electrodes are cooled rapidly. In some devices the copper electrode is cooled by air or water, by means of special devices.

Conditions Governing the Use of an Arc

The conditions that must be established in the use of an arc are, according to Mr. Duddell, as follows:

- 1.—The arc must be supplied with a steady electromotive force, obtained from storage or primary cells, if a generator is not convenient.
- 2.—Solid carbons instead of cored must be employed.
- 3.—The induction coil employed must be of low resistance.
- 4.—The condenser must be constructed to stand high pressure without a breakdown, and also sudden variations in the amount of the charge.

By producing the arc in hydrogen gas or illuminating gas the waves thrown out per second are increased in number. An arc burning in air will produce 50,000 waves or alternations per second, while an arc burning in hydrogen will produce over 300,000 waves per second. The length of the arc is an item of considerable importance, as it bears upon the success or failure of the system. Too long an arc will not work, nor will too short an arc. There is a given length called the active length of the arc which must be adhered to in operating the system. If, when the arc is active, the waves become too rapid, then the arc must be shortened.

The Wireless Telephone System

It will now be understood that a wireless telephone system divides itself into three distinct parts, as follows:

- 1.—The apparatus producing the wave train.
- 2.—The apparatus used for transforming the voice vibrations into electrical waves impressed upon the wave train.
- 3.—The apparatus used for receiving the electrical wave equivalent of the voice and transforming it into speech.

The parts of the transmitting station (see Fig. 31) are as follows:

- The microphone transmitter circuit.
- The arc lamp or wave-producing circuit.
- The radiation or antenna circuit.

This indicates that the telephone transmitter is spoken into, which impresses this set of vibrations on the wave-producing circuit and by means of the antenna radiates the same into space.

The parts of the receiving station are as follows:

- The telephone receiver circuit.
- The wave detector.
- The aerial and tuning circuit.

The Transmitting Apparatus

In Fig. 31 is shown the transmitter or sending apparatus. At *E* is shown the transmitter of similar kind as the ordinary telephone transmitter, and connected in the local circuit containing a battery and the coils of a transformer, the battery being shown at *F*, and the transformer at *D*. By means of the transformer *D* the current in the local circuit passing through the transmitter controls the supply of current to the arc at *A*. At *B* is shown a condenser, and at *C* a coil of wire giving inductance as already mentioned. At *G* is a second transformer by means of which the generating circuit through *A*, *B* and *C* is con-

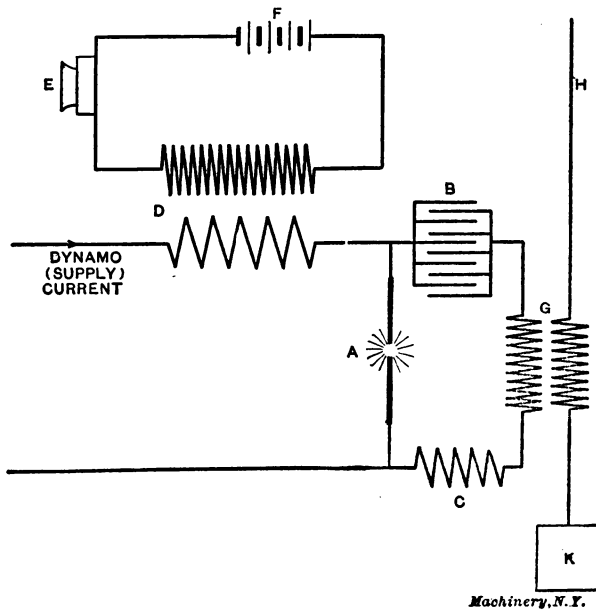

Fig. 31. Transmitter or Sending Apparatus

nected to the antenna *H* and the ground connection *K*. By this means the electric waves, as produced by the speaker's voice, are transmitted into space. The transmitter current of the local circuit influences by induction the supply current so that this current is increased or decreased in a manner corresponding to the sound waves impinged upon the diaphragm of the transmitter.

Several forms of aerial conductors, by means of which the current passes out from the instruments, have been devised. The best one is undoubtedly the fan-shaped aerial or antenna. The lower end of the aerial wire is led into the instrument room and there connected to one terminal of the current generating coil, while the other terminal is connected to a large metal plate sunk into the ground as shown at *K* in Fig. 31.

The current is actually conducted by the earth, so that the electrical resistance of the ground influences to a considerable extent the possibilities of wireless transmission. The resistance in the sea being low, the possible distance of transmission of wireless messages over water is much greater than over land, and it is also easier to transmit messages over moist soil than over dry soil. It has been found that the differences are very considerable, and that a station which can transmit speech over a distance of say fifty miles over dry land can transmit with equal ease the speech over 200 miles of water. It has also

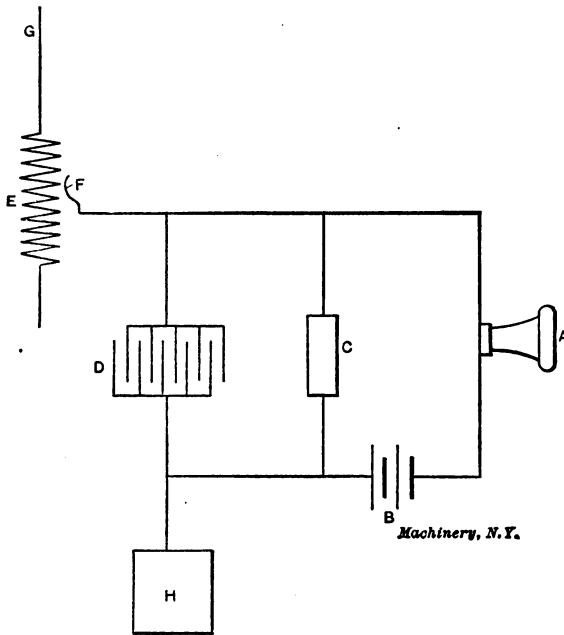

Fig. 32. Diagram of Receiving Apparatus

been found that conditions in the atmosphere account for curious differences in transmission by day and night. This was first discovered by Marconi.

Receiving Instruments

At the receiving end of a wireless telephone system there is an aerial conductor and earth connection similar to those at the sending station. In this case, however, the aerial conductor is connected to the receiving instrument the same as is also the ground connection. In practice, of course, there is a receiving instrument and a sending instrument at each end of the line, either of which can be connected to the aerial and ground connections, so that speech can be transmitted and received at each station.

A receiving apparatus is shown diagrammatically in Fig. 32. At *A* is shown the receiver, and at *B* a battery for producing the local current actuating the receiver. At *C* is shown a detector by means of which the local circuit is connected when the detector is impinged upon by the electric waves transmitted. At *D* is a condenser, and at *E* a coil with a sliding connection *F* which is used for "tuning" the circuit *G E D H* to the frequency of the transmitted current. *G* is the aerial conductor, and *H* is the earth connection.

In the receiving apparatus the alternating current of high frequency transmitted through the ether is transformed into a direct current, the strength of which is proportional to the average value of the alternating current. The direct current is then transformed into air vibrations and sound by means of the ordinary telephone receiver. The so-called tuning of the instrument permits of working several wireless stations at once within the same area of electric influence without interference. The object in view is accomplished by the arrangement of the stations in pairs, each of which works with a current having a different number of alternations per second than the other pairs. In a case of that kind each receiver will interpret such messages as are sent by its corresponding station, ignoring all others. The system, of course, is so arranged that the receiving apparatus can be quickly changed so that any one station can communicate with any other by tuning the instruments to correspond.

The detector employed in wireless telephony may be either of electrolytic or silicon type, or of any convenient form suitable to the purpose. Detectors may be generally classified as of the coherer type, the silicon type, the thermal, or the electrolytic type.

The coherer type consists of a tube of nickel and silver filings sensitive to the impact of ether waves of high or low frequency.

The silicon type consists merely of a piece of silicon in the detecting circuit, which is affected by and extremely sensitive to the ether waves.

In the thermal type, Prof. Fessenden uses a fine platinum wire 0.00006 inch in diameter to detect waves by their thermal effect. In the Collins system a thermo-detector is used for the waves, consisting of two wires mounted and crossing each other. They are of different metals and act most satisfactorily. The inventor claims a sensitiveness which detects and acts with power equal to 0.00002 of an erg.

The electrolytic type consists of a platinum wire dipped in vitric acid, sensitive to the ether waves by the variations in resistance due to the minute electro-chemical changes on the surface of the platinum wire.

General Considerations

There is an interesting law governing the amount of radiation from a wave producer. This law may be stated as follows: Radiation increases with the fourth power of the frequency. The table below indicates this relationship:

TABLE OF RADIATION

Distance	Frequency, or Waves per second	Radiation from Antennae
1	10,000	1
4	20,000	16
16	40,000	256
64	80,000	4096

In explanation of the table given it may be said that the range or mileage of an apparatus varies with the square root of the intensity of radiation; that is, as shown in the table, if the frequency per second is doubled, the radiation increases by the fourth power and the distance by the square. For example, when the frequency is doubled the radiation becomes sixteen times as great and the distance over which the influence is felt becomes four times as great.

OUTLINE OF A COURSE IN SHOP AND DRAFTING-ROOM MATHEMATICS, MECHANICS, MACHINE DESIGN AND SHOP PRACTICE

Any intelligent man engaged in mechanical work can acquire a well-rounded mechanical education by using as a guide in his studies the outline of the course in mechanical subjects given below. The course is laid out so as to make it possible for a man of little or no education to go ahead, beginning wherever he finds that his needs begin. The course is made up of units so that it may be followed either from beginning to end; or the reader may choose any specific subject which may be of especial importance to him.

Preliminary Course in Arithmetic
JIG SHEETS 1A TO 5A:—Whole Numbers: Addition, Subtraction, Multiplication, Division, and Factoring.

JIG SHEETS 6A TO 15A:—Common Fractions and Decimal Fractions.

Shop Calculations

Reference Series No. 18. SHOP ARITHMETIC FOR THE MACHINIST.

Reference Series No. 52. ADVANCED SHOP ARITHMETIC FOR THE MACHINIST. Reference Series No. 53. USE OF LOGARITHMIC TABLES.

Reference Series Nos. 54 and 55. SOLUTION OF TRIANGLES.

Data Sheet Series No. 16. MATHEMATICAL TABLES. A book for general reference.

Drafting-room Practice

Reference Series No. 2. DRAFTING-ROOM PRACTICE.

Reference Series No. 8. WORKING DRAWINGS AND DRAFTING-ROOM KINKS.

Reference Series No. 33. SYSTEMS AND PRACTICE OF THE DRAFTING-ROOM.

General Shop Practice

Reference Series No. 10. EXAMPLES OF MACHINE SHOP PRACTICE.

Reference Series No. 7. LATHE AND PLANE TOOLS.

Reference Series No. 25. DEEP HOLE DRILLING.

Reference Series No. 38. GRINDING AND GRINDING MACHINES.

Reference Series No. 48. FILES AND FILING.

Reference Series No. 32. SCREW THREAD CUTTING.

Data Sheet Series No. 1. SCREW THREADS. Tables relating to all the standard systems.

Data Sheet Series No. 2. SCREWS, BOLTS AND NUTS, Tables of standards.

Data Sheet Series Nos. 10 and 11. MACHINE TOOL OPERATION. Tables relating to the operation of lathes, screw machines, milling machines, etc.

Reference Series Nos. 50 and 51.

PRINCIPLES AND PRACTICE OF ASSEMBLING MACHINE TOOLS.

Reference Series No. 57. METAL SPINNING.

Jigs and Fixtures

Reference Series Nos. 41, 42 and 43. JIGS AND FIXTURES.

Reference Series No. 3. DRILL JIGS. Reference Series No. 4. MILLING FIXTURES.

Punch and Die Work

Reference Series No. 6. PUNCH AND DIE WORK.

Reference Series No. 13. BLANKING DIES.

Reference Series No. 26. MODERN PUNCH AND DIE CONSTRUCTION.

Tool Making

Reference Series No. 64. GAGE MAKING AND LAPPING.

Reference Series No. 21. MEASURING TOOLS.

Reference Series No. 31. SCREW THREAD TOOLS AND GAGES.

Data Sheet Series No. 3. TAPS AND THREADING DIES.

Data Sheet Series No. 4. REAMERS, SOCKETS, DRILLS, AND MILLING CUTTERS.

Hardening and Tempering

Reference Series No. 46. HARDENING AND TEMPERING.

Reference Series No. 63. HEAT TREATMENT OF STEEL.

Blacksmith Shop Practice and Drop Forging

Reference Series No. 44. MACHINE BLACKSMITHING.

Reference Series No. 61. BLACKSMITH SHOP PRACTICE.

Reference Series No. 45. DROP FORGING.

Automobile Construction

Reference Series No. 59. MACHINES, TOOLS AND METHODS OF AUTOMOBILE MANUFACTURE.

Reference Series No. 60. CONSTRUCTION AND MANUFACTURE OF AUTOMOBILES.

Theoretical Mechanics

Reference Series No. 5. FIRST PRINCIPLES OF THEORETICAL MECHANICS.
Reference Series No. 19. USE OF FORMULAS IN MECHANICS.

Gearing

Reference Series No. 15. SPUR GEARING.

Reference Series No. 37. BEVEL GEARING.

Reference Series No. 1. WORM GEARING.

Reference Series No. 20. SPIRAL GEARING.

Data Sheet Series No. 5. SPUR GEARING. General reference book containing tables and formulas.

Data Sheet Series No. 6. BEVEL, SPIRAL AND WORM GEARING. General reference book containing tables and formulas.

General Machine Design

Reference Series No. 9. DESIGNING AND CUTTING CAMS.

Reference Series No. 11. BEARINGS.

Reference Series No. 56. BALL BEARINGS.

Reference Series No. 58. HELICAL AND ELLIPTIC SPRINGS.

Reference Series No. 17. STRENGTH OF CYLINDERS.

Reference Series No. 22. CALCULATIONS OF ELEMENTS OF MACHINE DESIGN.

Reference Series No. 24. EXAMPLES OF CALCULATING DESIGNS.

Reference Series No. 40. FLY-WHEELS.

Data Sheet Series No. 7. SHAFTING, KEYS AND KEYWAYS.

Data Sheet Series No. 8. BEARINGS, COUPLINGS, CLUTCHES, CRANE CHAIN AND HOOKS.

Data Sheet Series No. 9. SPRINGS, SLIDES AND MACHINE DETAILS.

Data Sheet Series No. 19. BELT, ROPE AND CHAIN DRIVES.

Machine Tool Design

Reference Series No. 14. DETAILS OF MACHINE TOOL DESIGN.

Reference Series No. 16. MACHINE TOOL DRIVES.

Crane Design

Reference Series No. 23. THEORY OF CRANE DESIGN.

Reference Series No. 47. DESIGN OF ELECTRIC OVERHEAD CRANES.

Reference Series No. 49. GIRDERS FOR ELECTRIC OVERHEAD CRANES.

Steam and Gas Engine Design

Reference Series Nos. 67 to 72, inclusive. STEAM BOILERS, ENGINES, TURBINES AND ACCESSORIES.

Data Sheet Series No. 15. HEAT, STEAM, STEAM AND GAS ENGINES.

Data Sheet Series No. 13. BOILERS AND CHIMNEYS.

Reference Series No. 65. FORMULAS AND CONSTANTS FOR GAS ENGINE DESIGN.

Special Course in Locomotive Design

Reference Series No. 27. BOILERS, CYLINDERS, THROTTLE VALVE, PISTON AND PISTON ROD.

Reference Series No. 28. THEORY AND DESIGN OF STEPHENSON AND WAL-SCHAERTS VALVE MOTION.

Reference Series No. 29. SMOKE-BOX, FRAMES AND DRIVING MACHINERY.

Reference Series No. 30. SPRINGS, TRUCKS, CAB AND TENDER.

Data Sheet Series No. 14. LOCOMOTIVE AND RAILWAY DATA.

Dynamos and Motors

Reference Series No. 34. CARE AND REPAIR OF DYNAMOS AND MOTORS.

Data Sheet Series No. 26. WIRING DIAGRAMS, HEATING AND VENTILATION, AND MISCELLANEOUS TABLES.

Reference Series Nos. 73 to 78, inclusive. PRINCIPLES AND APPLICATIONS OF ELECTRICITY.

Heating and Ventilation

Reference Series No. 39. FANS, VENTILATION AND HEATING.

Reference Series No. 66. HEATING AND VENTILATING SHOPS AND OFFICES.

Data Sheet Series No. 20. WIRING DIAGRAMS, HEATING AND VENTILATION, AND MISCELLANEOUS TABLES.

Iron and Steel

Reference Series No. 36. IRON AND STEEL.

Reference Series No. 62. TESTING THE HARDNESS AND DURABILITY OF METALS.

General Reference Books

Reference Series No. 35. TABLES AND FORMULAS FOR SHOP AND DRAFTING-ROOM.

Data Sheet Series No. 12. PIPE AND PIPE FITTINGS.

Data Sheet Series No. 17. MECHANICS AND STRENGTH OF MATERIALS.

Data Sheet Series No. 18. BEAM FORMULAS AND STRUCTURAL DESIGN.

Data Sheet Series No. 20. WIRING DIAGRAMS, HEATING AND VENTILATION AND MISCELLANEOUS TABLES.

