

TJ

7E

M3

v.73

UC-NRLF



B 3 018 800

MACHINERY'S REFERENCE SERIES

EACH NUMBER IS A UNIT IN A SERIES ON ELECTRICAL AND STEAM
ENGINEERING DRAWING AND MACHINE DESIGN AND SHOP PRACTICE

No. 73

A Dollar's Worth of Condensed Information

Principles and Applica- tions of Electricity

By NEWTON HARRISON

PART I

STATIC ELECTRICITY—ELECTRICAL
MEASUREMENTS—BATTERIES

Price 25 Cents

CONTENTS

Static Electricity	- - - - -	3
Electrical Measurements	- - - - -	18
Batteries	- - - - -	30

The Industrial Press, 49-55 Lafayette Street, New York
Publishers of MACHINERY

COPYRIGHT, 1911, THE INDUSTRIAL PRESS, NEW YORK

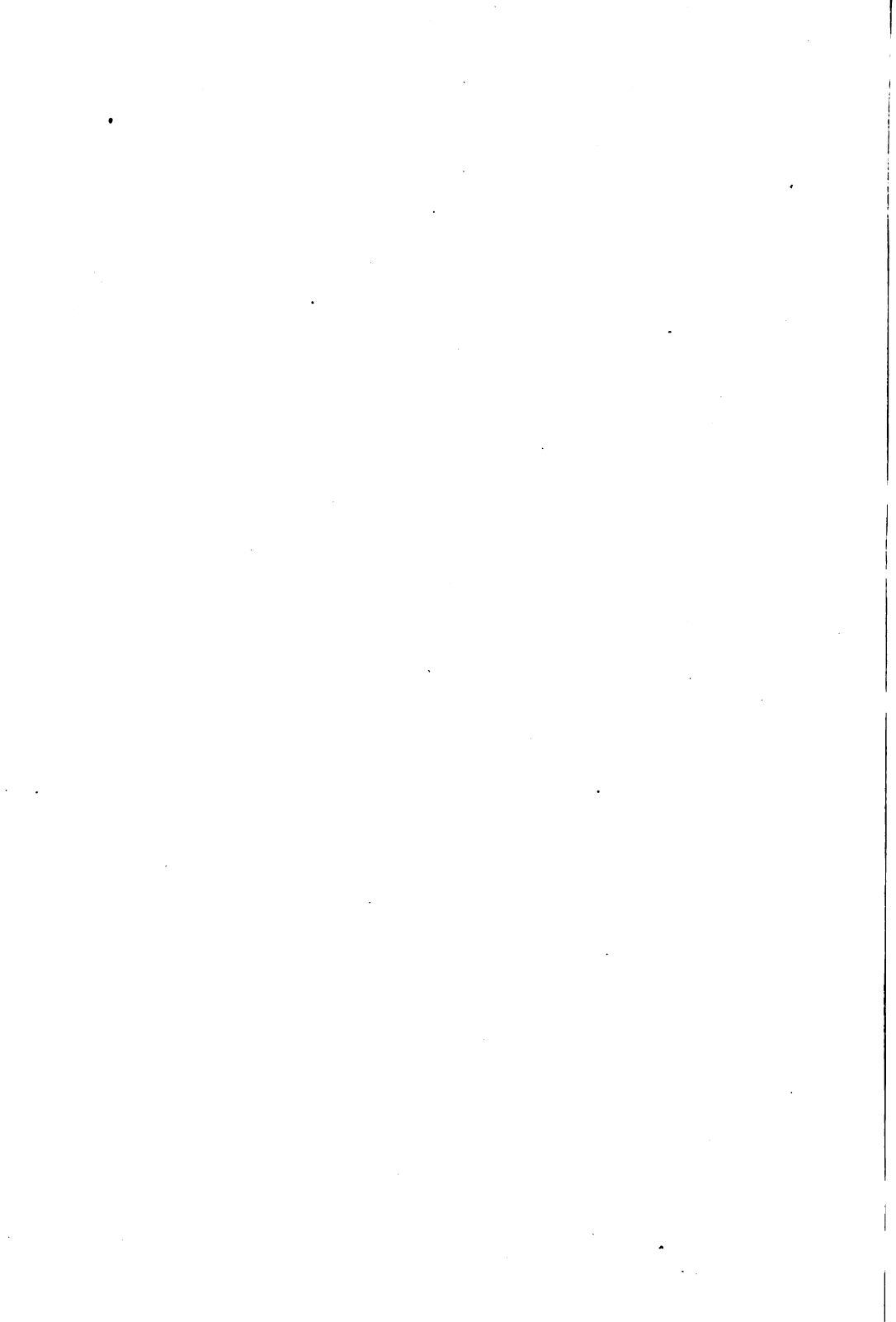

MACHINERY'S REFERENCE SERIES

EACH NUMBER IS A UNIT IN A SERIES ON
ELECTRICAL AND STEAM ENGINEERING
DRAWING AND MACHINE DESIGN
AND SHOP PRACTICE

NUMBER 73

PRINCIPLES AND APPLICATIONS OF ELECTRICITY

By NEWTON HARRISON

PART I

STATIC ELECTRICITY—ELECTRICAL
MEASUREMENTS—BATTERIES

CONTENTS

Static Electricity	- - - - -	3
Electrical Measurements	- - - - -	18
Batteries	- - - - -	30

7751

M3

v. 73

7751
M3
v. 73

CHAPTER I

STATIC ELECTRICITY

Greece, with her art, her literature and philosophy, has left her stamp upon all other great nations, whose destinies have been largely moulded by the thought which emanated from the classic times. Vast influences have sprung from her buried seed of learning, even though her knowledge was shrouded in the mists of mythology. Thales, the Greek philosopher, remarked upon the curious properties of amber. To him, a prototype of Greek paganism and metaphysical thought, there lay within this strange relic of primeval days a wonderful soul. The soul of amber, as it was called, gave evidence of its existence when the amber was rubbed upon the garments. A strange influence was emitted from the precious gum, which drew towards it light bodies, such as wisps of straw, for example. This unique property of amber was recorded by the sage, and handed down to other nations, to become, after the passage of more than 2000 years, the subject of new interest and inquiry, from a standpoint, however, which stripped it of its mythological character and fortunately gave rise to a series of new investigations of great interest and ultimate benefit to mankind.

The period of the renaissance proved an awakening, not only to the world of art and letters, but gave rise to a new manner of thinking, which ushered in the birth of science. Dr. Gilbert, one of the exponents of this new idea, physician in the reign of Queen Elizabeth, investigated the properties of amber in conjunction with a series of other substances, and thus was enabled to find in them all a similarity of effects which forever dissipated the doctrine of spiritual influences as far as this particular substance was concerned. The Greek name elektron, however, which means amber, has been preserved and embodied in the word electricity.

The question is often asked, "What is electricity?", and the answer generally given is ambiguous and misleading. Electricity, like light and heat, is simply a form of energy. The entire field of electrical engineering, with its immense scope and innumerable applications to domestic, municipal and industrial purposes, represents, in total, only an effort to produce an effect at a point more or less distant from the source of power, and to transmit and transform energy with this object in view.

The fundamental idea of energy is, in a sense, metaphysical, yet it is defined as the capacity of a body to do work. Force is defined as any cause that produces, stops, changes, or tends to produce, stop or change the motion of a body. Work is defined as the action of a force in overcoming resistance. There are, therefore, the ideas of energy,

force and work, upon which the structure entitled the electrical science is reared and without which it is impossible to measure the relationship between cause or effect, or one form of energy and another, in an exact and practical manner.

To deal with the subject of electricity in an exact manner, it is necessary to base all units upon some foundation which can be considered as unchangeable. An international agreement has been reached in this respect, with the result that the units of length, weight and time which are employed, are the centimeter, gram, and second. The name given to the system based upon the use of these units is the absolute or C.G.S. system. From these units are derived all measurements of force or work by means of which the phenomena of electrical actions and reactions can be expressed.

Static Electricity

Electricity can be generally divided into two kinds—static and dynamic. Static electricity means electricity at rest. Dynamic elec-

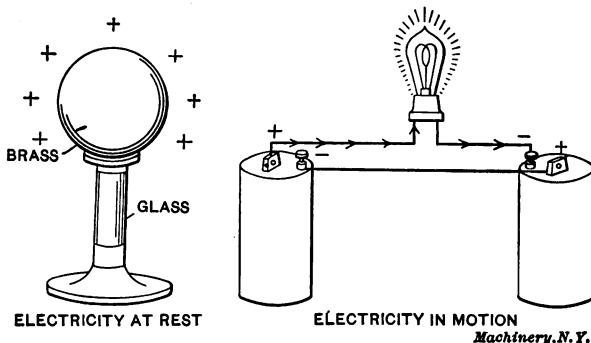

Figs. 1 and 2. Examples of Static and Dynamic Electricity

tricity means electricity in motion. As an illustration of what is meant by static electricity, take a metal globe insulated by means of a glass support and charge it with static electricity. (See Fig. 1.) This is a case of electricity at rest. On the other hand, take a source of electric current such as a couple of dry cells and connect the terminals through a small lamp. (See Fig. 2.) In this case the electricity is in motion, and is thereby distinguished from the static. It is merely necessary to impart motion to a static charge to give it all the characteristics of dynamic electricity or of what is called a *current*. If the charged metal globe is allowed to discharge its electricity through a wire (see Fig. 3), it becomes transformed into dynamic electricity and exercises the same effects as an electric current. This has been noted a number of times in the case of lightning discharges, where melting, burning and decomposition have been caused by the escaping electricity, originally static in character, and for the instant possessing those qualifications which define it as dynamic.

Producing Static Electricity

Nearly all chemical and physical changes produce electricity. Static electricity can be produced in great quantities by means of friction and by applying certain principles of static electricity to the construction of machines through which mechanical or muscular energy is transformed into static electricity. A common way of developing static electricity for experimental purposes, is to use a glass rod free from lead, and rub it with a silk handkerchief, or to secure a rod of hard rubber and rub it with a woolen cloth. If the air is dry, sufficient electricity can be obtained to produce decided reactions with small pieces of light paper, fragments of cork, etc. Benjamin Franklin in his experiments used a glass globe mounted on a horizontal axis, against which a rubbing cushion pressed, thus producing static electricity.

Two Kinds of Electricity

There are two kinds of electricity, called positive and negative, as may be ascertained by the following experiments: Take a glass rod

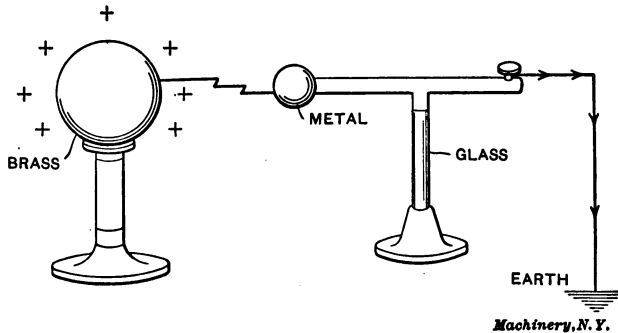

Fig. 3. Static Electricity being Discharged

and excite a charge on its surface by rubbing it with a silk handkerchief. Bring the end of the rod near a pith ball mounted on an insulating support and hanging from a delicate silk thread, as shown in Fig. 4. On bringing the charged glass rod near the pith ball, it will be attracted, but on touching the rod it will be instantly repelled, assuming the position marked 3. The process may be repeated with a rod of hard rubber on which a charge has been excited by means of a woolen rag. On bringing the hard rubber rod near the pith ball it will be attracted and repelled in exactly the same manner. The positions assumed by the pith ball are relatively 1, 2 and 3 with either rod. The fact to be observed particularly in the course of such an experiment, is that the pith ball, though showing every sign of marked repulsion to the charged glass rod in the first case, instantly flies to the charged hard rubber rod in the second case; and if the experiment is then repeated with the glass rod it will be seen that the pith ball strongly repelled from the hard rubber rod will now be attracted by the excited glass rod. The results can be tabulated as follows:

- 1.—Glass rod: Pith ball attracted, then repelled.
- 2.—Rubber rod: Pith ball attracted, then repelled.
- 3.—Glass rod: Pith ball attracted, then repelled.
- 4.—Rubber rod: Pith ball attracted, then repelled.

In other words, it is evident that the electricity in the pith ball, communicated to it in the first place by the glass rod, causes repulsion, and that the same electricity in the pith ball causes it to be attracted by the rubber rod, though subsequently repelled; and in this manner the operation can be kept up, showing that what the glass rod repels, the rubber rod attracts, and *vice versa*.

The explanation of this phenomenon lies in the assumption of two kinds of electricity, called positive (+) and negative (—), produced by the glass and rubber rods, respectively. When the glass is rubbed with silk, positive electricity is developed on the glass. When the rubber rod is rubbed with flannel, negative electricity is developed on

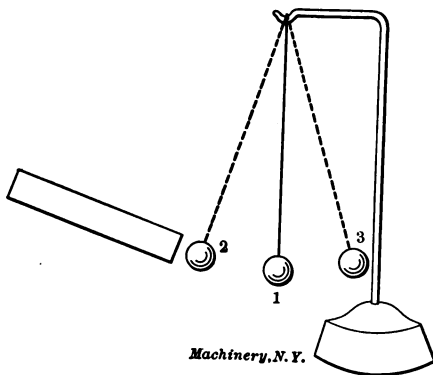

Fig. 4. Experiment Showing the Presence of Positive and Negative Electricity

the rod. Bringing the glass rod near the pith ball causes the pith ball to be attracted; it touches the glass rod, and is repelled. The repulsion occurs because it has taken up some of the electricity of the glass rod, which is positive. The negatively charged rubber rod is brought near, and the pith ball is attracted. This occurs because the pith ball and the rubber rod hold different kinds of electricity, or present different phases of electrical energy. After the pith ball touches the rubber rod and has had some of the negative electricity transmitted to it, it is repelled. The entire process is due to the operation of two simple laws as follows:

Law I.—*Unlike charges attract each other.*

Law II.—*Like charges repel each other.*

When the pith ball touches the glass rod, the positive electricity in both glass and ball causes repulsion. The negative electricity in the rubber can then attract, but when contact occurs also repels. Thus the various positions of the pith ball, 1, 2 and 3, are adequately explained after contact takes place, and when a body charged with an

opposite kind of electricity is brought near the pith ball. This explanation will hold in all cases where two charges of electricity can affect each other. The character of these charges must be determined, and then a rational conclusion drawn, based upon the two laws as stated. Before a further advance is made in the study of this subject it is necessary to arrive at some conclusion regarding what may be called a unit charge of electricity.

Unit Charge of Electricity

To measure static electricity correctly, a simple experiment can be tried or imagined in the following manner: Two spheres (see Fig. 5) of 1 centimeter radius are placed 1 centimeter away from each other. Each of the spheres is charged with positive electricity, imparting to each exactly the same quantity. If the condition is imposed that the spheres each possess an equal charge of electricity, then, when they

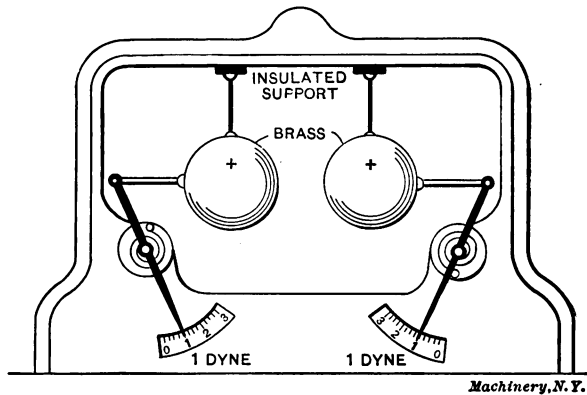

Fig. 5. Mechanical Illustration of the Unit Charge of Electricity Machinery, N. Y.

repel each other with the force of one *dyne*, each sphere possesses a *unit* charge of electricity. To fully explain the meaning of this it is necessary to define a dyne.

A dyne is the force required to impart to a mass of 1 gram the velocity of 1 centimeter per second. It is the same as though the amount of force were measured that is required to lift a weight of 1 pound 1 foot per second, only the force in the case of a dyne is much smaller, and is the result of the adoption of the C.G.S. system as the basis for all units. A unit of electricity, commonly called a unit quantity or unit charge, is named a coulomb in honor of a distinguished investigator of that name. It is defined as that quantity of electricity on the surface of a sphere of 1 centimeter radius, which will repel a similar and equal quantity on a sphere of 1 centimeter radius at a distance of 1 centimeter with the force of 1 dyne.

Static Charges outside of Bodies

If a sphere is charged with electricity an examination of it will show the charge distributed equally on the outside. If the sphere is hollow

(see Fig. 6), an examination of it when charged will disclose the same state of affairs, namely, that there is no electricity inside the sphere, the charge being entirely outside. Michael Faraday made note of this fact, and experimented with what is called a Faraday cylinder for the purpose of illustrating this idea. It will be seen in Fig. 7 that when the cylinder is charged, the pith balls inside show no sign of repulsion, but the pith balls outside violently repel each other. This is due to the presence of electricity only on the outside of the cylinder; were there any inside it would give evidence of its existence, by causing repulsion between the inner pith balls, but as this is not so, the opposite conclusion is inevitable.

A network of wires forming a cage would therefore be a great protection against heavy charges of electricity. If a sort of electric cage armor of this description were constructed, enormous charges of elec-

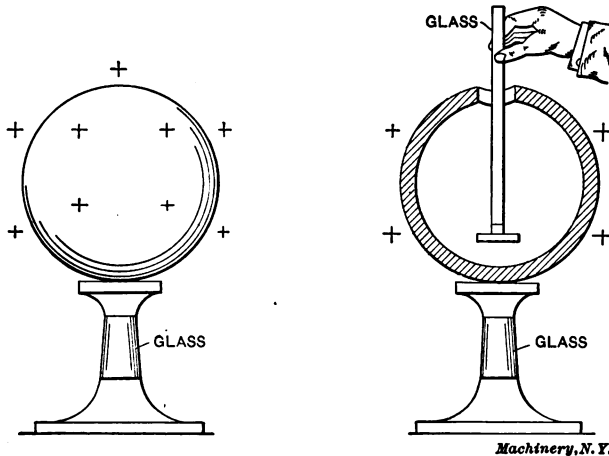

Fig. 6. Solid and Hollow Spheres, Showing Charge on the Outside

tricity could be directed at it without producing the slightest effect upon those within. In large cities with modern steel frame buildings, considerable protection is afforded from this source alone against lightning. The steel frame also serves as an excellent ground connection during electric storms.

Electrostatic Induction

A keen mind will not be contented with the statement made regarding a charged rod and a pith ball. The inquiry which will arise is this: Why does the pith ball in the first place move toward the charged glass rod? It is to be remembered that the pith ball was perfectly neutral in the first experiment, yet it was immediately affected by the presence of a charge in its neighborhood. How can a charged body affect a neutral body? Why should a pith ball absolutely devoid of any trace of electricity be attracted by a charge of electricity? The answer is as follows: The charged body affects the condition of the

pith ball and develops in it both positive and negative electricity. (See Fig. 8.) From this fact a general principle can be stated—that induction occurs between a charged body and a neutral body across the empty space between them. In some remarkable way an influence is promulgated from every electric charge in such a manner that all bodies far and near become possessed of two kinds of electricity. By giving to this the name of electrostatic induction, it must not be un-

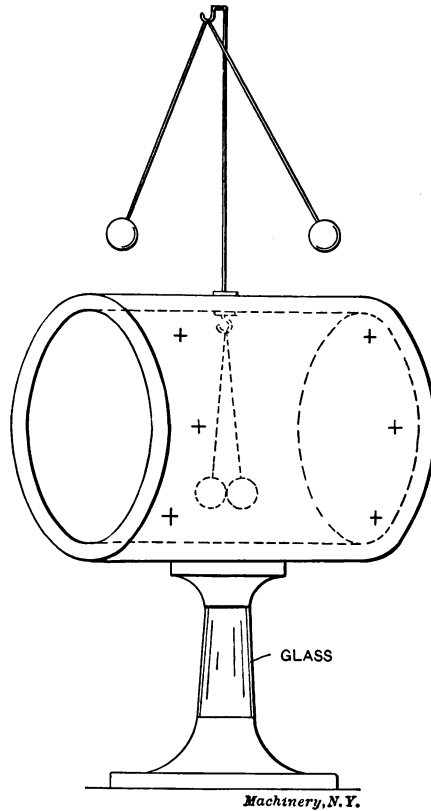

Fig. 7. Faraday Cylinder, Showing Electricity on the Outer Surface only

derstood that the phenomenon is explained; but such facts as can be deduced from experiments which prove the presence of induction are employed for the purpose of investigating other results, the causes of which would otherwise be a matter of great doubt.

Continuing the discussion relating to the pith ball, it is now easy to see why it was attracted by the charged rod. It simply obeyed the law "that unlike charges attract each other," and for this reason if the rod was positively charged it attracted the negative electricity in the pith ball developed there by induction. Another question which will arise, however, is this: Why does the pith ball move, even though

it is attracted, when it also carries a charge which repels? This is because the attracting charge is nearer to the charged rod than the repelling charge and therefore one force is a little greater than the other.

This idea can be best represented by two metal plates, one of which is insulated and rests on an insulated support, while the other is supported by means of a spring balance, as shown in Fig. 9. Before the lower plate is charged, the force indicated on the spring balance will be merely that of the weight of the upper plate.

When the lower plate is charged with positive electricity, induction takes place between it and the upper plate. The lower surface of the upper plate develops a charge of negative electricity, while an *equal* quantity of repelled positive electricity accumulates on the upper surface of the upper plate. The scale will indicate a greater force than before and the difference between the apparent weight when affected inductively and the actual weight of the plate is the extent of the attraction. This, of course, represents the difference, as well, between

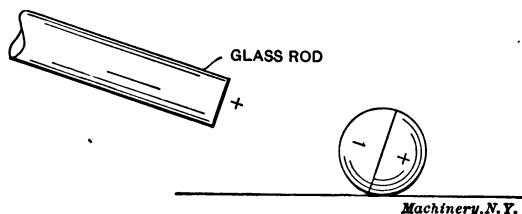

Fig. 8. Induction between Pith Ball and Glass Rod

the attraction of the positive and negative and the repulsion between the positive and positive electricity of the two plates. If sheets of different materials such as glass, hard rubber, paraffin, etc., are interposed between the two plates it will be noted that the balance will change its record in each case.

Insulators and Dielectrics

The change in the record of the spring balance would be due to the fact that different insulating materials, such as those enumerated, cause different degrees of induction to occur between the plates. This power of a body to allow induction to occur through it is called its inductive capacity and such bodies are called *dielectrics*. Therefore when the induction is greater, the balance records a greater pull, and when it is less the reverse is true. The amount of induction occurring through air is taken as the standard and is called 1. With reference to this the inductive capacity of other bodies is noted.

When a body conducts electricity it is called a conductor, and when it does not conduct electricity the name insulator or non-conductor is employed. One of the best conductors is silver and one of the best insulators is dry air. Between these two are a series of substances which include metals, earths, water, etc., which embrace all grades of

conductivity. For this reason they are grouped in such a manner that they comprise the following:

Partial conductors such as metals, wood or earth.

Non-conductors, such as rubber, glass or porcelain.

When lightning leaps through the air it breaks down the insulating properties of the air because of the tremendous tension existing between two opposite charged bodies. When the accumulated charges of electricity reach a certain point, the electrical pressure becomes so great that the insulation is rent by what is called a "disruptive discharge."

Electrophorus

To produce static electricity continuously without having to resort to the rather primitive method of rubbing a rod of glass or hard rubber with a silk or woolen rag, a device is employed which involves the

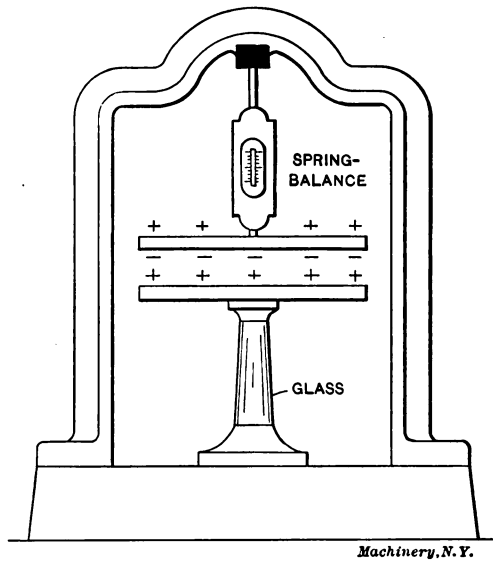

Machinery, N.Y.
Fig. 9. Induction between a Charged and a Neutral Body, and the Method used for Measuring the Attraction

action of the two fundamental laws of static electricity and the principle of electrostatic induction. It is called the electrophorus and consists of a plate of hard rubber or resin on which rests a detachable brass plate with an insulated handle.

The hard rubber plate is beaten with a piece of cat's fur or a woolen rag and becomes strongly electrified. The brass plate is then rested upon the rubber plate and the finger then placed upon the brass plate for an instant. If the brass plate is lifted up carefully by its handle and the knuckle presented to it, a spark will show that quite a discharge has taken place. If the plate is put back, then touched with the finger and removed and discharged and the operation repeated a

dozen times, it will become evident that in this device electricity can be obtained continuously without applying friction more than once to the under plate.

In the first place, when friction is applied, negative electricity is developed. This charge acts by induction on the brass plate resting on it and positive and negative electricity appear. The positive electricity is held on the under side of the brass plate by induction and is called a *bound* charge. The negative is repelled to the upper surface of the brass plate and is called a *free* charge. The free charge may be removed by touching the plate with the finger. When the plate is lifted away by its handle, the bound positive electricity becomes free, because it is removed from the inductive influence. It can be discharged by presenting the knuckle and the device is then ready for a repetition of the process.

The question is asked, "Why does induction take place when the brass plate *rests* on the rubber plate?" The answer is that a film of dry air acts as insulation between the two plates. The inequalities of

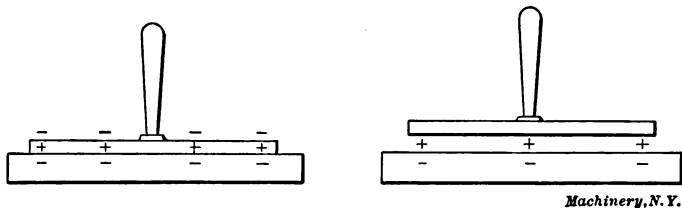

Fig. 10. Electrophorus with Plates in Contact, and with Plates Separated and the Free Electricity Removed

surface account for this; otherwise, if the surfaces were absolutely flat and therefore in intimate contact, the negative electricity of the under plate would pass into the upper brass plate and there would be conduction instead of induction.

The Leyden Jar and Condenser

Electricity can be accumulated or condensed so that small quantities regularly supplied to a properly constructed device can be gathered into one large charge. The original name for such a device was a Leyden jar, but in its more modern form it is called a condenser.

The town of Leyden, Holland, was, according to tradition, the scene of the following incident about two centuries ago: A beaker of water holding a metal stirring rod rested on a stand near an electrical machine. Sparks from the machine entered the rod and charged the water. When the beaker was lifted by the philosopher's assistant with one hand, and the other touched the rod, a terrible shock was experienced by him, and the beaker fell to the ground. This meant the discovery of a means of condensing a series of small charges, so that when so held they were capable of discharging in one great flash. A Leyden jar, Fig. 11, consists of an inner and outer coating of tin foil attached to a glass beaker. A metal rod with a knob at its outer end and a chain at its inner end, is mounted in the center of a well-var-

nished cork inserted in the mouth of the beaker. When positive electricity enters the knob, the inner tinfoil coating is charged. The outer tinfoil coating is acted upon by induction and its inner surface becomes negative and its outer surface positive. The outer surface can be touched with the finger and the free positive electricity removed. As the jar now stands it contains positive electricity inside and negative outside, and it can be repeatedly charged with small amounts of electricity, until a considerable charge has been accumulated. The two plates of the electrophorus in Fig. 10 act in the same manner, and merely re-

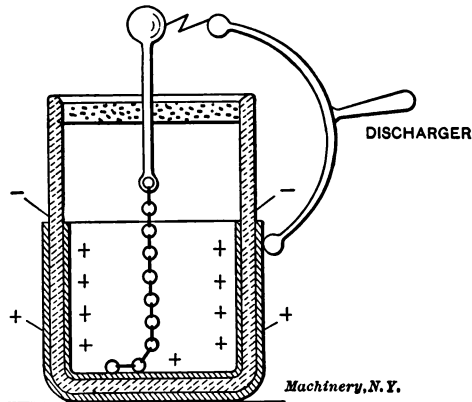

Fig. 11. Diagrammatic Representation of the Leyden Jar

present the two tinfoil coatings in a different position. In this manner electricity is condensed, or, expressed in a more scientific manner, *the potential is raised.*

Principle of the Condenser

If a closed tank with one inlet is pumped full of gas, the gas pressure rises. The gas may enter in small quantities until the tank contains gas at the same pressure as the working pressure of the pump; then the action ceases. A condenser is an electrical tank in which the electrical pressure (measured in *volts*) rises as more electricity enters. The correct expression is that the potential rises as the condenser is charged. In order to be accurate, and thus have a system by which measurements can be made, the units of potential and capacity are defined with reference to the condenser as below.

Definition of the Farad

A condenser has a capacity of one *farad*, if, when charged with one *coulomb* of electricity it has a difference of potential of one volt. This means, for instance, that if a metal tank takes in a cubic foot of air and then shows 15 pounds pressure, the tank has a capacity of one cubic foot. In the same sense if the electrical tank takes in a coulomb and shows a pressure of one volt, its capacity is one farad. The capacity

is determined by the pressure developed by a certain quantity of electricity in the condenser. This is expressed by the simple formula:

$$\text{Quantity} = \text{pressure} \times \text{capacity.}$$

For instance, if a condenser had a capacity of 1 farad it would have 1 volt difference of potential with 1 coulomb, 2 volts with 2 coulombs, 3 volts with 3 coulombs, etc. The idea is relatively the same as if 1 cubic foot of air is forced into a tank of 1 cubic foot capacity, the pressure being 15 pounds; with 2 cubic feet, 30 pounds; with 3 cubic feet, 45 pounds etc.

When sheets of tinfoil and paraffined paper are arranged in alternate layers, and a tongue of tinfoil allowed to project for the purpose of making connections from each tinfoil sheet in such a manner that the projections of all the positive sheets are easily connected together as well as the projections of all the negative sheets, as shown in Fig. 12, then a practical condenser is obtained which can be used for exact tests when its capacity has been determined. The farad is such a

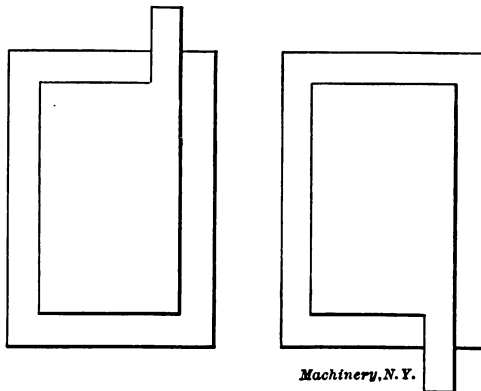

Fig. 12. Plates of Condenser, Showing Paraffined Sheet with Tinfoil having Projection for Connections

large unit and so unattainable in practice that condensers are built on the basis of one one-millionth of a farad. This fractional part of the original unit is called a microfarad. A condenser of a microfarad capacity is about the size of a cigar box, but, of course, such a comparison is not very exact, because the capacity of a condenser depends upon the area of the tinfoil sheets, the nature of the dielectric, and the thickness of it.

Connecting up Condensers

Condensers may be connected in series for high potential effects and in multiple for low potential effects. By this is meant that condensers in series give high pressure (voltage) and small quantity, while those in multiple give large quantity and little pressure. This idea is represented by the diagram in Fig. 13, where the condensers are connected in series. Here the + and - poles are connected to-

gether and by that means the potentials of the various condensers. In Fig. 14 the condensers are connected in multiple. All the positive poles of the condensers are connected together and all the negative. The total capacities are obtained as follows:

Condensers in Multiple.—Add the capacities of the various condensers together; for instance, if they are of 1, 2 and 3 farads capacity, respectively, the total would be 6 farads.

Condensers in Series.—The total capacity of condensers in series is equal to the reciprocal of the sum of the reciprocal of the capacities. Turned into arithmetic this rule appears as follows:

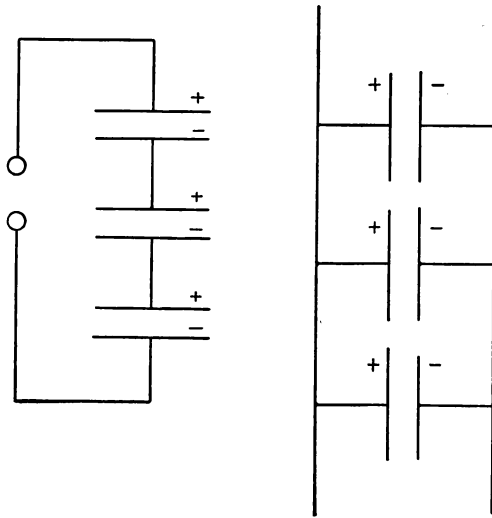

Fig. 13. Condensers in Series Fig. 14. Condensers in Multiple

Machinery, N.Y.

$$\text{Total capacity} = 1 \div \left(\frac{1}{\text{capacity of 1st condenser}} + \frac{1}{\text{capacity of 2d condenser}} + \frac{1}{\text{capacity of 3d condenser}} + \text{etc.} \right)$$

In the case mentioned above the total capacity would be:

$$\frac{1}{\frac{1}{1} + \frac{1}{2} + \frac{1}{3}} = \frac{1}{\frac{11}{6}} = \frac{6}{11} \text{ of a farad.}$$

Interesting examples of condenser action are afforded by a thunder storm. In this case the action may be merely between clouds. One cloud is heavily charged with positive and the other with negative electricity. When they approach, the clouds develop a high potential at the points nearest to each other, and the air resistance is broken down

by a blinding flash. When a condenser is discharged by a wire leading from one pole to the other the principle is the same. If the electrified cloud is over a church steeple or a high tree, induction takes place. If the cloud is positive, the high structures underneath, and, in fact, the whole area exposed, become negatively charged. When the strain becomes so great that the inductive influence breaks down the integrity of the resistance between, lightning appears; and as a natural consequence of the discharge, the thunder follows. Lightning is practically instantaneous as far as the eye is concerned. Thunder, however, travels at the rate of 1100 feet per second, or about 1 mile every 5 seconds. By noting the number of seconds between the flash and the thunder, a fair estimate of the distance at which the disruptive discharge took place can be obtained.

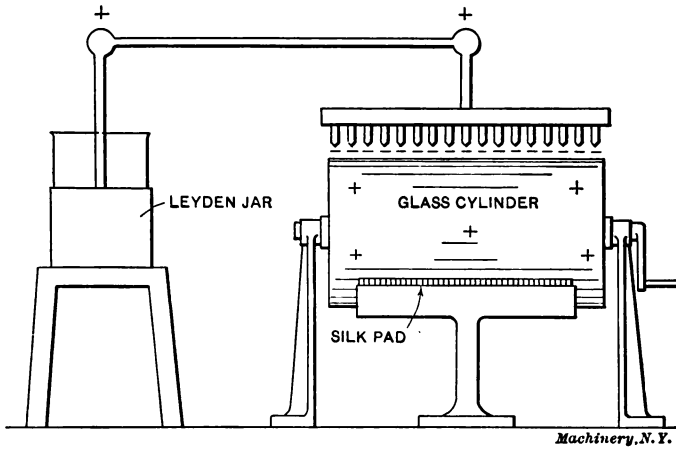

Fig. 16. Frictional Machine for Producing Small Quantities of Electricity

It is interesting to know the cause of the so-called splitting and breaking effects of lightning. If a tube filled completely with water and sealed, is exposed to a static discharge of sufficient force, it will break into pieces. This is due to the steam and gases of decomposition produced by the electricity in passing. The induction between the water inside, and the charge outside thus breaks down the glass wall between. With a tree, however, the wood cells contain moisture which is suddenly transformed into high pressure steam when the lightning passes. The effect of this is an internal disruption similar to a series of miniature boiler explosions, and the tree is necessarily split in two.

Waves Produced by Condensers

When a Leyden jar or a condenser is discharged it produces a tremendous disturbance in the ether. This disturbance appears in the form of waves, known by the name of Hertzian waves, and their application for the transmission of intelligence without wires is known as wireless telegraphy. If a large Leyden jar, or a static machine, is

allowed to produce a series of discharges in the center of a room, it can be proven that millions of waves are set into motion in the room, pass through the walls and reach out over miles of distance through all sorts of obstacles such as other buildings, hills, etc.

A wire stretched around the room with fine saw cuts in it, thus dividing it up into sections, will exhibit small sparks between the edges of the cuts when a Leyden jar is discharged as described. This is due to the waves striking the wire, producing electricity in it, and appearing as minute sparks in a darkened room. Carrying out the idea with a sheet of tinfoil on a glass plate, the tinfoil divided by fine saw cuts, provides a device by which waves can be detected still further away. It is but a step to inclose fine metal filings in a glass tube with a metal plug at each end. This will detect waves at a great distance away from their source and if used in conjunction with a few cells of battery, a telegraphic relay, and sounder, we have the essential elements now in use for wireless telegraphy.

Frictional and Induction Machines

Machines producing static electricity may be divided into two classes—frictional and induction machines. The first type is but little used in the laboratory, but consists of a cylinder of hard rubber or glass rotated against a buffer or rubber of flannel, wool or silk, as shown in Fig. 15. A metal rod is placed near with teeth mounted in it almost touching the cylinder. Rotation of the cylinder produces positive electricity on its surface as it is rubbed by the pad. The teeth or points of the rod “blow” bound negative electricity on the glass, and, in consequence, an equal amount of free positive electricity is collected by the Leyden jar. This constitutes the so-called frictional machine in which, as can be seen, induction is an important factor. If the cylinder is replaced by a device which has its charge reinforced by *induction* alone, then the pure type of induction machine appears as represented by those machines bearing the name of Holtz, Ranney, Wimshurst, etc.

An interesting feature of induction and frictional machines is the fact that toothed rods keep the surface of the glass plate or cylinder neutralized. For instance, in the case given, as the glass cylinder rotates, the excited surface of the glass is brought opposite the row of teeth, which blow a stream of negatively charged particles of air on the retreating portion of the cylinder. This neutralizes it before it passes under the silk pad again.

It must be understood that the action of a point is to discharge electricity. The air particles in contact are charged and repelled, and as this is a continuous action it is evident that by this process the charge of a pointed object is quickly dissipated unless as rapidly supplied.

CHAPTER II

ELECTRICAL MEASUREMENTS

Electrical measurements do not consist entirely of measurements of the amount of pressure (volts) or current (amperes) in a circuit. The process is more extensive than this and embraces the measurement of resistance, power, induction, magnetic flux, etc. In other words, under the title of electrical measurements may be included a great variety of tests in electricity and magnetism, many of which are of such great importance that it may be said that the very science of electrical engineering itself depends upon them for its existence. In the following, however, we shall deal only with the very simplest electrical measurements.

The corner stone of the science of electrical measurements rests upon a knowledge of what is known as Ohm's law. This law states that *the current is proportional to the electromotive force and inversely proportional to the resistance*. This law makes it possible to find any one of the three factors, amount of current, electromotive force, and resistance, when two of them are known. For instance, when resistance and current are given, electromotive force is found; when electromotive force and current are given, resistance is found; when electromotive force and resistance are given, current is found. The three quantities whose relationship can be expressed as indicated are thus:

1. Resistance, given in *ohms*.
2. Current, given in *amperes*.
3. Electromotive force, given in *volts*.

Ohm's law may be expressed arithmetically as follows:

To get volts, multiply amperes by ohms.

To get amperes, divide volts by ohms.

To get ohms, divide volts by amperes.

Expressed as formulas, these rules would be:

$$E = C \times R \dots\dots\dots (1)$$

$$C = \frac{E}{R} \dots\dots\dots (2)$$

$$R = \frac{E}{C} \dots\dots\dots (3)$$

in which

E = electromotive force in volts,

C = current in amperes,

R = resistance in ohms.

To illustrate the application of Ohm's law, the following examples are given:

Example 1.—Find how many volts are required to send 10 amperes

through a resistance of 100 ohms. In this case the volts are to be found, and the two values given must be multiplied together:

$$\text{Volts} = \text{amperes} \times \text{ohms} = 10 \times 100 = 1000.$$

Example 2.—Find the number of amperes passing through a lamp taking 110 volts, whose resistance is 220 ohms. According to the law as expressed by the rules just given, we have:

$$\text{Amperes} = \text{volts} \div \text{ohms} = 110 \div 220 = \frac{1}{2}.$$

A fact which may be mentioned is that an incandescent lamp has a high resistance when cold, and a much lower resistance when hot. A resistance test would show that the lamp when cold has a resistance of 450 ohms, while at incandescence the resistance falls to 220 ohms.

Example 3.—Find the resistance of a coil of wire which takes a current of 2 amperes and a pressure of 110 volts. According to our rule,

$$\text{Ohms} = \text{volts} \div \text{amperes} = 110 \div 2 = 55.$$

These are the simplest illustrations of Ohm's law as employed by electrical workers all over the world. The examples may be considered as characteristic of the most important forms in which the law appears. It undergoes other changes in alternating current theory, because of the fact that additional influences are operating besides those ordinarily at work. The above forms would therefore be inapplicable to circuits carrying variable and alternating currents.

Ohm's Law for an Instantaneous Current

When a current is turned into a circuit for an instant and turned off, or when a current is first sent into a circuit, the current for a short period of time is not exactly equal to the volts divided by the ohms. There seem to be other influences at work which partially arrest the free flow of the current. It cannot be said that this influence is due to the resistance of the wire, because if this were the case, Ohm's law would hold true in every sense of the word. The difficulty, however, is not so much inside the wire, but is due to outside influence. This, it seems, acts in such a manner that a current cannot be instantaneously sent into a wire at its full strength, neither can it be instantaneously cut short. The wire possesses the power of developing, through this external influence surrounding it, an *electromotive force of its own*.

When the blacksmith strikes the anvil, the hammer flies back. In a sense, when a current strikes a circuit, the circuit strikes back. The sound may be absent, and there may be no visible signs of this reaction, but it is always there. From a scientific standpoint, it is said that the magnetism around the wire, which surrounds it when a current flows, momentarily develops this counteracting influence. It acts against the *incoming* current, checking it, and consequently only permitting it to rise to its full value in a certain period of time; or it acts with the retreating current when the circuit is opened, augmenting its pressure at the last moment. It had been noted for quite some time, before an examination of the conditions had been made by eminent physicists and mathematicians, that rapidly changing currents

did not seem to flow in obedience to Ohm's law. Neither did Ohm's law, as then understood, coincide in its results when applied to those obtained with a current turned rapidly on or off. The fact that the current took an appreciable time to rise to its full value and did not immediately cease in a circuit opened and closed, gave room for thought. It soon became evident that the simple form of Ohm's law for these conditions would not do. It could be correctly applied in the case of a continuous current, but not in the case of either an *instantaneous* or an *alternating* current. Helmholtz interpreted Ohm's law in a new form, in which time is considered, and the influence external to the wire called self-induction. The Helmholtz equation, as it is called, is therefore a form of Ohm's law by which the current can be ascertained at any instant. In the equation expressing it, self-induction is expressed or measured in *henries*.

The Helmholtz Form of Ohm's Law

Helmholtz gave Ohm's law as stated, but he added a modifying clause, so to speak. He adds to the formula a parenthesis by which the fraction must be multiplied to obtain exact values for any condition of the circuit or current. The formula then takes the following form:

$$\text{Amperes} = \frac{\text{Volts}}{\text{Ohms}} \left(1 - e^{-\frac{\text{Ohms of circuit}}{\text{Self-induction of circuit}} \times \text{Time in seconds}} \right)$$

Written with symbols, Helmholtz's interpretation of Ohm's law for the current at any instant is:

$$C = \frac{E}{R} \left(1 - e^{-Rt \div L} \right)$$

In this formula, e is the base of the Napierian logarithms*; L is the self-induction in henries, and t the time in seconds.

To illustrate, make

$$E = 100 \text{ volts.}$$

$$R = 20 \text{ ohms.}$$

$$L = 2 \text{ henries.}$$

$$t = 5 \text{ seconds.}$$

Then e with its exponent becomes equal to $\frac{1}{e^{50}}$, which is practically

equal to zero. This would leave $C = E \div R$, with the quantity inside of the parenthesis = 1. Hence, when the time during which the circuit is closed is prolonged, as in this case, to 5 seconds, the simple form of Ohm's law applies without modification.

Form of Ohm's Law for Alternating Currents

The influence of self-induction has been referred to in the Helmholtz form of Ohm's law. From this form of the law another expression has been obtained, which is given in a more practical form. In this new expression or formula, the effects of self-induction and the

* See MACHINERY'S Reference Series No. 53, Use of Logarithms and Logarithmic Tables, page 16.

frequent changes of the current are given such form that simple calculations can be made. When a current is started in a circuit, all of the disturbing effects are present whether the current is continuous or alternating. If the current is alternating in character, the more rapidly it reverses its direction in a second, the more of this reaction takes place in the circuit. The extent of this impeding influence is given by the formula as follows:

$$I = \sqrt{R^2 + p^2 L^2}$$

in which

- R = resistance in ohms,
- L = self-induction in henries,
- $p = 2 \times \pi \times$ the frequency per second,
- I = the impedance in ohms.

As a practical example of the use of this formula, the question might be asked: What is the impedance of a circuit (see Fig. 16), in which the resistance equals 5 ohms, the frequency 100 per second and the henries 2? Then

$$R^2 = 5 \times 5 = 25,$$

$$p^2 = (2 \times 3.1416 \times 100)^2 = 394,800, \text{ approx.}$$

$$L^2 = 2 \times 2 = 4.$$

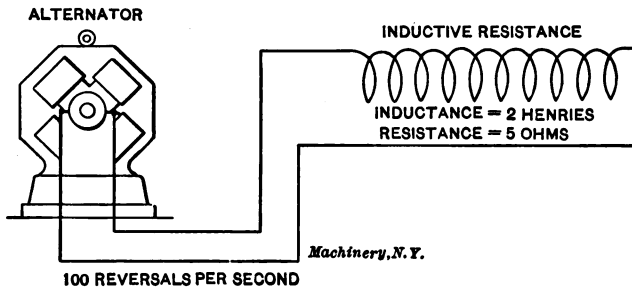

Fig. 16. Illustrating a Problem in the Calculation of Impedance in Alternating Currents

Then $R^2 + p^2 L^2 = 25 + 394,800 \times 4 = 1,579,225$, and the square root of this number equals 1257 ohms. The comparison of the effect of the resistance of 5 ohms and the effect of the impedance in total shows how the ordinary resistance may be disregarded altogether when the frequency of an alternating current is high or the self-induction in the circuit is high. The actual resistance having been substituted for by the false resistance, Ohm's law for alternating currents will be

$$\text{Current} = \frac{\text{electromotive force}}{\text{impedance}}, \text{ or } C = \frac{E}{I}.$$

If the current is not alternating, and therefore, there is no value to insert in the impedance formula for frequency, then the formula is simply a direct expression of Ohm's law. For instance, if there were no frequency, $p^2 L^2$ disappears, and the square root of R^2 is R . The

formula then becomes $I = \frac{E}{R}$, and we have $C = \frac{E}{R}$, which is the original

familiar form of Ohm's law. The two forms of Ohm's law as given by Helmholtz, and with respect to the resistance or impedance to alternating currents, both become transformed into Ohm's original form when the time is prolonged in one case, and the frequency or inductance disappears in the other.

Measurement of Resistance

One of the most familiar of all tests is that carried on for the purpose of ascertaining the resistance of a conductor. Though it would seem as if this included the general scope of all tests of this character, yet other tests of equal importance in an engineering sense must be made of the very opposite of good conductors, namely, insulators. Thus, tests of resistance might be generally classified as measurements of very low resistances, very high resistances and of resistances which occupy a middle place between these two. To illustrate—resistances of 0.01 of an ohm, of 1000 ohms and of 1,000,000 ohms, repre-

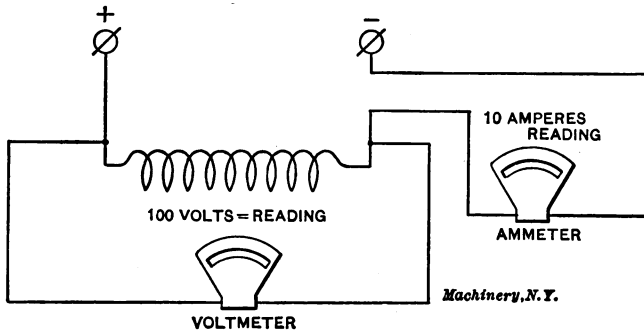

Fig. 17. Obtaining the Resistance in a Circuit

sent a great difference in value, and different methods must be used for each. A few of these methods will be considered under the heads of: 1. Drop of Potential Method; 2. Method of Substitution; 3. Wheatstone Bridge Method.

Drop of Potential Method

There is no reason to believe that a simpler method than the drop of potential method can be presented in developing devices of resistance measurements. It is based upon the proposition contained in one form of Ohm's law that the pressure which is necessary in a circuit, to send a given current through a given resistance, is equal to the product of this current by the resistance. In other words, if the problem is presented to find the resistance of a circuit (see Fig. 17) whose lost pressure or "drop" equals 100 volts when carrying a current of 10 amperes, the answer can be readily given on the above basis. A loss of 100 volts, or whatever it may be, is caused by a cer-

tain current passing through a definite resistance. The problem in arithmetic form then becomes, $100 = 10$ times what value? It is quite evident that the value to be found is 10. The drop in pressure between the ends of the circuit being 100, and the current being 10 amperes, the resistance must be 10 ohms. The drop of potential method therefore, consists in a measurement with an instrument called the voltmeter (instrument for measuring electromotive force or electric pressure in volts) of the drop of pressure between the ends of a circuit through which current is passing. The next step is the measurement of the current itself with an ammeter (instrument for measuring current in amperes). Dividing the volts by the amperes will give the ohms as indicated. The test may be made in other ways, which merely represent modifications of this idea without any real change in the method. For instance, if the resistance of the circuit

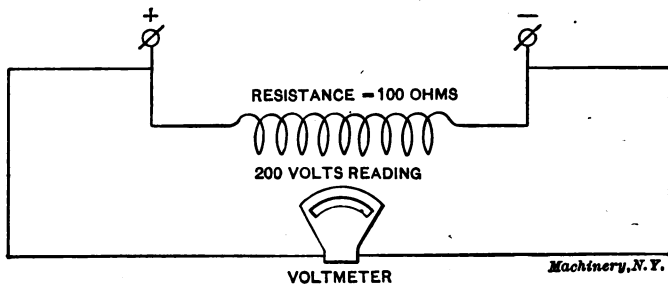

Fig. 18. Obtaining the Strength of Current in a Circuit with a Voltmeter and a Known Resistance

is known, it is a simple matter to find the number of amperes passing through, by ascertaining the drop in exactly the same manner. The drop in volts divided by the ohms will give the amperes. On the other hand, the idea may be still further developed for the purpose of discovering the volts consumed by the circuit. In this case the resistance, which is known, is multiplied by the current which is measured. The product will give the volts lost or "drop" of the circuit. The general idea thus presented covers a means of obtaining the resistance if the amperes and volts are known; the volts, if the amperes and ohms are known; and finally the amperes, if the volts and ohms are known. It is legitimate to include all of these tests under the one general category. Rules and examples for the application of these methods are given in the following.

DROP OF POTENTIAL METHOD

To get ohms.....	Measure the drop and measure the amperes.....	Divide E by C
To get amperes.....	Ohms known; measure the drop,.....	Divide E by R
To get volts.....	Ohms known; measure the amperes.....	Multiply C by R

Examples of the Drop Method

A voltmeter (see Fig. 18) shows a drop of 200 volts between the terminals of a circuit carrying a certain current. The resistance is known to be 100 ohms; what is the current in the circuit? Dividing 200 by 100 gives a current of 2 amperes.

An ammeter shows a current of 10 amperes in a circuit having a resistance of 50 ohms (see Fig. 19); what is the pressure or "drop"? Multiplying 10 by 50 gives a voltage of 500.

How many ohms resistance has an incandescent lamp hot, whose terminal pressure is 120 volts, and which takes a current of 0.4 of an ampere. Dividing 120 by 0.4 gives a resistance of 300 ohms.

It is possible to use an ammeter as a voltmeter or a voltmeter as an ammeter by securing a definite length of copper wire of sufficient size to cause a slight drop when the current passes and yet not dissipate too much energy. For instance, 1000 feet of No. 10 B. & S. gage copper wire would give a resistance of 1 ohm. If a piece of wire is obtained whose resistance is known, and this wire is placed in series with a motor, the voltmeter, giving the drop across its terminals, will

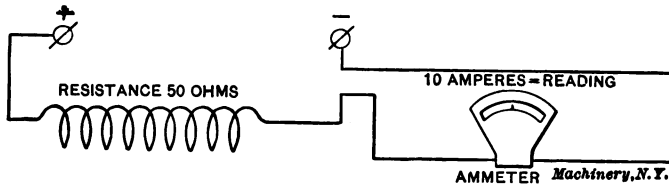

Fig. 19. Obtaining the Voltage of a Circuit with an Ammeter and a Known Resistance

be the means of measuring the current. If the voltmeter reads 2 volts, and the resistance of the wire is 0.1 of an ohm, then 2 divided by 0.1 equals 20 amperes. If instead of a voltmeter an ammeter is used, the test for volts can be made, but the resistance must be greatly increased and must be disconnected from the motor if accurate measurement of the pressure is to be made. If the line pressure is 220 volts, it may be sent through a resistance of 100 ohms, and the reading of an ammeter in series will complete the test. Under these conditions 2.2 amperes would be indicated, the product of this current and 100 ohms giving the line pressure, 220 volts.

Measuring High Pressures

For the measurement of pressures like 1000, 5000 or 10,000 volts, the following plan is practicable: Either 10, 50 or 100 lamps are connected in series. If about 1000 volts are to be measured, about 10 lamps will do. The total pressure is then sent into this series as shown in Fig. 20. A voltmeter is used for the purpose of taking the drop between the terminals of every lamp. The total is found when all results are added together. For instance, if the voltmeter indicated as follows: First lamp, 90 volts; second lamp, 95 volts; third lamp, 100 volts; fourth lamp, 110 volts; fifth lamp, 105 volts; sixth lamp, 98 volts; seventh lamp, 99 volts; eighth lamp, 102 volts; ninth

lamp, 85 volts; tenth lamp, 87 volts; then the total equals the sum of $90 + 95 + 100 + 110 + 105 + 98 + 99 + 102 + 85 + 87$ volts, or 971 volts in all. This is an early method of measuring the high pressures of alternating currents before high-reading voltmeters were made.

Method of Substitution

Measuring resistance by the method of substitution is really a comparative method. If a certain known resistance will cause an indicating instrument to show a deflection of 100 divisions, and then, when another resistance is put in its place, the deflection falls to one-half or 50 divisions, it is evident that the resistance must be twice as great. The reduced deflection means less current or more resistance. If the conditions are otherwise the same, the drop in the reading of the indicating instrument to one half proves the presence of twice the resistance. Ohm's law, as stated, that the current is directly proportional to the electromotive force, and inversely proportional to the resistance means, when applied to this case, that if the electromotive

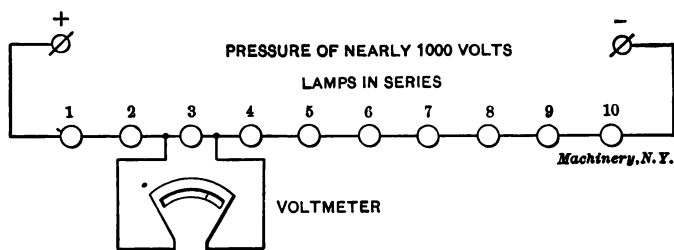

Fig. 20. A Method for the Measurement of High Voltage

force has not changed, but the current is one-half as shown by the deflection, the resistance is twice as great. To illustrate this idea, an instrument used for indicating electric currents, and called a galvanometer, may be connected to a cell of battery and a known resistance of say 100 ohms, as shown in Fig. 21. If under these conditions, the galvanometer gives a reading of 20 divisions, the record will read, 100 ohms, 20 divisions. Assume that the 100 ohms resistance is removed, and an unknown resistance, such as a lamp, is put in its place. Suppose the galvanometer now shows a deflection of only 5 divisions, as in Fig. 22. The conclusions to be drawn are as follows: If 100 ohms gives a reading of 20 divisions and an unknown resistance gives a reading of 5 divisions, then the unknown resistance must be greater. Its resistance is so much greater that it reduces the current down from that value which gives a 20 division reading, to a value so much less that only a 5 division reading is possible. In other words, the reading has been reduced in the galvanometer from 20 to 5 divisions because the current passing through it has been reduced. The reduction is due to the new unknown resistance substituted for the known resistance. If the resistance in the first case was 100 ohms, it must in the second case in conjunction with that of the galvanometer, be

four times as great as the original resistance. If the galvanometer resistance equals 100 ohms, then it is evident that $100 + 100 = 200$ ohms causes a deflection of 20 divisions. It also shows that $100 +$ an unknown resistance gives a deflection of 5 divisions. The question that naturally arises is "What is the unknown resistance?" As previously stated, it must have taken four times the resistance to reduce

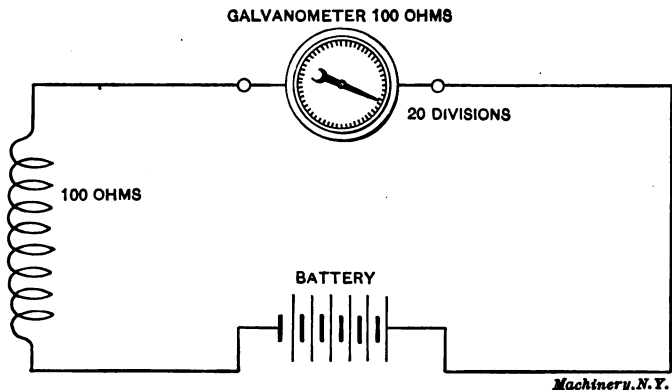

Fig. 21. Galvanometer used for Measuring Resistances by the Method of Substitution

the reading from 20 to 5 divisions. This being the case, the 200 ohms in the first instance must have been increased to 800 by the addition of the unknown resistance. If the galvanometer resistance, however, is 100 ohms, then the unknown resistance must be equal to 700 ohms. Thus, the method of substitution as outlined, calls for a knowledge of the resistance of the galvanometer, or indicating instrument.

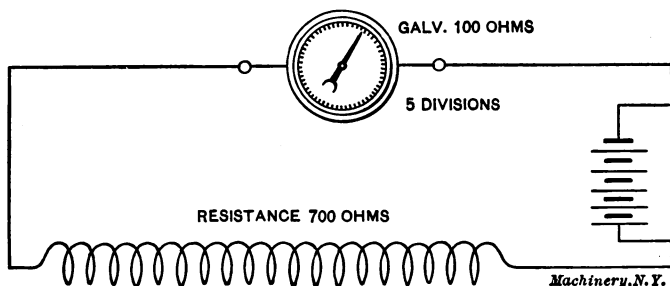

Fig. 22. Reading of Galvanometer when Unknown Resistance is Substituted

It also calls for a knowledge of the value of the first resistance interposed. With these facts known, it is evident that any reasonable resistance may be substituted for the first, and if the deflection is taken, the resistance is readily calculated.

Measuring the Resistance of Insulation

The resistance of insulation is enormous compared with that of conductors. An insulator, so-called, is not an absolute non-conductor,

but a very poor one. The idea is relative. A pressure of 1000 volts, applied to a resistance of 1000 ohms would mean a current of 1 ampere. A pressure of 1000 volts applied to a resistance of 1,000,000 ohms, would mean a current of 1/1000 of an ampere. If the pressure is lower, the current is correspondingly less. A telegraph line is supported on insulators. Though made of glass, these insulators permit current to leak from the line to the ground. Not one support alone, of course, is responsible for the entire leakage. An infinitesimal current from one, multiplied by the number of insulating supports, would give the total current. If in the above case, the one thousandth of an ampere was multiplied by 10,000, the total would equal 10 amperes. This is not entirely an imaginary case for the reason that 10,000 insulators, at the rate of 25 to the mile, would only equal 400 miles between stations. The leakage per insulator might be less than that stated, but whatever it was, it would be multiplied by 10,000 on a 400-

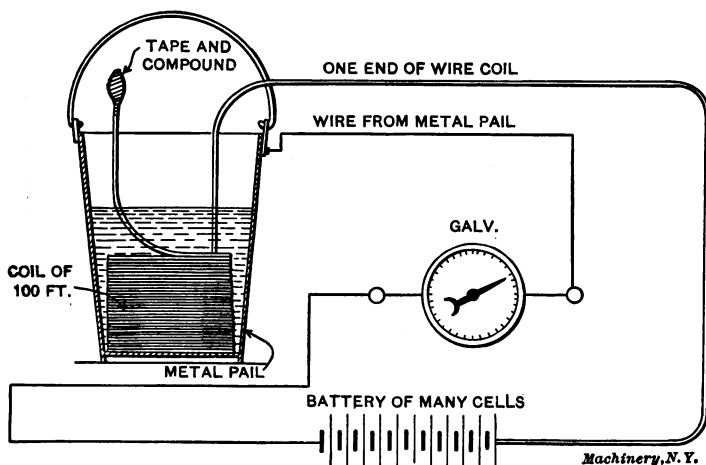

Fig. 23. Measuring the Insulation Resistance of Rubber Covered Wire

mile line. Not only is it necessary to know the relative merits of insulators for line service in order that line leakage may be reduced to its lowest value for telegraphic and other lines, but the insulation of power-carrying wires must be known as well.

The following is an outline of the method of measuring insulation resistance, by the principle of the substitution of one resistance for another: The requirements are a metal pail, a sensitive high resistance galvanometer, and a carefully tested high resistance. (See Fig. 23.) With these, the value of the resistance of high-grade insulation, reaching into the millions of ohms, can be found. The insulator, or insulated wire, is so placed in the water that the current passes through from the metal pail and the conducting solution into the insulation, and then out via the wire. If a coil of insulated wire is tested, consisting of say 100 feet of rubber covered wire, then one end of the wire is carefully coated with tape and an insulating compound.

The other end leads out, as does also a separate wire connected to the metal pail. The coil is laid in the pail and covered with water slightly tintured with sulphuric acid to lower the resistance of the water. The preliminary test is then made with a resistance of 10,000 ohms, which will cause a deflection of 50 divisions in the galvanometer. Supposing the galvanometer to possess a resistance of 10,000 ohms, the first galvanometer deflection is due to 20,000 ohms in all. Removing the 10,000 ohms resistance from the circuit, the insulated coil situated as described in the water, is substituted in its place. If the deflection in this case is only one division, then it is clear that 50 times the resistance is in place now. In other words, where 20,000 ohms gave 50 divisions, it has taken 1,000,000 ohms to cut this down to 1 division. Of the one million ohms, 10,000 are due to the galvanometer resistance. The balance of 990,000 is the resistance of the hundred feet of insulated wire in the metal pail. As a single foot of wire would show a resistance higher than this, in fact 100 times as great, it may be

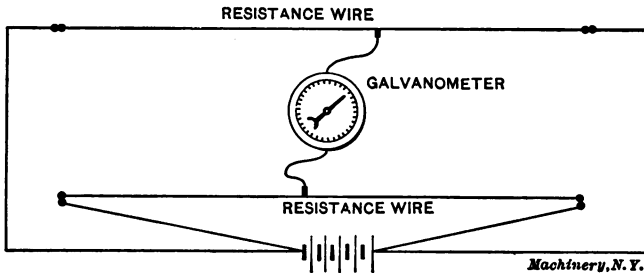

Fig. 24. Illustrating the Fundamental Principle of the Wheatstone Bridge

stated that according to the test, 1 foot of this wire has an insulation resistance of 100 times 990,000 ohms or 99,000,000 ohms, commonly called 99 megohms.

The Wheatstone Bridge

The Wheatstone bridge is an almost historic instrument, and is perhaps the most extraordinary device in the world. By its means, resistances can be measured with accuracy which express a range of difference equal to the ratio of one-thousandth to a million. This ratio numerically is that of one to a billion and cannot be equaled by any simple device in existence. It is as if a pair of scales could weigh with equal accuracy, one one-thousandth of an ounce and a million ounces. This extraordinary device is used for the purpose of measuring all kinds of resistances, high and low. The value of insulation resistances are discovered by the method just described; but for general resistance measurements, the Wheatstone bridge is universally used. It practically consists of a loop of wire so constructed that a galvanometer whose terminals rest on each wire of the loop, respectively, will indicate the difference in drop between one part of the wire to which it is attached, and the part of the other wire to which it is similarly joined. For instance, if two parallel wires of a certain

resistance carry a certain current, it is easy to realize that the terminals of a galvanometer will find a place on each wire respectively where the drop will be equal. (See Fig. 24.) Under these conditions no current could possibly flow into the galvanometer. If the upper or lower terminal of the galvanometer is shifted a trifle either way, it will take a potential higher or lower than that of the other wire, and a current will consequently flow through the instrument. When the two points spoken of are found, however, the galvanometer remains unaffected. This condition is expressed by saying that the *A* arm (see Fig. 25) is to the *B* arm as the *C* arm is to the *D* arm. By this is meant that the resistance of *A*, *B*, *C* and *D* bear a certain relationship to each other. If they are given such values as 10, 20, 40 and 80 ohms, then 10 is to 20 as 40 is to 80. The fact that *A* is to *B* as *C* is to *D*, is only true, of course, when the galvanometer terminals reach these particular points where the "drops" of the two wires are alike.

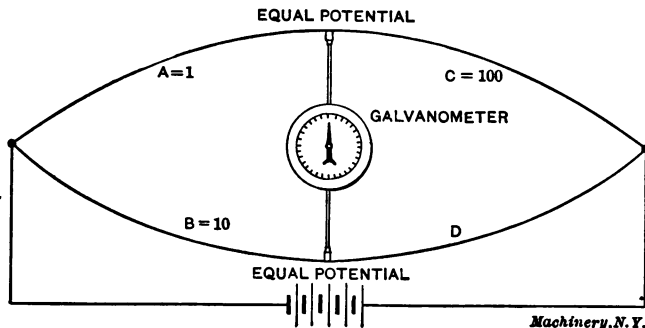

Fig. 25. Diagrammatical Representation of the Wheatstone Bridge

Now, if the two wires are joined at each end to form a loop with the galvanometer between and a battery supplying the joined ends with current, as in Fig. 25, then the conventional Wheatstone bridge appears ready for service. In practice, the *A* and *B* arms express the ratio of 1 : 10 or 1 : 100 or 1 : 1000. The *C* arm is adjustable, so as to develop a balance between itself and the resistance to be measured. Supposing the *A* and *B* arms are set at the ratio of 1 : 100, then if the unknown resistance is inserted, and the *C* arm adjusted by manipulating the resistance it represents until the galvanometer does not show any deflection, the bridge is said to be balanced. If the balance was only possible when the *C* arm was made equal to 100 ohms, then the *D* or unknown resistance must be equal to 10,000 ohms. The method is simple enough if the necessary ratio of $A : B = C : D$ is remembered. If, for example $A = 1$, $B = 10$, $C = 100$, then $1 : 10 = 100 : D$. According to these figures $D = 1000$ ohms. If the bridge is constructed with many *A* and *B* ratios, the range of measurement is thereby greatly increased.

CHAPTER III

BATTERIES

A battery as understood by the scientific world of to-day, is a device by means of which chemical energy is directly transformed into electrical energy. Were it possible to burn coal and obtain electricity without the aid of an engine or dynamo, the process would be very similar to that taking place in a battery. Here, the fuel is generally a metal and an acid, and from these two electricity is produced as a full equivalent of the transformation which takes place.

The Voltaic Pile

The Voltaic pile, Fig. 26, consists of a disk of zinc and copper resting together, then a disk of blotting paper slightly tintured with acid, then two more disks, respectively of zinc and copper, then blot-

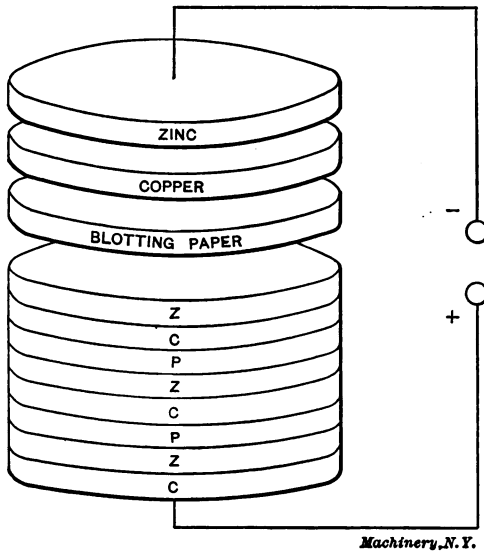

Fig. 26. The Voltaic Pile

ting paper, etc. This arrangement of metal disks is historic and proved a source of the greatest interest to the rising world of experimenters of over a century ago. As it represents the earliest type of battery of which any records exist, and as from it arose the multitude of diverse forms, including both the dry and the wet battery, with its many modifications, it is evident that an examination of the principles it embodies will prove interesting and instructive.

What is generally called a simple voltaic cell, Fig. 27, consists of a

jar containing a diluted solution of sulphuric acid and two elements. These elements are respectively plates of zinc and copper. On bringing together two wires attached to these plates, a current of electricity will flow.

Action on the Plates

The zinc plate will gradually dissolve in the solution, and while undergoing this process, it develops electricity. The copper plate seems to serve a different purpose. It is not affected to any extent by the chemical process taking place, but simply serves as a means of transmitting the electricity. For this reason the pole of the passive plate is called the positive and the pole of the plate acted upon is called the negative pole. In reality, the plates deserve opposite names, because the plate producing the electricity is the positive plate, although the

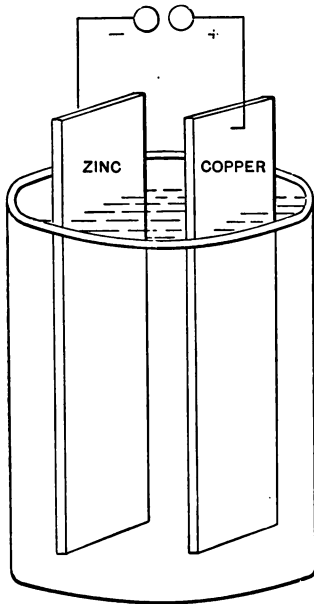

Machinery, N.Y.
Fig 27. Simple Voltaic Battery

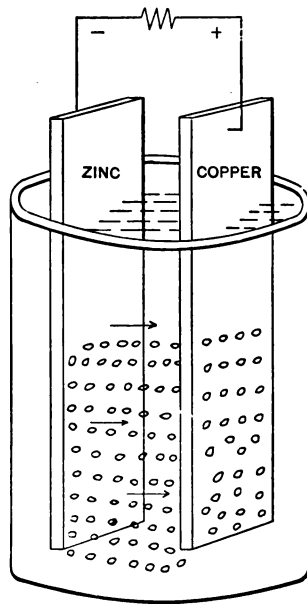

Machinery, N.Y.
Fig. 28. Principle of Process of Polarization

negative pole, and that to which the current is transmitted, is, more accurately speaking, the negative plate, though the positive pole.

The voltaic pile composed of alternate disks of copper and zinc, is a simple dry battery in which the dampened paper, slightly acidulated, acts upon the zinc and in producing chemical action develops electricity.

What is generally understood as chemical action, is a union taking place between dissimilar substances to form a new product. This is familiar to the layman as well as the chemist, but the fact that is not so evident is that whenever chemical action takes place, electricity

is developed. In other words, that which is called a battery, is simply a device in which chemical action is directly transformed into electricity.

Polarization

A simple voltaic cell will not run well very long. It will gradually fail and its power diminish to a point so low that little or no current is perceptible. A battery of this kind consists of two plates, as stated before—one of zinc and one of copper. These plates rest in an acid solution which attacks the zinc plate. If a jar of this character, containing such elements, is held up to the light the effervescence in the neighborhood of the zinc will be easily perceived. This is due to the sulphuric acid combining with the zinc, thus producing zinc sulphate and hydrogen gas. The solution will also begin to heat up, and a stream of hydrogen will pass across the liquid from the zinc plate, as shown in Fig. 28, and cluster around the copper plate. Hydrogen is one of the lightest and consequently the most buoyant of gases, yet it will not rise from the zinc to the surface directly, but instead moves horizontally to the copper plate. The clustering of these hydrogen bubbles around the copper plate has the effect of weakening the current to such an extent that it is merely necessary for enough of them to gather to completely destroy the value of the cell as a producer of electricity. When this condition has been reached the battery is said to be polarized. Polarization, therefore, is a condition in a cell brought about by chemical and electrical action through which hydrogen gas is deposited upon the copper plate and interferes with or prevents the action of the cell.

The gas on the copper plate is carried over by the current. The action is called electrolytic, by which is meant that an electric current has the power of carrying over from pole to pole certain constituents that it finds there. In the case of a simple electric cell, the current travels from the zinc through the liquid to the copper plate. The action therefore is exactly similar to electroplating, only instead of zinc being carried over, hydrogen is transmitted. The copper plate is therefore plated with hydrogen gas, which has two effects upon the action of the cell as an electrical generator. First, the hydrogen acts as a non-conductor, and therefore prevents the electricity from passing into the copper plate; second, the hydrogen has the effect of tending to develop a current in the opposite direction in conjunction with other elements of the cell. These two injurious influences cause the simple voltaic cell to cease its action after a short time has passed.

The ebullition due to intense chemical action will not diminish even though no current flows outside. The process by which current can develop and be used under these circumstances is seriously interfered with, and in consequence methods are employed to destroy the effect of polarization in a cell.

Methods of Depolarization

The methods of depolarization may be classified under three distinct headings:

First—Depolarization by mechanical means.

Second—Depolarization by chemical means.

Third—Depolarization by electro-chemical means.

There are no primary batteries in use which do not employ one of these three methods to accomplish the purpose in view, namely, the annihilation of polarization.

Mechanical Method

The mechanical method is the simplest method of all to grasp, as it is quite evident that if the liquid in the battery is vigorously stirred the hydrogen bubbles will be dislodged and the gas thus freed will pass to the surface and disappear. The liquid can be kept flowing, which will accomplish the same purpose.

In many early batteries, air was blown through the liquid and the hydrogen thereby removed. One of the most interesting cases of the

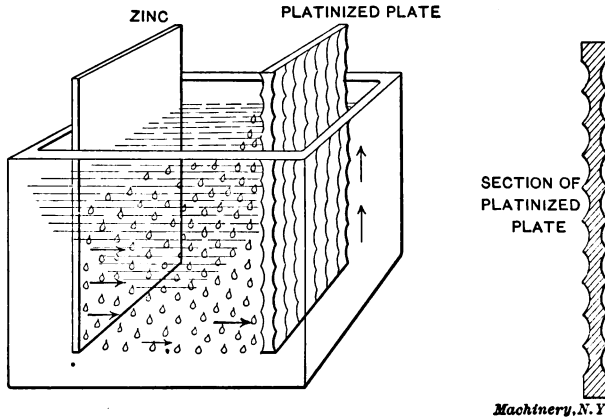

Fig. 29. The Smee Battery with Corrugated Platinized Plate for Preventing Polarization

application of mechanical means is found in the Smee battery. This is a cell greatly in vogue in the past for electroplating necessitating the use of powerful electric currents. The negative plate of this cell (see Fig. 29) was constructed so that it presented a surface of platinum to the liquid, but not a smooth surface. It was rough and prickly, and the general appearance of it, as shown, indicates the difficulty with which hydrogen bubbles could lodge and adhere to the surface. In a cell of this kind the hydrogen passes freely over from the zinc to the platinized copper plate with the result that a continuous stream of hydrogen gas ascends from the negative plate to the surface of the liquid. It is possible, therefore, to sum up the mechanical method of depolarization in the following manner:

First—Depolarization by agitating the liquid.

Second—Depolarization by air blown through.

Third—Depolarization by using rough plates.

Means are employed nowadays which insure to a large extent the continued action of the battery in cases where such action is expected.

Open and Closed Circuit Batteries

Polarization has been the means of dividing batteries up into two general classes. They are called:

1. Open circuit batteries.
2. Closed circuit batteries.

In the open circuit batteries it is the intention of the manufacturers to produce a cell which can be used for occasional work without attention. The so-called dry cell, Fig. 30, is a well-known type of this kind. These cells polarize rapidly, but only when kept in continual use. On the other hand, if placed on a shelf or in an out-of-the-way place they require no attention and may be thrown away at the end of a year or more of intermittent use. Such cells are distinctly open circuit cells, that is to say, they are on open circuit most of the time. If kept on a closed circuit for any longer period, polarization will set in and the cells rapidly become useless unless allowed to recuperate. An open circuit cell is not provided with means for rapidly depolarizing its negative plate. It has not the proper chemicals within to destroy the hydrogen gas rapidly enough to permit an uninterrupted and undiminished flow of current.

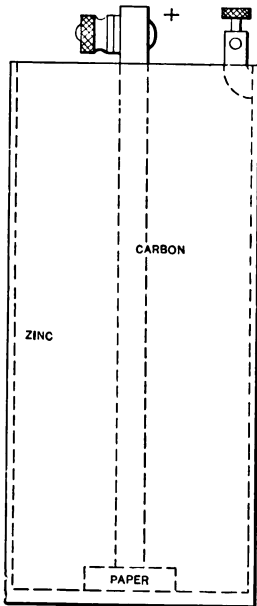

Machinery, N. Y.

Fig. 30. Open Circuit Dry Battery, Showing Zinc Envelope Containing Chemicals and Carbon Plate

In the closed circuit batteries the opposite idea in a sense prevails. The manufacturers of these want to provide a source of electricity which can be permitted to flow for long periods of time without considerable diminution of strength. One of the most familiar batteries of this type is the old gravity battery so much employed on telegraphic lines. It may be connected up to a circuit and will give current for weeks and months at a time. In fact, it is so distinct a type of the closed circuit battery that, whereas the dry cell as an open circuit battery must not be on closed circuit for more than a few minutes at the most at a time, the gravity battery must be kept on closed circuit and must not be left on an open circuit for more than a short time during its use.

In a dry cell depolarization is slow, but the cell will not eat itself up rapidly when not in use. In the gravity cell depolarization is rapid but the production of current is limited, though continuous, and in this respect the open and closed circuit batteries represent fundamental ideas based upon the method of producing depolarization rapidly and continuously or slowly and occasionally.

The greatest activity in battery invention took place in France thirty

or forty years ago. In one of the principal squares of Paris, electric lamps were set up, and the current supplied to them was obtained from powerful batteries. One of the famous equipments installed was called the cascade battery, Fig. 31, which consisted of tier upon tier of cells arranged on a pyramidal series of platforms. The liquid was pumped from a receiving tank at the bottom to the upper cells and from them it descended through a series of pipes to the tank below, thus passing through all cells in succession. The liquid in this system was in a constant state of motion and thus a mechanical method of depolarization was obtained.

In some cases part of the current was diverted through a motor, which, by running a fan, blew air through the liquid of the cells. In other cases the liquid was stirred and this effectually dislodged the hydrogen bubbles. All the methods outlined produced an agitation in

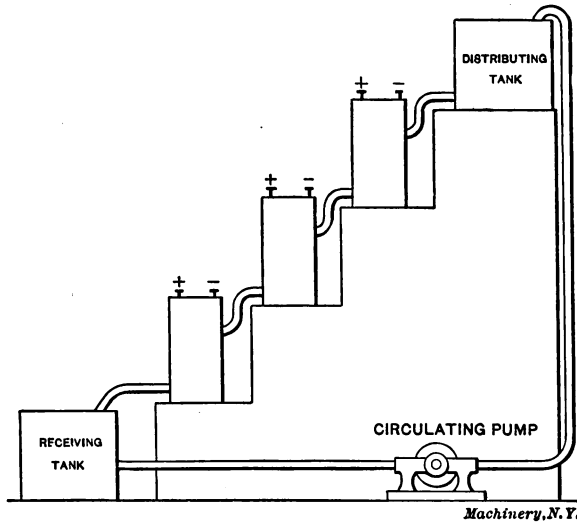

Fig. 31. Batteries with Circulating Fluid

the liquid which caused depolarization; but by far the most important of the three classified means of producing depolarization is the chemical method.

Chemical Method of Depolarization

Hydrogen is a gas possessing a great affinity for oxygen. The use of a chemical mixed with the solution, the said chemical possessing a great deal of oxygen, would be effective in combining with the hydrogen, and thus free the cell from the injurious effects of polarization. A chemical in common use for this purpose is bichromate of potash. This crystal possesses a great deal of oxygen bound up with the other elements which constitute it. In consequence of this, when a diluted solution of sulphuric acid dissolves crystals of bichromate of potash, the new solution possesses hydrogen-absorbing properties which are

used directly in the construction of what it called a bichromate of potash battery.

When the acid solution attacks the zinc, hydrogen gas in very small bubbles is released and carried over towards the other plate, consisting in this case of carbon. It is rapidly taken up by the bichromate in solution, the oxygen combining with the hydrogen and thus permitting the cell to continue to develop a strong current. If the chemical activity between the zinc and the acid is too intense, gas will be released more rapidly than the oxygen in the bichromate can absorb it. In this case, a gradual polarization would ensue and the battery weaken. A battery will polarize, therefore, in spite of the chemical method of depolarization if sufficient depolarizing material is not employed.

In the so-called open circuit cell depolarization is not rapidly carried on. The depolarizing material, such as that used in dry cells, is dioxide of manganese, which simply represents a chemical containing enough oxygen to slowly absorb or combine with hydrogen. When a dry cell is in use, the salammoniac in contact with the zinc shell of the battery releases hydrogen gas. This gas attempts to pass through the cell to the carbon pole. Before reaching it, however, the dioxide must be traversed. Here the hydrogen is assimilated and the carbon freed from the effects of polarization. The dioxide cannot absorb the hydrogen very rapidly. This is the reason why a dry cell will quickly polarize if used continuously. Were it constructed, however, with a great deal of the depolarizing material arranged around and in contact with the negative plate, it is very likely that the cell would be able to operate continuously while giving a comparatively powerful current; but this would mean a bulky cell and an expensive one as well. The salammoniac solution which acts upon the zinc merely dampens the pulp or packing which is employed in contact with the zinc. A dry cell is therefore a damp cell inside though sealed on top to prevent evaporation.

A cell which polarizes quickly is merely a cell whose constituents combine with the hydrogen slowly. On the other hand, a cell which can remain on a closed circuit a long time is one which absorbs the hydrogen quickly. This distinction is very important and shows that the classification on this basis is the only practical one to make with reference to the utility of the cell.

Mixed Types of Cells

Cells have been constructed which possess the qualifications that entitle them to be used for both intermittent and constant service. A cell of this description also makes use of bichromate of potash and a diluted solution of sulphuric acid. As a general rule the water is acidulated until a 10 per cent solution is made—ten parts water and one part acid. In the simple form of the bichromate battery it is the custom to saturate the solution with bichromate crystals. To accomplish this, warm water is employed in which enough crystals are dissolved, and then the acid is added.

A rule which must never be broken is that the acid must be added to the water, *never the water to the acid*. If this rule is not observed serious injury may result to the experimenter. The jar will crack through the intense heat and the acid will spatter around. If it gets into the eyes or on the hands or clothes an alkaline solution must be applied at once. Ammonia or soap and water are effective antidotes.

Action on the Zinc

Before considering other types of batteries, a curious phenomenon must be observed in connection with the zinc. If a rod of zinc is used as one element and a rod of carbon or copper as the other, then when both are inserted into a diluted solution of sulphuric acid, effervescence immediately begins in the neighborhood of the zinc. The acid attacks the zinc in the following manner:

Sulphuric acid + zinc = zinc sulphate + hydrogen.

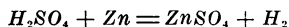

This simply means that the acid and zinc combine forming zinc sulphate and thus release the hydrogen from the acid.

In an ideal cell, the zinc should not be consumed unless the battery is in use. And it may be furthermore stated that *pure zinc* will not eat away in a diluted sulphuric acid solution. The question then naturally arises, "Why does the zinc eat away at all?" To answer this question correctly, it is necessary to understand that commercial zinc is impure, and in consequence of this, the impurities with which it is permeated, such as particles of iron and carbon, etc., form small voltaic cells with the zinc in which they are embedded. This causes intense chemical action, and the zinc wastes away, whether the cell is in use or not.

Amalgamating the Zinc

To remedy the serious and otherwise insurmountable defect mentioned in the previous paragraph, a coating of mercury is applied to the zinc rod. First the zinc is dipped in a solution of diluted sulphuric acid, and then, after it is thoroughly clean, the mercury is poured over it, or it is dipped into a dish or bottle containing mercury. If a rag is used the amalgamating process is carried on more successfully. The action of the mercury is as follows: It dissolves the zinc, leaving the impurities behind, and thereby presents to the action of the acid a coating of pure zinc mixed with mercury. The mercury is perfectly neutral, and in consequence a well amalgamated piece of zinc may be allowed to remain in an acid solution for many days without any waste of the zinc taking place. A bichromate of potash battery supplied with well amalgamated zincs, will use up the zinc only when the battery is in use. If there are impurities in the mercury or acid, a slow action will take place, and the zinc, if allowed to remain in the solution, will disappear. This difficulty has been met in at least one instance by the invention of a means of automatically amalgamating the zinc.

A cell called the Fuller mercury bichromate employs the follow-

ing method for automatically amalgamating the zinc. Instead of a zinc rod, a cone of zinc is employed. This rests on the bottom of a porous jar, Fig. 32, and into the jar a tablespoonful of mercury is poured. A diluted solution of sulphuric acid is then poured into this jar. An outer glass jar holds a bichromate of potash solution, and in this solution either one or more carbon rods are suspended. If the acid solution acts upon the zinc, there is always mercury there to heavily reamalgamate it. This is of course an automatic action, the mercury climbing up the cone of zinc, and thereby preserving its integrity until the battery is on a closed circuit. The hydrogen which is released passes through the walls of the porous jar, and meets the bichromate solution which combines with it.

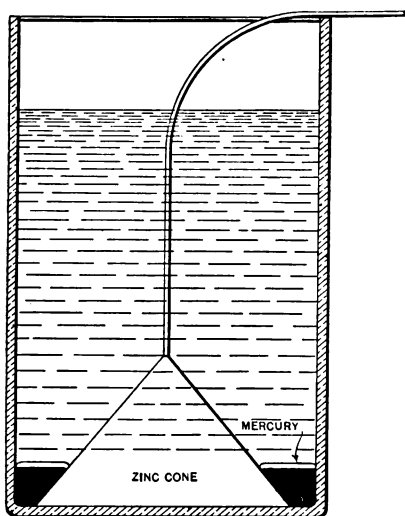

Machinery, N. Y.

Fig. 32. Automatic Amalgamation

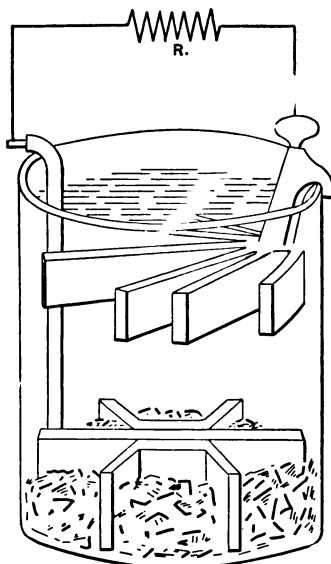

Machinery, N. Y.

Fig. 33. Closed Circuit Gravity Battery

A cell of this description may be used for continuous work, and will under these circumstances deliver a strong current. On the other hand, if used only occasionally, it will act as an excellent open circuit battery, because no waste of material can take place when it is not in use. Evaporation will occur, and the acid may lose its strength in the course of time, but cells of this character are good for several years of service on open circuit and are exceptionally reliable for closed circuit work as well.

Recapitulation

In relation to prevention of polarization, two methods have been considered: the mechanical and the chemical. The purpose of amalgamation is to prevent "local action." This is the term employed to describe the injurious effect of the presence of impurities in zinc. It

has been attempted by manufacturers to cast the zinc with mercury, and thus offer on the open market a zinc presumably free from local action when in use. The effort was unsuccessful, because the zinc did not retain enough mercury to make such an alloy equivalent to a thorough amalgamation, neither has it been found possible, except in rare cases, to substitute any other metal for zinc in a battery. Thomas A. Edison has succeeded to some extent, but the fact remains, that to-day, both dry and wet cells employ zinc as an indispensable element, and in addition a positive plate of carbon or copper.

The Electro-chemical Method of Depolarization

The third method of reducing or removing the hydrogen from a battery may be found in the first popular type of cell in practical use. This cell, greatly used to-day, and exclusively employed in this country in the past for telegraph lines is called the gravity battery. The name was given to it because the two solutions this battery holds when in normal action are separated from each other solely by gravitation. The two solutions are respectively sulphate of copper, which is in this case the under layer, and sulphate of zinc, the layer of solution resting on the first. Their specific gravities prevent them from mixing as long as they remain undisturbed. In this cell a crowfoot of zinc is suspended above in the sulphate of zinc solution. Below is found a cross of copper surrounded by a solution of sulphate of copper, and with copper heaped around it. (See Fig. 33.)

The zinc is acted upon by the solution around it and hydrogen gas is produced which seeks to travel downward to reach the copper cross below. (See Fig. 34.) Here it enters the sulphate of copper solution at the point where both meet. The sulphate of copper solution seizes hold of the hydrogen gas, but substitutes for it a particle of pure copper. The pure copper particle continues to travel toward the copper cross the same as if it were the hydrogen bubble. It follows the same route and finally attaches itself to the copper cross. This action, instead of interfering with the output of electricity from the cell, improves it. When the hydrogen gas meets the sulphate of copper solution the following exchange takes place:

Hydrogen + sulphate of copper = copper + sulphuric acid.



This means that when hydrogen gas and sulphate of copper combine, sulphuric acid is made and pure copper (*Cu*) is separated. In the electro-chemical method of depolarization the hydrogen gas is held, and the resulting copper sent on in its place over the same path to deposit itself, instead of the hydrogen, on the copper element. This, of course, results in an accumulation of pure copper on the copper element, the complete absence of polarization, and an absolutely continuous current of electricity of increasing instead of diminishing strength.

This brilliant idea of substituting a metal through the agency of electricity, in place of the hydrogen gas is originally due to Daniell, the

inventor of the famous Daniell cell at one time accepted as a standard of electric potential, but subsequently converted into the now better known gravity battery. The Daniell cell, like the gravity battery, makes use of the same elements and naturally operates along the same general lines.

Zinc as Fuel

Power is produced in a cell by chemical action taking place between the zinc and acid. As zinc is employed in the great majority of batteries, and as this metal is consumed during the operation of the cell, it must be regarded as the fuel through which the transformation of chemical energy into electrical energy is effected. If during the operation of a cell, the liquid becomes very warm, it is a sign that the processes are not taking place properly, and the energy which should be transformed into electricity is being dissipated as heat.

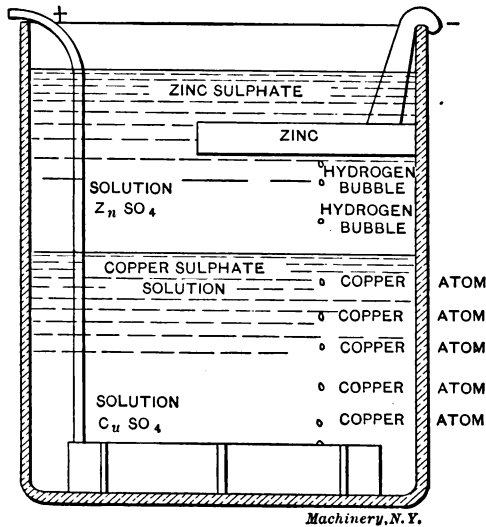

Fig. 34. Illustrating the Action of the Gravity Battery

If zinc is to be regarded as fuel, the battery utilizing it cannot be considered as differing essentially from a steam boiler, whose power in the form of steam under pressure is the result of the chemical processes taking place between the coal and the oxygen in the air. In the general run of steam plants it takes from 4.5 to 6 pounds of coal to give 1 horsepower for one hour. In a battery it takes from 1 to 2 pounds of zinc to give 1 horsepower-hour. The reason why the amount of zinc per horsepower-hour differs so much is because the number of volts produced by different cells differ. For instance, it is well known that the number of volts produced by a zinc and copper cell are about 1, whereas the number of volts produced by a zinc-carbon cell is about 2. In other words, the elements composing a cell give a number of volts depending upon the character of the elements em-

ployed and the nature of the solution. If this is true, then it must be understood that the amount of zinc consumed to produce a current of a given strength is always the same. The exact amount of zinc consumed to give a current of 1 ampere for one hour is 1.2133 gram. If these figures are turned into the English system, it will be found that the following results are obtained:

Volts of Cell.	Horsepower-hours.	Weight of Zinc.
1	1	2 pounds
1.5	1	1.33 pounds
1.75	1	1.14 pounds
2.00	1	1.00 pounds
2.5	1	0.80 pounds

To test a battery it is necessary to weigh the zinc plate before and after it has developed a given amount of current for a specified time. If there are marked differences between the figures obtained, and those given in the table, local action will be sufficient to account for them. Comparing the cost of electricity obtained from batteries with that obtained from electric light plants, the figures in the following will indicate the impossibility of the former at present competing with the latter. The question is essentially a commercial one, in which the contrasting figures show the costliness of electricity obtained by chemical action in batteries.

Cost of Electricity from Bichromate Batteries

A solution of sulphuric acid and bichromate of potash of the following proportions, costs about 35 cents a gallon: 1 pint water dissolving 3 ounces bichromate of potash; add 2 ounces sulphuric acid.

The cost of the zinc would be about 15 cents a pound, well amalgamated with mercury. On this basis, estimating that one pound of zinc will require one gallon of solution, it is easy to see that the generation of 1 horsepower-hour would involve the following expense with a 2-volt battery:

Zinc, 1 pound.....	15 cents
Solution, 1 gallon.....	35 cents
	—
Total	50 cents

If these figures are compared with the cost of a horsepower-hour produced in an electric light station, where this power costs about 4.5 cents instead of 50, the ratio between the two is more than 10 to 1 in favor of the dynamo plant.

If batteries are used which give less than two volts, the cost rises until it is seen that any claims to do electric lighting, or to supply power from batteries, are necessarily absurd if the proposition is framed so as to indicate attempted competition with electric light and power plants.

The possibilities associated with the primary battery are very great from a theoretical standpoint. Many efforts have been made to obtain the energy from coal by electrical means without resorting to direct

oxidation and combustion. If it were possible to reduce coal, so that while oxidizing it did not develop heat, but electricity, then a great problem would be solved. A well-equipped electric light plant is able to get the effect of about 14 pounds of coal out of every 100 pounds consumed. On this basis it is evident that more than six times the amount of power obtained is wasted through radiation, etc. An electrical method of reducing coal so as to transform its heat energy directly into electricity would represent a great saving of fuel and power. The general efficiency of a battery is high in comparison with an electric light plant. While a battery has over 70 per cent efficiency an electric light plant has only 14 per cent. But, as shown by the last

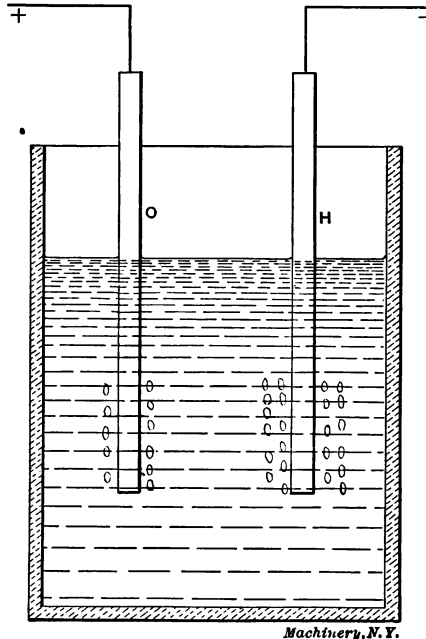

Fig. 35. Decomposition of Water

figures, the cost of the materials consumed is too great. This being the case, further progress in the field of battery construction is impeded.

Storage Batteries

Place the terminals of a battery of cells in acidulated water, as in Fig. 35, and note the bubbles which appear at the positive and negative poles. A close examination will reveal the fact that there are more bubbles at the negative than at the positive pole. The process taking place is this: The electricity in passing from pole to pole decomposes the water; the two gases composing water are oxygen and hydrogen and these gases collect at the two poles, the oxygen appearing at the positive, and the hydrogen at the negative pole. There is more hydro-

gen than oxygen because water when decomposed yields twice as much hydrogen as oxygen.

If tubes, as shown in Fig. 36, are used to collect the gases at the two poles and these tubes partly dip into the water along with their platinum electrodes, then, when sufficient gas has been collected the following experiment can be tried: A galvanometer can be attached to the two electrodes, as in Fig. 37, and the effect of this connection noted. The needle of this instrument will, at the moment of connection, swing from a position of rest and indicate the passage of a strong current. The only explanation of this is by reference to the two gases and the electrodes. Here is a case of a current appearing, as if this combination of tubes, gases and electrodes with water represented the constituents of a battery. By sending a current into this combination of parts, gases are evolved. On bringing the terminals from the tubes

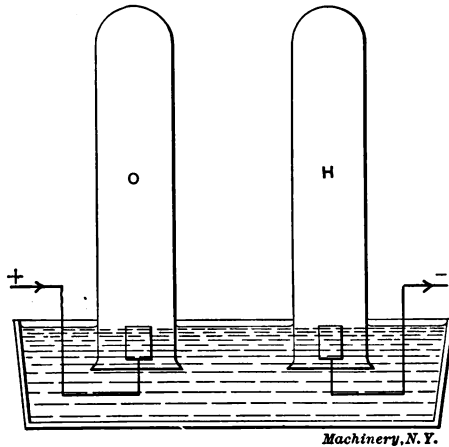

Fig. 36. Collecting Oxygen and Hydrogen in Tubes

together, after disconnecting the original source of electricity, a current is returned. This is, in many respects, the first type of storage battery evolved, and from this developed many of the types in common use to-day.

Gaston Plante may be considered the father of the modern storage battery. He tried the foregoing experiment and then decided to try metals other than platinum for his electrodes. The results obtained by the use of lead plates were so successful that little if any scientific progress has been made in this direction since his day. Lead electrodes when dipped in diluted sulphuric acid, and carrying an electric current, begin to oxidize. The plate connected to the positive pole becomes coated with a film of peroxide of lead, a reddish spongy development. The other plate, connected to the negative pole, is oxidized to a lesser degree. In this case the coating is one of dioxide of lead, a grayish and less spongy surface. (See Fig. 38.) When these

oxidized surfaces appear, if the current is stopped and the electrodes connected to a meter or indicating instrument like a galvanometer, a powerful current will be noted.

The current will continue to flow from the plates for a while, and then it will cease. In order to develop a capacity within the plates for a continued supply of current, Plante found it necessary to "form" the plates. This is accomplished by sending a current in one direction, and then discharging the cell, and then in the other direction, and discharging the cell. By repeating this process and lengthening the intervals of charging the plates and discharging them, the so-called forming process is eventually completed. When the plates are formed, they are of a spongy texture, but their capacity is greatly in-

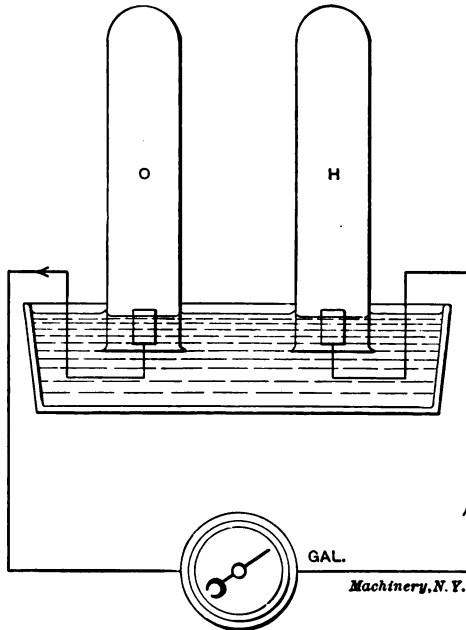

Fig. 37. The Simplest Type of Storage Battery

creased. The gases formerly seen at the beginning of the process do not appear. All of the energy applied in the form of electricity, in a theoretically perfect cell, is transformed into chemical energy within the porous and spongy plates of dioxide and peroxide of lead.

A storage battery, therefore, is a device which receives electrical energy, and transforms it into chemical energy, and which again transforms this latter into electrical energy when the cell is being discharged. During this process some of the energy is wasted in heat and in decomposing the solution. The dissipation of energy occurs while the cell is being charged and again when it is being discharged. About 30 per cent of the total power is thus lost.

A storage battery, after it is charged, possesses nearly all of the features of a primary battery. The gradual transformation of the lead plates into oxides, whose relationship to each other in the acid solution gives rise to a current, makes it clearly evident that the oxides are responsible for the result although they themselves are the direct effect of electrolytic action.

The Inventions of Brush and Faure

Charles F. Brush in America took out patents on a rather different type of plate from that known as the Plante. Camille Faure, of France, laid claim to the same general improvement as that about to be cited. He argued that the development of the lead oxides on the

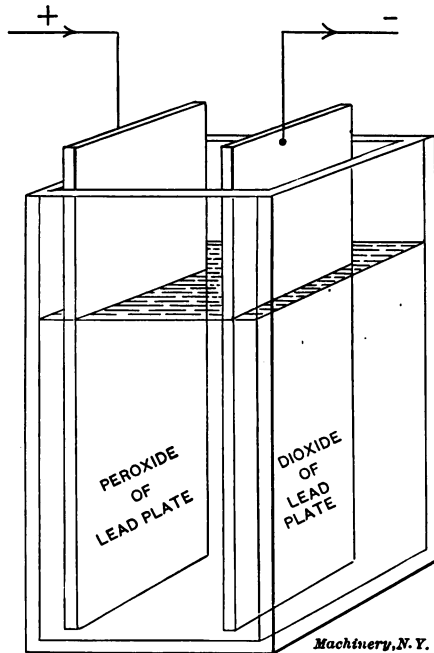

Fig. 38. Practical Form of Storage Battery

lead plates through the "forming" process is necessarily a slow and expensive method and proposed to hasten it by the application of lead oxides to the surface of the lead. A red lead paste was originally applied to both plates, and this, by the action of the current, was reduced to the oxides found on the original Plante plate. Eventually a lead grid, Fig. 39, was invented, in the openings of which the oxides were pasted. Red lead paste was applied to the positive, and a paste made of litharge to the negative grid. By this means intimate contact was secured between the grid and paste and it became easier to obtain what is called "an active surface."

The pasted grid plate has the advantage of both lightness and ca-

capacity and thus improves the utility of the storage battery in this respect. A Plante plate is very weak unless reinforced by the use of thick lead. Grids, however, can be made of an inoxidizable material to resist deformation. For automobile service, as well as for station use, the storage battery has found a distinct field.

Defects of Storage Batteries

The defects of storage batteries may be classified under the two following heads—sulphating and buckling. The first, sulphating, is due to the plates being left in the acid solution uncharged. The second, buckling, is due to the discharge being too heavy and thus bending or buckling the plates.

Sulphating is avoided by keeping the batteries charged, never allowing the charge to fall below a certain point. The means for detecting

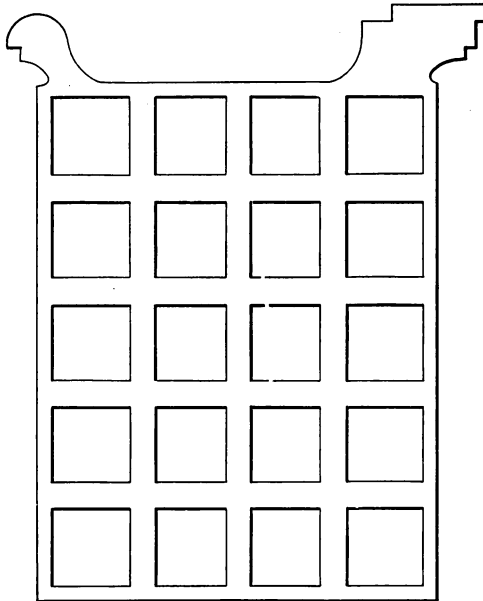

Machinery, N. Y.

Fig. 39. The Lead Grid to which Paste is Applied

when the charge falls below the required point is to be found in the voltage of the cell. When fully charged its voltage is 2.2 and when being discharged it should not be allowed to fall below 1.9 volts. By adhering to this rule sulphating is avoided. The action of the acid on the lead forms a whitish cement-like coating, which consists of sulphate of lead. This can be scratched off only with great difficulty, but may be eventually transformed into an oxide by continued charging. A strongly built plate will resist the warping influence of a heavy discharge. The standard types found in the open market are built on these lines and serve the purpose expected of them satisfactorily.

Capacity of Storage Batteries

The area of the plates governs their capacity, as well as the amount of active material they contain. One cell with twice the plate surface of another cell would have about twice the capacity, other things being equal. Catalogues of the manufacturers of storage batteries will supply this data, which varies with each particular style of plate. The rating is given in ampere-hours, which means a given strength of current for a given number of hours, a greater current for less hours or less current for a greater number of hours.

THE
UNITED STATES
GOVERNMENT

THE
AMERICAN
MUSEUM OF
NATURAL HISTORY

