

TJ

7

M3

v. 68

UC-NRLF



B 3 018 789

# MACHINERY'S REFERENCE SERIES MACHINERY'S

EACH NUMBER IS A UNIT IN A SERIES ON ELECTRICAL AND STEAM  
ENGINEERING DRAWING AND MACHINE DESIGN AND SHOP PRACTICE

No. 68

A Dollar's Worth of Condensed Information

# Boiler Furnaces

Price 25 Cents

## CONTENTS

Combustion and Fuels	- - - - -	3
Furnaces	- - - - -	11
Mechanical Stokers	- - - - -	23
Mechanical Draft	- - - - -	30
Oil Fuel	- - - - -	35
Chimneys	- - - - -	40

The Industrial Press, 49-55 Lafayette Street, New York  
Publishers of MACHINERY

COPYRIGHT, 1911, THE INDUSTRIAL PRESS, NEW YORK

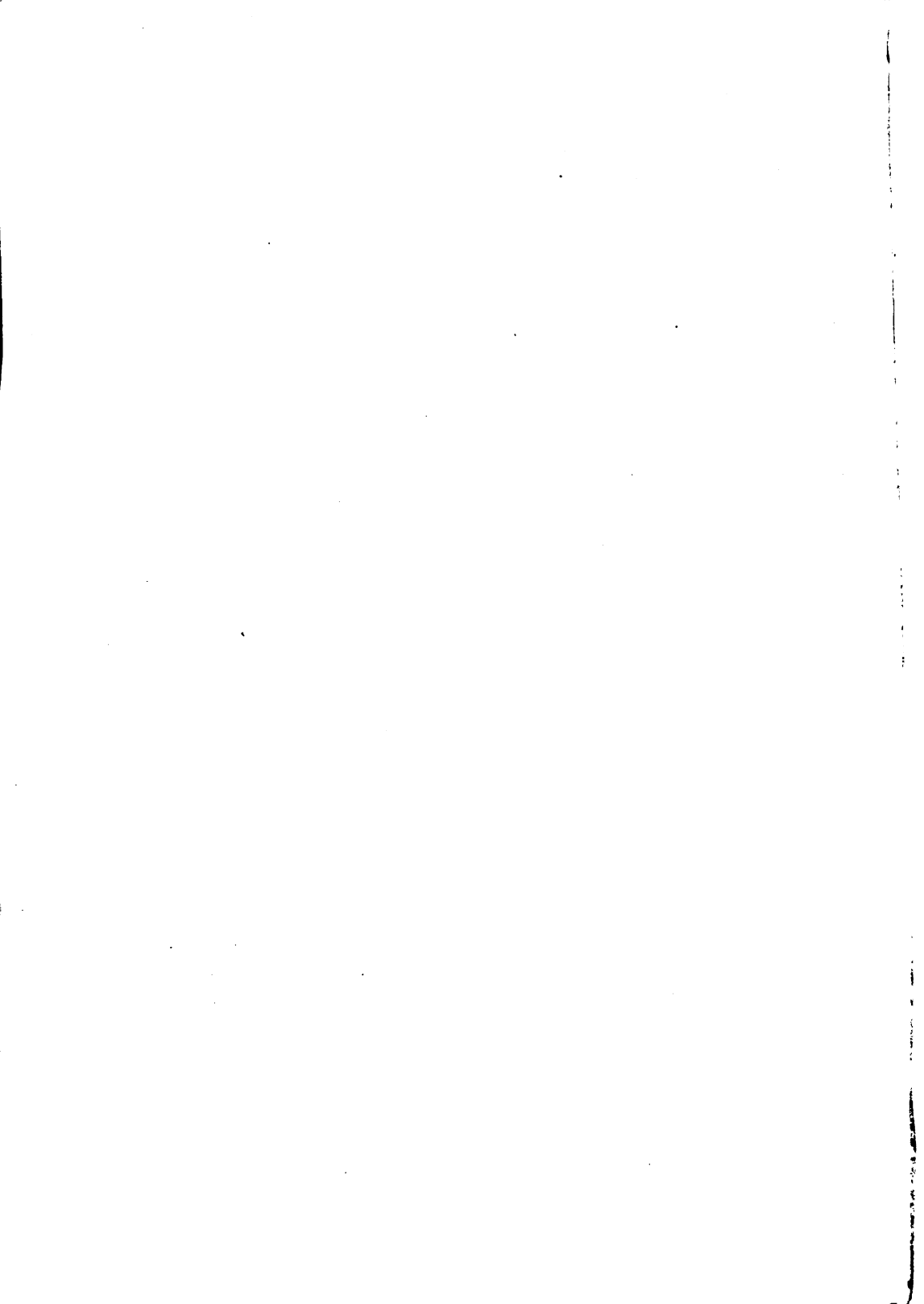

# MACHINERY'S REFERENCE SERIES

EACH NUMBER IS ONE UNIT IN A COMPLETE  
LIBRARY OF MACHINE DESIGN AND SHOP  
PRACTICE REVISED AND REPUB-  
LISHED FROM MACHINERY

NUMBER 68

## BOILER FURNACES

### CONTENTS

Combustion and Fuels - - - - -	3
Furnaces - - - - -	11
Mechanical Stokers - - - - -	23
Mechanical Draft - - - - -	30
Oil Fuel - - - - -	35
Chimneys - - - - -	40

Library of  
Machinery

T 77  
113  
164

113  
164

## CHAPTER I

### COMBUSTION AND FUELS

The process of combustion is affected by so many different physical conditions that in order to either design a furnace or superintend its operation, it is necessary to fully understand the chemical changes which take place. Among the physical conditions referred to above may be included strength of draft, depth of fuel bed, form of furnace, and the various methods of firing employed. So far as the generation of steam is concerned, combustion may be considered as the chemical union of oxygen with the various elements of the fuel for which it has an affinity. This union produces a definite amount of heat per pound of combustible, depending upon the element with which the oxygen combines.

The elements contained in the usual forms of fuel, which enter into the process of combustion, are oxygen, carbon, hydrogen and sulphur. There are various other constituents present which have no fuel value, such as the iron, silicon, etc., found in coal. These usually exist in small quantities, and are classed as impurities. They produce a certain waste in the form of ash, and in addition to this, their temperature must be raised to that of the fire before becoming separated from the other elements, and more or less of this heat is lost as they are discharged from the fire.

Oxygen is the universal element of combustion; it is an invisible gas and makes up about one-fifth the volume of the air in an uncombined state. It is also found in water, being combined with hydrogen in this case, and in coal and other fuels of vegetable origin, combined with carbon and hydrogen. It is usually present in coal in amounts varying from 1 to 25 per cent, according to the grade.

Carbon is a solid, and is found in a pure state in the form of graphite and charcoal. In its crystalized state it forms diamonds. It is also found in oils of various kinds, and in tar, combined with hydrogen. Vegetable products of all kinds contain carbon in combination with oxygen and hydrogen, and it is the principal heat-producing element in coal and other fuels, including liquids and gases.

Hydrogen is a combustible gas, and exists in nature only in combination with some other element. Water can be separated into oxygen and hydrogen by passing a current of electricity through it. Another method of producing the same result is to pass steam through a bed of white-hot coal. The oxygen in this case unites with the carbon, forming carbon monoxide, leaving the hydrogen in a free state. A mixture of carbon monoxide and hydrogen is called water gas and under certain conditions is used for lighting and heating.

Nitrogen is also an invisible gas, forming about four-fifths the

volume of the atmosphere. It does not unite chemically with the other constituents of the air or take any part in the process of combustion. For this reason it is a source of loss in the operation of a steam boiler, because in order to supply the necessary oxygen for combustion, four times the volume of nitrogen must be raised from the temperature of the atmosphere to the point of combustion, and then discharged at a high temperature with the waste gases into the chimney. This process adds nothing to the heat of the furnace and is constantly extracting heat from it. Nitrogen is found in coal in amounts varying from 0.5 to 2 per cent, by weight.

Sulphur enters into the composition of coal in amounts varying from 0.5 to 5 per cent. Although sulphur is combustible, the amount of heat given off is small, and the gases are so detrimental to the boiler plates that it is commonly considered an impurity. It appears in coal in two forms, combined with iron and with lime. In the first of these combinations its heat value is about one-fourth that of carbon, while in the second case it is worthless so far as its fuel value is concerned.

The atmosphere is a mixture, consisting principally of oxygen and nitrogen in very nearly the proportion of 1 to 4 by volume. It also contains small amounts of carbon dioxide and water vapor, which vary according to the location. A knowledge of the composition of the air is necessary in order to determine the required air space through the furnace grate, and also the chimney area. Computations for finding the air to be supplied by mechanical draft involve the composition of the atmosphere.

#### Stages of Combustion

The combustion of a fuel requires three stages, as follows: The absorption of heat to raise its temperature to the point of ignition; the distillation and burning of the volatile gases; and the combustion of the fixed carbon. When fresh fuel is added to the fire, it absorbs heat until its temperature reaches the point at which the combustible elements will unite with the oxygen of the air. This point varies with the kind of fuel, commonly running from 600 to 800 degrees F. in the case of lump coal and coke. Carbon monoxide requires a temperature of 1210 degrees and hydrogen 1100 degrees F. While the coal is being raised to the point of ignition, the so-called hydrocarbons, such as marsh gas, tar, pitch, naphtha, etc., are driven off in the form of a gas and combine with the oxygen of the air which is supplied through the bed of the hot fuel. When the hydrocarbons have been driven off, combustion of the solid portion of the fuel, that is, the carbon, takes place. This unites with the oxygen of the air to form carbon monoxide and carbon dioxide. Any substances which are not combustible fall through the grate into the pit below in the form of ash and clinker.

#### Air Required for Combustion

Theoretically, 11.52 pounds of air are required for the complete combustion of 1 pound of pure carbon. This is equivalent to ap-

proximately 12 pounds of air per pound of average coal. In practice, however, it is usually necessary to supply about twice this amount with a natural draft, and about 18 pounds with a forced draft. This is because ideal conditions for combustion cannot be attained in actual practice on account of the difficulty in supplying air to all parts of the fire uniformly. This results in some of the fuel receiving less oxygen than is necessary for complete combustion, while other parts have a surplus. On the other hand, if too much air is supplied and insufficient time is allowed after the gases have become incandescent before they come in contact with the cooler plates of the boiler, combustion will also be retarded.

#### Smokeless Combustion

In the design and operation of a furnace, provision must be made not only for the combustion of a given quantity of fuel, but it must be burned with the least amount of smoke possible. There are two reasons for this, one being the ordinances against the production of smoke in most of the larger cities, and the other being the greater economy secured when fuel is burned without smoke. Smoking chimneys in large towns and cities are not only unsightly, but a smoke laden atmosphere is unhealthful and also quickly injures fine architectural works and interior decorations. The waste of fuel is not due to any great extent to the smoke itself, but a smoking chimney is an indication of incomplete combustion, the waste itself being in the unburned and invisible gases passing away with the smoke.

The principles of complete combustion are simple, although not always easy to carry out, especially in the case of bituminous coal. As previously stated, combustion consists of introducing the coal into the furnace, raising its temperature to the burning point, and supplying sufficient air for the combustion of the gases which are given off during this process. It is also necessary that the air be thoroughly mixed with the combustible gases and that these be maintained at a sufficiently high temperature during the process. An important point in securing the best results is to prevent the direct flames from reaching the boiler plates, as this tends to cool the flames below the temperature required for complete combustion. In the case of anthracite coal the process is simple, because it contains very little volatile matter and combustion takes place within the bed of the fuel and a short distance above it. The air is thoroughly mixed with the fuel in passing upward through it from the ash pit. This also maintains the required temperature for producing complete combustion.

With bituminous coal the conditions are greatly changed. Here, in some cases, 50 per cent or more of the coal is composed of volatile matter which is driven off when heated. When fresh coal is fired on top of the fuel bed, the gases are driven off at a point where the air supply does not easily reach them, and the result is that a large proportion of them are carried into the chimney unburned. It is evident from this that special provision should be made for supplying air and

mixing it with the gases after they have been distilled from the coal and before they reach the main part of the heating surface of the boiler.

Taking up the process more in detail, it is evident that the introduction of fresh coal tends to shut off the air supply by closing the openings through the fuel bed at a time when it is needed the most. In addition to this, all coal contains more or less moisture, which, in the process of evaporation, cools the furnace, and thus further interferes with combustion. The next step is the production of water gas by the water in the steam uniting with the carbon to form carbon monoxide and hydrogen. This takes still more heat from the furnace, which, however, would be given back if sufficient air at a high temperature could be supplied above the fuel bed to burn the gases. It is not possible to do this by opening the furnace doors because the air thus admitted is too cool, hence a large proportion of these gases pass off unconsumed. After the moisture has been driven off, as above described, distillation of the hydrocarbons begins; part of these are burned, while the remainder, owing to lack of air and low temperature, are wasted. This entire process results in the formation of smoke, the waste of combustible gases, and the coating of the heating surfaces of the boiler with soot, thus reducing their efficiency.

One difficulty in hand firing with bituminous coal is the intermittent character of the process. A comparatively large amount of fuel is put on at one time, resulting in a sudden demand for an air supply at a high temperature above the fuel. This demand increases until the fire is in the condition of a coke fire, requiring that practically all of the air go through the fuel bed instead of above.

From what has been said, it is evident that the following conditions are necessary for complete, and therefore smokeless, combustion:

First, an extra supply of air, as warm as possible, should be introduced above the fuel bed after fresh coal has been fired.

Second, the air thus supplied must be thoroughly mixed with the volatile gases which are given off from the freshly fired fuel.

Third, the mixture of air and gas must be kept at a temperature well above the point of ignition.

Fourth, the combustion chamber must be of such form and size that the gases will have time to be completely burned before leaving it.

If complete combustion is to be secured, the gases must be kept at a high temperature for a definite length of time in the combustion chamber. Observations show, in the case of an average furnace, that the gases pass through the combustion chamber in about one second. Under ordinary conditions only partial combustion can take place in this length of time; but it has been shown that flame will pass through a perfect mixture of explosive gases at a rate of 1,000 feet per second. Hence, the furnace must either be made very large to increase the time of flow through it, or devices must be employed for producing a more thorough mixture of the gases, thus increasing the rate of



combustion. As the latter alternative is the more practical, most of the smokeless furnaces are designed on this principle.

#### Mixing Devices

Various devices have been advanced for producing a thorough mixture of the air supply with the gases of combustion. One of these is the steam jet. This, under ordinary conditions, is simply a makeshift, as the steam has a chilling effect upon the furnace and also carries quite an amount of heat up the chimney. Steam-jet mixing devices are, in general, costly to operate, the steam required more than offsetting the gain due to improved combustion. There are some cases, however, where the furnaces are of sufficient size and properly lined with fire-brick, in which good results have been obtained in the reduction of smoke without increased cost of operation. Superheated steam has been frequently used for this purpose, the idea being that the cooling effect in the furnace will be much less than with saturated steam. This, however, simply reduces the bad effects to some extent without eliminating them.

In the case of hand-fired boilers it is necessary to place the mixing device beyond the grate, otherwise the gases distilled from the coal at the rear of the grate would pass into the smoke flue without receiving their proper supply of air. Some of the best results in mixing air with the fuel have been obtained with oil. The oil being thrown into the furnace in the form of a spray, it is a comparatively simple matter to mix the required amount of air with it to produce complete combustion. With a properly constructed furnace and burners or nozzles of good design, it is possible to burn the oil with as little as 5 per cent excess air over the amount theoretically required for complete combustion. With a coal-fired furnace it is necessary to supply an excess of 40 to 50 per cent in order to prevent the formation of carbon monoxide, which is an indication of incomplete combustion.

Another device, by means of which improved results are obtained, is the mechanical stoker. This device partly overcomes two of the conditions previously mentioned, by making the introduction of fuel practically continuous instead of intermittent, and because more of the air required for burning the gases can be forced through the fuel bed and heated, instead of admitting it through the feed door, as is necessary in hand-fired furnaces. The gases in this case are distilled at one particular point in the furnace, and pass over the bed of incandescent fuel, which serves to keep them at a high temperature and allows the use of nearly the whole of the combustion chamber for mixing the gases with the air and burning them. This condition is impossible with a hand-fired furnace, where the gases are given off over practically the entire grate surface. In order to secure the best results with a stoker, it should be carefully operated in the manner for which it is designed, and the hand bar and poker used sparingly.

Having stated in some detail the conditions required for smokeless combustion, the following points may be given as guides in the design and operation of boiler furnaces in order to secure the best results:

A fire-brick lined combustion chamber of ample size with suitable baffles for mixing the gases with the air; the introduction of sufficient heated air in the combustion chamber to consume the gases before reaching the heating surfaces of the boiler; and a device for automatically controlling the air supply so as to gradually diminish it after each firing of fresh coal.

The most important and widely used fuel at the present time is coal. In some localities, wood, oil, gas, and peat are abundant, and are, therefore, used instead of coal. In manufacturing plants of certain kinds there are by-products which are used, such as straw, tan, sawdust, bagasse, etc. The chief constituent of most fuels is carbon, although hydrogen is found in varying amounts in most of them.

#### Coal

There are many kinds of coal, classed according to their composition, as anthracite, semi-anthracite, semi-bituminous, bituminous, and lignite. The common market classification of coals corresponds quite

TABLE I. CLASSIFICATION OF COAL

NAME OF COAL	Fixed Carbon, Per Cent	Volatile Mat- ter, Per Cent	T. U. per Pound of Combustible
Anthracite.....	97 to 92.5	3 to 7.5	14,600 to 14,800
Semi-anthracite.....	92.5 to 87.5	7.5 to 12.5	14,700 to 15,000
Semi-bituminous.....	87.5 to 75	12.5 to 25	15,500 to 16,000
Bituminous, Eastern.....	75 to 60	25 to 40	14,800 to 15,200
Bituminous, Western....	65 to 50	35 to 50	13,500 to 14,800
Lignite.....	under 50	over 50	11,000 to 13,500

closely with the composition given in Table I, which is taken from Kent's "Steam Boiler Economy." It should be noticed that the last column gives the heating value per pound of *combustible*, and not per pound of coal. The amount of ash varies so greatly with different coals of the same class that it is necessary to put them on some common basis when estimating the heating value.

Anthracite coal consists almost entirely of carbon, containing but a small proportion of volatile matter. It is hard and lustrous, breaks up easily under a high temperature, and burns with very little flame and smoke. It is liable to break into small pieces on account of its brittleness and, therefore, requires a grate with rather small openings. It represents the highest quality of fuel known, and is the nearest to a pure carbon combustible. Anthracite coal is found only in Pennsylvania, Colorado, and to a small extent in Virginia. Semi-anthracite coal closely resembles anthracite; it has a high percentage of carbon, and is low in volatile matter, but has more ash and contains slightly more oxygen. This coal is only found in a narrow strip along the edge of the anthracite region.

Semi-bituminous coal is one of the finest for power plants, but owing to the limited supply is not widely used for this purpose, except in the Eastern States. It is found in a narrow strip extending for

about 300 miles across Pennsylvania, Virginia, and Tennessee. It contains more volatile matter than the anthracite coals, but is much like them otherwise, and burns with but little smoke.

Bituminous coal is usually dense and black in color, although in some cases it has a brownish tinge. There are two distinct varieties known as *caking* and *non-caking* coals. The former, when fed into the furnace, swells up and fuses into a soft mass which must be broken up from time to time to allow the air and flame to pass through it. It is rich in hydrocarbons, burns with a long yellow flame, and produces a dense smoke which is difficult to prevent when fresh coal is first fired. Non-caking coal is rather hard and brittle, and does not fuse when heated. It burns with a yellow, smoky flame similar to the caking coal. This variety is extensively used for gas making. There is such a wide variation in the characteristics of bituminous coals that it is difficult to design a furnace for general use which will prove satisfactory under all conditions; but in general, a large combustion chamber is required with ample provision for supplying air and mixing it with the gases, as already noted.

Lignite varies in color from a brown to a deep black, depending upon the composition, the latter color denoting the better grades. Lignites are soft in texture, contain high percentages of hydrogen and oxygen, are easily ignited, and burn with a short flame. The poorer grades are of little value for steaming purposes on account of the large amount of moisture and ash. Lignites do not cake in the furnace, and are much like anthracite in action. To get the best results it is necessary to carry a thick fire, which in turn calls for a stronger draft.

#### Other Fuels

Fuels other than coal include wood, peat, oil, various by-products, etc., as already noted. Wood, when considered as a fuel, is divided into two classes known as hard and soft wood. Pound for pound there is very little difference in the heating values of hard and soft wood, but as the weight per cubic foot varies from 21 pounds per cubic foot for ordinary pine, to 58 pounds for English oak, it is evident that there is a great difference in their heating values when reckoned by the cord. Kiln-dried wood contains about 8,000 T. U. per pound, while in wood containing 25 per cent of moisture, the heat value drops to about 6,000 T. U. Taking the lower value, which corresponds more nearly to the condition of wood used for fuel, one cord of English oak is equal in heating value to about 1.6 tons of anthracite coal, and one cord of pine is equal to 0.6 of a ton. It is customary to roughly estimate one cord of average hard wood as being equal to one ton of coal.

Peat consists of decayed vegetable matter and earth, and is found in bogs and swamps. It is cut out and dried, and sometimes pulverized and compressed into blocks before burning. It gives an intense heat, burning with a short blue flame which changes to yellow when the grate spaces become filled with embers. A comparison of its heating value with other forms of fuel may be made by assuming one pound of air-dried peat to contain about 7,700 T. U.

Straw is only used in connection with portable boilers in the grain fields of the West. It contains 36 per cent of carbon, and has a heat value of about 7,000 T. U. per pound. Bark, after being used in the process of tanning, is often burned under the boilers. A pound of perfectly dry tan has a heating value of about 6,000 T. U., which makes it approximately equivalent to one-half its weight in coal. The form of furnace for burning tan is usually of the Dutch oven type, set in front of the boiler, and fed from holes in the top.

Bagasse is the fibrous portion of the sugar cane left after the juice has been extracted. A pound of bagasse, as it comes from the press, has a heating value of approximately 3,400 T. U., or about 4.25 pounds are required to equal 1 pound of coal. In burning this fuel with mechanical draft, an air supply of 200 cubic feet of air per pound is required. This gives better results than if burned under a natural draft, as smaller flues and chimney may be employed and a better mixture of the air and gases is secured in this way. An induced draft with the equivalent of 1 ounce to 1¼ ounce pressure seems to give the best results. Under a natural draft about 270 cubic feet of air are required per pound of fuel.

Petroleum is becoming an important fuel in many parts of the country and also to a considerable extent in marine practice. Petroleum is a hydrocarbon liquid containing from 82 to 87 per cent carbon, 11 to 15 per cent hydrogen, and 0.5 to 6 per cent oxygen. It weighs about 7.65 pounds per gallon, and has a heat value of 18,000 to 22,000 T. U. per pound. In general, oil fuel is not used to any great extent in power plants in the East, owing to its high cost as compared with coal; but in the southwestern part of the country, Texas and California, oils are largely employed for this purpose. Among the advantages of liquid fuel are the ease with which it may be regulated; more even distribution of heat; cleaner, and, therefore, more efficient heating surfaces; a thorough mixture of the air and gases, resulting in a more complete combustion; and a reduction in the cost of handling and firing as compared with coal.

Among the objections may be mentioned danger from explosion, loss by evaporation, and high cost in localities remote from the oil fields. The first two of these may be practically overcome by proper precautions, but the latter limits the territory in which it may be economically employed, although its use is constantly increasing. When used as a fuel, the oil is thrown into the furnace in a finely divided spray by means of special apparatus, in which superheated steam or compressed air is the motive force. In some cases the spray is produced by simply forcing the oil under pressure through a specially formed nozzle.

Gas in many ways is an ideal fuel, but for use in steam plants the natural gas is the only form which is used to any extent, since artificial gas of any form requires special apparatus in addition to the boiler.

## CHAPTER II

### FURNACES

Having taken up the general requirements for the combustion of fuel, some of the different forms of furnaces used for this purpose will now be described. The necessary parts of any furnace, whatever its special form, are a grate for supporting the fuel; a chamber in which combustion may take place; means for supplying fresh air and removing the incombustible gases; and an ash-pit for catching the refuse from the fuel bed.

#### Grate

The purpose of the grate is not only to support the fuel, but it must also be designed to admit a certain amount of air for burning the fixed carbon, and in some cases for burning a part, at least, of the hydrocarbons. The proportion of air space through the grate depends somewhat upon the kind of fuel to be burned. An extra large amount will do no harm, as the quantity of air supplied may be regulated by means of the draft doors. The openings must not be large enough, however, to allow the unburned fuel to fall through.

#### Firebox, Combustion Chamber and Ash-pit

The firebox proper is the space directly above the grate, while the combustion chamber is an extension of this in which combustion of the volatile gases takes place, and where the heat thus produced is absorbed by the water through the heating surfaces of the boiler. The horizontal dimensions of the firebox are fixed by the size of grate required for the given conditions, while the vertical height from the grate bars to the boiler shell, in the case of tubular boilers, depends upon the kind of fuel. With anthracite coal this is commonly made 24 inches for boilers from 42 to 54 inches in diameter, and 30 inches for those from 60 to 72 inches in diameter. In the case of bituminous coal more space is required on account of the greater amount of volatile matter to be cared for. Here the distance should be about 42 inches for a 48-inch boiler, up to 52 inches for a 72-inch boiler. With water-tube boilers, the height depends a good deal upon the general form and type of boiler.

The principal office of the firebox, aside from the distillation of the gases and the burning of the fixed carbon, is the mixing of the air supply with the unburned gases at a high temperature. As already stated, the combustion chamber is for burning this mixture as it passes from the firebox. There seems to be no fixed rule for determining its depth, it being assumed that no harm can come from extra space, so that in designing a furnace, the combustion chamber may be made as large as the special form of setting will allow. The common practice of filling in a part of the space back of the bridge wall, as is

often done in the case of tubular boilers, seems to have no especial value except as a matter of convenience in removing the ashes, due to the sloping floor.

The ash-pit beneath the grate serves both for catching the refuse from the fire above and also as an air reservoir from which the air supply passes upward through the grate. There should be sufficient depth between the bottom of the ash-pit and the grate to give plenty of air space, and also to provide for the accumulation of ash and clinker to a considerable extent without overheating the grate bars. From 24

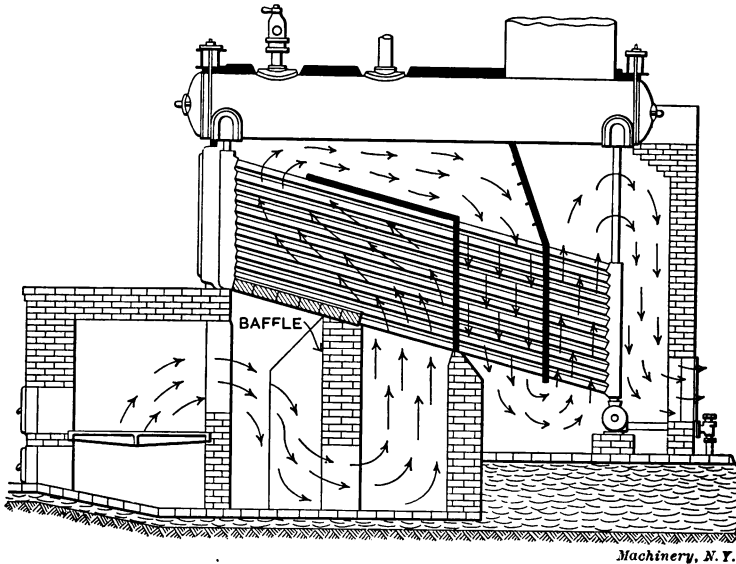

Fig. 1. Boiler with Dutch Oven Type of Furnace

to 30 inches is usually sufficient for this purpose. It is a good idea to slope the pit toward the front, in order to facilitate the removal of ashes.

#### Brickwork

The furnace construction should be of firebrick so arranged that the lining exposed directly to the fire can be renewed without disturbing the rest of the setting. Fire-brick is commonly designated as *acid*, *basic*, and *neutral*. In the first of these, silica predominates, and in the second alumina; a combination where the proportions of the two are approximately equal forms the third class. In addition to the standard forms of fire-brick, there are many special shapes adapted to the construction of arches, linings, etc., which are often used with different types of boilers. Fire-brick should be laid with very close joints, it being customary to simply dip them in a thin mixture of fire-clay and water when laying up a wall or lining. In case of an arch, the bricks are commonly placed in a form and there grouted with a thin solution of clay and water. Another use for fire-brick is in the

construction of devices for smokeless combustion. These require a great variety of shapes which can only be formed by hand, and require great skill in their construction.

#### Dutch Oven Furnaces

One of the most popular of the special furnaces for burning bituminous coal is some form of the Dutch oven, one of which is shown in Fig. 1. The furnace proper is extended in front of the boiler, and at the rear of this is a mixing wall or baffle which gives a hot wall for the burning gases to strike against as they rise from the bed of fuel. This gives the hydrocarbons ample opportunity, after being distilled from the fresh fuel on the grate, to become thoroughly mixed with the air before passing into the combustion chamber at the rear of the wall. The passage of the hot gases over the heating surfaces of the boiler is indicated by the arrows.

A longitudinal section through the Burke furnace is shown in Fig. 2. This is similar in form to the one just described, except that there

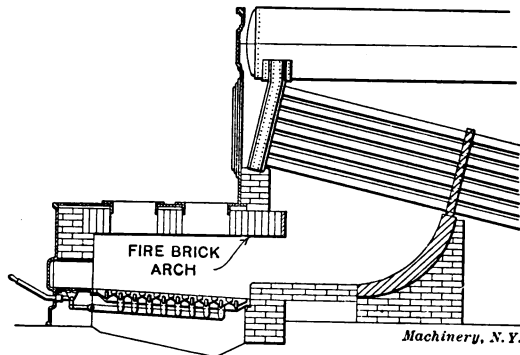

Fig. 2. Longitudinal Section of Burke Furnace

is no mixing wall, the gases being deflected upward among the tubes as indicated. The mixing process in this case is performed by the fire-brick arch at the rear of the grate. Owing to the temperature of the furnace and the draft of the chimney, a natural circulation is set up, and the proper amount of air is combined with the hydrocarbon gases from the coal as they come in contact with the arch. This being heated to a high temperature, furnishes the necessary heat for igniting the gases, which burn perfectly and pass under the boiler free from smoke. Coal is fed into the furnace at each side through openings in the top instead of by way of the door in front, which by the peculiar construction prevents the inrush of cold air when fresh fuel is fired.

A view of the McKenzie Dutch oven furnace is shown in Fig. 3. This furnace is designed for use with marine, horizontal tubular, and water-tube boilers not exceeding 300 horsepower. Coal is fed into the side magazine hoppers above, either by gravity or shovel, and its admission to the furnace is regulated by a pair of levers not shown in the illustration. Air is admitted at the sides by means of a hand-

wheel at the boiler front, and is distributed over the top of the fire. The air supply to the ash-pit beneath the grate is through a grating in the floor. Special arrangements are provided for shaking the grates, and for dumping, without opening the furnace.

#### Other Special Furnaces

Fig. 4 shows a double-arch furnace with mixing arch, for a return tubular boiler. In this case the grate is divided into two parts by a wall as shown in the plan. These two fireboxes connect with a common combustion chamber by way of a brick arch at the rear of the bridge wall. The advantage is that the two furnaces may be fired alternately, thus always having one bright fire and a continuous stream of hot gases passing under the incandescent arch for burning the freshly distilled gases from the new fire.

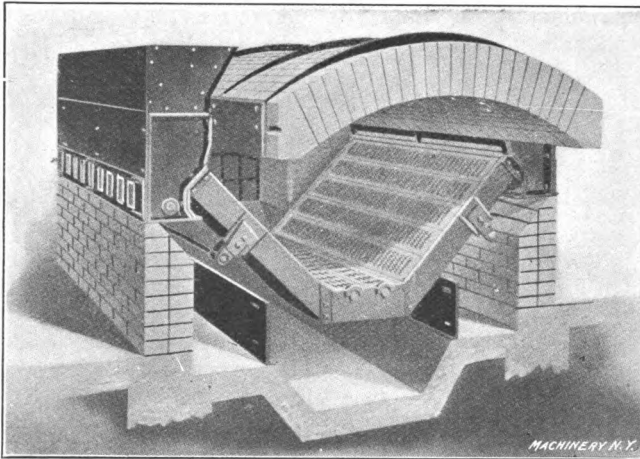

Fig. 3. McKenzie Dutch Oven Furnace

The Wooley smokeless furnace is shown in Figs. 5 and 6. This furnace also has a dividing wall through the center of the grate which permits of alternate firing the same as the furnace previously described. When mechanical stokers are employed, this dividing wall is not used. By extending the rear wall of the firebox upward on each side to the boiler tubes, and leaving a vertical opening in the center, the products of combustion from the green fuel and the incandescent fuel are brought together and mixed with a partial supply of oxygen at the restricted point in front of the V-shaped baffle wall. An air supply for the top of the fire is provided at the sides by inclining the grate bars sufficiently to bring their outer edges above the bed of the fire. The air thus admitted is mixed with the hydrocarbon gases as they are distilled from the coal, and these gases pass to the secondary combustion chamber as already described. This chamber being in an incandescent state at all times, completes the combustion of any unburned gases before reaching the heating surfaces of the boiler.



The Sullivan smokeless furnace shown in Fig. 7 in connection with a water-tube boiler may be applied to any usual form of boiler by making simple changes in the regular form of furnace. It consists of a special bridge wall provided with a transverse air passage *a*, which is carried back and forth across the furnace several times to heat the air thoroughly, and then terminates in a series of outlet ports *b*, just above the fuel bed. This supplies a sufficient quantity of hot air above the fire to produce a complete combustion of the distilled gases. Air for the bridge wall openings is drawn through a pipe extending from the rear wall of the setting as shown.

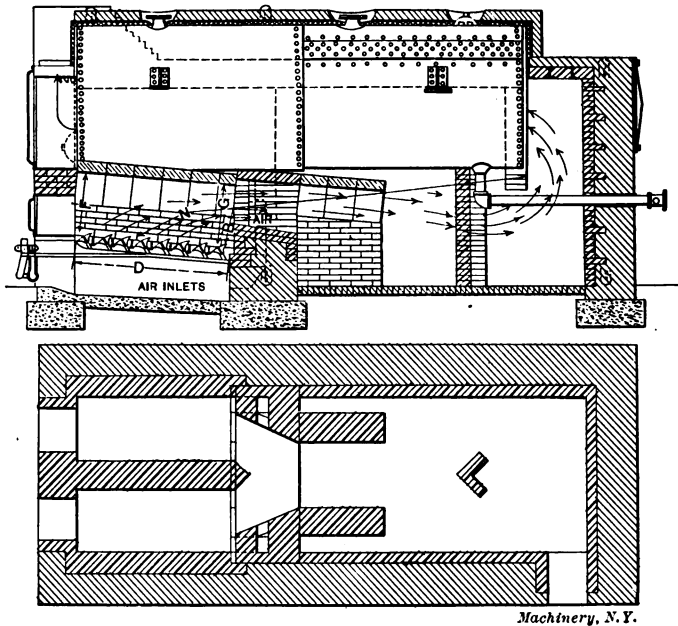

Fig. 4. Double-arch Furnace with Mixing Arch

In addition to this special air supply, there is a steam retort *c*, located above the feed doors and arranged to discharge superheated steam in small jets when coal is first added. This provides steam for only a few seconds while stoking, when a temporary excess of hydrocarbons is formed. The retort is supplied with steam through a  $\frac{1}{2}$ -inch pipe, which is provided with a valve operated by an automatic time-regulator so arranged that steam will be turned on full as soon as the door is opened to feed the furnace. When through firing, and the door is shut, the valve closes slowly, being fully shut by the time the excess of hydrocarbons has been given off.

#### Grates

The form of grate bar depends upon the kind of fuel to be burned. The ordinary form of straight bar is shown in Fig. 8. This is usually

made up in sections of one, two or four bars each, as it is more easily handled in this form and less likely to warp. Other patterns of plain grates are shown in Fig. 9. Grate bars of this general form should not be over 3 feet in length; when longer grates are required,

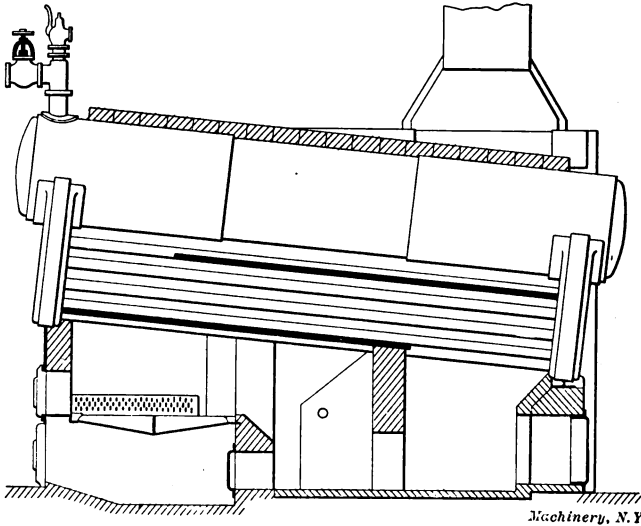

Fig. 5. Vertical Section of the Wooley Furnace

two bars of the proper length to give the desired dimension should be placed end to end. A grate over 6 feet long cannot be properly fired by hand on account of the difficulty in cleaning the rear portion. With bituminous coal this must be done frequently, and a 6 foot furnace

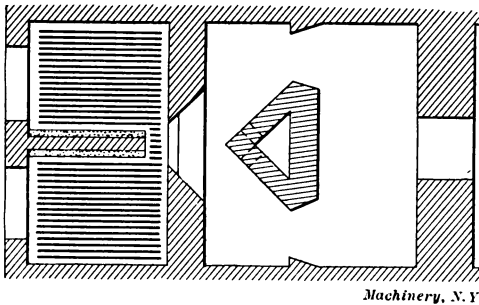

Fig. 6. Horizontal Section of the Wooley Furnace

is, therefore, the limiting size for easy operation. The free air space through the grate is commonly made from 30 to 50 per cent of the entire area. For coking coal, and for the larger sizes of anthracite, the spaces between the bars are often made 1 inch in width, while for coal smaller than No. 1 buckwheat, this dimension should not be more than  $1/16$  to  $3/16$  inch.

The method of computing the grate area for different conditions is given in MACHINERY'S Reference Series No. 67, "Steam Boilers," and need not be repeated here. Experience shows that too large a grate is as undesirable as one which is too small, as in this case an excess

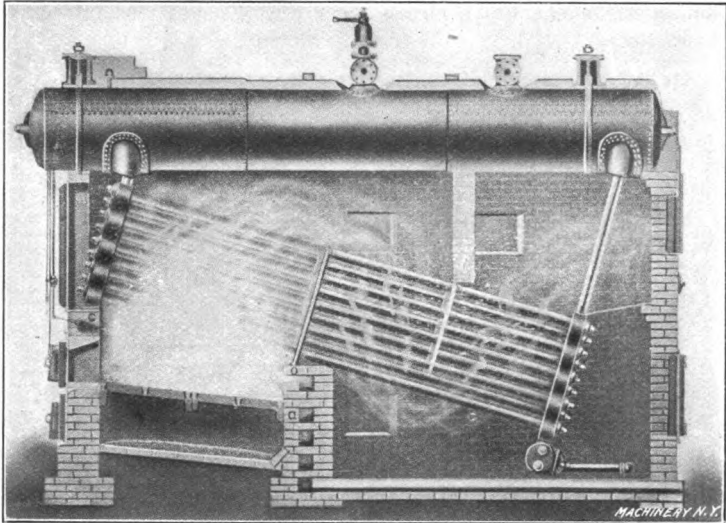

Fig. 7. Boiler with Sullivan Smokeless Furnace

of air is likely to enter the furnace, cooling the gases below a point capable of the highest efficiency, both as regards the combustion and the transmission of heat. One of the principal objections to the hand-

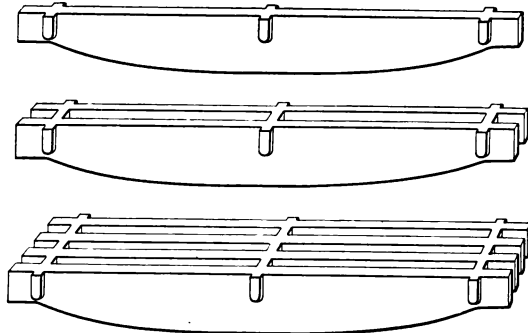

Fig. 8. Ordinary Form of Straight Grate Bar

fired grate is the frequent opening of the feed door, which is necessary in cleaning and breaking up the fire. This is especially true for coals which are high in ash or tend to form clinker, and in cases of this kind some form of shaking or rocking grate is often used.

## Types of Grates

The Aetna shaking grate is shown in Fig. 10, and is made up of separate bars supported at the ends on rocker bearings, to which is attached the lever for operating the grate. The rocker is so formed that alternate bars are moved backward and forward, thus producing a sliding movement which cleans the grate of ashes without the use of hand tools.

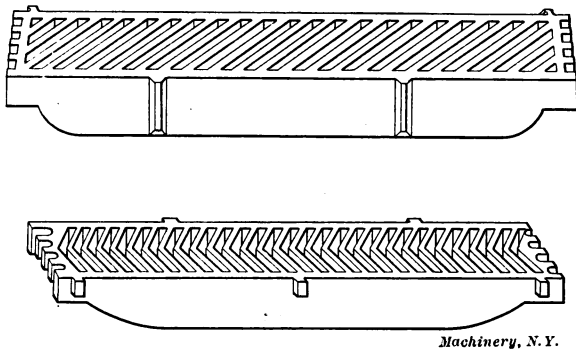

Fig. 9. Types of Grate Bars

Machinery, N. Y.

In the Martin rocking grate, Fig. 11, the bars have a rocking motion rather than a sliding movement, as in the preceding one. They are of heavy construction and are designed to burn the cheaper grades of fuel, such as slack and screenings, as well as other kinds. In the assembled grate the bars extend lengthwise of the furnace, but the motion is sidewise. Each grate bar is supported at both ends by a

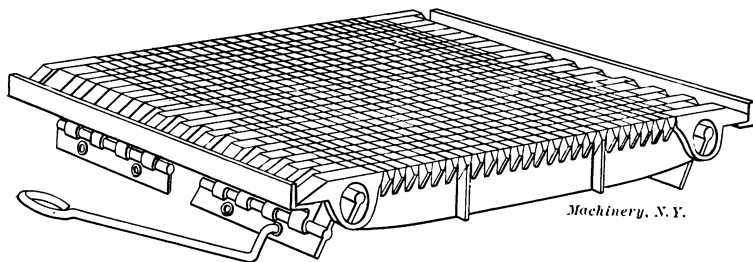

Fig. 10. The Aetna Shaking Grate

Machinery, N. Y.

bearing bar, on which it rests through the medium of an inverted cone bearing, which causes it to operate easily by means of the lever shown at the front. It is a rocking rather than a dumping grate, has a smooth surface, and can be placed in any furnace of regular form without changes in the brickwork.

The New England roller grate, Fig. 12, is a shaking grate, taking its name from the roller bearings supporting the bars. One special feature of this grate is the fact that the openings do not change when it is shaken, hence it is economical in the use of fuel, as it does not

allow the finer parts to fall through. The mechanism upon which the movement depends consists of only one piece, its office being simply to reciprocate the bars, the whole weight of the bars and fire being supported by the rolls upon which they move.

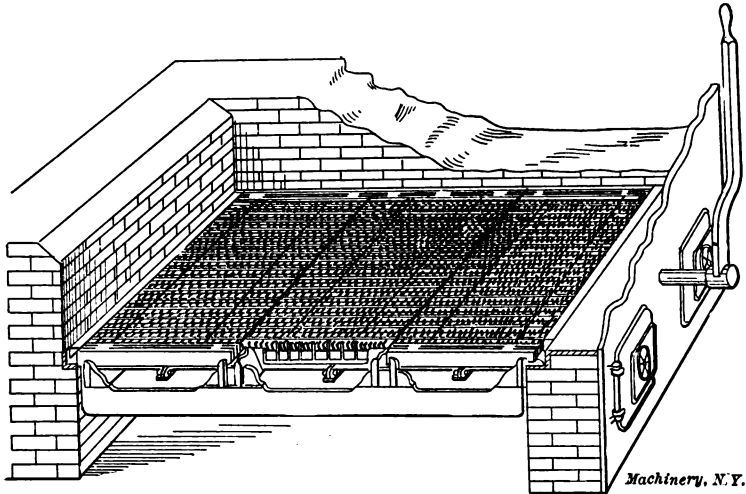

Fig. 11. The Martin Rocking Grate

The Neemes grate, Fig. 13, is a combined shaking and dumping grate with a shearing attachment for removing the clinker. In Fig. 13, the shearing bars are shown between the shaking bars in the front half of the grate, and assist in cutting and breaking up the clinkers. In action, the clinkers and ash are first rolled upward to the shear bars,

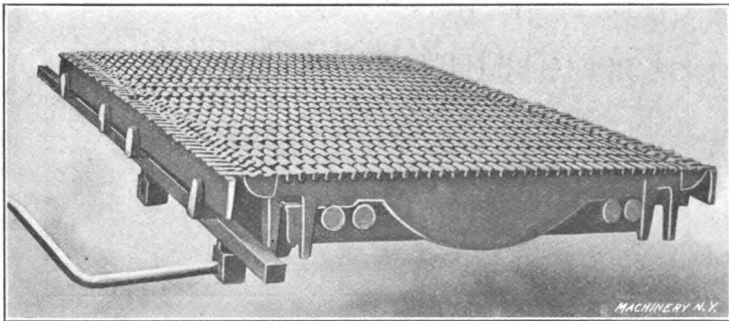

Fig. 12. The New England Roller Grate

then cut into small pieces and thrown into the ash-pit, thus cleaning the bottom of the fire without allowing the unburned fuel to pass through. Special provision is made for the expansion of all parts without warping or buckling, and the grates can be installed under any standard type of boiler without changes in the brickwork. The bars are spaced to burn any kind of fuel, and as the fire can be attended

to without opening the doors, it has the advantage of excluding the cold air from the furnace the same as other grates of the same type.

Two forms of dumping grates are shown in Figs. 14 and 15. In this case the sections are made larger, and when the fire is to be freed from clinker, a section, or series of sections, is rocked to an inclined

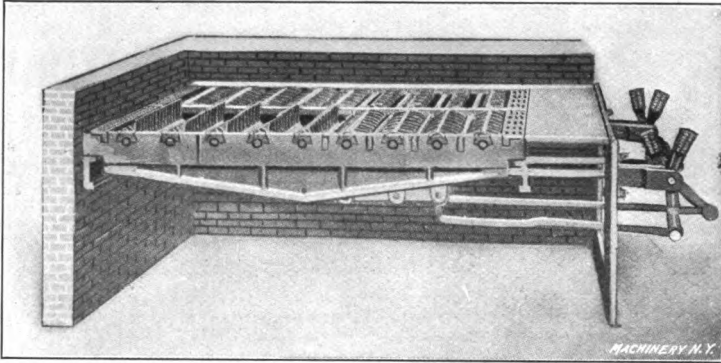

Fig. 13. The Neemes Grate

position, thus breaking up the clinker and allowing it to fall into the ash-pit. The Salamander grate, Fig. 15, is divided into two parts, as shown, and so arranged by means of levers that either the front or the rear of the fire can be dumped separately.

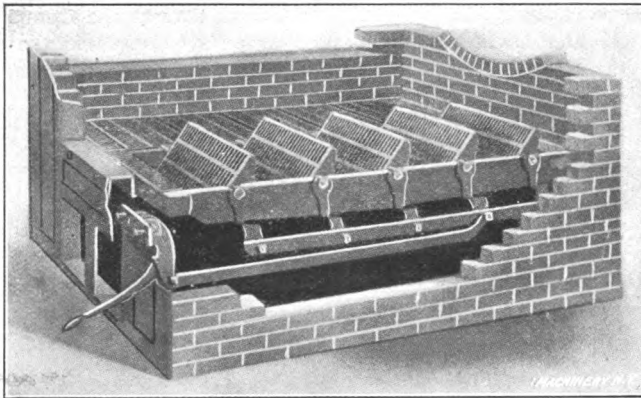

Fig. 14 A Dumping Grate

The Gordon hollow blast grate, Fig. 16, is designed especially for burning sawdust, bark, chips, and various forms of wood refuse, which do not burn readily on the ordinary form of grate. The apparatus consists of a series of hollow grate bars connected with a blast fan as shown. Air is admitted to the fire through specially formed openings in the upper surfaces of the bars, depending upon the character of the fuel to be burned.

**Firing Steam Boilers**

There are two general methods of adding fresh fuel in hand-fired boilers, depending upon the kind of coal used and the type of boiler. One method often employed where two furnaces lead to a common combustion chamber is to fire one side at a time, as in this way the fire on one-half of the grate will be bright at all times and the hydrocarbons given off from the freshly fired fuel will be burned by the hot gases present in the furnace and combustion chamber. In this way the fire is not checked to such an extent as when coal is added to the whole grate. This is called alternate firing. In so-called "spreading," the coal is distributed in small quantities at frequent intervals over the entire surface of the fire. The entrance of cold air should be guarded against by keeping the furnace doors closed, except when actually introducing the fuel. With anthracite coal very good results

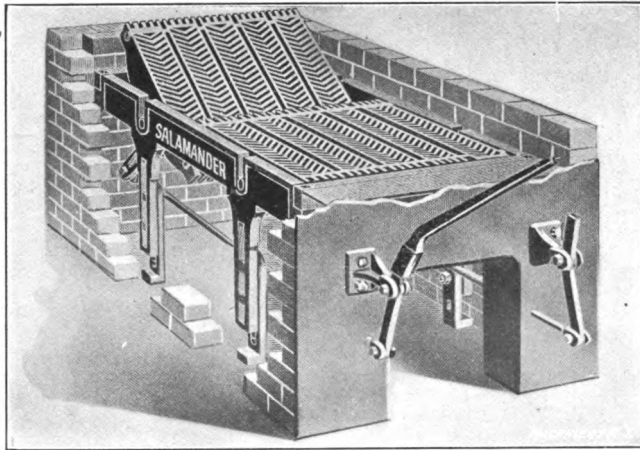

Fig. 15. The Salamander Grate

may be obtained in this manner, and a comparatively even fire maintained at all times. After firing fresh coal, the draft plates should be opened for a short time until the gas has burned off.

Bituminous coal requires a different method of firing, owing to the greater amount of smoke given off when fresh fuel is added. The coal is first placed on the front of the grate, just back of the firing door, where it is allowed to remain until the greater part of the hydrocarbons is given off, which requires from twenty to thirty minutes under ordinary conditions. During this process, air should be admitted through the draft plates to assist in the combustion of these gases. After this so-called coking process the coal is pushed back and spread over the grate and fresh fuel added as before, and the operation repeated.

The best depth of fire to carry will depend upon the kind of coal used, and the power of the chimney draft. Under ordinary conditions,

with coarse coal, the depth may be about 12 inches, which should be reduced to 4 or 5 inches with fine coal or poor draft. Forced draft calls for a heavier fire than a natural draft, and bituminous coal allows of a thicker fire for a given draft than anthracite. In each particular case the fireman should learn by experiment the proper depth of fire to carry for obtaining the best results, and then adhere to it. The fires should not be cleaned oftener than is necessary to keep them free

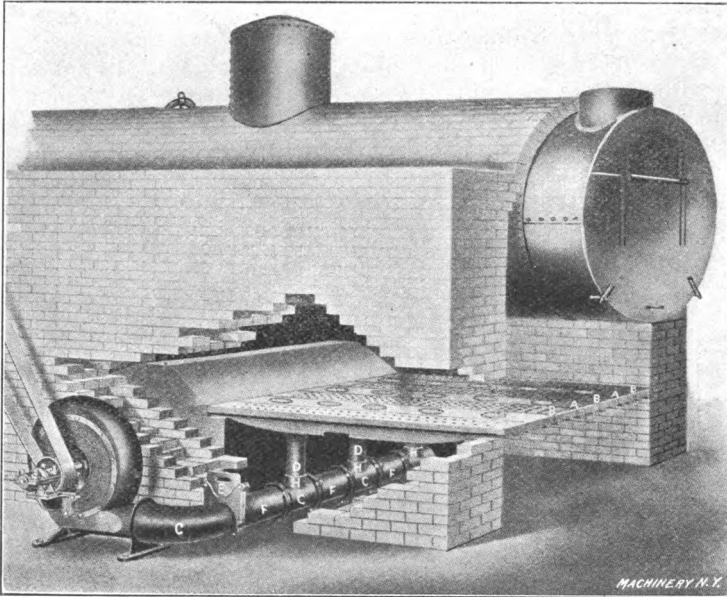

Fig. 16. The Gordon Hollow Blast Grate

from ashes and clinkers; this, however, will depend upon the grade of fuel used, and must be determined by observation. Before cleaning the fires, they should be allowed to burn down somewhat, but not so much that they will not come up quickly afterward. Some firemen prefer to first clean the front of the grate and then the rear, while others clean a side at a time. This is a matter of choice, and either way should give satisfactory results when properly carried out.



## CHAPTER III

### MECHANICAL STOKERS

Mechanical stokers are now used extensively in plants of large size. The advantages derived from their use are economy in operation, one man being able to care for several furnaces; more even firing; better combustion; the introduction of fuel with closed furnace doors; and practically smokeless combustion. The principal objection is their first cost, but in plants of large size this is easily offset by greater efficiency and a reduction in the cost of operation.

#### Types of Stokers

Stokers are divided into two general classes called "over-feed" and "under-feed." In the former the coal is fed through an opening which

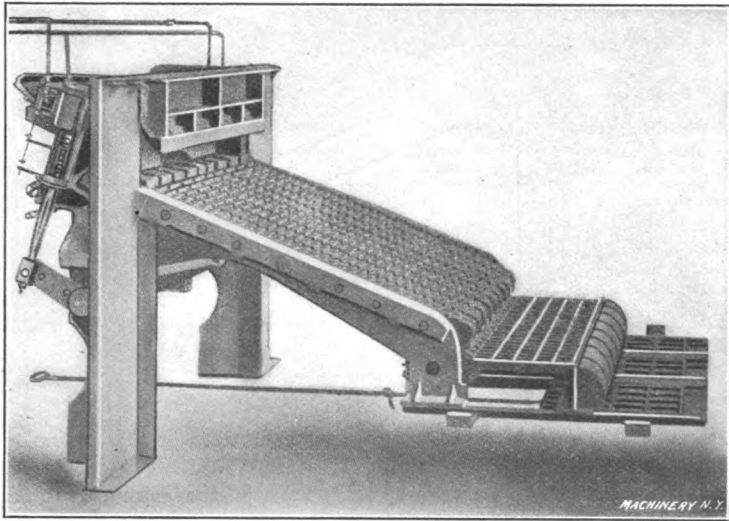

Fig. 17. The Wilkinson Over-feed Stoker

takes the place of the furnace door in the ordinary hand-fired furnace, and is placed on the surface of the fuel bed. In the under-feed type the fuel is forced into the bottom of a special retort, or series of retorts.

A general view of the Wilkinson over-feed stoker is shown in Fig. 17, and a sectional view in Fig. 18. This stoker has an inclined grate with a coal hopper at the front, from which the fuel passes under the coking arch before being fed onto the grate. In operation, the coal passes under the drop plate, the height of which is regulated to suit the size of the coal, then down the grate, and after beginning to ignite and coke at the point A, it soon reaches a zone of higher combustion

at *N* and becomes white hot at *C*. The unburned portion of the fuel falls to the table *D* where combustion is completed, and the refuse falls to the ash-slide, from which it can be dumped to the pit below as it accumulates. The grate bars are hollow, and each is supplied with a small steam jet at the upper end as shown in Fig. 18, the air supply being drawn in with the steam through openings surrounding the jets. The fuel is made to flow forward and downward by a constant sawing action of the grate bars, produced by hydraulic motors, one of which is seen at the left in Fig. 17. Automatic regulation of the steam jet gives a varying amount of draft according to the requirements, the steam jets blowing strongly when the boiler is forced and lightly when the load is small.

The Wetzel stoker, shown in Fig. 19, is of a type somewhat similar to the one just described. It consists of a cast-iron front, on the out-

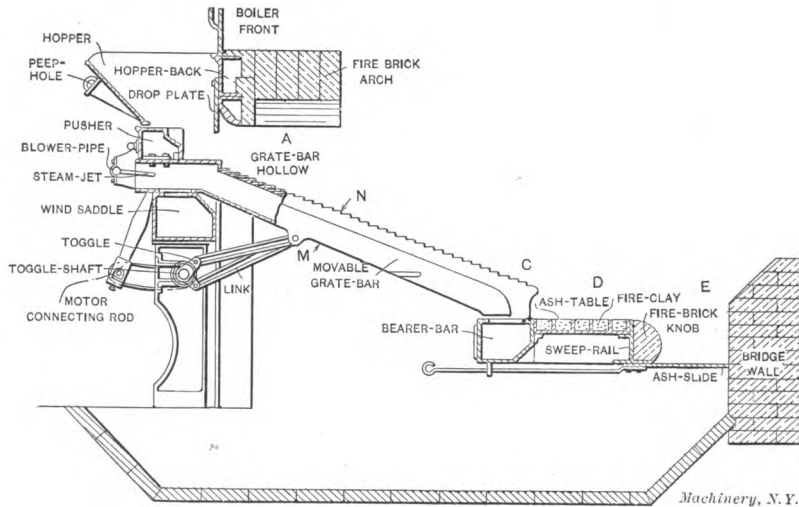

Fig. 18. Sectional View of the Wilkinson Stoker

side of which is a coal hopper and driving device; on the inside is a frame carrying the coking grate, main grate, and dumping grate. The largest proportion of air space is provided in the coking grate and the least in the dumping grate. The entire grate surface is inclined, and the coal which is fed into the hopper, either mechanically or by hand, is pushed automatically to the coking plate where the hydrocarbons are distilled and mixed with the hot air admitted through the perforated tile of the combustion chamber. The coal, after coking, travels downward toward the dumping grate at a speed depending upon the amount of ash and the desired rate of combustion. The stoker is operated by a small steam engine direct-connected to the driving mechanism by means of a worm-gear.

The McKenzie traveling grate stoker is shown in Fig. 20, and has a horizontal grate instead of one that is inclined as in the preceding cases. The movement of the grate is continuous, the speed depending

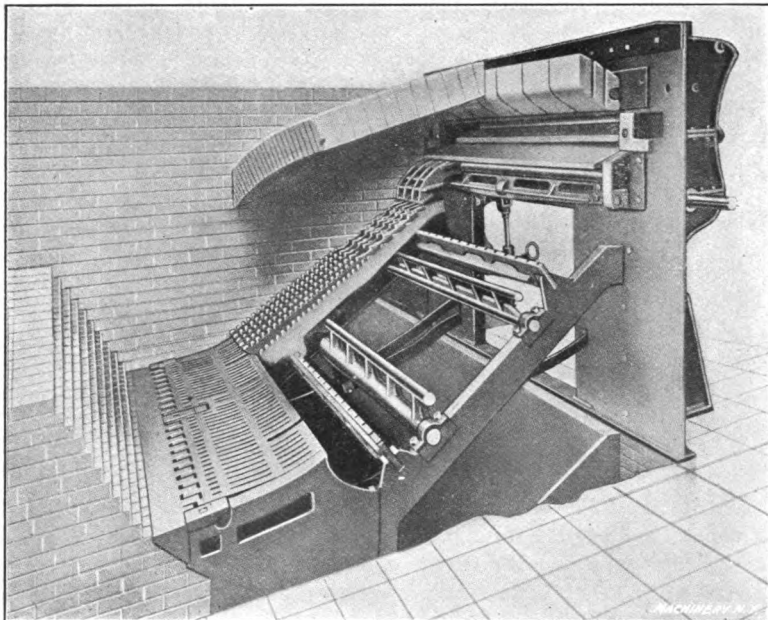

Fig. 19. The Wetzel Stoker

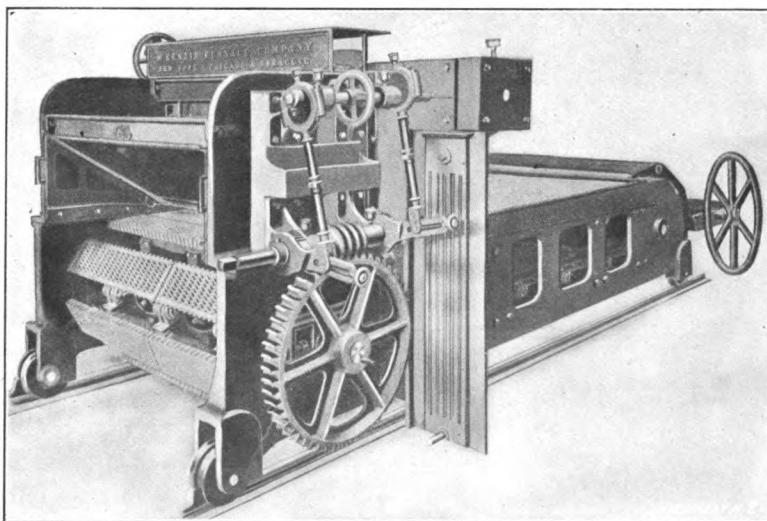

Fig. 20. The McKenzie Traveling Grate Stoker

upon the desired rate of combustion and the character of the fuel. The grate is of the truss form, and is divided into a number of parts the full width of the machine. The different sections are removable

and can easily be replaced in case they become damaged. The machine is equipped with a clinker apron and horizontal dumping grate which forms an ash receiver at the rear end. The motive power is derived from an electric motor geared to the driving parts by means of a worm-wheel. Coal is fed onto the front end of the grate by means of

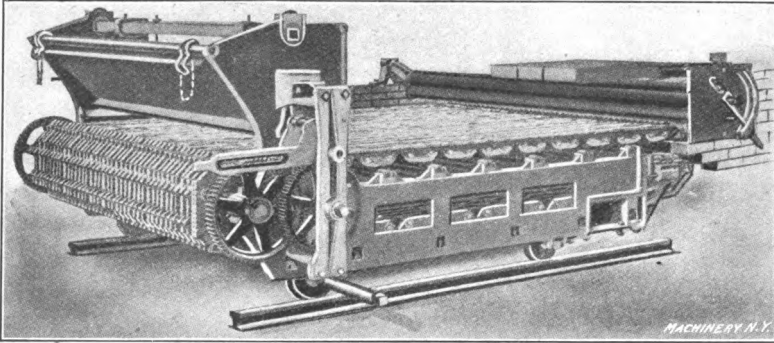

Fig. 21. The Green Traveling Link Stoker

a hopper, and carried through the different parts of the furnace, being entirely consumed by the time it reaches the farther end.

A general view of the Green traveling link stoker is given in Fig. 21, and a longitudinal section in Fig. 22. This stoker is similar in principle to the one just described, except that a chain or link grate

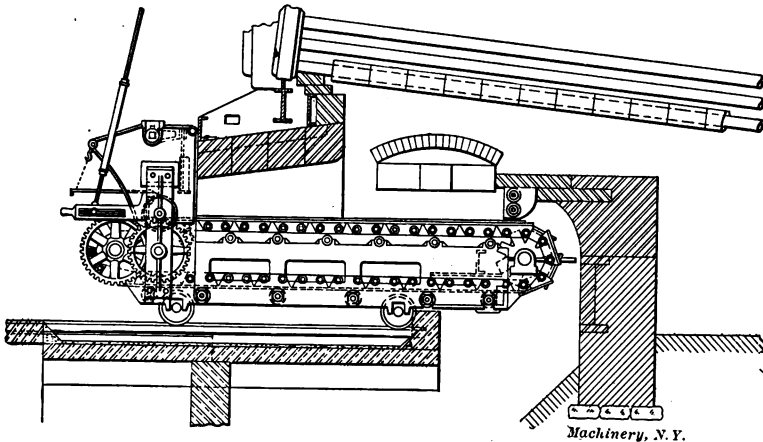

Fig. 22. Longitudinal Section of the Green Stoker

is substituted for the bars. The frame is of cast iron, with cross rolls supporting a chain driven by sprockets on shafts at the front and rear. Owing to the special design, the sprockets shear any clinker which may get under the hubs of the driving links, and automatically clean the engaging surfaces. The stoker is furnished with a flat igniting arch over the front half of the grate as shown in Fig. 22, which causes

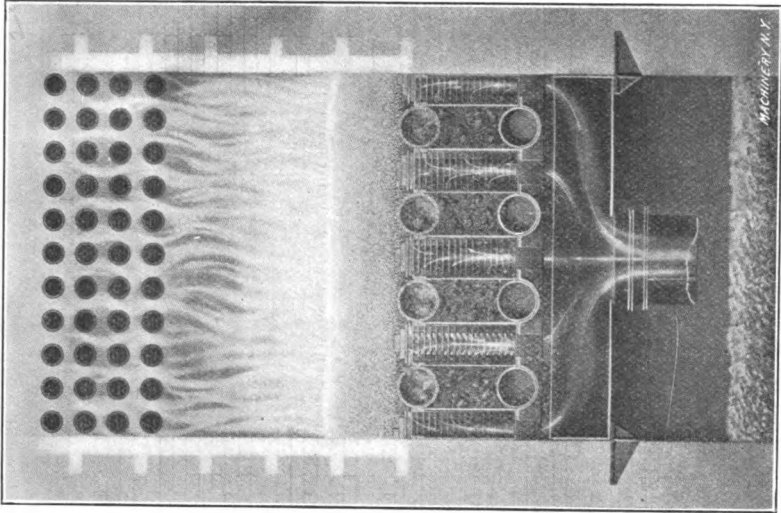

Fig. 24. Cross-section of Taylor Stoker

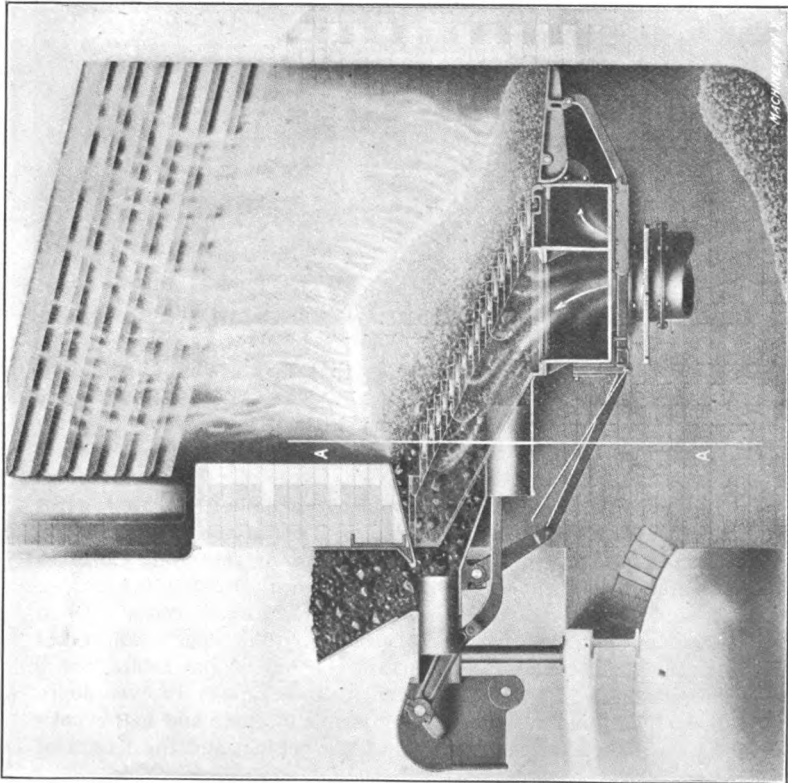

Fig. 23. The Taylor Gravity Stoker

uniform ignition and combustion the full width of the furnace. The automatic waterback at the rear of the grate is for controlling the discharge of ash and the admission of air at this point. It consists of two extra heavy pipes, the upper one being stationary while the lower one can swing upward and to the rear while in contact with the upper one, this movement being controlled from the outside. The pipe can be locked in any desired position or it can be allowed to swing freely, in which case the ash pressure will raise it as may be required. Both pipes are cooled by a circulation of water and are connected to the supply and discharge mains by flexible hose.

#### Under-feed Stokers

The advantage of the under-feed stoker is that it conducts all of the volatile gases directly through the incandescent fuel bed, thus

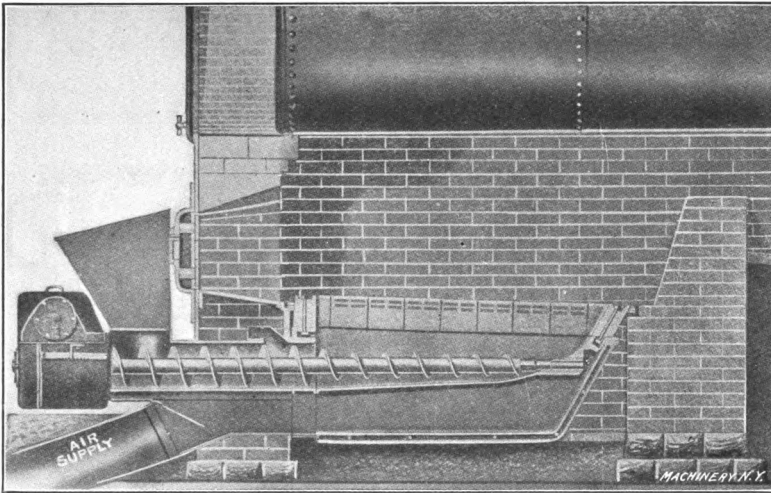

Fig. 25. The American Under-feed Stoker

bringing them to a high temperature so that they are readily ignited when mixed with the proper amount of air. They are, for this reason, able to handle high overloads with very little, if any, smoke production. This type of stoker requires a forced draft for driving the air through the fuel bed.

The Taylor gravity stoker is an under-feed stoker of the general form; it is shown in Fig. 23. It consists of a series of inclined retorts, or fuel magazines, supported upon a blast box or reservoir. A cross section on line A-A is shown in Fig. 24. The coal is fed into a hopper in front, and then descends to cylindrical hydraulic rams, two in each retort, as indicated in the illustration. The upper ram takes coal from the hopper and forces it into the top of the retort, while the lower ram feeds in a sufficient quantity to maintain an even depth of fuel bed. The rams are operated by means of links and bell cranks attached to a main shaft driven by a steam engine, and the length of

stroke is adjusted to meet the requirements of the particular kind of fuel burned. Air is supplied at a low pressure by means of a blower, thus insuring proper regulation and a thorough mixture with the gases, which would be impossible with a natural draft.

The American under-feed stoker is shown in Fig. 25, and consists of a screw conveyor driven by a direct-connected steam engine. The coal is fed into the hopper in front and is then forced into the center of the furnace by means of the screw. The coal enters the trough or

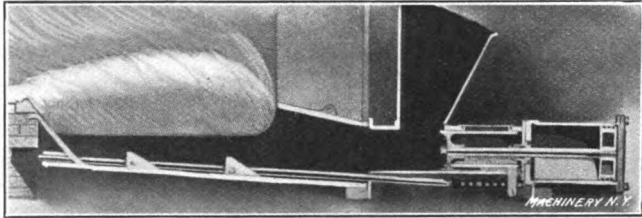

Fig. 26. The Jones Under-feed Stoker

retort and is crowded upward by the pressure of that behind. The volatile gases are mixed with the air, which is supplied under pressure, and which enters the fire through a series of openings around the edge of the retort. The only escape for the mixture of air and gases is through the bed of incandescent fuel, which results in complete combustion.

The Jones under-feed stoker is shown in Fig. 26, and in general form is similar to the preceding type shown, although in this case the coal is forced into the furnace by means of a steam driven ram instead of a screw. This stoker requires a forced draft, and the air is delivered through a number of openings around the upper edge of the retort.

## CHAPTER IV

### MECHANICAL DRAFT

Mechanical draft is often employed as a substitute for a tall chimney, and also in case a boiler plant is increased beyond the capacity of the original chimney. Again, certain kinds of low grade fuels require a stronger draft than is provided by a chimney of ordinary height. Forced draft is also necessary for stokers of the under-feed type as already noted in the previous chapter.

In a general way, the advantages of mechanical draft are as follows: The capacity of a boiler may be increased, as well as the efficiency, which is due to the more intimate mixture of the air with the fuel, when under pressure, thus making it possible to carry deeper fires; ease of regulation, and the ability to provide just the right amount of air for complete combustion; the use of poorer grades of fuel than can be burned with a natural draft; and the possibility of forcing the boilers, if necessary, without regard to outside weather conditions. Forced draft also permits the use of feed-water heaters in the smoke flues, which cool the chimney gases to a comparatively low temperature, and which would interfere with the natural draft of a chimney. The cost of the equipment for mechanical draft is also considerably less than for a chimney. Mr. W. B. Snow gives the following figures of comparison: For forced draft, with a single fan and short stack, the cost is about 20 per cent of that for a brick chimney; for the same conditions with induced draft, 30 per cent; and for induced draft, with duplicate fans, 40 per cent. In the case of power plant work, the rate of combustion commonly runs from 20 to 40 pounds of coal per square foot of grate area per hour, with an ash-pit pressure of  $\frac{1}{2}$  to 2 inches of water column, depending upon the kind of fuel.

Mechanical draft apparatus is divided into two general classes, according to their use for *forced* or *induced* draft, and to these may be added the steam jet, which, perhaps, might well be included in the latter class.

#### Forced Draft

The forced draft method consists in forcing air under pressure into the ash-pit of a furnace, or into the retort of an under-feed stoker, and thus causing it to pass upward through the bed of fuel. It has the advantage of low first cost, and is also easily applied to old furnaces where it is desired to increase the power of the plant without installing additional boilers. Fans used for forced draft are more durable than those for the induced system, as they handle only cool air. Forced draft cannot, however, be used to advantage with an economizer placed between the boilers and the chimney.

One of the disadvantages of this system is that the pressure maintained in the ash-pit and furnace is liable to blow ashes and smoke



into the fire-room if forced too hard. With moderate pressures this may be avoided if care is taken to shut off the blast-pipe before opening either ash-pit or furnace doors. In admitting air to the ash-pit for forced draft, the ducts should be arranged to spread it as much as possible, and on this account it is usually introduced either through openings in the bridge wall or in the bottom of the ash-pit just inside

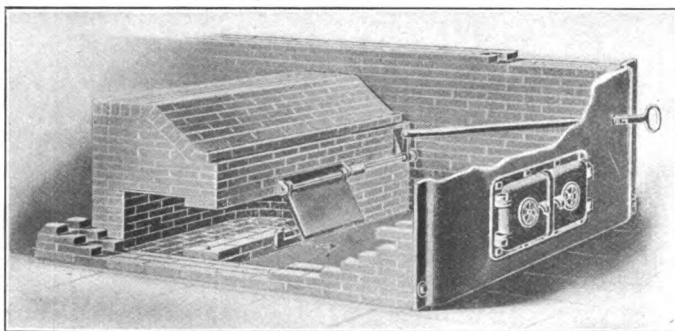

Fig. 27. Air Duct Arranged to Introduce Air through Opening in Bridge Wall

the doors. Fig. 27 shows the former arrangement with the extended handle for operating the damper from the outside of the boiler front. The blower is connected by means of a suitable duct with the chamber within the bridge wall and the air admitted to the ash-pit in a broad sheet near the floor by means of the form and position of the inlet

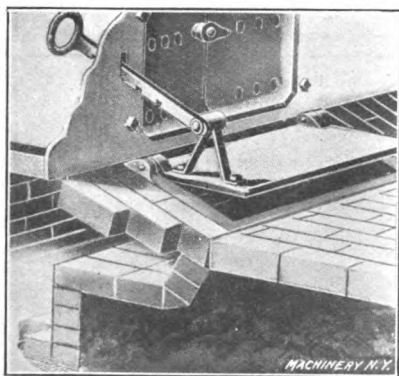

Fig. 28. Arrangement for admitting Air through Ash-pit Floor

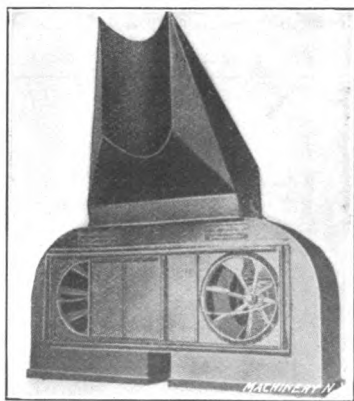

Fig. 29. Arrangement of Double Fans for Induced Draft

damper. Fig. 28 shows a method of admitting the air through the ash-pit floor, a spreading damper being used the same as in the previous case.

A complete outfit of the "balanced draft" system, a special form of forced draft, is shown in Fig. 31, attached to a water-tube boiler. The blower and engine for driving it are shown to the left, and the air is carried to the hollow bridge wall by means of an under-ground duct.

A part of this equipment consists of a special damper placed in the smoke outlet at the rear, and controlled by an automatic regulator which operates in connection with the fan. This combination main-

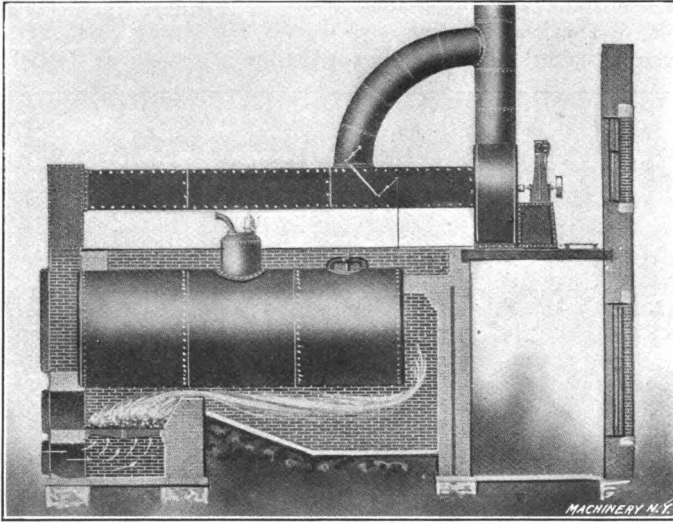

Fig. 30. Fan for Induced Draft Placed on Steel Frame

tains within the furnace a pressure equal to the surrounding atmosphere, and limits the volume of air introduced to that required to effect complete combustion. The draft is balanced by throttling the suction

TABLE II. SIZE AND SPEED OF FANS FOR FORCED DRAFT

Horsepower of Boilers	Diameter of Fan, Feet	Pressure, in Inches of Water					
		½		1		2	
		R. P. M. of Fan	H. P. of Engine	R. P. M. of Fan	H. P. of Engine	R. P. M. of Fan	H. P. of Engine
250	2½	500	1.7	600	2.0	780	2.6
350	3	440	2.4	500	2.7	650	3.5
475	3½	360	3.0	430	3.6	550	4.6
600	4	330	4.0	370	4.5	490	6.0
750	4½	290	4.8	340	5.7	430	7.4
950	5	250	6.0	300	7.0	380	9.0
1100	5½	230	7.0	270	8.3	360	11.0

of the chimney in exact proportion to the speed of the blower, and this, in turn, is governed by variations in the boiler pressure.

#### Fans for Forced Draft

Steel plate blowers of the centrifugal type are commonly used for mechanical draft. These may be of the regular form used for ventilating purposes, or of the multivane type, which is a common form of

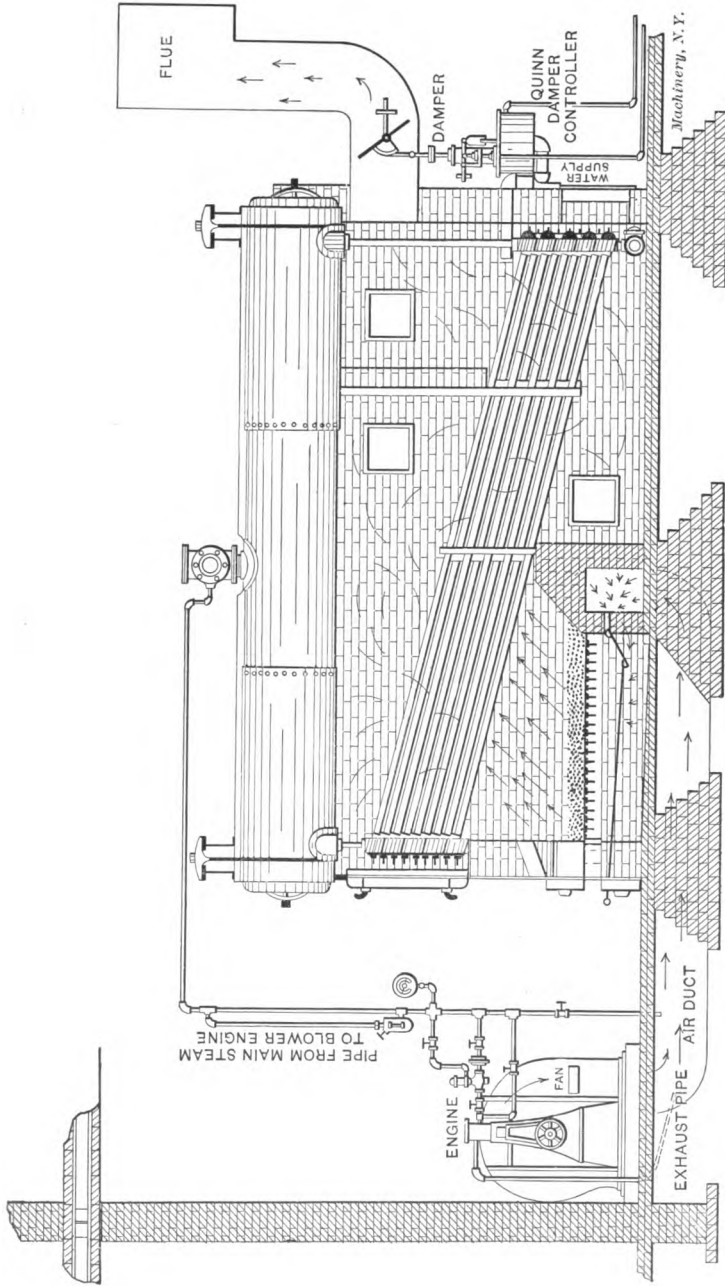

Fig. 81. Water-tube Boiler with "Balanced" Draft

centrifugal fan having a large number of shallow vanes or blades. The fan may be driven by a direct-connected steam engine or turbine, or by an electric motor. Sometimes it is belted to a counter-shaft. The steam engine or turbine seems to give the most satisfactory results, everything considered, being easily protected from dirt, and not injured by the high temperature to which it is exposed. The speed is easily regulated by the boiler pressure, and the exhaust can be used in the feed-water heater.

Table II gives the size and speed of fan and brake horsepower of engines for producing different ash-pit pressures for boilers of different ratings. The figures in the table are based on a coal consumption of 4 pounds per horsepower per hour, and are for a standard ventilating fan in which the width equals  $\frac{1}{2}$  the diameter. From the table we find, for example, that a 600 horsepower boiler plant requires a 4-foot

TABLE III. SIZE AND SPEED OF FANS FOR INDUCED DRAFT

Horsepower of Boilers	Diameter of Fan, Feet	Pressure in Inches of Water					
		$\frac{1}{2}$		1		2	
		R. P. M. of Fan	H. P. of Engine	R. P. M. of Fan	H. P. of Engine	R. P. M. of Fan	H. P. of Engine
190	2 $\frac{1}{2}$	690	2.3	810	2.7	1050	3.4
250	3	580	3.0	660	3.6	860	4.6
350	3 $\frac{1}{2}$	490	4.1	570	4.8	740	6.3
490	4	430	5.4	500	6.0	650	8.0
580	4 $\frac{1}{2}$	390	6.6	450	7.6	580	10.0
690	5	340	8.0	390	9.2	510	12.0
830	5 $\frac{1}{2}$	310	9.7	360	11.0	490	14.5
975	6	280	11.2	340	13.0	430	17.0
1300	7	240	15.0	280	18.0	380	23.0

fan driven at a speed of 370 revolutions per minute by a 4.5 horsepower engine to produce an ash-pit pressure of 1 inch water column.

#### Induced Draft

In the induced draft system the fan is placed between the furnace and the chimney, and the air drawn through the furnace by suction. This corresponds with the natural draft produced by a chimney, and also permits of the use of an economizer in the main smoke connection. With this arrangement, all leakage is inward and there is no danger of dust and smoke being blown into the fire-room. On the other hand, a system of induced draft is more expensive to install, because the gases, being at a higher temperature, have a greater volume, and require a higher speed and more power to move them. In the induced system the fan may be placed on top of the boiler, or on a steel frame, as shown in Fig. 30, thus saving space. Fig. 29 shows an arrangement of double fans for induced draft. In this case the hot gases pass through the fan which makes it necessary to provide water-cooled bearings. The accompanying Table III is similar to Table II, but is corrected to correspond with the conditions to be met with in induced draft.

## CHAPTER V

### OIL FUEL

There are two principal methods of burning oil under steam boilers, depending upon the form of burner used. In the one most frequently used, the oil is mixed with steam or compressed air inside the burner and thrown into the furnace in the form of a spray. In the other case

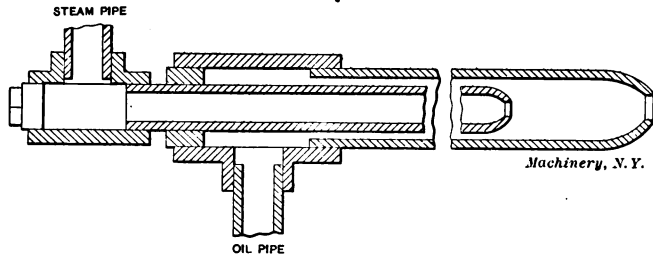

Fig. 32. Simple Burner of the Injector Type

the oil is made to drop upon a sheet of steam or compressed air after it is discharged from the nozzle, and the mixture formed outside the burner. In still another form, the oil is first heated and then forced under a high pressure through a special form of nozzle which breaks it into a fine spray.

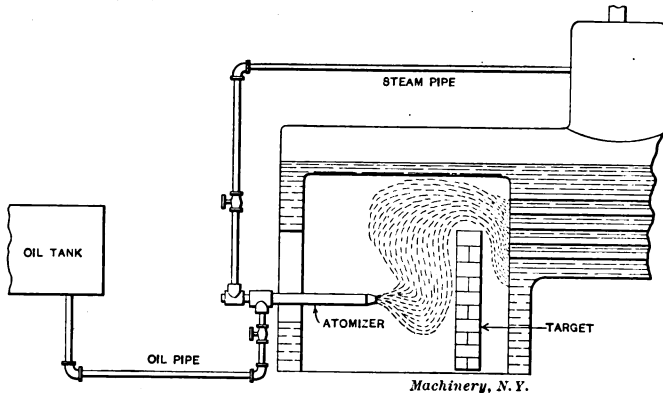

Fig. 33. An Oil-burning Furnace

The use of compressed air in the burner is more efficient than steam, but requires a more complicated apparatus, as it has to be compressed and heated to get the best results. Steam, on the other hand, while not so efficient from the heating standpoint, can be taken directly from the boiler under pressure and at a high temperature, and can also be used for heating the oil, which is an important point.

## Burners

The best form of burner depends upon the kind of oil to be used. A simple burner of the injector type is shown in Fig. 32. It is so constructed that when the oil reaches a certain point, a jet of steam mixes with it and forces it through the nozzle of the atomizer into the fire-box in the form of a spray, as shown in Fig. 33. The spatter wall or target shown in the illustration is to prevent the blaze from striking directly upon the tube sheet of the boiler.

The Lunkenheimer burner is shown in section in Fig. 34. The flow of oil is regulated by the needle point at the end of the valve *D*. Steam

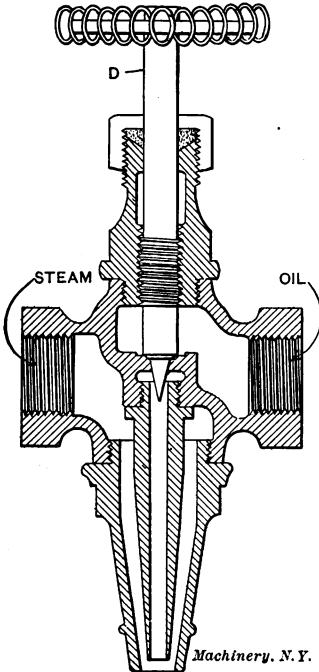

Fig. 34. The Lunkenheimer Burner

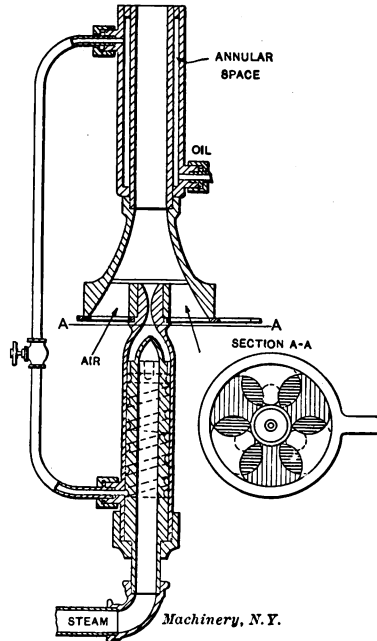
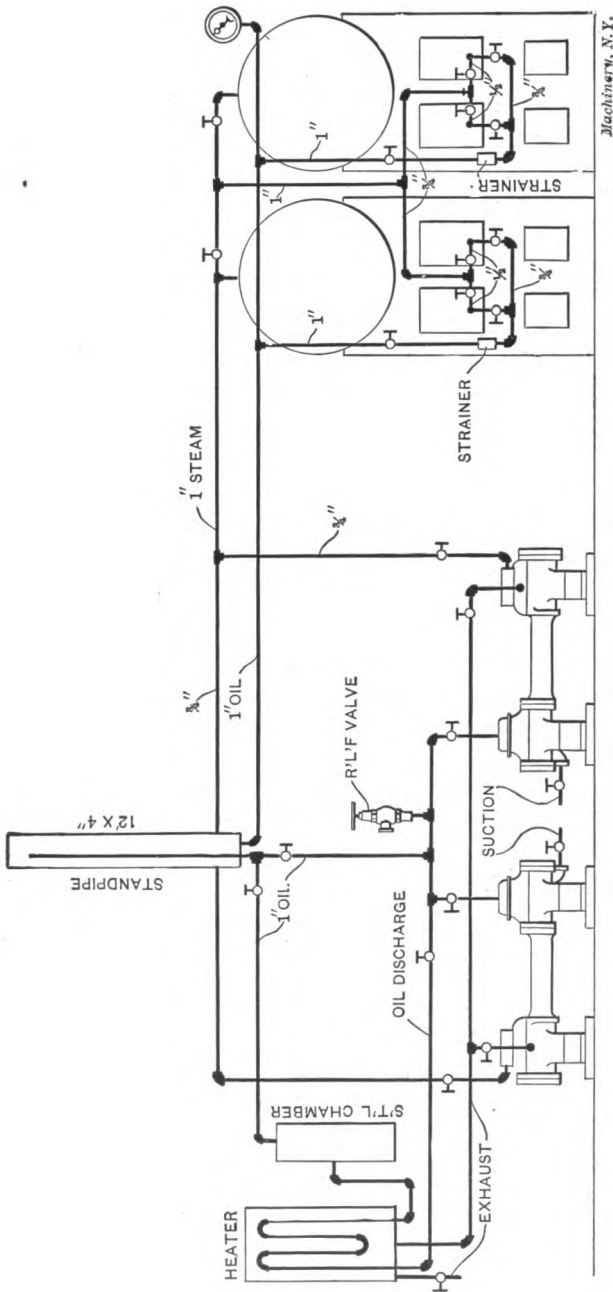

Fig. 35. The Branch Burner

enters at the left and oil at the right, the connecting pipes being provided with valves not shown in the illustration. The Branch burner, illustrated in Fig. 35, differs from the others shown, in that it preheats the oil to be burned in a mixture of steam and air. The oil, entering at the right, is heated in its passage through the annular space, from which it flows through the small pipe at the left to the spiral groove around the nozzle, which heats it still further. The air supply is drawn in, as shown by the arrows, through a regulating damper of special design. No target or spatter wall is required with this burner.



*Machinery, N. Y.*

Fig. 36. Typical Arrangement of Piping for Oil-burning System

A typical arrangement of piping for an oil-burning system, using steam in the burners, is shown in Fig. 36. The pipe the oil flows under a constant head to the burners. Steam for the heater is under-ground, and the oil is pumped from here to a standpipe, passing on its way

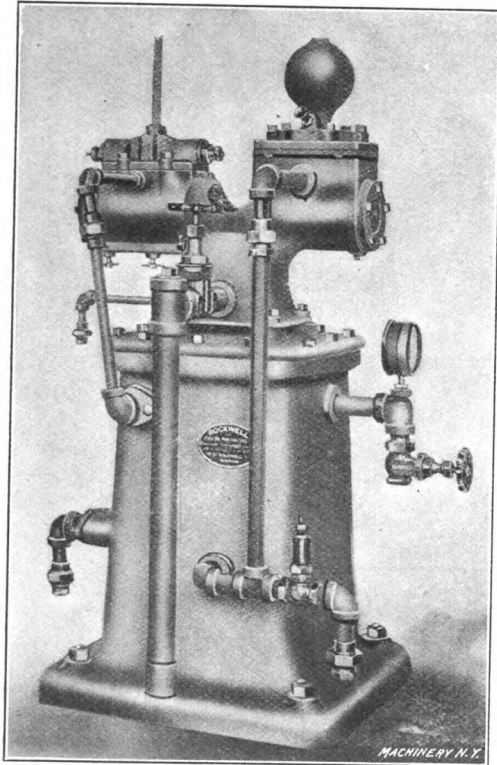

Fig. 37. The Rockwell Pump, Designed for Delivering Oil from Storage Tank to Furnace

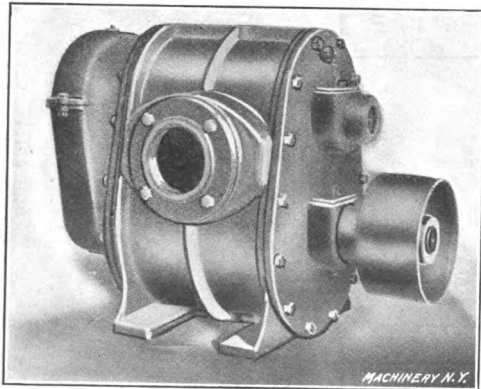

Fig. 38. Pressure Blower for Furnishing Air to Oil-burners

Fig. 37 shows the Rockwell pump, which is especially designed for delivering the oil from the storage tank to the boilers. It is steam driven, and the exhaust is used for heating the oil. A pressure blower for furnishing compressed air for certain forms of air burners is shown in Fig. 38.

In the Koerting system of oil firing, shown in Figs. 39 and 40, the oil is heated above the boiling or flash point and is then atomized by means of a centrifugal spray nozzle at the entrance of the furnace as indicated in Fig. 39. A general view of the outfit is shown in Fig. 40. The oil flows from a supply tank to a central pumping outfit, where it passes through a primary heater and flows through filters to the pressure pump, which forces it under a pressure of 50 to 75 pounds per square inch through a second heater on its way to the burners. The various parts of the system in Fig. 40 are as follows: *E*, exhaust pipe; *F*, filter; *H*, heater; *N*, spray nozzles; *OP*, oil pressure pipe; *OS*, oil supply pipe; *R*, safety valve, and *S*, steam pipe.

For the best results with burners of the injector type, the oil should



be delivered to the burner at a temperature of about 150 degrees F. The steam pressure is commonly 15 to 40 pounds for low-pressure systems, and 60 to 120 pounds for high-pressure systems. The tanks used for storing the oil are usually placed under-ground, but in this case a

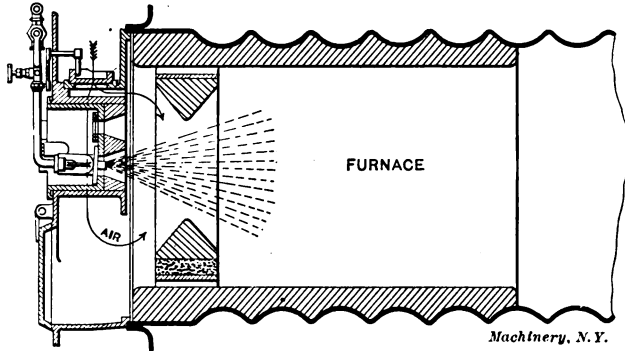

Fig. 39. Arrangement at Furnace Entrance, Koerting System of Oil Firing

walled pit should be provided so that they may be easily reached for painting and repairs. The oil may be pumped directly to the burners or to a standpipe from which it is fed under a constant pressure. The

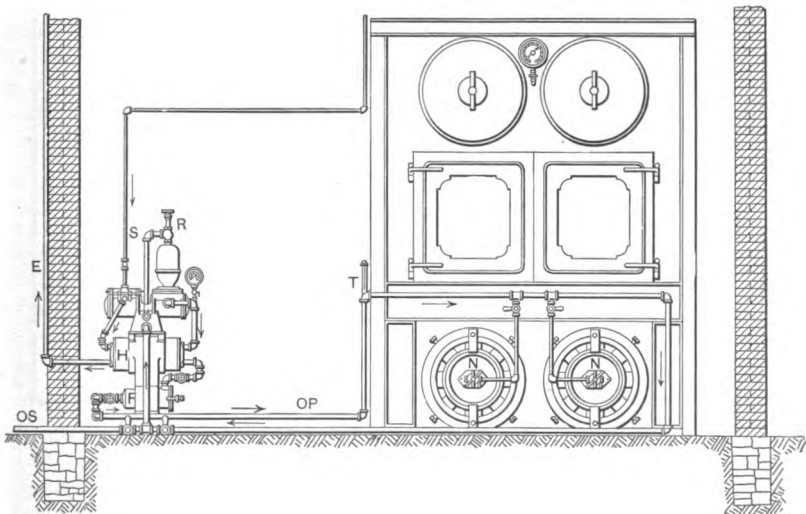

Fig. 40. General Arrangement of Koerting Oil Firing System

gravity system of feeding the burners directly from the storage tank is not recommended, as it involves certain elements of danger not present in the methods mentioned above.

## CHAPTER VI

### CHIMNEYS

The requirements of a chimney are that it shall provide sufficient draft to burn the required amount of fuel on the grate in a given time, and also carry off the obnoxious gases. The strength of the draft depends upon the height of the chimney, while the volume of the gases to be carried off fixes the sectional area of the flue. The exact proportions depend upon the kind and amount of fuel to be burned, the design and arrangement of the boilers and connecting flues, and the altitude of the plant above the sea level. No universal formula has yet been devised which covers all of these conditions, so that it is more common

TABLE IV. SIZE OF CHIMNEYS

Diameter, Inches	Height of Chimney and Commercial Horsepower										
	50 Feet	60 Feet	70 Feet	80 Feet	90 Feet	100 Feet	125 Feet	150 Feet	175 Feet	200 Feet	225 Feet
18	23	25	27								
21	35	38	41								
24	49	54	58	62							
27	65	72	78	83							
30	84	92	100	107	113						
33		115	125	133	141						
36		141	152	161	173	182					
39			183	196	208	219					
42			216	231	245	258	271				
48				311	330	348	365	389			
54					427	449	472	503	551		
60					536	565	593	632	692	748	
66						694	728	776	849	918	981
72						835	876	934	1023	1105	1181
78							1038	1107	1212	1310	1400
84							1214	1294	1418	1531	1637
90								1496	1639	1770	1893
96									1876	2027	2167

in designing a chimney to use experimental data obtained from chimneys in actual use. In a formula given by Kent it is assumed that 15 pounds of coal will be burned per hour upon each square foot of grate surface, with the draft produced by a chimney 80 feet high. This formula is in common use and has been employed in computing the chimney dimensions given in Table IV. To find the pounds of coal which may be burned per hour with any chimney given in the table, multiply the corresponding horsepower by 5.

Another method used is to determine the height of stack required to burn different grades of fuel, and then make the flue area from

one-seventh to one-tenth the grate area, depending upon the height of chimney. For example:

Height of Chimney, in Feet	Ratio of Chimney Area to Grate Area
75 to 100	1/7
100 to 125	1/8
125 to 150	1/9
150 to 200	1/10

The following method, taken from the *Engineer*, shows how to find the height of flue required to produce sufficient draft to burn different

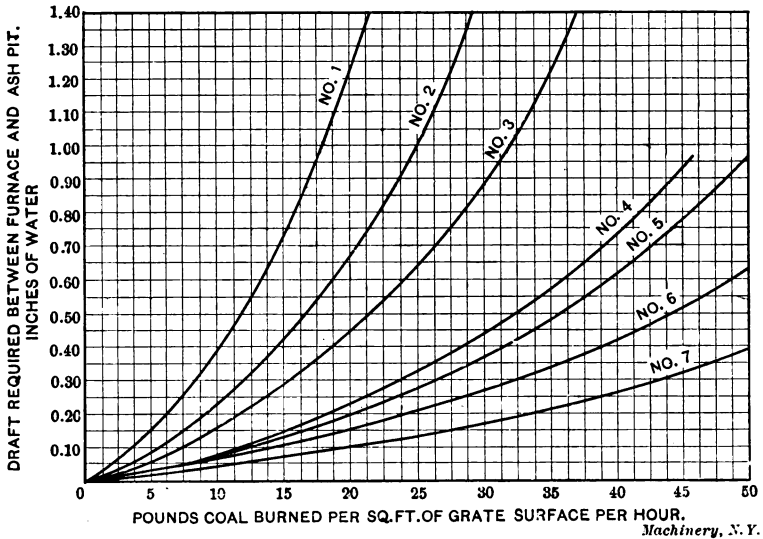

Fig. 41. Diagram of Relation between Draft and Coal Burned

Machinery, N. Y.

grades of fuel and to overcome the friction in the furnace, and in the smoke flue between the furnace and the chimney. The formula for height is:

$$H = \frac{d}{0.8 K}$$

in which

$H$  = height of chimney, in feet,

$d$  = "available draft,"

$K$  = a constant, depending upon the temperature of the flue gases.

The "available draft" is made up of three parts: (1) that required between the ash-pit and furnace; (2) between the furnace and flue; (3) in the flue between the furnace and chimney. The first of these depends upon the rate of combustion and kind of fuel, and is given by the curves in Fig. 41, in which the different numbers correspond to the grades of coal as given in the following:

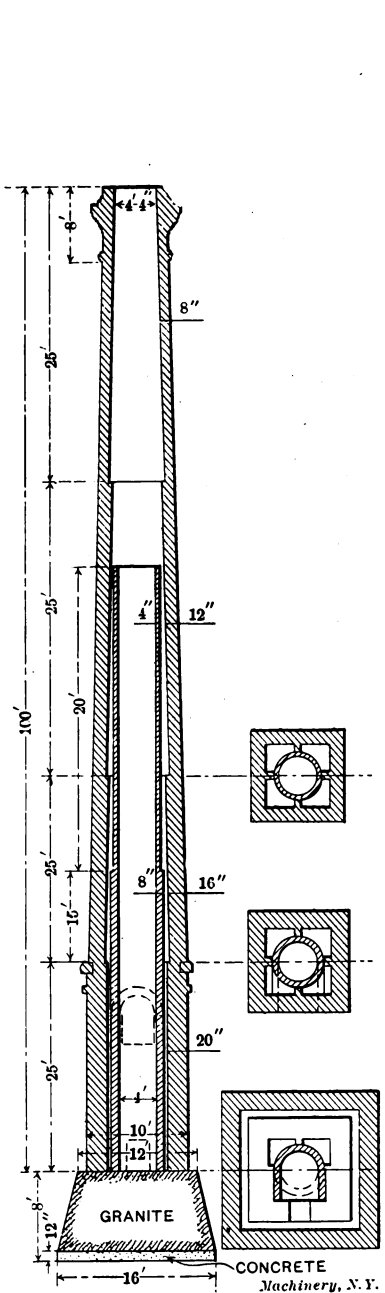

Fig. 42. Proportions of 100-foot Chimney, not drawn to Scale

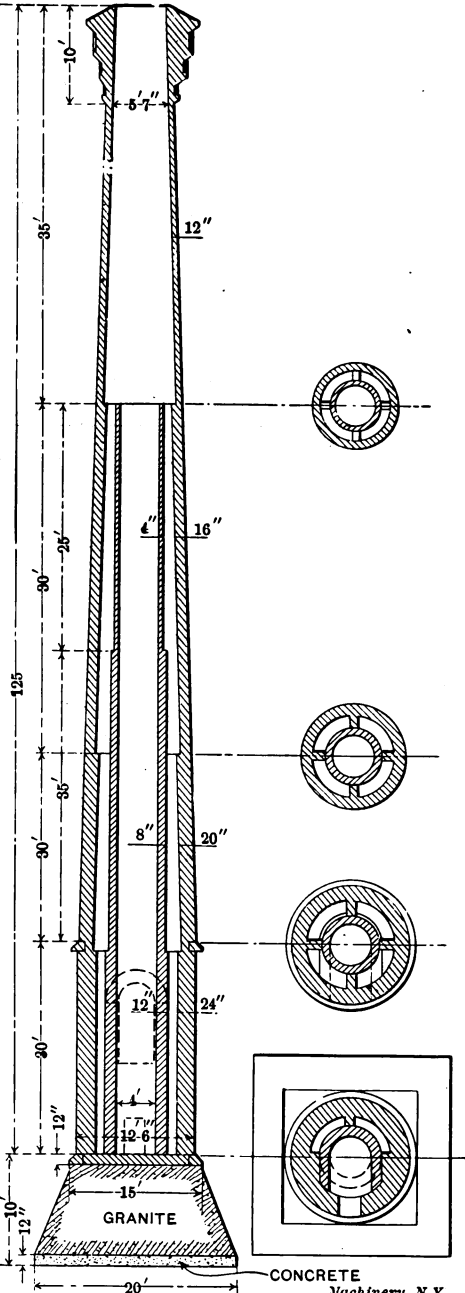

Fig. 43. Proportions of 125-foot Chimney, not drawn to Scale

Number of Curve	Kind of Coal
1	Anthracite buckwheat, No. 3.
2	Anthracite buckwheat, No. 1.
3	Anthracite pea.
4	Bituminous slack, on chain grate.
5	Run-of-mine, semi-bituminous.
6	Bituminous, slack.
7	Run-of-mine, bituminous.

The second item of draft, for average conditions, may be taken as 0.4 inch of water, which allows for a reasonable amount of overload. The third item may be found by allowing 0.1 inch of water for each 100 feet length of straight smoke flue, and 0.05 inch for each right-angled

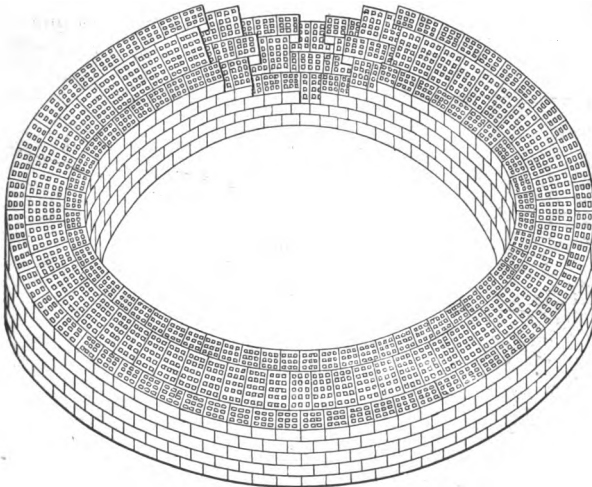
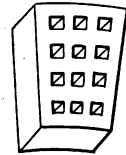
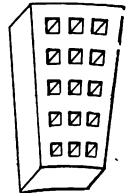

Fig. 44. Construction of Alphons Custodis Chimney



Machinery, N. Y.

Fig. 45

bend. For example, the required "available draft" for burning 20 pounds of anthracite pea coal per square foot of grate per hour in a furnace having a smoke pipe 100 feet long with one right-angled bend will be:

$$0.45 + 0.4 + 0.1 + 0.05 = 1.00 \text{ inch of water column.}$$

The value of *K* in the formula may be taken as follows:

Temperature of Flue Gases, Degrees F.	Value of <i>K</i>
500	0.0067
550	0.0071
600	0.0075

It will be sufficiently accurate for all ordinary conditions if the value of *K* is taken as 0.007.

*Example:*—What should be the height and diameter of flue of a chimney for the conditions stated in the preceding example, for a boiler plant having a total of 150 square feet of grate surface?

$$H = \frac{1}{0.8 \times 0.007} = 178 \text{ feet.}$$

Referring back to the table of ratios between chimney and grate areas we find that a flue area of  $150 \div 10 = 15$  square feet is required for this height of chimney. This corresponds to a diameter of 4 feet and 5 inches. The chimney in this case would probably be made 180 feet high, with a flue of  $4\frac{1}{2}$  feet diameter.

#### Chimney Construction

Chimneys are commonly built of brick, concrete, and steel plate. The foundation is an important part, and should be laid under the direction of an experienced engineer. It is commonly made of concrete, and

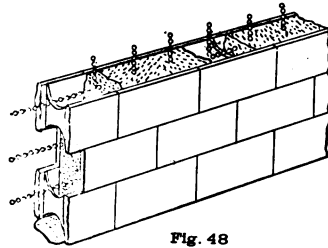
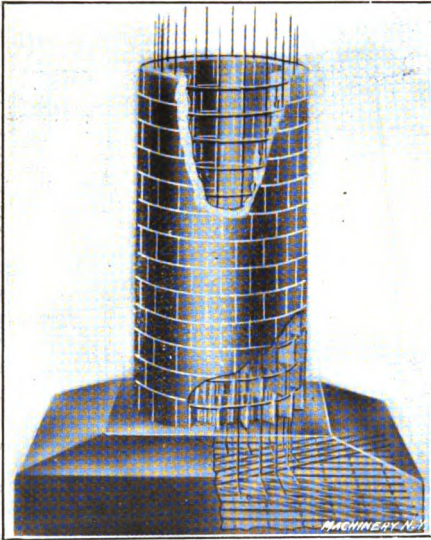

Fig. 48

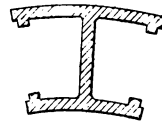

Fig. 47

Machinery, N. Y.

Figs. 46 to 48. The Wiederholdt Chimney

should be of such dimensions that the pressure will not exceed one ton per square foot in the case of a soft clay footing. If the ground is of stiff clay, or well packed loam or sand, the load may be twice this. In computing the weight of a chimney, granite masonry may be figured on a basis of 160 to 170 pounds per cubic foot, and brick-work from 120 to 130 pounds.

The thickness of the walls will depend upon the height, usual dimensions for brick chimneys 100 and 125 feet high being given in Figs. 42 and 43, respectively. In these designs the cores are only carried up for a portion of the height. Some engineers prefer to extend the lining the full height if the boilers are likely to be forced. In case this is done, the lining and outside wall should be entirely independent and not tied together at the top. A circular flue is always best, and a circular or octagonal shape for the outside wall offers the least resist-

ance to the wind. The top should be thoroughly protected by a cap of tile or cast-iron plates, to keep the water from penetrating the masonry.

Fig. 44 shows a section of the Alphons Custodis chimney, which is constructed of hollow radial brick, of the general form shown in Fig. 45. Chimneys of this construction are ordinarily built without a core, the hollow brick forming a sufficient air space for insulating purposes. For chemical works, metal refineries, and furnaces where the temperature of the gases is such as to disintegrate the brick, a special lining is provided.

The Wiederholdt chimney is shown in Fig. 46. This is constructed of a special form of tile, Fig. 47, filled in with steel rods and concrete as shown in detail in Fig. 48. Self-supporting steel stacks are often used in place of masonry chimneys. They require a solid foundation of concrete, and special anchor bolts for holding them in place against wind pressure.

# OUTLINE OF A COURSE IN SHOP AND DRAFTING-ROOM MATHEMATICS, MECHANICS, MACHINE DESIGN AND SHOP PRACTICE

Any intelligent man engaged in mechanical work can acquire a well-rounded mechanical education by using as a guide in his studies the outline of the course in mechanical subjects given below. The course is laid out so as to make it possible for a man of little or no education to go ahead, beginning wherever he finds that his needs begin. The course is made up of units so that it may be followed either from beginning to end; or the reader may choose any specific subject which may be of especial importance to him.

✓ **Preliminary Course in Arithmetic**  
JIG SHEETS 1A TO 5A:—Whole Numbers: Addition, Subtraction, Multiplication, Division, and Factoring.

JIG SHEETS 6A TO 15A:—Common Fractions and Decimal Fractions.

## Shop Calculations

Reference Series No. 18. SHOP ARITHMETIC FOR THE MACHINIST.

Reference Series No. 52. ADVANCED SHOP ARITHMETIC FOR THE MACHINIST.

Reference Series No. 53. USE OF LOGARITHMIC TABLES.

Reference Series Nos. 54 and 55. SOLUTION OF TRIANGLES.

Data Sheet Series No. 16. MATHEMATICAL TABLES. A book for general reference.

## Drafting-room Practice

Reference Series No. 2. DRAFTING-ROOM PRACTICE.

Reference Series No. 8. WORKING DRAWINGS AND DRAFTING-ROOM KINKS.

Reference Series No. 33. SYSTEMS AND PRACTICE OF THE DRAFTING-ROOM.

## General Shop Practice

Reference Series No. 10. EXAMPLES OF MACHINE SHOP PRACTICE.

Reference Series No. 7. LATHE AND PLANER TOOLS.

Reference Series No. 25. DEEP HOLE DRILLING.

Reference Series No. 38. GRINDING AND GRINDING MACHINES.

Reference Series No. 48. FILES AND FILING.

Reference Series No. 32. SCREW THREAD CUTTING.

Data Sheet Series No. 1. SCREW THREADS. Tables relating to all the standard systems.

Data Sheet Series No. 2. SCREWS, BOLTS AND NUTS. Tables of standards.

Data Sheet Series Nos. 10 and 11. MACHINE TOOL OPERATION. Tables relating to the operation of lathes, screw machines, milling machines, etc.

Reference Series Nos. 50 and 51.

PRINCIPLES AND PRACTICE OF ASSEMBLING MACHINE TOOLS.

Reference Series No. 57. METAL SPINNING.

## Jigs and Fixtures

Reference Series Nos. 41, 42 and 43. JIGS AND FIXTURES.

Reference Series No. 3. DRILL JIGS. Reference Series No. 4. MILLING FIXTURES.

## Punch and Die Work

Reference Series No. 6. PUNCH AND DIE WORK.

Reference Series No. 13. BLANKING DIES.

Reference Series No. 26. MODERN PUNCH AND DIE CONSTRUCTION.

## Tool Making

Reference Series No. 64. GAGE MAKING AND LAPPING.

Reference Series No. 21. MEASURING TOOLS.

Reference Series No. 31. SCREW THREAD TOOLS AND GAGES.

Data Sheet Series No. 3. TAPS AND THREADING DIES.

Data Sheet Series No. 4. REAMERS, SOCKETS, DRILLS, AND MILLING CUTTERS.

## Hardening and Tempering

Reference Series No. 46. HARDENING AND TEMPERING.

Reference Series No. 63. HEAT TREATMENT OF STEEL.

## Blacksmith Shop Practice and Drop Forging

Reference Series No. 44. MACHINE BLACKSMITHING.

Reference Series No. 61. BLACKSMITH SHOP PRACTICE.

Reference Series No. 45. DROP FORGING.

## Automobile Construction

Reference Series No. 59. MACHINES, TOOLS AND METHODS OF AUTOMOBILE MANUFACTURE.

Reference Series No. 60. CONSTRUCTION AND MANUFACTURE OF AUTOMOBILES.



### Theoretical Mechanics

Reference Series No. 5. FIRST PRINCIPLES OF THEORETICAL MECHANICS.

Reference Series No. 19. USE OF FORMULAS IN MECHANICS.

### Gearing

Reference Series No. 15. SPUR GEARING.

Reference Series No. 37. BEVEL GEARING.

Reference Series No. 1. WORM GEARING.

Reference Series No. 20. SPIRAL GEARING.

Data Sheet Series No. 5. SPUR GEARING. General reference book containing tables and formulas.

Data Sheet Series No. 6. BEVEL, SPIRAL AND WORM GEARING. General reference book containing tables and formulas.

### General Machine Design

Reference Series No. 9. DESIGNING AND CUTTING CAMS.

Reference Series No. 11. BEARINGS.

Reference Series No. 56. BALL BEARINGS.

Reference Series No. 58. HELICAL AND ELLIPTIC SPRINGS.

Reference Series No. 17. STRENGTH OF CYLINDERS.

Reference Series No. 22. CALCULATIONS OF ELEMENTS OF MACHINE DESIGN.

Reference Series No. 24. EXAMPLES OF CALCULATING DESIGNS.

Reference Series No. 40. FLY-WHEELS.

Data Sheet Series No. 7. SHAFTING, KEYS AND KEYWAYS.

Data Sheet Series No. 8. BEARINGS, COUPLINGS, CLUTCHES, CRANE CHAIN AND HOOKS.

Data Sheet Series No. 9. SPRINGS, SLIDES AND MACHINE DETAILS.

Data Sheet Series No. 19. BELT, ROPE AND CHAIN DRIVES.

### Machine Tool Design

Reference Series No. 14. DETAILS OF MACHINE TOOL DESIGN.

Reference Series No. 16. MACHINE TOOL DRIVES.

### Crane Design

Reference Series No. 23. THEORY OF CRANE DESIGN.

Reference Series No. 47. DESIGN OF ELECTRIC OVERHEAD CRANES.

Reference Series No. 49. GIRDERS FOR ELECTRIC OVERHEAD CRANES.

### Steam and Gas Engine Design

Reference Series Nos. 67 to 72, inclusive. STEAM BOILERS, ENGINES, TURBINES AND ACCESSORIES.

Data Sheet Series No. 15. HEAT, STEAM, STEAM AND GAS ENGINES.

Data Sheet Series No. 13. BOILERS AND CHIMNEYS.

Reference Series No. 65. FORMULAS AND CONSTANTS FOR GAS ENGINE DESIGN.

### Special Course in Locomotive Design

Reference Series No. 27. BOILERS, CYLINDERS, THROTTLE VALVE, PISTON AND PISTON ROD.

Reference Series No. 28. THEORY AND DESIGN OF STEPHENSON AND WALSCHAERTS VALVE MOTION.

Reference Series No. 29. SMOKE-BOX, FRAMES AND DRIVING MACHINERY.

Reference Series No. 30. SPRINGS, TRUCKS, CAB AND TENDER.

Data Sheet Series No. 14. LOCOMOTIVE AND RAILWAY DATA.

### Dynamos and Motors

Reference Series No. 34. CARE AND REPAIR OF DYNAMOS AND MOTORS.

Data Sheet Series No. 20. WIRING DIAGRAMS, HEATING AND VENTILATION, AND MISCELLANEOUS TABLES.

Reference Series Nos. 73 to 78, inclusive. PRINCIPLES AND APPLICATIONS OF ELECTRICITY.

### Heating and Ventilation

Reference Series No. 39. FANS, VENTILATION AND HEATING.

Reference Series No. 66. HEATING AND VENTILATING SHOPS AND OFFICES.

Data Sheet Series No. 20. WIRING DIAGRAMS, HEATING AND VENTILATION, AND MISCELLANEOUS TABLES.

### Iron and Steel

Reference Series No. 36. IRON AND STEEL.

Reference Series No. 62. TESTING THE HARDNESS AND DURABILITY OF METALS.

### General Reference Books

Reference Series No. 35. TABLES AND FORMULAS FOR SHOP AND DRAFTING-ROOM.

Data Sheet Series No. 12. PIPE AND PIPE FITTINGS.

Data Sheet Series No. 17. MECHANICS AND STRENGTH OF MATERIALS.

Data Sheet Series No. 18. BEAM FORMULAS AND STRUCTURAL DESIGN.

Data Sheet Series No. 20. WIRING DIAGRAMS, HEATING AND VENTILATION AND MISCELLANEOUS TABLES.

1900

