

TJ  
7  
M3  
v. 123

UC-NRLF



B 3 018 852

5 CENTS

# METAL COLORING AND FINISHING

METHODS OF PRODUCING COLORS ON IRON,  
STEEL, COPPER, BRONZE, BRASS AND  
ALUMINUM—BURNISHING METALS



MACHINERY'S REFERENCE BOOK NO. 123  
PUBLISHED BY MACHINERY, NEW YORK

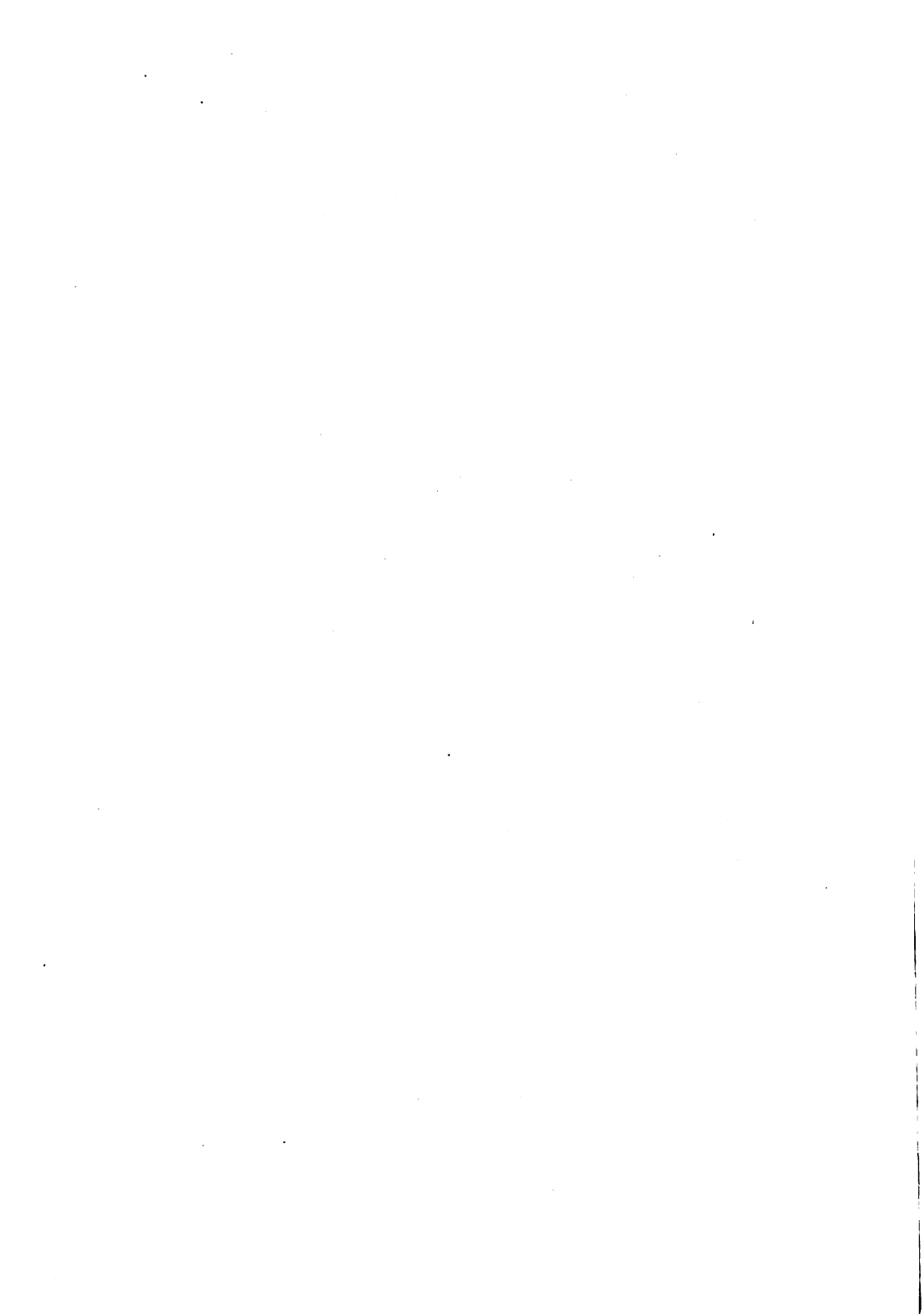

# MACHINERY'S REFERENCE SERIES

EACH NUMBER IS ONE UNIT IN A COMPLETE LIBRARY OF  
MACHINE DESIGN AND SHOP PRACTICE REVISED AND  
REPUBLISHED FROM MACHINERY

NUMBER 123

## METAL COLORING AND FINISHING

### CONTENTS

Principles of Metal Coloring, by W. J. KAUP	- - 3
Coloring Iron and Steel, by E. F. LAKE	- - - 9
Coloring Non-ferrous Metals and Alloys, by E. F. LAKE	15
Lathe Burnishing of Metals, by WILLIAM A. PAINTER	- 26
The Ball Burnishing Process, by CHESTER L. LUCAS	- 33

## CHAPTER I

### PRINCIPLES OF METAL COLORING

The subject of metal finishing and coloring has received but scant attention in mechanical publications; this is rather surprising when we note the inclination of the manufacturers of today to combine this artistic treatment with utility, and add contrast of color to the severe straight-line plainness of our commercial products, to produce more beautiful effects. There is nothing new in metal coloring. Ages ago it was old in Japan, and to the Orient we must really turn for original authority on successful coloring of metals.

The purpose of this book is to give to those who are interested the results of the experience of a number of authorities in coloring metals, solely from the manufacturing side, rather than from the chemist's standpoint. So many conditions enter into the work that no law can be laid down by which everyone can obtain the same satisfactory results, for with everyone the coloring of metals must at first be more or less of an experimental nature. A cheap monochrome color can be produced by the novice who is unacquainted with the metallurgical properties of metals and chemical actions of solutions used, but the very fact that the slightest change in the alloy, as well as in the strength of the coloring solutions, produces a different shade of coloring under the same treatment, makes it essential that the operator should have considerable knowledge of metallurgy and chemistry for any except the simplest work.

First, let us consider the different methods and conditions under which color can be obtained, *viz.*, by heat-treatment alone; by varnishes and lacquers; and by corroding agents or chemical compounds. We will treat each under its separate heading, but first will refer briefly to the Bunsen burner, by the use of which, together with a pot of heavy fish or lard oil and a pair of tweezers, one can color small pieces by the heat process.

#### The Bunsen Burner

We will take for granted that some readers, at least, are not acquainted with the Bunsen burner, or at least the principle of its operation. The illustration herewith will explain its construction. The object of this burner is to procure a flame capable of producing great heat, but which will not smoke any vessel or article heated in it or over it; by carefully noting the construction, it will be readily seen how this is accomplished. The force of gas, escaping through the small aperture at *A*, draws the air through the holes in the sleeve surrounding the jet. The air and gas mix together, consuming the carbon produced by the decomposing gases before it becomes incandescent, and producing the flame desired. The air is controlled by

a sleeve, which turns around the inner tube, thereby increasing or decreasing the size of the opening through which the air is drawn. A few minutes' use of the burner will enable anyone to get the flame right, but a few points with respect to this may be useful. The flame should be about  $2\frac{1}{2}$  inches high only; it should not blow; it should burn with blue light, showing a defined inner cone of blue-green light immediately *above* which, at point *C*, the greatest heat is obtained.

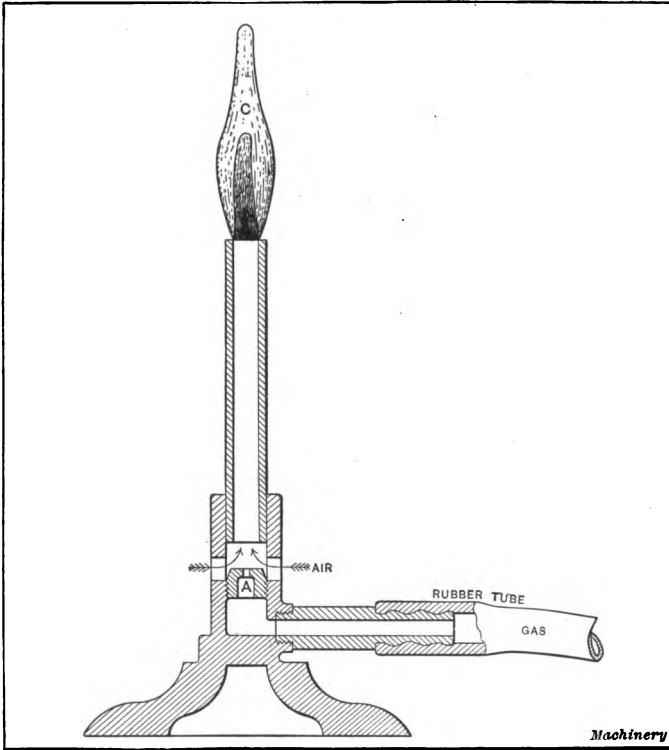

Sectional View, showing Principle of Action of Bunsen Burner

#### Producing Color by Heat-treatment

The work treated over a Bunsen burner is necessarily small, such as small screws, bolt heads, washers, pins, etc. The work should be thoroughly cleansed from all grease, either by dipping in a strong hot lye solution or in alcohol, and then dried in clean sawdust; it is absolutely essential that the entire surface presents the same physical condition, to obtain uniformity of color. The work should be subjected to the flame immediately above the inner cone of light. Carefully watch the varying change of color and withdraw from the heat before it quite reaches the blue desired; then hold the work in the air until the desired shade appears, and "check" the color change by dipping

the piece in the oil and allowing it to cool in it. Very good bluing can be done in this way by the beginner on pieces of uniform shape, but much more skill will be required on pieces where the shape is irregular, having large surfaces in one place and small in another, when the heat must be confined to the larger part for a longer period of time than is necessary for the small parts. In such cases the amount of heat contained in the larger part is usually sufficient to produce the desired effect in the smaller details after taking the piece from the flame.

Another very common method, especially for flat work, is to heat a flat piece of iron or steel of sufficient size to retain the heat for a long time and place the piece to be colored on the hot surface, sometimes in direct contact with the hot metal, and at other times on a piece of sheet iron placed on the hot piece. When the desired color appears, plunge the work into an oil bath. Yet another way is the hot-sand method. A pan of sand is heated to a high degree, the parts are buried in it and rolled around, and when the required color appears it is "checked" as before. In all these methods the colors that appear to the eye come in the following order: Pale straw, dark straw, brown, purple, blue and green. The processes are identical with those of tempering steel by the color method. The wearing life of work done by these methods is naturally very short, as the colors rub off very quickly by handling.

#### Corroding Agents

We now come to the corroding agents—chemical compounds—by which the most successful results are obtained, by the dipping process, or "wet coloring," as it is called. There are many methods known as "dry coloring" which have been repeatedly tried; in this compounds are mixed together, forming pastes that are applied with a brush and allowed to remain any number of hours and then rubbed off, but most of these methods are more or less failures. The wet method presents many advantages, both as regards economy of time and uniform results.

To color copper articles, such as ash trays, pin dishes, receivers, etc., a solution of ammonium sulphide will give the best results to the beginner. The greatest variety of colors, from light brown to black, can be obtained by this simple method. Use a dilute solution, cold. A good working solution is produced by diluting a saturated solution of ammonium sulphide with 10 to 40 parts of water. A light brown color is produced by dipping the work for a very short time in the solution, withdrawing it, and allowing it to dry in the air. A darker shade of brown is obtained by a longer immersion, according to the color desired, after which the work is allowed to dry in sawdust. To obtain a black coloring, allow the article to remain quite a while in the bath, and, after removing, dip it in alcohol, after which the alcohol is burnt off, leaving a black coating. These colors can be permanently fixed by a transparent lacquer. The objection to ammonium sulphide

is the great care necessary in handling, as it leaves an indelible stain upon the fingers, and also has a very obnoxious odor. The ammonium sulphide also decomposes in time, depositing sulphur. It should be kept in a dark-colored bottle provided with a glass stopper. It is not good for brass, being adapted only for copper.

Another solution for coloring copper which yields very good results is:

Copper nitrate .....	1 part
Water .....	3 parts

This forms a deposit of copper salt, and, if heated, the salt is decomposed into a black copper oxide. The greenish tints are obtained by the following solution:

Ammonium carbonate .....	2 ounces
Ammonium chloride .....	2/3 ounce
Water .....	16 ounces

This solution gives good results on both copper and brass, different colorings being obtained by repeated dippings in the solution, allowing ample time between each for the articles to properly dry.

Many varieties of color can be obtained by different chemical solutions on both copper and brass, but the desirable colors for commercial use are dead black and steely gray.

The following mixture has also given very good results for brass: hydrochloric, or more commonly termed muriatic acid, white arsenic, and silver.

Take any given quantity of arsenic, say  $\frac{1}{2}$  ounce, dissolve it in strong muriatic acid, and then snip off a small piece of a silver dime, if no other silver is at hand. Heat the article to a dull red and dip it in the solution; then allow it to remain until cool. This produces the dull black result so often seen on mathematical instruments. The steely gray is obtained in the same manner, except that the article is not heated to such a high temperature as in the preceding case. By the arsenic solution many good results are obtained by cold dipping also.

In every case where chemical solutions are used, it is well to remember that the slower the rate of deposition the better the results from the wearing standpoint; hence, the longer a dilute solution takes to deposit its coating, the better the color will last, and that is, of course, a very desirable quality. In Chapter III is given a more complete review of the whole subject of coloring non-ferrous metals.

#### Cleaning Old Brass and Copper

In conclusion, it will be well to touch upon the method of cleaning old brass or copper from impurities. The brass articles are strung on a wire, which should be of the same material as the articles, and dipped in the following solution: 1 part nitric acid, 6 parts muriatic acid (hydrochloric acid), and 2 parts water.

The articles are first dipped in a strong hot solution of soda in water, and then into the bath, where they are swirled around for a

time, removed and rinsed in cold water and dried in sawdust. If the metal looks dark and is not quite bright, the nitric acid in the solution should be reduced. Where many pounds of small brass fittings are to be treated, they are put in an earthenware pot containing numerous perforations.

Zinc is often cleaned by dipping into a solution of 16 parts water and 1 part oil of sulphuric acid, for a few moments, and then washing it thoroughly to remove all trace of the bath.

#### Coloring Iron and Steel

The coloring of copper and brass, especially copper, is for its artistic value alone; but from the purely commercial standpoint the coloring of iron and steel is of greater value, because it is used for so many machine parts and parts of guns, small arms, etc., which are treated to produce a blue or black color for the purpose of preserving the metal against corrosion, as well as to give it a handsome appearance.

The following solution will give very satisfactory results with iron or steel if carefully treated: Take equal parts of potassium nitrate and sodium nitrate and fuse by heating mixture until completely melted. The melting point of the mixed nitrate salts is about 600 degrees F. Dip the articles first in boiling lye or strong hot soda water to thoroughly cleanse them from grease; then dip them in the hot mixed nitrate flux, and from there remove them into boiling water to rinse off the nitrate. Different temperatures of the solution will produce different shades of coloring, and sometimes it will be found advisable to use the flux at a temperature as high as 700 degrees F.

In many cases where hardened articles are to be treated it would not be possible to bring the steel to the desired color by this process, because the temperature of the fused nitrates would be so high as to draw the temper of the articles. In such cases the old nitric acid rusting process is generally resorted to. The nitric acid is placed in an earthenware jar and inclosed in a box that can be made practically tight by closing the lid. The article is suspended in the box and the lid closed, and the fumes arising from the acid oxidize the surface of the article; if the article is moistened before placing it in the box, a very much more rapid oxidation is assured, saving considerable time.

Many experiments have been tried with different mixtures for coloring iron and steel, where there is danger of drawing the temper of the metal; of these the following has proved very successful: A wooden box is used, of a size according to the kind of work to be colored. A small steam pipe connects with the box, so that a quantity of steam may flow into it continuously and moisten the air in the box. A bath made of the following ingredients is then placed in the box:

Iron chloride (muriate tincture of steel).....	1 ounce
Alcohol (spirits of wine).....	1 ounce
Corrosive sublimate (mercury bichloride).....	$\frac{1}{4}$ ounce
Strong nitric acid.....	$\frac{1}{4}$ ounce
Blue stone (copper sulphate).....	$\frac{1}{8}$ ounce
Water .....	1 quart



The vapor arising from this bath forms a deposit on the articles, which are allowed to remain in the receptacle a number of hours and rubbed off with a cloth; the operation is repeated if a darker color is desired. Very rich coloring can be obtained by this process, after a little experimenting, and the temper is not affected. Many other methods are included in the detailed descriptions dealing with the coloring of iron and steel given in the next chapter.

#### Removing Rust from Steel

A quick method of removing rust from steel parts, which is not generally known, is outlined in the following: Rub the surface of the piece of work from which rust is to be removed with muriatic acid. A convenient way to do this is to dip a match or other small stick into the acid and rub it over the surface of the work. This procedure is continued for several minutes, dipping the stick in as often as necessary to obtain a sufficient quantity of acid. After this treatment has been completed, the work should be washed with a solution of common washing soda and water and then dried in sawdust. This will leave the work free from rust and scratches, but with a dull gray surface. The surface of the metal can be restored to its original color by a little rubbing. In one factory this method has been used for several years with successful results.

#### Varnishing and Lacquering

Varnishing and lacquering, as being somewhat apart from the subject matter, will be treated very briefly. The method cannot be used to produce an artistic color effect, but is nearly always used for protecting the surfaces of instruments and machines from discoloration by atmospheric influence. In nearly every instance lacquering is used only on metal alloys. It might be well in this connection to note the discoloring tendencies of metals in alloys, as given by a noted German authority. The discoloring action upon metals takes place to the greatest extent upon tin and the least upon gold. In the following list of metals the action becomes less from the first to the last: 1. Tin; 2, nickel; 3, aluminum; 4, manganese; 5, iron; 6, copper; 7, zinc; 8, lead; 9, platinum; 10, silver; 11, gold.

## CHAPTER II

### COLORING IRON AND STEEL PRODUCTS

There are three ways in which to produce colors on metals, namely: First, by heat-treatment; second, by dipping in a bath; third, by electro-plating. Often two of these methods are used in combination. A fourth might be added, that of brushing or rubbing a powder, or liquid, onto the piece to be colored. This is so similar to the dipping process, however, that it can be classed under that head. None of these metal-coloring processes can be learned from a few receipts that may be printed. Metal coloring is in reality a trade in itself and must be learned.

Some of the solutions get weaker with use, and the last article treated will be of a different color from the first. Nearly all of the coloring materials have different effects on cast iron, wrought iron and malleable iron and will produce different shades, if not different colors. The chemical composition of the steels is so varied that no set of rules will apply to all steels. Likewise the preparation of the metal before coloring and the treatment given it after coloring must be changed to suit the kind of metal being colored. Hence it is necessary to know the metal that is being worked upon. It is always best to first experiment with a few pieces and see if uniform results are being obtained. It is a good rule not to treat miscellaneous steel pieces by the one coloring process, although some of the plating processes that deposit heavy coatings might be relied upon.

#### **Preparing Work for Coloring**

Preparing the work for the coloring operation is of the most vital importance. It is absolutely necessary to remove all grease, and the removal of all other foreign substances for the surfaces to be colored is of just as much importance. In fact, only the clean metal surface should present itself to the coloring materials, no matter what their nature may be. When all the layers of oxide, grease, dirt, etc., have been removed the entire exposed surface can be given a uniform color and a quantity of pieces will be the same shade if the other conditions are properly looked after.

#### **Rust-proof Black Finish**

When a rough surface, such as is presented by castings, forgings, etc., is to be given the rust-proof black finish, sand blasting is the quickest and cheapest method of cleaning the work. In this black finish the metal is oxidized and coated with black magnetic oxide of iron. One method of producing this is to heat the work to a red heat in a muffle furnace in the presence of steam and hydrogen gas. A small amount of gasoline, injected with the steam, improves the color. The

work should be subjected to red heat in the muffle for about an hour. If the work is given a thin coating of linseed oil after it has cooled off the color will be deepened and present a smoother appearance.

This coating is quite hard and not easily worn away, and is a dead black. It is free from the red oxide that has spoiled so much work of this kind. The hydrogen gas is generated by passing steam over red hot iron chips or turnings. Cast iron, malleable iron and steel may all be given this black finish. The principle on which it is based is that of giving the surface all the oxide it will take up so that the oxygen in the air cannot reach it and cause corrosion. Tests have shown it to resist this action for many years and the color to be preserved.

#### **Black Oil Finish**

Black oil finish is produced by heating the work to a bright red; then quenching it in lard oil, afterward putting it back in the furnace to burn the oil off, and then quenching it in water. The oil must be kept cool and the water clean. A thin coat of linseed oil applied to the black gives the same results as described above. This coating is not durable but it will prevent rusting until the goods are sold, and is useful for such tools as can be heat-treated in the same operation.

#### **Gun-metal Finish**

Gun-metal finish is based on the same fundamental principle as the black finishes described above but is a great improvement over them and applicable to a finer class of work. For this work, as well as for the browns, blues or other fine colors that are produced on polished surfaces, the pieces must be cleaned by methods that will not injure these surfaces, as does the sand blast.

Grease and dirt are readily removed by boiling the work in a solution of one pound of potash to one gallon of water. This turns the grease to soap, which is absorbed by the water, and the dirt falls off from the work. The potash will last a long time and the water can be replenished as it boils away. When exhausted, the bath can be renewed by adding fresh potash. On small work, or a few pieces, stirring about in benzine or paraffine will remove the grease and dirt. If used continuously three vessels should be provided. In the first the bulk of the grease would be cut from the work; in the second the balance of it would be cleaned off; and the third should be kept clean to remove any particles that might still remain. The first two could contain paraffine and the third benzine.

After this cleaning the pieces should be washed with clean water and thoroughly dried. If boiling water is used they will dry in the air; if cold water is used clean sawdust is effective for drying them. The work should never be touched with the bare hands as the fingers are likely to leave grease marks.

#### **Pickling preparatory to Coloring**

Scale, oxide, etc., are not removed by the above washing methods and hence a pickling in acid solutions is required. One part of sul-

phuric acid to twenty parts of water is often used for iron. This mixture leaves the work dark colored and sometimes it has a different appearance at the edges. To make the work bright, the following pickling solution should be used: Dissolve two ounces of zinc in one pound of sulphuric acid and mix this with one gallon of water; then add one-half pound of nitric acid. The volume of the bath should be twenty times that of the work, to prevent it from becoming weakened too soon. The glassy patches on cast iron, which are usually iron silicate, can be removed by hydrofluoric acid.

After pickling, the solution should be thoroughly washed off and the work brushed with steel scratch brushes revolving at from 600 to 1000 R. P. M. Cleaned work can be protected from rusting by keeping it immersed in water containing some caustic alkali until it is needed. Caustic soda and sodium carbonate are both effective for this purpose.

Polished steel surfaces can be pickled by immersing them, in contact with a piece of clean zinc, in a moderately strong solution of the acid potassium sulphate and water. Hydrogen gas is liberated when the zinc decomposes the solution and this removes the oxide of iron or rust from the steel. Another good pickling solution for steel is made of twenty parts hydrochloric acid and eighty parts water. Iron and steel can also be pickled white, in concentrated nitric acid to which has been added some lampblack. After pickling, the work should always be thoroughly washed and scratch brushed.

#### Other Gun-metal Receipts and Methods

Several different chemical solutions have been used successfully in giving steel the gun-metal finish or black color. Among these are the following: Bismuth chloride one part, copper chloride one part, mercury chloride two parts, hydrochloric acid six parts and water fifty parts. Ferric chloride one part, alcohol eight parts and water eight parts. Copper sulphate two parts, hydrochloric acid three parts, nitric acid seven parts and perchloride of iron eighty-eight parts. Other solutions have been prepared from nitric ether, nitric acid, copper sulphate, iron chloride, alcohol and water, and from nitric acid, copper sulphate, iron chloride and water.

Applying these and finishing the work is practically the same in all cases. The surface of the work is given a very thin coating with a soft brush or sponge that has been well squeezed, and is then allowed to dry. If put on too thick the surface will be unevenly corroded and white spots will appear. The work is then put into a closed retort to which steam is admitted and maintained at a temperature of about 100 degrees F. until covered with a slight rust. It is then boiled in clean water for about fifteen minutes and allowed to dry. A coating of black oxide will cover the surface, and this is scratch brushed. After brushing, the surface will show a grayish black. By repeating the sponging, steaming and brushing operation several times a shiny black surface will be obtained that is lasting. For the best finishes these operations are repeated as many as eight times.

Another process employs a solution of mercury chloride and ammonium chloride which is applied to the work three times and dried each time; a solution of copper sulphate, ferric chloride, nitric acid, alcohol and water is then applied three times and dried as before; a third solution of ferrous chloride, nitric acid and water, is applied three times and the work boiled in clean water and dried each time; the third and last solution of potassium chloride is then applied and the work boiled and dried three times. The work is then scratch brushed and given a thin coating of oil. Ordnance for the French Government was treated in this way.

The above methods are useful for hardened and tempered steels, as they are only heated to about 100 degrees F. and this temperature does not draw the hardness. For steels that will stand 600 degrees temperature without losing the desired hardness, better and much cheaper methods have been devised.

The color does not form a coating on the outside, as with the other processes, but a thin layer of the metal itself is turned to the proper color, which should make the color wear well. By varying the temperature of the furnace, the time the work is in it, and the chemical, different colors can be produced from the light straws to the browns, blues, purples and black, or gun-metal finish. Rough or sand-blasted surfaces will have a frosted appearance, while smooth, polished surfaces will have a shiny brilliant appearance.

A variety of colors can be produced on iron and steel by immersing the pieces, for different lengths of time, in a boiling hot solution of the following composition: Lead acetate fifty grains, sodium thiosulphate fifty grains, water five fluid ounces. A half-hour immersion will make the work black and a shorter time will make it steel-gray, blue, mixed purple and blue, purple, dark brown and light brown. By controlling the time, the desired color can be obtained. These colors are very beautiful but fade quickly. A coat of lacquer on top of the color, however, will preserve them for years. On top of a nickel plating these colors are exceptionally brilliant.

#### Coloring Steel by Heat

Producing colors on steel by heat-treatment is almost too well known to comment on here, and has already been referred to in the previous chapter. Suffice it to say that 430 degrees F. produces a faint yellow, 460 degrees dark yellow, 490 degrees light brown, 500 degrees dark brown, 520 degrees light purple, 540 degrees dark purple, 560 degrees light blue, 580 degrees dark blue, 600 degrees blue green and 620 degrees black. By mixing potassium nitrate and sodium nitrate in an iron pot and melting them, the bath can be maintained at any of these temperatures. By immersing the work in this bath until it absorbs its temperature and then cooling it, any of these colors can be obtained. The work can be cooled by plunging it into boiling water and the coating of salt removed at the same time. A thin coating of these salts sticks to the steel and prevents the oxygen in the

air from attacking the metal and altering the color while it is being transferred from the nitrate bath to the boiling water. The contained heat will dry the work when removed from the water.

#### Browning Iron and Steel

A good brown color can be obtained as follows: Coat the steel with ammonia; dry it in a warm place; then coat with muriatic or nitric acid; dry in a warm place; then place in a solution of tannin or gallic acid; and again dry. The color can be deepened by placing the work near the fire, but it should be withdrawn the minute the desired shade is reached or it will turn black.

The U. S. Government adopted the following formula for browning gun barrels: Alcohol three ounces, tincture of iron three ounces, corrosive sublimate three ounces, sweet spirits of niter three ounces, blue vitriol two ounces, nitric acid one and a half ounce and warm water two quarts. The solution is applied with a sponge, allowed to dry for twenty-four hours, and after this the loose rust is removed by scratch brushing. A second coat is given in the same manner. After that the piece is boiled in water and dried quickly. A thin coat of boiled linseed oil or lacquer is then put on to preserve the color.

Another process for browning iron and steel consists of dissolving four ounces of copper sulphate in two quarts of water and then adding one ounce of nitric acid, one ounce of spirits of niter, two ounces of alcohol and one ounce of ferric chloride. Scratch brushing and rubbing with a piece of smooth hard wood will polish and burnish the work and a coat of shellac or lacquer will preserve the color. Rubbing with the polishing wood will give the lacquer or shellac a polished surface.

A solution that may be used in place of the above is spirits of niter one ounce, copper sulphate one ounce and water twenty ounces. This must be allowed to remain on the work for twenty-four hours and then brushed off with a stiff brush. The operations can be repeated enough times to get the depth of color desired.

#### To Produce Bronze-like Color

A warm bronze-like color can be produced by exposing iron or steel to the vapors of heated aqua regia, dipping them in melted vaseline, then heating until the vaseline begins to decompose and wiping it off with a soft cloth.

Another method of producing this bronze-brown color is to slightly heat the work, cover the surfaces evenly with a paste of antimony chloride, known as "bronzing salt," and let it stand until the desired color is reached. It can be made more active by adding a little nitric acid.

Still another bronzing process consists of soaking the work for some time in an acid solution of ferric chloride, then vigorously moving it about in hot water and allowing it to dry, and finally brushing with a waxed brush. The oxygen, liberated by the decomposition of the water, combines with the iron and forms a dark layer of oxide.

#### To Produce Gray Color

A gray color can be obtained by immersing the work in a heated solution of ten grains of antimony chloride, ten grains of gallic acid, 400 grains of ferric chloride and five fluid ounces of water. This is doubtless due to the antimony. The first color to appear is pale blue and this passes through the darker blues to the purple and finally to the gray. Thus if immersed long enough the metal will assume the gray color, but if not any of the intermediate colors may be produced. Used cold it is also one of the bronzing solutions.

#### The Niter Process for Bluing Iron and Steel

This process was first brought to the notice of the public in a paper read before the American Society of Mechanical Engineers, by Mr. William H. Weightman in 1886. This method produces a beautiful color and may, therefore, be of general interest. The process is very simple, the niter (nitrate of potash, often called saltpeter) is melted in an iron pot and heated to about 600 degrees F. The articles to be blued are cleaned and polished and then immersed in the molten niter, in which they are allowed to remain until the desired color has been obtained in a uniform manner. Only a few seconds are required, or, in general, only the length of time necessary for the articles to arrive at the heat of the niter. The articles are then removed and allowed to cool, after which they are immersed in water and the adhering niter washed off. Articles which will not warp or twist may be immersed in water immediately after having been removed from the niter. After the cleaning process the articles are dried in sawdust and then oiled with suitable oil, such as linseed, to prevent them from rusting. If a uniform color is to be attained continuously, a pyrometer should be used to control the temperature of the heated niter, because a higher heat than 600 degrees F. will produce a dark color, while a lower heat will make the objects light.

The niter process can scarcely be called suitable for small articles on account of its cost. Niter itself is not expensive, but the pieces must be dipped carefully in order to obtain the desired color and the handling in washing them off afterwards and drying them makes the cost per piece high. It is, therefore, used mostly for medium-sized and large work.

#### Mottling

The mottled colors can be produced by heating the steel pieces to a good cherry red for several minutes in cyanide of potassium, then pouring the cyanide off and placing the pot of work back in the fire for five minutes and then quickly dumping the contents into clean water. To heighten the colors the work should afterward be well boiled in water and oiled while hot. This also carbonizes the work and larger lots could be handled in the regular carbonizing furnaces.

## CHAPTER III

### COLORING NON-FERROUS METALS AND ALLOYS

In thickly inhabited sections a great deal of coal gas is burned. More or less of the products of combustion, together with the gases arising from the manufacture of other materials, stay in the atmosphere and give to brass and bronze objects a dark, dirty color by attacking their surfaces. The oxygen and moisture in the atmosphere also give these metals or alloys a disagreeable color. Hence coloring or coating is also resorted to for the purpose of enhancing and preserving the original beauty of the metal. Sometimes rich and beautiful browns and greens are produced on copper alloys that have been subjected to atmospheric conditions for years. Therefore these conditions have been studied and chemical means have been found for producing the colors quickly and on a commercial scale.

Copper is more susceptible to coloring processes than any of the other metals, and hence the alloys containing large percentages of copper are readily given various shades of the yellow, brown, red, blue and purple colors and also black. Alloys with smaller percentages of copper, or none at all, can be given various colors, but not as easily as if copper were the principal ingredient, and the higher the copper content, the more readily can the alloy be colored. The shades, and even the colors, can be altered by varying the density of the solution, its temperature and the length of time the object is immersed. They can also be altered by finishing the work in different ways. If a cotton buff is used one shade will be produced; a scratch brush will produce another, etc. Thus to color work the same shade as that of a former lot all the data in connection with these operations must be preserved so they can be repeated with exactness.

Many different kinds of salts are made into solutions for the coloring processes. When capable of producing the desired results it is always best to use the simple salts. It is often necessary to combine two or more salts in the solution to get the required color, but these deteriorate in strength much more rapidly than the simple salt solutions and hence the last piece immersed will have a lighter color than the first one. When adding salts to bring back the original strength of the bath, they should first be dissolved in a small amount of water to prevent their settling to the bottom where they might become covered with an insoluble mud that would prevent them from being dissolved. In making the solutions it should be remembered that a strong solution will produce the color quickly and a weak solution more slowly. When a uniform coating can be produced the strong solution is always the best owing to the time factor. The most effective and lasting results, however, are obtained with the weaker



solutions, and hence they are used for high-grade work. While these solutions are often used cold, there are many cases where better results can be obtained when they are heated. Raising the bath to the boiling point will insure a complete solubility of the salt.

#### Cleaning Work to be Colored

Cleaning the work is of the utmost importance before attempting to give it any kind of color. A greenish or brownish film forms on copper, brass, bronze, etc., when they stand, as they are attacked by the moisture in the air and the simultaneous presence of carbonic acid which gradually changes into carbonates. This film is a mixture of carbonate of copper and oxide. Often sulphur compounds are formed when the atmosphere is impregnated with the products of combustion arising from the coal gas burned in cities and towns. This is nearly always stronger in rooms than in the open. If these films are not removed before coloring they show up as stains and the work will be streaked or spotted. Touching the work with the bare hands after it is cleaned will also leave a slight film that will make the work spotted, and hence it should be strung on wires or handled in other ways that will prevent it from being touched with the hands.

Several acid dips can be made that will remove these films and leave the bright clean metal with its original smooth surface. Work that will stand heating can be heated to a dull red and then plunged into dilute sulphuric acid, after which it should be soaked in old aquafortis and then thoroughly rinsed. It should be soaked long enough to have a uniform metallic appearance, and the bath should be large enough in volume to prevent its heating up from the hot work. The best results are obtained with straw-colored aquafortis, as the white is too weak and the red too strong. In diluting the sulphuric acid it should always be poured into the water slowly, as heat is generated, and too rapid mixing generates so much heat that the containing vessel is liable to crack and the escaping liquid to cause burns. To pour water into sulphuric acid will cause an explosion that is almost sure to result in serious, if not fatal, burns from the flying liquid.

A good method of removing these films, without heat, is to soak the work in a pickle composed of spent aquafortis until a black scale is formed and then dip it for a few minutes into a solution composed of 64 parts water, 64 parts commercial sulphuric acid, 32 parts aquafortis and 1 part hydrochloric acid. After that the work should be thoroughly rinsed several times with distilled water. If the strong aquafortis is used for the pickle in which the work is soaked it will cause a too rapid corrosion of the copper during the time of the solution of the protoxide. Hence the spent aquafortis is better on account of its slower action and it also saves the cost of new. A dip that is useful for removing the sand, etc., that sticks to castings is composed of 1 part spent aquafortis, 2 parts water and 6 parts hydrochloric acid. A few minutes will suffice for small pieces, but

large castings can remain in the bath for thirty minutes. They become coated with a black mud and when this is thoroughly washed off they should be bright.

If a further whitening of the work is desired a solution may be made by mixing 3 pounds nitric acid, 4 pounds sulphuric acid and 40 grains sodium chloride (table salt), combining this with 40 times its bulk of water and allowing it to cool before using. If a dead surface is desired the following mixture can be added to the bath: 2 pounds nitric acid, 1 pound sulphuric acid, 10 grains sodium chloride and 40 grains zinc sulphate. The degree of deadness is determined by the length of time the work is left in the bath. As with all other solutions, the work should be well rinsed after leaving the bath and then thoroughly dried. Another dead dipping bath can be made from one part of a concentrated solution of potassium bichromate and two parts of concentrated hydrochloric acid. Many other combinations of chemicals may also be made for cleaning or whitening the work or giving a dead finish after it has been colored, but those given above will suffice for the present.

#### Bright Castings

The bright clean color sometimes seen on bronze castings has been thought by many to be the result of an acid dip. This has been produced, however, by plunging the castings into water while they are still red-hot. It is seldom that brass castings can be given this color as they usually contain too much lead. Likewise the bronze castings must be free from lead as well as iron, antimony or other impurities, and the water into which they are plunged must be clean, or a dirty, unpleasant color will be the result. The castings must also be as hot as possible when quenched. If too hot the metal will be brittle and hence the highness of the temperature is governed by the toughness that is desired in the casting, but if quenched after they have cooled too much the color will be dull. Copper ingots can be given a beautiful rose-red color by this method.

#### To Produce Yellow to Orange Colors

Polished brass pieces can be given a color from a golden yellow to an orange, by immersing them for the correct length of time in a solution composed of 5 parts caustic soda to 50 parts water, by weight, and 10 parts copper carbonate. When the desired shade is reached the work must be well washed with water and dried in sawdust. Golden yellow may be produced with the following: Dissolve 100 grains lead acetate in 1 pint water and add a solution of sodium hydrate until the precipitate which first forms is redissolved, and then add 300 grains red potassium ferri-cyanide. With the solution at ordinary temperatures the work will assume a golden yellow, but heating the solution darkens the color until at 125 degrees F. it has changed to a brown. A pale copper color can be given brass by heating it over a charcoal fire, with no smoke, until it turns a blackish brown, then immersing in a solution of zinc chloride that is gently boiling, and

finally washing thoroughly in water. Dark yellow can be obtained by immersing for five minutes in a saturated solution of common salt containing some free hydrochloric acid and which has as much ammonium sulphide added as the solution will dissolve.

#### To Produce a Rich Gold Color

A rich gold color can be given brass by boiling it in a solution composed of 2 parts saltpeter, 1 part common salt, 1 part alum, 24 parts water, by weight, and 1 part hydrochloric acid. Another method is to apply to the work a mixture of 3 parts alum, 6 parts saltpeter, 3 parts sulphate of zinc and 3 parts common salt. The work is then heated over a hot plate until it becomes black and then washed with water, rubbed with vinegar and again washed and dried. Still another solution is made by dissolving 150 grains sodium thiosulphate in 300 grains water and adding 100 grains of an antimony chloride solution. After boiling for some time the red-colored precipitate must be filtered off, well washed with water and added to 4 pints of hot water. Then add a saturated solution of sodium hydrate and heat until the precipitate is dissolved. Immerse the brass articles in the latter solution until they have attained the correct shade. If left in too long they will be given a gray color.

#### To Produce White Colors or Coatings

The white color or coating that is given to such brass articles as pins, hooks and eyes, buttons, etc., can be produced by dipping them in a solution that is made up as follows: Dissolve 2 ounces fine grain silver in nitric acid, then add 1 gallon distilled water and put into a strong solution of sodium chloride. The silver will precipitate in the form of chloride and this must be washed until all traces of acid are removed. Testing the last rinse water with litmus paper will show when the acid has disappeared. Then mix this chloride of silver with an equal amount of potassium bitartrate (cream of tartar) and add enough water to give it the consistency of cream. The work is then immersed in this and stirred around until properly coated, after which it is rinsed in hot water and dried in sawdust.

#### Silvering

Another method of silvering that is applicable to such work as gage or clock dials, etc., consists of grinding together in a mortar 1 ounce very dry chloride of silver, 2 ounces cream of tartar and 3 ounces common salt. Then add enough water to make it of the desired consistency and rub it on the work with a soft cloth. This will give brass or bronze surfaces a dead white thin silver coating, but it will tarnish and wear if not given a coat of lacquer. The ordinary silver lacquers that can be applied cold are the best. The mixture as it leaves the mortar, before adding the water, can be kept a long time if put in very dark colored bottles, but if left where it will be attacked by light it will decompose.

#### Assorted Colors

Some very interesting results in coloring brass can be obtained by dissolving 200 grains sodium thiosulphate and 200 grains lead acetate in 1 pint water and heating it to from 190 to 195 degrees F. Immersing the work in this for five seconds will make it pale gold; fifteen seconds, brown gold; twenty-five seconds, crimson; thirty seconds, purple; forty-five seconds, an iridescent bluish crimson green; sixty seconds, pale blue; sixty-five seconds, mottled purple; eighty seconds, nickel color; eighty-five seconds, mottled blue and pink; one hundred and ten seconds; mottled purple and yellow; two and one-half minutes, pale purple; four minutes, mottled pink and yellow; five minutes, mottled gray; ten minutes, mottled pink and light blue. Other combinations of colors can also be obtained, but some of these fade and change color unless protected by a coat of lacquer. By using one-quarter ounce of sulphuric acid in place of the lead acetate a variety of colors can also be produced, but they will not be as good a quality as those made with the above solution. Nitrate of iron can also be used.

#### To Produce Gray Colors

A solution of 1 ounce of arsenic chloride in 1 pint of water will produce a gray color on brass, but if the work is left in too long it will become black. The brass objects are left in the bath until they have assumed the correct shade and then are washed in clean warm water, dried in sawdust and finally in warm air. A dark gray color that can be made lighter by scratch brushing can be obtained by immersing the work in the following solution: 2 ounces white arsenic oxide, 4 ounces commercially pure (c. p.) hydrochloric acid, 1 ounce sulphuric acid and 24 ounces water. A steel gray can be produced with the following: 20 ounces arsenious oxide, 10 ounces powdered copper sulphate, 2 ounces ammonium chloride and 1 gallon hydrochloric acid. After mixing, this should stand for one day. A 5 per cent solution of platinum chloride in 95 per cent water will also produce a dark gray color if it is painted on and the brass is warmed. Weaker solutions will make the color lighter. Copper can also be colored, but the platinum does not adhere as firmly to the surface as it does on brass. A coating of lacquer is required to make it permanent. By smearing the work with a mixture of 1 part copper sulphate and 1 part zinc chloride in 2 parts water and drying this mixture on the brass, with heat, a dark brownish color is obtained. If desirous of immersing the work a weaker solution could be used. The color is changed very little by exposure to light.

#### To Produce Lilac Blue and Violet Colors

The lilac shades can be produced on yellow brass by immersing the work in the following solution when heated to between 160 and 180 degrees F. Thoroughly mix 1 ounce chloride, or butter, of antimony in 2 quarts muriatic acid, and then add 1 gallon water.

To give brass a blue color dissolve 1 ounce antimony chloride in 20 ounces water, and add 3 ounces hydrochloric acid. Then warm the

work and immerse it in this solution until the desired blue is obtained. After that, wash it in clean water and dry in sawdust. A permanent and beautiful blue-black can be obtained by using just enough water to dissolve 2 ounces copper sulphate and then adding enough ammonia to neutralize and make it slightly alkaline. The work must be heated before immersion. Copper nitrate, water and ammonia will also yield this rich blue-black, but if the brass is very highly heated after immersion it changes to a dull steely black. On copper or work that is copper-plated this latter produces a crimson color.

A beautiful violet color can be produced on polished brass with a mixture of two solutions. First, 4 ounces sodium hyposulphite is dissolved in 1 quart water, then 1 ounce sugar of lead is dissolved in another quart of water and the two are well stirred together. By heating this to 175 degrees F. and immersing the work the correct length of time, it takes on the violet color. The work first turns a golden yellow and this gradually turns to violet. If left a longer time the violet will turn to blue and then to green. Thus this same preparation can be used for all of these colors by correctly limiting the time that the work is immersed.

#### To Produce Green Colors

When left to the natural action of the atmosphere, or ageing, most of the brasses and bronzes first turn green, and very decidedly so if near the ocean where the moisture from the salt water attacks the metal. This green color gradually darkens and then turns brown and finally black. Some of the shades it assumes are very beautiful and hence they have been produced by chemical means, as nature is too slow in its action. So many different chemical combinations are used for this purpose that it would require a book to enumerate them all and hence only a few can be mentioned. Some of the green colors can be produced by the solutions given above, but the antique, or rust, greens require different mixtures.

One solution that will produce the verde antique, or rust green, is composed of 3 ounces crystallized chloride of iron, 1 pound ammonium chloride, 8 ounces verdigris, 10 ounces common salt, 4 ounces potassium bitartrate and 1 gallon water. If the objects to be colored are large, this can be put on with a brush and several applications may be required to give the desired depth of color. Small work should be immersed and the length of time it is immersed will govern the lightness or darkness of the color. After immersion, stippling the surface with a soft round brush, dampened with the solution, will give it the variegated appearance of the naturally aged brass or bronze. Another solution that will give practically the same results is composed of 2 ounces ammonium chloride, 2 ounces common salt, 4 ounces aqua-ammonia and 1 gallon water. The work may have to be immersed or painted several times to give it the desired coating, and after washing and drying it should be lacquered or waxed. The Flemish finish can be given brass with a solution composed of  $\frac{1}{4}$  ounce sulphuret of potassium, 1 to 2 ounces white arsenic, 1 quart muriatic acid and 10

gallons of water. The arsenic should be dissolved in a part of the acid by heating and then mixed with the balance of the acid and water. Two ounces sulphuret of potassium in a gallon of water may also be used if it is heated to 160 degrees F. One ounce sulphuric or muriatic acid in a gallon of water darkens the color produced by this last mixture.

#### To Produce Brown Colors

Many different shades of brown can be produced and many different chemicals are used to form solutions or pastes for this purpose. In these liver of sulphur, either potassium sulphide or sodium sulphide, is one of the most commonly used chemicals. One-fourth ounce liver of sulphur in 1 gallon water will give bronze a brown color when used cold but if heated it is more effective. The depth of the color is governed by the length of time that the work is immersed. If left in too long, however, it becomes black and if too much liver of sulphur is used the color will be black. Copper is turned black even with the weak solutions. To set the color it should afterwards be immersed in water containing a small amount of sulphuric or nitric acid. Brass is not attacked by this solution but if caustic potash is added it causes the liver of sulphur to color the brass. Then 2 ounces liver of sulphur should be added to 1 gallon water and from 2 to 8 ounces caustic potash, according to the shade of brown that is desired; the more potash the darker will be the color. A solution composed of  $\frac{1}{2}$  ounce potassium sulphide in 1 gallon of water will produce a gray or greenish color on brass when cold but when heated to 100 degrees F. it produces a light brown; at 120 degrees, a reddish brown; at 140 degrees, a dark brown; and at 180 degrees, a black color.

The barbedienne bronze, or brown, color can be produced on cast brass or bronze by immersing in a solution made by dissolving 2 ounces golden sulphuret of antimony and 8 ounces caustic soda in 1 gallon water. The work must be properly cleaned beforehand and afterwards scratch-brushed wet, with a little pumice stone applied when brushing. It must then be well washed and dried in sawdust. A second immersion in a solution of one-half the above strength will have a toning effect, and the work must again be washed and dried. The high light can be made to show relief by rubbing the object with pumice stone paste on a soft rag. A dead effect can be produced by immersing in a hot sulphuret of antimony solution for ten or fifteen seconds, then rewashing and immersing in hot water for a few seconds and drying in sawdust. The work should be lacquered to preserve the tones and waxed when the lacquer has become dry and hard. This brown color can be darkened by a five-seconds immersion in a cold solution of 8 ounces sulphate of copper in 1 gallon water. Some other processes use two solutions, the first of which is heated and the second used cold, after which the work is rinsed in boiling water.

#### To Produce Black

There are as many different processes and solutions for blackening brass as there are for browning, and consequently only a few can be

given. Trioxide of arsenic, white arsenic or arsenious acid are different names for the chemical that is most commonly used. Its use can be traced back to the fifth century and it is the cheapest chemical for producing black on brass, copper, nickel, German silver, etc. It has a tendency to fade and a much greater tendency if not properly applied, but a coat of lacquer will preserve it a long time. A good black can be produced by immersing work in a solution composed of 2 ounces white arsenic and 5 ounces cyanide of potassium in 1 gallon water. This should be boiled on a gas stove, in an enamel or agate vessel and used hot. Another cheap solution is composed of 8 ounces sugar of lead, 8 ounces hyposulphite of soda and 1 gallon water. This must also be used hot and the work afterwards lacquered to prevent fading. When immersed the brass first turns yellow, then blue and then black, the latter being a deposit of sulphide of lead.

The ammonia-copper carbonate solution much used for medals, ornaments, etc., is made by taking the desired quantity of the strongest ammonia water and mixing it with an equal amount of distilled water, and dissolving carbonate of copper in it until it is thoroughly saturated and a little remains undissolved. This is placed in a stone crock and surrounded with water and then heated to from 150 to 170 degrees F. before the work is immersed. After immersing for a few seconds the brass will turn black; it is then removed, rinsed in cold water, dried, and given a coat of dead, black lacquer.

#### "Heat-Black" Finish on Brass, Bronze and Copper

The so-called "heat-black" finish on brass, copper, or bronze is one of the new methods of coloring metals that has recently appeared and is one of the most durable. It is adapted for a large variety of work and is even replacing nickel-plated work for some kinds of articles. Desk telephone sets are now being finished in the "heat-black," and in many parts of the United States have supplanted the nickel-plated article previously used.

The adaptability of the "heat-black" finish is wide, and the reader will undoubtedly find many new uses for it. The color is an absolute dead black, and as it is not difficult to apply, the future will undoubtedly find it extensively employed. It can be applied to brass, bronze or copper. It does not work evenly on steel or iron.

The article to be treated should be free from grease, although a slight tarnish does no harm. It is usually customary to sand blast the surface, although very good results may be produced without it. A sand-blasted surface takes an excellent finish, but those who do not possess the apparatus for producing it need not have any hesitation in using the finish without it, as about the only difference between the results is that the sand-blasted surface is a little more dead.

Two stock solutions are first made up. One is a solution of nitrate of copper in water, and the other is a solution of nitrate of silver in water. The proportions need not be exact, although it is preferable to keep them fairly close. According to the *Brass World*, they are made up as follows:

**Nitrate of Copper Solution**

Water .....	1 oz.
Nitrate of copper.....	1 oz.

This gives a practically saturated solution of nitrate of copper in water and is used for a "stock" solution. If desired, the nitrate of copper may easily be made by taking 1 ounce of strong nitric acid and dissolving in it all the copper wire it will take up. A thick, blue solution is left which is used for the "stock" solution. As few platers have nitrate of copper in stock, it can easily be made from the copper wire.

**Nitrate of Silver Solution**

Water .....	1 oz.
Nitrate of silver.....	1 oz.

This solution can also be made by dissolving pure silver in nitric acid until no more will dissolve, but dilute acid (1 part acid and 1 part of water) should be used as silver does not dissolve readily in strong nitric acid. It is preferable, however, to purchase the nitrate of silver as it is easily obtained. The nitrate of silver solution is practically a saturated solution and is used as the "stock" solution.

**Mixed Solution for Applying**

The mixed solution for applying to the metal is made as follows:

Water .....	3 parts
Nitrate of copper solution.....	2 parts
Nitrate of silver solution.....	1 part

The solution is kept in a glass or stone-ware vessel for use.

**Applying to Brass or Other Metals**

The brass, bronze or copper article to be treated is heated on a hot iron plate or in an oven to a temperature of about 250 degrees F. and the solution applied with a brush or cotton swab so as to cover the surface uniformly. The brush should be a rather soft one in order to allow the coating to be made in the best manner. The so-called "rubber-set" brushes are the best for the purpose, as there is no metal on them to be attacked by the solution.

One or two coatings of the solution on the surface of the article is usually enough; it dries almost immediately leaving a green froth. The temperature is not sufficiently high to draw the temper of hard brass, but it will usually melt soft solder.

When the entire surface has changed to a uniform black color, allow the article to cool and then brush off the fluffy material on the surface of the metal with a stiff-bristled brush. The color will now change to a brownish-black that is quite pleasing for many purposes and which is very tenacious. When the fluffy material is completely brushed off, it is surprising how even and uniform the coating is and how tenaciously it adheres. If the brown-black finish is desired, the surface may now be waxed or lacquered, but it is usually customary to give



the article an additional treatment in a liver of sulphur solution in order to change the brown-black coating to one that is absolutely dead black.

#### Final Treatment

When the smut has been brushed off from the surface of the article, it is immersed in a cold liver of sulphur solution for 5 minutes. This solution is made by dissolving 2 ounces of liver of sulphur in 1 gallon of water. The article is immersed in it, allowed to remain about 5 minutes and then, without rinsing, is again heated until the surface is uniformly black.

The surface is now brushed again with the bristle brush when it will be found that the color is a dead black and quite uniform. It should be borne in mind that the article is not rinsed at all after it is removed from the liver of sulphur solution, but is simply drained off and then heated.

The article may now be lacquered with a flat lacquer or waxed as may be desired. The final appearance of the surface will be found quite satisfactory and contrary to what one would naturally expect. The coating of the solution that is first applied need not be very even as long as a sufficient quantity is put on.

The process as arranged by steps may be summed up as follows:

1. Applying the solution to the metal.
2. Heating on a hot plate or oven until the solution has dried and the residue left by evaporation has turned black.
3. Brushing off the smut.
4. Immersion for about 5 minutes in a liver of sulphur solution.
5. Drying without rinsing and heating on the plate or in the oven again.
6. Lacquering or waxing.

If the surface is not satisfactory, or an old article is to be refinished, the wax or lacquer may be burned off and the process repeated.

It is believed that this is one of the most satisfactory black finishes known, as it is dead black, is readily applied and is very durable. It is calculated to resist considerable handling, such as a desk telephone would receive. There are many articles that can well be treated by it.

#### Oxidizing

Solutions that produce the green, brown or black colors are usually used when it is desired to oxidize copper, brass or bronze. A dark slate green can be produced with a solution composed of 8 ounces double nickel salts, 8 ounces sodium hyposulphite and 1 gallon water. The color is almost instantly produced when the temperature of the solution is above 150 degrees F., but below the boiling point, and the articles immersed. After removing and rinsing in water the relief is easily produced with pumice stone or other abrasives. This green color harmonizes well with the metal color.

The browns and blacks are coated on the metal in the same manner as described under these headings; those solutions that are used hot give the best results, as the coating is more tenacious and better withstands the buffing that is necessary when oxidizing the work. Many beautiful effects are produced by these combinations of colors, and while it is not difficult to relieve the rough surfaces of cast, stamped or pressed articles it requires considerable skill to properly relieve turned or polished surfaces.

#### Mottling

After properly buffing and cleaning the work, a handsome mottled effect can be produced by first immersing it in a boiling solution composed of 8 ounces sulphate of copper, 2 ounces sal-ammoniac and 1 gallon water. This produces a light taffy color that soon changes to an olive green. The work should be removed when the taffy color appears and dipped in a second solution composed of 4 ounces sal-soda in 1 gallon water and that has the surface covered with a small amount of lard oil or gasoline. After that the work is again immersed in the first solution until the olive-green color is produced. The oil spreads over the surface and prevents the uniform action of the first solution, and hence the taffy and olive-green colors are mottled together with a pleasing effect. The same process might be used with different chemical solutions to mottle work with other combinations of colors.

#### Coloring Aluminum

Aluminum is the most difficult of metals to color. Heretofore aluminum parts have only been colored by coating them with lacquers of different colors, but a process has recently been patented by Salamon Axelrod in Germany that produces different metallic colors. Either a neutral or alkaline cobaltous nitrate is made into a water solution into which the articles are dipped, or it may be painted on pieces too large to dip. After that the work is heated and the degree of heat determines the color. A low temperature produces a steel gray color that changes to brown with a higher heat and to a durable and permanent dead black when the temperature is still higher. Zinc, tin and other white metals may also be colored with similar cobalt salt solutions.

The gun-metal finish can be given aluminum by immersing it for from six to ten seconds in a cold solution of 12 parts hydrochloric acid, 1 part chloride of antimony and 87 parts distilled water. After that, thoroughly wash it in running water for several minutes, dry with heat and lightly buff with a high-speed wheel. The color penetrates the metal and its depth is governed by the length of time it is immersed. If immersed longer than ten seconds the solution should be weakened, as hydrochloric acid eats the metal.

Nearly any color can be plated on any of the metals or alloys by electro deposition, but this is an art or trade that requires experienced platers. Electrochroma is the name given a new plating process that promises to revolutionize the older methods of plating on

colors. It produces any desired shade of green, blue, red, violet or yellow and black and white by immersion in the electrolyte for from one-half minute to two minutes. The work is made the cathode. One of its special features is the coloring of leaded glass. The lead can be given any desired color, while the glass is not affected but is left clean and with a clear luster. Heretofore the lead has been painted by hand, which is a long, tedious job, often consuming a day or more for one piece. It is also easy to match colors with this plating process and they are permanent enough not to require lacquering or waxing. The plating processes, however, are separate and distinct from those given above, as these do not require an electric current nor the high degree of knowledge and skill that goes with the plater's profession.

## CHAPTER IV

### LATHE BURNISHING OF METALS

The burnishing of metals while not requiring the skill of the spinner, or the multiple operations or tools used in that craft, still is a trade that is separate and distinct from spinning. Metal burnishing can be divided into three classes:

1. Hand burnishing of irregular shapes, such as tableware, jewelry, belt buckles, metal clocks, ornaments and all metal parts that cannot be revolved on the lathe, using steel hand tools of various shapes.

2. The burnishing of small round work in the lathe, such as buttons, ornaments, etc.—mostly plated ware that has already been surfaced and is operated on to brighten only—not requiring the heavy pressure of the tool, and being mostly done with blood-stone burnishers, a natural stone of small size mounted in a steel holder. These stones, some of which are very expensive, last for years.

3. The burnishing of unfinished or rough work in the lathe, which requires smoothing and polishing at the same time; this requires considerable pressure. The blood-stone burnisher would be ruined on this class of work. The tools used are of steel and the handles are short; they are held in the hand only. A strong wrist and muscular arm are required for burnishing, as well as a steady feed of the tool, which is partly accomplished by the movement of the body, in conjunction with the arm and wrist motion; the hand is steadied by being held against the body.

Burnishing may be described as an economical way to finish, polish or brighten the surface of metal, without wasting any of the material. It is also a means of strengthening the metal by tempering or harden-

ing it; this is accomplished by pushing the tool over the work, beginning at the front end and pushing always against the chuck. The toolpost is used as a fulcrum and the tool, which is pressed against the work, as a lever. The tool is given a slight rotary motion, and only the thin edge or end is used.

While the pressure against the work does not seem great, still the area in contact with metal is so small, and the speed of the lathe so high, being from 3200 to 5000 revolutions per minute, that the tool leaves a bright mark. The skill of the operator lies in passing the tool over the metal so as to leave a continuous bright surface without



Fig. 1. View showing Method of Moistening Work with Finger Pads and also Position and Angle of Burnishing Tool

any trace of the tool marks; to do this the tool must be fed with regularity and without overlapping or leaving any dull places.

After sheet metal is spun, or drawn in presses, the smooth, even surface which it has when it comes from the mills is changed to a rough, uneven surface having high and low spots which are hardly noticeable to the naked eye, but very easily distinguished under the magnifying glass. The working operations distend or elongate the molecules, and the annealing operation restores them to their original shape. Some shells are annealed several times before the burnishing operation is reached, besides being pickled after each annealing to remove the scale; this leaves the surface of the metal in a pebbly or matted condition, as well as soft and without temper.

A spun shell can be gone over with a planisher, and hardened, but the scale and dirt is crowded into the grain of the metal, and the only way to get a smooth surface is to buff or cut it down until this pitted face is removed thus wasting about 10 per cent of the metal.

The spinner can do this in another way, that is by skimming or shaving the uneven surface, but even more metal is wasted than by buffing, and the shell is also weakened by gouging the high places. This same shell could be left without polish, and the chuck transferred to the burnishing lathe, which runs at much greater speed than one used for spinning. After the shell is dipped bright to remove all spinning dirt and scale, it can then be polished to an even surface, the uneven face of the metal being amalgamated or smoothed down to a bright surface of the proper temper; it is then colored with a cloth buff to obtain a perfect finish. The gage or thickness remains the same as there is no dirt or scale to buff out.

Burnishing is economical, especially on pressed or drawn work made in large quantities, some work being finished at the rate of five

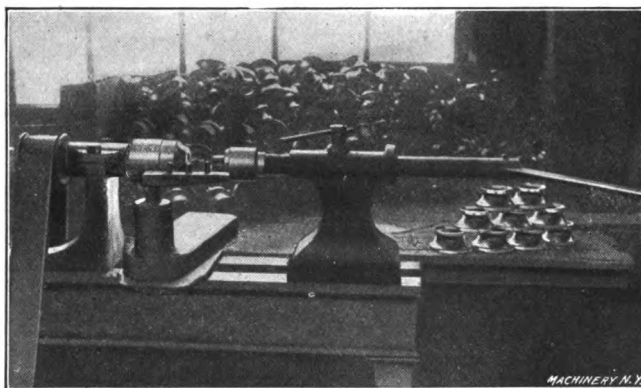

Fig. 2. Burnishing Lathe Equipped with Split Chuck

hundred or more an hour. It is necessary to have a metal chuck in burnishing, and where the shell has been spun on such a chuck, the latter can be used for both operations. Some work can be lacquered without coloring on the buff wheel, the only operation after burnishing being to wash in hot water and dry at once in hot sawdust.

A burnishing lathe is smaller than a spinning lathe, and it has only one speed. The countershaft is fastened to the floor under the lathe; this is necessary on account of the great speed, besides a down-pull of the driving belt causes less vibration than the up-pull of a belt from an overhead countershaft. The speed of burnishing lathes is varied for different classes of work. In a group of four lathes in use in one factory one is belted to run at 5000 revolutions, two at 4000 revolutions and one at 3200 revolutions a minute. Lathes for very large work of 12 inches and over in diameter have straight babbitted bearings, with a back screw and button to take up the end shake. The babbitt has to be renewed about once a year for continuous service, only the best grade being used. All threads on the spindles are of one standard size, the chucks being interchangeable for the burnishing and spinning lathes.

In some shops it is customary to have a small stream of water running on the work above the chuck, the connections being hinged, so that the stream can be guided above the tool. A back center is used to hold the work against the chuck. The operator wears a rubber apron to protect himself from the flying water, and stands in a shallow trough that has a drain. The great speed of the lathe throws off all surplus water, leaving only a thin film next to the metal—all that is necessary.

This chapter describes a method of burnishing that is used in many shops. The shells are first dipped in a tank of water, which is on the bench back of the lathe head; they are then held on the chuck by the left hand, the thumb and first three fingers being covered with canvas pads. These pads are dipped in the water and are held opposite the burnishing tool and slightly in advance of it to keep the metal moist,

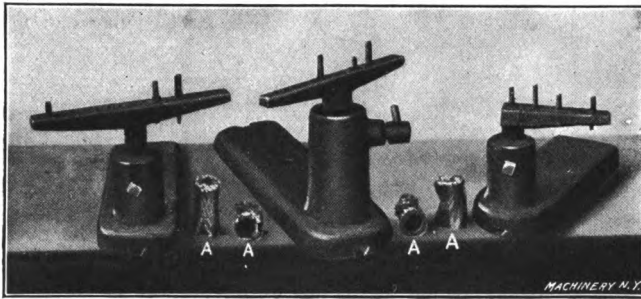

Fig\* 3. Burnishing Lathe Steady-rests and Finger Pads

thus leaving no surplus of water to be thrown off. The hand also holds the work against the chuck instead of the back center. Sometimes on large work it is necessary to dip the pads in the water a second time; also where a very fine polish is wanted it is necessary to pass the tool over the work twice, roughing it down on the first pass and finishing it on the second, using the same tool without taking it off the chuck.

Fig. 1 shows the method of using the pads on the fingers and also the proper position and angle of the tool, as well as the height of tool-post or rest. The chuck shown is  $8\frac{1}{2}$  inches in diameter and weighs 36 pounds; it runs at 4000 revolutions per minute. The shell has been gone over twice.

Fig. 2 shows a burnishing lathe equipped with a split chuck, one part being in the tail-spindle and having a roller end bearing. All chucks for burnishing are like the spinning chucks, except that greater care must be taken in machining them to have them perfectly balanced.

Fig. 3 is a view of the steady-rests that are used on burnishing lathes. These are different from the spinning rests, for while the spinner uses only one pin as a fulcrum, changing it from one hole to

another as the work advances, the burnisher uses several pins of much smaller size, inserting as many pins as he needs positions for the sweep of his tool. These pins are about  $\frac{1}{4}$  inch to  $\frac{9}{32}$  inch in diameter and are tapered  $2\frac{1}{2}$  degrees on the end which is inserted in the cross-bar of the steady-rest, the holes also being tapered and the pins driven in tight. The canvas finger cots that are used on the left hand to moisten the work are shown at *A*.

Fig. 4 shows a group of burnishing tools, some of which are of high speed steel, and others of regular tool steel. These tools are made extremely hard and no temper is drawn. They project out of the handles from  $2\frac{1}{2}$  to 5 inches and are  $\frac{3}{8}$ ,  $\frac{7}{16}$ ,  $\frac{1}{2}$ , and  $\frac{5}{8}$  inch in

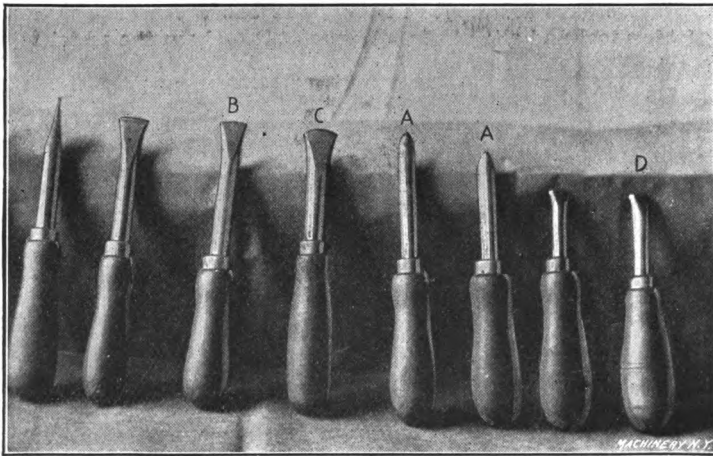

Fig. 4. Group of Tools used for Burnishing

diameter. The round tools *A* are used on heavy work; also to get in sharp corners and to burnish shells which are part plain and part embossed, requiring the tool to be lifted from one part of the work to another to avoid the embossed area. *B* is a flat tool with a slight curve on the end; it is used mostly on straight work and convex surfaces. *C* is a flat tool with a greater curve on the end, and it is used mostly on concave surfaces, while *D* is a flat tool with a still greater curve on the end, for use on small curved work, such as that shown in Fig. 5. These tools have to be polished when they become coated with metal, the interval between polishings depending on the texture of the metal worked and its temper, a shell that has been annealed several times coating the tool more than one that has not. It is a quick operation to polish the end of a burnisher. A board of soft wood or a strip of leather fastened to a board and to the bench, in a position convenient to the operator, is used. Grooves are worn into the leather or board, and flour of emery and oil, or flint flour and water is used to clean the tools, a few passes of a tool being all that is necessary to polish it.

Fig. 5 shows samples of burnished work; some of these are spun but most of them are drawn in presses. The bright dip which is used to clean work before burnishing is composed of: Oil vitriol (sulphuric acid), 2 parts; aqua fortis (nitric acid), 1 part. This solution should be kept in a crock set in a tank of running water, and mixed 7 or 8 hours before using, as the acids when combined heat up. It is best to mix the acids the day before using. In dipping brass, copper and German silver, the parts are strung on a wire whenever possible. If there are no holes in the metal that can be used for stringing, they can be put in a metal or crock basket, but they cannot be handled to good advantage as it is very difficult to thoroughly wash and dip them. After stringing the work on a stiff brass or copper wire, it should be washed in boiling potash, and then dipped in cold water to clean the potash off and cool the metal.

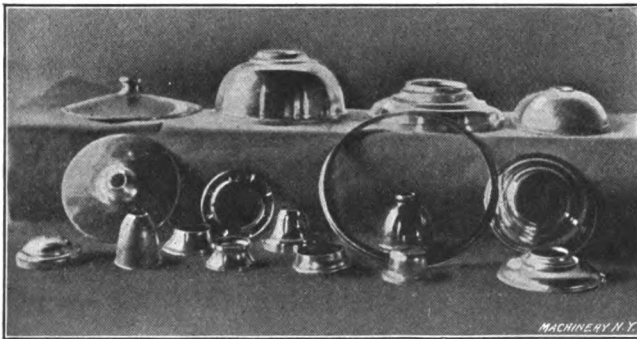

Fig. 5. Samples of Burnished Work

After cooling in the water, they are dipped for a few seconds in the acids, keeping the work constantly in motion, so that the surfaces will be all exposed equally; they are then shaken thoroughly above the acid and immediately washed in two separate cold-water baths, then in hot soap water, and then in hot water, after which they are dried at once in hot sawdust. This operation will leave a bright, clean surface free from acid.

Common yellow soap, dissolved to thick paste, is used as a lubricant when burnishing brass. The shells and the finger pads are dipped in clear water, and the tool is dipped in the soap paste before burnishing each shell.

A lubricant for copper is made by dissolving about one ounce of ivory or castile soap in a gallon of water. The shells and pads are dipped in this solution, no lubricant being used on the tool. Yellow soap should not be used on copper, as the action of the rosin on copper is different from that on brass, the metal being so glazed or greased that the tool works badly.

For copper plate on steel, such as copperized steel oilers, etc., about one-half ounce oil vitriol to four gallons of water should be used. The burnishing tool should be dipped in a mixture of mutton tallow that



has been melted with 5 per cent of beeswax, and the work and the finger pads should be dipped in the acid mixture. The tool is lubricated in the tallow mixture before burnishing each shell.

For German silver, the shell should be dipped in clear water, the finger pads in sour beer, and the tool in yellow soap paste.

For white metal or Britannia, use ivory or castile soap in the paste form for the tool, and sour beer or ox gall in water (4 ounces to the gallon) for the finger pads. Wash the work in hot alkali water (a spoonful of cream of tartar, saleratus or soda to a pail of water), and dry in hot sawdust.

For burnishing work which is to be lacquered, without coloring on the cloth buff, use thin glue for a lubricant, and also on the finger pads. When the part is burnished put it in saleratus water to keep it from tarnishing; then wash in hot water and dry in hot sawdust. Most plated work can be burnished with the sour beer mixture for the finger pads, and castile or ivory soap paste for the tool lubricant.

## CHAPTER V

### THE BALL-BURNISHING PROCESS

Burnishing, as used in the ordinary sense of the word, consists in finishing exterior surfaces of work by rubbing with a highly polished steel hand tool, which hardens and polishes the surface metal. The Abbott ball-burnishing process produces the same effect, but in an entirely different manner, employing quantities of hardened and polished steel balls which are caused to roll over the work while under

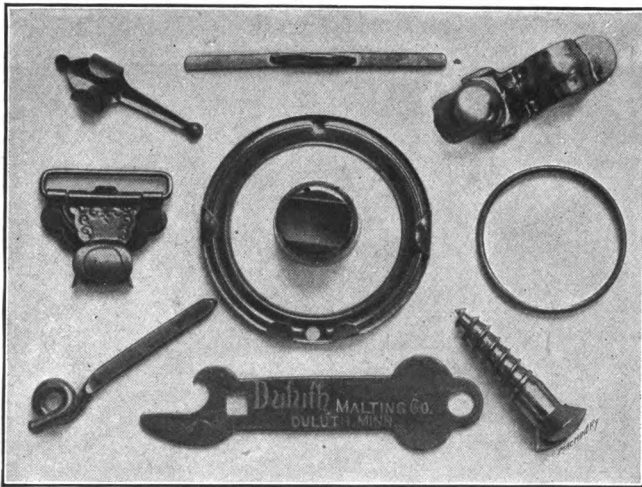

Fig. 1. Character of Work finished by Abbott Ball-burnishing Process

pressure. This pressure is effected by the weight of the balls which are confined within a tumbling barrel like that shown in Fig. 2. Thus, each ball acts as an individual burnishing tool, and as it rolls over the work, pressed by the mass of balls and work above, it leaves a burnished path on the work. Fig. 1 shows some representative burnishing jobs which have been efficiently handled by this process. Some idea of the action which takes place within the tumbling barrel may be gathered by noticing the balls and work which are represented in Fig. 3.

Fig. 4 shows the general form of the ordinary tumbling barrel as contrasted with the Abbott burnishing barrel. From this it will be seen that in the Abbott barrel, the balls are confined in a deep narrow space so that the same amount of balls being restricted within a narrower space exert a heavier burnishing pressure upon the work. The Abbott ball-burnishing process cannot be used when any metal is to

be removed or deep scratches are to be taken out. It is purely and simply a burnishing process for putting a high finish upon the work, and on work within its limitations is highly successful. Not only can a large amount of work be done in a short space of time, and in a very efficient manner, but many jobs which cannot be burnished by hand are efficiently finished by this process. Referring to Fig. 3 again, it will be seen that it is a simple matter for the balls to burnish the inside of a tube, the center of a deep depression, or the inside of a wire loop as shown in Fig. 1. Such pieces as these would be difficult to burnish in any other way. In order to burnish corners and depressions, it is necessary to employ balls small enough to come in contact with the surfaces of such places; therefore, on other than the very plainest of work, two sizes of balls are commonly used as shown in Fig. 3. Again, on work which is lettered, ordinary polishing processes "drag" the letters, but with the ball-burnishing process this trouble is not experienced.

The balls used for this work are made of low carbon steel, by the heading process, carbonized and hardened clear through and then highly polished. The

balls are not truly spherical, nor of an exact size, but they are highly finished and very hard. The barrels may be of the single or multiple type, having one or more compartments. The barrel shown in Fig. 7 has two sections, and gives a general idea of the construction. The compartments are octagonal in shape and are lined with maple wood so that the balls and work do not come in contact with any metal during the burnishing process. Two hand-holes are provided for each compartment with covers which may be clamped in place. The two hand-holes furnish a means for quickly removing the contents and washing out the barrel. A lubricant is employed in burnishing, which ordinarily consists of soapy water.

To burnish a quantity of work, the work and balls are placed in the barrel in the proportion of one peck of work to two pecks of steel balls. Water is then added until it stands about one inch above the contents of the barrel. In this water, about four ounces of burnishing soap chips have previously been dissolved. The hand-hole covers are then clamped in place, and the mixture tumbled from one to five hours,

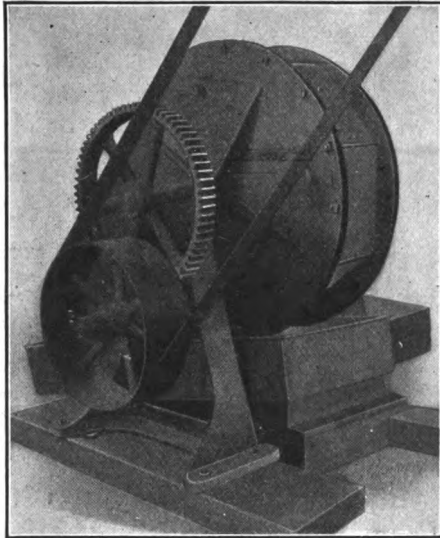

Fig. 2. Type of Burnishing Barrel used

depending upon the character of the work, metal, etc. The speed ordinarily employed for tumbling ranges from 10 to 30 R. P. M., the usual speed being 15 R. P. M. If after tumbling the work has a dull or smutty appearance, the soap solution should be drained from the work and clean water substituted, to which should be added a piece of cyanide of potassium about the size of a pea. It is highly important that the balls be kept from rusting, for rust, of course, destroys their burnishing qualities. The balls are easily kept in good condition by returning them to the barrel with the soap solution on them, but in no event should they be washed in clear water and allowed to stand.

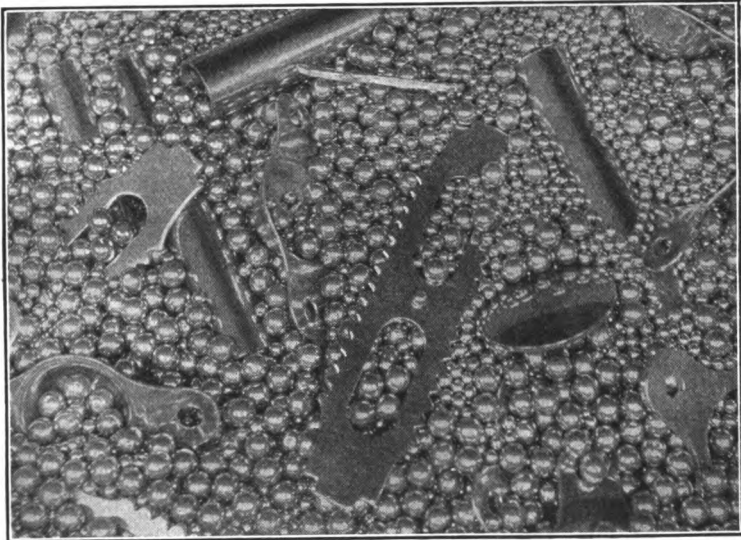

Fig. 8. View within the Barrel to show Burnishing Action of the Balls

The burnishing operation is the same on all kinds of metal. After the work has been burnished sufficiently, it is separated from the balls by dumping the mixture into a screen of sufficiently coarse mesh to allow the balls to drop through. A convenient arrangement to use for separating the balls from the work is shown in the illustration Fig. 5.

If the work is not to be plated, it is taken from the barrel and dried in sawdust, but if to be plated, it is cleansed in the usual manner and plated. The cleaning operation incident to plating is usually very troublesome on account of the rouge that is driven into corners of the work by the polishing wheels. No such trouble is experienced after ball-burnishing, as no rouge is used. It is only necessary to rinse off the soap solution, dip in potash and plate. After plating, the work is returned to the barrel and tumbled in a soap solution for a half hour to impart a high finish.

While most commonly used for small work, say under three inches in greatest dimension, larger work may be handled by a modification

of the process. The difficulty in burnishing large work is due to the fact that the weight of the piece is often great enough to injure other

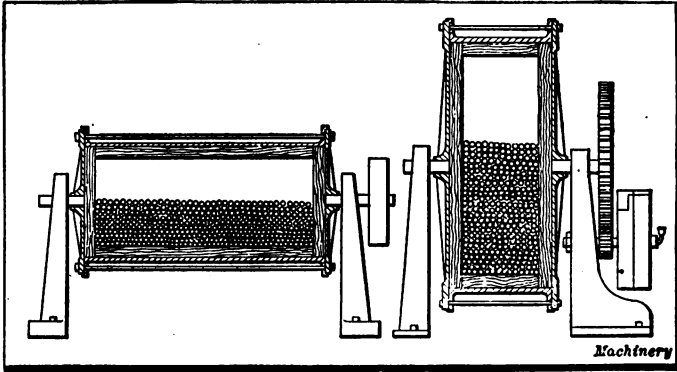

Fig. 4. Comparison of Old-style Barrel with Abbott Barrel

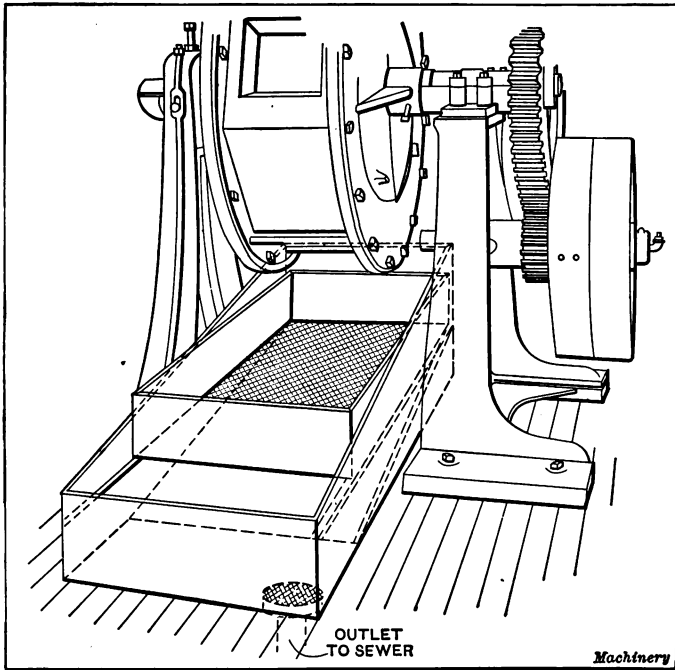

Fig. 5. Convenient Arrangement for Separating Balls and Work

pieces of work, and, of course, if the pieces are easily bent, there will be trouble from this source. Aside from the danger of bending large work in the burnishing barrel, a greater source of trouble is from scratches caused by the sharp edges of such pieces coming in contact

with the finished faces of other pieces in the barrel. Referring to the illustration Fig. 8 a method of mounting pieces of this character is shown. Any convenient method of clamping is employed, depending, of course, on the shape of the pieces, but the fundamental idea is to support the pieces so that they cannot move in the barrel, and yet give

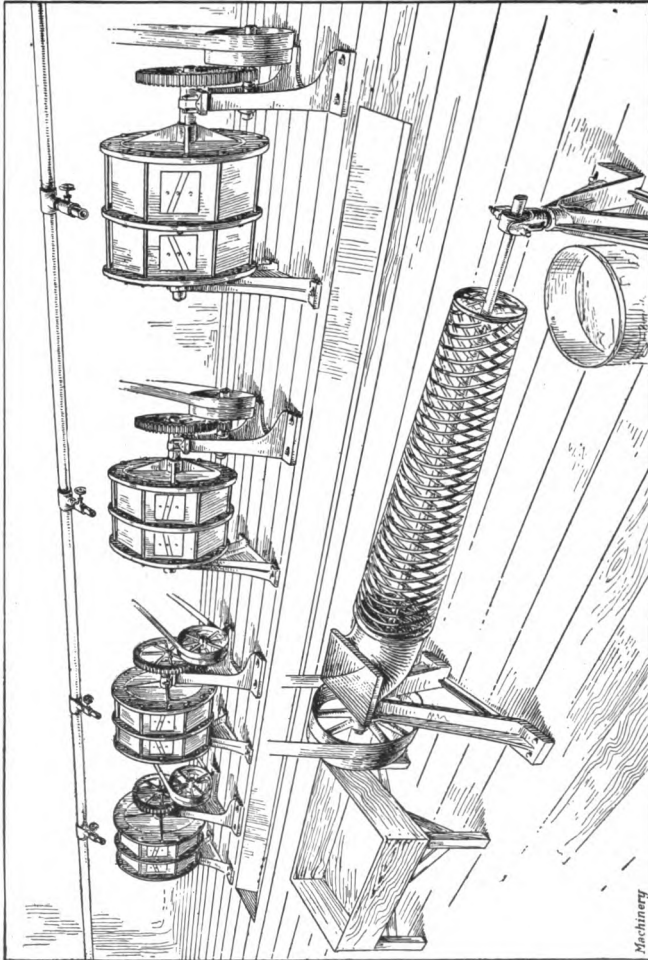

Fig. 6. Abbott Ball-burnishing Installation at Heron Mfg. Co.'s Plant

the burnishing balls a chance to act upon the work exactly the same as though it was loose in the barrel. Mounted in this manner no possible injury can be done to the work and yet the balls have access to every part of the piece except the edge, even to the inside. It is apparent that this method cannot be used for all work, but a little ingenuity will often solve the problem without having to resort to hand polishing.

A typical installation of the Abbott ball burnishing process is found at the Heron Mfg. Co., Utica, N. Y. This installation is represented by the illustration Fig. 6, in which are shown four double barrels driven from a common shaft. A line of piping extends over the four barrels, being connected with a hot water tank on the floor above. By means of outlets over the barrels, water may be admitted to the barrels for

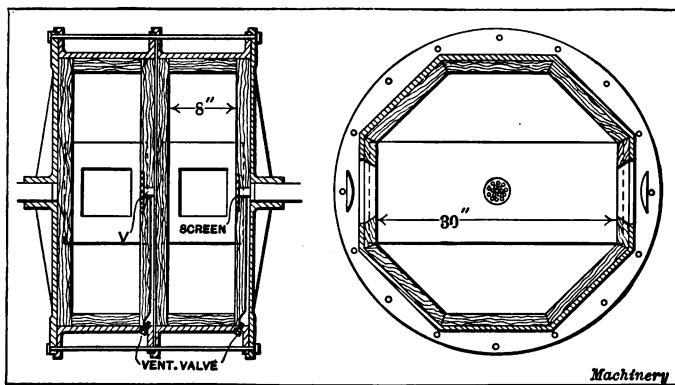

Fig. 7. Construction of Ball-burnishing Barrel

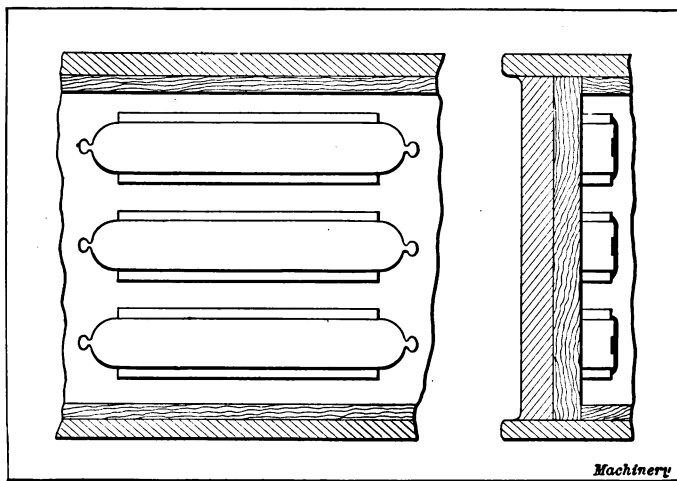

Fig. 8. Section of Barrel to show Method of Mounting Large Work

mixing the burnishing solutions, and for cleaning the barrels and their contents after the burnishing operation. A trolley system is arranged so that after the work has been dumped from a barrel into a basket, during which operation the suds and soap solution are carried away by means of the trough in front of the barrels, the work may be carried to the sawdust box for drying. This sawdust box is of the usual type and after the work has been sufficiently dried, it is

shoveled into the chute shown at the right of the sawdust box, from which it enters the revolving conical screen cylinder and is separated from the sawdust, emerging from the small end of the screen, completely dried and ready for shipment.

By the use of this apparatus, the Heron Mfg. Co., who manufactures casters of all kinds, states that it is producing twice the number of parts at half the cost, and getting a better finish than when using hand polishers. Thus an expensive polishing and buffing equipment is eliminated, as well as the high priced labor formerly employed.



## PRICE OF EACH BOOK

25 CENTS

1 SHILLING

# The Unit System of SELF-EDUCATION

The Unit System of Self-Education in Mechanics, originated by MACHINERY, now comprises 125 Reference Books and twenty Data Books all published at the lowest price that has ever been made for mechanical books of real merit. Each book measures about 6 x 9 inches, standard size, and contains from 32 to 56 pages, depending upon the amount of space required to adequately cover its subject. The books in the Data Series are slightly wider than the Reference Books in order to provide for hundreds of large plates. The books are all first class in every respect—printed from new plates, with new and ample engravings, on the same high-grade paper that is used for MACHINERY, and have wide margins to allow for binding in sets, should this be desired. These books have been enormously successful, but probably would not have been, had readers been obliged to pay the usual high prices incident to expensive bindings. These books, being made for *use* and not for ornament, are bound in strong paper covers, which enables marketing them at an unprecedented price for books of the highest merit.

The plan comprehends an indefinite number of compact, inexpensive books, each covering one subject thoroughly in a practical manner, and sold singly, or in complete sets, as may be desired. The whole series comprises a complete working library of authentic mechanical literature for the Mechanical Engineer, the Machine Designer and Draftsman, the Machinist, the Toolmaker and the Apprentice. The books are particularly adapted for self-education and are planned to meet the demand for a reliable, practical and inexpensive system.

The information contained in the books of this System is the latest and best available on machine design, construction and operation, revised and brought up to date by MACHINERY's editorial staff—men constantly in touch with the best sources of information, and with the latest developments in mechanical practice.

These books are for the practical men at work in the mechanical industries. They deal in a practical manner with actual mechanical problems. They describe the practice and explain the mechanical principles in clear and simple language and in a direct and straightforward manner. The whole idea of the books is to give the *greatest possible amount of definite, practical information, in the clearest manner and in the smallest amount of space practicable. The information is boiled down.*

# MACHINERY.

THE INDUSTRIAL PRESS  
140-148 LAFAYETTE STREET  
NEW YORK, U. S. A.

MACHINERY PUBLISHING CO., LTD.  
27, CHANCERY LANE  
LONDON, W. C.

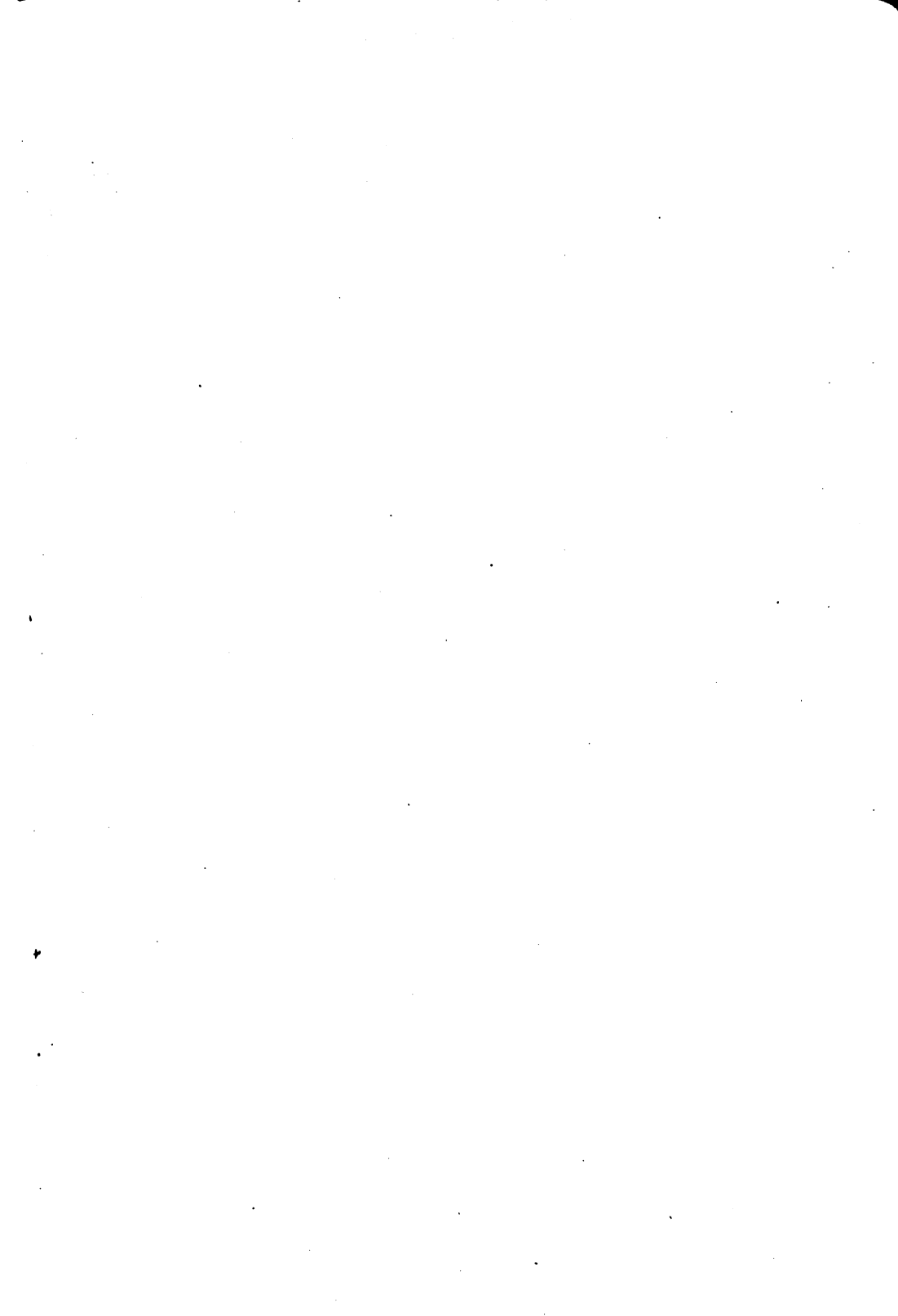



# MACHINERY'S HANDBOOK

For MACHINE SHOP  
AND DR. FITTING-ROOM

A REFERENCE BOOK ON MACHINE  
DESIGN AND SHOP PRACTICE FOR  
THE MECHANICAL ENGINEER  
DRAFTSMAN TOOL-MAKER AND  
MACHINIST.

MACHINERY'S Handbook comprises nearly 1400 pages of carefully edited and condensed data relating to the theory and practice of the machine-building industries. It is the first and only complete handbook devoted exclusively to the metal-working field, and contains in compact and condensed form the information and data collected by MACHINERY during the past twenty years. It is the one essential book in a library of mechanical literature, because it contains all the facts of importance in the text-books and treatises on mechanical engineering practice. Price \$5.00.

## GENERAL CONTENTS

Mathematics—Tables—Trigonometry—Methods and formulas in arithmetic and algebra—Logarithms and logarithmic tables—Scales—Areas and volumes—Solution of triangles and trigonometric problems—Angles and problems—Mechanics—Strength of materials—Welding—Strength of bolts—Strength and properties of steel wire—Strength and properties of wire—Strength of springs and tables for spring design—Torsional strength—Shafting—Friction—Ball bearings—Keys and keyways—Clutches and couplings—Friction brakes—Cam design and cam milling—Spur gearing—Bevel gearing—Spiral gearing—Herringbone gearing—Worm gearing—Envelopic gearing—Belting and rope drives—Transmission chain and chain drives—Crane chain—Dimensions of small machine details—Speeds and feeds of machine tools—Shrinkage and force at allowances—Measuring tools and gaging methods—Change gears for spiral milling—Milling machine indexing—Jigs and fixtures—Grinding and grinding wheels—Screw thread systems and thread gages—Taps and threading dies—Milling cutters—Reamers, counterbores and twist drills—Heat-treatment of steel—Hardening, casehardening, annealing—Testing the hardness of metals—Foundry and pattern shop information—The welding of metals—Autogenous welding—Throat welding—Machine welding—Blacksmith shop information—Die casting—Extrusion process—Soldering and brazing—Etching and etching fluids—Coloring metals—Machinery foundations—Application of motors to machine tools—Dynamo and motor troubles—Weights and measures—Metric system—Conversion tables—Specific gravity—Weights of materials—Heat—Pneumatics—Water pressure and flow of water—Pipes and piping—Lutes and cement—Patents.

MACHINERY, the leading journal in the machine-building field, the originator of the 25-cent Reference and Data Books. Published monthly. Subscription, \$2.00 yearly. Foreign subscription, \$3.00.

THE INDUSTRIAL PRESS, Publishers of MACHINERY

140-148 LAFAYETTE STREET

NEW YORK CITY, U. S. A.

