

HARVARD UNIVERSITY.



LIBRARY

OF THE

MUSEUM OF COMPARATIVE ZOOLOGY

55,773

BEQUEST OF

WILLIAM BREWSTER

December 4, 1920.

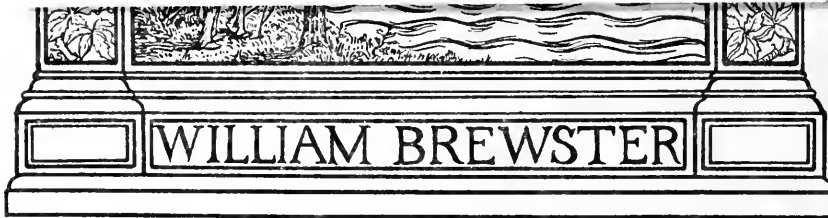

DEC 4 1920







RECREATION

A MONTHLY MAGAZINE DEVOTED TO EVERYTHING THE
NAME IMPLIES



VOLUME XVIII.
JANUARY TO JUNE, 1903



G. O. SHIELDS (Coquina), Editor and Manager



NEW YORK
23 West Twenty-fourth Street
1903

1908
STATIONERS
AND
PRINTERS

COPYRIGHT, 1908, BY G. O. SHIELDS

INDEX TO VOLUME XVIII.

	PAGE.
"The captive moose is left wretchedly to drag out its life".....	FRONTISPIECE
Moose Snaring in Nova Scotia. Illustrated.....	ERNEST RUSSELL 3
O' Winter Nights. Poem.....	HILTON R. GREER 6
Facts About the Beaver. Illustrated.....	R. C. W. LETT 7
Beaver Trapping.....	J. A. NEWTON 9
A Successful Fishing Trip.....	F. HIBBARD 11
A Girls' Boat Club. Illustrated.....	LAURA WESCOTT 13
A Holiday Hunt.....	J. O. LANDER 15
Round the Camp Fire. Poem.....	A. L. VERMILYA 17
Tyee Salmon in Puget Sound. Illustrated.....	J. H. BOWLES 19
A Florida Kid on a Camp Hunt.....	CHARLEY APOPKA 21
Among the Water Fowl. Illustrated.....	EDITOR 23
A Ballad of the Future. Poem.....	A. L. VERMILYA 25
The White Goat in Alaska.....	E. W. SHAW 28
Curiosities of Ecuador. Illustrated.....	DR. S. A. DAVIS 30
Signs of a Cold Winter.....	ADIRONDACK JIM 31
Bass Fishing in August.....	J. A. NEWTON 70
It Became a Free-for-all Fight.....	FRONTISPIECE
A Bear Fight in the Yellowstone Park. Illustrated.....	DAN BEARD 85
A Lullaby of the Sound. Poem.....	MRS. JEAN LE MUNYON 87
Bearding a Grizzly in His Den.....	A. L. DUHIG 89
Mr. Potter's Ovis Canadensis.....	STANLEY MAYALL 94
In the Arkansas Mountains.....	JOHN T. BAILEY 101
Some Place West of Kansas. Poem.....	MINNIE J. REYNOLDS 102
A Birchwood Fire. Poem.....	JAMES R. EDLIN 103
A Cushion Shot on Swartz Creek.....	C. A. HARMON 104
Outwitting a Mink.....	FRANK FARNER 105
Lost in a Tamarack Swamp. Illustrated.....	W. A. MASON 106
At a Rifleman's Fireside. Illustrated.....	W. H. NELSON 108
A Florida Kid on a Camp Hunt. VII.....	CHARLEY APOPKA 110
My First Adventure with a Buffalo.....	C. B. R., M.D. 112
My Big Trout.....	SENEX 113
Yellow Wolf . . . tried to dash into the post at the head of a dozen followers.....	FRONTISPIECE
With the Best Intentions. Illustrated.....	F. M. BERNARD 167
A Girl's Life in the Rockies.....	MYRTIS B. BUTLER 180
A New Hampshire Coon Hunt.....	E. H. HUNTER 183
A Coon Hunt in Pennsylvania.....	CHAS. H. WEAVER 185
It Might Have Been. Poem.....	EDWARD BOURNE 185
Ned Buntline's Raquette River Bass.....	J. F. CLOSSON 186
A Glimpse of the Old Kentucky Home. Poem. Illustrated.....	GRAYSON JEMISON 187
A Florida Kid on a Camp Hunt.....	CHARLEY APOPKA 188
Among the Pronghorns. Illustrated.....	B. R. BEYMER 191
A Camping Trip in Argentina.....	L. S. MCCAIN 192
Merrimac Bait Catching.....	GEO. L. WHITMORE 193
The wounded buck was a roaring murderous force. William Schutte.....	FRONTISPIECE
A Tale of a Trail. Illustrated.....	VICTOR SCHOOLMAN 249
A Song of the Hills. Poem.....	R. S. STRINGFELLOW 255
Ontario's Great Playground. Illustrated.....	FRANK YEIGH 257
Hunting in New Mexico.....	J. F. FOLEY 260
In Lonely Ways.....	FRANK H. SWEET 262
Touring in the Canadian Rockies. Illustrated.....	STANLEY WASHBURN 263
Some Bear Stories.....	S. N. LEEK 272
The Keiley Glycerine Process. Illustrated.....	K. ROWA 273
The Spring Poets. Poem.....	A. L. VERMILYA 275
A Mashipacong Tragedy. Poem. Illustrated.....	A. C. RUGGERI 276
Why Not? Poem.....	W. H. NELSON 278

	PAGE.
The streaked demon alighted beside the astonished terrier.....	FRONTISPIECE
Chum. Illustrated.....	W. S. CROLLY 331
Bass Fishing in the North Potomac.....	ALEXANDER HUNTER 337
How the Deacon Became a Horse Jockey. Illustrated.....	L. B. ELLIOTT 341
Oh! My Heart Is Hungry for the Hills. Poem.....	ALFRED I. TOWNSEND 345
Spring Madness.....	TEN SLEEP 347
A Place Just West of Kansas. Poem.....	FRANK WHITE 348
Canoeing on the Temagaming.....	C. E. T. 350
Casualties Among Animals. Illustrated.....	J. A. LORING 351
A New Mexico Sand Storm.....	HARRY SUYDAM 356
The Judge and I.....	MENOQUET 357
On the Manistee River. Illustrated.....	A. ST. J. NEWBERRY 359
He came near the surface and headed toward Vancouver.....	FRONTISPIECE
An Indian Harpooner's Catch. Illustrated.....	J. P. TODD 413
Canoeing on the Delaware. Illustrated.....	DR. ZANE GREY 415
Fishing in New Brunswick. Illustrated.....	CHAS. D. LEONARD 419
The Chronicles of a Chipmunk. Illustrated.....	DR. C. C. CURTIS 423
Home River Fishing. Poem.....	MILO THOMPSON 427
Sunday Inspiration.....	E. M. LEETE 428
A Haven of Refuge.....	CHAS. C. TOWNSEND 431
A Day Dream. Poem.....	L. C. ELERICK 431
The Song of the Fisherman. Poem.....	SYDNEY B. CARPENDER 432
Hunting and Fishing in the Highlands of Ontario.....	H. R. CHARLTON 433
With Worms for Bait.....	AL 435
The Jellyfish. Poem.....	J. C. EDWARDS 437
The Florida Kid.....	CHARLEY APOPKA 440
The Reason.....	CHAS. E. SCOFIELD 482
Who Said Rats? Poem.....	L. N. DOUGLAS 482
Why Peaceful Valley Left Home.....	TIMOTHY xxiv
From the Game Fields.. 33, 115, 197, 279, 361, 443	Forestry..... 59, 145, 223, 308, 389, 471
Fish and Fishing..... 41, 125, 205, 287, 371, 453	Pure and Impure Foods. 61, 147, 225, 310, 392, 473
Guns and Ammunition.. 45, 129, 209, 291, 375, 459	Book Notices..... 64, 228, 313, 395, 475
Natural History..... 51, 137, 215, 299, 381, 463	Publisher's Notes..... 65, 149, 229, 314, 396, 476
The League of American Sportsmen, 55, 141, 219, 302, 385, 467	Editor's Corner..... 67, 151, 233, 316, 397, 479
	Amateur Photography.. 74, 157, 238, 320, 402, 484

TYEE SALMON IN PUGET SOUND;

A Good Fishing Story by J. N. BOWLES,
with full page drawing by LOUIS AKIN.

VOLUME NUMBER

\$1.00 A YEAR
10c A COPY

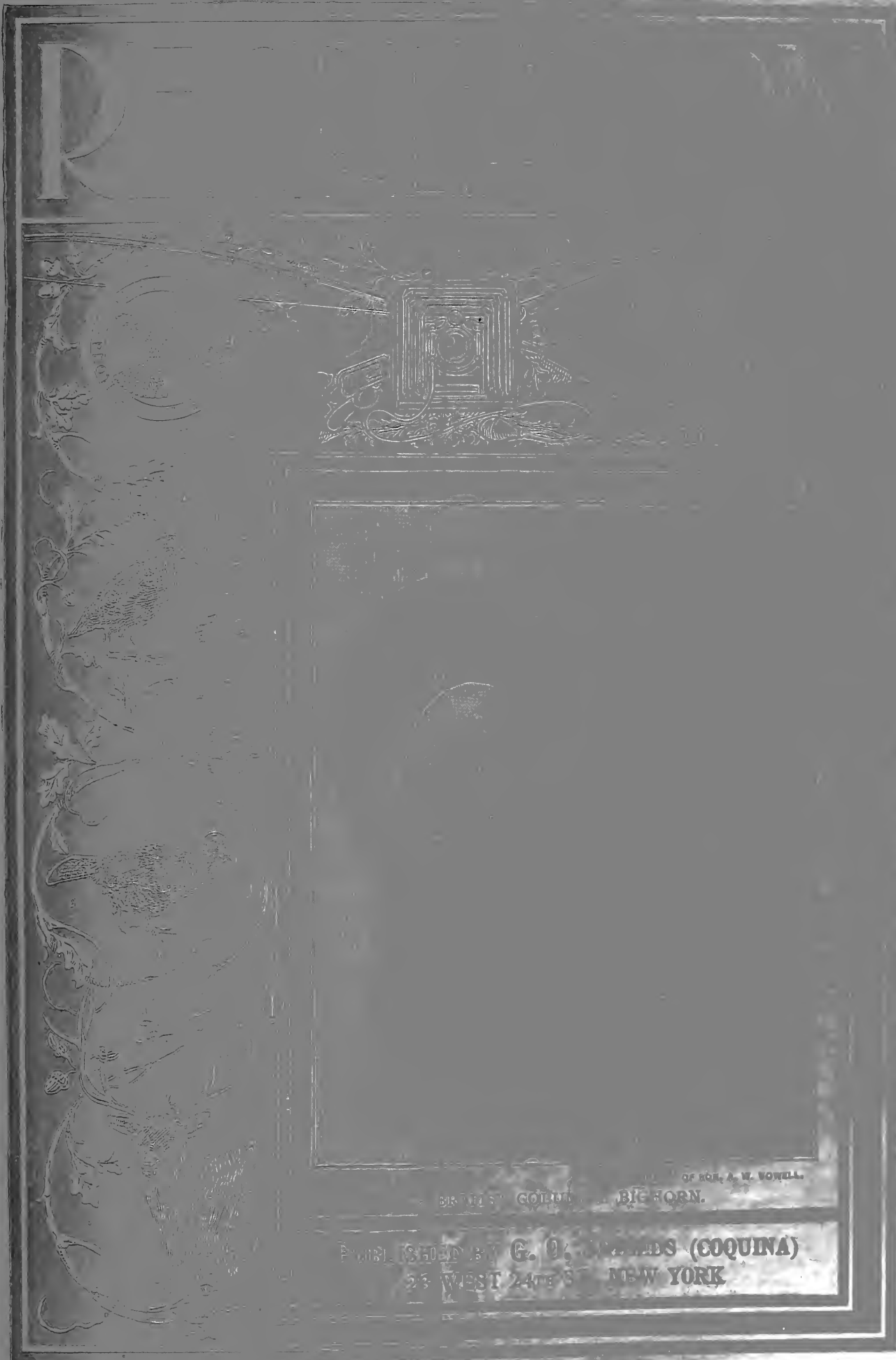

OF MR. A. W. VOWEL.
BIG HORN.

PUBLISHED BY G. O. STUBBS (COQUINA)
23 WEST 24TH ST. NEW YORK

OFFICIAL OFFER

MOOSE STARING IN NOVA SCOTIA:

By ERNEST HUNTER. Full page drawing by CARL RUNGIUS.



Established 1851

W. H. JONES & CO.

Importers and Wine
and Spirit Merchants

Also Proprietors of the Elm Hill Distilling Co.

REGISTERED AND SPECIAL BRANDS

Per Gal.
Old Gold Bourbon - \$4.00
(Eleven Years Old)

Holiday Pure Rye - 4.00
(Eleven Years Old)

Hermitage Rock & Rye 4.00
Superior

Five pounds of rock candy crystals to each gallon of seven year old Hermitage Rye whiskey, is used in the preparation of our Celebrated Rock and Rye.

Bon Ton Cocktails - 4.00
Martini, Manhattan, Vermouth, Whiskey, Tom Gin and Holland Gin. Carefully prepared from the choicest materials, perfectly blended.

Ruthven Sherry - 4.00
From Duff, Gordon & Co. Warranted twenty years in the wood before bottling. Rich and fruity.

Jewel Port - 4.00
From Silva & Cosens, Oporto. A choice product of the grape.

Rainbow Brandy V.O. 4.00
The product of one of the best American Vineyards, with all the medicinal qualities of French Brandy.

Jupiter Gin - 4.00
From the Swan Distillery, Schiedam, Holland, where Good Gin comes from. Tastes differ. Many people appreciate Good Gin. Jupiter is the best the world affords.

Medford Old Rum - 4.00
From Daniel Lawrence & Sons, Medford, Mass.

EXPANSION IS THE ORDER OF THE DAY

On receipt of \$12.00, we will ship, transportation charges prepaid, to any railroad point in the United States, twelve full quarts, assorted to suit, of any of the Brands named in this ad.

The goods are warranted as represented, namely, the Best of their class that money can buy. The capital and reputation of a commercial concern established more than fifty years is back of this offer. The result of a trial would be most gratifying to you. You would find it an investment not an experiment.

Remit cash in registered letter, or by Express Co., or P. O. money order. Write full name, P. O. address and nearest railroad station, with choice of shipping route.

W. H. JONES & CO.

Hanover and Blackstone Sts.

BOSTON, MASS.

RECREATION

Copyright, December, 1902, by G. O. Shields

A Monthly Magazine Devoted to Everything the Name Implies

\$1.00 A YEAR.
10 CENTS A COPY.

G. O. SHIELDS (COQUINA),
Editor and Manager.

23 WEST 24TH STREET,
NEW YORK

CONTENTS OF THIS NUMBER

	PAGE
"The captive moose is left wretchedly to drag out its life".....	FRONTISPIECE
Moose Snaring in Nova Scotia. Illustrated.....	ERNEST RUSSELL 3
O' Winter Nights. Poem.....	HILTON R. GREER 6
Facts About the Beaver. Illustrated.....	R. C. W. LETT 7
Beaver Trapping.....	J. A. NEWTON 9
A Successful Fishing Trip.....	F. HIBBARD 11
A Girls' Boat Club. Illustrated.....	LAURA WESCOTT 13
A Holiday Hunt.....	J. O. LANDER 15
Round the Camp Fire. Poem.....	A. L. VERMILYA 17
Tyee Salmon in Puget Sound. Illustrated.....	J. H. BOWLES 19
A Florida Kid on a Camp Hunt.....	CHARLEY APOPKA 21
Among the Water Fowl. Illustrated.....	EDITOR 23
A Fallad of the Future. Poem.....	A. L. VERMILYA 25
The White Goat in Alaska.....	E. W. SHAW 28
Curiosities of Ecuador. Illustrated.....	DR. S. A. DAVIS 30
Signs of a Cold Winter.....	ADIRONDACK JIM 31
Bass Fishing in August.....	J. A. NEWTON 70
From the Game Fields.....	33
Fish and Fishing.....	41
Guns and Ammunition.....	45
Natural History.....	51
The League of American Sportsmen.....	55
Forestry.....	59
Pure and Impure Foods.....	61
Book Notices.....	64
Publisher's Notes.....	65
Editor's Corner.....	67
Amateur Photography.....	74

Entered as Second-Class Matter at New York Post-Office, Oct, 17, 1894.



TIDINESS

and **COMFORT**
for all men by using

WASHBURNE'S

Cuff Holders

Instantly Attached or Detached.

Sent Prepaid for 20 Cents.
Scarf Holder 10 Cents.
Key Ring and Chain 25 Cents.

They never come loose—a tiny lever with a bulldog grip.

Illustrated Catalogue of others on request.

AMERICAN RING CO., Dept. 44, Waterbury, Conn

Sore Throat

Hoarseness, Quinsy, Tonsillitis
Laryngitis and other throat
troubles quickly relieved
and promptly cured
by the use of

Hydrozone

This scientific germicide is used and endorsed by leading physicians everywhere. It is *absolutely harmless*, yet a most powerful healing agent.

By killing the germs that cause these diseases, without injury to the tissue, Hydrozone cures the patient. Sold by Leading Druggists. If not at yours, will send bottle, prepaid, on receipt of 25 cents.

Prof. Charles Marchand

(Dept. F-59) Prince Street, NEW YORK.

Abercrombie & Fitch

HAVE

Removed Their Factory and Salesrooms

TO

314-316 BROADWAY

NEW YORK CITY

WHERE THEY ARE SUPPLYING

Complete Outfits

FOR

Explorers, Campers and Prospectors

Tents, Camp Furniture, Sleeping Bags, Blankets, Stoves, Aluminum and Tin Cooking Outfits, Clothes Bags, Camp Packs, Pack Harness, Pack Baskets, Alforjas, Saddle Bags, Pack Saddles, Canoes, Pantasote Clothing, Loden Clothing, Pontiac Clothing, Khaki Clothing, Hunting Boots, Moccasins, Fishing Tackle, Compasses and Instruments, Steel Traps and Chains, Rifles, Guns and Revolvers, Portable Houses, Cameras, Photo Outfits, etc., etc.

SEND FOR CATALOGUE R

20TH CENTURY LAUNCHES



STEAM YACHTS

SAIL YACHTS

ROW BOATS

CANOES

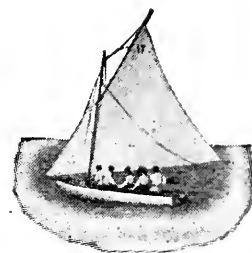
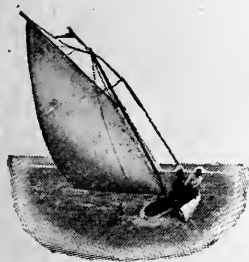

The Ideal Gentleman's Pleasure Craft used at the Pan-American Exposition because they were the best. Elegantly finished, simple, safe, reliable, and speedy. 15 ft. Fishing Launch, \$150. 16 ft. Family Launch, \$200. 35 ft. Cabin Launch, \$1,500. Send 10 cents for 80-page illustrated catalogue giving the truth in detail about the best boats built. Address

RACINE BOAT MFG. CO.

RIVERSIDE, RACINE, WIS.

SPRATTS PATENT ORIGINAL FOUR-PLATE COLORED CALENDAR

for 1903 will be ready for issue about the third week in December. As the first edition will be limited to 50,000 copies, applications should be sent in at once. Each calendar will be mailed in a tube, and a post-card will be posted at the same time notifying correspondent. Send three 1c. stamps for postage to the undersigned.

Write for our catalogue "Dog Culture," with practical chapters on the feeding, kenneling and management of dogs, post free.

We also manufacture specially prepared food for dogs, puppies, rabbits, cats, poultry, game, pigeons, fish, birds, etc.

Spratts Patent (AMER-ICA) Lmtd.

450 Market St., Newark, N. J.

Branches: 1324 Valencia St., San Francisco, Cal., 714 S. 4th St., St. Louis, Mo.

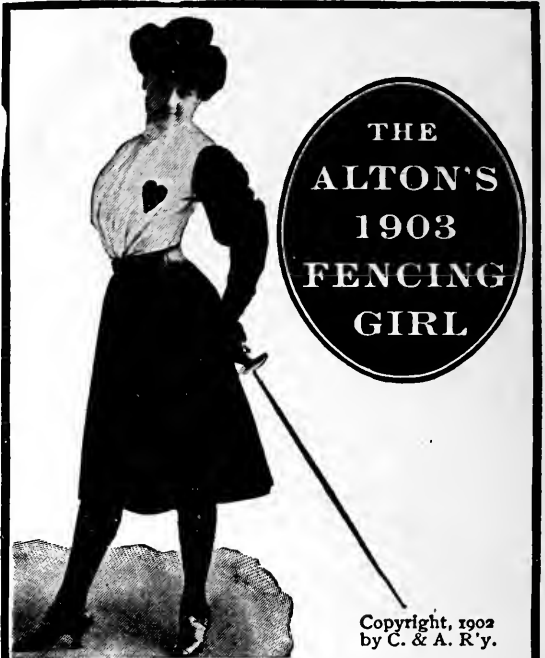

ART CALENDAR

Four graceful poses from life; figures ten inches high, reproduced in colors. Highest example of lithographic art.

"THE ONLY WAY"

to own one of these beautiful calendars is to send twenty-five cents, with name of publication in which you read this advertisement, to GEO. J. CHARLTON, General Passenger Agent, Chicago & Alton Railway, 328 Monadnock Building, CHICAGO, ILL.

The best railway line between CHICAGO, ST. LOUIS, KANSAS CITY and PEORIA.

99 OUT OF EVERY 100

USERS OF

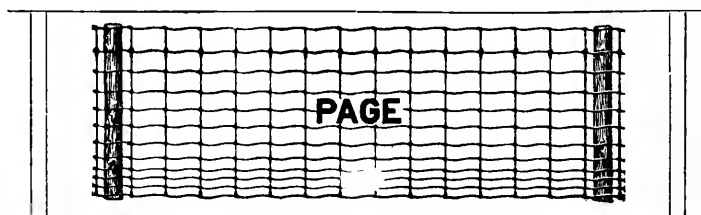

PAGE FENCE

keep on buying it because they like it, and the other one keeps on buying it because he can find no other as good.

Page Woven Wire Fence Co., ^{Box} 39, Adrian, Mich.

IF
you want

TO GET VIM

and elasticity in a pup
troubled with worms, **get rid
of the worms.** If you want lus-
trous eyes and jolly companionship
in a dog who has worms, **kill the worms.**

There is in every business some standard of
excellence that all strive to gain all claim they
have it yet still keep striving. We believe we have
in "**SURE SHOT**" the standard vermifuge because it is
compounded by a scientific, practical and experienced man
who has owned and studied the well dog and the sick dog in home
and in field pretty much all his life. At any rate we do not try to
better it for we know it can't be improved upon, and the formula is our
sole property.

You've known all along what worms will do to a dog as a puppy or adult.
Now you know the best remedy for ridding a dog of worms.

SERGEANT'S "SURE SHOT"

is a remedy with a string of successful years behind it, because it is
thoroughly safe and reliable. No harm can follow its use even if worms
are not the trouble, and it will give puppies a strong, healthy constitu-
tion that will fight victoriously the ravages of disease later in life. No
first-class kennel manager or private owner ever thought of being with-
out it, once he used it.

Lock Box 103, HOLLY SPRINGS, MISS.
"I consider "**SURE SHOT**" the best medicine I have ever used for worms in
puppies, and the least trouble to administer. MRS. ROBERT HASTINGS.

SERGEANTS "SURE SHOT" per bottle 50c. Sold by Druggists or
Sporting Goods Dealers everywhere or mailed (prepaid) from

POLK MILLER DRUG CO.,
RICHMOND, VIRGINIA, BOX 217.

There isn't anywhere a dog lover or owner who wouldn't
like to have our 48 page Treatise on
Dogs. We will send it and a Ped-
igree Blank to any address for
3 cents in stamps, which
go to pay the postage.

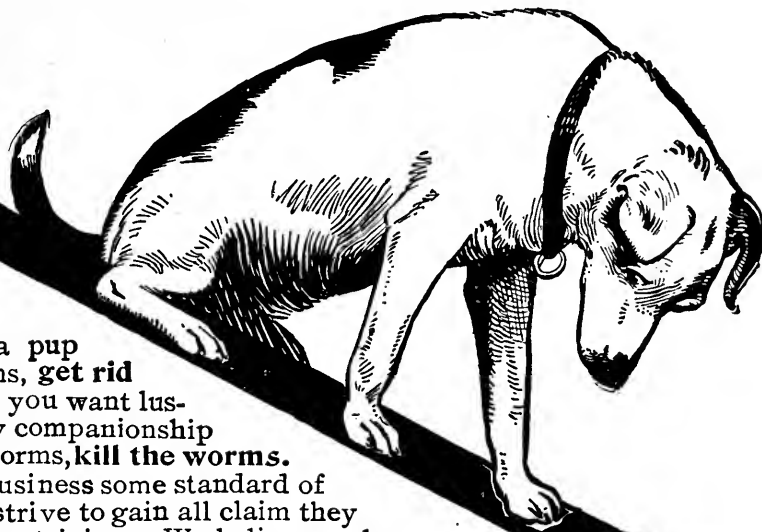
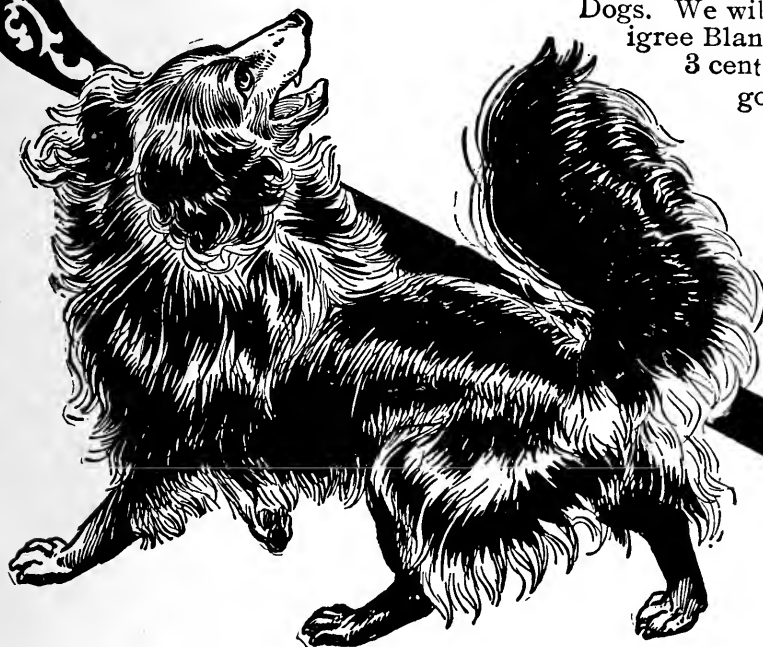

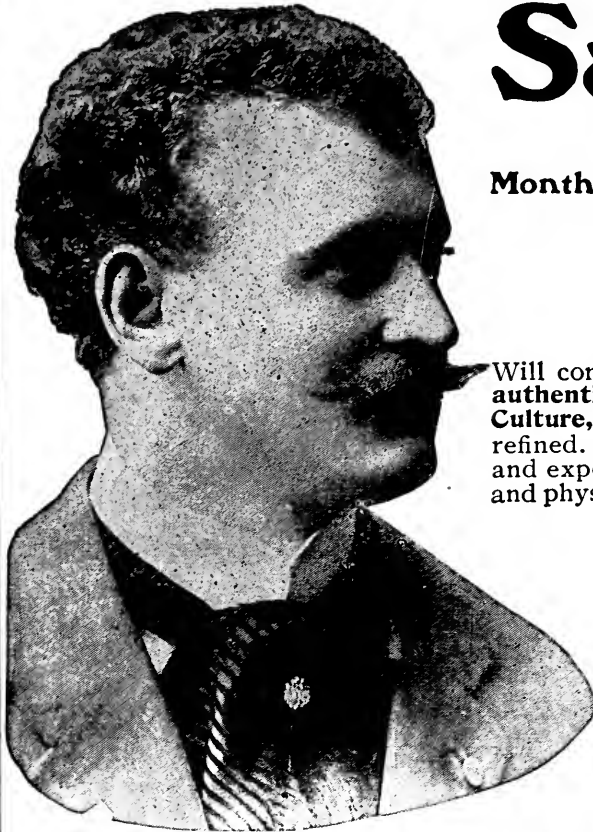

Sandow's

Monthly

Magazine

for 1903

Will contain during the year more than 1,000 pages of the most authentic information and instructions pertaining to Physical Culture, Hygiene and Recreation. Fully illustrated, chaste and refined. It will contain not only the results of my own researches and experience, but also that of the world's foremost educators and physiological experts.

TO ALL MAGAZINE SUBSCRIBERS at \$1.00 each who send me their age, sex, height, weight, occupation, also the general condition of their heart, lungs, stomach and nerves, I will prescribe and immediately forward by mail, free of charge, a course of scientific exercises covering a period of twenty days, the practice of which will be both fascinating and health-giving, and will prepare the business man or woman for their work, or lay the foundation of perfect health for the child.

During my future American tours, I wish to meet personally, and examine my Postal Course pupils. With that end in view, I shall hereafter issue to every pupil a registered coupon, which will admit the owner to all my

lectures and exhibitions, and also serve to fully identify my pupils whenever they call upon me for a private interview. Send ONE DOLLAR without delay for one year's subscription, to

EUGEN SANDOW, Boston, Mass.

A GREAT COMBINATION

Until February 28, 1903, subscriptions will be taken at this office for the following publications at rates named in right hand column :

	Regular Price	Our Net Price
RECREATION	\$1 00	\$1.00
Success.....	1.00	.60
Frank Leslie's Popular Monthly	1.00	.50
Everybody's Magazine.....	1.00	.50
Woman's Home Companion.....	1.00	.50
Review of Reviews.....	2.50	1.50
Current Literature.....	3.00	1.50
Lippincott's Magazine	2.50	1.50
	<u>\$13 00</u>	<u>\$7.60</u>

Any 3 or more of above, including RECREATION and *Success*, pro rata.

All subscriptions must be sent to RECREATION.

Magazines may be sent to one or to different addresses. Subscriptions will commence with issue requested whenever possible to furnish copies, otherwise with issues of the month following that in which the subscription is received.

Present subscribers to RECREATION may take advantage of these offers, either in ordering their own subscriptions extended for one year from the date of expiration, or in presenting a subscription to RECREATION to some friend.

Remit by P. O. or Express Money Order. **Not** by local check.

Address RECREATION, 23 West 24th St., New York City

J. M. Hanson's Clubbing Offers

LEXINGTON, KY.

Four Leading Magazines, for \$2.25

Sent to one or different addresses. The periodicals in any combination offer may be sent to one or different addresses. Join with your friends and take all. The subscriptions may be either new or renewals except where otherwise stated. All subscriptions are for one full year.

RECREATION, 1 yr.	\$1.00	} All Four One Full Year
Cosmopolitan, 1 yr.	1.00	
Frank Leslie's Monthly, 1 yr.	1.00	
The Nickel Magazine, 1 yr.50	
		} \$2.25
		(Personal Checks Accepted)

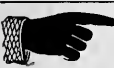

Three Leading Offers

Recreation and Nickel Magazine, \$1.00
 Recreation and American Boy .. 1.25
 Recreation and Everybody's .. 1.25

Recreation.....\$1.00	} Send us only \$2.00 for All Three
Cosmopolitan..... 1.00	
Leslie's Monthly..... 1.00	
Recreation.....\$1.00	} Our Price \$3.25 for All Four
Country Life in America .. 3.00	
Everybody's Magazine .. 1.00	
Nickel Magazine..... .50	

Recreation.....\$1.00	} Cut in Half \$3.00 for All Three
Public Opinion (new sub.)3.00	
The Critic..... 2.00	
Recreation.....\$1.00	} Send us Only \$3.00 For All Three
Current Literature..... 3.00	
Hunter, Trader & Trapper 1.00	

	Regular Price.	Our Club Price
Recreation, Review of Reviews and Success	5.50	\$3.00
RECREATION AND LESLIE'S WEEKLY	5.00	3.00
Recreation, American Boy, Cosmopolitan and Vick's Magazine	3.50	2.25
Recreation, Judge (weekly) and Public Opinion (new sub.)	9.00	5.00
Recreation, Current Literature and Popular Science News	5.50	3.25
Recreation, Everybody's, Arena, and Mind	6.50	2.50
Recreation, House Beautiful and Leslie's Monthly	4.00	2.50
Recreation, Birds and Nature, Success and Cosmopolitan	4.50	2.50
Recreation, American Field and American Boy	6.00	4.25
Recreation, Lippincott's and Success	4.50	3.00
Recreation, Table Talk and Country Gentleman	3.50	2.25
Recreation, Woman's Home Companion, Cosmopolitan and Leslie's Mo.	4.00	2.50

Recreation Will Also be Sent in Clubs as Follows:

	Club Price.	Club Price	
with Nickel Magazine and Vick's.....	\$1.50	with Cosmopolitan and House Beautiful	\$2.50
with Nickel Magazine and American Boy	1.75	with Cosmopolitan and Lippincott	3.25
with Nickel Magazine and Success	1.75	with Cosmopolitan and St. Nicholas	4.00
with Nickel Magazine and Everybody's	1.75	with Cosmopolitan and Scribner's	4.25
with Nickel Magazine and The Era.....	1.75	with Cosmopolitan and Critic	2.50
with Nickel Magazine and Table Talk.....	1.75	with Cosmopolitan and Century	5.00
with Nickel Magazine and Ev'ry Month	1.75	with Cosmopolitan and Country Gentleman..	2.25

The American Boy or Leslie's Monthly may be substituted for Cosmopolitan in all offers.

Youth's Companion (including all extra numbers and calendar for 1903) may be added to any of our offers for \$1.75 additional. Pearson's Magazine, \$1.00; Ladies' Home Journal, \$1.00; Saturday Evening Post, \$1.00; McClure's, \$1.00; Delineator, \$1.00; Munsey's, \$1.00; St. Nicholas, \$2.65; Harper's, \$3.35; Century, \$3.65.

Free If you will send us three orders for any of the above combinations, of \$1.50 or more, you may have free, as your premium, a yearly subscription to Recreation, or Cosmopolitan or American Boy or Leslie's Monthly or Success or Everybody's. Your own club, and two other clubs make the three orders
 REFERENCES: The Bradstreet Agency, R. G. Dun & Co., All Publishers, Phoenix National Bank Lexington, Kentucky.

Club raisers, newsdealers and agents wanted to take orders for our combination offers. Liberal commissions paid. A \$1100 WING PIANO and a Number of CASH PRIZES to Agents sending us most subscriptions. Write for particulars. Address all orders to

J. M. HANSON, MAGAZINE AGENCY,

120 HANSON BLOCK, LEXINGTON, KENTUCKY.
 44-Page Catalogue of 3,000 Periodicals Free.

Game is Growing Scarce

SO ARE GAME FISHES

The time is coming when the only shooting or fishing worth while will be on private preserves.

HERE IS A CHANCE

To Join a Club that Will Always Have
PLENTY OF GAME and
PLENTY OF BROOK TROUT and
PLENTY OF BLACK BASS
 ON ITS OWN PROPERTY

Only 6 hours from New York City, 3 hours from Boston

20,000 acres of land, to be abundantly stocked with game of various kinds.

15 miles of trout streams to be stocked with trout.

Thousands of acres of lakes and ponds, to be stocked with black bass.

PINE FORESTS RICH IN OZONE

Hardwood forests, which are the natural home of the deer and ruffed grouse.

Old, abandoned farms, which will furnish ideal range for thousands of quail.

Golf grounds, polo grounds, tennis grounds, baseball grounds.

Fine roads for riding, driving, and automobiling.

Pure air, pure water, delightful scenery.

Address

L. A. TILLINGHAST

275 Westminster Street

Providence, R. I.



PINEHURST

N. C.

In the Heart of the
LONG LEAF PINE REGION

Most Healthful and Delightful Resort in the South.

FOUR MODERN HOTELS

Including the CAROLINA, one of the most delightful and largest of America's resort hotels. FIFTY COTTAGES, CASINO, and livery of fine saddle horses.

TWO FINE GOLF COURSES

One of 18 holes, splendidly laid out and kept in the pink of condition, and another of 9 holes for beginners.

FINEST QUAIL SHOOTING

In the south upon the Pinehurst preserves, 25,000 acres upon which has been planted more than a hundred patches of cow peas, which are left unharvested for feeding purposes.

Perfectly trained hunting dogs and guides always to be had, and ideal sport guaranteed.

FOR BOOKS ON GOLF AND SHOOTING AT PINEHURST, ADDRESS

Resident Manager, Pinehurst, North Carolina.

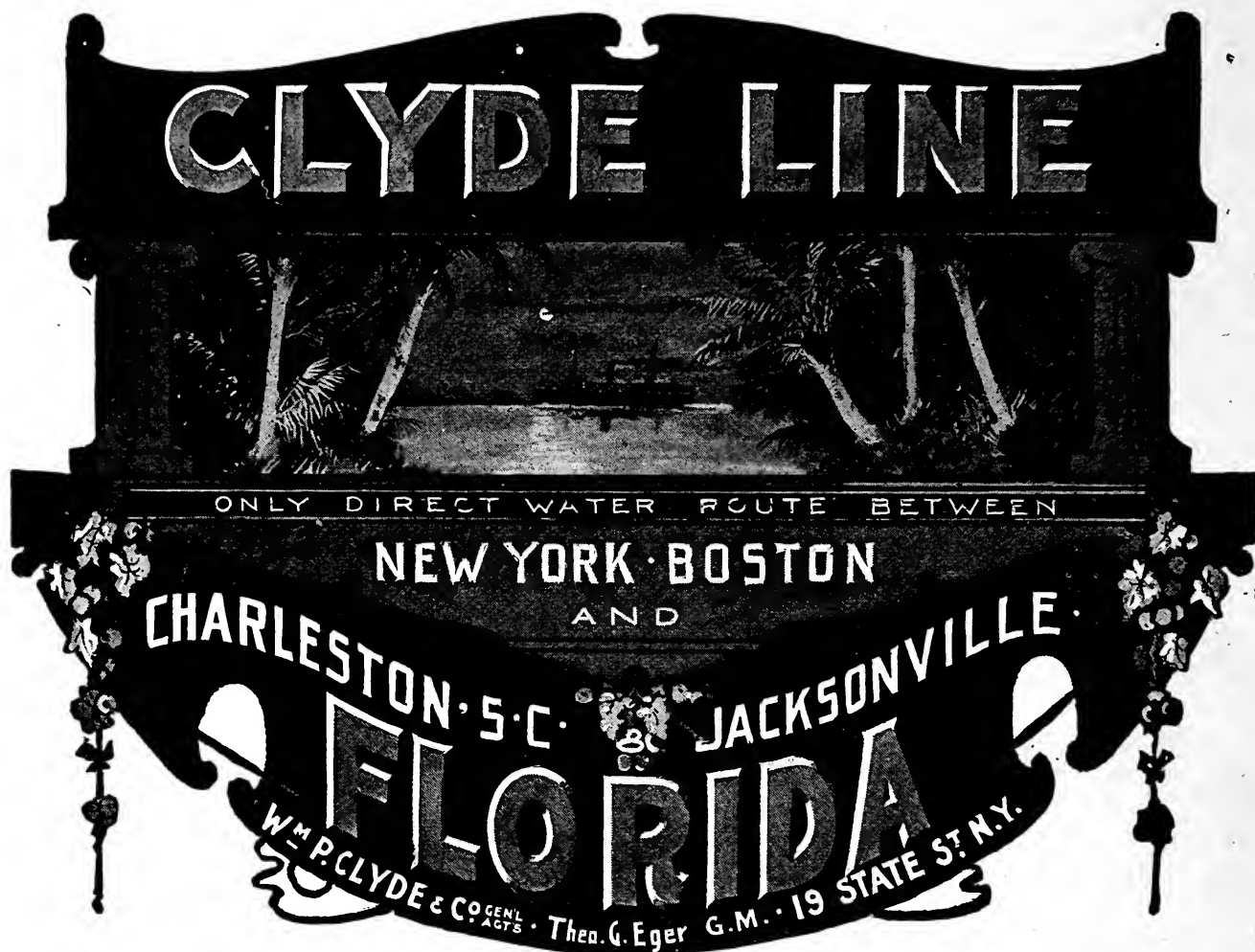

OLD DOMINION LINE

Delightful Short Trips

FOR THE TOURIST

Who desires to see the heart of the picturesque and historical waterways of Virginia.

For Those Who Seek Rest

In the balmy air of Old Point Comfort and Virginia Beach.

FOR THE BUSINESS MAN

Who prefers to break his journey by an agreeable sea-trip, and

FOR THE SPORTSMAN

In search of good hunting country.

Steamer Sails 3 P. M. Every Weekday.

Ticket and Stateroom Reservations at Pier 26, N. R.
Telephone 1580 Franklin.

OLD DOMINION STEAMSHIP CO., General Offices, 81 Beach St., N. Y.

H. B. WALKER, Traf. Mgr.

J. J. BROWN, G. P. A.



Oceans of Sunshine California

Acres of roses and miles of palms
— that's California in midwinter.
SEA-BATHING THE YEAR ROUND.

Chicago to California in less than three days, on a high-class train,
The California Limited. You will enjoy the perfect dining
car service, the unique scenery, and the new compartment Pull-
mans. Visit Grand Canyon of Arizona en route.

Apply to agents The Atchison, Topeka & Santa Fe Railway System for illustrated books describing the California tour. NEW YORK 377 Broadway—BOSTON 332 Washington St.—MONTREAL, QUE. 138 St. James St.—PHILADELPHIA 711 Chestnut St.—BUFFALO Ellicott Square Bldg.—DETROIT 151 Griswold St.—CLEVELAND Williamson Bldg.—CINCINNATI 417 Walnut St.—PITTSBURG 402 Park Bldg.—ST. LOUIS 108 N. 4th St.—CHICAGO 109 Adams St.—PEORIA 103 S. Adams St.—KANSAS CITY 905 Main St.—TOPEKA A. T. & S. F., Gen. Pass. Office—DES MOINES 409 Equitable Bldg.—MINNEAPOLIS 503 Guaranty Bldg.—DENVER 1700 Lawrence St.—SALT LAKE CITY 411 Dooly Block—LOS ANGELES 200 Spring St.—SAN FRANCISCO 641 Market St.—SANTA BARBARA 635½ State St.—GALVESTON 224 Tremont St.—DALLAS 246 Main St.—SAN ANTONIO 101 E. Commerce St.—EL PASO Mills Block—ATLANTA 16 N. Pryor St.—NEW ORLEANS 705 Gravier St.

Santa Fe

Santa Fe

THE PAST AND THE PRESENT



The Oldest Inhabitant on The Union Pacific R. R.

THE OLDEST INHABITANT ON LINE OF UNION PACIFIC

The oldest inhabitant—admire him! The last of his race—what pity! King of his kind—mighty, majestic!

He has braved the mountain torrents. He has laughed at heaven's deep rolling thunder. His eyes have given responsive fires to the lightning's flash. The tornado has only combed out to fineness his shaggy mane. In protection of his kind he has hurled splendid defiance at his cruel foe—man.

He is a type par excellence in the animal kingdom; type of courage, power, nobility. For centuries he has dominated plain and mountain, forest and canyon—free, fearless.

Before the Indian, the scout, the pioneer, the settler—he was. He has witnessed all their advances, encroachments, innovations, while he fought for life, land, liberty. The territory was his, his sacred heritage, and he battled for it as the primal, rightful and superb aboriginee.

But man is unfeeling, selfish, destructive, when nature, animate or inanimate, stands in the way of his enterprise and enrichment. And so the animal ruler of the wide, wild western world was hunted, driven back and brought to the verge of extermination.

It would challenge the fine artistic talents of a Rosa Bonheur to portray the qualities and nobilities of such a matchless specimen of the beast creation, and then his melancholy yet defiant grandeur as he witnessed the merciless extinction of his race.

Man, however, is conquerer, and time is the paramount consideration. Time is health and wealth, and to time everything succumbs. The Buffalo, the primal "Lord of the Land," has been driven back to his animal fastnesses in obedience to the law of advancing civilization and the imperative demand of time, the speediest time. The

railroad meets the demand of time, and, specifically, the Union Pacific meets the demand of the speediest time.

Formerly the race across the great western portion of the continent was by the horse and the caravan. But something better was to come. Over twin lines of steel, climbing peaks, threading canyons, covering vast plains, came the first engine of advancing civilization with its human freightage in eager search of the one supreme goal—life and prosperity. But still the best had not been attained.

How weary the caravan! How tedious the early railway passage over the great western world. The culmination, however, was to come—has come.

And this widely coveted zenith, this supreme desideratum of man and object of man's search, is here. How so? By a Union Pacific train reaching Salt Lake City in twelve hours, San Francisco sixteen, and Portland sixteen hours ahead of all competition. No exception to this, mind you. You leave Omaha at 9:40 a. m. to-day, are thousands of miles away, in Salt Lake City at 3:05 p. m. to-morrow, San Francisco 5:25 p. m., and Portland 4:30 p. m. the next day, Los Angeles the day after.

Extinction—resurrection! If it means extinction to one of the noblest types of the animal kingdom, it also means a resurrection to man who was made lord of that kingdom; a resurrection into a wider, grander sphere of development, usefulness and higher civilization.

The law of compensation and of higher compensation obtains. The merely animal gives way to the diviner human; and the diviner human requires the two prime essentials of speedy time and spacious territory to realize its ideals for the betterment of all.

"THE OVERLAND LIMITED" THE GREAT CALIFORNIA TRAIN

The Only Electric Lighted Daily Train Between East and Pacific Coast

ONLY ONE NIGHT TO UTAH
TWO NIGHTS TO CALIFORNIA AND OREGON

RUNS EVERY DAY IN THE YEAR
CONNECTING EAST AND WEST

E. L. LOMAX, G. P. & T. A., OMAHA, NEB.



In California there are a hundred places to go; a thousand things to do—mountains to climb, old missions to visit, flowers to gather, fruit to eat, people to get acquainted with, great hotels where you can be more comfortable than at your own home.

Why not go there this winter? The trip is quickly and comfortably made if you take the

Golden State Limited.

No other train to Southern California makes faster time. No other train is so luxuriously equipped.

Leaves Chicago daily at 7.45 P.M.; Kansas City 10.40 A.M. Only 68 hours Chicago to Los Angeles; 72 hours to San Diego; 74 to Santa Barbara.

Route: Rock Island and El Paso and Northeastern Systems, Chicago to El Paso; Southern Pacific Company, El Paso to Los Angeles and San Francisco. Electric lights; electric fans; barber shop; bathroom; Booklovers Library; compartment and standard sleepers; observation, dining and library cars. Lowest altitudes and most southerly course of any line across the continent. Send 6 cents in stamps for book about California. Beautifully illustrated; interesting; practical.

JOHN SEBASTIAN,

Passenger Traffic Manager, Rock Island System, Chicago, Ill.



“FOR 34 YEARS A STANDARD PIANO.”

THE WING PIANO

YOU NEED THIS BOOK IF YOU INTEND TO BUY A PIANO. A book —not a catalogue— that gives you all the information possessed by experts. It makes the selection of a piano easy. If read carefully, it will make you a judge of tone, action, workmanship, and finish; will tell you how to know good from bad. It describes the materials used; gives pictures of all the different parts, and tells how they should be made and put together. It is the only book of its kind ever published. It contains 116 large pages, and is named “**The Book of Complete Information About Pianos.**” We send it free to anyone wishing to buy a piano. Write for it.

SAVE FROM \$100 TO \$200 We make the WING PIANO and sell it ourselves. It goes direct from our factory to your home. We do not employ any agents or salesmen. When you buy the WING PIANO you pay the actual cost of construction and our small wholesale profit. This profit is small because we sell thousands of pianos yearly. Most retail stores sell no more than twelve to twenty pianos yearly, and must charge from \$100 to \$200 profit on each. They can't help it.

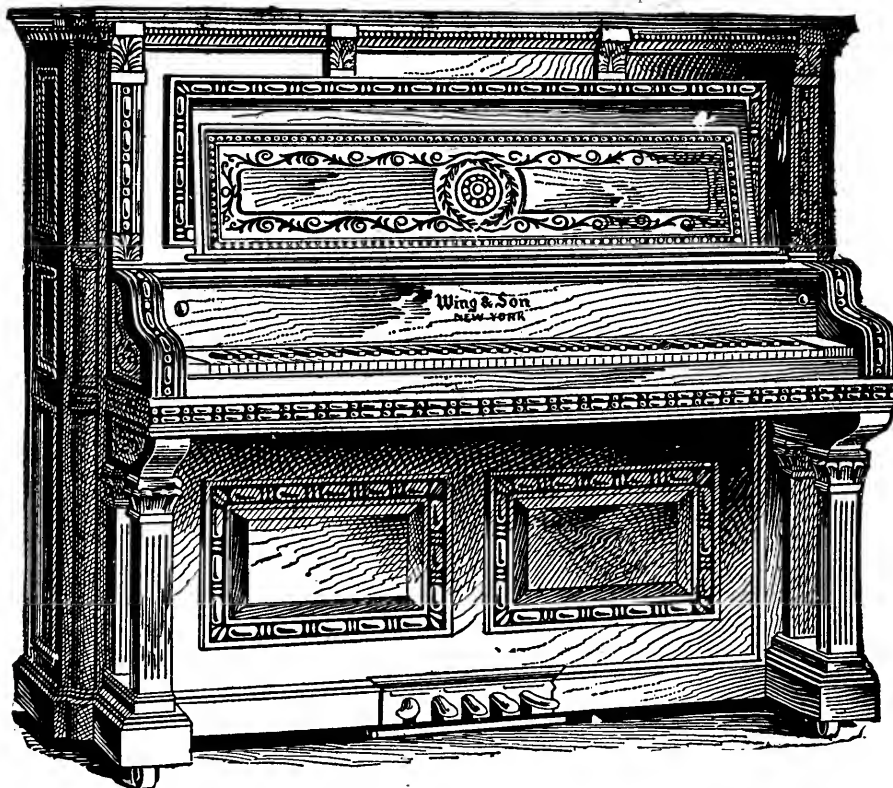

A Wing style—45 other styles to select from.

SENT ON TRIAL WE PAY FREIGHT. NO MONEY IN ADVANCE. We will send any WING PIANO to any part of the United States on trial. We pay freight in advance and do not ask for any advance payment or deposit. If the piano is not satisfactory *after twenty days' trial in your home, we take it back entirely at our expense.* You pay us nothing unless you keep the piano. There is absolutely no risk or expense to you.

Old instruments taken in exchange.

EASY MONTHLY PAYMENTS.

INSTRUMENTAL ATTACHMENT A special feature of the Wing Piano; it imitates perfectly the tones of the mandolin, guitar, harp, zither and banjo.

IN 34 YEARS 33,000 PIANOS We refer to over 33,000 satisfied purchasers in every part of the United States. WING PIANOS are guaranteed for twelve years against any defect in tone, action, workmanship, or material.

WING ORGANS Are just as carefully made as Wing Pianos. They have a sweet, powerful, lasting tone, easy action, very handsome appearance, need no tuning. Wing Organs are sold direct from the factory, sent on trial; are sold on easy monthly payments. For catalogue and prices write to

WING & SON, 226 and 228 East 12th St.,
NEW YORK.

1868—34th Year—1902.

JAMAICA

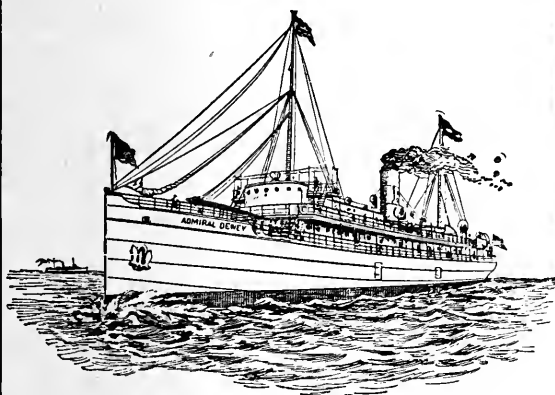

THE GEM OF THE WEST INDIES

An ideal spot in which to spend a winter's vacation and avoid all the extremes of the northern climate

UNITED FRUIT CO.'S STEAMSHIP LINES

operate weekly between BOSTON and PHILADELPHIA and JAMAICA, the magnificent twin-screw U. S. Mail Steamships

**Admiral Dewey, Admiral Sampson
Admiral Schley, Admiral Farragut**

Sailings Weekly from Boston and Philadelphia. Fare for round trip, including state-room accommodations and meals, \$75; one way, \$40

Send for Beautiful Booklet Whether You Contemplate the Trip or Not

United Fruit Co.

Pier 5, North Wharves, Phila.
Long Wharf, Boston



MKT TO OLD MEXICO MKT

**EVERY DAY IN
THE YEAR AND
SUNDAYS, TOO**

Not the First,
Not the Last,
But the ONLY.

**The Missouri, Kansas
& Texas Railway Co.**

Operates First Class Drawing Room Sleeping Cars between St. Louis and the City of Mexico Without change either of cars or train attendants.

TRAIN LEAVES ST. LOUIS DAILY AND SUNDAYS, TOO, AT 8:32 P. M.

First day out it passes through the beautiful Indian Territory, the second morning it is at SAN ANTONIO, TEXAS, the City of Missions. In the evening it crosses the Rio Grande at Eagle Pass (the Mexican Frontier). Thereafter the route is via the most picturesque portion of Old Mexico.

For a charming little book on this picturesque country, and a souvenir Mexican coin free, address

JAMES BARKER,

G. P. & T. A., M. K. & T. Ry., St. Louis.

N. B.—These are not Tourist Cars, but the finest equipment of the Pullman Co.

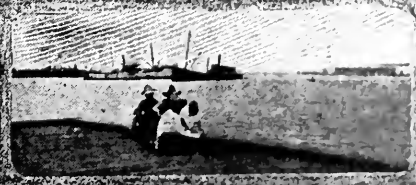

SAVE FOUR BIG PROFITS.

When you buy whiskey from a dealer, you pay five profits, though four of them can be avoided. The distiller distills the whiskey under U. S. Government supervision, and when it leaves him it is absolutely pure. The Government sees to that. All distillers, except ourselves, sell in barrels to brokers, who sell, also in barrels, though in smaller lots, to rectifiers. The rectifier takes the pure whiskey out of the barrels, blends it, waters it, adulterates it, "doctors" it as much as he likes, for the Government has no control over whiskey after it once leaves the distiller, and then bottles it and sells to wholesale dealers, who in turn sell to retail dealers, from whom you buy. You thus pay the enormous and unnecessary profits of the broker, the rectifier, the wholesaler and the retailer. You pay at least double our price and at the same time get "doctored" whiskey.

We sell direct to consumers and are the only distillers who do. Therefore, when you buy Hayner Whiskey, you get it direct from our own distillery, with all its original strength, richness and flavor, with a United States Registered Distiller's guarantee of purity and age, and save the four big profits of the broker, rectifier, wholesaler and retailer. That's why Hayner Whiskey is so good and cheap. That's why it's best for medicinal purposes and preferred for other uses. That's why we have over a quarter of a million satisfied customers. That's why you should try it. Your money back if you're not satisfied.

HAYNER WHISKEY

4 FULL QUARTS \$3.20

EXPRESS CHARGES PAID BY US.

OUR OFFER. We will send you **FOUR FULL QUART BOTTLES** of **HAYNER'S SEVEN-YEAR-OLD RYE** for \$3.20, and we will pay the express charges. Try it and if you don't find it all right and as good as you ever used or can buy from anybody else at any price, then send it back at our expense and your \$3.20 will be returned to you by next mail. Just think that offer over. How could it be fairer? If you are not perfectly satisfied you are not out a cent. Better let us send you a trial order. If you don't want four quarts yourself, get a friend to join you. Shipment made in a plain sealed case, no marks to show what's inside. **Write our nearest office NOW.**

Orders for Arizona, California, Colorado, Idaho, Montana, Nevada, New Mexico, Oregon, Utah, Washington or Wyoming must be on the basis of 4 Quarts for \$4.00 by EXPRESS PREPAID or 20 Quarts for \$16.00 by FREIGHT PREPAID.

SPECIAL NOTICE. A Hayner quart is a full quart, an honest quart of 32 ounces, 4 to the gallon, whereas all other high-grade whiskies are sold in so-called quart bottles, requiring 5 to the gallon. We give one-fourth more in every bottle, really reducing our price just that much.

ESTABLISHED
1866.

THE HAYNER DISTILLING COMPANY,

DISTILLERY,
TROY, OHIO.

DAYTON, OHIO.

ST. LOUIS, MO.

ST. PAUL, MINN.

ATLANTA, GA.



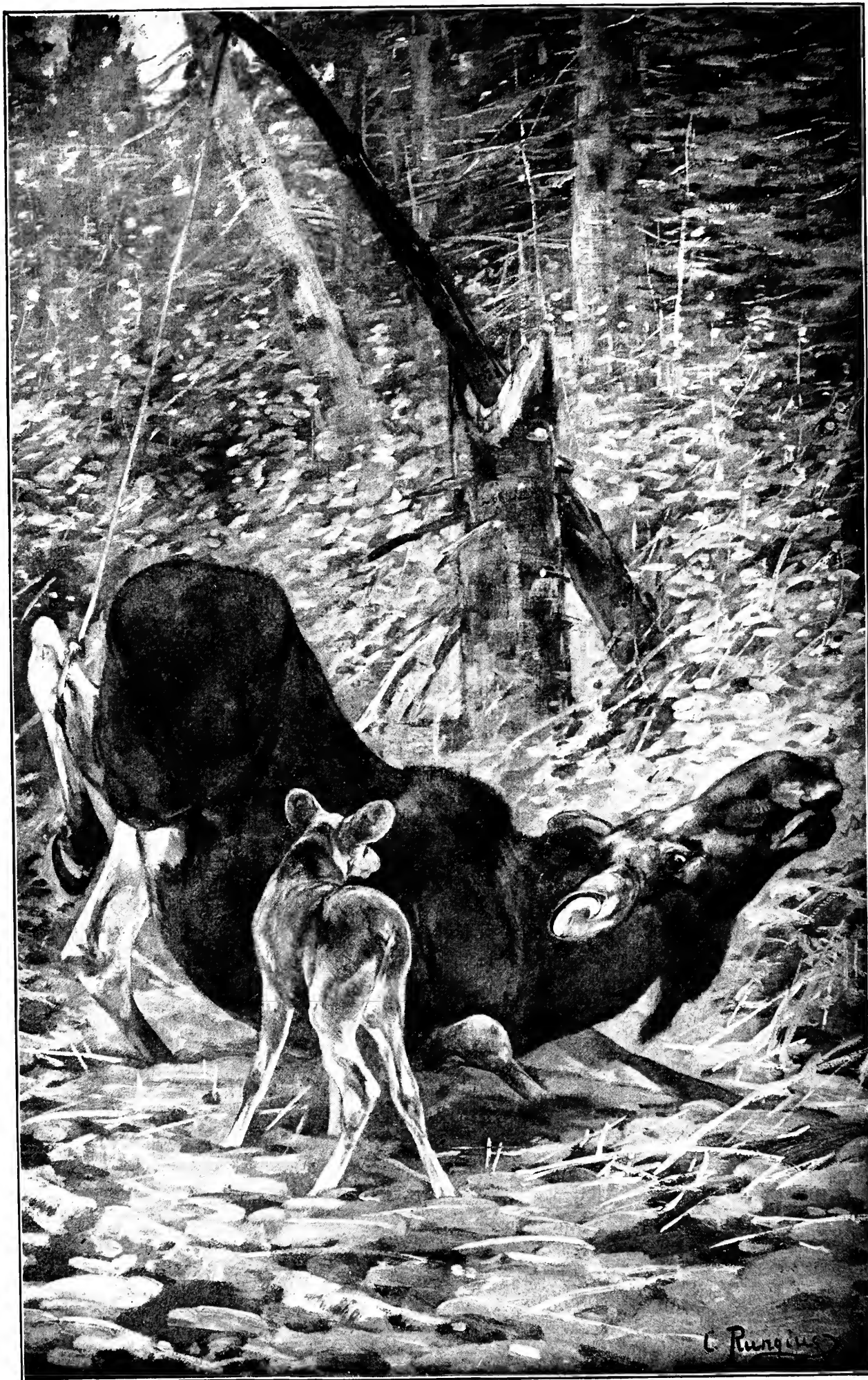

"THE CAPTIVE MOOSE IS LEFT WRETCHEDLY TO DRAG OUT ITS LIFE."

RECREATION

Volume XVIII.

JANUARY, 1903.

Number 1.

G. O. SHIELDS (COQUINA,) Editor and Manager

MOOSE SNARING IN NOVA SCOTIA.

ERNEST RUSSELL.

A noted writer on outdoor life has recently drawn attention to the fact that few of our wild animals meet death in a natural or, at least, in a peaceful manner. This statement serves but to emphasize the appalling number of destructive agencies which surround and assail every inhabitant of the woods, and demonstrates how acute is their struggle for existence. The "survival of the fittest" needs no better exposition than is to be found in the experience of any observing sportsman.

It is true that nature offsets, in a great measure, such apparently overwhelming odds against her children by a remarkable array of protective faculties, adapted in each individual to the requirements of its particular environment and developed to a surprising degree; but a realization of the myriad forces at work against the lives of all wild creatures must ultimately bring to their human antagonists a pronounced and sympathetic interest. The modern tendency toward game protection is the first ray of hope to penetrate the gloom of a relentless extermination which has been waged for centuries in the name of sport.

An authority of repute has stated in RECREATION his belief that the moose will be the last of the great deer family to become extinct in America. He relies for this optimistic view on the non-gregarious habits of the animal and on the impenetrable fastnesses of the vast territory in the North and Northwest. Let us hope

this may be so; that the moose may escape the perils which threaten him elsewhere to find in those dim solitudes true sanctuary.

The moose of Nova Scotia are well distributed over the 15,000 square miles which constitute the peninsula proper, and, though perhaps neither so numerous nor attaining such size as their brethren in New Brunswick and Alaska, they are as abundant as can reasonably be expected under the adverse conditions existing. There is no finer moose territory anywhere than exists in that Province to-day. There the moose could and should be indefinitely perpetuated, safeguarded in a true wilderness of lakes streams and boggy lowlands, intersected by long ridges, well timbered with beech, birch, poplar and spruce. It is truly a glorious country, teeming with the natural food of the *cervidae*, an ideal home of large extent, yet easily patrolled.

The modern sportsman has many sins to answer for. He is charged with the ruthless slaughter of countless sentient and freedom-loving creatures, and has even been indicted, perhaps with a measure of justice, as "the fiercest beast of prey." There is another individual who has wandered into my ken, built like a man, garbed like man, and with many of the superficial masculine attributes, yet whose real nature contrasts so darkly with that of the true sportsman that I hold him up to immediate and merited condemnation. I refer to the moose snarer in his Nova Scotian haunts.

He is the chief factor in the decrease of the moose throughout the Province. The others are hardly worth mentioning. The bear, that hangs on the flank of the forming yard to bring down an unwary calf, is really being trapped to extermination; the wolf is gone, and that oldtime implacable foe, the Indian, has given place to the equally merciless and more degenerate provincial. Occasionally the snarer is an otherwise honest and well meaning peasant, seeking but to increase a scanty food supply, unmindful of the devastation and misery he causes, or, if dimly aware of it, finding sufficient excuse in his necessity. The more sinister type is the evil outgrowth of a delayed civilization. Ignorant and depraved, with no regard for existing laws, he defies the better element of his community. Fashioned in a similar mold of criminal instincts, he is to be classed in the same category with the dog poisoner and the midnight incendiary. I know not if he ranges in the woods of Maine, in the untouched wilderness of New Brunswick or in remote Alaska, but wherever he may be I appeal in behalf of the moose, the grandest antlered animal this country possesses, for his absolute and speedy suppression. No pen of mine can fittingly describe the horrors of his hideous calling. Nothing but the actual evidence of the pathetic struggle of the captive moose can bring before one's eyes the true enormity of this brutal practice. In the apparent security and peace of the wilderness, while all else in nature is bright and full of inspiration, to meet the bloody work of this heartless outlaw is to experience an overwhelming revulsion of feeling.

It is safe to presume that the snarer lives some distance from any considerable settlement. usually just on the borders of the moose country, where he has secured a few acres of crown land and built a rude shanty.

He ekes out a poor existence, in a shiftless manner, helping at a saw-mill or working in a lumber camp, trapping a little between jobs and loafing a good deal. He tends his snares as opportunity offers, sells his moose meat at the settlement a score of miles away, and gets drunk on the proceeds. His various callings carry him frequently into the woods, where he gets many opportunities to mark the range of the moose in all their wanderings. Like Death, he has all seasons for his own. He commences operations before the summer has fairly waned and continues till the coldest winter weather freezes the rope and renders the deadly slip-noose powerless. The first warm days of early spring see him again at work, and it is only the heat of summer, which destroys his meat, that causes him to again desist for a short period. About the first of August he locates a bit of bog land, observes the runways near the adjacent streams, roughly calculates the number of moose in the vicinity, and goes to the settlement for a coil of stout $1\frac{1}{4}$ inch Manila rope. He has no use for a rifle, nor the money to buy one. With no arm but his axe he seeks the locality decided on. By the border of the moose trail he selects a hemlock, cuts off the top, to leave a stub standing about 6 feet high, with a crotch at the top. He next fells a stout sapling, 8 inches through at its thick end, perhaps 15 feet in length, trims it of all branches, and secures it in the crotch of the stub, after the fashion of an old well-sweep. He fastens the rope, which terminates in a large slip-noose, to the small end of the sweep, props up the heavy butt, arranges the noose in the moose trail, well covered in moss, with a treadle in the center. Pressure on the treadle releases the sweep and the heavy butt falls to the ground. As the smaller end rises in the air the noose is drawn tight about the moose's leg, well up, and

suspends the poor animal, either by a foreleg or a hind one, to thrash and beat about till exhaustion compels a rest. With so powerful an animal in the toils this is long in coming. The same futile effort is repeated and repeated with intervals of rest.

After spending a day of hard labor in setting up a dozen of these hellish contrivances the weary brute seeks rest in his miserable shanty. He knows that unless some fair minded man discovers the work, only to destroy it, the traps will not need renewal for a year or more. Perhaps he will replace a rotten and frayed rope with a new one, but in a general way he has nothing further to do but to visit his snares, remove his meat, reset the trap, and conceal his tell-tale tracks.

Then follows the worst phase of the whole detestable business. Your snarer is a careless, procrastinating devil, at best; and for one reason or another he may not, often does not, visit his snares for a week at a time. The captive moose is left wretchedly to drag out his life, or often her life and heavy with calf at that, through the endless hours of day after day and night after night, half suspended in the air by that inexorable rope, without water, without food, weakened by the fearful struggle, alone! Torture unspeakable! I have myself seen the fearful evidences of all this; the boggy, blood-soaked sod trampled for yards, the freshly stripped hide thrown to one side of the scene of the hideous tragedy, and half a carcass of what was, so short a time before, a noble bull moose, clawed over and revelled in by a hungry bear. In the near vicinity were discovered and destroyed 6 similar snares, all set, and hoof-marks were noted (with what pleasure!) where a running moose had lightly leaped over one of those hidden ropes in some playful midnight gambol. My companion had earlier had the exquisite if somewhat

arduous pleasure of freeing a captive cow moose, heavy with calf, from an inevitable and distressing death in one of these snares. Strapping his hunting knife to a pole he succeeded, after much patient toil, in cutting the rope, only to see the poor, half starved creature take a few weak, tottering steps and fall to nibbling the poplar sprouts a short distance from him. For some time she remained in the vicinity, as if conscious of the presence of a protector, and finally ambled leisurely away, let us hope to a region of greater security.

I have given but a brief outline of a barbarous practice, common in nearly every county of Nova Scotia. The reports of the 30 wardens maintained in the Province teem with allusions to it and its deadly effectiveness. Where it is common knowledge that moose snaring is indulged in, it is useless for the authorities to protest ignorance of it. The question naturally arises as to what Nova Scotia is doing to suppress it. The following interesting statistics from the report of the Nova Scotia Game Society for 1900 will throw a little limelight on the matter. The 12 members of the Society's Council disbursed the munificent sum of \$1,643.82 for game and fish protection during the year. In the same time a force of 37 wardens have prosecuted 6 cases of game law violation and secured one conviction, with an attendant fine of \$5, while one case is still pending.

These are the chief features of a most interesting report, covering 21 pages, and serve pointedly to answer our question.

I have the authority of an official of the society for the statement that they are pleased to have a law-abiding class of American sportsmen visit the Province in quest of moose. For indulging in the sport there is an incidental license fee of \$30. It seems proper to inquire if Nova Scotia, in

the matter of adequate protection for her game, is producing results to justify an acceptance of the invitation. Leaving the field of conjecture in the above matter, there is to be touched on, in conclusion, a phase of far greater moment.

Nova Scotia's magnificent endowment in the matter of the moose entails a duty toward her own inhabitants. Properly to conserve, protect and perpetuate her noble game to future generations, is a manifest and apparent obligation. Leaving the financial value of such an important asset entirely outside the question, there remains the debt to posterity. The Province appoints the Game Society custodian of this most important trust, and we look in vain for the best fulfilment of the duty. To legalize the slaughter of cow moose, to permit the moose snarer to pursue his calling and market his ill gotten

booty unconvicted, to expend a paltry \$2,000 a year in protecting 18,000 square miles of territory, form an arraignment difficult to reconcile with a due regard for such a priceless heritage. No just person expects any small body of men to work an immediate and general revolution among the inhabitants of a large community where the public conscience in the matter of game protection lies dormant and inert; but a widespread campaign of education and the salutary punishment of flagrant offenders would do much to awaken the people of Nova Scotia to a realizing sense of the dangers which menace her exceptional game supply. It is not too late to inaugurate this movement, and it remains for the Game Society to do it. A large audience of interested and sympathetic friends stands ready to applaud a praiseworthy energy in the matter.



PREPARING THE LURE.

AMATEUR PHOTO BY I. T. JONES

Made with Premo Camera, Bausch & Lomb Lens.

FACTS ABOUT THE BEAVER.

R. C. W. LETT.

Now that the beaver is fast becoming extinct, it is only on rare occasions that a person has a chance to study the habits of this most interesting animal. While canoeing through the highlands of Ontario recently, I came across many wonderful works by these 4-footed laborers, which I am certain could not be constructed by the greatest architect in the land, provided the same material were used. Many

a dam. A large rock stood up in the center of the creek and there the intelligent little chaps built their dam, using that rock as the middle stay, or pier.

The first thing a beaver does after choosing a site for a dam, is to fell a poplar or birch. That is a sight worth going miles to see. The work is done in a manner totally unlike that depicted in the general run of photos and sketches, in the taking and



AMATEUR PHOTO BY R. C. W. LETTS

BEAVER DAM.

Showing lake on level with head of man in foreground, who stands on a rock at back of dam.

have heard of the beaver dam, but comparatively few have any idea of what it looks like, and of what use it is to the beaver. The photo reproduced herewith shows one of the most perfect beaver dams I ever had the pleasure of seeing. A number of years ago a small stream rippled quietly through a beavers' paradise of rich, juicy poplars and birches, and served to carry off the overflow of a small lake about a mile above this dam. Now the scene is changed. Some energetic beaver, seeing a chance for a rich harvest there, picked a favorable spot for building

making of which stuffed beavers are usually employed. I had an opportunity of witnessing this, and it was done exactly in this way.

Picking out a tree as close to the water's edge as possible, the beaver proceeded to work. Raising himself on his hind legs, he rested his fore feet against the part of the tree nearest him, not taking the tree in his arms, as most illustrations picture it, but placing one foot above and one below the spot where he intended cutting. In that position the body did not, like that of the stuffed beaver, maintain a uniform



AMATEUR PHOTO BY F. I. CHÜRCH.

AN ALDER 28 INCHES IN DIAMETER DROPPED BY BEAVER ON BANKS OF SKOKOMISH RIVER.

The tree, when felled, did not completely break from the stump, so the beavers cut it off again 2 feet farther up.

thickness, but sagged toward the haunches. Then the bark flew. Soon he was through it and into the wood beneath. Stopping about every 9 bites he dropped a mouthful of chips and gave an occasional whine at a chap who had come to assist him, but which act of kindness he evidently resented.

"Now, then, look out below, she's going to fall!" Crack, crack, crash! and the beavers who were awaiting the tree's doom, to pounce on it, like darkies on a woodchuck, scattered to a safe distance till all danger was over.

"Ha! what's that, not down yet, eh?" The tree bowed low, and, as though aware of its impending doom, stretched forth its branches and caught them in those of another, which, together with the hold it still retained of the stump, hung it in mid air..

"Now," thought I, "you are done for, Mr. Beaver. Surely nothing less than a human being would have the sense to return to the stump and cut it clear but, "as I live to tell the tale," that is exactly what he did.

Returning to the stump he raised himself on his hind legs and gave 10 or 12 sharp bites at the point of cutting, which brought the tree with a final crash to the ground. To see this interesting sight I sat from 8.30 one evening till 3 o'clock the next morning, and I consider I was well repaid.

In a case where the tree is unusually large, the portion still uncut will form a mass of splintered wood when the tree falls. This the beaver knows would hurt his mouth and fill his teeth with splinters,

were he to attempt to cut it clear from the stump, so, beginning about a foot from the first cut, he sets to work and soon the tree drops flat on the ground. Then the work of cutting it into lengths of about 5 feet and lopping off the branches proceeds.

Next comes the hauling of the timber to the water, when it is back from the shore some distance. I have yet to learn how the large pieces are carried or dragged. Some old trappers say that beavers carry it on their backs, and that they carry wood from the size of a rolling pin down, in their teeth; but, as hearsay has led to many errors in natural history, I feel inclined to

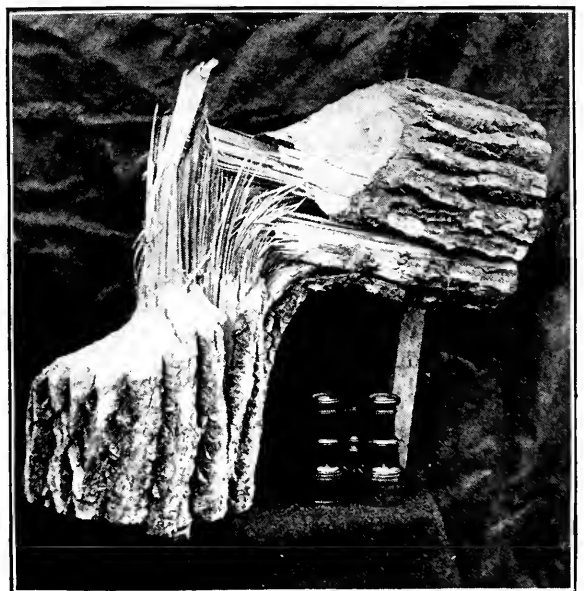

AMATEUR PHOTO BY R. C. LETTS.

SAMPLE OF BEAVER CUTTING.

believe only that which I see. I have, however, seen one beaver carry a large piece of wood by tucking one end under his forearm, and walking away on his hind legs, in a stooped position, trailing the other end of the stick behind him.

Before floating the wood and larger branches down to the dam site, the bark, which is the beaver's staple article of food, is generally eaten off, as clean as a clay pipe stem.

In our old school books, the beaver got credit for using his tail as a mason would use a trowel, but this has never been proven to be the case. No; the front feet are handier than any trowel, and the way in which lily roots, mud, etc., are handled in

conjunction with the wood, is marvelous.

As the dam progresses, the water backs up and floods sometimes large tracts of land, giving the beaver access to trees which may be dropped into the water, cut into lengths and secured in the mud under water close to their house, which is usually some distance from their dam, for their winter supply of food. As food is required, a log is drawn through an underground door into their house. When the bark has been stripped off, the log is ejected, to be used the following spring for repairing the dam.

With the help of the moon and a powerful pair of field glasses, one can pass many pleasant hours with the beaver.

BEAVER TRAPPING.

J. A. NEWTON.

The beaver resembles no other animal so much as he does the muskrat; his diet and habits being similar.

In '73 I first saw fresh signs of beavers. It was my good fortune to accompany a party to a great pigeon roost in Presque Isle county, Michigan. There was a stream near on which beavers were building a new dam, felling poplars 5 and 6 inches in diameter. An old trapper in the party told me that the framework was about completed.

"Now," said he, "smaller brush will be cut down and woven in: then they will begin sending dirt down stream, which calks the dam until it will hold water."

It was a great wonder to me that an animal should possess such seemingly human intelligence. I marvelled that they could construct a dam that would hold water and survive floods, place it where natural conditions promised the least labor in construction, and fell timber as unerringly as expert woodsmen.

The trapper and I formed a partnership, sent for a kit of traps and spent the fall there; making our headquarters in the pigeon hunters' shack. When our outfit came it was still too early for the skins to be of high value, therefore we spent the time exploring the country. Grouse were numerous and extremely tame, and it required no effort to supply ourselves with meat. We discovered 3 other dams in the vicinity of Rainy river, evidently long established. On the new dam its inhabitants were working in midsummer, but we saw no fresh sign to indicate occupancy of the old dams until the first frosts came. Then we noticed that repairs were being

made on the dams which had been injured by floods.

Labide, the trapper, said the ponds are deserted after the young have been raised in early summer. The animals travel about during warm weather; but are sure to return, if unmolested, and restore their dam. They cut poplars and willows, sinking them in the pond, and the bark furnishes food in winter. If no house is built the home is a burrow in the banks, after the manner of the muskrat. When winter sets in, the beaver is a prisoner, as it were, until the spring breakup, all feeding and movements taking place beneath the ice.

About October 15 Labide said it was time to set the traps. Double spring fox traps were used. I watched his preparations closely and listened eagerly to his remarks. He said,

"Where the water is deep enough, trapping should be done from a boat, so as to leave no signs; for the beaver is as suspicious of man's footprints, scent and other evidence of his presence as is the red fox. If the water is too shallow, as it usually is, traps must be set by wading. A beaver, like a muskrat, will leg himself if the water is not deep enough to drown him; and he is worse to hold in proportion than a rat because he must not be staked solid lest he tear away. I hitch to a chunk that can be pulled around, but big enough to keep the game from escaping."

No houses were seen except on one of the dams, where there were 5. At the base of those we set traps under water. Elsewhere traps were set under water against the bank, in excavation signs. When visit-

ing traps Labide cautioned me to approach only near enough to the bank to satisfy myself as to the result. One colony was so far away that we decided to trap it later. We caught 3 on the new pond the first night; the traps on the other ponds were undisturbed. Two of the beavers were large. I estimated their weight at 20 pounds each. The large ones were alive and lest they should tear off a foot and escape Labide shot them.

We caught 7 large and 4 small beavers in the 3 ponds. Then the remainder left the vicinity in spite of our precaution. During the next 3 days none of the traps were sprung, so we pulled them up and made for the farther dam, hoping we should find the fugitives or some of them added to its colony. We were doomed to disappointment; an Indian occupied the ground and had already caught 7. Pine martens were numerous, however, and we turned our attention to them. By placing bait in the bottom of hollow trees and other conspicuous places we caught 21 in a week.

My last trapping of beavers occurred in the fall of '89, near Manistique lake. I found an occupied dam on spring water that was still open. I succeeded in catching 2 before the rest left just before the pond froze over. I hunted over the same territory the following autumn, but that time was not prepared for trapping. An old trapper held the ground and was trapping beavers on 2 dams. In one week he caught 9, of all sizes, and eventually trapped 14. In consideration of courtesies received

he imparted additional secrets of beaver trapping.

He said that in fall, beavers may be more readily caught by the use of a mixture of oil of rosemary, one part; anise oil, 2 parts, which must be kept tightly bottled. A few drops are sprinkled on the bank just above the trap or wherever fresh signs may appear. Often this scent is placed on a piece of rotten wood and laid just above the trap. During the mating season, March and April, beavers make a deposit of musk at the different points of feeding or of leaving the water; also with each deposit of excreta. This is done to enable the animals to track their companions. Trappers, taking advantage of the habit, remove the musk gland, or castor, as it is called. Sufficient alcohol is taken in a bottle to cover the castor, which, after being dissolved, is used in the same manner as the anise mixture. Trappers do not use any kind of bait in trapping beavers except the odors mentioned.

Sometimes beavers are caught by lowering a trap into the entrance of a burrow deep under water. The trap is staked solidly and brush is thrust in the bottom near the burrow, so that when caught the animal may become entangled and drown. Beavers should be skinned open and stretched as nearly round as possible. The tail, having no value, is left on the carcass.

The capture of beavers in Michigan is prohibited for several years to come. Few are to be found at present below the Straits of Mackinac.

O' WINTER NIGHTS.

HILTON R. GREER.

O' winter nights when all the world lies
still
And ghostly moonbeams glimmer on the
hill,
With pipe to comrade me, 'tis sweet to
dream,
Wrapt in the ruddy firelight's fitful gleam,
And, dreaming, fare through old time ways
at will.
Ah! how the heart swells and the dry eyes
fill
With mists of memory that over spill,

As back I turn, up Life's too rapid stream
O' winter nights.
Then how the vibrant pulses throb and
thrill
With youth-keen ardor which nor age nor
ill
Can lessen; for again I seem
To hear the hoof beats of some smoking
team
And catch the chime of sleigh bells, sweetly
shrill,
O' winter nights.

A SUCCESSFUL FISHING TRIP.

F. HIBBARD.

What constitutes a successful fishing trip? Is it the fish you catch? Is it the getting up at 3 a. m. when you would rather sleep and wish heartily you had not promised to go? Is it the early, hurried breakfast or the starting off without one? Is it the long, cold ride or the wet grass? Is it the contents of the lunch basket? Is it the briar and bramble and wet feet? Is it the return trip? No and no. Yet you are ready to go again and have planned your next trip before you reach home.

We were up at 2.30 June 29th, Ray and Bill and I, and with the usual hurried cup of coffee, the lunch, the worms and the tackle we started. The improvised team, a mate and an odd one, were hitched to a light rig, the pole of which did not fit, and were toggled on with hay wire. The links on the heavy tugs were toggled on to the light whiffletrees in the same way. Visions of all kinds of trouble flashed through my mind. The word to go was given and the trouble began. The odd horse plied ahead and the mate plied back and refused to go. With ears laid back and cussedness in his eye he began to back until the rig was cramped against the gatepost. We all got out. It was growing daylight and there were 10 miles to go. We waited a minute, which seemed an hour. Gradually the ears of the balky horse resumed their natural position, he took a reluctant step, then 2. We yelled "whoa," and they were off. With a lively spring we caught on and away we went.

The woods, so lately bare, were clothed in green and all nature was at its best. Our cigars were lighted and we bowled along. A mile from town in an open glade a deer was quietly grazing. He knew he was safe, and after a good look, to see if we had a gun, he continued his breakfast. Down the long grade we went at a lively gait, crossed the stream and climbed the bluff past the deserted houses of the old Caledonian mine. The Flint Steel valley lay below us on the left, grandly beautiful in the morning light, and rocky bluffs rose high on our right.

Greenland was reached and left behind asleep, and we plunged into the woods again. We were shivering with cold but anticipation stirred our blood as we neared the end of our trip, and 5 o'clock found us at the high trestle where the Mineral Range road crosses the stream.

We put up the horses in an old shack

by the roadside, rigged the tackle with fingers so cold it was difficult to string a squirming worm on a hook, and plunged into the wet woods and grass, each trying to score the first fish. The brush was so thick I had to trim the knots off my rod in order to draw it after me endwise. I stumbled over logs and snags. My hook was fast in a snag at the bottom and then in a bush overhead. I was wet up to my knees, I had a stick in my eye, a bug in my ear, and several mosquitoes on my neck, but I was having fun, had several bites and got one or 2 small trout. Then I wondered how many the other fellows had. Ever just behind the next bend, a little farther up, seems to be a better place. I tore through the brush and over the logs, I slipped, slid and stumbled to get ahead of those other fellows. I was no longer cold. My collar was wilted and my shirt was up my back. I was getting hungry, but I was having fun.

At last I found time to look at my watch and it was 8 o'clock. Great Scott! I thought it was almost noon! The folks at home were not up yet and my breakfast would not be ready if I was at home. I seated myself on a log, lighted a cigar, baited my line in the pool, wondered "where I was at," and how far it was back to the wagon. It would not do to let the other fellows beat me! Desk and business were forgotten. Troubles of yesterday and of tomorrow cut no ice. The change of scene had cast its spell and I did not care whether school kept or not.

I impaled another struggling worm and tried for that big one I had not yet caught. For an hour more I fished industriously for count, and then made a break for the wagon. As I crashed through the brush I wondered how I ever got there and how far it was back.

I found things as I left them. We ate lunch, lighted our pipes, counted our fish and for an hour lay on the grass, rested and compared notes.

The afternoon was passed in much the same way only not in such a hurry. To be tired, hungry and to reach home are the 3 things essential to a successful hunting or fishing excursion. One trout that weighs a pound and 19 more that weigh another pound make a proud and happy angler. He has planned another trip for the earliest possible day. Who says it is not a success?

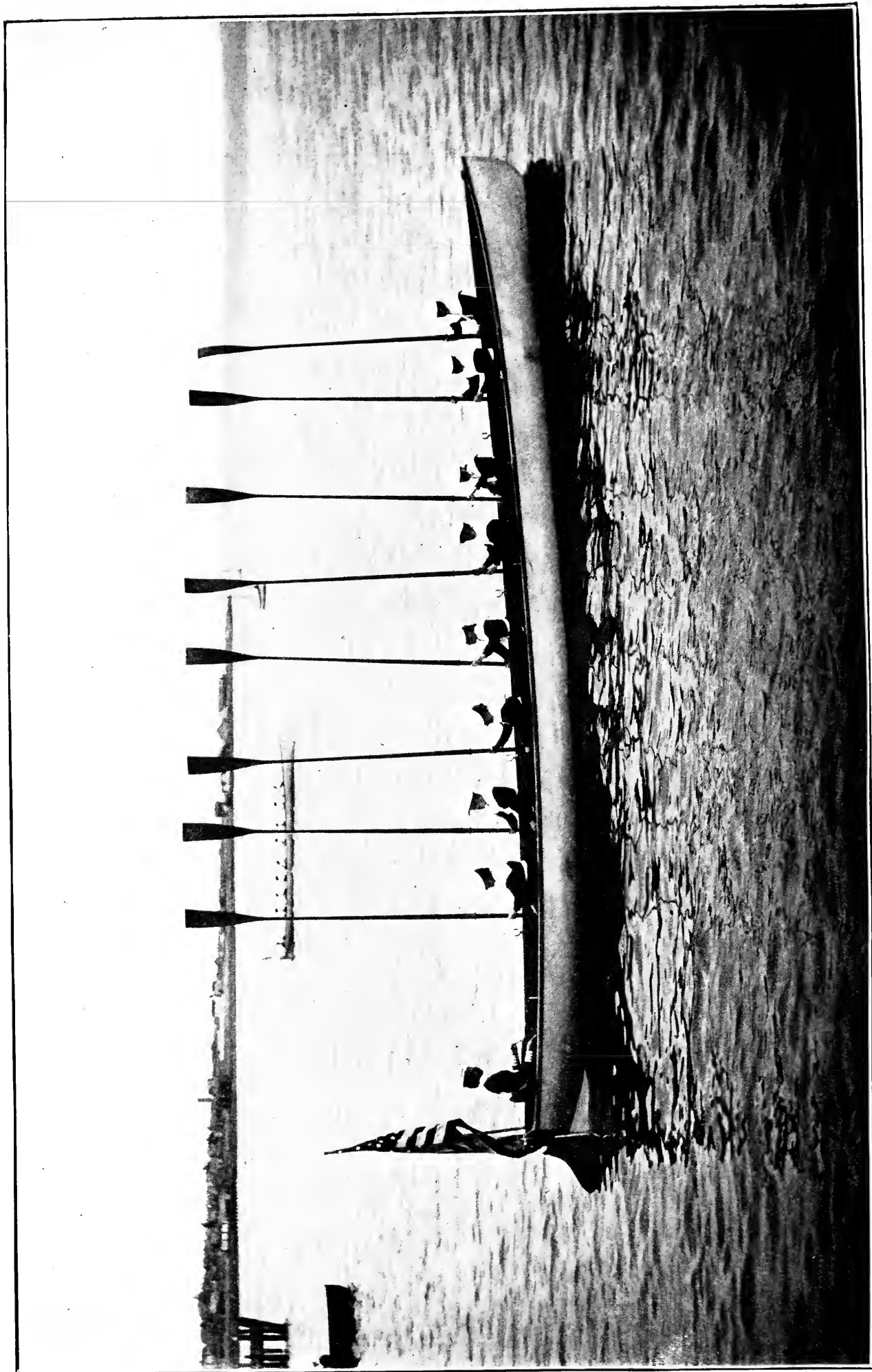

THE SALUTE, "TOSS."

A GIRLS' BOAT CLUB.

LAURA WESCOTT.

San Diego is a natural center for aquatic sports. The bay on which it is situated rivals that of Naples in beauty of surface and surroundings, and surpasses it in safety. Young women have not been slow to avail themselves of the splendid opportunity San Diego bay affords for rowing. About 10 years ago plans for systematic rowing were adopted. Before that time women's crews were unheard of, while to-day San Diego is the home of some 20 such organizations.

The State Normal school of San Diego was organized in November, 1898, and the young women of the school at once became intensely interested in rowing. They adopted it as the out of door physical training, which should receive their greatest attention. In January, 1899, they organized themselves into a rowing association, which still shows the greatest activity. The association is composed of 5 complete crews which row in its 8 oared barge, the *Pristis*. Each school day a crew, composed of 8 girls and a captain, has its regular practice row about the bay of an hour and a half or 2 hours, for the exercise and drill; and at special times rows of 6 to 14 miles are taken. The officers of the organization are commodore, Miss Laura Wescott; secretary treasurer, Miss Laura Fenton; business manager, Mr. J. F. West. These officers and the captains of the various crews form the executive board. Each crew of the association has its captain, name and colors. The champion crew is composed of the 8 girls who have proved themselves the strongest and most skilled rowers among the crews, and is commanded by the commodore.

At the time appointed for practice row the girls assemble at the club house, don their loose, comfortable sailor blouses, and stand by to await the captain's orders. The barge is hoisted to its place under cover by means of block and tackle, and with the order "Stand by to let fall the boat" numbers 1, 5 and 8, managing the tackle, lower the boat into the water. As the captain gives the order "Man the boat," the girls slide down the ropes and take their places; and with the orders "Stand by your oars," "Up oars," and "Let fall," all is in readiness to push off. Then as the orders "Stand by" and "Give way" are obeyed the crew is off on the water. When several crews are out at the same time and meet one another the salute is "Toss." With the orders "Stand by to toss" and "Toss" the oars are raised altogether in an upright position, the captains salute, and after a chat the row is

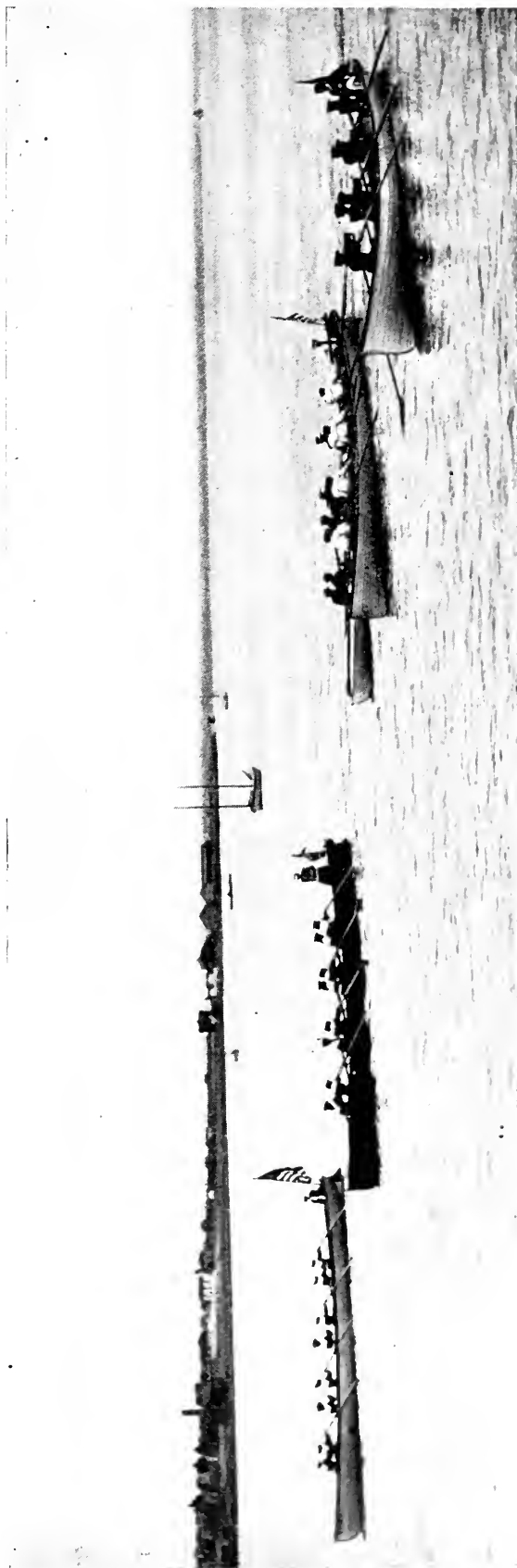

THE FLEET.



“STAND BY.”

continued. The discipline and evolutions on the regular rows are in every way similar to those of the barge rowing of our navy. A pleasant part of the row is the “hand out,” an appetizing luncheon, after which the oars dip with renewed energy. On the return to the boat house the Pristis is hoisted to her position and the ropes are coiled.

With few exceptions the girls of the crews are enthusiastic swimmers and do much rowing in an ordinary 2 oared boat. The fascination of the sport is great and the girls regard the rowing as valuable physical exercise as well as pleasant recreation. At the end of a season they find the muscles of the whole body healthily developed and firm; and they look on life in general with zest.

It has not been the custom to do much racing on San Diego bay, but from the first organization of boat crews there have frequently been tests of skill, and for the championship beautiful and costly prizes have been given, usually flags, pennants, etc. At the 4th of July celebration, 1901, the 4 8-oared barges of the bay, manned by their respective crews, entered into competitive drill, the order of evolutions being regulated by the officers of the U. S. S. Ranger

and the signals given from that ship. This was one of the most interesting exhibitions ever given by the girls' crews. Similar evolutions are a feature of rowing when different vessels are in port.

Quite as important as the discipline of the crews is the social side of the life. An ingenuous method of obtaining money to defray the expense of keeping up boats, buildings, etc., is giving entertainments and private theatricals. These always, of course, prove successful, and afford not only the needed funds but the amusement of preparations and rehearsals. Association and crew parties and dinners are also a part of the social life. For barge parties, on moonlight nights, some point along the bay is selected for landing, guests are invited, and a bountiful luncheon is prepared. On landing, material for a bonfire is collected, coffee made, and often fish or the like roasted over the fire. Then when supper is over, all join in games, story telling, or other features of the evening.

Thus the rowing association ministers to the whole woman, developing the physique, affording mental as well as physical discipline, and offering the recreation, social diversion, and good fellowship so much needed by the busy student.

“What would you say,” began the voluble prophet of woe, “if I were to tell you that in a short time all the rivers of this country would dry up?”

“I should say,” replied the patient man, “‘Go thou and do likewise.’”—Christian Register.

A HOLIDAY HUNT.

J. O. LANDER.

In 185— my friend H. and I. were invited to spend Christmas week at the home of Mr. E., a substantial farmer living in Southwestern Kentucky, and to participate in an annual deer hunt.

Christmas morning we ate breakfast at Mr. E.'s by lamplight, and by the time we left the table our hunters were saddled at the door. A brisk ride of 2 miles in the crisp air and we pulled up at the ideal Kentucky country home of Squire C., who was to lead the hunt. The Squire gave us a cordial welcome, and was much interested in my rifle, which had one of the few Remington barrels then in existence. The other members of the party were equipped with the old long Kentucky rifles, and we all carried powder horns, hunting pouches, ammunition and sheath knives, for those were the days of muzzle loaders.

After presenting us to the ladies of the family Squire C. gave the order for us to mount at once. This was promptly obeyed, and with some 20 others who had arrived we were shortly on our way to the first drive, 3 miles distant, the Squire and Mr. E. at the head of the column and the well trained hounds scouring the thickets in front, being kept together by the sound of a horn in the hands of the Squire. I had never before participated in such a hunt and Mr. E. had promised to instruct me. Soon he dropped back to my side and as we were riding through a thicket along a narrow wagon track he halted, dismounted and told me to tie my horse beside his. We walked to the edge of the thicket and came on an old field, of probably 10 acres, from which the fence had been removed. Thirty feet from the thicket, in the field, stood an old peach tree, and Mr. E., stopping me at it, said:

"This tree is not a first class shelter, but as you have a good gun and can reach any part of this old field we give you this stand. The dogs will start in at the upper end of the thicket. The deer always come out of the thickets by one of their regular runs or paths and they have several out of this, one of which is opposite this tree. Get behind the tree and raise the hammer of your rifle so as to be ready if the deer come out here. Then remain perfectly still, as the least noise or the slightest motion will turn the deer back—"

A series of short, sharp yelps, followed by the long, deep bay of a hound, interrupted him. Listening a moment, he said: "That is those fox hounds, but Trail will settle them. He says deer are in there and I must get to my stand. Remem-

ber, no motion or noise," and he left me.

I was still enough for a while but the air was sharp and about an inch of snow had fallen that morning, so my feet began to ache with cold. I looked about to see where the others were stationed, but no one was in sight; nothing but the bare, and it seemed to me increasingly cold, field. I began to think my feet were freezing. I had just convinced myself that in the edge of the thicket was a better place for me and was about to go there when a change in the tone of the dogs caused me to remain where I was and forget the cold. Then came a crashing of brush, blasts from the Squire's horn, baying and yelping of dogs and loud halloos of human voices intermingled. The crashing of brush in the thicket grew more distinct until I could trace its course by the sound. As it was apparently approaching me, my every sense was keenly on the alert, I was oblivious of all other surroundings and I had entirely forgotten the cold. My whole being seemed absorbed in that rush. Still on it came, with ever increasing sound, down through the center of the thicket, and finally it passed me. Glancing around I saw many of the hunters skirting the edge of the field and yelling with all their power. I took a step forward, when "Keep your stand!" "Stand by the tree!" came from a dozen of them, and again I took my position, but every man had disappeared as if by magic. Then the crackling brush again became more distinct. My rifle was at my shoulder and my eyes felt as if they were coals of fire, through my efforts to see into the dense thicket. At last a movement of the brush, then a magnificent buck, followed by a doe, sprang from the thicket into the open directly in front of and not 30 feet from me, headed to the left and checked their speed to look about. In an instant I had a bead drawn just behind the left shoulder of the buck and pressed the trigger. It was the best mark at game at close range which had ever fallen to my lot, but for the first and only time while I owned her my rifle failed to respond and both of the deer sped away across the field. With both hands I raised my rifle above my head to dash it to the ground, but catching sight of the deer I again threw it to my shoulder and fired at long range, but my aim was high. The buck made one or 2 desperate springs and was again in the brush. Then the dogs came out of the thicket, the bloodhound in them intensified by the chase, and that

peach tree was too small to satisfy me that it would shield me from their sight and attack; but they passed me at an increased speed, with noses to the ground, until entering the brush, when again one of them gave 3 peculiar sounds and all were again lost to sight. Then the hunters came riding into the pen and surrounded me.

"Where is your deer?" asked the Squire as he rode up.

"Gone off into the woods," I answered.

"Didn't you fire "

"I did."

"Where did the deer come out of the thicket?"

I pointed out the place, and I noticed that most of the men, especially the younger ones, had all they could do to keep from an outbreak of laughter. I then explained the failure of the cap to explode and where the deer were when I did fire, adding that my hurried aim was too high.

"Go and see what Trail found," said the Squire to one of the men, and again turned to me.

"Where are the dogs?" he asked, and there was a suspicious twinkle in his eyes.

"Gone after the deer."

"Why did you not stop them?"

Just then I caught sight of H., who, like the other young fellows, was doing his best to keep his face straight, and I replied:

"Well, Squire, I had no instructions to do so, and I don't mind saying that I know so little about bloodhounds I am not sure I should have tried it if I had been told to."

"So you let them go by and probably have ended our hunt for to-day," said he. Just then the man he had sent forward returned and reported, "Two or 3 flecks of red, but the tracks beyond are long and regular."

The Squire's horn was at his lips in an instant and I learned for the first time the tremendous capabilities of a well prepared ox horn when blown with vigorous blasts; but the Squire's utmost efforts failed to change the cries of the dogs, which were constantly becoming more and more faint, so the drive was at an end for that day.

I commenced expressing my regrets when the Squire interrupted:

"The fault is not alone with you. I promised to give you instructions but forgot to do it, so my older neighbors must blame me for the disappointment; but you will have to hoe your own row when the young people get you to themselves, and I don't envy you the experience."

When we entered the house most of the young ladies of the entire region had

gathered there, and all were curious to know why we had returned so early. On our way there H. had told me the young fellows had agreed that as I was a stranger they would let me down easy. That did not suit me, so when the young ladies asked the cause of our early return I told the story and I did not spare myself.

The Christmas dinner defied description and I shall not attempt to say more than that it seemed to me every known edible formed a part of it. There for the first time I had a taste of Kentucky crab cider, which is made by freezing and thawing crab apples twice before grinding them and pressing out the juice. It is delicious.

After an early breakfast the next morning I was placed in charge of one of the young hunters, a son of Mr. E., my stations for the day being next to him, but I had improved the time to get posted as well as I could. We took our places on the edge of a big road for the first drive of the day, but the dogs found nothing in it; so mounting our horses we rode leisurely toward our second stations. Soon my companion, who had been listening to the dogs, said excitedly:

"There they go, with us a mile from our stands! We must ride for it," at the same time dashing ahead. He had the best traveler, and called back to me, "Two adjoining stands empty and the dogs on a hot trail won't do. Follow this track," and he turned into a little used wagon track leading off to the right of the road. Finding that I was losing ground I soon left the track, which had many curves, and headed straight for him, jumping my horse over logs, brush piles, etc., which lay between us; and when our stations were reached I was with him. We had just taken our positions when a large buck sprang across the wagon track close beyond me, but Mr. E. was at that stand. The buckshot from his gun cut the throat of the deer neatly and it fell dead.

We hurriedly dressed the deer, hung it to the limb of a tree and soon all were on their way to their stations for the third drive. At my earnest request Squire C. reluctantly consented to let me follow the hounds with him in that one, saying he would be glad of my company but feared I would find the experience worse than freezing my feet on a stand. He rode a large gray hunting mare that for a time seemed to me to take things remarkably easy, the Squire not touching the bridle which lay loose on the pommel, the mare taking her course by the sound of the voice of the hound Trail, while the horn directed the course of the dogs. The first half hour, as we rode along engaged in pleasant conversation, I thought following the hounds a great improvement on

occupying a stand; but about that time the dogs jumped, the Squire's old hunter pricked up her ears, lengthened her stride and increased her pace. I attempted to keep up gradually, but fell behind. Finally I brought up in a tangle of grape vine and brush. I tried to back out, but I was also in a bed of green brier, so my horse could not back. I was obliged to dismount and cut my horse loose with my sheath knife. When I mounted again the Squire was out of sight. I pulled my hat down over my eyes, gave my horse the spur and leaning forward headed for the sound of the horn at the best speed my horse could make. Finally I came to an opening and discovered the Squire about half a mile away, his old hunter standing still, with 4 or 5 of the other men and some of the boys near him. An occasional blast on his horn to recall the dogs warned the men that the drive had been traversed and the deer had escaped by a run which had not been guarded.

"You must have found following the hounds even more rough than I expected, but are you seriously hurt?" said the Squire as I rode up.

I had been intent on catching up with him, but his question and a smarting sen-

sation as I halted caused me to look at my hands, then another twinge at my thigh, and finally to make a general examination. My hands were scratched and bleeding all over; I had a gash in one thigh 3 inches long and half an inch deep, probably made by a thorn bush I had dashed through; and numerous other wounds. There were many holes torn in my clothing, but my face was all right, thanks to my heavy, wide brimmed hat. The hat itself was badly ventilated for winter weather.

My wounds were rubbed with whiskey and the largest were pressed together and bound with a few strips of sticking plaster.

The weather looked threatening and the hunt was abandoned for that day. We spent the evening cheerfully around the great wood fire, and on retiring, a thorough rubbing with whiskey left me in good condition for the next day. However, a long rain had set in and the drive was over; but not our holiday. A lot of young people gathered and in the different homes of the region, where we were always given a royal Kentucky welcome, we spent the remaining 3 days of our vacation most joyously. Notwithstanding my somewhat rough experience in the drive I shall always remember the incidents of that holiday week with greatest pleasure.

ROUND THE CAMP FIRE

A. L. VERMILYA.

Pile the fagots high upon the roaring camp
fire,

While we tell the story of the wildwood's
joys;

Here the sky is clear, the air is soft and
balmy,

And we hear no echoes of the city's noise.
From the thicket's depths the whip-
poor-will is calling,

And the streamlet sings along its
cheerful way;

While above us, in the breeze,
Sway the branches of the trees,
Where the birds await the coming of
the day.

Pile the fagots high upon the gleaming
camp fire

While we smoke our pipes, and tell the
story o'er

Of the game we bagged upon the hills or
moorland,

Or the fish we landed on the pebbly shore.
Then we'll sleep, and dream of pleas-
ures for the morrow;

Sleep and dream while lullabies the
cricket sings;

Till the cool night wears away,
And the shadows dim and gray
Flee before the light the rosy morn-
ing brings.

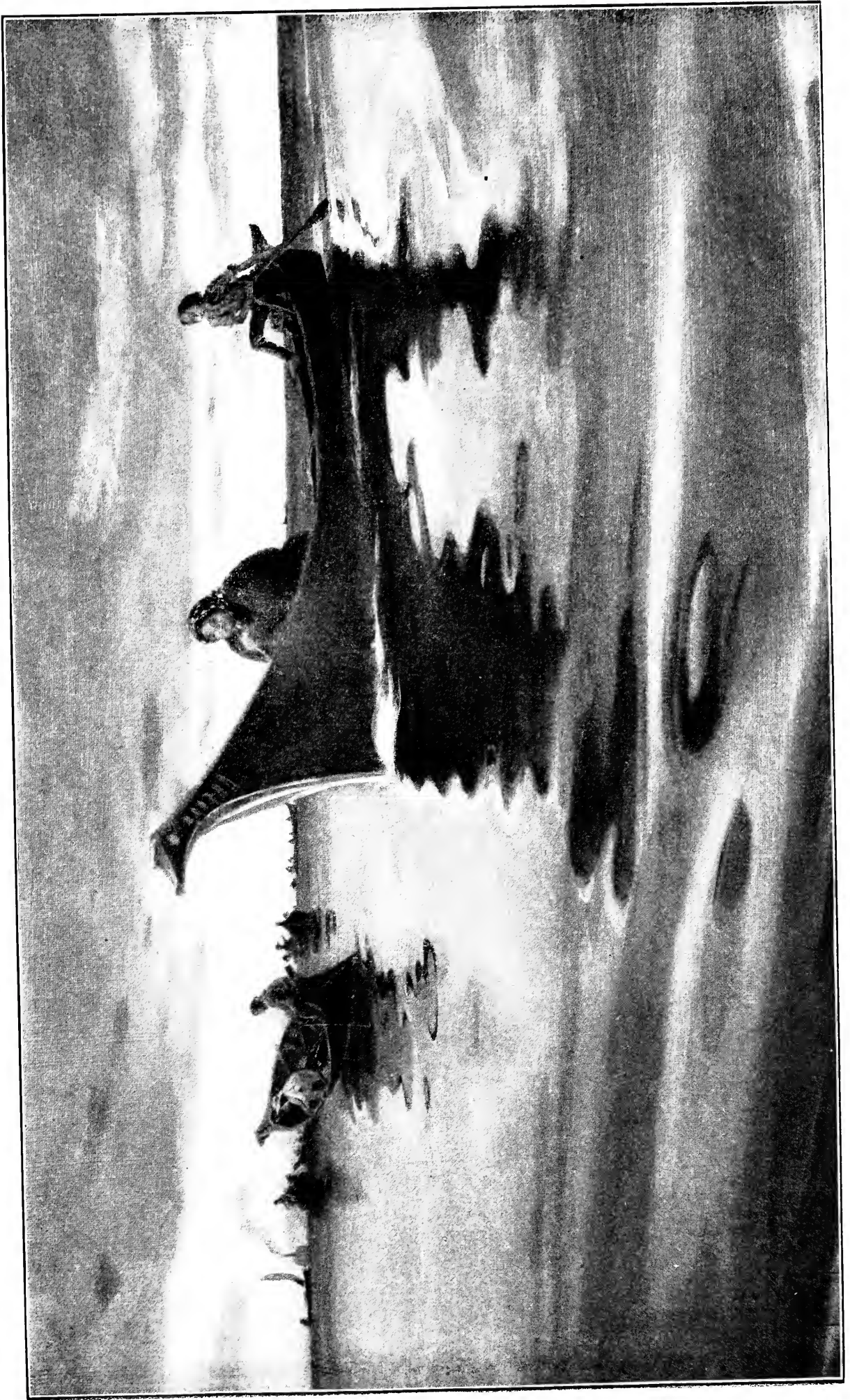

HERE COMES OLD JACK PERCHED IN THE STERN OF HIS CANOE.

TYEE SALMON IN PUGET SOUND.

J. H. BOWLES.

My piscatorial brothers of the Catalina islands, fresh from battles with the yellow-tail and the tuna, will probably scoff and raise pitying eyebrows at the idea of fishing for such small fry as the tyee salmon of Washington. Nevertheless, about the last of May I am well pleased to have my Siwash Indian friend, old Jack, come to me with the information, "Tyee running at Point; no herring." Translated, this means that the spring run of salmon has reached Point Defiance, and that the herrings have not come, so it will be necessary to take some for bait. I never use bait, but for 5 years the old fellow has been tireless in his efforts to convert me. I drop into a store and buy him a package of tobacco, when he says good-bye in high good humor.

Point Defiance, about 7 miles from Tacoma, Washington, is a long arm of land stretching out into Puget sound, which at that place is a beautiful sheet of water about 3 miles wide. It is a most picturesque spot, the clay and sand cliffs rising abruptly 200 feet over the water; and towering skyward from the top are giant cedars and firs, some of them 300 feet high. Around the foot of the cliffs the tide rushes like a mill race, forming whirlpools and back eddies, the latter running close to shore, often for over a mile. Deep down in these eddies and close to the whirlpools the tyee (Siwash for chief) love to lie in wait for their favorite food, the herring; the water being ice cold and 75 to over 500 feet deep.

It was in one of these back eddies that B. and I were to be found one warm afternoon in May, 2 hours before sundown. Our outfit was a cedar skiff, a 7-foot salmon rod weighing 11 ounces, a reel holding 600 feet of line, a gaff, a short killing club, and 3 or 4 varieties of darting spoons. The darting spoon seems to be a creation of the Pacific Northwest; at least I have seen nothing exactly like it elsewhere. It is a single thin piece of copper, brass, or silver, about 5 inches long by 2 inches wide, cut in a narrow oval. It has a peculiar series of curves and does not revolve, but zigzags in all directions when drawn through the water. A single hook is riveted into the end and about 3 feet of wire snell are used, with a swivel at each end to prevent the line from kinking. Some anglers use double or even treble hooks. A keel-shaped sinker weighing about 7 ounces is used, which is arranged to slide along the line by 2 screweyes. Its proper position is about 30 feet up the line from the spoon,

where it is held in place by a wire catch that is set in one end in a line with the screweye. The strike of the fish releases it, when it slides down to the snell and allows a free line for play.

Thus equipped we rowed slowly along the eddy, just fast enough to keep the spoon energetic at the end of 100 feet of line. We carefully watched the surface of the water in all directions to see if the tyee were rolling, and we rejoiced that the water was unbroken. At certain times these fish all come to the surface to play, rolling their backs and tails lazily on the surface. On such occasions the angler can paddle within a few feet of them, but he might just as well pack up his tackle and go home, for he can not catch anything.

It was early in the day for tyee, but soon a fierce jerk told us a fight of some sort had begun. I reeled in the line as fast as possible, apparently without even the spoon at the end, but we well knew that was only one of the tricks of the silver salmon. This fact was proved a few seconds after the strike, when close to the boat a glistening 12 pounder leaped high out of the water and tried to shake the hook from his mouth. Failing in that, after several attempts, he twisted and turned over in the water so rapidly as to soon tire and allow himself to be brought to gaff. The line was wound 3 or 4 times around his gills, but a few raps with the killing club quieted him and he was then untangled. Very handsome he looked lying in the boat, and he made a swift, gamy fight for 10 minutes, but we were after something different.

We put out the spoon again and soon a short tug, followed by a spirited fight far below the surface, brought to light a 5 pound rock cod. His bright red color and gaping mouth gave him the appearance of being much heated and out of breath from his exertions.

Still hope was deferred, but undismayed we again lowered the spoon and a few minutes rowing took us over where a sand bar stretched far below the surface. In passing this the spoon seemed to catch on the bottom, an accident which almost invariably means the loss of spoon, sinker and a portion of line, not to mention a frightful loss of temper. Fortune favored us that time, for a steady strain showed a gain of 3 feet of line, which continued until a long dark body appeared in the clear water below. It was one of the big brown cod of Puget sound: but as soon as he

saw the boat his tail pointed upward and down he went, like an iron safe. That style of fighting continued about 25 minutes, until finally his codship was brought to gaff, both fish and angler about equally exhausted. Nineteen pounds, over 3 feet long, with an enormous mouth fringed with teeth like those of a bulldog, the brown cod is, nevertheless, the finest food fish in those waters.

By that time the sun had nearly reached the horizon and the Indians were around us in their canoes. There was old Jack, perched in the stern of his canoe, on a pile of large rocks that barely offset the weight of his enormous squaw in the bow, incidentally the fattest human being I ever saw out of a circus. They formed a truly remarkable contrast, he being mere skin and bone. In these cases the squaw always does half the paddling, while the man does all the fishing.

For half an hour or so we rowed slowly along, watching the kingfishers and guillemots retiring for the night to their holes in the cliffs, and finally becoming completely absorbed in watching the onslaught of a flock of crows on a pair of bald eagles, whose nest was in one of the giant firs. Suddenly the rod was almost jerked out of my hand, the tip was pulled deep under water, and the reel buzzed angrily as its handle removed the skin from one or 2 of my knuckles. Fifty feet, 75, 100, 150, and still the line went out. This is no silver salmon or cod, for no fish in the sound but the tye is capable of such continued bursts of speed. Gradually, however, the strain of the little rod begins to tell and 50 feet of line are regained, when the reel handle is jerked out of my hand and he is off again on another 150 foot race. Nearly 400 feet of line are out, but I fight back, inch by inch, until my fish goes to the bottom to sulk and try to jerk the hook out of his mouth. This is the most trying time of all to the angler, for the mouth of a salmon is tender and will not stand much snubbing. However, if he keeps this up he will certainly tear loose, so I gradually force him to the surface, which gives us a view of his broad green back with its black mottling. The first sight of the boat sets him frantic and he is off again on another series of rushes, this time so close to the surface as to make the line sing through the water, thus forming with the whirring of the reel the most charming of all duets to the ear of an angler. The fight is on again for the same length of time as before, but finally he tires and is brought to gaff. Still shaking his head, after a grand battle of over half an hour, he is taken into the boat, 22 pounds of the gamest fighting fish in Puget sound.

The sun having set, all the other boats

caught fish as well as ourselves. The Indians use herring and a hand line, for they argue that a rod in such cases is white man nonsense and a criminal waste of time. However, we were both anxious to waste another half hour in the same way, so over went the spoon. That time only 2 minutes passed before the tip of the rod was jerked under water, and the handle of the reel tried to resemble a circular saw in action. The fight was a repetition of the last one until, apparently tired out, the fish was brought within 100 feet of the boat. Then, as if possessed by the Furies, he dashed away with 200 feet of line and came to a sudden stop. I reeled in the line with nothing but dead weight at the end, and we lifted from the water the remains of a handsome salmon. He was torn into shreds, and looking down into the water we saw a school of dogfish.

It was necessary to row a few hundred yards to get away from them, and preparatory to setting the sinker I tossed the spoon over with 3 or 4 feet of line. We then examined our mangled captive, before starting in to fish, and he proved an interesting example of dogfish voracity. The clean cut bites gave a good idea of the sharp teeth of this little shark. An unexpected interruption came in the shape of a great splash under the stern of the skiff and I threw out the sinker just in time to avoid a broken line. Another fight and a 15 pound tye was brought to gaff.

It was then dark and a succession of short jerks on the line showed that nothing but dogfish were to be caught. This was amply proved as out of the darkness we heard an Indian gaff a fish, then the thud, thud, thud of the killing club, and lastly a splash followed by an avalanche of Siwash profanity. Not a thing could be seen, but the whole scene was before us as plain as day, for we knew that such is the love bestowed on all dogfish by the Indians.

The tide being in our favor, we paddled lazily back to the camp. The possibilities of this kind of fishing form one of its many fascinations, for the angler never can tell what may take his hook. Some days he will lose nearly every fish that strikes, while on others he will make a clean record. Nearly everything from a rock cod to a bull seal has been known to take a spoon, and tye as heavy as 75 pounds have been taken on the hook. Mr. P. V. Caesar, of Tacoma, met with an exciting experience when nearly all of his 600 foot line was taken out at one rush by some unknown monster of the deep, only to have it tear loose at the end. Realizing that he must check the rush at all costs, he applied a heavy drag to the reel and then gave the butt, which resulted in the loss of the fish,

A FLORIDA KID ON A CAMP HUNT.

CHARLEY APOPKA.

PART VII.

Next morning pa woke me up soon, an as soon as we'd et a snack, an' put a couple of biscuits apiece in our pockets, we lit out fer the traps, an' we was aimin' ter move our line some'rs else, but we had more in 'em than we'd ever had at one time. First trap we come to, there was a big ole ring-tail in it, awaitin' fer us, an' he weren't in no good humor neither, but pa told 'im howdy with a light'ud knot, an' we snatched 'is pelt of in a minnit. We decided not to move that trap, seein's it was doin' so well, an' as it was clost ter where we caught our trap bait, I got a handful of worms outen a dead tree an' we went down ter the branch an' got our little poles outen the bushes an' went ter fishin'. I reckon I've said it a dozen times before, but it shore was fun a snatchin' them perch out. I caught a little catfish, an' he were the most wiggle-some thing I ever seen. It tangled my thread line up so bad I had ter throw it away, an' I got worried with 'im an' tried ter mash the stuffin' outen 'im, an' struck one of 'is horns in my thumb, an', doggon my cats, how it hurt. I throwed 'im on the ground and give 'im a stomp that fixed 'is clock, an' by that time we had enough, for pa'd jest been a slingin' 'em out while me and the catfish was a havin' it.

The next trap had another big coon in it.

"By grannies," pa sez, "at this rate we'll soon be loaded down with hides."

The first 2 otter traps weren't sprung, but the third one had a big, fine one in it. We could hear the chain a rattlin', an' the water a splashin' soon's we come clost to it, an' I never seen nothin' no fiercer'n that old otter. He'd grab the trap in 'is tushes an' chomp it like he was goin' ter eat it up. Pa said it takes a mighty good dog ter whip one, fer their hides so loose they kin turn plum around in it, an' a dog kaint git no holt. Pa done 'im like he done the coons, an' throwed 'im over 'is shoulder, an' we went on till we come to where we had a trap set in the dry sand on the bank where the otter had been a wallerin'.

The trap was sprung, and the ground jest natchelly tore up. There was one toe of an otter in the trap, jest fresh gnawed off, an' the water was still roiled up where he'd entered the branch.

"Dad buzzle it all," sez pa, "if we'd a been 5 minutes sooner we'd a got 'im, but it ain't no use ter cry over lost otters nor spilt milk."

We pulled up the trap an' set it in another

place, fer pa said it ud be a long time 'fore they wallered there again.

We was agoin' acrost from one pond to another, an' we seen something runnin' through the grass an' a shakin' the weeds, an' we took after it, and doggone if it weren't 3 otters. They kaint run so powerful fast an' pa knocked one in the head with a knot, but the other 2 tore out for the nearest pond, an' you couldn't no more head 'em than nothin'. They was jest simply bound an' determined ter git in that water, but jest as they was a gittin' in a bunch of tall grass in the edge of the pond, I turned my old single barrel loose an' killed one, an' the other got away. We was shore proud, an' I wouldeen fool yer. We hung the 3 of 'em in a little thick oak out of the sun, an' went ter the balance of the traps quick's we could, an' we got 4 more coons, and 2 'possums, which we turned loose.

"If this keeps up," sez pa, "we'll be rich as Jews."

We went back to the otters and pa showed me how to start the hide, an' I cased one while he was a doin' the other 2. It shore is a job, fer every bit of skin has ter be worked off with the knife, an' if you ain't mighty keerful, you'll cut holes in it, an' ruin it. It was one o'clock 'fore we was done, an' I was nearly faint I was so hungry.

On the way back we went by a little slough, an' there was the biggest bunch of white curlews I ever seen, a feedin' along the edge of it. Pa sez:

"Slip up to 'em, son, an' see'f you kaint kill us a mess at one shot."

I crawled on my all fours through the grass, an' got right up on 'em. I laid there a minute a watchin' 'em, an' it was a right purty sight. They was a walkin' about in the mud an' water, a drillin' down in it with their bills after crawfish, which they seem ter love bettern anything else. Anyway their craws is always full of 'em when you kill 'em. They was all the time makin' a fuss amongst 'emselves like they was a talkin' ter one 'nother. All of a sudden one old feller seen me through the grass, an' sez "onk, onk," an' the whole bunch riz up together, an' such another battin' of wings I never seen. I laid flat in the grass, but bein' up in the air they all seen me an' I knowed it was now or never. So I jumped up an' aimed inter the thickest of 'em, an' shot down five of 'em, but I'm satisfied if I'd a scored into 'em on the ground I'd a got 20. We cut the meat offen

'em an' pulled out fer camp, an' we killed 11 poterges in 3 shots, on the way back.

Uncle Dick an' Mr. Sam had a lot of fried pertaters an' about 40 perch a keepin' hot fer us in the skillet, an' I'm here ter tell you they was shore good. After dinner pa stretched the otter hides on some boards he had fixed fer the business an' I tended ter the coon hides. When it come dark we cooked up our birds an' made some biscuit an' had another fine mess. Livin' in camp's the best livin' in the world. While we was eatin' the curlews, pa said to Uncle Dick:

"Do you remember when we was boys, an' slipped up ter that big bunch of curlews in the hammock perairer, an' never got none of 'em."

Uncle Dick laughed an' said:

"I cert'n'y do."

When they was boys, they was a marsh pond with a fringe of hammock round it, clost ter their home, an' it was called the hammock perairer. One day they was a terrible big bunch of curlews a feedin' along one side, clost ter the bushes, an' they took their guns an' went after 'em. Right next to where the curlews was a feedin' they was 2 trails went through the bushes, 'bout 50 yards apart, an' one of 'em slipped up ter one openin' an' on to the other ter see where they was the thickest. Where pa was they was thick as they could stand an' he motions to Uncle Dick to come there, but they was jest as thick where he was an' he motions pa to come ter him. Each one thought he seen 'em the thickest, an' they got to whisperin' an' then to callin' ter one 'nother.

"Come 'ere, dad burn it. They's a heap the thickest here."

"No they ain't. They're the most here."

Directly they made such a fuss till the

curlews got scared an' flew off an' left 'em a disputin' 'bout it, an' they got mad an' fought, an' their pa frailed the dirt outen 'em fer it.

They got ter tellin' 'bout fire huntin' an' how the deer used ter tear up the pertater patch of a night, an' Mr. Sam said one time they was 2 fellers went a fire huntin' an' they shone a pair of eyes an' the man with the gun shot down a big ole buck. The feller that was totein' the fire pan sez:

"We done well that time."

"We, the dickens," sez the other man. "I killed 'im, you didn't have nothin' ter do with it."

They hung up their deer an' went on a piece, an' direckly they shone another pair of eyes, an' the fellers pulled down again, an' bless the Lord, he'd massycreed a man's horse that was grazin' in the woods.

"Now we've played the devil," say the feller.

"We nothin'," sez the one with the fire pan, "you killed 'im, I didn't have nothin' ter do with it."

Pa said it was a mighty sorry hunter couldn't tell a deer's eyes from a horse. We laid there by the fire a while, an' I'd a been plum satisfied only I couldn't help a thinkin' before long we'd have ter pull out fer home, fer our time was comin' to an end an' the flour an' pertaters a gittin' low. Jest as we rolled up in our blankets we hearn the old varmint holler, off acrost the branch toward the big cypress, an' Old Ring got up and howled the lonesomest I ever seen. I wouldn't a been by myself for a 100 dollars. Mr. Sam sez:

"If it'll come a rain before we leave ter make trailin' good, we'd ought ter take a day and seef we kaint run 'im down with Old Ring."

Pa an' Uncle Dick said they was willin', an' that's the last I heard that night.

Witness—Yis, Oi had 3 more whiskies at Casey's place.

Lawyer—And that made you drunk. You admit that, of course.

Witness—Oi'll not swear to it. Oi dunno was Oi drunk or sober, fur Oi don't ray-mimber anything after thot.—Philadelphia Record.

AMONG THE WATER FOWL.

The Rev. H. K. Job has written a book which bears the above title, and which has recently been issued by Doubleday, Page & Co., New York. Mr. Job tells many interesting stories of days and weeks spent on lakes, rivers and marshes, studying and photographing the various species of water birds with which he came in contact. In

idea of the character of this work by quoting from the author's preface:

"The beautiful bird pictures of Audubon fascinated me as a child and made me love the birds and begin to watch such of them as could be found in the home garden in the suburbs of Boston. By the time I was old enough to be trusted afield, the limits

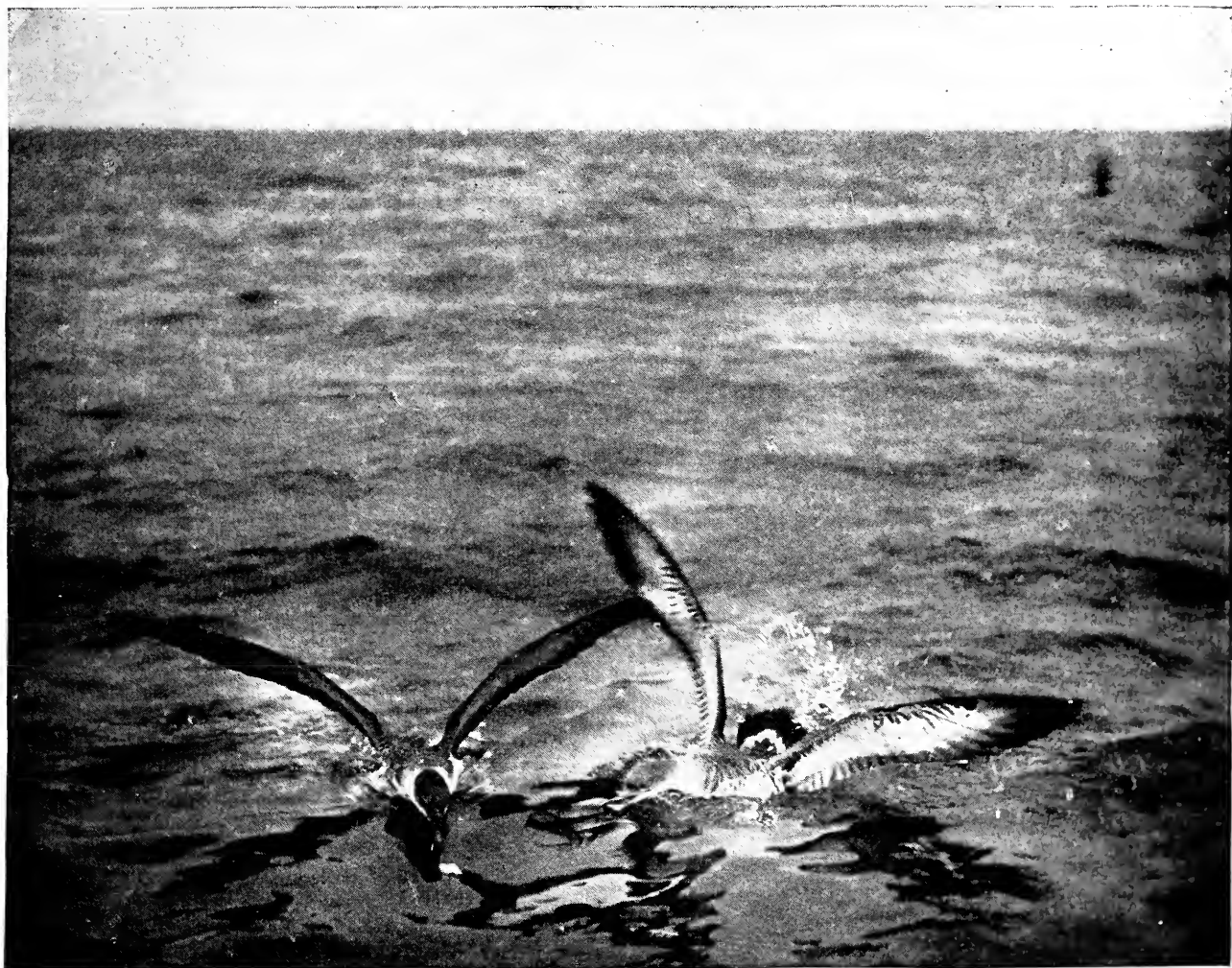

GREATER SHEARWATERS. THESE BIRDS ARE NOT JUST ALIGHTING; IT IS A CUSTOM OF SHEARWATERS TO PROPEL THEMSELVES OVER THE WATER BY FLAPPING WITH THEIR WINGS, IN ADDITION TO PADDLING WITH THEIR WEBBED FEET

other words, he has for years past been hunting with a camera instead of with a gun, and this volume records some of his most interesting experiences. He is a man of wonderful patience and perseverance, and in the present volume he has given to the world a great deal of valuable information and many pictures illustrating the life and habits of the water fowl, as only an enthusiastic and persistent student could ever know them. I can best give the reader an

of the city became too narrow, and I began to roam abroad, seeking out the haunts of the birds. In due time I had formed a considerable acquaintance with all the familiar songsters, and many others. Soon I came to feel a special interest in the shy and more mysterious species that the average youngster knew nothing of. Hawks and owls were my especial delight, and to discover their nests no effort was too great a price to pay.

"This enthusiasm soon took me to the sea coast, where there were new worlds to conquer in the hordes of migratory waders and strong winged fowl of the deep, about which the books were all too silent. Audubon knew them best, but my other favorite writers seemed to have sadly neglected them. Samuels' "Birds of New England" I almost know by heart, but many of my bird favorites its author was evidently little acquainted with. Minot was intensely interesting, but he stopped short of the water fowl. In pursuit of these inhabitants

time past these have been thought of largely as targets for the gun. Perhaps they will pardon me for laying bare their lives to scrutiny, as I protest to them, on the first occasion of our future meeting, that I am trying to raise up friends for them, not foes. It will mark a new era in our civilization when the now persecuted wild fowl can alight in the village pond and feed in peace, the object only of friendly admiration.

"As yet they are fearful of that new, mysterious Cyclops with its staring eye, the

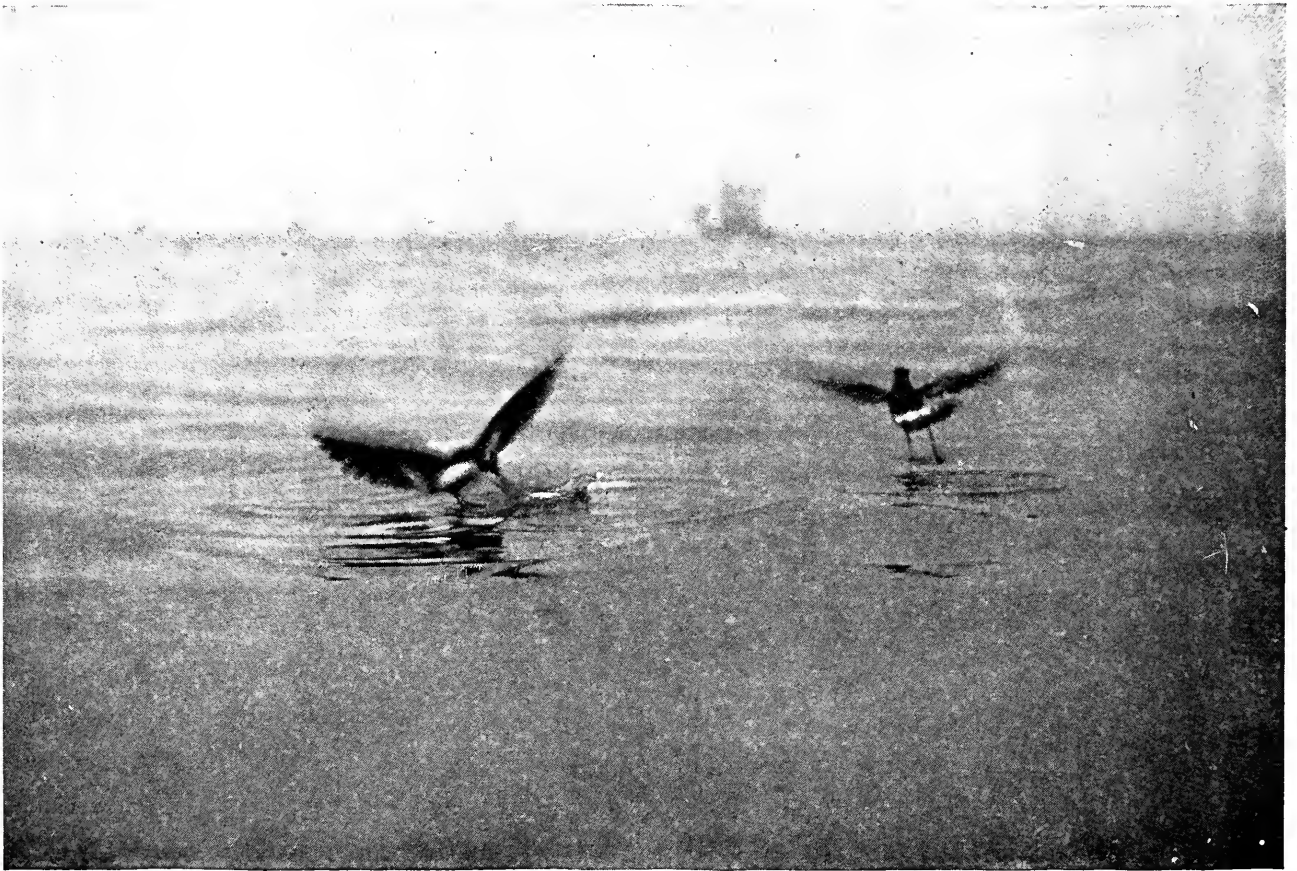

WILSON'S PETRELS; THE ONE ON THE RIGHT SHOWS THEIR CHARACTERISTIC "WALKING ON THE WATER"

of shore and ocean, various were the craft that I owned and navigated, and many the narrow escapes. However, I am yet alive, and the wild fowl have thought it best, in view of my persistency, to take me in some measure into their confidence and divulge to me some of their secrets. After rounding out a full quarter century of these prying, on land and sea, I hope I am not abusing the confidence of my wild friends in telling what they have taught me. The robins and chippies, with their kin, have been popularized in books innumerable; but why should not the great nature-loving public find also interesting and instructive the lives and ways of the water fowl? In

camera; but I hope they may learn to recognize in it a real friend, for in thousands of hands this is taking the place of the gun. Far be it from me to deny that there are legitimate uses for the dead bird; but owing to relentless, short sighted slaughter, hitherto carried on, it is coming to be a question of birds or no birds. Every true sportsman will practise moderation in the capture of game, and every thoughtful lover of wild life will stand for its protection. Exercise afield and contact with Nature are invaluable, but require an incentive. If the destruction of life can be minimized by the finding of some satisfactory substitute for the gun, no one will be the loser. Such a

substitute I myself have found in the camera, which fully satisfies my hunter's instinct. Far more skill and resource are required to photograph a wild creature than to shoot it, and the picture, when secured, is, ordinarily, of far greater value than a few mouthfuls of flesh. As I recall successful shots at fowl from the gunning-stand, I would give much to have the pictures now to inspire me, in exchange for fleeting memories. Would it not be wise policy to interest our boys in Nature-study, and the camera as applied to it, and discourage shooting at living things? Real acquaintance with a harmless and beautiful wild creature, I can testify, makes one less and less disposed to take its life. Hence I most cordially commend to my fellow sportsmen and bird lovers this noble instrument. An expensive outfit is unnecessary. In case my own experience may be of any encouragement, let me say that all my pictures in this book were taken with an ordinary 4 by 5 focusing camera, rapid rectil-

inear lens, and bellows of 12 inches draw, that cost me less than \$20. I consider the 4 by 5 size just right for field work. Equipped with such a camera and any good make of rapid plates, with a little careful study and practice of photographic method, following out some such plans afield as are described in this and other volumes, joined with real love for the birds and nature, there is no reason why anyone may not succeed better than I have done."

The book contains over 100 illustrations, all from photographs, and a man might profitably spend a whole day studying these alone. It will be impossible for any bird lover to look at even half a dozen of the pictures without wanting to read the text, and learn how it was possible for a photographer to get near enough to the birds to make the pictures. Mr. Job has placed all bird lovers under lasting obligations to him, by giving to the world this delightful volume, and I trust it may have the large sale it so greatly merits.

A BALLAD OF THE FUTURE.

A. L. VERMILYA.

How dear to my heart are the old fashioned
stories
Of game hogs who roamed o'er the earth
long ago;
'Tis said that those swine once partook of
the glories
Which fond Mother Nature so loves to
bestow.
They ground-raked the quails, they slew all
the rabbits,
They made of the wildwood a desolate
waste;
Yes; they killed all the game, and so hog-
gish their habits,
They left for the sportsmen not even a
taste.

CHORUS.

The bristle-backed game hog,
The slab-sided game hog,
The ill mannered game hog,
Extinct long ago.

O, those game hogs they proved to be cow-
ardly scooters
When the L. A. S. forces marched into
their camp,

But the sportsmen got after the dropsical
rooters,
And hustled and harried each bristle-
backed scamp.
Also came RECREATION—may it flourish for-
ever—
And swatted the porkers with language
succinct;
It lammed them and jammed them, with
tireless endeavor,
Till the whole swinish lot soon became
quite extinct.

That's the reason I like to hear stories that
tell of
The low minded hogs and their mean, sel-
fish ways;
But I sigh as I think what a perfectly hell
of
A time sportsmen must have had back in
those days.
And it really does give me much quiet en-
joyment
To think how those rooters must work
where they dwell;
For Satan has given them steady employ-
ment
At constantly piling on brimstone in hell.

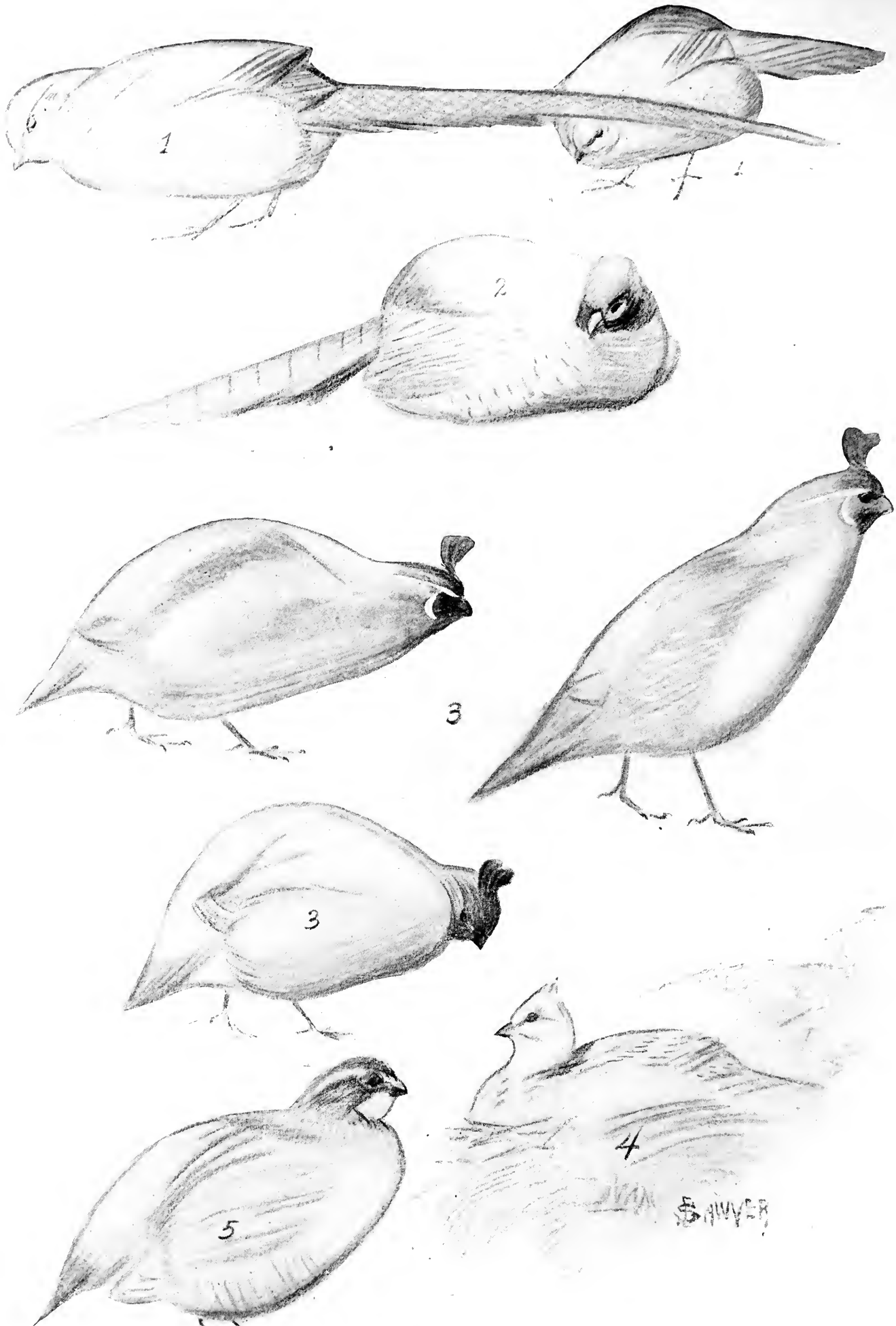

1. GOLDEN PHEASANT (COCK AND HEN). 2. MONGOLIAN PHEASANT (COCK).
 3. CALIFORNIA QUAIL. 4. RUFFED GROUSE. 5. BOB WHITE, OR QUAIL.

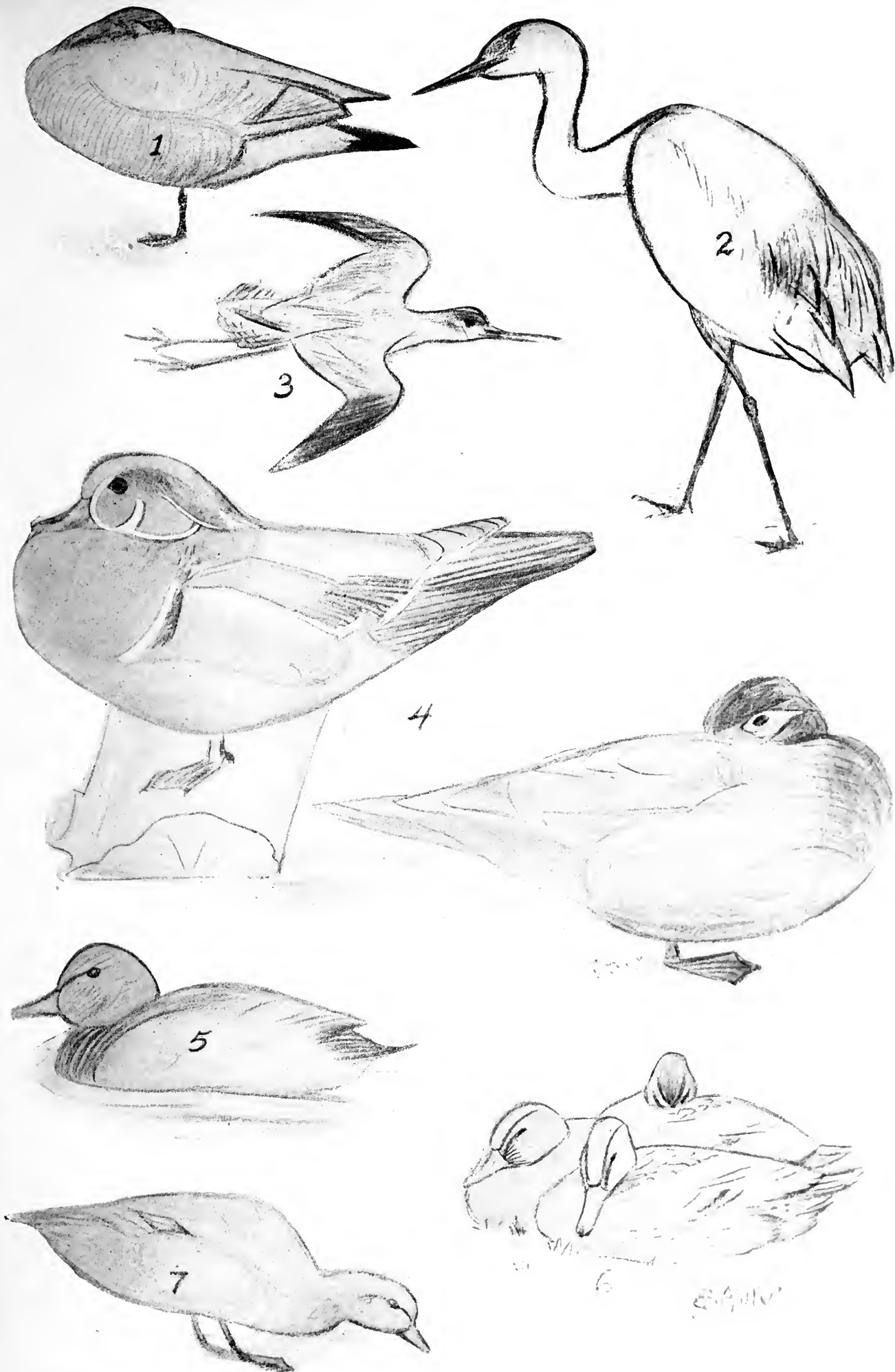

1. CANADA GOOSE. 2. SANDHILL CRANE. 3. YELLOW LEGS. 4. WOOD DUCK. (MALE AND FEMALE). 5. REDHEAD DUCK. 6. MALLARDS. 7. TEAL.

THE WHITE GOAT IN ALASKA.

E. W. SHAW.

We were camped on the Cleveland peninsula, about 50 miles North of Ketchikan, and were following some rich looking float, discovered the spring before by my companion, Sam Gellet. Ketchikan is on Tongas narrows and is a little, white hamlet, typical of Alaskan coast, with totem poles, a salmon cannery, Siwash dogs and an occasional mail steamer. It was in November, and the first snow of the season, dry and feathery, had effectually stopped all prospecting for that winter. Back on the rocky, bold mountains of the peninsula, where dwells the white goat, it lay deep and dangerous enough to satisfy the most enthusiastic lover of mountain climbing or winter shooting. While the ground remained bare, we had agreed to devote our time to prospecting; so goat hunting was postponed, although we well knew the risk attending it when the treacherous steeps were covered with ice and snow.

Having made the tent snug and tight on our arrival some weeks before, by backing it well with such moss as one finds only in Alaska, we spent a few days in laying by a stock of venison. At that we would probably have been unsuccessful had it not been for my partner's dogs, Carlo and Bounce. As it was we bagged 2 deer; Sam killing an old doe in front of Bounce, while I shot a yearling, still hunting. This sounds easy, but was quite the contrary. We had put the dogs out only as a last resort, and after repeated failures in still hunting.

Before many nights passed, the reason for the scarcity of game became apparent. A band of large black timber wolves were on the rampage in the neighborhood, and many a night they would come down in the moonlight to the salmon stream and howl defiance across at our little white tent under the big cedars. To protect our meat against their ravages, it was strung up by the throat halyards to the mast of our little sloop, which lay in quiet water off the mouth of the stream.

While prospecting on the morning of the storm, we had separated as usual, in order to cover more ground. A careful search along my side of the gulch failed to reveal the quartz ledge of free gold for which we were looking. The fast falling snow hastened my return to camp, and supper was cooking on the stove when Sam arrived. Over the after dinner pipes my companion told of finding fresh goat signs away back in a basin just below tree line, at the head of the valley visited by us that day.

By November 1st, goats have selected and are on their winter range, which is usually much lower than their summer habitat, and as they travel but little, one is reasonably sure of finding them near their sign. As Gellet was not enthusiastic that evening over my proposal to go hunting, I was prepared on the following morning to hear a vigorous protest. He pointed out the unsettled condition of the weather; but my determination to go, even though alone, finally won his consent to accompany me, bringing his dogs. I had never seen dogs used in following goats and it was with some interest that I looked forward to the day's hunt.

An hour's steady tramp after leaving camp, took us to the head of the creek. In a few minutes more we stood in the basin and the chase was on. We thought it better to cover thoroughly all slides extending down into the timber. Then, by working gradually to the summit of the ridge our hunt could, if necessary, be carried on to the main range. We hoped to secure game without going up among those glaciers whose talclike greens had been in sight for weeks.

The precipitous face of the mountain was lined with slides alternated by ridges covered with dense thicket and with spruce timber. Previous to the ascent, the surfaces of the open slopes were carefully scanned with the hope of seeing, outlined against the snow, that faint yellowish spot indicating Billy's location.

Failing to sight game, Sam proposed a mode of hunting too simple and seemingly too sure to be interesting. It was, however, arduous labor. He would take one slide and I the next, while the dogs ranged on the timbered hogback between. If they routed the quarry, one of us would in this way be sure of obtaining a shot as it crossed the opening above. The more elevated our position grew, the greater difficulty of traveling; and there were frequent briery tangles eager to tear the hands or catch the clothing. They are not found only on the mountain slopes, but throughout the low country as well, to the great discomfort of hunters and prospectors alike. Many an hour have I spent after reaching camp at night, extracting countless numbers of these poisonous needles.

These may be distressing, but that morning I found 2 things absolutely dangerous; the slippery ice, invisible under the snow, and the liability of starting an avalanche. It is surprising to note the ease with which

tons of rock and loam can be started into activity by the loosening of just one stone.

One gully especially was full of loose granite and frozen gravel, freshly come down that morning, from many feet above. To avoid a perpendicular drop in the declivity I had been working my way slowly up, just in the edge of the brush. As the ascent looked easier on the opposite side, I started to cross. Suddenly, without the slightest warning, the whole mass of debris, 2 or 3 feet in depth, became freed from its temporary lodging and swept down toward the edge of the cliff. It was a moment, of course, getting under way, and in that interval a few powerful leaps had placed within reach a projecting ledge, which, however, I failed to grasp in my hurried descent. Then I lost my balance completely and in a half sitting posture was being carried toward a large windfall, extending over and a few feet above the slide, and under which I would pass.

It seems strange that I did not at once think of the tree as a possible means of escape. At that moment, however, I was wholly occupied in watching the downward flight of an immense boulder that, ricocheting past me, bounded over the cliff, and out of sight. I did not feel alarmed, although aware of my danger, and was well under the tree before recognizing in it an avenue of safety.

Fortunately my rifle had been tossed aside into the bushes, near the ledge above. Straightening myself as I approached the limb, I waded a lunge, throwing both arms about it and swung the lower portion of my body clear of the swiftly moving earth beneath. In a few minutes everything was quiet again; but it was some time before I dared set foot on that treacherous dirt. Then, gingerly enough, I picked my way to where the Winchester was lying, and hastened on to make up the time already lost. Wondering how far ahead my partner and the dogs were, I heard the latter giving tongue among the rocks, some distance above tree line and almost out of hearing. Afraid of not being in at the death, I pressed forward, gradually leaving the scrubby firs below me.

Old Sam was overtaken while stopping to regain his breath. As I drew near he excused himself by saying, "Wind ain't as good as 'twas 20 year ago." Up to this time, we had seen no traces of the animals; but from the sound which now could be plainly heard, concluded the goat or goats were at bay. The excited yelping of our canine friends acted as an incentive, and the climb was quickly resumed, Sam following.

We arrived on the scene of the conflict, greatly fatigued, and covered with perspiration, just in time to see Bounce close in

on a large male goat, and receive a vicious stab in the breast from the old fellow's sharp, jet black horns. Although Carlo was vigorously occupied in the rear, Billy seemed to pay little attention to him and was about to charge poor Bounce, who had backed off and was coughing blood, when I fired, breaking the goat's back with a 45 from my repeater.

It was plain the horn had entered the dog's lung; and as we examined the wound, it was pitiful to see Sam's streaming eyes and hear his homely expressions of endearment. He had lost that dog's sire in the same way, up on the Chickerman river, only in that case dog and goat went over a precipice together. Even little Carlo looked on in sympathetic silence as I bound up his wounded partner.

As Bounce refused or was unable to walk, and as Sam would not hear of his being shot, I turned my attention to the goat; the second it had been my good fortune to kill. Wishing to save this splendid specimen for mounting, I at once began taking off the head. During the process Sam conceived the idea of making a stretcher of the hide as a means of getting the dog to camp, and he immediately descended to timber, in search of 2 suitable poles.

Work had proceeded on the carcass 20 minutes or more, when I heard Sam shout from below, "Another goat, Teddy; shoot! shoot!" Grabbing the rifle, my attention was attracted by a stone rattling down from higher up on the ridge, and I was just in time to get in a shot as a second goat clambered over the loose rock above. Apparently unharmed by the hastily aimed ball, the animal vanished in a flurry of snow. Of course I was soon on his track, and was not surprised, though keenly disappointed, at finding neither blood nor hair.

I decided to undertake the almost hopeless task of following what I thought an uninjured, and already much frightened mountain goat. My lucky star must have been in the ascendent that day, for hardly 100 yards were covered when I nearly stumbled over the body of the goat, pitched head downward, in a snow-filled gully. The shot had ranged forward, breaking a number of ribs in its flight.

When I appeared before Sam later with the head and hide, he "allowed" he had known of my success by the "crazy yelling." It was some time before he could understand why I cut the hides up the back of the neck instead of the front, or, in fact, why I cared to save them at all.

He had meanwhile completed my interrupted work; the litter being constructed by running 2 cedar poles through slits cut lengthwise of the skin.

On the long woolly hair we carefully

placed the dog, laying our rifles beside him; and, each of us strapping a goat head to our backs, were ready for the descent, the accomplishment of which I now recall as the most exasperatingly hard bit of labor ever undertaken by me. This may have been Sam's opinion also, though in his case it was a labor of love. He repeatedly refused my request that the suffering of the poor brute be ended with a bullet, insisting that the dog would recover and, in fact, he did.

Though camp was reached without accident, the discomforts of the latter part of the day's hunt were increased to a large

degree by the rapidly rising wind, and the simultaneous dropping of the mercury. During the trip down, which consumed the greater part of 2 hours, our enforced activity prevented us from feeling the cold; and, it seemed to both, on finally reaching the tent that we had well earned a long night's rest.

A few days later we started on our return to Ketchikan, and for nearly a mile, were obliged to chop a passage in the ice, for our boat. The town was reached just in time to dine with my brother and friends, aboard his yacht, on Thanksgiving Day.

A CURIOSITY FROM ECUADOR.

DR. S. A. DAVIS.

In almost every flock of sheep on the Inter-Andean plains of Ecuador may be found rams having more than the usual pair of horns. Rams with 3 or 4 horns are common. I have been told of some having 5 or 6, but have never seen them. The arrangement of these horns is varied. The upper pair, when there are 2, occupy the usual position on the skull; the lower pair are placed close below and slightly behind the bases of the first. The upper pair lack usually the twist of normal horns; curving upward and outward, or arching downward. The lower pair usually take a downward curve to form almost half-circles. Where there are 3 horns, a vertical, spikelike horn rises centrally between the downward curving lower pair. I have, again, seen all 3 horns curving forward, so that, if the growth continued, the points would terminate, the one above somewhere back of the nostrils, and those laterally placed, near the angles of the mouth. The local name is *ingo*; plural *ingos*.

Through the courtesy of Mr. A. McL. Miller, one of the civil engineers of the Guayaquil and Orento railway company, I am enabled to send you a photograph of a 4-horned domestic ram of Ecuador. The head having been cleaned of all soft parts and otherwise prepared for mounting, it lacks natural proportions, as well as that preoccupied expression assumed just before launching himself at some unsuspecting person's unguarded rear. However, as the purpose is only to show the 4 horns, the absence of other features needs no criticism. Rams are found here having 5 and even 6 horns, but such horns are usually dwarfish, abortive and asymmetrical, as if Nature had planned a piece of work which she could not afterward well perform. The cropping of one ear is the owner's mark. The removal of the taps

from the upper pair of horns shows the ram to have been brave or gifted with more push than was considered desirable.



AMATEUR PHOTO BY DR. S. A. DAVIS
DOMESTIC RAM OF ECUADOR.

Larvæ, called the dobson, or alligator, are common in the cooler streams of Ecuador, and the mature insects are well known. What seems to me an anomaly is the pupation and emergence of the imago from the earth, as I had always been led to believe that this part of its life history took place, if not in the water, at least in close proximity. I saw lately an imago of this insect, just emerged from the pupa case, which I pulled from its hole in the ground, at the foot of a ledge of rocks. If the larva had crawled there to undergo pupation, it must have crawled up the steep side of a railway embankment, across the grade to where the ledge stopped its progress, and buried itself in the little dirt it found, a distance from the stream of about 50 feet.

SIGNS OF A COLD WINTER.

ADIRONDACK JIM.

Of course you know all the ordinary signs of an approaching cold winter; thick corn shucks, big muskrat houses, and all that; but I saw a sign that eclipses them all.

A few years ago I was deer hunting in the Adirondacks in October. While returning to camp from watching a runway, I turned aside from the trail to examine a bear's den I had noticed when passing in the morning. The sun was just setting and as 4 miles of wilderness lay between me and camp, I realized I had little time to spare, but I was anxious to know whether Bruin was at home or not.

I had been prospecting about the mouth of the den possibly 10 minutes when a sudden gust of wind caused me to look up. In the West I saw a huge black cloud rolling up and obscuring the horizon.

I don't say I was frightened, for I would not acknowledge it if I was, but I struck into that trail as quickly as possible. I had covered about a mile of the distance to camp when the storm broke in a fierce gale and darkness closed about me. As I had gone up the trail that morning I had seen an old log shanty, and I thought I must be nearing the spot; but the trouble was to locate it in the darkness, as it stood back from the trail. I remembered there was a notch in the range of mountains at that point which might help me to discover the location of the hut. Straining my eyes hard at the blackened West I could make out a faint outline of the unbroken crest, but no notch. I stumbled along as rapidly as wind and rain would permit. Presently a dark spot in the West gave me the clue. I turned to the right and leaving the trail, entered the notch. The notch cut the mountain range from East to West and the storm swept through with tremendous force directly in my face.

I could scarcely see anything, yet I pushed forward, knowing that shelter was near. Presently I ran plump against the corner of the old shanty. When I passed in the morning I noticed that the greater part of the roof had tumbled in, but that a small portion at one end was intact, and the door was on the South side near the

center. I felt my way along until I came to the door. It was about 2 inches ajar, but when I attempted to open it, it refused to move. The old building had settled and securely fastened the door. I had no time to investigate, for the rain was coming down in sheets. I knew there was an opening at the top, so I climbed the corner where the ends of the logs projected and was inside in a jiffy.

If I had dropped into a Fifth Avenue hotel in New York I couldn't have felt better. I wiped the water from my face and began to feel about the place with my feet. I had on a long ulster overcoat. This I decided would make a good bed quilt. No pillow being at hand, I placed the stock of my rifle under my head and prepared to sleep; but no sleep came to my eyes.

It must have been past midnight, the storm had cleared away, the stars shone like incandescent lights, when suddenly I heard a scratching and the next instant a large animal crouched on the top of the wall. In the dim light I could just discern the outline of the beast. Without ceremony he leaped inside, his long, catlike tail following. I knew that instant it was a panther. I wished I was not at home to callers. No; I wished I was at home. I was not frightened, I never am frightened; I just lay still and waited. Presently I felt a loose board move near my feet. The next instant the long ulster was jerked from over me and with a bound the animal was over the wall with the coat.

I was vexed to think I had allowed the panther to steal my coat without the least opposition. What should I tell my comrades when I got back to camp? Presently morning came and I lost no time in getting on the trail. I had walked a mile when that panther crossed the trail ahead of me. I knew it was the same one, for he had my ulster on and I could see the long skirts trailing on each side of his tail. When he looked up and saw me he went off at a gait that made the tails of the coat slap like a flying jib in a head wind.

That winter was the coldest ever known in the Adirondacks.

Lady—Did you every try to get work?
Tramp—Yes, ma'am; I got a job for me
brother once.—Baltimore World.

ILLINOIS AND MISSOURI RAZORBACKS.

A subscriber recently sent me a clipping from The Republic, of St. Louis, Mo., showing the photograph reproduced herewith and stating that the men whose portraits appear are W. F. B. Smiley, of Belleville, Ill., and W. A. Kinsey, of Carrollton, Mo., with 135 pounds of black bass caught

bass, but caught 150 pounds of bass and pickerel, principally bass.

W. A. Kinsey, Carrollton, Mo.

Kinsey looks like an intelligent man and one who should have known better. No one who looks at Smiley's portrait could

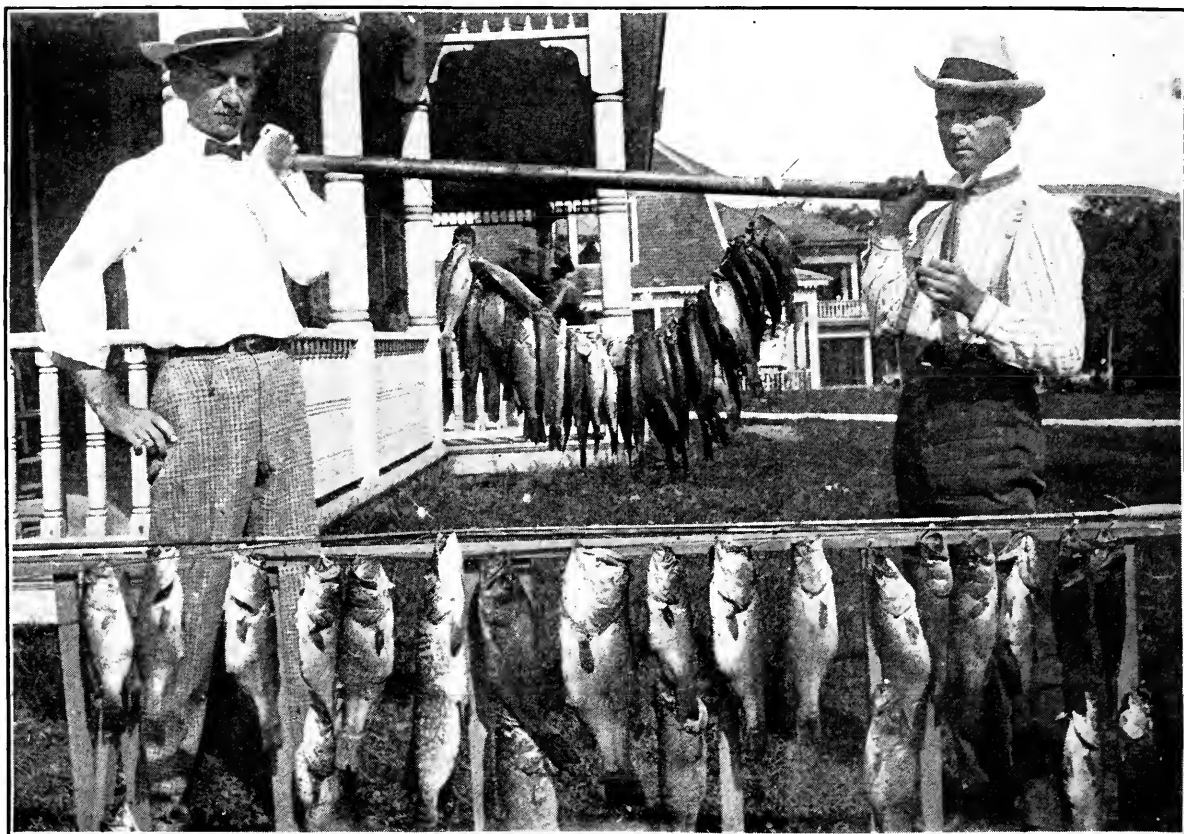

T. B. SMILEY.

W. A. KINSEY.

by them in Lake Minnetonka, Minn. I wrote these men, asking for confirmation of the report, and received this reply:

We did not catch 135 pounds of black

reasonably hope that he would ever be anything else than a fish hog or a game hog, but they are both in the same pen. It is to be hoped they may some time repent of their sins and that even Smiley may yet feel ashamed of himself.—EDITOR.

POSSIBLE DAIRY STOCK.

I send you a photograph of Master Hugh Rogers and the pointer, Lady. Hugh is the son of Mr. Hugh M. Rogers, of Spokane, and Lady is the property of W. W. Caserio, of the same town. The first time Hugh ever saw a cow milked he was much interested and wished to help. Not being permitted to do so, he skirmished around, found a small tin pail, chained Lady to a tree, anticipating her possible intention to rebel, and industriously stripped her, to the tune of "So Lady." I had my camera close and took a snap of him at his "milking." Hugh is 4 years old.

Dr. A. U. Viney, Garfield, Wash.



AMATEUR PHOTO BY A. U. VINEY

FROM THE GAME FIELDS.

The man who quits when he gets enough, with plenty of game still in sight, is a real sportsman.

THE NEW YORK DEER LAW AGAIN.

ED. FAY.

The November number of RECREATION contains a bitter protest from the able pen of James M. Graves, against cutting August out of the open deer season in the State of New York.

While giving Mr. Graves credit for good faith, it is hard for one who knows the situation, and is solicitous for the preservation of deer in the Adirondack forests, to allow his letter to go to the readers of RECREATION without protest. I take issue with Mr. Graves when he says it would have been tenfold better to have cut off the 15 days of November shooting than to have cut off the August shooting. There is no time in the year when deer are so easily approached and killed as during the warm weather, excepting, perhaps, when they are yarded in winter. This never occurs before December. I have seen no less than 12 deer at one time in Potter pond in August, and that without taking pains to approach the pond quietly. The farthest one of the 12 was within easy rifle range, and a person who could not have killed his 2 deer in one day would be no menace to the preservation of game if the whole year was an open season.

Those who wish to kill deer in hot weather are no better respecters of the game law than those who prefer waiting till the deer are fat and wary; and any deer hunter knows that during hot weather deer frequent salt licks and water, and may easily be killed at either. While they are in the water at night they become an easy prey to the jack hunter. I have never been guilty of jacking, but I know too well that it is indulged in and is difficult to prevent during the open season. The same argument holds true regarding salt licks.

With the advent of cool weather, deer stop frequenting either water or licks. Our lawmakers wisely lopped off that part of the season that furnished the greatest temptation to illegal killing of deer, as well as the time when it requires little skill to get a reputation as a deer slayer.

Mr. Graves says, "Any 10-year-old boy can sharpen a stick and go out and kill a deer on soft snow." This is ludicrous. When Mr. Graves gets out on snow in the morning as soon as he can see a track, takes his grub in his pocket and trails a deer till he can get the drop on it, he will have more respect for the courage and skill that kind of hunting requires than he appears to have at present. To my mind, there is no more sportsmanlike way of

hunting deer than still hunting, snow or no snow. The deer has an even chance, and it is a great game between the skill and pluck of the hunter and the acuteness and vigilance of the deer. As Mr. Graves truly says, "There is no sitting with back against a tree for a snooze" in that kind of business, unless your game is cunning enough, which is not unusual, to lead you astray and your "snooze" is an all night one, waiting for daylight to help you find camp again. The "snoozy" kind of hunting comes when you sit waiting in ambush for some doe to wade out into a pond to feed on the tender water-lily pads or get away from the flies. When her splash wakens you, take your rifle, or shot gun if you can't hit anything with a rifle, and murder her. During warm weather nearly every deer killed is a doe, and on snow the reverse is true.

Again, it seems Mr. Graves must be misinformed as to the number of deer the Granshue and Inlet clubs killed on snow last year, as there were only 2 days of snow before the season closed, and the fall was so deep that hunting was out of the question the second day. I am personally acquainted with a popular member of one of those clubs, and well remember how he tried still hunting the last day of the open season last year. As the old guide said, "Indian not lost; wigwam lost"; and Charley partook of the hospitality of a woodchopper's camp that night.

The latter part of Mr. Graves's letter comfortingly reveals the fact that he writes from information obtained from men in his section, who, he says, agree that November shooting should be abolished. That is just what Charley said the next morning after the wily old buck led him a wild goose chase for 8 straight hours and left him, luckily, where the choppers heard his alarm shots after dark, 6 miles from camp, in 2 feet of snow.

When the open deer season needs further pruning, by all means lop off 2 more weeks of warm weather and do not open it till the middle of September. The fellows who want the season open in August instead of November are the ones who would like to kill a deer or 2 every season, but do not value the sport highly enough to undergo any great fatigue or hardship, 2 things a true sportsman really enjoys when on a hunting trip.

A case in point: A party of 10 of my acquaintances, at the opening of the present season, killed 12 deer, and every one was shot from a boat in daylight, the hunt lasting 6 days. A party of 7 of us, with 2 guides, have just returned from a 5 days'

trip. Only 2 deer were killed, and what we went through will live in all our memories as proof of our powers of endurance. We shall not forget the day we got up at 3 o'clock in the morning, got our breakfast out of the way and had camp cleaned up by the first flush of dawn; then shouldered our rifles, took a day's ration each, and tramped over mountains and through swamps and marshes till dark, with not a drop of blood drawn by any of us that whole day. The next morning we were up and off again as soon as we could see to travel. By consummate skill and the patience of a Piute Indian, Lute snaked himself over the top of a hill to get a view over an open, beyond, when a lusty old buck mistook his cunning and, with all his tacking and maneuvering, got a 38 in the short ribs. This is the kind of hunting that makes picnic hunters want November shooting abolished, to be replaced with warm weather shooting, when they can step down into a boat 10 rods from camp, have a guide paddle them downstream till they can shoot some unsuspecting doe with an unweaned fawn, and get her into camp without even the trouble of toting her.

ABOUT ARKANSAS GAME LAWS.

I wish to address particularly, through RECREATION, those gentlemen sportsmen of Arkansas who are really interested in the protection of game. The game laws of that State are so arranged as to license the professional market hunter and trapper, but they do not protect nor preserve game; nor do they allow the true sportsman the liberty to which he is entitled. For instance, if a man goes there for a day's recreation and sport, even if he lives only a few miles away in an adjoining State, he is subject to arrest and a heavy fine. That type of man is probably one who would wish to see game protected, and who would not under any consideration molest game out of season, or perpetrate any wanton slaughter; while the professional market hunter can move to the State during the hunting season only, if he so choose, and of course the more he hunts and the more he kills, the greater is his profit. The law which prohibits non-residents of Arkansas from going there to hunt and recreate, does not catch the class of people against whom it was aimed. It simply gives the cheap and unprincipled deputy sheriff a chance for graft on a class of men who are able to pay a fine and who, when caught, have to pay, in order to get back to their business and because they have not the time to spare to fight the case. Such a sportsman could, in nearly all cases, defeat the snap judgment passed on him by the magistrate, who probably is in league with the

deputy, but his business demands that he pay the fine and return at once; while the professional who lives there all the time and the professional who has only moved there for the hunting season and claims to be a full fledged citizen of the State, and who destroys more game in one season than the gentleman sportsman would in many, is allowed to go on slaughtering for money, unmolested. I do not say what the remedy is, but I should like to see the following suggestion and figures put to the Legislature by the good people of Arkansas who are interested in protecting their bountiful game supply, before it is too late.

Make it a misdemeanor for anyone to sell game at all, and limit the catch and kill. It is with the sportsmen and sportsmen's journals to protect game. The professional hunter or trapper will never do it until the last turkey, prairie chicken, duck, deer, squirrel, rabbit, fish and furred animal is gone. I submit the following figures as a limit for one man, and if they were a law no one but a game hog would violate them: 3 deer in one season; 5 turkeys in one season; 15 ducks in one day; 25 squirrels in one day; 15 prairie chickens in one day; 25 fish in one day; 10 rabbits in one day.

These are ample, though they are often doubled by people who call themselves gentlemen sportsmen. There are plenty of real sportsmen in Arkansas and I should like to hear from some of them in regard to this, for this is a true outline of the conditions in that State.

Pax, Memphis, Tenn.

TOWNSEND-BARBER CO. EXPLAINS.

Editor RECREATION:

We have noticed the item published on pages 282-3 of the October, 1902, number of RECREATION, entitled "Killed too Many Sheep," in which appears a letter from R. J. Boyd and your answer thereto. We take exception to your criticism of Mr. Boyd's action while in our employ on the trip when we secured 8 sheep in February last. Those sheep were specially secured to fill orders from the leading museums. Six of those same sheep are now in the American Museum of Natural History, in New York, and one of the others, with further specimens, is in another Eastern museum.

The Mexican mountain sheep belongs to the species recently described by Dr. C. H. Merriam, of Washington, as *Ovis mexicanus*. Until last winter the only specimens of this species in museums were the type specimens from which the species was described, in Washington. It was therefore desirable, not only from the standpoint of the naturalists and museums concerned, but from the standpoint of the general public for whose education these museums exist, that specimens should be

secured to be placed on permanent exhibition where they will form a lasting monument to the species. To what better use can an animal be put? We answer, "None." Fifty specimens of *Ovis mexicanus* placed in the leading museums of the world, where they will be looked after carefully, will do more good for mankind in general than if the sheep are left to live on their native hills in Mexico. That is the only point we wish to make. We are heartily in accord with intelligent legislation for the protection of game, in whatever country, and we would under no circumstances be guilty of transgressing any existing game laws. We agree with you that one, or at most 2, sheep a year are all that the ordinary hunter, who is simply after sport or a head, should kill; but we claim that the leading public museums of the world have always the first and best claim on any living animal. They should be supplied with specimens of that animal at the earliest opportunity, before it is in danger of becoming extinct. Whatever happens in the future to any species of animal, scientific specimens of that animal should be preserved to show future generations what it was like. The South-western elk, *Cervus merriami*, of Nelson, is a case in point of a most interesting species of large mammal that is now practically extinct, and of which not a perfect specimen is in existence in any museum. You can readily understand how this fact is deplored by anyone interested in large game animals. There are enough extinct animals that lived on this earth in bygone ages of which we have no reliable data, except such as may be derived from their skeletons, and it behooves us to see that existing species are properly represented in museums before it is too late.

Townsend-Barber Taxidermy and Zoological Co.

LET US BUY THE WOLF AND HELP THE GIRL.

I recently saw a grey wolf chained in a shady and grassy front yard of a farmhouse, 10 miles West of Dubuque, Iowa. I took a long look at him, admired his shape and size, then went in and inquired. The wolf, 6½ months old, male, was given to a 15 year old girl when he was 10 days old. She raised him on a bottle and he is now large and fat, with splendid coat of hair, and seems to be fully developed. He is playful and obedient to those he knows, but with strangers he is shy and afraid. He accompanies his mistress, loose, all over the farm; when she goes to the pasture after the cows, etc. He will throw himself down at her feet, roll over and catch her wrists with his teeth, all playfully; but he can not be trusted a moment alone with chickens or turkeys. He is as clean look-

ing a pet as one could wish. The girl is fond of him, but would like to sell him. She is bright, intelligent and ambitious, but not rich, and one of her hands is crippled, forever probably. She lives with her parents on a small rented farm and tries hard to make a teacher of herself. She would apply the money to that end. Her parents are not able to help her to the full extent of her ambition, and her career upward is necessarily slow, as considerable of her means have been, and still are, expended for medical treatment. Who will help her by highest offer for her pet wolf? Her address is Irene Murray, Peosta, Dubuque county, Iowa. Application to her should contain a 2-cent stamp, or write me.

A. Lindemann, Cascade, Iowa.

Let us chip in 50 cents each, buy the wolf, give it to some zoological park, and thus help the poor girl through school. Contributions sent to this office will be promptly acknowledged and forwarded to Miss Murray. No one need send more than 50 cents. Remit in stamps. I already have \$5 subscribed. Let us act promptly.—EDITOR.

LABRADOR IN NOVEMBER.

I wish some reader would give me information about the game and the climate of Labrador in November.

H. W. Smith, Dorchester, Mass.

I referred the above to Dr. Morris, of this city, who is familiar with the country mentioned. His reply follows:

I have not been in Labrador in November, but the residents along the coast tell me that while winter really begins about the last of September, it is not very cold or stormy until well toward Thanksgiving time. I should expect the bears would all be in their dens by early November. There are any number of caribou in Labrador, but in November they are in great droves, and one either finds a million or none at all. Before the migration begins in September they may be found almost anywhere in smaller numbers. The barren ground caribou have their range down to the Hamilton river, and the woodland caribou range North to about that point, so both forms intermingle more or less along the Hamilton. The barren ground grizzly bear is said to range as far South as the upper waters of the Hamilton. Some of the natives told me they could take me into the grizzly country, but I doubt it, as the people along the coast only go "3 days inland." I think it would be necessary to get Naskopie Indians for guides for the upper Hamilton waters, and they do not speak English or French, and are independent, caring little for coming to trad-

ing stations. There would be danger in getting caught in the Naskopie country in winter, for a traveler would have to divide his provisions with any Indians met *en route* who were short of supplies. If he tried to keep his own provisions he probably would not need any the next day. The Nascopies are good enough excepting when they are tempted, and they are easily tempted.

Robert T. Morris, New York City.

RECREATION NO RESPECTER OF PERSONS To J. H. Osgood, Fergus Falls, Minn.

You sent me a clipping stating that 6 men had killed 75 prairie chickens. Let us see how much of a crime they committed. That is an average of $12\frac{1}{2}$ birds to each man, and it is likely that as those men went from Chicago and St. Paul to the shooting grounds, they stayed more than one day. But suppose they had stayed only one day. What then? A man may reasonably kill 12 or even 15 prairie chickens in a day, though personally, I believe no man should be allowed to kill more than 10 in a day. Until we have laws limiting the bag to some such figure, there is no objection to killing 12 birds a day, or to averaging that number.

I did not go into the matter at such length in reply to your first letter, but when under date of September 23. you state a string of falsehoods, it becomes my duty to show you how far you miss the truth. I therefore enclose herewith a few clippings from past issues of RECREATION in order to show you whether or not I confine my roasts to poor men.

One man condemned in one of these articles is General N. A. Miles, Commander in Chief of the United States Army; another is S. E. White, a prominent business man of Grand Rapids, Mich.; another is Professor O. C. Hagermann, President Lexington University, Morgantown, W. Va.; another Senator J. H. Smith, of your State; another an ex-Justice of the Peace and ex-game warden S. P. Monroe, of Lyme, Mass.; another W. F. Burrell, a wealthy business man of Portland, Oregon; and still another J. A. Cooper, Commissioner of the Supreme Court of the State of California. And I could name 100 others if necessary.—EDITOR.

NEBRASKA GAME BUTCHERS.

I send you an account from the Wisner Chronicle, of a great rally of shoats in this vicinity. It was not the first of the kind here. This time they killed 150 quails, 225 rabbits, and more than 200 ducks and prairie chickens. The high man, T. Thompson, admits that he potted 14 quails

in a bunch on the snow. Is there no way to stop such work? J. C., Wisner, Neb.

The clipping reads as follows:

The local Nimrods went forth last Thursday to slaughter game for points. It was not a favorable day for hunting and less game was secured than in former contests of this kind. The victory was won by A. Lednicky's side, the following being the score:

BEEMER'S SIDE.

O. D. Beemer, Capt.	200	S. Lant	112½
A. R. Oleson	112½	T. Thompson	470
F. J. Buck	112½	Wm. Murphy	160
G. Wessel	140	B. Emley	190
R. Schwarz	100	H. Johnson	165
M. Hoff	40	Wm. McKenzie	65
Geo. Labohm	65		
		Total	2,097½

LEDNICKY'S SIDE.

A. Lednicky, Capt.	90	M. Thompson	170
E. C. Kinzel	90	W. McKown	280
E. Herrmann	170	C. Behlers	200
H. Kinzel	112½	C. Schneider	260
O. R. Thompson	60	H. Cornaman	165
S. J. Merriam	405	F. Balster	60
L. Thiemke	260		
		Total	2,487½

Unfortunately there is at present no law against holding side hunts except that of sportsmanship. In a few years more, participation in a side hunt will be a punishable offense. Meantime the white people of Wisner might tar and feather these butchers. If the tar was of the proper temperature it would perhaps impress on them the fact that wholesale slaughter is becoming unpopular. I fear, however, that gentle measures would have little effect on these men.—EDITOR.

MARKET SHOOTING IN TEXAS.

I note your call on the people of Texas to stop the slaughter of their ducks by Eastern hogs. The inference from your article would be that it should be an easy thing to do. It is not.

Five years ago last spring I came up from New Orleans and on the train met a sportsman who told me that 6 men were then in Texas killing mallards for New York. They had refrigerator cars sidetracked and killed day and night. Not only this, but they hired as many natives as possible and paid them 7 cents each for mallards. For smaller ducks they paid in proportion. They did not, however, want the other species, but instructed their hirelings to bring only mallards. They had an open offer that held good for a certain time, for every duck brought in. The ducks were so thick and so hungry that those hogs could murder them wholesale.

I wondered then what was the matter with the sportsmen of Texas. There are some good ones in that State and just why they should allow butchers to rob them, was a mystery to me. I trust you have a good circulation in Texas and

that the loyal sportsmen of that great State will wake up before it is too late.

F. M. Gilbert, Evansville, Ill.

ANSWER.

Yes, I know such butchery has been going on in Texas for years, to feed the Eastern epicures. The same as to the coast of North Carolina. The only new feature of the matter is that the North Carolina men themselves have wiped out the great flights of water fowl that formerly wintered in Carrituck sound and have now gone to Texas to clean up that coast also.—EDITOR.

SOMETHING DOING IN OREGON.

The markets here are still full of wild ducks, and the ducks are full of wild rice and wapatos, but we can not buy muskox for 4 bits a pound. There has not been enough big game killed here in a month to lunch a bachelor's family; but I know where there is a bunch of elk and deer ranging in the 25th ward. Am now getting up a party to move on them as soon as the moon gets in the dark. Eastern hunters who want to join should remit at once before it is everlastingly too late. No reasonable fees refused. It will be an easy hunt, no tiresome tramps. Locality is also known as City park, and fresh bear tracks have recently been seen there. Street cars to within 2 blocks. As to my guiding accomplishments, I refer, without permission, to those I have guided. The biggest bags recently made here were out on Pudding river, away up the North fork. A party of 4, guided by Swinomish Sam, of Snohomish, using rifles whose spud gear never got clogged, shot a total of 827 codlin moths in one day; a short winter day, too. As soon as the days lengthen out to 24 hours again the same party expect to take a 2-day whirl among the hoplice and bag at least 6,000. Fear of your giving the bacon brand to these hunters causes the withholding of their names, but everyone will acknowledge the corn when you write and ask. A Legislature is the next thing to be elected here, and into it we propose to introduce a bill inviting all the wild game of the State to come in and board at the best hotel in town. It is claimed that such a system would be easier on the taxpayers than present protective methods.

John Watermelon, Portland, Ore.

A RECORD TO BE PROUD OF.

The Clearfield Game Protection Association was organized here February 9, 1899. Its object is to assist in restocking our streams and woods with fish and game; to enforce the game and fish laws, and to prosecute all offenders in our county. Since its organization the following cases have

been disposed of: G. M. Baney, 2 squirrels, shot before season, \$20 and costs; he went to jail. James Condon, killing one deer in August, \$100 and costs; paid. Andy Reese and John Carns, dynamiting trout, \$50 and costs; paid. John Lynch, killing one grouse and 2 squirrels, \$50 and costs; paid. Christian Weber and another, killing one deer in July, \$100 and costs; paid. Alex. Wallace, killing one deer in July, \$100 and costs; paid. Victor Baker, killing one rabbit with ferret, \$50 and costs; application for new trial pending.

The Philadelphia Inquirer is urging defeat of a bill introduced by Hon. F. G. Harris, Representative to the General Assembly from this county. Most of the opposition to the bill is being offered by the game dealers of Easton, Pa. We have good grouse shooting here, and last fall over 1,000 birds were shipped from Clearfield by non-resident hunters. I presume that in all cases, when possible, the daily limit of 10 birds was taken. Most of our sportsmen favor the passage of the bill. Still we have some hunters who are never satisfied until they have taken the daily limit of birds. If all sportsmen would stop to consider the growing scarcity of game, there would be little opposition to the passage of our bill. License the gun by all means.

H. W., Clearfield, Pa.

TWO DOVE CASES.

August 10th I arrested Geo. A. Cunningham, ex-city attorney, for shooting doves before the open season. He admitted killing 14 doves, and I secured them. He returned to the city with me, and I filed an affidavit before Justice Poole. Mr. Cunningham claimed there was an error in the affidavit and appealed to the circuit court. State Warden Sweeny has instructed me to see the case through to a finish.

This matter was thoroughly ventilated in the daily papers, but on the 13th of August, while after some other law breakers, I found Ed. T. McNeely shooting doves. He was accompanied by Mayor Covert. I did not see the latter shoot, nor have any game in his possession, but I saw McNeely throwing doves out of his pocket as he ran. I made him go back with me and we picked up 5 doves. I filed complaint against him before the same justice and the matter has dragged along until to-day when McNeely paid \$52.75 fine and costs, for shooting one dove.

I found it impossible to get legal help till Mr. A. J. Clark was employed by the State. I do not hesitate to say that if these men had not been leading politicians the cases would have been settled long

ago. Much praise is due Mr. Clark for his fearless prosecution.

E. F. Mantel,
Dep. Fish and Game Warden,
Evansville, Ind.

HAD A RIGHT TO SELL THEM.

A doctor here, by the name of Chidester, had 3 deer on his farm, said to have been raised by him. They became troublesome, by wandering away and getting on neighbors' property. Dr. Chidester sold the deer to a butcher and slaughter house owner, one of the firm of Schaffner Bros., who butchered them for the market! Our game warden here is one Rogers, and it would be useless to go to him for information or help. I have brought the case to the notice of Arthur Dunn, constable, who was formerly game warden, and a good one, but had to resign because the State would not back him up in a lawsuit with a dealer, and he paid good money out of his own pocket. He has promised to look up the law on the question, and I think will act if he can. Will you kindly advise me what could be done in this case? If the L. A. S. can possibly do something I wish it would, for this was certainly a brutal and inhumane act. If you can do nothing else roast them and ask Erie daily papers to copy.

C. W., Erie, Pa.

Unpleasant though it be, it is a fact that those deer were not game, and were not subject to the game laws of Pennsylvania. Having been domesticated, they were simply live stock, just as so many cows, or sheep, or hogs would be; and the owner had the same right to dispose of them to the butcher that he would have had to dispose of any 3 of his other domestic animals.—EDITOR.

A SLAUGHTER OF RABBITS.

I have just come in from Mantua, a small town about 10 miles West, where I enjoyed a little shooting. The morning I arrived 600 rabbits were being shipped to Pittsburgh, all having been caught within a radius of 4 or 5 miles. Two boys were out 2 days and came in with 285 rabbits. The town is full of ferrets.

One man sold, last year, \$110 worth of pelts, including everything from fox down. Portage county seems to have an abundance of quails, rabbits and squirrels of all kinds, with a heavy sprinkling of pheasants not difficult to bag.

A. A. Browne, Windham, Ohio.

The above was referred to Mr. Reutinger, then Chief L. A. S. Warden of Ohio. His reply follows:

During the last General Assembly the

law protecting rabbits was repealed. This was brought about largely by the farmer members of the Legislature, who claimed rabbits were becoming so numerous that they were destructive to crops, trees, etc. Therefore, it would be impossible for me at this time to stop the destruction of these animals. The State is swarming with them and I know that in many peach orchards trees suffer considerably from being girdled by rabbits. We endeavored to head off the movement to repeal this law, knowing quails and other game would suffer, as hunters would kill all kinds of game under the pretense of hunting rabbits.

L. H. Reutinger.

BUSINESS MEN APPROVE.

Here is a copy of a letter written by a prominent business man of Burlington, Iowa, to Congressman Hedge of that State, which shows how the majority of reading and thinking sportsmen of this country view the important question of game protection:

Burlington, Iowa.

Hon. T. Hedge, M.C., Washington, D. C.

Dear Sir—I enclose herewith a circular issued from the New York office of the League of American Sportsmen. I have been much interested in the work of this Association for some years. It has done much good in the line of protection for our fast vanishing game against the average game destroyer, whose idea of the value of game is regulated by its market price. From your long acquaintance with me you know I formerly killed a great deal of game, but my sons and I have in the last few years realized much more than formerly that game is worth a great deal more alive than dead, and should be destroyed sparingly to obtain the greatest value for the human family. There are many others in Iowa who will voice my sentiments in this matter, and you will do the cause of game protection great good if you will insist on the passage of the Lacey Bill H. R. No. 10,306. If you will take time to read this bill I think you will agree with me as to its value toward the protection of game.

Yours truly, Carl Leopold.

DEPENDS ON THE LOCALITY.

I note that you are roasting people for killing too many rabbits. Please tell me what is your object in protecting rabbits? If every one, cottontail or Jack, were dead, this country would be better off. They are the worst of pests. There is more damage done to orchards by rabbits than by anything else. One farmer had a large orchard and rabbits killed two-thirds of his trees. I am a reader of RECREATION and enjoy it.

I believe in protecting all game except rabbits. G. B. Kemp, Odessa, Wash.

ANSWER.

It is easy to protect fruit trees from rabbits by wrapping the trees with cloth or by placing wire netting around them, or even pasteboard cones. Nearly all careful, thrifty farmers and fruit growers protect young trees in this way in countries where rabbits are at all numerous. The rabbit should be protected in most localities, because he is good game and furnishes good food in winter. In the Southwest, Kansas, Texas, New Mexico, Arizona and Southern California, the jack rabbit often becomes so abundant as to be a serious pest, and has to be driven into corrals and killed by thousands, but in the East the little cottontail seldom becomes a pest.—EDITOR.

WORK OF THE CUVIER CLUB.

The following, from the Cincinnati Enquirer of December 24, shows the progress of our cases to that date:

There was rejoicing in the Cuvier Club yesterday over the conviction of the dealers and cold storage company who were found by Game Warden Rayborn with quails in their possession. The defendants, E. J. Anderson, Louis Gloesten, F. T. Hier, and R. F. Ison, were arraigned before Squire Herrick, in Price Hill, yesterday morning. All but Ison entered a plea of guilty. Gloesten was fined \$25 and costs and Anderson \$50 and costs. Hier was fined twice, first as the agent of the Cincinnati Ice Manufacturing and Cold Storage Co., and as an individual. In the first case he paid \$25 and in the second \$100. Ison's case was held over until to-morrow at 1 p. m. The attorneys for the club are now looking up the statutes relating to the additional penalty of \$25 for each bird found in possession out of season. The laws are conflicting, as usual, and some preparation is necessary in order that no mistake may be made.

You see we are doing what we can to preserve the game birds and fishes in this part of the country.

Alex. Starbuck, Pres. Cuvier Club, Cincinnati, O.

KILLED 210 RAIL BIRDS.

Chester, Pa.—Charles Longbotham, money order clerk at the Chester post office, broke all previous records among local gunners for bird shooting. He went out on the Delaware and returned with 210 rail birds, all of a splendid quality.—Philadelphia Press.

Regarding this report Longbotham writes:

In reply to yours will say that your information is correct. I did shoot 210 rail birds on one tide, which gives about 4 hours' shooting. If you are a sportsman yourself you know that was great sport.

Chas. Longbotham, Jr., Chester, Pa.

I claim to be a sportsman, but instead of agreeing with you that this is great sport. I call it mere butchery. No decent sportsman would ever think of killing more than 25 of these birds in one day. Game

hogs make a business of killing all they can find and you are fairly entitled to the name.—EDITOR.

GAME NOTES.

I recently arrested Bartimeus Wingate, under the 12th section of our State fish and game laws, for allowing his dog to run at large. Trial was had before Justice J. W. Hera. Wingate pleaded guilty, and being unable to pay a fine was sent to the county jail for 24 hours. I have 2 more dog cases awaiting trial.

Stults Pierce,
Deputy State Fish and Game Warden,
Glassboro, N. J.

I am deeply interested in your report of the dog case. This is a new departure in the matter of game protection, and the man who drafted your game law knows a good thing when he sees it. Furthermore, he knows how to make it. I should like to hear the result of the other 2 cases you have on hand and any further prosecutions you may conduct.—EDITOR.

The other day I went out with a few cartridges to see if any birds were flying. I did not see any large birds and had fired all but 3 shells when I looked out in the harbor and saw about 50 birds on a small sandbar. I sneaked down, fired 2 barrels at them and bagged 18 or 20 birds. Is not that fair shooting?

J. M. Gray, Walpole, Mass.

ANSWER.

No, that is not fair shooting. It is pot shooting of the worst possible sort, and you should be ashamed ever to have indulged in it. I trust you may never again be guilty of such unsportsmanlike conduct. Always flush your birds before you shoot, then single out one for each barrel before firing. If others get in line and are killed that can not be avoided; but never attempt to kill more than one bird at one shot.—EDITOR.

I have read more than a score of times how you roast the game hogs, but what about the Indians in our neighborhood who are slaughtering deer all the time? They kill a deer whenever they can, take the hide, horns and hind quarters. The remainder of the carcass is left to rot. As long as the settlers make no effort to have this stopped the slaughter will go on till the game is all killed. Then the Indians will leave the country themselves.

W. Wendzinski, Jennings, Wis.

ANSWER.

I am after the Indians, too, just as vigorously as I am after the white butchers; but you and the other men on the ground can

best handle the cases you complain of.—
EDITOR.

I should be false to myself, my native Province and its guides, than whom it has no more trustworthy and reliable citizens, if I failed to protest emphatically against the impression Mr. W. G. Reed evidently seeks to create in the October issue of RECREATION when he says, "Good guides are as scarce in New Brunswick as good heads in Maine." We have an institution here called The New Brunswick Guides' Association, consisting of over 30 members, mostly master guides. It matters not which of these guides the sportsman may select, he will be sure of square treatment, a good run for his money, and competent service.

L. I. Flower, Central Cambridge, N. B.

Stroudsburg, January 30.—For shooting an English pheasant on Sunday in Chestnut Hill township, this county, Owen Sandt, of Easton, paid Justice Gruver, of this town, fines and costs amounting to \$64.37. To add to Sandt's woe he did not get the pheasant after shooting it. The complainant in the case is Policeman George W. Siglin, of the Pohoqualine Association of Mc-Michaels.—Philadelphia North American.

Fellows like Sandt will find it economy to expend their surplus energy in stealing chickens. They will probably get off with 10 doys in jail, and if, at the worst, they stop a load of shot, the town doctor will pick 'em out and charge it to the taxpayers.—EDITOR.

William A. Eddy, of Bayonne, N. J., measured by means of his kites the altitude of the thousands of wild ducks which were flying Southward along the coast. The average height of the flying ducks was 1,500 feet. They passed across the crosswire space of Mr. Eddy's kites in about 3 seconds. This time was taken repeatedly, and 20 observations confirmed the speed traveled. It was found that the ducks were traveling nearly 47½ miles an hour. Although the kites were up but 500 feet the ducks appeared afraid of them and repeatedly great flocks steered off to one side or the other as they approached the point where the kites were. Mr. Eddy had aloft 29-foot and 27-foot kites.—Bayonne, N. J., Paper.

C. D. H., on page 117, August RECREATION, states: "The Canadian Indian, who smokes and salts down thousands of ducks for his food supply in winter, would wonder why the yearly flight across the line was growing less." Will C. D. H. kindly say on what authority he bases his statement? What section of Canada is referred to? Am much interested in preservation of game in Canada, and should like to look into this matter.

Canadian, Montreal, Que.

James Horner's story in December RECREATION of his hunt near Silverton, Oregon, sounds fishy. There are neither curlews nor jack rabbits in that region, and the laws of Oregon limit a hunter to 15 upland birds a

day. Possibly the curlews were blackbirds and the jack rabbits may have escaped from some Belgian hare farm.

W. A. Roberts, Portland, Ore.

You are doing the greatest work for the protection of game, fish, and song birds that has ever been done in any land. There are thousands of good people who are mighty glad you came to this planet to live. Swat, oh! swat the game hogs and the fish hogs, and may Providence and everybody else back you in your swatting.

A. L. Vermilya, Colombiaville, Mich.

Near Eagleville, a little village 5 miles North of here, a good sized bear with one cub was seen by a woman who was picking berries. Several deer have been seen East of this place. Not in many years before have bear and deer been known in this locality.

G. F. Spaulding, Cambridge, N. Y.

The Westchester county, N. Y., Trap Shooters' Association serves notice on the public that it will do everything possible to enforce the law passed by the last Legislature making a close season on ruffed grouse in that county to and including December 31, 1904.

For having 3 quails in his possession after the open season had ended, R. Ison, the East Fourth street, grocer, will pay to the State about \$85, \$75 fine and the costs of prosecution. His case was heard before Squire D. R. Harrick, of West Price Hill, with the above result. According to the Cuvier Club's records, this is Mr. Ison's fifth offence.—Cincinnati Enquirer.

I have just returned from a trip in the North Canada woods, Temiskaming, Quebec. Am prepared to answer questions regarding the region. It is a fine country for all kinds of sport.

O. R. Leonard, 21 Reed Pl., Detroit, Mich.

Since this State prohibited the sale of game comparatively little hunting has been done. The increase in the number of grouse and ducks is already noticeable.

A. H. Lewellen, Schill, Neb.

A yearly subscription to RECREATION is one of the most practicable and useful presents you could possibly give a man or a boy who is interested in nature study, fishing, hunting, or amateur photography.

All boys instinctively love the woods. RECREATION teaches them to love and to study the birds and the animals to be found there. If you would have your son, your brother, your husband, or your sweetheart interested in nature, let him read RECREATION. It costs only \$1 a year, and would make him happy 12 times a year.

FISH AND FISHING.

A REVEREND SINNER PUNISHED.

The facts *in re* State against Rev. W. H. Stone, of Elysian, Le Sueur county, Minn., are as follows: About the 20th of July my wife, daughter and I went to Elysian to enjoy a few days' fishing on Lake Francis, a comparatively small lake, but one of the prettiest bodies of water in the State and a favorite resort for bass fishing. The 23d was excessively hot and my folks preferred the shaded woods to the scorching sun, so they remained ashore while I employed a boatman and went fishing. We went out about 7 in the morning and found this man Stone comfortably anchored in a choice spot with a boat that looked like a protected cruiser. In addition to his casting rod he was using 4 extra rods; and as further evidence of his porcine character he had extra baited hooks on his extra lines. This was shown whenever he landed a fish; and he secured some large bass while I took in the situation. I did not know the man, but ascertained his name; and when I found he was a resident of that place I decided to enlist the services of the county attorney before taking any steps in the matter. We remained on the lake about 2 hours. When we left he was still performing with his formidable array of tackle and did not even take a recess for lunch. We were out 2 hours again in the afternoon and he was still there when I left preparatory to taking the 6 o'clock train. I learned that was his usual custom, and that he generally took his dinner with him and fished all day without intermission. It is quite clear that he and his family could not possibly use all the fish obtained by his operations, and it is equally clear that he was not fishing simply for pleasure.

Immediately on my return home I communicated the facts to Mr. Fullerton, executive agent, and to the county attorney of Le Sueur county and told them I wished to make complaint and have Mr. Stone prosecuted. Mr. Fullerton was much pleased with the notion, but as the county attorney was absent from home my first letter was mislaid. After waiting a reasonable time I again wrote him, offering to prepare the complaint and warrant and go before any justice he might name to make complaint. He promptly responded to this communication, expressed his willingness to prosecute, authorized and requested me to prepare the complaint, and named G. J. Dressel, of Waterville, as the most convenient justice before whom to institute the proceedings. Accordingly, on the 29th of August I went to Waterville, made complaint, had warrant issued, and arranged

for the trial on September 3d, in case of a contest. The arrest was made August 30th, a plea of guilty was entered, a fine of \$25 and \$7 costs were imposed, making a total of \$32, and I was advised the following day and saved the trouble and expense of going to Waterville to testify. I understand that Mr. Fullerton gave the facts to the press and that the case was widely advertised and commented on, but as I was absent from home about that time I did not happen to run across the stuff that was dished up to the preacher. I have, however, met many men, in different parts of the State and in several counties where I have been since that time, who did read it and the universal verdict is that it served him right. I know it served him right, but am glad it is generally so considered. As he was arrested, pleaded guilty and was fined on Saturday I trust that on Sunday he preached from the text, "The way of the transgressor is hard."

Mr. Chas. E. Price, of Currie, Murray county, Minn., should be given full credit for his good work in the following case. April 29th I received a letter from Mr. Price, who is a member of the L. A. S., complaining of illegal fishing at Currie and of his inability to secure satisfaction from the authorities. I immediately laid the information before Mr. Fullerton and a deputy was sent from Fairmont; and through Mr. Price he was able to obtain satisfactory results. May 8th I received the following report from Mr. Price: The State is richer by \$156.80 to-day than it was last night. Deputy Searle, from Fairmont, caught 10 fellows from Walnut Grove, brought in 2 of them and their net, and Justice Millard fined them \$75 apiece, in addition to costs.

Henry A. Morgan, Albert Lea, Minn.

AN ACTIVE LEAGUE WARDEN.

Deputy Sheriff Jackson was out one Sunday in August, looking around for violators of the fish or game laws. He started to go into a piece of brush where he heard shooting and in order to get there he had to cross a brook that we had stocked with trout. When he reached the brook he came right on 2 Poles, who had a net, made of a grain sack, across the brook. One of them was holding the sack while the other one was driving the fish into the net. Mr. Jackson arrested those men, took them to a house near, and left them in care of one of the men at the house. Then he went back, caught the fellow that was shooting robins, and took all 3 down to town. The next day they were fined \$25 each. That was good work.

And Jackson is made of the right kind of stuff.

Special Warden Mephram and I work together a great deal. We have cut up 4 set lines and 4 nets and made 2 arrests this summer. The first arrest was one night after dark. We were down the river about 7 miles from here, at Niskayuna. Just before dark we saw a boat that we thought was using a set line, but by the time we got a boat and got out where they were it was dark and we could not see what they were doing. We rowed past them and turned our boat into the brush and while waiting for them we saw another boat, just above, putting out a line. We waited till they began to bait it, and then we pulled out to them and told them their game was up. We took them before the justice, but as they seemed decent fellows we asked the justice to let them off with a light fine, which he did, fining them \$2 on their promise not to violate the law again.

We caught another man using a set line and took him before our city justice. He claimed he had no jurisdiction, as the offense was committed outside the city limits. I could have taken the man before another justice in Glenville, but as he had nothing but eels and promised to give up his illegal work, I let the case drop.

There was no venison advertised last year after the season had closed. You remember we had a case 2 years ago, and, although we failed to convict the party, it gave people a scare and they are careful not to repeat the offense.

J. W. Furnside, Schenectady, N. Y.

A MASSACHUSETTS FISH HOG.

Harry E. Morse, who is spending a week or 2 at West Centre Harbor, N. H., caught 255 large perch, rock bass, pickerel and horned pouts in 3 hours one day. The perch measured 8 to 12 inches long and weighed half a pound to a pound each. Most of the rock bass were as large as a man's 2 hands, and one of the horned pouts weighed a pound and 7 ounces when dressed. In proof of his remarkable fish story, young Morse shipped a firkin full of dressed fish to the Mirror.

How is this for a fish hog? This clipping was taken from the Danvers Mirror. Morse goes to New Hampshire every summer and makes a hog of himself, but this is the worst record he has shown. If you wish to find out about the truth of this article write to Frank E. Moynahan, editor of the Danvers Mirror. It is claimed some of the fish were sent to him.

R. E., Danvers, Mass.

I wrote Mr. Morse himself for confirmation of the report and he replied:

I did not advertise to have what I caught put in the papers. It is true that I caught 255 perch, pickerel, rock bass and horned pouts in about 4 hours. Some of the fish

weighed as much as 2 pounds apiece, while the smallest weighed about 7 ounces. I had 3 lines out and had my hands full to tend them. Had I had but one pole I would not have caught so many. I fished in Hawkins' lake, about $\frac{1}{4}$ mile from Winona, N. H. I can prove my luck fishing by over 25 of the neighbors around there to whom I gave the fish. I do not brag of my luck, but I know where the fish are in the lakes about there and how to catch them. I used live bait and worms.

Harry E. Morse, Danvers, Mass.

You are a bristly, thick skinned, shameless porker, and I commend to you a careful reading of Mr. Vermilya's "Elegy on a Country Fish Hog," printed on page 273 of October RECREATION. By looking at the picture he draws there, you will see yourself as others see you.—EDITOR.

HOW TO CATCH BASS.

Wallace Schaum, Hartford, Ind., asks why black bass do not bite in Higgins lake, Roscommon county, Michigan. He says they are there, for he can see them 25 feet down in the clear water. For further evidence he asserts that he has seen the natives spear any number of them, which is not his way of fishing. If Mr. Schaum has read and profited by the teachings of RECREATION he should have preferred charges against those native spearmen and should have seen to it that they were prosecuted to the full extent of the law. Michigan has stringent laws for the protection of game fishes from such butchers, and all true sportsmen should be willing to uphold and aid the proper authorities in enforcing these laws. However, if Mr. Schaum will provide himself with a 5½ or 6 foot bait-casting rod, a quadruple 80 yard reel and 50 or 75 yards of fine, strong, hard, braided, silk casting line, an artificial minnow and a few other baits and will closely observe the following directions I will guarantee that black bass, either the large or the small mouth variety, will bite for Mr. Schaum or anyone else.

No intelligent bass will take a bait or lure when visible to the angler or when the angler is perceptible. Black bass are seldom taken by still fishing. Don't let your bait soak. Keep it moving. A moving bait is their ruin, as they will strike for it when not the least hungry, just from pure viciousness. Keep your boat in deep water and cast into shallow places near lily pads and rushes, reeling back slowly after each cast. Cast 50 to 100 feet, getting the bait as far from the boat as possible. Or, let the minnow out 75 or 100 feet back of the boat, and troll, slowly, as near the pads or bars as possible, avoiding snags, and good results are certain to follow. A cloudy or breezy day is

best for bass fishing in clear water; late in the evening if calm.

Fred T. Bradley, Toledo, Ohio.

ILLINOIS CANDIDATES FOR THE PEN.

H. G. Dodds, of this place and H. J. Puterbaugh, of Mackinaw, Ill., claim to have caught, in about 3 hours, 52 black bass, that weighed over 160 pounds, and would have caught as many more if they had not run out of bait. How they could feel proud of such a day's butchery is more than I can see.

You have done much toward making our people ideal sportsmen and aside from these 2 men, who hunt and fish half their time, there is no one here who would be guilty of such conduct. I congratulate you on your success and may you continue the good work.

B. F. Tucker, Morton, Ill.

On inquiry as to the accuracy of this report, these men reply:

Mr. H. G. Dodds and I did catch 52 black bass in 4½ hours, and in August last Mr. H. G. Dodds' wife and son, about 8 years old, my wife, my daughter, 14 years old and I caught 73 black bass in less than 5 hours. We also caught at different times 50 to 100 pounds of pickerel and walleyed pike in a short time.

H. J. Puterbaugh, Mackinaw, Ill.

Mr. Puterbaugh, of Mackinaw, Ill., and I did catch 52 black bass in about 3 hours, and would have caught more had our bait not run out.

H. G. Dodd, Morton, Ill.

You fellows waste your time by fishing with one rod and one line and one hook each. You are evidently not fishing for fun, but for fame and for the pot. Here is a bit of fame for you.

You will hereafter be known to the 330,000 readers of RECREATION as dirty, contemptible swine and there is not a decent man among all these readers who would not like to see you both locked up for 30 days in a high barred corral, with a herd of 4 legged hogs.—EDITOR.

A SHAMEFUL CONTEST.

The trout fishing contest of the Knights of Pythias ended at noon to-day. J. M. Blakeslee's fishermen have the other side beaten so badly that they might as well have kept their fish at home. The total weight of the fish caught by Blakeslee's party was 88½ pounds, while the best the others could do was 37 pounds.

The scores of the individual fishermen were as follows:

JAY M. BLAKESLEE'S PARTY.	
Charles Cliffe, Ed. Gilbert, August Bauman and Jud Cameron.....	46
Charles Hensel.....	10
Tom Gunton.....	8¾
J. M. Blakeslee.....	7¾
C. E. Taylor.....	3½

Fred Curtis.....	1½
B. S. W. Finkle.....	11
Total.....	88½

A. W. RICKERD'S PARTY.

George W. Howard.....	4½
E. R. McCoy and J. W. Hannen.....	1
John Lamson.....	1½
Bert Miller, Dr. Moon and E. S. Williams....	8
H. Monroe.....	3
D. E. Wynkoop.....	4½
H. W. Cunningham.....	5½
J. W. Jarrett.....	9
Total.....	37

This evening the Knights of Pythias will eat the trout and have a banquet at the expense of A. W. Rickerd's side.—Traverse City (Mich.) Evening Record.

It seems that some of the Michigan herd are still at large. It is humiliating to read of members of so good an organization as K. of P. indulging in a fish-slaughtering match like that recorded above. Evidently there are no sportsmen in the Traverse City lodge of the K. of P.—EDITOR.

MOUNTING FISH HEADS.

What is the best and easiest method by which an amateur can preserve a fish head? Where can glass eyes for mounted fish be bought?

L. L. Harrington, Mill Village, Pa.

ANSWER.

The fish head should be carefully cleaned from the inside, free of all flesh. When the flesh has been scraped away, the head should be thoroughly washed, then treated on the inside at all points with arsenical soap. After that the cavities which are overlaid by skin should be filled with potter's clay to replace the flesh. The eyes should be set in papier-maché. Wires to support the head on a shield should be fastened firmly into the back of the skull. The head can then be fixed in position on a board as it is intended to hang when exhibited, the mouth opened properly and held in position by strings and pins until thoroughly dry.

As soon as the head has been mounted and set in position it should be given a coat of white varnish to hold as much of the color as possible. The varnish must, of course, be thinned down with turpentine, so it will not be too thick. It should flow as freely as thin cream.

Glass eyes in endless variety can be had from Fred Kaempfer, dealer in taxidermists' materials, 88 State street, Chicago, Ill.—EDITOR.

RIGHTLY PUNISHED.

Last summer my brother and I spent some time in Clinton county. Up there the law is not obeyed. The natives laughed at us when we told them how many under sized trout we threw back. Their reason was, "The next person that comes along will take the little ones." The people who

lived there would catch a 10 quart pail full of 2 and 3 inch trout. One time a city man and his son went fishing and caught several baskets of fingerlings. The game warden happened to come along and asked them, "What luck?" They opened their baskets and were quickly pulled in. They were fined \$30 each. Served them right.

In September, hounding was going on. The game warden is a sleepy looking fellow and has not yet made an arrest. The reason is his son has hounded, so if he should make an arrest the hunters would give his son away. The hunting and fishing up there were good, but if the hounding keeps up the deer will feel the result. When the hunters hound up there they generally get their venison, but in still hunting they can not always kill the game. I hear they have a new game warden, and I hope he will do some good.

RECREATION is a fine magazine and I hope it may always prosper.

F. S. Mathias, Brooklyn, N. Y.

GRAY TROUT IN CHARLESTON LAKE.

I noticed an article in your August number, page 185, entitled "Salmon Fishing in Charleston Lake," and your footnote, in which you state that the salmon referred to is "probably Atlantic salmon, *Salmo salar*." What the writer of that article calls salmon are only the ordinary gray trout to be found in nearly all Canadian lakes. I have often fished in Charleston lake and caught the fish referred to. The Atlantic salmon has not for many years been caught farther from the sea than Jacques Cartier river, a few miles above Quebec, and it was never to be found in any of the small Ontario lakes, to which, in fact, it could get no access. By publishing this you will correct an error.

John L. Morris, Montreal, Canada.

ANSWER.

You are doubtless right in stating that the fish in question is the ordinary gray trout, or Mackinaw trout, *Cristivomer namaycush*. The use of the name salmon by Mr. Geiger, the size of the fish, and my failure to look up the exact geographic location of the lake mentioned led to the error in identification.—EDITOR.

MISSISSIPPI ANGLERS BEING ROBBED.

I saw a reference in RECREATION to the Yellow Bushy river in Mississippi. There is no such river; probably the Yallahusha was meant. The Yallahusha and Tallahatchie bottoms are still full of bear, deer, turkeys, wolves and panthers. The game is hard to get at, however, because of the density of undergrowth in the swamps. There are 2 lakes South of the bottoms, known as North and South Horn lakes. I camped there a while last summer. They

offer no inducement to anglers, as the fish are being rapidly seined out. A Memphis man named Louis Fritz runs an immense seine there and ships about 2,000 pounds of fish daily. At least 500 weight of this catch is of game fishes. Can not something be done to squelch this hog?

M. R. Williams, Memphis, Tenn.

NIBBLES.

Two friends and I had a successful fishing trip to Rainbow lake last summer, where we stayed a week with 2 guides. The fish bit too fast at the bait, so we tried trolling and got 3 good ones in an hour. There are lots of fish in the lake and it is an excellent place to go. I am a subscriber to RECREATION and like the way you roast the hogs.

Robert Fohs, Millinocket, Maine.

The United States Fish Commission recently planted 10,000 rainbow trout in streams along the lines of the Iron Mountain Railway in Missouri. Among the waters supplied are the Big river, near Irondale, Missouri; the St. Francis river, near Loughborough; and 2 tributaries of the Black river.

Fishing last season at Tomahawk and other Northern Wisconsin lakes was the poorest I ever experienced in any of my 15 consecutive trips. If those chaps really caught 26 muskies in one day, I do not believe it was with hook and line, for fish were not biting at that time.

T. W. Harrington, Greencastle, Ind.

Mr. F. W. Wakeman, of Paw Paw, Mich., county clerk of Van Buren county, caught, in October last, a large mouth bass that weighed 7¼ pounds. He used a light bamboo rod and a small silk line. The fish was the largest of its species taken in that vicinity in years past.

I enjoyed Lake Champlain much last summer. Was at Thompson Point. We caught all the fish we needed; though, on account of high water, the fishing was not up to the usual mark.

C. F. Langworthy, Washington, D. C.

Mr. A. D. Wilson, of Philadelphia, is said to have caught a brook trout at Notre Dame du Lac, Quebec, in September last which weighed 7¼ pounds.

If you wish to make a present to a man or boy who is interested in shooting, fishing, amateur photography, or nature study, give him a year's subscription to RECREATION. Nothing you can possibly buy for \$1 would give him so much pleasure as 12 issues of this magazine. Come early and avoid the rush.

GUNS AND AMMUNITION.

Anybody can shoot all day, but a gentleman will quit when he gets enough.

A NEW 22 CALIBER REPEATER.

I have just been looking over what seems to me one of the finest pieces of the rifle maker's art I have even seen. It is now in process of construction at the Savage Arms Company's plant in Utica, and is the invention of Mr. Arthur W. Savage.

I have owned or used about every 22 caliber rim fire rifle, single shot or repeating, on the market; also many now obsolete. This new Savage rifle, so far as mechanical construction goes, embodies more valuable features than any gun of its class with which I am acquainted. Of its ballistic qualities, it is, of course, premature to judge; but I am assured the barrels will be bored and rifled as accurately and well as American machines and American brains can accomplish.

There is no class of firearms where inaccuracy is so quickly detected as in rifles taking 22 rim fire ammunition, and if extreme accuracy be not obtainable with such a weapon, it is usually soon discarded. Any improvement on these rifles will be heartily welcomed. The 22 has many attractive features. The disappearance of much of the large game removes the incentive to own a rifle suitable for hunting large animals, but the vast increase of interest in field sports has created great and growing demand for rifles that may be used successfully in hunting small game and for target purposes at short range. The 22 rim fire cartridge, particularly the short, long and long rifle, supplies all these demands, and, as well, provides cheapness, comparative safety and a charge shorn of excessive noise and recoil. Many ladies use this type of arm and ammunition, principally, I believe, because of the last-mentioned feature.

The new Savage 22 is a hammerless repeater, take down, with a handsome, well shaped $\frac{3}{4}$ pistol grip, not checkered. The position of the firing pin and striker is automatically indicated by an attachment which also acts as a positive safety, in much the same manner as the safety slide on a double shot gun. The stocks will have rifle or shot gun butt and be of plain or selected walnut, as required. The barrels are full octagon only, and 24 inches long, although on special order shorter and longer barrels, within a reasonable limit, may be had. The slots are cut to take any stand and sight, but the rifle will be regularly furnished with bead front and V rear sights. The action, however, presents the most notable innovation and is a marvel of ease and precision in manipulation. The

frame is smooth and strong, with no projections on top except the safety indicator. The mechanism is entirely contained within the receiver and is actuated by a modification of the well tried sliding fore end, or, so called, trombone action. The motion is short and positive, permitting great rapidity of fire. Ejection is accomplished by expelling exploded shells smartly to the right. The magazine is of the box type, removable at will by a spring catch, placed just within the circle of the trigger guard, and is of thin steel handsomely blued and finished to match the action. This box will be constructed to hold 7 or 8 cartridges, placed horizontally, one on top of the other. They are held automatically in the magazine, which, when put in place, will feed its contents into the rifle until the box is empty. By carrying extra magazines, already charged, the possessor of this little gun can in an instant remove the empty magazine and replace it with one fully charged. The cost of extra magazines will be nominal. This feature demonstrates at sight its convenience and utility, for the ammunition thus safely placed in such a receptacle can suffer no injury; can lose out no bullets nor collect any dirt, and keeps a definite number of cartridges in a position to facilitate most rapid insertion in the rifle. This plan has all the advantages of the clip style of loading, with several additional advantages that will naturally suggest themselves. By providing a reasonable number of extra magazines the work of charging may be done at home, and while afield no one would be obliged to even touch a cartridge.

The use of the popular 22 long rifle cartridge in repeating rifles has always been inconvenient, and the Winchester Company has never made repeaters to handle this shell. The Savage box magazine, however, makes its use entirely feasible. The rifle can be used as a single loader without cutoff, with magazine in position, or it may be used as a single loader with the magazine detached.

I understand the intention is to furnish rifles chambered as desired. The rifle chambered for the 22 long rifle will handle both 22 short and 22 long, also, and will be rifled with one turn in 18 inches. Those chambered for the 22 short will handle that shell only, and be cut with a 20 inch twist. The same magazine will take the 22 long rifle and the 22 long; but another magazine will be required for the 22 short. The action, however, is identical for all 3 cartridges. The system employed could

well be adopted to handle the 25-25, 25-21, 25-20 single shot, 25-10 rim fire and the 22-7-45; and, possibly, should sufficient demand be apparent, such rifles will be put on the market.

There is little excuse for the purchase of a single shot rifle with such a perfected repeating arm obtainable, except the possible matter of cost. This weapon can be as readily and perfectly cleaned and inspected from the breech as can a single shot.

The take down feature is thoroughly strong and practicable and is controlled by a powerful thumb screw. The 2 sections are separable by using no other tools than the fingers, and in a moment's time. The rigidity of the frame is not impaired in the least, the arm being as strong, safe and unyielding as in any solid frame.

The little rifle balances perfectly and is of graceful outline and excellent finish. It is the lightest repeater on the market, as far as I am aware, weighing slightly over 5 pounds. I believe it is bound to encounter a universally favorable reception at the hands of discriminating riflemen, particularly as it is to be sold at a cost no higher than that of competing arms.

E. B. G., Utica, N. Y.

THOSE REMINGTON GUNS.

I am just in receipt of the Remington catalogue for 1902 and it is a thing of beauty, and a joy to me. Ever since I carried a pair of Remington revolvers in Custer's cavalry, in the shindy of '61-'65, I have felt a pride and a confidence in the honest old firm which, notwithstanding the sobering influence of years, tingles in my nerves yet whenever I see or handle a weapon bearing their stamp.

True, the good old man who established the works, and who built into its walls and its methods his own sterling manhood, has long since passed away; but those who stepped into his place have continued the business on the old lines. And so, a Remington once, a Remington always. The name is a synonym for honesty.

It is the custom of manufacturers of arms to claim that every weapon made is tested at the range for accuracy, as well as for sighting. The Remington people make that claim good. Apropos of this factory test claim, I could say something that would queer a firm which has recently withdrawn its ad from RECREATION. A big concern may sometimes trade on its reputation.

The Remington catalogue is more than a mere pictured list of the goods of the firm. It is a work of art from the printer's standpoint.

Looking over its pages one feels that he were hard to please who could not find a shot gun to his fancy. Double or single,

they are all on the square. I hope some good friend may some day present me with a Remington Special double gun, illustrated on page 21 of the new catalogue, and priced at \$750; but I fear I shall not realize on that hope.

In the popular rush for the small bore smokeless the Remingtons have put out the No. 5 rifle, built on the exact lines of the old Creedmoor, with the same old flying lock, better than which nothing has ever been devised. Strength, simplicity, safety, durability, all are wrapped up in its earliest mechanism. It is adapted to the various popular sizes of small bore, powerful smokeless cartridges, including the new 32-40 high pressure. It weighs about 7 pounds.

On a recent visit to Denver I dropped into a gun store and found an obliging clerk who showed me the new Remington-Lee sporting rifle. It is a most beautiful weapon, neat and graceful in contour, and polished like a mirror, the wood of its selected stock beautiful as a dream, and its mechanism smooth as silk.

The columns of guns and ammunition contain many inquiries from young people eager for advice as to what weapon to buy. To all such I say:

Get any rifle you please so it's a Remington. You can not miss it if you get one bearing the old name. Any model, any caliber, any length, any weight; all send their leaden messages true. They hit hard, and they last. You can bet your life on one every time. If you do not drive the tack every time don't look for the fault in the gun. The fault is yours. Keep her clean, draw her true, and then bet your last dollar, if you wish. Don't buy a Mauser, nor a Flobert; buy a Remington. Take care of it, learn it well and keep it.

W. H. Nelson, Eldora, Colo.

A 12-GUAGE LOAD.

Frank A. Ward asks, in August RECREATION, for information as to loading 12 guage shells with Laffin & Rand powder. It has always been my practice to load my own ammunition and having used Laffin & Rand smokeless powder, exclusively, several years, I give the benefit of my experience.

My gun is a 12 guage Ithaca weighing about 7½ pounds, I use Winchester Leader shells, ¾ base, and of as short length as I can get; usually 2½ inches. This powder occupies only small space and the shorter the shell the less wadding will be required.

For grouse and other bird shooting I use 38 grains powder and 1⅛ ounces No. 7 shot; for a medium heavy load, suitable for gray squirrels or ducks in good range, 40 grains powder and 1 3-16 ounces No. 3

shot; for a heavy charge in hunting foxes or chance shots at ducks at long distance, 42 grains powder and $1\frac{1}{4}$ ounces BB shot. Place over the powder one smokeless card wad and enough black edge wads so the shot and one thin Winchester card wad on the same will leave about 3-16 inch of shell for crimping. The Laflin & Rand people have a graduated powder measure, which they sell for 25 cents. I use that in measuring my loads. I have found the above loaded shells exceedingly effective, and when I miss I do not blame my ammunition.

In October, 1901, N. A. Lee of Dexter, N. Y., and I were hunting at the mouth of Black river, Jefferson county, N. Y. We saw a large flock of black ducks coming up the main channel and flying high. They were far out of ordinary shot gun range. Acting on the impulse of the moment, when the ducks were opposite us, I picked up my gun and fired hastily with the left barrel loaded with BB shot. What was our surprise to see a duck drop into the water. My friend laughed and said, "Well! well! 30 rods!" Examination showed that one shot had hit the duck in the head just back of the ear.

On another day about the same time 4 of us were hunting the big marshes of Black River bay. A large bird came flying slowly between us and the shore. It apparently considered itself out of range. Two of us tried a chance shot, but I was the only one to have large shot in my gun. After flying a rod or 2 the bird fell. On being brought in we found 2 BB shot had hit its side and breast. It may be interesting to add that the bird was to us a curiosity. Two of the party had lived and hunted in that vicinity all their lives, but had never seen the like. The taxidermist at Watertown, N. Y., said it was a seabird, a cormorant; and that once in a while one will follow the St. Lawrence river up to Lake Ontario. The bird measures 2 feet from bill to tail.

William J. Gardinier, Herkimer, N. Y.

In answer to F. A. Ward, Sterling, Ill.: After many tests with nitro powder in a 12 gauge 30 inch barrel, I have found 42 grains, 1 field wad, 2 felt wads, $1\frac{1}{8}$ ounces No. 8 chilled shot, firmly crimped, an excellent load. Also, $45\frac{1}{2}$ grains powder, same wadding, $1\frac{1}{4}$ ounces No. 5 shot for larger game. The Winchester Repeating Arms Co. furnish these loads, and their shells are excellent.

Chas. L. Kelsey, Buffalo, N. Y.

HAS DISCARDED MARLIN GOODS.

I am deeply interested in the comments on the Marlin guns. I have been using a Marlin take down repeating shot gun, 12

gauge, 2 barrels, 26 and 30 inches, for the past 6 months. Its action in rapid firing, or rather its non-action or over-action, has caused me to lose a great many birds, as well as a large part of whatever religion I had. One morning I was out with some friends after quails and the first covey found rose in a scattering manner, offering the finest opportunity I ever saw for the use of a pump gun. I fired one shot, and in trying to throw another shell into the barrel, the magazine spring allowed 2 to come into the carriage. That of course locked it tight. If this had occurred only once I might think it was my fault, but it occurs every time I go into the field. I now have my gun advertised for sale, intending to get me a Winchester 16 gauge with 26 and 28 inch barrels. I like the pump guns, but I am through with anything that has "Marlin" stamped on it.

I should be pleased to have users of the Savage rifle give their opinions of it, as I expect to get one at an early date. I should also like to have the views of different users of telescope sights, as I wish to get one for the rifle in question.

We have a large quantity of small game in this section, consisting of quails, squirrels and turkeys, and occasionally a wildcat. There are not many bristle-backs in this country. Nearly everyone observes the game laws.

R. G. Robertson, Junction City, Ark.

RECOMMEND THE 25-35.

If Mr. Huff is looking for a light and effective gun, I advise him to buy a 25-35 half-magazine carbine. I carried one on a 3 months' trip through the Sierra Madre mountains, last fall. I was attracted by its lightness, a point I could fully appreciate after toting a 30-40 Krag. My comrades used 30-30's and a 45-70. They jeered at my popgun, but I had the last laugh. I fired 5 times at 4 bucks and got them all, 3 dropping in their tracks and one running about 100 yards, shot through the lungs. The only other deer secured by our party was hit several times with the 45-70, and then would have escaped, had it not become entangled in a barb wire fence.

James H. Pierce, Boulder, Colo.

In August RECREATION A. Huff finds fault with the 25-35 Winchester. I have no 25-35 to sell, but I can not allow a man who admits he only used it on one or 2 deer to call a good gun bad names. I spend much of my time in the woods as a guide, and have used a 25-35 Winchester 3 years. I think the 30-30 O. K., but the 25-35 has better penetration, flatter trajectory, and greater velocity; shells cost less, make less noise, and have less recoil. I

hear lots about the difficulty of cleaning the 25. If you go about it right it is as easy as any other small caliber..

R. A. Powell, Eureka, Cal.

STILL THEY WRITE PETERS.

Auburn, N. Y.

Messrs. Peters Cartridge Co.,
Cincinnati, Ohio:

Dear Sirs:

After reading your article in RECREATION I feel obliged to write you my experience. In the fall of '98 I bought a Winchester repeating shot gun, 1897 take down model, and a package of Peters' New Victor shells loaded with smokeless powder and No. 8 shot. When I tried to load the gun it was impossible to make the carrier push the shell into the barrel, nor could I push it in with my fingers. When I tried to use the gun as a single shot, the shells stuck in the barrel half way up the brass rim. The dealer I bought them of said it was caused by the shell expanding in loading, and if I would use long brass rim shells they would work better. They did, for the next shells I bought were U. M. C. smokeless with high base, and they worked perfectly. Since that I have used only U. M. C. or Winchester loaded shells and not one of them has ever jammed in the barrel.

The article in April RECREATION is true in Mr. Radcliff's and my cases, and not maliciously false, as you claim. So, Mr. Secretary, you are entitled to another guess.

F. B. Annin.

GOVERNMENT EXPERIMENTS.

The crack shots of the 23d infantry have just returned from Sea Girt with a store of information on rifles and ammunition. A number of experiments were made there by the Government. The new Springfield rifle was tested and found the most powerful military arm on earth. The new cartridge contains about 44 grains of smokeless powder and a 220 grain bullet. Its muzzle velocity is about 2,250 feet. The shell is a little over 2½ inches long and much heavier than the old shell. It has a grooved head like the Mauser shell. Several Krag-Jorgensen rifles were chambered for testing this cartridge, but the gun action was too weak for such a powerful load. Breech bolts were broken so often that it was unsafe to experiment with the old army rifle. A so-called rifle without rifling was also tested, and gave good results. If the new cartridge is ever taken up by sportsmen, gunmakers will have to design a new rifle. I am sure none of the old model rifles could handle this load.

A. J. Hubbard, Color Sergt. 23d Inf.,
Plattsburgh Barracks, N. Y.

A 22 WILL KILL DEER.

In commenting on Mr. Van Dyke's hunting adventures many correspondents have declared that deer can not be killed with a 22 rifle. Without claiming that the 22 is a big game gun, I can assure them that many deer and even larger animals have been killed with that weapon I wish writers would give us more facts about guns and game, and less guff about their individual prowess. RECREATION space is too valuable to waste on private horn blowing

John Patterson, Dell, Mont.

I see several of your readers criticize Mr. Van Dyke's story in February RECREATION. That is probably all right; but when Mr. Patrick, of Cedarville, Mich., says a deer can not be killed with a .22, and that "a healthy deer would run off with all the .22's the U. M. C. Co. could make in a month," he is making as great a mistake as he thinks Mr. Van Dyke did. I have killed deer with a .22 caliber Stevens, using a common short rim fire cartridge.

C. E. T., Pleasantville, Ia.

THE 22 THE BEST SQUIRREL GUN.

In September RECREATION, Buck, of Akron, O., asks for information in regard to the proper gun for squirrel and rabbit shooting. The calibers he mentions are all good, but I think the 22 is sufficiently large for all small game, besides being inexpensive. I prefer a model '90, Winchester, chambered for 22 short only. With this gun I can kill all the game any decent sportsman needs, and the gun is serviceable and easily taken down to put in a trunk.

Uncle Dan, Indianapolis, Ind.

To Buck, Akron, Ohio, I would say that I have had some experience selecting a rifle for squirrels and rabbits. I first tried a 32 but found I could do better with a 22. The latter will kill every time at 100 feet, which is the average range, and will do fair work at 100 yards. The '90 model Winchester 22 short is a good gun for all small game.

C. M. Smith, Campello, Mass.

TWO ACCIDENTAL KILLS.

To C. L. Patrick and others in July RECREATION, I wish to say that I saw a deer killed by one shot from a .22 rifle. I was hunting cottontail rabbits with my brother-in-law on his ranch in Southern California, each of us having a .22 long Winchester. A prong horn buck jumped out of the brush not more than 30 feet from us, trotted a few yards and stopped. My brother-in-law fired at him, just to sting him for his impudence, and was dumb-founded to see the deer jump into the air and fall without a kick. The bullet entered

the brain just in front of the ear and went nearly half way through it. This was as much an accident as was my killing of an eagle with a stone while fishing in Santa Barbara county, some years ago. The eagle came soaring down the creek and I threw a stone at it to frighten it; the huge bird sailed into the stone and went down into the water with a broken neck.

S. O. Blodgett, San Francisco, Cal.

SMALL SHOT.

Will you kindly inform me through RECREATION what gun is best adapted for the big game of Africa, such as lions, elephants, etc. Is the 30-40 Winchester deadly at 2,000 yards, and what is the penetration at that distance?

Charles Thornquest, New York city.

ANSWER.

As a rule, sportsmen in Africa do not limit themselves to one gun, but take a battery of several guns, suited to the different animals. The elephant and the lion are not at all in the same class. Ten and 12-bore rifles have been much used for shooting elephants. The modern high power rifles of 40 and 45 caliber are highly spoken of, as all around rifles, and the .303 is said to kill even elephants fairly well.

The 30-40 is deadly at 2,000 yards in the sense of killing a man or an animal struck in a vital spot. The penetration at that distance I do not know.—EDITOR.

Although the story in RECREATION entitled "The Mystery of a Bullet," by Charles W. Sawyer, does not call for an answer I think I can throw some light on the case. I figure it out that the boys were hunting, several days of their vacation, in a woods near where the sheep went to feed; that one of those queer bullets came straying out of the woods and fell in the pasture of the sheep; and that either the sheep itself ate the bullet by mistake or that the lawyer mentioned in the story fed it to that sheep in order to get a case, as he knew that one of the boys had been bucked by one of that farmer's rams. It would look rather hard for the boys and the case would be easy for him to win for the farmer. The farmer does not prosecute the boys and the villain is foiled once more.

Edwin H. Lankety, New York City.

In July RECREATION there appears an article from the Savage Arms Co., giving the penetration of .303 Savage as 50 inches in tests made at Detroit, Boston and New York. They were made in pine, longitudinally, which the Savage people claim is a greater test of penetration than when made horizontally through pine boards. I do not

question the penetration of the Savage .303 as compared with other arms; but I maintain that any bullet will show greater penetration in wood in line with the grain than across it. I should like to wager the Savage Arms Co. the price of a .303 that they can not show a 50 inch lateral penetration in solid pine with any cartridge used by sportsmen.

W. A. Barr, Chicago, Ill.

RECREATION readers will be interested in a telescope sight manufactured in in this city by Joseph Coxe. For simplicity and ease of application it has no equal. It is composed of lenses in 2 sets. One set is fitted to a folding leaf and attached to the gun in the rear slot; the other set is attached to any peep sight and can be changed to an open sight by simply turning the leaf down. The front sight is not changed and is kept in its regular position. It will plainly show the eyes of a sparrow at 100 yards; a thing impossible with any other sight. It is called the Mag-noscope, and may be had by addressing Mr. Coxe. Price \$4.

J. W. Stapleton, York, Neb.

There is in this vicinity a gun which if not unique is at least rare. It is a 16 gauge, undersnap action, pin-fire, and was made in France. Its chief peculiarity is that it dismounts in 3 sections: the stock, back of the pistol grip; the pistol grip, lock, and about 8 inches of the barrel, making a formidable breech loading horse pistol; and the remainder of the barrel, the length of an ordinary cane. This is fitted with a knob at one end and a ferule at the other, and is colored to imitate wood. A better weapon for a poacher could hardly be devised. The gun is of good quality and workmanship; is still serviceable and in fair condition.

G. A. Mack, Pleasantville, N. Y.

My experience with German and U. M. C. ammunition agrees with that of Messrs. Stokes and Higgins. I find the U. M. C. 7-m-m cartridges stronger, and more cleanly and accurate than the German loads. While on my ranch in Idaho last winter I tested my Mauser against Savage .303, and Winchester and Marlin 30-30. The Mauser proved much more powerful than the others. I do not know that this is any great point in favor of the Mauser, as the .303 and 30-30 shoot hard enough for all practical purposes. I also agree with Mr. Higgins in regard to the good qualities of Laflin & Rand powder.

C. H. Kessler, Oro Fino, Idaho.

A year ago my wife and I wanted each a gun for field and trap use. After looking the matter up thoroughly I placed an order with the Ithaca Gun Co. for 2 guns; one a No. 2, 16-26 6¼ pounds ejector with 13½ inch stock for my wife, the other a No. 4 chester. A pronghorn buck jumped out of used both for game and over the traps, firing thousands of loads, and think our choice of an Ithaca was a wise one. Mrs. Brownie often breaks 20 out of 25 targets; I sometimes get 25 straight. RECREATION'S crusade against the game hogs will go a long way toward improving field shooting.

Leon Brownie, Abilene, Kan.

I notice in the Marble Safety Axe Co.'s ad on the front cover of July RECREATION, a gun sight listed at \$1. It appears to be a front rifle sight. Have any of RECREATION'S readers used it, and if so, do they like it as well as or better than the Lyman sight? The only fault I see with a Savage rifle is that the trigger and lever lock slides too easily backward and forward. It needs only a slight jar after the rifle is a little worn to move the lock back so the trigger is free. If the lock pulled as hard as the trigger, or the trigger pulled as easy as the lock, it would be perfection.

G. W. McHay, Kelsey, Minn.

September RECREATION contained an article suggesting straight grooving for smooth bore rifles. I have such a gun, an old flint lock altered to percussion, which I will give to anyone who cares to experiment with it. The only condition I make is that the result of the experiment be reported to RECREATION. This gun did excellent work in its day, with both balls and shot. It is slightly out of order, but can be readily repaired at slight expense. Will forward by express to first applicant whose name is known to me through RECREATION.

Peter Kachlin, Wickertown, Pa.

I see W. S. Mead wants to hear from someone who has used the Stevens Ideal, No. 44. I have used that arm and can tell Mr. Mead it is excellent for all work for which it is intended. For shooting at 300 to 500 yards, get a 32-40 Stevens No. 44. Tell Mr. Onderdonk that the 38-55 cartridge loaded with full charge of smokeless powder will give about 100 feet greater velocity, a flatter trajectory, and 2 to 3 inches more penetration than the black powder load.

H. C. Walton, York, Pa.

V. J. N., of Dubuque, Ia., will find the 32-40, with mushroom bullets, an admirable gun for deer. For larger game I advise him to get a 7 m. m. Remington-Lee. It is

handsome, exceedingly effective and will bunch 5 out of 6 shots in a 2 inch circle at 200 yards. As a big game gun it is superior to even the Winchester 30-40 and .303 Savage. Last fall I shot a deer at 360 yards with my Remington-Lee. The bullet struck the rump and came out between the shoulders.

Harry James, Flatlands, N. Y.

The sparrow gun described in May RECREATION has killed 125 sparrows to date. I think the heavier a 22 rifle barrel is, if not over 8 pounds, the better the score. The 22 Winchester single is the best of the lot. It will wear 100 years and not get loose. I think the Winchester 1897 take down the best single shot gun on the market. I choose the 16 gauge, moderate choke.

C. Vitous, East Pittsburg, Pa.

I agree with F. Winton of Spring Hill, Tenn., that there is nothing better than the Stevens rifle for small game and target work. I have had one 3 years. Recently I killed one crow at 235 yards and 2 at 210 yards. I use Winchester and U. M. C. long rifle cartridges. My rifle is fitted with globe sight in front and Lyman's combination rear sight.

F. I. Blake, Buda, Ill.

I have an Ithaca \$80 grade gun which I believe is in every respect as good as the \$100 grade of any other make. In shooting quality it can not be beaten at any price. In engraving and checking nothing better could be desired.

M. B. Beecher, Meriden, Conn.

Tell A. L. Tabor, of Los Angeles, that I find the Winchester 22 greaseless bullet cartridge much better than the lubricated. It is clean and more powerful and accurate than any other cartridge.

P. B. Moore, Quaker Hill, Conn.

I should like information from persons who have tried shooting solid lead balls in cylinder bore shot guns.

H. L. Clark, Canton, Pa.

What could be a more desirable present than a yearly subscription to RECREATION? It is one of the most practicable and useful presents you could possibly give a man or boy who is interested in nature study, fishing, hunting, or amateur photography.

All boys instinctively love the woods. RECREATION teaches them to love and to study the birds and the animals to be found there. If you would have your son, your brother, your husband, or your sweetheart interested in nature, let him read RECREATION. It costs only \$1 a year and would make him happy twelve times a year.

NATURAL HISTORY.

When a bird or a wild animal is killed, that is the end of it. If photographed, it may still live and its educational and scientific value is multiplied indefinitely.

DO LYNX KILL DEER?

About 30 years ago I was in upper Michigan with an Indian guide, still hunting deer. Snow had fallen to the depth of 15 or 18 inches. I was trailing 4 deer from their feeding ground to their day beds. To my great surprise I came on the track of a lynx crossing the deer trail at a slight angle. The imprints were large and fresh, stepping into the deer track.

Not caring much about the deer I decided to try for the lynx. The ground was open and a slight ridge lay in the direction the trail indicated. This I studied with the field glass, but failed to locate the lynx. I surmised he was after the deer for some purpose. Acting on this theory I again took up the deer trail with double caution. A little farther on a great crash and snapping of dry twigs told the story; the deer were gone. They could not have seen or winded me.

I found the lynx had followed the deer as far as it deemed safe on the surface of the snow, and then ploughed a furrow deep enough to entirely conceal his approach to within 30 feet of one of the deer that was sleeping by a log. The others were in the tree top near.

The lynx had packed the snow solid with its hind feet to give a send off, and in 2 bounds had landed on the deer's shoulder. Great tufts of hair on the snow told plainly that the deer was caught. After looking the ground over, I started on the trail again, hoping to kill the lynx. Soon I found a crimson spray on the snow. Then marks of a struggle, then a dead deer with its throat torn away. But the lynx was gone, and I realized at once that in following I had gone down wind. There was nothing to do but to return to camp with a new experience.

L. D. Watkins, Lansing, Mich.

Yes, decidedly! Some years ago while hunting in Manitoba I was trailing a jumping deer on a runway. It was just after sunrise and a fresh breeze was blowing from the deer to me. I had been trailing some distance and my deer had been walking all the time, when suddenly he started off with a terrific bound and then stretched out into a wild run. I followed a little way and then went back to where he had started running and took a look around to see if there was any sight of anything that could have started him. Soon I noticed some fresh lynx tracks in the snow. They went up a long poplar tree that leaned across the path. I could see where the lynx

had made his spring and quickly decided to follow to see if I could find any trace of the deer or the lynx. After following the path probably a mile I found Mr. Lynx impaled on a broken limb of a spruce tree, which was also lodged across the path. The limb had been broken by the fall, leaving only a knot probably 10 inches long over the deer path. The deer had passed under but the lynx was pierced to the brain and was still hanging when I found him, with deer hair and blood all over his jaws.

F. L. Wilson, Baker City, Oregon.

The lynx stories in May RECREATION remind me of an incident of my hunting trip 2 years ago. My father and I were after deer in the Sunol foothills. One day, a little before sunrise, we started up the hill back of our camp for another try at deer. We had not gone 200 yards when a wildcat ran to a tree about 40 yards from us. He placed himself between a fork within a few inches of the ground and so stood that only his head presented a mark to us. My father, standing a yard ahead of me, took the shot and missed by half an inch. The cat made off in a direction that kept father between him and me. Before I could get in a position to shoot, father had broken the cat's hind leg. Then it did not take me long to poke in a 255 grain bullet. My shot entered just behind the left shoulder, coming out the other side. The cat was large and his skin made a fine rug.

John Obermuller, Hayward, Cal.

DO BEAVERS EAT FISH?

I went over on the South Platte to fish one day last summer, but found the water low and sluggish and practically no fish. The settlers along 11-Mile canyon, where I fished, startled me with the information that the beavers along the stream destroyed the fish. Beavers are protected in Colorado and are numerous along this stream, as evidenced by dams and work on every hand. There is a good chance on the Platte for the man who claims these wary animals can not be photographed alive, for he can stay on the train and take snap shots at 150 feet.

How old do deer live to be and is it possible to tell their age by any marks about them?

Colorado is still a great game country, and a paradise for lovers of outdoor life and mountain scenery. I saw deer, wildcat, marten and beaver tracks, made the

night before, only 49 miles from Colorado Springs.
Geo. L. Cleaver, Colorado Springs, Colo.

ANSWER.

It is always dangerous to say what animals of a given species will not do, or never can do. Thus far, the world has no direct evidence that a beaver ever has eaten a raw fish. We are, however, all willing to believe that the beavers of the South Platte do eat fish; but before we do so, we must have some direct evidence in proof of it. If a reliable observer should see a beaver eating a fish, or should kill a beaver with portions of a fish in its stomach, I am prepared to believe. Until such evidence is produced I beg leave to disbelieve the story that the beavers of 11-Mile canyon are regularly catching fish for food. There must be some other cause for the disappearance of the fish. It is now well known that muskrats will at times eat flesh; but the muskrat belongs to the rat and mouse family, *Muridae*, and practically all the members of that family are carnivorous, when occasion demands. As far as known up to date, the beaver draws the line at fish.

There is no mark, or marks, by which the age of a deer can be determined. As a general rule, a warm blooded animal attains an age equal to about 3 times the period it requires to reach full maturity. Usually, a deer reaches full maturity in its 5th year. It is my belief that the average life of wild deer is about 15 years.

W. T. H.

COONS, SQUIRRELS, AND GROUSE,

Coons give a cry that is hard to imitate, tremolo whistle beginning high and descending about 10 notes. It is a full round tone that can be heard a long distance. I have heard dozens of coons call, but never in the day time, nor after midnight. I never heard one call except when descending a tree. Have seen them on the ground, in trees, going up and coming down, when they were unconscious of my presence. I have never seen a coon come down a tree in the evening without giving the peculiar cry. On a still night it can be heard half a mile. Coons are heard here nearly every night near the cornfields.

I have seen and shot many gray squirrels and have seen them carrying ears of corn. Have seen 4 grays at once running from a cornfield to the woods, each having an ear of corn in its mouth. If chased hard they would drop the corn. Have known a red squirrel to gather over half a bushel of butternuts, besides hazel and beech nuts. I see you flatly dispute F. E. Williams, of Minnesota. As I have had some experi-

ence, have seen these things myself, and am ready to furnish witnesses to what I have said, you can hardly disagree with me. I have felled 20 or 30 trees in the past few years that had nests in them, and always found more food than you claim, unless food was scarce.

I have seen grouse on the nest, on the drumming log, or rock, at the brook drinking, and wallowing in the dust, for they wallow the same as barnyard fowls. I think I can safely say I have shot 50 grouse when drumming. Have been within 10 feet of a drummer and have seen him drum while I stood there. He was in a dense growth of underbrush, and when he was quiet I stood still, but when he drummed I went toward him. I found the end of the log before I found the grouse.

I am no great hunter nor trapper, but just a man with a natural love for nature and the inhabitants of our forests. Will correspond with any reader if he wishes to make inquiries.

W. R. Collins, Stowe, Vt.

ACCIDENTALLY HUNG.

The picture in August RECREATION of the oriole hanging by the horse hairs from her nest reminds me of a similar case. One day last June I was wheeling along the road and heard an oriole making distress calls in a maple tree overhanging the roadway. I saw she was in trouble, so I procured a ladder and hatchet and cut the branch the nest was on. I found her fast in the hair that lined the nest; some was around her wing and some around her neck. I released her, and then I tied the branch back to its place, as the nest contained 4 nearly full fledged young birds. I hope they came out all right. The oriole is my favorite bird. I watch their coming and nesting every spring. Have always wondered where they go from here, as I never see any after about July 10. Do they go North after raising one brood, or do they change their plumage? An elm is their favorite tree to build in, with maple a close second. I saw one nest in a sycamore and one in an apple tree last year.

M. W. C., Cleveland, O.

One morning last spring I noticed something hanging on a dead branch of a locust tree, swaying in the wind. On closer examination I found it to be a robin hanging by a bit of cord. One end of the cord was in the bird's mouth, then there was one turn of the cord around its neck and the other end was caught in a rough hitch around the limb. My first thought was that a child or some older vandal had hung the bird there. A little study, however, convinced me that was not the case. The victim had evidently been carrying the

string to its unfinished nest when one end caught on the branch. The sudden stoppage of its flight had looped the slack cord around the robin's neck and strangled it.

W. C. Cottright, Wyoming, Pa.

INTRODUCING FRIENDS.

Please name for me the 3 birds I shall describe:

A small bird about the size of a canary; dark blue, almost indigo, all over, except the under part of its tail and wings, which are a brownish gray.

A swallow which builds a nest on the rafters of buildings. The nest is made of mud and is open at the top. The bird is a little longer than a sparrow, but not so heavily built. The entire upper parts appear black, but I think they are dark purple. The under parts are light chestnut. The tail is long and deeply forked. The 2 outer feathers are over 2 inches long. The others are shorter and have a white band across them.

A swallow that builds under the eaves. The nest is closed above, with a small hole leading in at the side. Birds are dark purple above, with a bright chestnut patch on the rump. Their under parts are pale chestnut. There is a small white spot just above the beak on the forehead. Their tails are not forked and they are more heavily built than the other kind.

H. H. Clark, Maple Park, Ill.

ANSWER.

Mr. C. William Beebe, assistant curator of birds in the Zoological park, identifies the birds described by Mr. Clark, as follows:

Indigo bunting, *Passerina cyanea*.

Barn swallow, *Chelidon erythrogaster*.

Cliff- or eave swallow *Petrochelidon lunifrons*.

Mr. Beebe says Mr. Clark has the rare gift of picking out the chief characteristics of a bird for identification.—EDITOR.

THE DIPPER, OR WATER OUZEL.

In July RECREATION C. W. Morgaridge asks for some light on the habits of the water ouzel, saying he has detected this little acrobat in questionable tricks. Does he refer to the American dipper, *Cinclus mexicanus*? For 16 years, in Idaho, this jolly little fellow has been one of my most intimate avian friends, and during all that time I have never detected him doing anything that a decent and self-respecting bird should not do. I have sat hours beside some brawling mountain torrent and watched a pair of dippers feeding their young and have never seen so much as a minnow carried to the nest. Their food; during the breeding season,

consists almost exclusively of the larvæ of the salmon fly that abounds in all Western streams during that season. The bird is one of our few winter residents; descending from the higher mountain stream to the larger rivers where there is little danger of a sudden freeze shutting off its food supply. The examination of several crops of those killed during the winter showed an almost total absence of animal food, but a great deal of vegetable matter gathered from the rocks along the rivers and from drifts. Let no man injure one of these birds thinking thereby to perpetuate the trout supply.

C. S. Moody, Sand Point, Ida.

PROBABLY A WIDGEON.

Several years ago, while snipe shooting, I saw a duck swimming on a small lake near here. Having secreted myself behind a stone wall I asked a friend to go around the lake and drive the duck across. This he did, and when about 8 rods from me, the bird rose almost perpendicularly from the water. I shot and killed it. I give color and measurements: Length, 18¼ inches; wing, from first joint to tip, 10½ inches; tail 3½ inches; tarsus, 1¾ inches. Head similar to that of black duck, only perhaps a little lighter; belly, white; breast, back and neck, a yellowish grey; speculum, dark green, the first feather being nearly white; crissum, white with brown spots; bill, bluish; feet and tarsus, dusky. The bird resembles a gadwall more than any duck I know, and is evidently a river duck, as indicated by its hind toe. Should you be unable to identify it, kindly submit it to the readers of your excellent journal.

W. A. Mead, Carmel, N. Y.

ANSWER.

The description answers more nearly to a female American widgeon or baldpate (*Mareca americana*), or the female European widgeon (*Mareca penelope*), than to any other river duck.—EDITOR.

THEY WERE ALL MULE DEER.

I have read your answer to Mr. Morris. Also the letter by Mr. Lea in regard to the mule deer of the Northwest. I trapped one winter in California, and deer meat was one of our staple articles, both for food and for bait. We procured it from a species of deer that the natives called mule-tail, named, as they told me, from the long, bushy tail like unto a mule's tail newly trimmed. It is the only deer they have in that part of California and in Oregon; farther South and West, and in the coast range, can be found plenty of blacktail deer. I see the Universal dictionary defines mule deer as you do. A California writer defines mule deer as a hybrid of the

elk and blacktail deer, and to judge from its size I should think he was right. I imagine Mr. Lea killed his mule deer after the horns were dropped, as they are not noted for their large horns. I killed one near Happy Camp, Cal., that had 15 points, and I saw the horns of one killed near Goose lake that had 22 points.

E. M. Gravett, Gravett, Ark.

That California writer should have a guardian and should be prevented from putting out any more such twaddle.—EDITOR.

NATURAL HISTORY NOTES.

One evening, about dusk, I thought I heard the well known call of a quail. As the house in which I live is in the heart of the city, and almost adjoining a large department store, I decided it was fancy only, as all day my mind had dwelt on what an ideal day it was to be afield. However, I opened my window and gave the 3 successive calls quails use in the fall, when I was immediately answered. I repeated the call, and the answer came nearer, till suddenly it ceased. I hurried out to the street, only to meet my landlady's little boy with a hen quail in his hands, which he said he had just caught in Parkway, it having apparently become dazed by the electric light. It was in no way crippled and is alive yet. It will be liberated as soon as any of us go into the country. I am wondering how it got here.

Bunny, Allegheny, Pa.

In August RECREATION you defend squirrels against the charge of stealing corn, and you ask for more evidence. A negro in this State planted a patch of corn adjoining a piece of pine sapling land. About the time he shocked the crop, domestic trouble caused him to abandon his home and the squirrels harvested his corn. They carried all the good ears to the tops of saplings and hung them there, turning back the husks, but not cutting them off. I have thrown seed corn in the cob on the piazza of my house and watched the squirrels carry it up into the live oaks about the place. I protect squirrels so far as I can, and if I testify against them in this case it is merely to answer your question.

C. S. Johnson, Beaufort, S. C.

I have been a squirrel hunter many years and have often been told that, especially in a dry season, I should go near water to find squirrels. I have yet to see a squirrel drink water and have never met a man who had seen them drink. Should like to hear from brother sportsmen on this subject

R. B. Stowers, Cupio, Ky.

Inkie takes a good long drink every day

of his life, often from a cup or a glass held by some of his many human friends, and I have often seen other tame squirrels drink.—EDITOR.

The strange noise described by Mr. Covert in March RECREATION was certainly made by a species of sucker. Some 4 years ago my cousin and I were fishing just above the Elkader dam, on Turkey river, in Iowa. A lot of foam and drift wood had floated up to the dam. Under the debris in one particular place we heard the peculiar sound. My cousin struck the spot with our canoe paddle and a good sized red-horse came to the top, but before we could pick it up it came to and darted away.

J. P. Jaeger, Independence, Ia.

In August RECREATION Edwin I. Haines tells of finding the grey cheeked thrush in the Catskills. Is it not much more probable that he saw, not the grey cheeked thrush, whose breeding range is said to be Labrador and Northwestward to Alaska, but the sub-species, *T. a. bicknelli*, or Bicknell's thrush; a bird which closely resembles the other and is known to breed on several of the highest points of the Catskills? I. McC. L., Haines Falls, N. Y.

I think it a fact that of a pair of mallards, the duck generally takes flight before the drake. I have noticed, when duck shooting, that birds dropped with the first barrel were seldom, if ever, drakes.

I can match Mr. Thatcher's story of the snake that ate corn. A few years ago, while husking corn, I found a large garter snake under a shock, and killed it. Its stomach was completely filled with shelled corn.

H. C. Beahler, Chicago, Ill.

This week I went to a stationer's to get a copy of a weekly sporting paper published in New York and devoted to fish and game topics, as there was some curiosity in my mind regarding the stand the paper was taking on the game hog question. I have not taken the paper for some years. The stationer told me there was so little call for it that he had cut out his order. I never miss a number of RECREATION, but I was looking for information, so I asked him if he kept that magazine. His answer was pithy and to the point: "We certainly do. RECREATION sells."

Henry A. Allen, Minneapolis, Minn.

A yearly subscription to RECREATION is one of the most practicable and useful presents you could possibly give a man or a boy who is interested in nature study, fishing, hunting, or amateur photography. It costs only \$1 a year, and would make him happy 12 times a year.

THE LEAGUE OF AMERICAN SPORTSMEN.

OFFICERS OF THE L. A. S.

President, G. O. Shields, 23 W. 24th St., New York.

1st Vice-President, E. T. Seton, 80 West 40th St., New York.

2d Vice-President, W. T. Hornaday, 2969 Decatur Ave., Bedford Park, N. Y.

3d Vice-President, Dr. T. S. Palmer, Dept. of Agriculture, Washington, D. C.

4th Vice-President, A. A. Anderson, 6 East 38th St., New York.

5th Vice-President, Hon. W. A. Richards, General Land Office, Washington, D. C.

Secretary, A. F. Rice, 155 Pennington Ave., Passaic, N. J.

Treasurer, Austin Corbin, of the Corbin Banking Co., 192 Broadway, New York City.

ARIZONA DIVISION.

M. J. Foley, Chief Warden, Jerome.

ARKANSAS DIVISION

W. R. Blockson, Chief Warden, Mena.

CALIFORNIA DIVISION.

Dr. David Starr Jordan, Chief Warden, Leland Stanford University. C. Barlow, Sec.-Treas., Santa Clara.

COLORADO DIVISION.

A. Whitehead, Chief Warden, 303 Tabor Building, Denver.

CONNECTICUT DIVISION.

Hon. F. P. Sherwood, Chief Warden, Southport; Dr. H. L. Ross, Vice-Warden, Canaan; H. C. Went, Sec.-Treas., Bridgeport.

DISTRICT OF COLUMBIA DIVISION.

C. H. Townsend, Chief Warden, U. S. Fish Commission.

FLORIDA DIVISION.

W. W. K. Decker, Chief Warden, Tarpon Springs

GEORGIA DIVISION.

J. J. Doughty, Chief Warden, Augusta.

IDAHO DIVISION.

L. A. Kerr, Chief Warden, Kendrick

ILLINOIS DIVISION.

M. D. Ewell, M.D., Chief Warden, 59 Clark St., Chicago; F. M. Taber, Vice Warden, 144 Kinzie St., Chicago; G. C. Davis, Sec.-Treas., 123 S. Central Ave., Austin.

INDIANA DIVISION.

Frank L. Littleton, Chief Warden, 30½ East Washington St., Indianapolis; J. J. Hildebrandt, Vice Warden, Logansport; T. J. Carter, Sec.-Treas., State House, Indianapolis.

IOWA DIVISION.

Carl Quimby, Chief Warden, Des Moines; C. C. Proper, Sec.-Treas., Des Moines.

KANSAS DIVISION.

O. B. Stocker, Chief Warden, Wichita; A. J. Applegate, Sec.-Treas., 113 E. 1st St., Wichita

KENTUCKY DIVISION.

Geo. C. Long, Chief Warden, Hopkinsville.

R. L. Brashear, Sec.-Treas., Bowling Green.

MAINE DIVISION.

Col. E. C. Farrington, Chief Warden, Augusta.

MASSACHUSETTS DIVISION.

Heman S. Fay, Chief Warden, Hazleton Block, Marlboro; J. E. Tweedy, Vice-Warden, North Attleboro; A. C. Lamson, Sec.-Treas., 194 Main St., Marlboro.

MICHIGAN DIVISION.

J. Elmer Pratt, Chief Warden, Grand Rapids; R. S. Woodliffe, Vice-Warden, Jackson; A. B. Richmond, Sec.-Treas., Grand Rapids.

MINNESOTA DIVISION.

Dietrich Lange, Chief Warden, 2294 Commonwealth Ave.

St. Paul; H. A. Moigan, Vice-Warden, Albert Lea; A. R. Bixby, Sec.-Treas., 101 Baldwin St., St. Paul.

MISSOURI DIVISION.

Bryan Snyder, Chief Warden, 726 Central Bldg., St. Louis.

MONTANA DIVISION.

Professor M. J. Elrod, Chief Warden, Missoula; Sidney M. Logan, Vice-Warden, Kalispell; R. A. Waagner, Sec.-Treas., Bozeman.

NEBRASKA DIVISION.

Fred. E. Mockett, Chief Warden, Lincoln; P. O'Mahony, Sec.-Treas., Lincoln.

NEVADA DIVISION.

Dr. W. H. Cavell, Chief Warden, Carson.

Geo. W. Cowing, Sec.-Treas., Carson.

NEW HAMPSHIRE DIVISION.

Dr. A. F. Barrett, Sentinel Bldg., Keene,

Sidney Conant, Sec.-Treas., Keene.

NEW JERSEY DIVISION.

A. W. Van Saun, Chief Warden, Pompton Plains;

Dr. W. S. Colfax, Vice-Warden, Pompton Lakes; I. V. Dorland, Sec.-Treas., Arlington.

NEW MEXICO DIVISION.

W. M. Borrowdale, Chief Warden, Magdalena.

NEW YORK DIVISION.

John R. Fanning, Chief Warden, Powers' Bldg., Rochester; Col. R. E. Moss, Vice-Warden, Wallack's Theatre, New York City; Dr. C. C. Curtis, Sec.-Treas., Columbia College, New York City.

NORTH DAKOTA DIVISION.

Dr. W. D. Jones, Chief Warden, Devil's Lake.

OHIO DIVISION.

W. E. Gleason, Chief Warden, Mitchell Bldg., Cincinnati; A. C. Thatcher, Vice-Warden, Urbana.

OKLAHOMA DIVISION.

W. M. Grant, Chief Warden, Oklahoma City.

ONTARIO DIVISION.

C. A. Hammond, Chief Warden, Box 701, St. Thomas; D. L. Mells, Sec.-Treas., St. Thomas.

OREGON DIVISION.

Robert F. Kelly, Chief Warden, Box 188, The Dalles; C. B. Cushing, Sec.-Treas., The Dalles.

PENNSYLVANIA DIVISION.

C. F. Emerson, Chief Warden, 189 N. Perry St., Titusville; Hon. C. B. Penrose, Vice-Warden, 1729 Spruce St., Philadelphia; E. Wager-Smith, Sec.-Treas., 1026 Ridge Ave., Philadelphia.

RHODE ISLAND DIVISION.

Zenas W. Bliss, Chief Warden, 49 Westminster St., Providence.

SOUTH CAROLINA DIVISION.

C. F. Dill, Chief Warden, Greenville.

SOUTH DAKOTA DIVISION.

D. C. Booth, Chief Warden, Spearfish; John C. Barber, Sec.-Treas., Lead.

TENNESSEE DIVISION.

Hon. G. C. Martin, Chief Warden, Clarksville; Hon. Austin Peay, Jr., Sec.-Treas., Clarksville.

TEXAS DIVISION.

Prof. S. W. Stanfield, Chief Warden, San Marcos; W. E. Heald, Sec.-Treas., San Angelo.

UTAH DIVISION.

Hon. John Sharp, Chief Warden, Salt Lake City.

VERMONT DIVISION.

W. E. Mack, Chief Warden, Woodstock; S. C. White, Sec.-Treas., Woodstock.

VIRGINIA DIVISION.

Franklin Stearns, Chief Warden, 13 N. 11th St., C. O. Saville, Vice Warden, Richmond; M. D. Hart, Sec.-Treas., 1217 East Main St., Richmond.

WASHINGTON DIVISION.

F. S. Merrill, Chief Warden, Spokane; F. A. Pontius, Sec.-Treas., Seattle; Munro Wyckoff, Vice-Warden, Pt. Townsend.

WEST VIRGINIA DIVISION.

E. F. Smith, Chief Warden, Hinton,
WISCONSIN DIVISION.

Frank Kaufman Chief Warden, Two Rivers; Dr.
A. Gropper, Sec.-Treas., Milwaukee.

WYOMING DIVISION.

H. E. Wadsworth, Chief Warden, Lander; Frank
Bond, Sec.-Treas., Cheyenne.

*Applications for membership and orders for badges
should be addressed to Arthur F. Rice, Secretary, 23 W.
24th St., New York.*

LOCAL WARDENS IN NEW YORK.

County.	Name of Warden.	Address.
New York	Conrad L. Meyer,	46 W. Broadway.
Livingston	M. De La Vergne,	Lakeville.
	K. S. Chamberlain,	Mt. Morris.
Albany,	C. D. Johnson,	Newtonville.
"	Henry T. Newman,	"
"	Kenneth E. Bender,	Albany.
Broome,	John Sullivan,	Sanitaria Springs
"	R. R. Mathewson,	Binghamton.
Cayuga,	H. M. Haskell,	Weedsport.
Chemung,	Fred Uhle,	Hendy Creek,
"	M. A. Baker,	Elmira.
Cortland,	James Edwards,	Cortland.
Erie,	E. P. Dorr,	103 D. S. Morgan Building, Buffalo.
"	Marvin H. Butler,	Morilla.
Essex,	W. H. Broughton,	Moriah.
Franklin,	Jas. Eccles,	St. Regis Falls.
Montgomery,	Charles W Scharf,	Canajoharie.
Oneida,	J. M. Scoville,	Clinton.
Orange,	Wilso' Crans,	Middletown.
"	J. Hampton Kidd,	Newburgh.
"	Thomas Harris,	Port Jervis.
Richmond,	Lewis Morris,	Port Richmond.
St. Lawrence,	Dr. B. W. Severance,	Gouverneur.
	A. N. Clark,	Sevey.
Schenectady,	J. W. Furnside,	Schenectady.
Suffolk,	F. J. Fellows,	Central Islip, L. I.
"	P. F. Tabor,	Orient, L. I.
Tioga,	Geo. Wood,	Owego.
Washington,	C. L. Allen,	Sandy Hill.
"	A. S. Temple,	Whitehall.
"	J. E. Barber,	Dresden.
Westchester,	George Poth,	Pleasantville.
"	Chas. Seacor,	57 Pelham Road, New Rochelle.
"	M. W. Smith,	Croton Falls.
"	Ralph Gorham,	Mt. Kisco
Dutchess,	A. B. Miller,	Jackson's Corners
Columbia,	James Lush,	Memphis.
Onondaga,	B. L. Wren,	Penn Yan.
Yates,	Symour Poineer,	Branch Port.
Dutchess,	Chas. H. DeLong,	Pawling.
"	Jacob Tompkins,	Billings.
Queens,	Gerard Van Nostrand,	Flushing, L. I.
"	W. S. Mygrant,	46 Elton Street, Brooklyn.
"	P. A. Geepel,	473 Grand Ave., Astoria, L. I.
"	L. B. Drowne,	119 Somers Street, Brooklyn.
Ulster,	M. A. DeVall,	The Corners.
	Wm. S. Mead,	Woodstock.
Jefferson,	C. J. Smith,	Watertown.
Herkimer,	D. F. Sperry,	Old Forge.
Oswego,	J. E. Manning,	154 West Utica St.
Putnam,	H. L. Brady,	Mahopac Falls.
Schuyler,	G. C. Fordham,	Watkins.
Allegany,	G. A. Thomas,	Belvidere.
Schoharie,	O. E. Eigen,	Sharon Springs.
Warren,	Geo. McEchon,	Glen Falls.
Orleans,	J. H. Fearby,	E. Shelby.
Greene,	W. J. Soper,	Windham.

LOCAL WARDENS IN OHIO.

Stark,	A. Dangeleisen,	Massillon.
Franklin,	Brook L. Terry,	208 Woodward Av., Columbus.
Cuyahoga,	A. W. Hitch,	161 Osborn St., Cleveland.
Clark,	Fred C. Ross,	169 W. Main St., Springfield.
Erie,	David Sutton,	418 Jackson St., Sandusky
Fulton,	L. C. Berry,	Swanton
Hamilton,	W. C. Rippey,	4465 Eastern Ave., Cincinnati.

County.	Name of Warden.	Address.
Allen,	S. W. Knisely,	Lima.
Knox,	Grant Phillips,	Mt. Vernon.
Lorain,	T. J. Bates,	Elyria.
Ottawa,	Frank B. Shirley,	Lakeside.
Muskingum,	Frank D. Abell,	Zanesville.
Scioto,	J. F. Kelley,	Portsmouth.

LOCAL WARDENS IN CONNECTICUT.

Fairfield,	George B. Bliss.	2 Park Row, Stam- ford, Ct.
"	Harvey C. Went,	11 Park St., Bridge- port, Ct.
Fairfield,	Samuel Waklee,	Box 373, Stratford.
Litchfield,	Dr. H. L. Ross,	P. O. Box 100, Can- naan, Ct.
Middlesex,	Sandford Brainerd	Ivoryton.
New Haven,	Wilbur E. Beach,	318 Chapel Street, New Haven, Ct.
"	D. J. Ryan,	188 Elizabeth St., Derby.

LOCAL WARDENS IN MASSACHUSETTS.

Norfolk,	Orlando McKenzie,	Norfolk.
"	J. J. Blick,	Wrentham
"	S. W. Fuller,	East Milton.
Suffolk,	Capt. W. J. Stone,	4 Tremont Row Boston.
Worcester,	B. H. Mosher,	Athol.

LOCAL WARDENS IN NEW JERSEY.

Mercer,	Jos. Ashmore,	124 Taylor St., Trenton.
Mercer.	Edw. Vanderbilt,	Dentzville, Trenton.
"	Roland Mitchell,	739 Centre St., Trenton
Morris,	Joseph Pellet,	Pompton Plains.
"	Chas. W. Blake,	Dover.
"	Francis E. Cook,	Butler.
Somerset,	Calone Orr,	Hibernia.
Sussex,	G. E. Morris,	Somerville.
Union,	Isaac D. Williams,	Branchville.
	A. H. Miller,	Cranford.
	C. M. Hawkins,	Roselle.
Warren,	{ Jacob Young, Reuben Warner, }	{ Phillipsburg.
Monmouth.	Dory-Hunt,	Wanaque.
Hudson,	A. W. Letts,	51 Newark St., Hoboken.

LOCAL WARDENS IN PENNSYLVANIA.

Jefferson;	John Noll,	Sykesville.
Perry,	Samuel Sundy,	Lebo.
Warren.	F. P. Sweet,	Goodwill Hill.
"	Nelson Holmes,	Cornplanter.
Juniata,	Clifford Singer,	Oakland Mills.
"	Ezra Phillips,	McAlesterville.
Venango,	G. D. Benedict,	Pleasantville.
Potter,	Ira Murphy,	Coudersport.
"	Wiley Barrows,	Austin.
"	Chas. Barrows,	Austin.
Crawford,	Jasper Tillotson,	Tillotson.
"	Geo. T. Meyers,	Titusville.
"	J. B. Lamb,	Buel.
Cambria,	W. H. Lambert,	720 Coleman Ave., Johnstown.
Butler,	F. J. Forquer,	Murrinsville.
Allegheny,	S. H. Allen,	Natrona.
Beaver,	N. H. Covert,	Beaver Falls.
"	W. R. Keefer,	"
McKean,	C. A. Duke,	Duke Center.
"	L. P. Fessenden,	Granere.
"	Wm. Holsinger,	Stickney.
Lackawanna,	Wm. Weir,	Moosic.
"	Wm. Major,	"
Carbon,	Asa D. Hontz,	East Mauch Chunk.
Cumberland,	J. C. Gill,	Mechanicsburg.
Wyoming,	Cyrus Walter,	Tunkhannock.
Tioga,	E. B. Beaumont, Jr.,	Lawrenceville.
"	G. H. Simmons,	Westfield.
Lycoming,	Jas. J. Brennan,	Oval.
"	B. D. Kurtz,	Cammal.
Delaware,	Walter Lusson,	Ardmore.
Montgomery,	L. C. Parsons,	Academy.
Bradford,	Geo. B. Loop,	Sayre.
Clarion,	Isaac Keener,	New Bethlehem.
Cameron,	Harry Hemphill,	Emporium.
Clinton,	M. C. Kepler,	Renovo.
"	Geo. L. Kepler,	Renovo.
Northumber- land,	{ G. W. Roher, 505 Anthracite St.,	{ Shamokin.
Elk,	D. R. Lobaugh,	Ridgway.

LOCAL WARDENS IN MICHIGAN.

County.	Name of Warden.	Address.
Ottawa,	W. H. Dunham,	Drenthe.
Kalamazoo,	C. E. Miller,	Augusta.
Berrien,	W. A. Palmer,	Buchanan.
Cass,	Thomas Dewey,	Dowagiac.
Hillsdale,	C. A. Stone,	Hillsdale.
Lake,	John Trieber,	Peacock.

LOCAL WARDENS IN VIRGINIA.

Mecklenburg,	J. H. Ogburn,	South Hill.
King William,	N. H. Montague,	Palls.
Smythe,	J. M. Hughes,	Chatham Hill.
King & Queen,	R. D. Bates,	Newtown.
Louisa,	J. P. Harris,	Applegate.
Henrico,	W. J. Lynham,	412 W. Marshall.
Richmond.		
East Rockingham,	E. J. Carickhoff,	Harrisonburg.

LOCAL WARDENS IN WYOMING.

Fremont,	Nelson Yarnall,	Dubois.
Uinta,	{ S. N. Leek,	} Jackson.
	{ F. L. Peterson,	
Carbon,	Kirk Dyer,	Medicine Bow.
Laramie,	Martin Breither,	Cheyenne.

LOCAL WARDENS IN TENNESSEE.

Sumner,	W. G. Harris,	Gallatin.
Stewart,	John H. Lory,	Bear Spring.
Robertson,	C. C. Bell,	Springfield.
Montgomery,	P. W. Humphrey,	Clarksville.
Madison,	H. T. Rushing,	Jackson.

LOCAL WARDENS IN NEBRASKA.

Hall,	E. C. Statler,	Grand Island
-------	----------------	--------------

LOCAL WARDENS IN NEW HAMPSHIRE.

Cheshire,	S. C. Ellis,	Keene.
Sullivan,	G. A. Blake,	Lempster.
"	J. W. Davidson,	Charlestown.

LOCAL WARDENS IN VERMONT.

Rutland,	Wm. J. Liddle,	Box 281, Fair Haven
Windsor,	F. A. Tarbell,	West Bridgewater.
Orleans,	E. G. Moulton,	Derby Line.
Essex,	H. S. Lund,	Granby.

LOCAL WARDENS IN ILLINOIS.

Rock Island,	D. M. Slottard,	12th Ave. and 17th St., Moline.
Iroquois,	J. L. Peacock,	Sheldon.

LOCAL WARDENS IN OKLAHOMA.

Kiowa and Comanche Nation,	A. C. Cooper,	Ft. Sill.
----------------------------	---------------	-----------

LOCAL WARDENS IN IOWA.

Clinton,	D. L. Pascol,	Grand Mound.
Pottawattamie,	Dr. C. Engel,	Crescent.

LOCAL WARDENS IN WASHINGTON.

Okanogan,	James West,	Methow.
Stevens Co.,	Jacob Martin,	Newport.

LOCAL WARDENS IN UTAH.

Washington,	S. C. Goddard,	New Harmony.
-------------	----------------	--------------

LOCAL CHAPTERS.

Albert Lea, Minn.,	H. A. Morgan,	Rear Warden.
Angelica, N. Y.,	C. A. Lathrop,	"
Augusta, Mont.,	H. Sherman,	"
Austin, Minn.,	G. F. Baird,	"
Austin, Pa.,	W. S. Warner,	"
Boston, Mass.,	Capt. W. I. Stone,	"
Buffalo, N. Y.,	H. C. Gardiner,	"
Cammal, Pa.,	B. A. Ovenshire,	"
Champaign Co., O.	Hy. F. MacCracken	"
	Urbana.	"
Charlestown, N. H.,	W. M. Buswell,	"
Cheyenne, Wyo.,	J. Hennessy,	"
Choteau, Mont.,	G. A. Gorham,	"
Cincinnati, Ohio,	B. W. Morris,	"
Coudersport, Pa.,	I. L. Murphy,	"
Cresco, Iowa,	J. L. Platt,	"
Davis, W. Va.,	J. Heltzen,	"
Dowagiac, Mich.,	W. F. Hoyt,	"
East Mauch Chunk, Pa.,	E. F. Fry,	"
Evansville, Ind.,	F. M. Gilbert,	"
Fontanet, Ind.,	W. H. Perry,	"
Ft. Wayne, Ind.,	W. L. Waltmarth	"
Great Falls, Mont.,	J. M. Gaunt,	"
Heron Lake, Minn.,	K. C. Buckeye,	"
Holidays'g, Pa.,	H. D. Hewit,	"
Hopkinsville, Ky.,	Hunter Wood,	"
Indianapolis, Ind.,	Joseph E. Bell,	"
Jerome, Ariz.,	Dr. L. A. Hawkins,	"
Johnsonburg, Pa.,	W. J. Stebbins,	"
Kalispell, Mont.,	John Eakright,	"
Keene, N. H.,	F. P. Beedle,	"

Kingfisher, Okla.,	A. C. Ambrose,	Rear Warden.
Lake Co., Ind.,	Dr. R. C. Mackey,	"
Lawton, O. T.,	Marion Miller,	"
Logansport, Ind.,	E. B. McConnell,	"
Ludington, Mich.,	G. R. Cartier,	"
Mechanicsburg, Pa.,	Dr. J. H. Swartz,	"
Minturn, Colo.,	A. B. Walde,	"
New Albany, Ind.,	Dr. J. F. Weathers,	"
New Bethlehem, Pa.,	Isaac Keener,	"
Penn Yan, N. Y.,	Dr. H. R. Phillips,	"
Princeton, Ind.,	H. A. Yeager,	"
Reynoldsville, Pa.,	C. F. Hoffman,	"
Ridgway, Pa.,	T. J. Maxwell,	"
Rochester, N. Y.,	C. H. McChesney	"
St Paul, Minn.,	O. T. Denny,	"
St. Thomas, Ont.,	L. J. Hall,	"
Schenectady, N. Y.,	J. W. Furnside,	"
Seattle, Wash.,	M. Kelly,	"
Syracuse, N. Y.,	C. C. Truesdell,	"
Terre Haute, Ind.,	C. F. Thiede,	"
The Dalles, Ore.,	C. B. Cushing,	"
Walden, N. Y.,	J. W. Reid,	"
Wichita, Kas.,	Gerald Volk,	"
Winona, Minn.,	C. M. Morse,	"

DISCOUNTS TO LEAGUE MEMBERS.

The following firms have agreed to give members of the L. A. S. a discount of 2 per cent. to 10 per cent. on all goods bought of them. In ordering please give L. A. S. number:

Syracuse Arms Co.,	Syracuse, N. Y.	Guns.
Davenport Fire Arms Co.,	Norwich, Conn.	Shot guns, rifles.
Gundlach Optical Co.,	Rochester, N. Y.	Photographic goods.
Blair Camera Co.,	Rochester, N. Y.	Photographic goods.
The Bostwick Gun and Sporting Goods Co.,	1528 Arapahoe St., Denver, Col.	
James Acheson,	Talbot St., St. Thomas, Ontario,	Sporting goods.
Jespersen & Hines,	10 Park Place, New York City	

LIFE MEMBERS OF THE LEAGUE.

W. D. Ellis,	136 W. 72d street, New York City.
A. F. Rice,	155 Pennington avenue, Passaic, N. J.
Dr. W. A. Valentine,	5 W. 35th street, New York City.
A. A. Anderson,	6 E. 38th street, New York City.
A. V. Fraser,	478 Greenwich street, New York City.
E. S. Towne,	care National Bank Book Co., Holyoke, Mass.
F. G. Miller,	108 Clinton street, Defiance, Ohio.
Gen. J. F. Pierson,	20 W. 52d street, New York City.
E. T. Seton,	80 W. 40th street, New York City.
J. H. Seymour,	35 Wall street, New York City.
A. G. Nesbitt,	Maple street, Kingston, Pa.
D. C. Beard,	204 Amity street, Flushing, L. I.
C. H. Ferry,	1720 Old Colony Bldg., Chicago, Ill.
Hon. Levi P. Morton,	681 5th avenue, New York City.
H. Williams,	P. O. Box 156, Butte, Mont.
D. B. Fearing,	Newport, R. I.
E. H. Dickinson,	Moosehead Lake, Me.
Lorenzo Blackstone,	Norwich, Conn.
A. L. Prescott,	90 W. Broadway, New York City.
G. S. Edgell,	192 Broadway, New York City.
W. B. Mershon,	Saginaw, Mich.
Hon. H. W. Carey,	East Lake, Mich.
George Carnegie,	Fernandina, Fla.
Andrew Carnegie,	2nd, Fernandina, Fla.
Morris Carnegie,	Fernandina, Fla.
W. L. Underwood,	52 Fulton street, Boston, Mass.
C. E. Butler,	Jerome, Ariz.
Mansfield Ferry,	183 Lincoln Park, Boulevard, Chicago, Ill.
Austin Corbin,	192 Broadway, New York City.
J. Stanford Brown,	487 Fifth Ave., New York City.
W. H. Smith,	Bryn Mawr, Pa.
E. B. Smith,	Bourse Bldg. Philadelphia, Pa.
A. I. McClure,	148 State street, Albany, N. Y.
T. Walter Thompson,	Times Bldg. New York City.

There are thousands of men in the United States who should be life members. Why don't they join? Will someone please take a club and wake them up?

THE KINGFISHER CHAPTER IS AFTER
LAW-BREAKERS.

Kingfisher, Okla.

Editor RECREATION:

From the enclosed circular which has been printed in all the newspapers of this county you will see what efforts we are making to protect the game. The facts regarding the slaughter of quails in our county last year are stated in the circular, and the L. A. S. members determined they should not be repeated this season. We have watched closely and so far as we know no quails have been shot or sold illegally this fall.

A. C. Ambrose, rear warden of our chapter, and county deputy, appointed by the Territorial warden, has made several convictions for seining and one for shooting doves, one day before the season opened. This act cost a young man of this city \$25. Mr. Ambrose has several deputies under him, scattered over the county and is doing good work. He plays no favorites.

F. D. Dakin.

The circular referred to reads thus:

\$10 REWARD.

The above reward will be paid by the League of American Sportsmen of this county to each and every person who will furnish convicting evidence against violators of the fish and game laws of the Territory, or the National law commonly known as the Lacey law.

This League was formed for the purpose of protecting the game and deserves the hearty co-operation of everyone, especially the farmers of this county, who each year are annoyed by trespassers and market hunters, who care little whether they shoot quails or stock.

The L. A. S. has been informed that 5,000 quails were slaughtered by 2 market hunters of this vicinity before the season opened last year and that those quails were shipped out of the Territory in violation of law.

All such game hogs will be watched this year, and if caught violating the law must suffer the penalty. All persons who are known as shippers of game are warned of the penalty for violating the law, and the above reward of \$10 will be paid for evidence that will convict any firm or individual of shipping game contrary to law. This county has a game warden and several deputies, who are sworn to do their duty, and, who will do it, and persons who violate the law will be prosecuted without fear or favor. All hotels and eating houses are warned not to serve quails till the 15th day of October, when the birds can be legally sold.

The farmers of this county are again requested and invited to join this League. It will be to their interest, and their co-operation would greatly strengthen the L. A. S. in its efforts to protect the game and enforce the laws.

LEAGUE NOTES:

The Blair county branch of the League of American Sportsmen continues to gather in violators of the game law throughout the county, on evidence secured by its special officers. Two culprits were arraigned before Justice John M. Delozier, of East Freedom, for offenses during the close season just ended. Charles Smith, who lives in the vicinity of Blue Knob, pleaded guilty to killing a pheasant out of season, and was sentenced to pay a fine of \$25 and costs. Frank Smith pleaded guilty before the same magistrate to a charge of hunting on Sunday, and was also sentenced to pay a fine of \$25 and costs. The prosecutions were brought by Special Officer Hoenstine, of Freedom township. These cases make a total of 12 convictions for violation of the game and fish laws secured throughout the county during the past season through the efforts of the League.—Altoona, Pa., Tribune.

Here is another chapter of the League which really does things. If all the puny, weak kneed, weak spined, alleged sportsmen throughout the country who clamor for officers and money with which to enforce their game and fish laws would join the League and work as these Blair county men are working, they would solve the problem of game protection, just as these men have solved it. God helps those who help themselves. So does the League.—Ed.

Enclosed clipping is from the Chronicle Telegraph; and thus the good work goes on.

J. C. Logue, Wikinsburg, Pa.

Altoona.—The county branch of the League of American Sportsmen is fulfilling its mission. As a result affairs throughout the county in the matter of game protection were never so good as this year. The law is being strictly enforced. It required several prosecutions to convince certain people that the League meant business, however, and in each case heavy fines were imposed. At a meeting of the executive committee it was decided that all constables of townships who either neglected or refused to return all violations of the game and fish laws in their respective bailiwicks should be prosecuted and a committee was appointed to see that they were prosecuted.

The next annual meeting of the League will be held in St. Paul, Minnesota, Wednesday, February 11, 1903. All Chief Wardens, Vice-Wardens and Secretary-Treasurers are eligible to membership in this assembly. In addition to these, each division is entitled to the privilege of sending one delegate for each 200 members or fraction thereof on its rolls October 1, 1902. It is to be hoped that all divisions will be fully and strongly represented at this meeting.

FORESTRY.

EDITED BY DR. B. E. FERNOW,

Director of the New York School of Forestry, Cornell University, assisted by Dr. John C. Gifford of the same institution.

It takes 30 years to grow a tree and 30 minutes to cut it down and destroy it.

FORESTRY ADMINISTRATION IN INDIA.

WILLARD W. CLARK.

Of the Philippine Forestry Service.

PART II.

The advisability of a systematic working of the Indian forests had frequently been urged during the earliest days of forest administration, but until Sir Diedrich Brandis arrived in Burma no practical steps were taken toward this end. Brandis set himself the task of ascertaining by means of numerous linear valuation surveys, the available growing stock in the forests under his charge and trained his associates to help him in the work. On the basis of the estimates thus formed and by the analyses of numerous stumps and logs, he calculated the annual possibility and framed preliminary working plans. They were plans drawn up on somewhat general lines, but were prepared with extreme caution and hardly ever erred on the side of over exploitation. These plans were used as guides for many years and were deviated from only when more detailed inquiries proved that any particular forest tract was able to produce a larger yield than had previously been supposed.

The general protection of the Indian forests was, at the outset, a matter of great difficulty, as the people had first to be taught that causing injury to the forest constituted an offense. In Burma it was quite usual to fell trees to collect cigarette wrappers. Areas amounting to thousands of square miles were everywhere annually destroyed by axe and fire for the sake of reaping one or perhaps 2 crops of cereals. Cattle and goats were grazed unchecked and forests were burned over to provide more extensive grazing grounds. Boundaries of forest property, though frequently shown on the map and sometimes indicated on the ground, had no particular meaning; and the forests inside the boundaries were maltreated in the same manner as those outside.

Fire protection is the most important and difficult problem with which the Indian forester has to deal. The nature of the climate favors the spread of fire. During the hot, rainless season the forests are filled with dry leaves, herbs and grass, and become as inflammable as tinder. This state of the forests is bad, but the foresters have also to oppose the ancient native custom of

firing grass lands and forests alike in order to clear away rank vegetation and make place for a new grass crop. In certain provinces almost general conflagrations are the chief reason for the barren character of so many of our Indian hill ranges and are more closely connected with famine than is usually supposed. An unfounded disbelief in the destructiveness of forest fires has also had to be opposed. It has been repeatedly argued that good forests exist and produce marketable timber which from ancient times have been overrun by jungle fires.

The annual cost of fire protection is at present a little above \$75,000 and amounts to less than 2 per cent. of the gross revenue. The work of fire protection begins early in the season with the cutting of grass, herbs and bushes on the fire lanes. When the material cut has become dry enough to burn it is burned at night.

Not only has the tree growth been benefited by fire protection, but the supply of grass and fodder has been increased, which is a great advantage to the surrounding agricultural population. The natives have even begun to appreciate this and have turned out *en masse*, unsolicited in some cases, to protect the government forest property against approaching jungle fires. The denser vegetation which follows fire protection almost immediately has had a most beneficial influence in counteracting erosion and preventing land slips and sudden floods; and the beds of rivulets from fire protected forests flow in narrower and better defined channels.

The nomadic and semi-nomadic habits of a great proportion of the people of India present another difficulty with which the Indian forest officers have to deal. From ancient times the natives have grazed their cattle, sheep and goats on all waste lands and forests wherever they chose. Since reserves were established one of the most important questions has always been to fix the kind and number of cattle to be grazed on each forest area. Grass being a commodity largely needed, the forests must, to a great extent, be managed with the object of growing grass kept in view, and almost all working plans are framed in accordance with the grazing requirements of the country. Fire protection and closures against grazing have, on several occasions of fodder famines, proved a great boon to

the country and saved the lives of many thousands of cattle.

In India it is necessary to rely almost entirely on natural reproduction of the forests. The forest areas are too vast and the average cash revenue per acre is too insignificant to warrant a more intensive management. The necessary trained staff of foresters is too small to carry on planting operations to any great extent. All that it is possible to do in the majority of cases is to protect against fire, grazing and other harmful interference to forest growth and to exploit the forests in such a manner as to give natural reproduction the best possible chance.

When the forests are put under regular management they are usually found in a bad state. Improvement cuttings are prescribed from the lightest thinnings of undesirable species, to heavy cuttings removing all but seed trees of desirable species and depending on coppice and seedlings to recover the ground. Even more or less denuded areas within the deciduous zone require rarely anything but seed to ultimately reclothe them with forest growth. Broadcast sowings are often successful. The bamboo is a nuisance, as it is in the way of and prevents reproduction. About the only way to get rid of it is to wait for the bamboo to flower, seed and die and then sow seed of teak or other species desired, under the bamboo.

In the reproduction of teak, the areas to be treated are first fire traced, then burned and cleared by fire. Teak and cutch seed are dibbled in plentifully and as many nursery plants set out as are available. This method may be applied only where the existing young growth is poor enough to excuse its being sacrificed. Otherwise the use of fire in clearing must be dispensed with. Some 4,000 acres have been stocked with teak in this manner since 1880.

A taungya is a piece of ground that has been cleared and cultivated for a few years and then abandoned by the natives. The land cleared for taungyas within the government forests, according to recent legislation, must be planted to teak before it is abandoned. The government often assists in this by supplying seeds or nursery material. As a result of this system 52,000 acres had been planted in teak up to 1900.

Girdling and felling of inferior trees in order to make room for teak, deodar, sal padouk, etc., should be done only in fire protected regions, since forest fires will upset the object of the thinnings and be made fiercer by the debris left from the thinnings.

Creepers cutting is an important duty of the Indian forester. The efficiency of the forest officer is often gauged by the absence of creepers in his beat. The usefulness of

climbers in holding and shading the soil is considered important by some. A writer in the Indian Forester says: "No climbers should be cut on steep banks or in other places save when actually on a tree or within 10 feet of one; and this does not apply to inferior species of trees."

Trees attacked by epiphytic fici must be felled as soon as found attacked.

Thinnings are mainly restricted to artificial plantations because of the lack of foresters sufficiently trained to do the work. Improvement fellings made with a view of increasing the proportion of healthy, promising stems in the crop, have been carried on wherever a demand for the produce of the felling exists; or in the absence of such demand to the extent to which funds and superintendance were available.

SEEDLINGS;

There is a strong movement on foot in New England to have a National park established in the White mountains. A committee has been appointed to present the matter to Congress.

The title Forest Engineer, which was first conferred by the New York State College of Forestry in 1902, is growing in favor throughout this country.

If you wish to make a present to a man or boy who is interested in shooting, fishing, amateur photography, or nature study, give him a year's subscription to RECREATION. Nothing you can possibly buy for \$1 would give him so much pleasure as 12 issues of this magazine. Come early and avoid the rush.

Stranger—What wonderful tales old Blinks relates! He must have been a great traveler in his day.

Native—He was never outside the county in his life, but his mind has wandered for years.—Chicago News.

"Have you been through calculus?" inquired the college professor.

"Not unless I passed through at night on my way here," replied the new student; "I'm from Kansas, you know."—Exchange.

I have been a constant reader of RECREATION many years. Was once, I am afraid, something of a hog, but thanks to RECREATION's teachings, am so no longer.

L. C. Eleriot, Enid, O. T.

PURE AND IMPURE FOODS.

"What a Man Eats He Is."

Edited by C. F. LANGWORTHY, PH.D.

Author of "On Citraconic, Itaconic and Mesaconic Acids," "Fish as Food," etc.

THE PRESERVATION OF FOODS.

According to a recent report of the Kentucky Experiment Station, the question of most importance in the manufacture and sale of foods is that of preservation, and this problem presents the most tempting field for adulteration to the otherwise honest food manufacturer and producer.

"As soon as the spark of life leaves the animal, putrefaction begins; as soon as milk is exposed to a warm atmosphere it commences to sour; and when ripened fruits or grains become bruised or exposed to a moulding atmosphere decay sets in. The best established theory is that the disorganization and decay of animal and vegetable tissues and of milk and its products are due to the action of ferments, or of fermenting bacteria. The preservation of food products depends on the suspension of these decomposing bacteria or the counteraction of their influence, and is accomplished in 4 general ways: cold storage, sterilization, ripening and the preserving influence of salt, sugar, vinegar or smoke. Thus ice in the refrigerator and cold storage system causes a low temperature, which delays the decay of meat and souring of milk; meats, vegetables and fruit are sterilized or heated to a degree hot enough to kill these organisms and then canned; the fats and caseins of milk are ripened into butter and cheese; fruits are preserved with sugar; vegetables are pickled with vinegar and salt; hams and bacon are cured with salt and smoke. Often 2 or more of these methods are employed to preserve a single article of food, and when combined with clean systems they are recognized as the healthful and ideal methods for preservation of food products. Salt and vinegar, besides being used to preserve the food, are relishes and stimulate the flow of the digestive juices; their taste makes them easily detected and when not desired they can be declined.

"These methods require skill and care to execute, proper sanitation and cleanliness in shipping and storage. Manufactured goods sometimes remain on the shelf for years before all the stock is sold. Foods are often produced in unclean surroundings and handled carelessly. Such reasons, with the tendency to imitate and to put on the market articles of food without regard to their quality, purity or food properties, cause the use of antiseptics.

"The antiseptics found in the foods re-

cently analyzed at the Kentucky Experiment Station were salicylic acid, benzoic acid, boracic acid, saccharin and formaldehyde. These antiseptics act as a strong paralyzant to the ferments in foods and their lasting embalming properties make them the surest method for food preservation, as well as the cheapest plan.

"The more honest manufacturers make use of them in small quantities; others use them without regard to quantity. These antiseptics, varying in effect, have a deleterious influence on the human system and their harmful effect in large quantities is not honestly denied.

It is claimed by the manufacturers who use them, and also stated by some authorities, that the use of antiseptics in small quantities in foods is not harmful. There is an overwhelming testimony from scientists that these antiseptics are for various reasons and in different degrees harmful when taken into the system. Even those who favor their use in small quantities agree that their use should be made known to the consumer. Whatever questions concerning the use of antiseptics in foods are unsettled, they supplant to some degree the cleanliness and care necessary to produce wholesome foods, cover deficiencies and cause the use of many food articles of an unhealthful character. The use of the more harmful should be prohibited; the use of small quantities of those less harmful should be rigidly restricted and only permitted when the fact of their use is made known to the actual consumer.

"Watching the various food products with regard to antiseptics alone is a large task, so extensively and recklessly are they used in the numberless articles of food on the market. Many food industries are built on this principle of preserving foods entirely with antiseptics. It is a wrong principle and should be discouraged. The representatives of such food factories present many arguments and schemes to protect the profits which accrue from the substitution of a pinch of some antiseptic for the more costly methods of ice, sugar, cleanliness and care employed by the manufacturers of the best food articles. To cite a fact, axiomatic of all drugs, that the single instance of a mild antiseptic in the minutest quantities has little effect in the system, does not defend the reckless use of antiseptics, a practice dangerous to the public health."

THE FOOD VALUE OF BEANS.

Beans and other legumes are among the oldest foods known to mankind, yet comparatively few studies of their food value have been made, with the exception of analyses which show the chemical composition. Studies like those recently made by Prof. Harry Snyder, at the University of Minnesota, are therefore of especial interest. He studied the thoroughness with which beans are digested by man; the changes which beans undergo, when parboiled, with the addition of soda before baking, which is a common domestic method employed in preparing them for the table; the characteristics of the chemical bodies which make up the different constituents; and related topics. A number of artificial digestion experiments were also made, in which digestion was accomplished by means of ferments similar to those found in the intestinal tract. The conclusions which Professor Snyder drew from his experiments follow:

"Beans were found to be more digestible when combined in a ration with milk, butter and other foods, and the highest degree of digestibility was secured in a mixed ration. The carbohydrate nutrients of beans were found to be more digestible than any of the other nutrients. The protein was the most variable in digestibility; its range of digestibility varying between 72.26 and 86.81 per cent. When soda was used in the preparation of the beans, it was found that 84 per cent. of the soda remained in chemical combination with the proteid material, and 16 per cent. was removed in the drain water. Less than 0.66 of one per cent. of the total nitrogen of beans was lost in the water used in parboiling, while 99.33 per cent. of the total protein remained in the beans. When the skins of beans were removed by parboiling in water containing a little soda, about 6.5 per cent. of the total dry matter of beans was removed in the skins. The skins contain a large quantity of crude fiber and a relatively small quantity of protein. About 3 per cent. of the total protein in the beans was removed in the skins. When the skins of beans were removed there was less tendency to the formation of gas in the intestines during digestion. A small quantity of germ adhered to and was removed with the skins; the germ and the skin are the parts of the bean which are the most fermentable and which produce sulphureted gaseous products during digestion. Beans contain a large quantity of protein and a small quantity of fat; hence, in their preparation as human food, fat is necessary in order to make a more balanced food. When the skins of the beans were removed, the

beans were more readily acted on by digestive solvents as pepsin, diastase, and pancreatin. In 12 hours, 25 per cent. more of the protein nutrient was digested when the skins of the beans were removed than when the beans were baked in a similar way without the removal of the skins. At ordinary prices, beans are one of the cheapest foods for supplying protein in rations. A pound of beans, costing 5 cents, contains about 1-5 of a pound of digestible protein and somewhat less than 3-5 of a pound of digestible carbohydrates, mainly in the form of starch.

"The nutrients in beans are different in character from the same class of nutrients in cereal foods. The protein in beans is mainly in the form of legumin, while that in the cereals is in the form of glutens. Bean starch granules are larger than and differ in microscopic structure from the cereal starch granules. Beans contain only a small quantity of ether extract, a portion of which is in the form of lecithin and free fatty acids. The ether extract from beans, however, has about the same caloric or heat producing power as the ether extract from other foods. In these experiments over a pound of baked beans was consumed per day by men engaged, part of the time, in active outdoor work. It is believed, however, that not more than 4 ounces of uncooked beans or 6 ounces of baked beans should be consumed in the daily ration. While beans are slow of digestion, they can not be considered as indigestible when the availability or total quantity of nutrients actually utilized by the body is considered. In these experiments, over 90 per cent. of the dry matter in the beans was digested and utilized by the body."

PASTEURIZING AND STERILIZING MILK.

When milk is heated to 158 degrees and over, in other words, when it is cooked, its milk sugar, according to a recent article by Professor Julius Nelson, becomes changed, being caramelized, or scorched, and certain of the albuminous constituents are coagulated and precipitated on the bottom of the kettle. "They then become superheated and charred, imparting a bad taste to the milk. By constant stirring, this sort of scorching is prevented. There are other changes produced in milk by cooking. Some enzymes are destroyed, and the taste is so altered that the milk is less palatable to most persons. It is also less readily digested, though apart from the loss of some of its nutrients by precipitation, its nutritious value has not been seriously impaired.

Milk that is boiled when perfectly fresh has a different flavor from ordinary boiled milk. The true cooked flavor is then

brought out, as distinguished from the flavor of raw milk, and it is one really agreeable to, and preferred by, some people. Milk that is near the souring point is made worse by being heated. While the temperature is rising the germs present are stimulated to increased activity, and sufficient acid is developed to curdle the milk. Even when heated so rapidly that the germs have no time to grow, there may be acid enough present to curdle the milk at a warm temperature. Sour milk is preferably partaken of raw than when cooked. Even when there is not enough acid present to curdle the milk on cooking there are enough deleterious products to deteriorate the flavor. Hence it is natural that there is a prejudice against cooked milk.

It is of the highest importance that milk that is to be heated should be as fresh as possible, for cooking does not destroy the deleterious products of fermentation, though it kills the germs that made these products. Hence the customer should insist on obtaining as pure a milk as possible. Sterilizing milk at home, as well as pasteurizing methods in the dairy itself, do not invite carelessness in regard to the cleanliness of dairy methods. The application of heat is intended to supplement these methods, to increase the purity of the milk, just as ice is applied for a similar object. Each agent is used in its own proper place so as to be most effective.

Heating milk for the purpose of destroying the germs present is effected by 2 methods, known as sterilization and pasteurization. Pasteurized milk has the same relation to sterilized milk that rare beef has to well done beef. Such milk has not been heated sufficiently to give it the cooked taste, and its preparation is founded on the fact that disease germs can be destroyed at a temperature below that which causes this cooked condition. As most of the other germs in the milk are destroyed at the same time, such milk is greatly improved as regards its keeping qualities.

Sterilized milk, properly speaking, is that which has had all its germ content destroyed. Hence if such milk be guarded from further contamination, it will remain unaltered, even at ordinary temperatures, for an indefinite period. To destroy all the germs in milk, including the spores, it becomes necessary to subject it to the action of live steam under pressure at a temperature considerably above the boiling point, 240 degrees. Such a proceeding is neither practicable nor necessary in the household, as pasteurizing serves all ordinary purposes. Milk, may, however, be completely sterilized by repeated pasteurization. The heating is re-

peated daily for nearly a week, because all the spores present do not germinate after the close of the first or even after the second heating, though few remain. While milk sterilized by this method, has no cooked flavor, yet it is a method commercially impracticable.

What is generally called sterilized milk is not entirely free from germs, but having been subjected to a more thorough heating than with pasteurization, and being guarded against further contamination, it will keep longer than does pasteurized milk. This is its main advantage, for it has to a greater or less degree the cooked flavor.

SHIP BREAD AND HARD TACK.

Ship bread, it is said, is made simply of flour and water. A barrel of flour is wet with $3\frac{1}{4}$ pails of water, making a stiff dough, which is generally cut into squares with a soda biscuit cutter and baked in a solid oven, which should be quite hot. Sometimes the dough is cut round and thick. When baked the ship bread is emptied into bins in the upper part of the bake shop, where it is allowed to dry for days, becoming practically kiln dried. It is commonly packed into flour barrels and sold by the pound. Often, however, a skipper has the bread packed in whiskey casks, especially if it is for a long voyage, as the smell of the whiskey will protect the bread from weevils. Vessels from the Mediterranean buy American ship bread, packing it into air-tight metallic casks. When wanted one cask is opened at a time, and thus the bread is kept for months in a fairly good condition. It is often taken to the coast of Africa and used in trading with the natives. That used on board ship is generally made from clear flour, and is sweet and wholesome, but that made for export, according to a trade journal, is often made from a low grade of flour and is dark in color. Ship bread is not used on board of vessels so much as formerly, since a great many vessels carry flour and bake bread as wanted.

Hard tack, used in the army, is similar to ship bread, and is made, as a rule, from sound, straight grade flour. During the Spanish-American war it was delivered to the Government in sealed tins containing 100 pounds each.

There is another class of water biscuit made wholly from flour and water which is largely used under the name of "water crackers." They are usually rather thin and are well baked, and, being brittle rather than soft, they require thorough mastication before being swallowed. Water crackers are cut into a variety of shapes and given different names.

BOOK NOTICES.

Commodore John E. Gunckel, of the Toledo Yacht club, has written and published a history of the Maumee Valley, in Northern Ohio. As most students of history are aware, that valley was the scene of several important struggles between the white pioneers of the middle West and the Indians. General Wayne's famous battle of the Fallen Timbers, General Winchester's defeat at River Raisin, certain of General Harrison's operations, the siege of Fort Meigs, Major Crogan's fight at Fort Stephenson, and Commodore Perry's victory at Put-in-Bay are all treated of in this book in a most comprehensive and interesting manner.

Any person interested in the history of the early settlement of Northern Ohio will find Mr. Gunckel's book of great value.

A postal card addressed to him at Toledo, Ohio, will bring you a circular telling all about the book.

The annual report of the Smithsonian Institution for 1901 has just been issued and contains many articles and illustrations of interest to all nature students. Among the papers which will probably appeal with greatest force to the readers of RECREATION are "Utilizing the Sun's Energy," "Color Photography," "The Arctic Voyage of the Belgica," "Forest Destruction," "Irrigation," "Traps of the American Indians," "The Laws of Nature," "The Greatest Flying Creature," "The Wanderings of the Water Buffalo," "The Preservation of the Marine Animals of the North West Coast," and "A New African Animal."

This book may be bought, at cost, from the Superintendent of Documents, Washington, or you may be able to get a copy free of charge through your member of Congress.

"A Plea for Hardy Plants," by J. W. Elliott, presents in clear, simple form, many thoroughly practical suggestions for beautifying home grounds, even though they be but small city lots. A list of the common, available, hardy plants is given, together with diagrams and plans for their placing in attractive design; and nearly every page in the book contains an exquisite half tone from a photograph showing beautiful floral effects produced by simple home gardening.

Doubleday, Page & Co., New York; price \$1.60.

Drs. Evermann and Kendall, in continuance of their studies of the geographic distribution of American fresh water fishes,

have recently published a catalogue of the species of fishes known to occur in the St. Lawrence river and its tributary waters below Lake Ontario. They list 71 species, among which the most important game fishes are both species of black bass, the wall-eyed pike, ouananiche, Atlantic salmon, lake trout, brook trout, marston trout, pike, and muskalonge.

Clay Emery has written, and Doubleday, Page & Co., New York, have published, a little book entitled "Cap'n Titus." The captain is an old Cape Cod fisherman and packet commander, who has the happy faculty of spinning yarns that are unique. They are told in the real salt water vernacular, and you can almost hear the lapping of the waves and feel the roll of the schooner as you read them. I trust Mr. Emery may give us other volumes of the old mariner's tales.

A yearly subscription to RECREATION furnishes one of the most delightful, instructive, entertaining presents you can possibly give a man or boy who is interested in nature, in fishing, shooting, amateur photography; or, who is fond of the woods, the fields, the mountains, the lakes or the rivers.

Many presents which people give their friends afford pleasure only for a few days, or weeks. A subscription to RECREATION means solid comfort a whole year. It reminds your friends 12 times during the year of your kindness and generosity. There are many men and women who for 5 years past have annually sent in long lists of names of friends, accompanied with a check, in order that these friends might be made happy a whole year. Would it not be well for you to adopt this plan?

Try it and see how grateful the recipient will be.

I consider RECREATION the best sportsman's magazine ever published. Besides being interesting, it is exceedingly instructive. I wish you continued success in your good work.

J. Zweighaft, Haines Falls, N. Y.

I think RECREATION is the best sporting magazine published and I will do my best to make my friends think so.

R. McG. Watt, Woodstock, N. B.

I would give \$1 a copy for RECREATION if I could not get it any other way.

I. H. Miller, Columbus, O.

PUBLISHER'S NOTES.

In a recent letter from the Page Woven Wire Fence Co., of Adrian, Michigan, they say:

"We were never so well equipped as at present to furnish Page fences. Having our own steel, rod and wire mills, and having largely increased our weaving capacity, we are in good shape to supply the demand for 1903. We make a standard style of fencing for every farm, poultry, stock, or railroad requirement; use double strength horizontal wires in all these styles, and coil or spiral every one of them from end to end the whole length of the fence, thus providing for expansion and contraction. Page wire will retain this coiled shape even after it has been drawn out straight 1,000 times. No locks, staples or other devices are used to hold the horizontals and crossbars together, because Page fence is a real woven wire fence. Horizontals and crossbars woven together is all there is of it.

The ad of the Page Fence Company appears regularly in RECREATION and if you have not yet investigated the merits of their fencing, you should write for catalog, descriptive matter and prices now.

Catalogues come so fast that it really keeps an editor hustling to tell of all of them; yet there are many coming to this office that are of such vital interest to my readers I feel it my duty to keep them advised as to these works.

The latest book in my line comes from Parker Bros., Meriden, Conn., makers of the old reliable Parker gun. This book, like many others I have had occasion to talk of, is replete with information of great value to bird shooters, and contains some elaborate illustrations of the Parker guns, both in their complete form, ready for use, and in detail as to mechanism. Only rarely does a man who uses a Parker gun need anything with which to repair it, but in case such a thing ever should happen, it would be handy to have a copy of this pamphlet at hand, for it illustrates every piece used in the Parker. Each part is numbered and named, so that even a novice would have no difficulty in expressing his wants. Of course, every reader of RECREATION will want a copy of the Parker catalogue, and in writing for it you should say where you saw it mentioned. It makes a lot of difference to me whether you do this or not.

The making of the gaily colored blankets of the Navajo Indians bids fair to become one of the lost arts in the near future. The old squaws are the only people in the tribe

who can be induced to weave these blankets, and they will soon have passed away. The younger people prefer to buy their blankets from post traders, and if they work at all they prefer to work on something more interesting and less confining than the slow process of weaving blankets by hand. Therefore, persons who wish to procure samples of these beautiful blankets and thus retain relics of the handiwork of a passing people, must do so in the near future. The Edward Smith Indian Post Trading Co., whose ad appears on page xxxvi of this issue of RECREATION, has a man traveling all the time among the Navajos, buying all the blankets he can find, and shipping them to the company's warehouse at Canyon Diablo, Arizona. The company has issued a catalogue of these blankets and of other rare and interesting Indian curios, which can be had by asking for it. In writing for it, please mention RECREATION.

The demand for our boats has increased so much within the last few months that we are compelled to work overtime to keep a supply on hand. So far this year we have sold twice as many of these boats as we did during the entire year of 1901, and we feel that the ad in your excellent magazine has been greatly instrumental in bringing us many orders. The demand does not seem to be confined to any particular part of the country, but comes from all over the United States and Europe. We recently shipped a large order to Germany. Last week we forwarded a car load to the Simmons Hardware Co., of St. Louis, Mo., and one to the Marshall-Wells Hardware Co., of Duluth, Minn. The ad in RECREATION has been a great factor in the sale of these goods and we would not hesitate to recommend it to the use of any one who wishes to place worthy goods before the sportsmen of this country.

W. H. Mullins, Salem, Ohio.

The Southern Railway announces excellent service and schedule for the Southern travel for the season of 1902 and 1903. Operating from New York over the Pennsylvania, 12 through sleeping car lines daily touch almost every prominent city in the South and Southwest. This road also gives high class dining car service on all the through trains. This route operates the Washington and Southwestern Limited, 39 hours, New York to New Orleans, connecting with the Southern Pacific Sunset Limited from New Orleans to the Pacific coast;

2 other fast trains, the New York and Memphis Limited and the U. S. Fast Mail; to Florida, Cuba and Nassau, the New York and Florida Limited, operated daily; and during tourist season, the world's famous Southern's Palm Limited. For full particulars, descriptive matter and general information regarding the South, call or address New York Offices, 271 and 1185 Broadway, Alex. S. Thweatt, Eastern Passenger Agent.

The Multiscope & Film Company, Burlington, Wis., makers of the famous Al-Vista camera, have lately put out a new catalogue that is really remarkable. It contains a series of panoramic pictures, made with the Al-Vista, that are revelations. There is one view of a flock of sheep grazing in a pasture, and another of a flock of children gathering daisies, both of which are marvels of beauty. These cuts are $4\frac{1}{2}$ by 12 inches, and each picture includes a stretch of country of, I should say, 200 yards in width, all taken at one swing of the swing lens. Every object within this field is as sharp on the plate as if it had been the sole point aimed at.

All lovers of beautiful pictures should write for copies of this exquisite piece of work, and should mention RECREATION.

Houston, Texas,

National Projectile Works,

Grand Rapids, Michigan:

Dear Sirs:—While on a hunting trip in the Rocky mountains, I had 2 dozen of your lubricated wire patched bullets that had been sent me as samples for use in a Savage rifle. With this ammunition I made a double on elk, killing 2 bulls out of one hand, and at a single shot each. I also killed a large brown bear with another one of your wire patched bullets. I learned of these cartridges in the first place through your ad in RECREATION, and I recommend them to hunters as being all that is desired. The ball mushrooms just right for making killing shots.

J. R. Stuart.

In September RECREATION I printed a paragraph which contained 2 unfortunate errors. I spoke of the Kenwood traps as being made by the Oneida Company, of Kenwood, New York. I should have said the Newhouse traps and the Oneida Community. However, both institutions are so well known to the readers of RECREATION that it is not likely anyone who read the notice was misled by it. Every reader of this magazine knows the Oneida Community and the Newhouse traps. Both are old timers, and there is scarcely a man or

boy in the land who is fond of the woods who has not used Newhouse traps, or seen them used. However, this correction is due to the good, honest, sturdy people who comprise the Oneida Community.

Great attention is given by athletes to the character of the brushes, sponges, liniments and soaps they use. Fairbank's Glycerine Tar Soap has found a popular place because it not only cleanses, but soothes and invigorates. Football players find that it does far more than the average liniment to allay the pain from bruises; and, of course, it removes grime as none of the liniments can do. With the athlete perhaps more than with anyone else it has a wide range of usefulness, removing from his hair the dust which collects through the violent character of his exercise. Its convenient shape and lasting qualities make it economical. Try it yourself if you have not already done so. At the grocers, 5 cents a cake.

The latest number of the New York Central's "Four-Track Series," No. 35, is devoted to "Historical Pilgrimages about New York." Besides containing a map of New York from the Battery to Newburgh, printed in colors, and a brief description of a large number of historic points and buildings, it explains how teachers with their classes can make pilgrimages of 3 to 12 hours and see a great deal that is of immense interest and value to them in their studies of geography and history. A copy will be sent free, postpaid, on receipt of a 2-cent stamp, by George H. Daniels, General Passenger Agent, New York Central Railroad, Grand Central Station, New York.

Decatur, Ill.

The Mitchell Mfg. Co.,
London, Ohio.

Dear Sirs:—

The J. C. Hand Trap duly received and I am much pleased with it. By using the trap on the side of a hill and throwing all angles, one can learn more about field shooting in an hour than in a month's actual practice on game.

Wishing you the success your trap merits,
I remain, Sincerely yours,

Chauncey M. Powers.

New York.

Messrs. Wing & Son:

After a thorough test of the Wing piano for the past 4 years I subscribe myself as its most ardent advocate. It has a powerful and beautiful tone. A piano must be a good one to stand the pounding it receives

when used in orchestra work. The Wing piano has all the essentials that constitute a perfect instrument.

Yours respectfully,
H. G. Corwin,
Leader Orchestra Hotel Navarre.

Schoverling, Daly & Gales have recently issued one of the most artistic catalogues of guns, shooting and fishing accessories, ever published. They would like to send this catalogue to every man who loves a fine gun, dog or fishing rod. It describes Daly guns at prices varying from \$80 to \$500, fine tackle and high grade rifles, pistols, etc. Write for the catalogue and please say you saw it mentioned in RECREATION.

The Burlington Basket Company will exhibit the Hawkeye Refrigerator Basket in spaces 46 and 51 at the Automobile Show in Madison Square Garden in January. Every camper and picnicker who visits the Automobile Show should examine this basket. It is one of the most useful and practical devices of this kind that has ever been offered to the public. If you see one, you will certainly want it.

Our sales of Century cameras have far exceeded our expectations, and never in our experience have we had so few complaints of any make of cameras as of the Century. There is an increasing demand for high grade cameras of the best workmanship, and the Century stands in the lead.

Yours truly,
Fowler & Slater, Cleveland, O.

Omer, Michigan.
West End Furniture Co.,

Dear Sirs:—Received the gun cabinet today. Please accept my appreciation of same. My husband is highly delighted and says I could have got him nothing else he would have liked so well.

Yours truly,
Mrs. D. H. McDonnell.

Dresden, Ohio.
Drs. Phillips & Wrean,
Penn Yan, N. Y.

I received the hares all right and they are the finest I ever saw. Thank you for your honesty in sending me a fine trio.
W. J. Barron.

EDITOR'S CORNER.

WRITE HIM YOUR OPINION.

I am reliably informed that the "Reverend" Ransome Williams, of Greenville, S. C., hunts quails more than he does sinners. It is said he shoots nearly every day during the entire open season, with the possible exception of Sundays. He has 2 good dogs and when he finds a covey of quails, he follows them as long as he can find one of them and if any of them get away, he grieves over it.

This Reverend bristleback does not confine his shooting to the open season. I am told that in May last, when preparing for a trip to the mountains a few miles North of Greenville, he told a friend of his that he knew where there were plenty of trout and grouse. This friend is a sportsman and asked the dominie if he would shoot grouse in the spring. The preacher said he would and that he hoped to kill some on that trip. The sportsman asked him if he would shoot quails at that season.

"Yes," said the old poacher, "I see no reason why I should not shoot the male birds."

His friend asked him if he did not know that the males assisted the females in incubating the eggs and caring for the chicks; that in case the cock were killed, the whole brood would probably be lost.

"Yes," said the sky pilot, "I have heard such stories, but I do not believe them."

He took his gun with him into the country. He has no church in Greenville, but officiates at several churches in the surrounding country. He always takes his gun and dog along when he goes on his circuit to preach. He stays every night with some good brother, shoots until he is tired, and manages to fetch up at the home of some one of his church members at meal times.

I wrote the Reverend Williams and asked him if the report quoted above were correct. He did not reply to my letter and after a reasonable lapse of time, I wrote him again, urging him to deny or confirm this report. Still no response. His silence is therefore equivalent to a confession, and every good sportsman who is also a good church member, will blush for his religion.

when he reads of the disgraceful and degrading conduct of this mossback Bible-pounder.

I have the highest possible respect for all good Christian people, but when I hear of a preacher who openly violates the game laws and who outrages the laws of God as to the rearing of the beautiful creatures He has placed on this earth, I wish I had the power to punish that man as he deserves.

There is one course that never fails to carry conviction to the heart of even the hardest game hog that ever lived. That is for 100 or more gentlemen sportsmen to write personal letters to such brutes and tell them to their faces, so to speak, what decent people think of them. Will not a lot of the readers of RECREATION use a little stationery and a few postage stamps in an effort to shame this old reprobate into a proper regard for the laws of his State and for the laws of decency? Give it to him straight from the shoulder and send me copies of your letters.

MANY FATALITIES.

The hunting season which ended with December yielded the usual crop of fatalities among hunters. Here is a record of a few of them:

George Miller mistook Matt Britz for a deer in the woods near Lathrop, Mich., and killed him. William Walsdorf was shot and killed near Chippewa Falls, Wis., by an unknown man, who probably thought he was shooting at a deer. Near the same place Carl Emerson received a load of buckshot in the shoulder by an accidental discharge of a gun in the hands of a friend. A settler named Martino, living near Bloomer, Wis., was killed by a stray bullet, which entered his left ear and came out of the right ear. William Fremert, of Oconto, Wis., was accidentally shot in the leg while hunting ducks.

Henry McPeters, of Milford, Me., W. C. Trickery, Dayton, Ohio, Leslie Bowker, Marshfield, Me., Frank Leonard, Frankfort, Me., and John O. Weeks, Boston, were killed in the Maine woods while hunting, and there are several counties yet to hear from.

Certain people talk a great deal about modern high power rifles being dangerous for use in deer hunting, but it seems that in nearly all cases where men have been mistaken for game and killed in recent years, they would have met the same fate if the hunters had been using the old black powder rifles. A man who shoots at a moving bush or a patch of something he does not exactly know the nature of, almost invariably bags his man, whether he uses smokeless or black powder. It will be observed that only one of the 9 men mentioned above stopped a stray bullet. The others

were all killed at short range and by men who thought they knew what they were doing.

LEAGUE MEMBERS IN CONGRESS.

The game birds and wild animals will have another strong friend in the next Congress in the person of Mr. George Shiras, of Pittsburg, an old time League member. He was elected in November last and on account of his intimate friendship with several other members and Senators will be a power for good in the cause of game protection.

Mr. Shiras was probably the first man in the world to substitute the camera for the gun in hunting big game, and for 10 years past has been making flashlight pictures of wild animals in their native haunts, which have surprised and delighted millions of people. I have published a number of his pictures and have others in hand for future issues of RECREATION. Mr. Shiras has made many beautiful pictures of deer, lynx, porcupines and birds within the past 2 years, which will be reproduced in a book he is now writing, to be entitled "The Camera Sportsman."

Another League member was elected to Congress last fall, in the person of the Hon. B. G. Humphreys, of Greenville, Miss. So we now have 9 L. A. S. men in the national House of Representatives.

Lacey, Shiras, Thropp, Small, Shattuck, Caldwell, Ray, Robinson and Humphreys will be a great team in the next House.

IT'S UP TO MY READERS.

A subscriber complains that I am giving too much space to criticisms of Marlin rifles and Peters cartridges, and charges me with condemning them myself. I have never said a word, editorially, against either of these lines of goods. I simply allow my readers to tell of their troubles with these, as with any other guns or ammunition, whether advertised in RECREATION or not; and as long as I print this magazine, I shall accord this privilege to my friends. I have printed just as severe criticisms of Winchester and Savage rifles as of Marlin rifles, but the difference is that only one man in 10,000 of those using Winchester and Savage guns has any trouble; while the percentage of those using Marlin rifles is different.

I have on file large numbers of complaints about Marlin rifles and Peters cartridges and these letters will be printed in the order in which they came. Whenever any weapon proves defective in the hands of a reader of RECREATION, and he sees fit to write me about it, his complaint will be printed whether the weapon be advertised in RECREATION or not. My Gun and Ammunition Department is a medium for the exchange

of information, ideas and thoughts on all goods in these lines, and it will remain such until further notice.

WHO WOULD KILL HIM.

Mr. R. W. Trussell, who lives at Neponset, Mass., called here the other day and told me an interesting story of a gray squirrel that lives in his village. He says there are a number of them that are tame and that are regularly fed and cared for by the people, who love and appreciate them. Mr. Trussell recently sat at his front window reading, when one of the gray squirrels came into a tree within a few feet of the house and began eating a nut he had picked up. Mr. Trussell took an English walnut from the table and tapped on the window pane with it. The squirrel looked a moment, and evidently identified the morsel; for he leaped from a branch of the tree in which he was sitting to the roof of a neighboring house, ran down to the eave-trough and hid the nut he had. Then he came to the window, took the proffered lunch from Mr. Trussell's hand, and returned to the tree again, where he ate it.

Is it not strange that after knowing how thoroughly, and how easily, these beautiful animals can be domesticated, some people still persist in killing them at sight? I trust all sportsmen may soon learn that this animal is not a legitimate object of pursuit, and that we may soon hear the last of squirrel shooting.

GET THE NAMES RIGHT.

Once more I beg my good friends to call things by their right names; especially ruffed grouse and mule deer. As I have said before, these creatures are sadly and habitually misnamed by nine-tenths of the people who hunt them. I cut out of manuscripts that come to this office the words "pheasant" "partridge" and "blacktail deer," some hundreds of times each year. If writers would only learn that there are no pheasants in this country except such as have been imported from Europe; that there are no partridges here at all, and that the blacktail deer is found only on the Pacific slope, North of the North line of California, it would save me a lot of work and annoyance, to say nothing of the valuable educational work which my good friends might accomplish in their conversation with others. The deer found throughout the Rocky Mountains, and which is called the blacktail by 99 per cent. of the people who talk of him, is the mule deer, and there are no blacktail deer in that region.

That stalwart game protector, Sam Fullerton, of St. Paul, is still after the law

breakers. The chicken season opened in that State September 15, but, as usual, a lot of shooters were too previous. As a result Mr. Fullerton and his associates rounded up 14 men who were shooting chickens before the legal date, and confiscated their guns. He also got one dog. It is worthy of remark that only one of the 14 guns was worth more than about \$7. This indicates that most of the men who violated the game laws are of the class who do not appreciate good guns, or good sportsmen's literature. If these men had been reading RECREATION for 2 or 3 years past, they would have waited for the open season before going into the chicken country, and would now have their guns. No doubt they regret the loss of them, even if they were made of gas pipe. If Sam will kindly send me the names and addresses of these men, I will send each of them a sample copy of this issue of RECREATION.

Dr. B. W. Evermann, who for years past has been the Ichthyologist of the U. S. Fish Commission, has recently been appointed Chief of the Division of Statistics and Methods of Commercial Fisheries. This is a new position and one for which Dr. Evermann is especially fitted by his long study and training. It may be confidently expected that he will, within the next few years, collect and compile a valuable fund of information regarding the commercial fisheries, not only of this country but of the world. Dr. Evermann still retains his old position of Ichthyologist, in which he is doing such splendid work.

Deputy game warden Kirmse, of Sandusky, Ohio, recently went to the house of Ferdinand Bork, a wealthy farmer, with a warrant for the arrest of Bork's sons for shooting squirrels out of season. When the warden stated his business, Bork immediately made an assault on him with a corn cutter, inflicting 2 serious wounds. Warden Kirmse drew a revolver and shot his assailant dead. It would have been just as well for Bork not to have interfered with the officer in the discharge of his duties.

Howard Gray, of Hughesville, Pa., went hunting squirrels September 20th, which was before the opening of the legal season. He killed 7 squirrels and on his way home he met constable Flick, who escorted him to Justice Kahler's court. There Gray was assessed \$73.12. Gray was unable to pay his fine and was locked up in the city pen. Some friends came to his rescue later and he was turned out to grass. It is hoped he will remember this experience a long time.

BASS FISHING IN AUGUST.

J. A. NEWTON.

It was a little past the middle of August, in the early '90's, when my friend, Mr. Cone, arrived from the city at my home in the village, on his old quest for the silvery denizens of the 2 rivers, Grand and Flat, at the junction of which I live. As I was constantly on the ground, Mr. Cone always looked to me for information as to what kinds of fish were biting, the best bait to use, and where to fish. I decided that on this occasion we should fish in a manner new to Mr. Cone. We were to take a boat and row to the head of the pond formed by a large dam on Flat river. There we should leave our boat and walk overland half a mile to the beginning of a sharp bend in the river, when we were to don our wading suits and fish down to the still water of the pond. I knew it would be hard to wade 4 miles, under the blistering August sun, but the swift waters of that stream offered about our only chance for success. The stream is shallow and stony, with here and there a streak of a few rods in extent where the water may be 3 or 4 feet deep. Those deep streaks are the home of the small mouth black bass.

The morning after Mr. Cone's arrival we got an early start in our skiff, loaded with our fishing tackle, lunch, and other luggage. It was cool when we commenced our pull up the river, and the fresh morning air as we rowed past the green forests crowning the towering bluffs caused my companion to exclaim,

"By George! it seems good to be here once more, out of the dust and hubbub. It hasn't been more than 2 hours since breakfast, but I am as hungry as a bear. For the last 3 weeks I haven't eaten enough to keep a 5-year-old boy alive, but when I struck town last night the change of air made me wolfishly hungry, and I had to buy a sandwich before I came up to the house."

The sun soon banished the coolness of the morning, and the early warblers became silent. The green heron and the sandpiper left the shore for shady nooks, and no living creatures were to be seen excepting long lines of turtles of all sizes, which lay basking on logs and old flood-trash. As we approached them, they rolled off, one after another, with a splash, into their native element. The only sound to be heard was the chirping of hidden crickets, and at intervals the droning sound of the harvest fly, from his resting place in some forest tree.

The current was getting so swift that we landed the boat, and continued our journey on foot to the shallow, swift water. There we donned our wading rigs, stepped out into the riffles, and in a few minutes had secured an ample supply of lively minnows. Then our more serious work commenced. I showed my companion how to hook the minnows through the lips, and how to cast his line for this style of fishing. When our bait would get down to the deep spots, there would be a savage splash and then how our reels would sing! The fish were greedy and took hold as if to say, "Just what I've been waiting for." They ran in weight from ½ pound to 2½ pounds. All who have fished bass on swift water know what resistance they are capable of making when they have the current to aid them. I had a strong rig and I grew impatient at the fight they made. I struck as if they possessed cast iron mouths, and then tried to snake them in headlong. This caused my friend much merriment. He accused me of being a pot fisherman, and of trying to land the bass in the wheat field back of us. I found it best not to force the fish too much, however. If crowded too hard in trying to bring them to the net too quickly, bass break water several times, leaping out with wide open mouth, and shaking their heads like angry dogs in their efforts to get rid of the hook, which they often succeed in doing.

Cone had a supply of artificial bait, which he tried successively; but he finally relegated the whole lot to his truck box, for minnows seemed to be the bait supreme. We fished the whole length of the swift water, which took us until nearly 5 o'clock in the afternoon. We had a trap with us, floating in the water, and as fast as we caught a fish we dropped him in and he was in his native element again, but with his liberties somewhat curtailed.

When we reached the boat at the head of the pond, we dumped our fish on the bank and found we had 112. Of course, such a catch is unusual, and I do not approve of fishing just to see how many can be caught, thus depleting the waters, in a short time, of all that the true sportsman holds dear; but I mention the number in this instance to show that good sport may be had fishing during the extreme heat of midsummer, when streams are low and the fish, living in slow, sluggish waters, have no life to respond to the allurements of the angler.

Schlitz

MILWAUKEE'S LARGEST BREWERS

**Over One Million Barrels
of Schlitz Beer Sold in One Year**

This makes us, by over one hundred thousand barrels, Milwaukee's largest brewers, and Milwaukee, as you know, is the most renowned brewing center in the world.

This is How It Was Done

For fifty years we have doubled the necessary cost of our brewing that Schlitz Beer might be pure.

We cool Schlitz Beer in plate glass rooms, and all the air that touches it comes through filters.

We age our beer for months before we market it. That is why Schlitz Beer doesn't cause biliousness.

We filter Schlitz Beer through wonderful filters, then sterilize every bottle after it is sealed.

The Beer that Made Milwaukee Famous

A DAY WITH THE JACK RABBITS.

Denver, Colo.

January 29, 2 nimrods of this city arranged to go after jack rabbits, which a friend had located on his way from Greeley to Denver. We made arrangements with this friend to meet us at the depot at La Salle with his team and take us to the promised land.

I retired at the usual hour and had got to sleep, and the jacks were running in every direction; something was wrong with my gun, as usual, in dreams. The shot would not hit Jack hard enough to dent the hair. I was cussing the gun, shells and everything else, when the alarm clock made its unearthly racket, frightening all the jacks away. I got up, pulled myself together, went to the window and looked out. Cold and cloudy. Dressed and went down stairs to make more observations. Still colder. Went back up stairs, built a fire and invited my wife to get up. She answered "No." So I proceeded to get breakfast on my own hook and was doing nicely when someone behind me said, "Don't you know enough to put the teakettle on the stove? Get out of the way. You don't know enough to boil water." I retreated in good form to give way to my superior. She soon had a good breakfast, to which I did justice. The doorbell rang. It was my pard. I hurried to take him in out of the cold.

"Shall we go?" said he.

"Sure! I did not get up at 2.30 to stay at home."

Got into my shooting clothes and we drilled down to the depot for the 4.15 U. P. train. We arrived at La Salle at 5.45 safe. Our friend was to be there at 6.30. We waited for him till 7.15, but he did not show up. This was nice. Two feet of snow and no team within 1½ miles. We were no tenderfeet, so we started down the track on foot. Cold! Just zero by the weather machine on the depot when we left.

We had gone 2 miles against the wind when we heard someone yell behind us. Looking back, we saw the handcar with 2 men, pumping for all they were worth. We tried to flag them, but they just grinned and pumped. We had a mind to take a shot at them, but while we were talking it over they got out of range, so we gave it up.

By that time we wanted to shoot something, so Pard said: "There's a jack in that cornfield. I smell him." Over the fence we went. Presently I saw Pard stop and laugh. His jack was fast in a big tumble weed. The snow was so deep that I guess he thought he could get through the weed easier than the snow. Finally he managed to extricate himself and started for Wyoming. Pard stuck up his 16 gauge Lefever. Pop, and Jack died.

After going through the cornfield we

climbed back to the railroad and pounded ties for about 1½ miles more. Then we had a consultation and decided to go to the river, about 2 miles, and hunt cottontails. We tramped through the snow for what seemed about 4 miles. The river kept moving away. At least we could not see that we were getting any nearer to it, so we changed the programme to jacks again. We had not gone far when I heard Pard's gun pop and saw a jack kicking about it.

That was a long shot. Pard stepped it off; 68 steps, and he is no kid. Pard was shooting 2¼ drams of smokeless powder and 1 ounce No. 8 chilled shot.

We went into another cornfield, and soon I saw a brown spot on the snow. I investigated. It was about 25 yards away. I stood transfixed. Suddenly they thought of something over in the next field. Up they jumped with a loud whirl. We counted 14 beautiful Bob Whites. I have hunted Bob for 20 years, but never found him so tame before. There is no open season on Bob in Colorado and if there were it would be out before now.

Farther on Pard stopped in an open field. There was not a track in sight. He called me over, and there, within 4 feet of him, all cuddled up in a little heap about as big as your fist, sat Mr. Jack. I guess he had been there since the snow before and thought best not to make any tracks. I wanted Pard to shoot the top of his head off, as we were out of meat, but Pard objected. Wanted to give him a show for his life. Wanted me to shoot him. Suddenly it dawned on me that I had not shot yet, so I told Pard to pull, but Jack would not, so I pulled. Pard told me to kick him. I walked up to Jack and yelled, "Pull," but he would not stir, so I said: "If you will not pull I will push." I gave him a good kick on the end of the tail, and he jumped, snorted, shook himself and pulled for Kansas, with a load of chilled 7's after him from my Parker. Jack and 7's got mixed up at about 40 yards and Jack concluded to stay in Colorado.

We tramped our legs nearly off in the deep snow, got 2 more Jacks and one cottontail. Pard skinned me good. He killed 5 out of the 6 that we got. We arrived at the depot in La Salle at 3 p. m., tired almost to death, but happy.

On the train home we met another hunter. He had 11 ducks, 6 mallards and 5 teal. He had one jack that he wanted to get rid of so I relieved him. On the train were about 40 colored soldiers from Ft. Russell, Wyoming, who had just been discharged and paid off. They were much interested in our game, much more than we were in theirs (craps). One of them offered me 15 cents for a jack. Not much, Bill. Those Jacks were worth \$4 apiece. At 6.05 we arrived in Denver O. K.

Nimrod.

THE EQUITABLE

HENRY B. HYDE
FOUNDER



J. W. ALEXANDER
PRESIDENT

J. H. HYDE
VICE PRESIDENT

A GOOD RESOLUTION

for 1903 would be to save something from your income.

An Equitable Endowment policy will not only help you to save something during 1903, but will help you to save during every year for 15 or 20 years — and will assure your life in addition.

A resolution of this kind will not benefit you — or your family — unless it is carried out. If it *is* acted upon, the money you might waste will be saved.

If you would like to accustom yourself to saving something each year, fill out coupon below

(Vacancies in every State for men of character to act as representatives. Apply to Gage E. Tarbell, 2d Vice-Prest.)

THE EQUITABLE LIFE ASSURANCE SOCIETY,
120 BROADWAY, NEW YORK. Dept. 16

Please send me information regarding an Endowment for
\$ if issued at years of age.

Name.....

Address.....

AMATEUR PHOTOGRAPHY.

"For sport the lens is better than the gun."

I wish to make this department of the utmost use to amateurs. I shall, therefore, be glad to answer any questions and to print any items sent me by practical amateurs relating to their experience in photography.

LEARNED BY EXPERIENCE.

The use of a citrate instead of a bromide as a restrainer should be given a trial. Good authorities have advised its employment, claiming that its addition to the developer as soon as all desired detail was out not only restrained but entirely prevented further increase of detail, while allowing density to build up to any desired degree of which the plate is capable. With it one may over expose quite freely. The plate must be started in a developer weak in alkali, so the image will come up slowly, and then the production of detail in the high lights can be stopped at any point desired by adding 2 drams of citrate solution to the 4 or 5 ounces of developer employed. It is best to throw away this first solution after adding the citrate and rocking the tray a few minutes and secure density by applying a developer similar to Cramer's bromo-hydro formula. Used in smaller quantities as a simple restrainer it has advantages over bromide. The comparatively high cost of the chemical in the solid form is no doubt the cause of its not being more popular. When it is once understood that the solution is easily prepared by adding sulphuric acid to a solution of the carbonate, either potassium or sodium, until it becomes slightly acid, this drawback is at once removed. It is only the difficulty of crystallizing the chemical that gives it its high cost at the chemist's.

I had occasion the other day to insist that an amateur friend furnish me with some mounted pictures for wall decoration at a boys' club. He complained, with some truth, that he had no time to print any. I took 3 or 4 sheets of melton faced mounting board out to his house and made him show me what he had on hand. The stock consisted of some proofs of negatives that he considered unsatisfactory and some Velox prints that were rejected because stained on the edges. They all needed trimming down to get out the best there was in them. Some of the rejected negatives contained bits that were gems. One of them produced a 2 x 10 panel that would have been an honor to any exhibition. Fifteen or 20 of them were trimmed and pasted, some on the backs of other spoiled prints and others on the black paper that comes around plates. These were again trimmed to leave a narrow border of either

white or black and then mounted on the large sheets of different colored mounting board which I afterward cut up with scissors and trimmed with a card cutter. The prints were a revelation to my friend. His dealer will have a hard time selling him any more stock sizes in mounts, but perhaps he will sell him enough of the mounting board to balance.

When the fascinating process of using platinotype paper is taken up, it will not be long before some negatives are found which, being strong in contrast, require the printing to be carried on for such a length of time that the shadows are perfectly bronzed, and when development takes place the deep shadows refuse to come up anything but a dull brown, being much as if they had rusted like old scrap iron. It may so happen that the general appearance of the print as a whole does not materially suffer when looked at straight in front, but on viewing it from one side the defect is evident. The remedy is to brush over the parts solarized a wash of wax water magilp, which may be obtained at art supply stores. It is used in water-color painting to add force to deep shadows, and the improvement it brings about on a faulty platinotype print is marked. The dingy, rusty color will instantly depart, and the shadows will lose their bronzed appearance.

The directions that accompany developers say to do this for under exposure, and to do that for over exposure, but no allowance is made for the fact that there is a vast difference in the behavior of a plate exposed on a contrasty subject and one exposed on a subject that is flat, or contains a short range of tones. An ordinary portrait contains a short scale. A strong developer, acting quickly, is required. The average interior contains a long scale of gradation from deep darks to highest lights. A weak developer and plenty of time are needed. For over exposure on subjects with a short scale of gradation use a weak developer well restrained. With a long scale, use less alkali, more reducer and no bromide. For under exposure with a short scale of gradations use as strong a developer as the plate will stand for a long time. With a long scale of gradations in the subject, use a solution weak in reducer and strong in alkali.

Daylight as an illuminant in developing is too variable. Besides, almost any coloring matter will lose its value to some extent if exposed to strong daylight for months. However, a fairly durable glaze for a dark room window may be made as follows: Coat each side of the glass with a solution of gelatine, coloring one solution with erythrosin and the other with

orange G, aniline colors. The first will absorb the green and the latter the blue and violet rays. The gelatine films should be protected with a good coat of varnish. Old negatives may be utilized by removing the image with a reducer and then staining the film with a solution of the dye. One might also place 2 of the differently dyed plates face to face before inserting in the sash, thus avoiding the necessity of varnishing them.

A weak solution of cyanide of potassium will remove the red spots that are so often a blemish to otherwise fine prints on aristo platino. One should bear in mind that it is a deadly poison and must be used with care. A 10 per cent solution makes a good stock strength. This may be diluted 6 or 8 times and used either locally by applying with a tuft of cotton or the print may be immersed in the solution. A few drops, say 2 to the ounce, will prevent dirty whites on developing paper if added to the developer with the regular allowance of bromide. Too much will yellow the whites and cause a loss of detail, but it will keep the whites clear where further addition of bromide would result in muddy tones.

The neatest finish for the sink and shelves of a dark room, as well as the walls in their vicinity, is a coat of bath-tub enamel. For resisting the action of alkalis and acids, a coating of this enamel will surprise anyone who has used only ordinary paint around the developing sink. There will be no water-soaked wood in the room, no blotches of crystallized chemicals where solutions have been spilled, no floating particles in the air; no dust collected here and there because it is too much trouble to rub it off. The smooth polished surface is a constant invitation to give the dusting brush the little exercise required to keep all as clean as a parlor.

A mountant that keeps well in a fairly tight jar is made as follows: Work up 2½ ounces of best arrowroot with 2 ounces of water to form a thick cream free from lumps. Add 30 ounces of water and into this stir 1-3 ounce of good ground glue. Bring to a boil slowly, stirring constantly, and remove after 5 minutes' boiling. When nearly cool, add slowly with vigorous stirring 2 ounces of alcohol containing 10 or 12 drops of pure carbolic acid. A little perfume may be introduced if desired. Should it become too thick rub up with a little water.

To print a developing paper by daylight, fit a printing frame with a hinged or sliding lid so that no light will reach the negative until ready to make the exposure. To bring the time of exposure within easily controlled limits it is advisable to fit the print-

ing frame with a sheet of ground glass or to paste over the front of it several sheets of tissue paper. The light from a North window is the best to employ, as it is surprisingly uniform throughout the larger portion of the day.

Bulbs of instantaneous shutters and other India rubber apparatus that have become hard and fragile with time can be softened by putting them in the following bath 5 minutes to an hour, according to their hardness: Water 2 parts, ammonia 1 part. In case there are any cracks in the articles, they can be closed, after softening, by coating their edges with India rubber solution as sold in the bicycle stores for repairing tires.—Western Camera Notes.

CAUSE OF RUST SPOTS.

What is the cause of rust or stain spots on film negatives? I think they do not appear until after prints have been made. Can they be removed? How? Why will not negatives always dry properly? Is silver printing paper the same as Solio?

C. Steckman, Minerva, Ohio.

ANSWER.

Rust spots which appear on film negatives are probably hypo stains. They may be caused by getting hypo into the developer in some way; for instance, by having hypo on the fingers. The use of agate ware trays will also tend to give the film the same appearance.

There is no method known by which hypo or rust spots can certainly be removed from negatives. The most important thing in amateur photography is cleanliness, and great care should be taken in the use of hypo, or spots will appear in the negatives and in the prints.

Silver printing paper is the same as Solio. Solio is what is known as a gelatinum-chloride on silver printing paper. Almost all the printing-out papers are silver papers.

If you will use a small quantity of glycerine in your last wash water when washing your film negatives, in a proportion of ¼ ounce to 10 ounces of water, your negatives will dry much flatter and be less likely to curl.—EDITOR.

MOONLIGHT VIEWS.

What is the right exposure for a view by full moonlight? By electric lamplight? The lens is a rapid rectilinear. What kind of pictures can be classed as *genre* pictures? How can I get some photos copyrighted without paying a lawyer to attend to the matter for me? Which is the more rapid, the rapid rectilinear lens with which the 5 x 7 Poco and Premo cameras are fitted, or a Bausch & Lomb rapid universal lens, speed of 8? If a view taken with the first lens requires ½ second, open dia-

phragm, what is the time with the Bausch & Lomb lens?

L. Goodrich, San Antonio, Texas.

ANSWER.

For moonlight views expose one-half hour to an hour, according to strength of light, condition of atmosphere, etc. For night views in cities, 5 to 10 minutes.

Genre pictures are those typical of scenes of everyday life, types of people, etc.

Send 2 copies of each photo to the Librarian of Congress, Washington, D. C. The fee is 50 cents a plate. If you wish a certificate of copyright the fee is \$1.

These lenses are supposed to work at F. 8, and there is practically no difference in their speed.—EDITOR.

SNAP SHOTS.

I see in September RECREATION S. N. Leek, of Jackson, Wyoming, says he had trouble in reloading his camera plates without blurring. I learned how from experience. If an amateur on a camping trip does not carry a cheap ruby candle, folding lantern or lamp he will at least have a lantern. Before starting he should buy 5 cents worth of orange office paper, which he can find in any book store. Put a lantern on any camp stool or box; put the yellow or orange paper around the lantern and pin it; then put a blanket around your head, pin it, and stoop over so the blanket will also cover the box with the lantern on. Under this cover the plates can be reloaded as well as in the best dark room, and there will be no danger of blurring them. I have a good Goerz No. 3 double anastigmat lens, with Bausch & Lomb shutter.

Joseph Stenhura, Manitou, Colo.

I was much interested in what J. C. C. says in May RECREATION about Cyko paper. A year ago I was in Idaho and sent to a Chicago concern for some Cyko paper and Cyko developer. The paper worked nicely until it reached the washing stage; then trouble came in the shape of blisters. In order to save any prints I had to reduce the time of washing to $\frac{1}{4}$ of that specified in the directions. I sent a blistered print to my dealer and asked advice. Another lot of paper was sent me, and I was told that the first batch might have been an old emulsion. The new paper was worse than the old, and began to blister the moment it was put in water. However, the few prints I succeeded in saving were beautiful. Should be glad to learn more about this paper from those who have used it.

J. E. Bates, Spokane, Wash.

The Bausch & Lomb Optical Company, Rochester, N. Y., have advanced the date of closing their quarter century photo-

graphic competition to October 3rd, 1903. This has met with general approval among photographers, who realize the importance of this competition, and are anxious to submit as perfect work as possible. A number of the foremost photographers of the country have signified their intention of entering the competition, and the spirit of the competitors indicates as much interest in making choice exhibits as in winning the pecuniary awards. These aggregate \$3,000. The special award of \$300 as a grand prize for the photograph showing the best lens work of any submitted in the competition is attracting much attention among photographers who seek to know the lens and its possibilities.

A meeting was held at the rooms of the Brooklyn Camera Club, 776 Manhattan avenue, Brooklyn, November 17 last, for the purpose of organizing a League of Long Island photographic clubs. Some preliminary work in this direction was done, and another meeting will be held at the same place in the near future, when it is hoped the League may be permanently organized. At the last meeting Mr. Edwin Torbohm was elected President, and Mr. John J. Tresidder Secretary of the new organization.

My explanation of the "20th Century Dawn," October, 1902, page 253, is this: The photographer did not see half the sun's disk above the horizon, but he saw the refraction of the sun's rays before it had touched the horizon with its upper limb and the camera caught the whole disk. It is a well known fact that the sun and moon are seen before they have actually risen and seen after they have set. This effect is caused by the refraction of the rays in the air.

Geo. C. Eyrich, Jackson, Miss.

I saw in October RECREATION, page 326, that Joseph B. D., Allegheny, Pa., wishes to buy negatives of the Pan-American exposition. I have a number, 4x5, quite good, which I am willing to sell.

O. R. Cutchlon, Clarion, Pa.

A yearly subscription to RECREATION is one of the most practicable and useful presents you could possibly give a man or boy who is interested in nature study, fishing, hunting, or amateur photography.

All boys instinctively love the woods. RECREATION teaches them to love and to study the birds and the animals to be found there. If you would have your son, your brother, your husband, or your sweetheart interested in nature, let him read RECREATION. It costs only \$1 a year and would make him happy 12 times a year.

**Anybody can make
Good Pictures by the
Kodak System**

**Loading, unloading, developing, printing
—all by daylight. Better results than
the old way, too**

**Dark-Room
Abolished**

**EASTMAN KODAK CO.
ROCHESTER, N. Y.**

New booklet, "The Kodak Way," free at the dealers or by mail

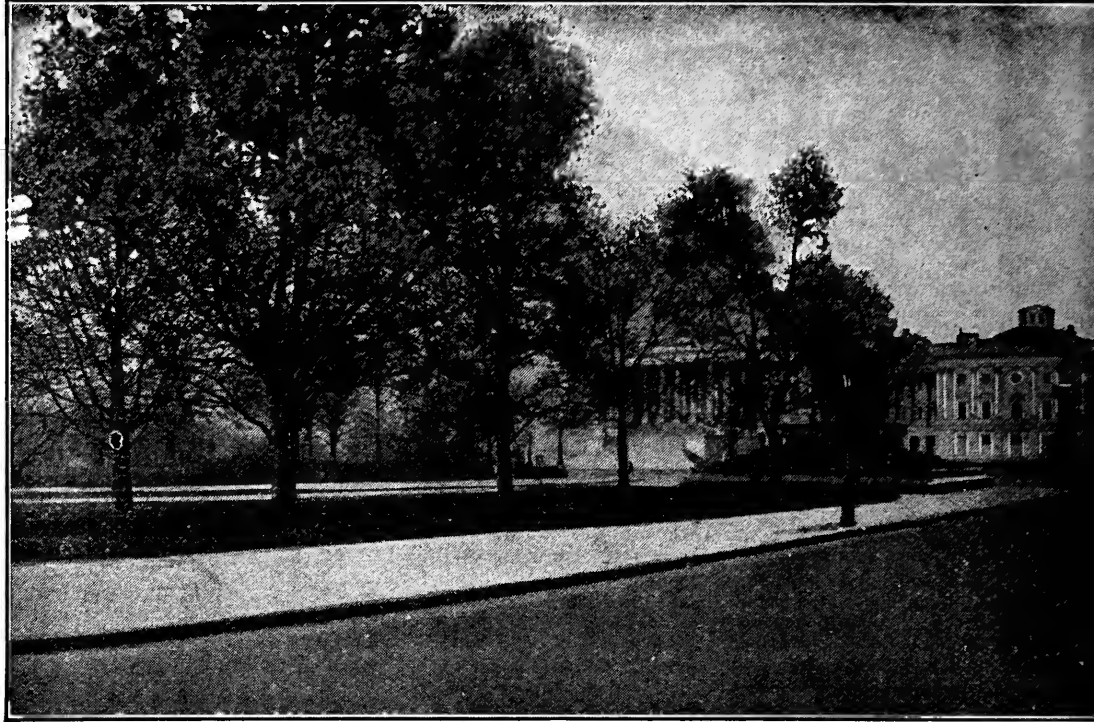

All in one picture, by the

take half length views, or with some models, stop the lens at five different places, and thus make five different widths of pictures, all depending on just how much of the view you wish. These are features no other camera possesses.

We will send free on application our beautifully illustrated catalogue.

Multiscope & Film Co.

136 Jefferson Street,

BURLINGTON, WIS.

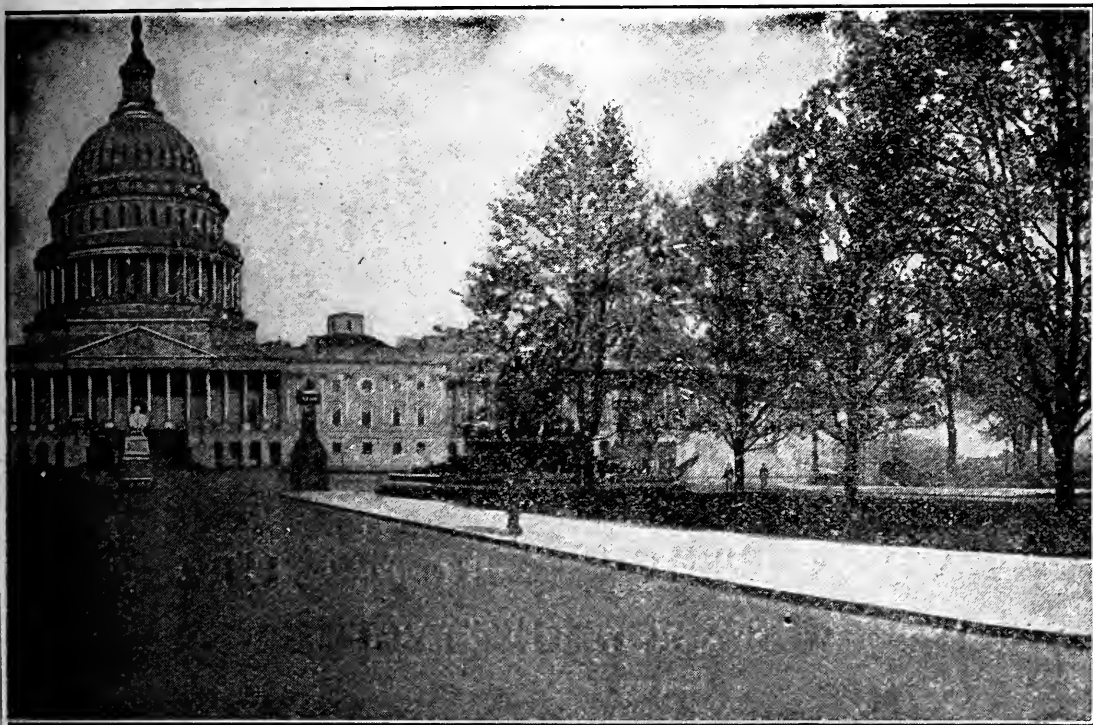

Al-Vista Camera, or you can

All our cameras take the daylight loading film cartridges—the regular sizes, so that any dealer can supply you, no matter in what part of the world you and your “Al-Vista” may be.

OUR CO-OPERATIVE PLAN

We now send you any camera described in our catalogue upon a small payment being made. The remainder you may pay in monthly instalments while you are using the camera. Write us for full information about this.

Multiscope & Film Co.

136 Jefferson Street,

BURLINGTON, WIS.

Are You an
Amateur
Photographer?



If so would you like a Camera
that will photograph

A whole range of mountains
A whole sweep of river
A whole army
A whole fleet of ships
A whole city

Or any other vast stretch of scenery or moving
objects? THE SWING LENS DOES IT

The Al Vista

Is the thing. It lists at \$30.

One of the greatest inventions of the age.
Given as a premium for 20 subscriptions.

For particulars Address

RECREATION

23 West 24th Street

NEW YORK CITY

R. O. C.

The Rochester Dry Plates

Make
the Negatives
that Make
the Pictures
that Make
the Fame
of the Artist

Ask the dealer for them
or send for Booklet

ROCHESTER OPTICAL AND CAMERA CO.
Rochester, N. Y.



IN NAME—**ROYAL**—IN QUALITY
ARE

Royal Anastigmat Lenses

**Royal
Anastigmats
are
Winners**

WE know it and we want you to know it, as **GREAT RESULTS** are sure to be obtained by the users of a **ROYAL**. They have speed, fine definition and great covering power and will prove a delight to the connoisseur of high grade objectives.

We make them in three series, ranging in relative aperture from F. 7. 5 to F. 5. We also make one of the very best Wide Angle Anastigmats on the market. Write and let us mail you our catalogue giving a detailed description of these lenses.

ROCHESTER LENS CO., 66 Atlantic Ave., ROCHESTER, N. Y.

DO YOU WANT A CAMERA?

If so, you can get it
Without \$1 of Expense

A Model 10, Century Camera. Listed at \$9.
For six yearly subscriptions to
Recreation.

A Model 12, Century Camera. Listed at
\$18. For 12 yearly subscriptions to
Recreation.

A 5x7 Century Grand. Long Focus, Double
Swing, with Wide Angle Lens. Listed
at \$60. For 40 yearly subscriptions to
Recreation.

Such opportunities were never before
offered.

I have but a few of these Cameras on
hand, and when the supply is exhausted
this offer will be withdrawn.

Sample copies of *Recreation* for use in
canvassing furnished on application.
Address

**Recreation, 23 West 24th St.
New York City**

FREE.

To any person sending me a subscription
to *RECREATION*, accompanied by \$1, I will
send one copy of the "Song of Songs," a
drama in 5 acts, based on the Song of Solo-
mon. This is an interesting, instructive
and elevating play, written by my late hus-
band, the Rev. Morse Rowell, Jr. The
book is bound in paper and is alone worth
\$1. In addition I have arranged with the
editor of *RECREATION* to send the magazine
to all subscribers who may send me their
subscription on this plan.

Mrs. Belle J. E. Rowell,
Miller Place, L. I.

Free: For 1 year's subscription of *REC-
REATION*, through me, will give 1 Bromide
enlargement, any size up to 11x14 inches
inclusive, from any negative not larger than
4x5; or from photographs. Negatives and
Photos to be returned to the owner. Here
is a rare chance to get a large Photo from
your pet Negative, also *RECREATION* for \$1.
A. F. Evarts, Meriden, Conn.

UNMOUNTED PHOTOGRAPHS

I will pay cash or give liberal exchange for interesting
unmounted photographs, any size, either amateur or
professional. **Wilfred S. Tilton, Prairie
Depot, Ohio.**

IT'S ALL IN THE LENS

Series V Long Focus Korona

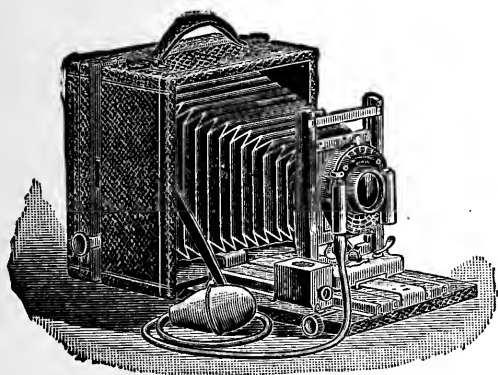

Can be used with equal facility for everyday, hand-camera

Snap Shots

Photographing Distant Views

Copying

or other work needing bellows capacity, and also with wide-angle lenses for interiors and kindred subjects.

ONE CAMERA DOES IT ALL

Every adjustment is a marvel of simplicity and mechanical ingenuity, and many of them are found exclusively on the Korona.

Note our patent auxiliary bed for use with wide-angle lenses, and compare it with

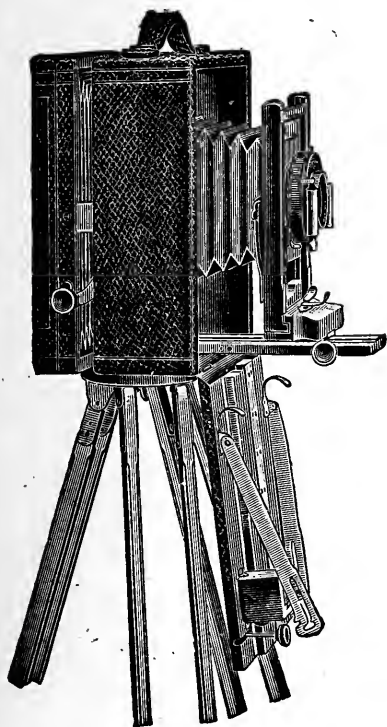
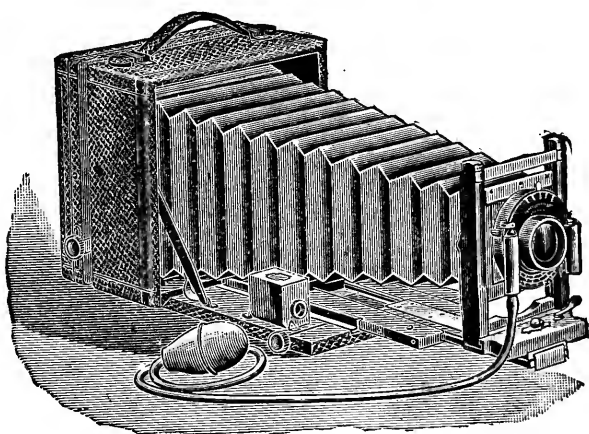

the clumsy methods used to obtain this result on other cameras.

Our patent automatic swing back operates from the center according to correct principles.

KORONA LONG FOCUS

Has a Convertible Lens, Automatic Shutter, and numerous other special advantages.

Catalogue gives full information

Gundlach-Manhattan Optical Co.
ROCHESTER, N. Y.

Mention Recreation

Decorate Your Den

With a set of the most beautiful
Hunting and Fishing Pictures
 ever made.

15 Plates. Size for Framing, 18 x 24 inches

SUBJECTS:

ELK HUNTING, SALMON FISHING,
MOOSE HUNTING, TROUT FISHING,
 HY. SANDHAM

MALLARD SHOOTING,
BLACK BASS FISHING,
 C. E. DENTON.

TARPON FISHING, BLUE FISHING,
 FRED. S. COZZENS.

ANTELOPE HUNTING,
GOOSE SHOOTING,
 FRED REMINGTON.

GROUSE SHOOTING,
WILD TURKEY HUNTING,
 R. F. ZOGBAUM.

MUSKALONGE FISHING,
 F. H. TAYLOR.

DEER HUNTING,
 A. B. FROST.

ROCKY MOUNTAIN SHEEP HUNTING
 E. KNOBEL.

These 15 plates are lithographed in the true colors of nature and altogether make one of the finest series of pictures of outdoor sports ever published.

ORIGINALLY ISSUED AT \$50.00 A SET.

I have bought the last of them and can furnish a complete set for 15 yearly subscriptions to RECREATION.

Or will sell at \$10.00 a set.

Address, RECREATION, 23 West 24th Street, New York City.

Something New!

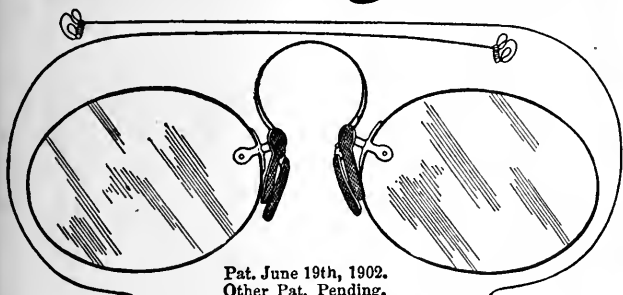

Pat. June 19th, 1902.
Other Pat. Pending.

PRESTO! CHANGE! Attachable Eyeglass Temples

Every wearer of eyeglasses wishes occasionally that they were spectacles. Spectacles stay on, however violent one's exercise, however warm or stormy the weather. This little device can be readily attached or detached without injury to the lenses, thus in a second giving you the choice of either spectacle or eyeglass. Just the thing for outdoor sports. The Temple Attachment will fit any of your eyeglasses and can be carried in the same case with them.

Send thickness of lens when ordering by mail.

Price in Nickel, 50 cents a pair

Price in Gilt, 75 cents per pair.

Send for Circular.

Our illustrated holiday catalogue can be had for the asking

We carry everything in the Optical and Photographic line Eyeglasses, Spectacles, Cameras, Opera, Field or Marine Glasses, Thermometers, Barometers, Telescopes, Hygrometers, Sun-dials, etc.

GALL & LEMBKE, Department C.

Established 1842.

21 Union Sq., New York.

Lake Koshkonong is in Southern Wisconsin; is 10 miles long and 3 to 4 wide. It is the favorite feeding ground of the canvasback duck, and they are there in thousands in the spring and fall. Fish abound in its waters. We have game hogs there in plenty. They shoot canvasbacks for market, and use great strings of decoys and a scull boat in violation of the game law. About 30 of them were arrested and fined last fall. Hotel accommodation is good and there are plenty of boats.

H. E. Shannon, Westby, Wis.

Prairie chickens abound on the plains of Eastern Washington, and blue grouse are numerous in the timber. There are plenty of elk, deer and bear in the mountains. I have hunted the ranges from Idaho to British Columbia, and am especially familiar with the Clear Water. If any reader wants information about that country, I shall be glad to hear from him.

W. J. Davidson, Oakesdale, Wash.

White Mountain Views Free

To any person sending me a subscription to RECREATION accompanied by \$1. I will send two mounted photos, on velox paper taken among the White Mountains, size 6x8; one shows Mt. Washington snow capped. To any one sending 2 subscriptions with \$2 I will send a souvenir of the White Mountains, size 4½x5½ containing seven photos. Send P. O. Money Order

M. E. TUTTLE, Box 337, Dover, N. H.

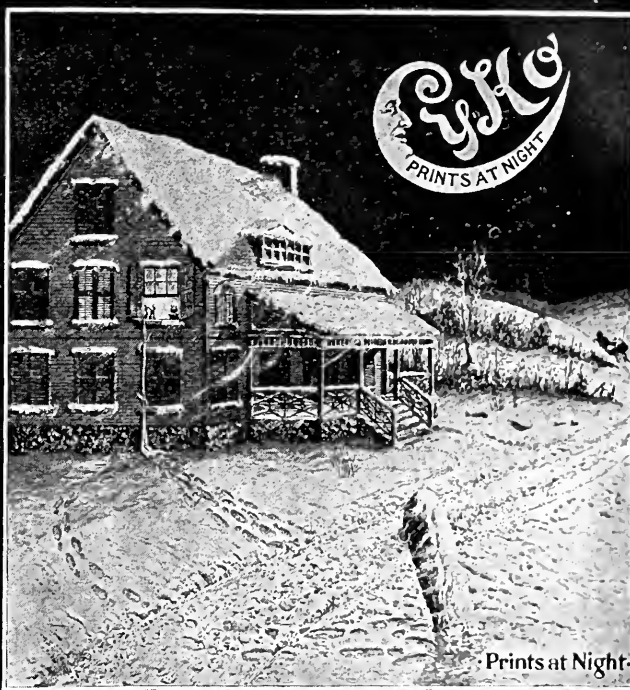

Prints at Night.

CALDER

A Night
Printing
Paper

CYKO

No Dark
Room
Required

Makes Beautiful Prints in Black and White.

The Only Paper for Winter Scenes

One dozen 4x5 Cyko with Developer, 20 cents.
Of your dealer, or

THE ANTHONY & SCOVILL CO.

122-124 Fifth Ave., New York Atlas Block, Chicago

LANTERN SLIDES COLORED IN AN ARTISTIC MANNER

Special attention given to the wants of Amateur Photographers Correspondence promptly attended to. I refer by permission to the Editor of RECREATION.

MRS. BUTTLES SMITH,

606 W. 115th Street,

New York City.

Huron Indian Work: To any one subscribing to RECREATION through me I will give a Bracelet and Ring worked in horse-hair, with any small inscription you like, your name, etc., woven in it with caribou hair; quite a curiosity. Send along your \$1. Walter Legare, 518½ John Street, Quebec, Canada.

Do You Want a Drinking Cup Free? Send me \$1 for a new subscription to RECREATION and I will send you either a fine nickel-plated folding drinking cup or a collapsible rubber cup. For 10 cents extra will send by registered mail. Thomas H. Walker, 295 Merrimac Street, Manchester, N. H.

MAGIC LANTERNS STEREOPTICONS and VIEWS

for Public Exhibitions, Church Entertainments, for illustrating sermons. Many sizes. All prices. Chance for men with little capital to make money. 260 page Catalogue FREE.

McALLISTER, Mfg. Optician, 49 Nassau St., N. Y.

SOME BUCK FEVER CASES.

There seems to be many styles of buck fever, but most attacks are confined to the first sight of wild deer. The first deer I saw was after days of patient watching, and when I heard a noise in a fallen tree top, I thought it must be a man. However, an old doe and a fawn soon came in sight, stopped, looked around and then loped slowly across an old logging road. I remember how tightly I gripped my gun, and how hard I tried to raise it to my shoulder, but it seemed impossible to move it. In fact, I stood paralysed, rooted to the spot. My hair seemed to rise, my tongue was dry and my heart pounded against my ribs in a most painful manner. As the deer, all unconscious of my presence, walked slowly out of sight, I took to trembling and am sure I could not have hit a flock of barns. It was a full hour before I could control my reason, and the sensation will never be forgotten.

Another case: A young man on his first deer hunt saw a doe feeding about 8 rods away. He raised his rifle, took careful aim, but could not pull the trigger. Try as hard as he would he could not make his finger move.

In another case the fever seemed to affect the finger in a different way. The hunter was standing on a runway with cocked gun and the muzzle resting on the toe of his shoe to keep the snow out. When an old buck walked out near him his finger worked but he failed to remove the gun from his foot. The loss of his toe brought him back to his senses.

Another inexperienced Nimrod, a man of about 30 years, was placed on a runway while the rest of the party drove a small thicket. They started a large buck which took the right runway and passed unharmed within 10 feet of the astonished hunter. All the poor fellow did was to exclaim, "Wasn't he big!" Perhaps the scolding he got steadied his reason, for he killed his next deer without looking to see if it was big or little.

Here is a case where the fever affected the auditory nerves. A man about 60 years old, who was a fine shot, but who had always hunted small game, saw his first deer. There were 3 quietly feeding on a hillside. Taking a careful aim at the shoulder of the largest, the hunter pulled the trigger. The deer all ran over the hill out of sight, and the man believed that he had snapped a poor cartridge, for it did not make any noise. In the belief that the shell had missed fire, he returned to camp. After we heard his story of how this deer had dropped her tail and then run ahead of the others, we sent a party back to investigate. They found a dead deer, shot through the heart.

It is no disgrace to have this fear, even if it lasts longer than the first sight of game; because the one who has it the worst generally has the larger imagination and will make the keenest sportsman.

Medicus, Hart, Mich.

YOUR HUNTING COMPANION

REV. WM. CHILDS.

The pleasures of the sportsman are largely increased by the fellowship of an agreeable companion. Anyone will not do; such a man must have more than ordinary patience and forbearance. He must also have ability, joined to a keen sportive nature. When he makes a clean miss he must be able to endure all your ridicule; and when you miss he should be ready to return the compliment.

When you make a record (not a game hog's record), he of all men must magnify it till you really think you have grown a few inches taller. When you get the buck fever and allow that 200-pound deer to walk away from you, he must palliate the circumstances by the assurance that it was one of the most difficult shots he ever saw. When you lose your "biggest fish" he must tell it to the boys and make it still bigger.

To the tenderfoot such a companion may seem unnecessary, but to the man who loves gun and rod he is a blessed reality and a necessity. To such a friend you tell the "whole truth"; to the other fellows you never reveal how the deer was rubbing the end of your rifle barrel when you missed, or that the fish got away because you were excited.

Such a companion exists. He paddles the boat patiently hour after hour when you cast your new bait, assuring him that the fish will follow it right into the boat. He sits by your side in the "wee" hours of the morning on a wild goose chase, or to some favorite hunting ground. He indulges your every whim and crawls out of his warm bed at unseemly hours at your call. During the close season he drops in for a chat and revives memories of many a pleasant outing spent together. He is your right hand man whenever you need him. You are happy when you can beat him at a score and just as happy when he beats you. He must not be your inferior but at times your superior. All brother sportsmen know this companion; but for him the woods would be empty and the lakes lonely.

This region is a good game country. Deer have increased wonderfully in the last 3 years, and do not leave for the high mountains in summer as they used to. The game law is generally respected. Hunting parties from the East do not stop here, but cross the range. Bears are numerous; mountain lions are also plentiful, but hard to find. I succeeded in getting 2 last November. Wildcats, coyotes, a few gray wolves and some mountain sheep complete our list of large game. I use a .38-55 '94 model Winchester. If that gun was built for smokeless powder it would have no equal.

A. L. Sweitzer, Bare Hills, Colo.

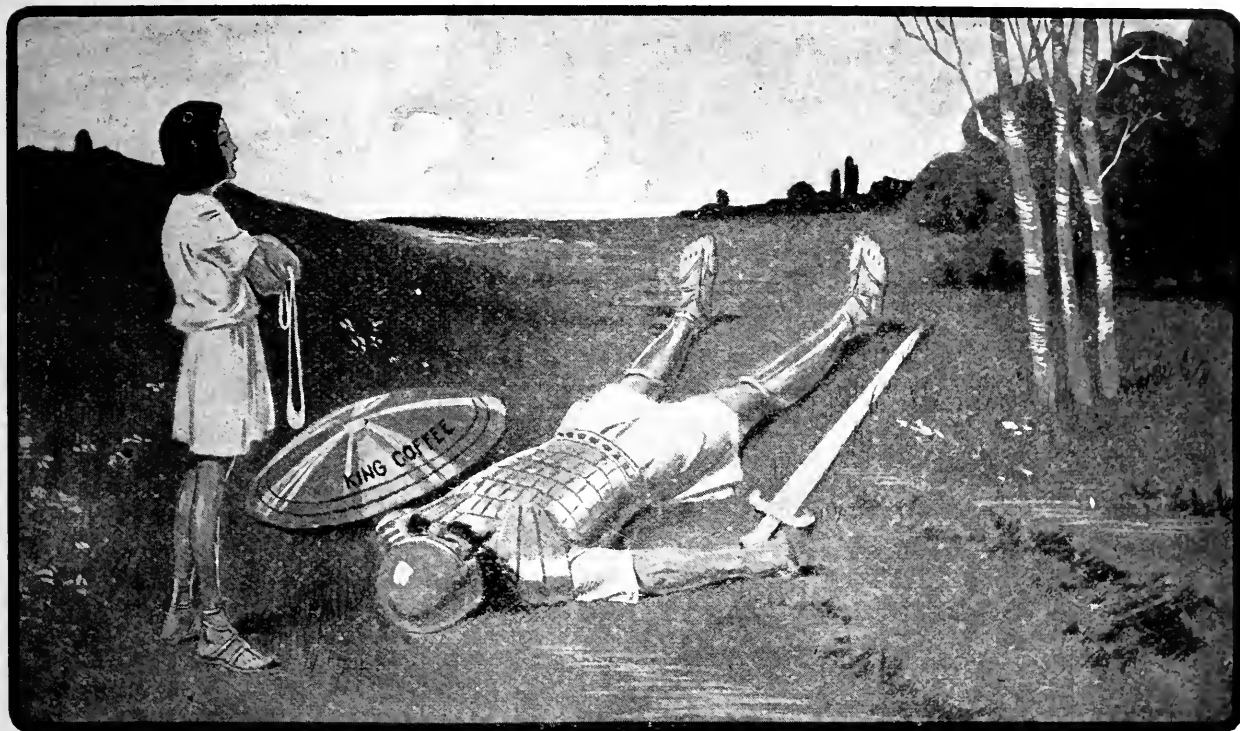

David and Goliath.

A Little Shot Put Old King Coffee Out of Business.

When medicine fails, they sometimes send sick people away to another climate for their health. Sometimes the climate does it, but more often they stumble on the proper food to take, and then get well.

A lady in San Diego tells of a friend who left her home each December, for the past two winters, to come to California for her health. She says:—“Almost all of her time was spent in visiting the doctor and sitting in a big chair and watching the clock to note the time for her next dose of medicine. Nervousness was her principal trouble, and with others of a kindred nature, made life for her a burden.

On the occasion of her last visit, I begged her to give up the use of coffee, and use Postum Coffee. She replied that she could not stop coffee. I said no more at the time, but the next morning at breakfast, I passed her a fragrant, steaming cup of Postum, making it as it should be

made. After that, I had no more trouble, and my friend drank no more coffee. But the most surprising part of the experience was the change that soon came over her.

We began to notice it within less than a week. In less than a month, her nervousness had left her, and in three months, she was a new woman in face, figure and health. I had not dared to hope for so much benefit, although I had been greatly benefited myself by Postum, but coffee to her system was simply poisonous and I believe this is the case with many others.

She returned to her home in December, and was married within less than two months after. She never fails to give credit to Postum for her health, or thanks to me for teaching her to make it properly, and well she may, for Postum has done for her what travel, doctors and medicine failed to do.”

Name given by Postum Cereal Company, Limited, Battle Creek, Michigan.



Bicycle Playing Cards Favorites the world over.

When you play with "Bicycle" Playing Cards you Hold Good Cards. Sold by dealers. Popular price. 29 backs. Order by name. Design shown is "Locomobile." Copyrighted, 1900, by

The U. S. Playing Card Company,
Cincinnati, U. S. A.



Warm Feet.



The greatest comfort and luxury of modern days; magnetic fire under your feet; the greatest life-protector known; your feet keep warm all the time, even if standing in water, snow and ice. Keeps rheumatism, colds and grippe out. If you doubt our word for it read what men and women, whose only interest in Thacher is what he has done for them, have to say. Following are extracts from genuine letters, which anyone can see:

St. Louis, Mo.
I am glad to be able to say that my wife no longer suffers with cold feet. The insoles benefited her from the first time she wore them. J. D. Wilson.

Knoz, Pa.
They keep my feet warm & I feel ever so much better. Mrs. Eliza Duncombe.

St. Johns, N. B.
They are little giants of force and warmth. C. J. Walsh.

Bordentown, N. J.
Please send me a pair of No. 7 Magnetic Insoles. I have been greatly benefited by the pair I purchased a year ago. F. J. Scovel, Jr.

Vacaville, Cal.
They seem to be the only thing that will cure and prevent chilblains. Chas. S. Curtis.

Price \$1.00 per Pair or Three Pairs for \$2.00.
Send for book full of information, mailed free on request.

THACHER MAGNETIC SHIELD CO.,
Masonic Temple, 87, Chicago, Ill

The Atlin district, in British Columbia, abounds in bear, mountain sheep, goats, moose, caribou, grouse, ptarmigan, ducks and geese. Recently on a trip to Leslie's lake, 90 miles from Atlin, my partner and I saw numerous caribou, and a large band of mountain sheep. We could easily have photographed 2 caribou and 3 sheep. This section of the country has been little hunted save near the mining camps. It is full of lakes and rivers abounding in fish and easily navigable. Although in the Arctic slope the climate is all that can be desired; August, September and October being the most enjoyable months. I should be pleased to answer any inquiries from fellow sportsmen.

Chas. B. Jones, Atlin, B. C.

Free: Cloth bound book, 766 pages, finely illustrated, on our war with Spain, given free to each one who subscribes for RECREATION through me. Address, C. L. Wyckoff, Cuba, N. Y.



Trial Box Free

which will give any lady a beautiful complexion. It is not a face powder, cream, cosmetic or bleach, but is absolutely pure and you can use it privately at home. It permanently removes moth patches, redness, crow's feet, pimples, blackheads, fleshworms, sallowness, freckles, tan, sunburn, and all complexion disfigurements. Address, Madame M. Ribault, 8989 Elsa Building., Cincinnati, Ohio

ASTONISHING OFFER TO SUFFERERS FROM

Rheumatism, Neuralgia, Pleurisy, Sciatica, Nervous Prostration, or any Blood or Nervous Disorders.

WE GIVE YOU THIS WONDERFUL APPARATUS FOR AILING MEN OR WOMEN

ABSOLUTELY FREE

to prove how it restores the power and buoyancy of perfect health—curing absolutely any ailments caused by over-taxed nerves and depressed vitality.

It is well known that all nervous diseases and resulting troubles arise from overworked nerves, which cause poor circulation and sluggish blood. To successfully meet and master these conditions, has been the hope of ages. Attempts to effect cures with internal remedies have proven a signal failure. A French physician, realizing this fact, experimented with various methods of supplementing the main nerves by artificial carriers of force, and the outgrowth of his experiments is

THE SYTONIC METHOD

This Sytonic apparatus shown in drawing consists of one main pad or "force center" applied to the back between the shoulder blades and two secondary pads or "force extremities" applied to the soles of the feet. These are connected by "force carriers," which supplement the main nerves of the body, relieving them of the excess work necessary to quicken the circulation throughout the entire system. This stimulates circulation and carries to the remotest recesses of the body the curative properties contained in the pads, soothing, quieting and strengthening all the nerves, gathering the impurities from all diseased portions of the body. **Every organ is strengthened**, every function is restored and joyous, abundant health returns.

This is a safe, logical treatment, and we have yet to find a single case of nervous or blood affliction which we cannot cure.

OUR LIBERAL OFFER TO SUFFERERS

Upon receipt of your name, address, height and nature of your trouble we will send you prepaid one complete apparatus with full directions absolutely free. No C. O. D. charges with the apparatus or afterward, or anything of that sort but **ABSOLUTELY FREE**. We only ask you to put on the apparatus and wear it; if it helps you send us one dollar; if not we ask not one cent.

We can afford this offer, because failures are few. They occur only when there are cases like cancer, which nothing can cure.

We have furnished the Sytonic apparatus to thousands, and 49 out of every 50 cases have cheerfully paid, because they got well. We stand the cost of the apparatus when one says we have failed. We don't want the money of the hopeless.

WRITE TODAY, as we file applications in the order received. Address

Dept. J. **THE SYTONIC COMPANY,**

Financial References—People's National Bank, Jackson, Mich. **JACKSON, MICH.**

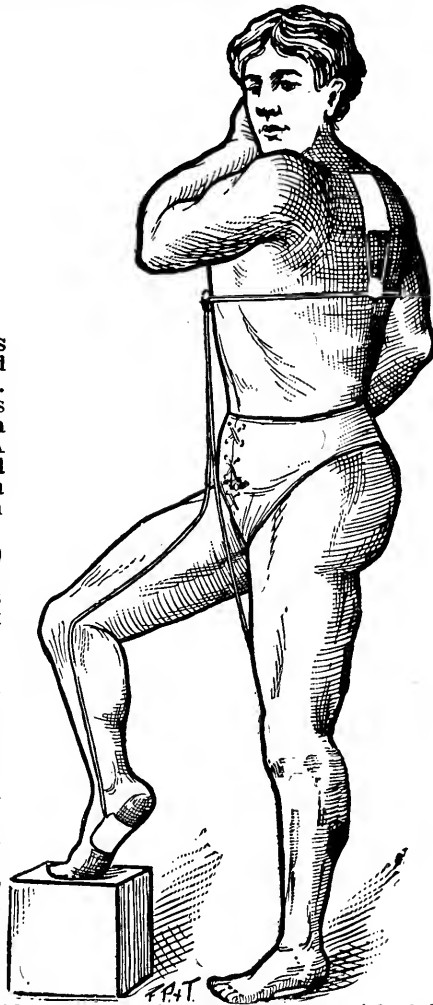

The Lamp of Steady Habits

The lamp that doesn't flare up or smoke, or cause you to use bad language; the lamp that looks good when you get it and stays good; the lamp that you never willingly part with, once you have it; that's

The New Rochester.

Other lamps may be offered you as "just as good"—they may be, in some respects, but for all around goodness, there's only one. *The New Rochester*. To make sure the lamp offered you is genuine, look for the name on it; every lamp has it. (300 Varieties.)

Old Lamps Made New.

We can fill every lamp want. No matter whether you want a new lamp or stove, an old one repaired or refinished, a vase mounted or other make of lamp transformed into a **New Rochester**, we can do it. Let us send you literature on the subject.

We are **SPECIALISTS** in the treatment of diseases of Lamps. Consultation **FREE**.

THE ROCHESTER LAMP CO., 38 Park Place & 33 Barclay St., New York.



HUNTING WITH A BAUSCH & LOMB FIELD GLASS.

I carried a Bausch & Lomb prismatic field glass with me to the Rocky Mountains last spring and got so great an amount of pleasure and satisfaction from its use that I deem it only fair and proper to tell the readers of RECREATION something about it. We camped in a canyon some 2,000 feet deep. In fact, some of the peaks on either side of us rose to heights of 3,000 to 5,000 feet.

and we could plainly see his eyes, his horns and hoofs in detail. We could easily distinguished the mane and the beard, and could even determine whether or not his hair was wet or dry. We could tell when the goat was chewing his cud and when he was not. In cases where he had walked through patches of snow, we could track him by the aid of the glass.

One old goat remained several days



A GOAT WITH A BROKEN NOSE.

White goats were in sight nearly every day, on the sides of the mountains about us, though they never came within less than $\frac{1}{2}$ mile of the camp. On clear days I frequently set up the tripod of my camera, laid my gloves on it and the field glass on these, so that I could easily shift it, to command a view of any section of mountain or side of canyon wall within the range of our vision. The results I obtained in this way were simply marvelous. A goat a mile away would appear through the glass to be not more than 100 yards away,

on a certain bench of the canyon wall, comprising not more than 5 acres of ground. This animal was nearly always seen broadside to, but finally lay down facing us. I set up the tripod, took a careful look at the creature, and found it had been seriously wounded in some way. Its face was badly cut and torn, and a section of its nose, some 6 inches long, extending from about the eyes to the tip, was an open sore. There was also a wound on one shoulder.

We were there during the close season on these animals, and under

other circumstances would not have shot at one of them. I, however, told Mr. Wright, the guide, that I thought it would be best to go up and see what the trouble was with this animal. He went, and Coleman with him. They easily got within 50 yards of the goat and found that the entire lower portion of its face had been torn off; that the nostrils were exposed and bleeding; and they naturally concluded that as soon as the warm weather and the flies came the goat would die from the effects of its mis-

We also had great fun watching birds and red squirrels, through the glass. A wren 100 yards away could be seen so plainly that we could count the feathers in its wings.

In targeting our rifles, at 200 yards, we could see every bullet hole plainly, and thus dispense with the services of a marker.

An old trapper who camped near us had a bear trap on the side of the mountain, nearly a mile from camp, and every morning we took a look at this to see whether it had been sprung.



BAUSCH & LOMB-ZEISS STEREO BINOCULAR. POWER 4 TO 12 DIAMETERS.



Field of STEREO Glass.



Field of Ordinary Glass.

fortune. They accordingly crawled up, made several photographs of the goat, in various positions, and then killed it, in order to put it out of its misery. The illustration herewith shows the goat in profile, but anyone familiar with the anatomy of this animal will see that the Roman part of its nose, so to speak, is all gone. Thus it happened that we were able to save this poor beast from a slow and lingering death by having a powerful field glass with us. The goat had evidently been caught in a snow slide.

Thus we saved him many a weary climb up the hill. Finally one morning we saw something in the trap, sure enough. We could not quite determine what it was by simply holding the glass to our eyes; but when we put it on the tripod and made it rigid, we saw in a moment that the bear was only a measly porcupine.

A prismatic field glass is an absolute necessity in the outfit of every hunter or nature student, and no man should ever go into camp without one of these powerful instruments

WHEN ANSWERING ADS ALWAYS MENTION RECREATION.

For Holiday Presents

For your best girl, or your brother, or for some other girl's brother, or for any one you love, and who is fond of skating

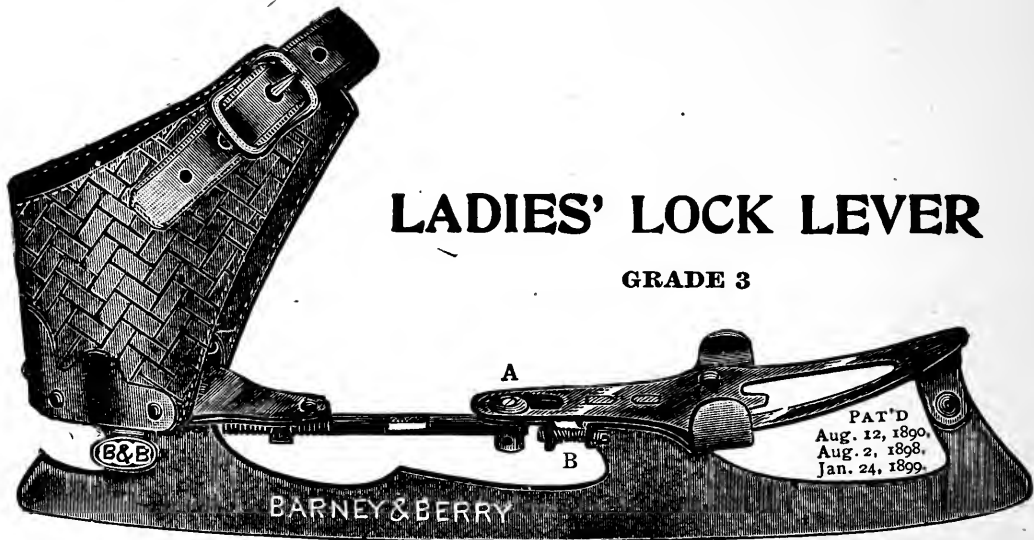

For 5 Yearly Subscriptions to **RECREATION**

I WILL SEND YOU

A pair of Lock Lever Skates

OR

A pair of Ladies' Lock Lever Skates

Grade 3, made by Barney & Berry, Springfield, Mass.

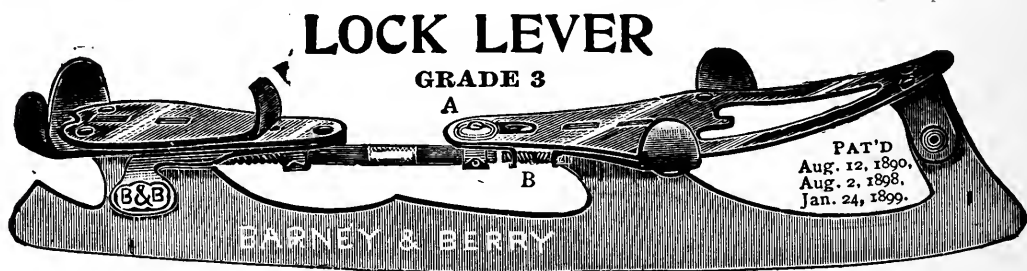

As every skater knows, these are the best skates made in the world.

The winter season is approaching, and you could scarcely select a more appropriate present

**FOR A MAN, OR A WOMAN,
A BOY OR A GIRL,**

than a pair of these high-grade skates. Only a limited stock on hand, and when these are gone this offer will be withdrawn.

Sample copies of **RECREATION** for use in canvassing furnished on application.

STRENGTH

Twenty-five years ago in acquainting jewelers with the strength of the Jas. Boss Stiffened Gold Watch Cases, an enterprising salesman used the method here shown.

Jas. Boss Cases are still the strongest cases made. As good as solid gold in appearance. Better than gold in wearing quality. Less than solid gold in cost. In a

JAS. BOSS

Stiffened GOLD Watch Case

there is a layer of very hard composition between an inside and outside layer of solid gold, reducing the cost of the case, and adding greatly to its strength.

BOSS cases are guaranteed to wear 25 years; are recognized as the standard, and sold as such by all jewelers. Write us for a booklet.

THE KEYSTONE WATCH CASE COMPANY, Philadelphia.

By This Mark  You Know Them.

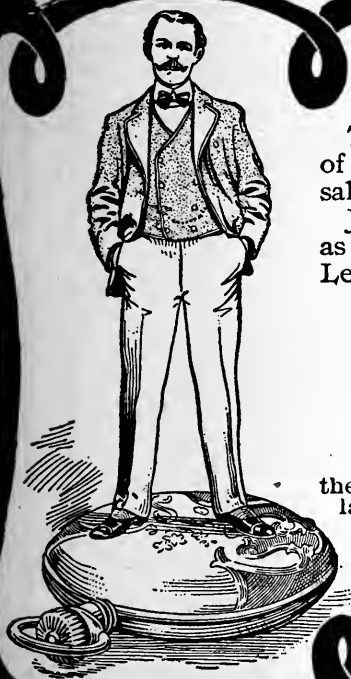

I have known 13 shots from a repeating gun fired at a deer 75 yards away, and not a hair of the animal was touched. Have seen cartridges ejected without being fired. Have known a ball to strike 14 feet above a deer at 20 yards distance and the man behind the gun so stricken with fever that he could not reload. How easy it is for a man badly rattled to fail to work the action of the gun to its full extent! Under such conditions any repeater will balk. No man should take a gun with whose action he is unfamiliar, into the woods and expect it to do good work from the start. Study the mechanism of your weapon and do a little target shooting before you try it on game. Commencing as I did with a flint lock, almost any modern gun seems to me marvelously accurate and efficient.

C. T. B., Bear Lake, Pa.

A recent story in RECREATION reminds me of a great shot once made by Pitts Eastman, who formerly lived here. His father owned a single muzzle loading shot gun with a barrel 6 or 7 feet long, which was noted as a long range weapon of great killing power. One day Pitts took the gun and went hunting. Seeing a rabbit 15 or 20 rods away, he took careful aim and pulled the trigger. There was a loud report, but the rabbit never moved. Pitts thought it mighty queer, and to investigate the trouble, he climbed on a stump and looked down the muzzle of the gun. Pitts used to say, when telling the story: "I see that charge acomin' up awlizzin' an', by gosh! I had jist time to pint the gun at the rabbit when out it whooshed; an' there warn't enough of that bunny left to pick up."

M. P. K., Comstock, N. Y.

No. 58

HERE IS A KNIFE Men Love So Much They Hate to Throw an Old Handle Away

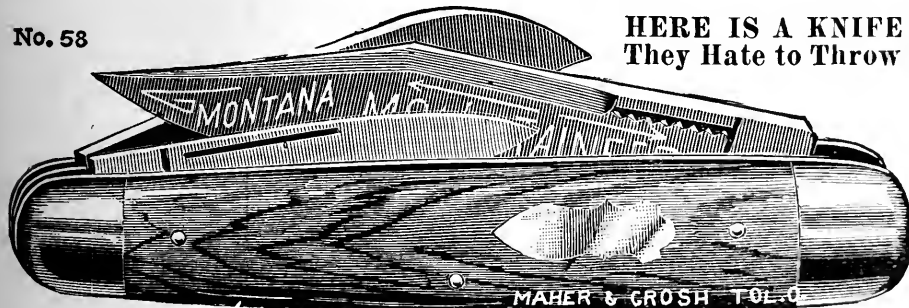

No. 58. Cut is exact size; ebony handle, 3 blades, German silver ends. The long blade is for rough or fine work; the medium blade is as thin as a razor. Price, postpaid, \$1.00. 50,000 in use.

No. 34 we call 'Our Masterpiece'; weighs only 2 ozs.; 3 cutting blades; will cut a quill pen or an ax-handle; price, with ebony handle, postpaid, \$1.25; ivory, \$1.50; choicest pearl, \$2.00.

No. 34

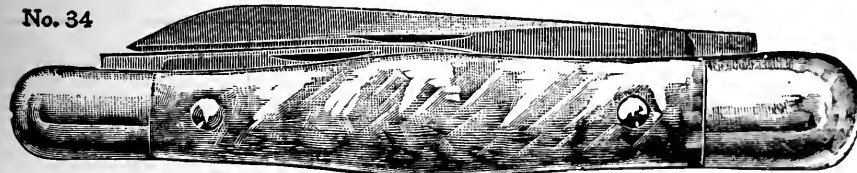

Our Jack Knife sells at 75c.; our special price is 48c., postpaid, 5 for \$2.00. All our blades file tested; warranted; replaced free if soft or flawed. Barbers' hollow ground Razor and Strop to suit, \$1.33. Send for free 80 page list and "How to Use a Razor."

MAHER & GROSH CO.
74 A Street Toledo, Ohio



*"Master thinks I'm a dandy
at mixing cocktails."*

**CLUB
COCKTAILS**

YOU can do it
just as well

Pour over lumps of ice, strain and serve

SEVEN KINDS

BEWARE OF IMITATIONS

G. F. HEUBLEIN @ BRO.

HARTFORD

NEW YORK

LONDON

PERSONAL MAGNETISM

Will power, the art of fascination, call it what you please—it is the intangible force that sways the minds of men. Our new **FREE BOOK** "The Secret of Power" tells how anyone can acquire this marvelous, mysterious force, how to learn to read the secret natures, character, abilities, talents and weaknesses of others, how to determine what vocation you should follow to succeed best, how to cure disease without medicine and develop wonderful physical and mental power.

You can possess a fine physique, a charming personality, the ability to read human nature, and rule the minds of men, so as to achieve marvelous business and social success, and gratify your highest ambitions, if you will but devote a few minutes per day to the study of our wonderful mail course. You need no subjects on which to practise. You can learn in the privacy of your own room without the knowledge of your most intimate friend. You can use what we teach the very first day after you get our course. Write at once for the "Secret of Power." Address,

Columbia Scientific Academy
Dept. 89D- 1931 Broadway, New York

It is all in The Lens

Any old box will answer the purpose if it does not leak light; but you must have a fine lens to make a fine picture.

You can get

**A Royal Anastigmat
Lens, 4 x 5, Series No. 1**

Made by the Rochester Lens Co., Rochester,
New York,

**And listed at \$45,
For 40 yearly subscrip-
tions to RECREATION**

You can get any other lens made by this Company on the basis of one subscription to each dollar of the list price of the lens.

Sample copies of RECREATION for use in soliciting furnished on application.

CUBAN GAME.

The only characteristic animal of Cuba is the hutia, or jutia. It is like a rat in habits and appearance, though much larger. It is 12 to 14 inches long, or with its tail 18 to 20 inches. The body around its middle measures about 18 inches. It weighs as much as 11 pounds. This animal is fond of meat and fruits. The hutia is intelligent, lives in the open country or in the wooded hillsides, and enjoys the latter, as it is able to climb trees. Its ratlike appearance does not make it an inviting food for the Northerner, but the poorer native or the negro is as happy with a hutia as a Southern darkie is with a 'possum. There are no rabbits, nor squirrels. The kildeer, or field plover, is quite common and tame, always running around near the tent or just out of one's path. Quails are much more numerous this year than last. Many a covey have I seen in the morning; the mother playing lame while the young fly or run a few yards and hide. Quail is the favorite bird with Cubans, who are otherwise apparently not at all enthusiastic hunters. Wild guinea fowls are plentiful in the uninhabited hills in some localities, but they are so wild that one never gets within range without great precaution, though their taunting "pot-rack" is continuously heard.

Along the seacoast there are numberless little sand snipe. They fly in flocks so thick that with 5 good shots a man can qualify as a game hog. The cold snaps of a Northern winter are noticed here by an increase in the size of the flocks of canvasback and blue wing teal. Parties go out along the coast in a boat, preferably to tramping the swampy shore, to some lagoon which proves a good feeding ground, and employ the same methods that are used in the United States in decoying ducks. The mud-hen is found in every inland lake or pool and the black diver is an all year frequenter of the Cuban coast.

Courtland Nixon, 1st Lt., 2d Inf., U. S. A.
Sancti Spiritus, Cuba.

"The Stretched
Forefinger
of all Time"
is on
the dial of an

Elgin Watch

—the world's standard
for pocket timepieces.
Perfect in construction;
positive in performance.
Sold by every
jeweler in the land;
fully guaranteed. Illustrated
art booklet free.

ELGIN NATIONAL WATCH CO.

ELGIN, ILLINOIS.

POPULAR SHEET MUSIC BARAINS

POSTAGE
PREPAID

SONGS

Hello Central Give Me Heaven - - - 17 cts.
Down Where the Cotton Blossoms Grow - - 17 cts.
Ain't Dat a Shame, 18 cts. Mister Dooley 17 cts.
My Lady Hottentot, 17 cts. On a Sunday Afternoon, 18 cts.

INSTRUMENTAL

Hunky Dory, Cakewalk - - - 18 cts.
Proposal, Waltzes - - - 17 cts.
Mosquitoes Parade, Two Step - - - 18 cts.
Creole Belles, Two-Step - - - 17 cts.
Ben Hur Chariot Race, March - - - 17 cts.
Eli Green's Cakewalk - - - 17 cts.

ANY 6 FOR \$1.00

We Sell All Kinds of Music for All Instruments at
Lowest Prices in the World. Catalogues Free
THE C. NYREX MUSIC CO.
35 W. 21st St. NEW YORK

OIL--SMELTER--MINES!

DOUGLAS, LACEY & Co.

66 BROADWAY & 17 NEW ST., NEW YORK.

Bankers, Brokers, Fiscal Agents.

Members N. Y. Consolidated Stock Exchange, and
Los Angeles, Cal., Stock Exchange.

**Dividend-Paying Mining, Oil and Smelter
Stocks, Listed and Unlisted our Specialty.**

Booklets giving our successful plan for realizing the large
profits of legitimate Mining, Oil and Smelter Investments,
subscription blanks, full particulars, etc., sent free to any
interested on application.

BRANCHES. Boston, Philadelphia, Chicago, Cleveland, Cin-
cinnati, St. Louis, Baltimore, Washington,
Pittsburg, Buffalo, Prescott, Ariz.; Los Angeles, Cal.; Hart-
ford, Halifax, N. S.; St. John, N. B., Montreal & Toronto.

NERVE

Nerve—that prime essential to the successful living of “the strenuous life”—means not only physical perfection of nerve organization, but also mental self-command and energy. The organic quality of brain and nerves depends upon the nutrition furnished by a healthy circulation. Mentality in its highest development is only possible when a man is not handicapped by physical imperfection.

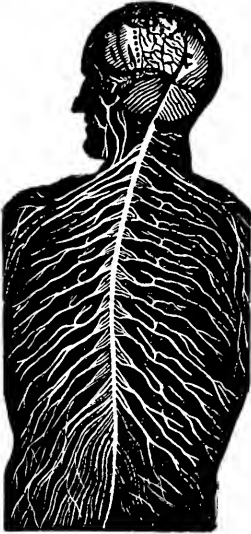

The greatest handicap to men in all walks of life is Varicocele. Varicocele is the disease of stagnant circulation that deprives the most vital nerves of their true nutrition

and impairs their function.

My original discoveries, showing the relation of Pelvic diseases to general nervous and mental disorders, as well as a new method of successful treatment, are fully explained in my treatise “Special Diseases.” This book and my professional opinion of the particular case will be sent to every man who writes me a complete description of his condition.

Nerve, and the life it gives, are of equal importance to the man who earns his living by his day's labor and to the man of affairs. My treatment is within the reach of every man who is sincere in his desire to obtain health.

I hold consultation and give personal attention to private correspondence at Suite E, 119 Michigan Avenue, Chicago.

DELMER D. RICHARDSON, M.D.

FREE BOOK, WEAK MEN



My illustrated nature book on losses, varicocele, impotency, lame back, free, sealed, by mail. Much valuable advice and describes the new **DR. SANDEN HERCULEX ELECTRIC BELT**. Worn nights. No drugs. Currents soothing. Used by women also for rheumatic pains, etc. 5,000 cures 1901. Established 30 years. Advice free.

DR. G. B. SANDEN,
1155 Broadway, N. Y.

Free Rupture Cure

If ruptured write to Dr. W. S. Rice, 1546 Main St., Adams, N. Y., and he will send free a trial of his wonderful method. Whether skeptical or not get this free method and try the remarkable invention that cures without pain, danger, operation or detention from work. Write to-day. Don't wait.



Don't Be Too Fat

Don't ruin your stomach with a lot of useless drugs and patent medicines. Send to Prof. F. J. Kellogg, 1192 W. Main St., Battle Creek, Michigan, for a free trial package of a treatment that will reduce your weight to normal without diet or drugs. The treatment is perfectly safe, natural and scientific. It takes off the big stomach, gives the heart freedom, enables the lungs to expand naturally, and you will feel a hundred times better the first day you try this wonderful home treatment.

50c. **SUPERFLUOUS HAIR REMOVED**
I guarantee that a few drops of my liquid will remove hair instantaneously, effectively, and without the slightest harm, pain, burn or blister. Sent upon receipt of fifty cents with full instructions. **Mme. MARIE LEON,**
905 E St. James Bldg., 1133 Broadway, New York

Your contributors delight in telling their successes, but here is a different story. One year ago last winter I made an extended trip through the South and spent some time in Northern Alabama, where quails are exceedingly plentiful. On one occasion a party of 4 hunted the entire day with 2 fine dogs. We started 11 coveys of quails and bagged one bird. Another time we were hunting at Fruithurst, Alabama, in tall grass, back of the hotel that had been specially recommended as fine rabbit ground. Suddenly I noticed a great commotion in the weeds. Then I saw a white streak with a dog in pursuit. Bang! Dead rabbit! However, a close inspection disclosed the long, lean, still form of the hateful cat. My friend and I just planted him and made no return of our kill. I tell this, not with the intention of boasting, but merely to show what a city sportsman can do when he is given a chance.

J. N. Ore, Chicago, Ill.

HAVE YOU A FRIEND
ANYWHERE IN THE WOODS,
IN THE MOUNTAINS
OR ON THE FARM,
WHO LONGS FOR SOMETHING TO READ
IN THE LONG WINTER EVENINGS, OR IN
THE LONG SUMMER DAYS?
SEND HIM RECREATION.
IT WILL PLEASE HIM A WHOLE YEAR
AND HE WILL RISE UP AND CALL YOU
BLESSED.
AND IT ONLY COSTS YOU \$1.

THE Keeley Cure

**Alcohol,
Opium,
Tobacco
Using ***

Produce each a disease having definite pathology. The disease yields easily to the Treatment as administered at the following Keeley Institutes :

ALWAYS ADDRESS THE INSTITUTE NEAREST TO YOU.

- | | | | |
|---------------------------------------|--|-------------------------------------|---------------------------------|
| Birmingham, Ala. | Des Moines, Ia. | Boulder Hot Springs, Boulder, Mont. | Pittsburgh, Pa., 4246 Fifth Ave |
| Hot Springs, Ark. | Crab Orchard, Ky. | Carson City, Nev. | Providence, R. I. |
| Los Angeles, Cal. | New Orleans, La., 1628-38 Felicity St. | Fargo, N. D. | Columbia, S. C. |
| San Francisco, Cal., 1170 Market St. | Portland, Me. | North Conway, N. H. | Sioux Falls, S. D. |
| West Haven, Conn. | Lexington, Mass. | Buffalo, N. Y. | Dallas, Tex., Bellevue Place. |
| Washington, D. C., 211 N. Capitol St. | Detroit, Mich., 85 Lafayette St. | White Plains, N. Y. | Salt Lake City, Utah. |
| Atlanta, Ga. | Grand Rapids, Mich. | Harrisburg, Pa. | Richmond, Va. |
| Dwight, Ill. | Kansas City, Mo. | Columbus, O. | Seattle, Wash. |
| Charlestown, Ind. | St. Louis, Mo. | Portland, Ore. | Waukesha, Wis. |
| Marion, Ind. | | Philadelphia, Pa., 812 N. Broad St. | Toronto, Ont. |
| | | | Winnipeg, Man. |



LESLIE E. KEELEY, M.D., LL.D.

"Non-Hereditary of Inebriety," by Dr. Leslie E. Keeley, mailed on application.

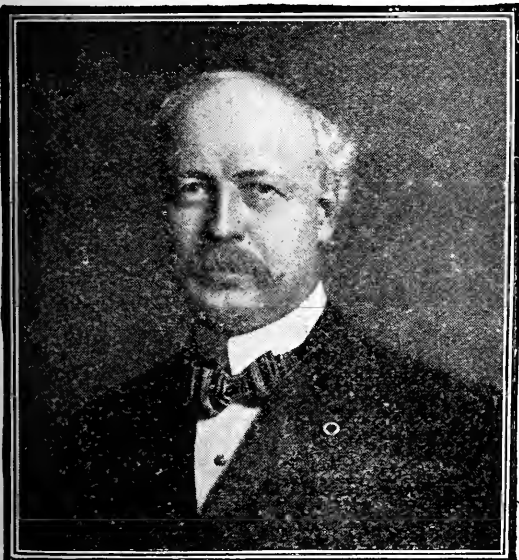

Varicocele Hydrocele

**Cured to Stay Cured in 5 Days.
No Cutting or Pain. Guaranteed
Cure or Money Refunded.**

VARICOCELE. Under my treatment this insidious disease rapidly disappears. Pain ceases almost instantly. The stagnant blood is driven from the dilated veins and all soreness and swelling subsides. Every indication of Varicocele vanishes and in its stead comes the pleasure of perfect health. Many ailments are reflex, originating from other diseases. For instance, innumerable blood and nervous diseases result from poisonous taints in the system. Varicocele and Hydrocele, if neglected will undermine physical strength, depress the mental faculties, derange the nervous system, and ultimately produce complicated results. In treating diseases of men I always cure the effect as well as the cause. I desire that every person afflicted with these or allied diseases write me so I can explain my method of cure, which is safe and permanent.

H. J. TILLOTSON, M. D.
The Master Specialist of Chicago, who Cures Varicocele, Hydrocele, and treats patients personally.
Established 1880.
(COPYRIGHTED)

My consultation will cost you nothing, and my charges for a perfect cure will be reasonable and not more than you will be willing to pay for the benefits conferred.

Certainty of Cure is what you want. I give a legal guaranty to cure or refund your money. What I have done for others I can do for you. I can cure you at home.

Correspondence Confidential. One personal visit at my office is preferred, but if it is impossible for you to call, write me your condition fully, and you will receive in plain envelope a scientific and honest opinion of your case, Free of charge. **My home treatment is successful.** My books and lectures mailed free upon application.

H. J. TILLOTSON, M. D., 140 Tillotson Bldg, 84 Dearborn St., CHICAGO



HER MARVELOUS GROWTH OF HAIR

FREE TO ALL

a trial package of a new and wonderful remedy mailed free to convince people it actually grows hair, stops hair falling out, removes dandruff and quickly restores luxuriant growth to shining scalps, eyebrows and eyelashes. Send your name and address to the Altenheim Medical Dispensary, 7277 Foso Building, Cincinnati, Ohio, for a free trial package, enclosing a 2-cent stamp to cover postage. Write to-day.

Cap'n Titus

By CLAY EMERY

THESE amusing stories of New England country folk center around the personality of a grizzled old mariner, whose yarns have the salty flavor of the seacoast town where he lives.

"A Cape Cod Munchausen."

—*New York Herald.*

"He is another David Harum in story-telling and trading."

—*New York Times.*

Order through your bookman; or we will send direct, postage paid

Price, \$1.00

DOUBLEDAY, PAGE & COMPANY
PUBLISHERS

34 Union Square

New York

The Laughlin Fountain Pen

IS THE PEER OF ALL PENS AND
HAS NO EQUAL ANYWHERE

Sent on Approval
to Responsible People

YOUR CHOICE
OF THESE TWO POP-
ULAR STYLES
FOR ONLY

\$1.00

Post-paid
to
any
address

By Registered Mail 8c
Extra

Superior to the \$3.00
Grades of
Other Makes

Our Extraordi-
nary Offer

Send us one dollar and we will mail either of these two styles. You can try it for a week—if it don't suit you mail it back to us and we will return your dollar. Ever hear or read of any-thing fairer?

The Laughlin Fountain Pen holder is made of finest quality hard rubber, is fitted with highest grade, large size, 14k gold pen of any desired flexibility, and has the only perfect feeding device known. Either style richly gold mounted, for presentation purposes, \$1.00 extra.

Lay this magazine down and write now.



Laughlin Mfg. Co.
424 Griswold St. DETROIT, MICH.

A FREE EDUCATION



THE Board of Directors of the Correspondence Institute of America voted at their last meeting that their **FREE TUITION CONTRACT OFFER** should be **withdrawn February 16, 1903**. This offer has been made for a number of months past, and hundreds of young people have availed themselves of this great opportunity. There is still ample time for your enrollment, if your application is sent in at once. Under our Free Tuition Contract Offer, you are allowed a regular Thirty-Dollar course in any of the subjects we teach, and the expense to you is the mere cost of incidentals—postage, cost of instruction papers, supplies, scholarship, etc.; and these incidentals, under this contract, you are expected to pay during the first four months. Furthermore, under this contract, you can enroll for One Dollar. This cannot be said of other schools.

OUR COURSES FOR HOME STUDY ARE:

Illustrating, Caricature, Ad-Writing, Journalism, Stenography, Proofreading, Bookkeeping, Practical Electricity and Electrical Engineering (which includes Interior Wiring and Lighting, Electric Railways and Telephone and Telegraph Engineering).

Prominent people endorse the work of the Correspondence Institute of America, and we can refer you to any bank or mercantile agency or large merchant, for we want you to know us as we are. The above notice will positively be carried into effect upon the date mentioned. Write to-day, and mention the study which interests you.

CORRESPONDENCE INSTITUTE OF AMERICA

Box 701, Scranton, Pa.

It is greatly to the credit of the sportsmen of South Dakota that the game law, and particularly the section designed to protect prairie chickens, is being rigidly enforced throughout the State. Sportsmen long ago realized that peace officers and the people generally could not be depended on to enforce the game law. They therefore took up the work themselves, with such success that illegal shooting has become as rare and is considered as dishonorable as any other infraction of law.

Pot hunting has about ceased, game is becoming more abundant, and all good citizens are delighted over the improved conditions.

R. F. Patterson, Wentworth, S. D.

I notice an increased number of birds and small animals in this vicinity and all seem less wild than formerly. God bless your work in protecting our furred and feathered friends.

W. O. Isaacson, Cory, Pa.

HAVE YOU Literary Talent?



Learn Journalism and Story-Writing by mail. Send for free booklet, "**Writing for Profit**," tells how to succeed as story-writer, magazine-contributor, and newspaper-correspondent



M.S. criticised and revised; sold on commission, Thornton West, Editor-in-Chief; founded 1895.

THE NATIONAL PRESS ASSOCIATION

The Baldwin, No. 109

Indianapolis, Ind.

The Marble match box and safety ax received O. K. It seems like getting money from home to receive 2 such valuable articles for so little effort. Please accept thanks for the same and best wishes for RECREATION.

W. H. Moore, Philadelphia, Pa.

There are plenty of quails and grouse here. They are but little hunted. Ducks are abundant on the ponds. Our fields are alive with woodchucks. I shot 23 in 6 weeks.

Edward Hamilton, Mohegan, N. Y.

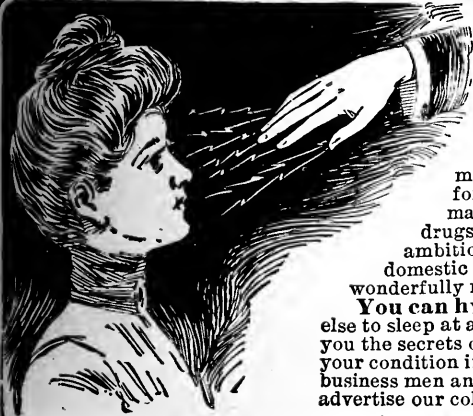

HYPNOTISM

Would you possess that strange mysterious power which charms and fascinates men and women, influence their thoughts, controls their desires and makes you supreme master of every situation? Life is full of alluring possibilities for those who master the secrets of hypnotic influence; for those who develop their magnetic powers. You can learn at home, cure diseases and bad habits without drugs, win the friendship and love of others, **increase your income**, gratify your ambitions, drive worry and trouble from your mind, improve your memory, overcome domestic difficulties, give the most thrilling entertainment ever witnessed and develop a wonderfully magnetic will power that will enable you to overcome all obstacles to your success. **You can hypnotize people instantaneously**,—quick as a flash,—put yourself or anyone else to sleep at any hour of the day or night—banish pain and suffering. **Our free book** tells you the secrets of this wonderful science. It explains exactly how you can use this power to better your condition in life. It is enthusiastically endorsed by ministers of the gospel, lawyers, doctors, business men and society women. It benefits everybody. It costs nothing. We give it away to advertise our college. Write for it to-day.

American College of Sciences, Dept. C N 4. 420 Walnut Street, Philadelphia, Penn.

SOME RARE OPPORTUNITIES

These goods are all new, and will be shipped direct from factory. Prices named are those at which manufacturers and dealers usually sell. Here is a good chance to get

A Book, a Gun, a Camera
A Sleeping Bag, a Fishing Rod
A Reel, a Tent, } FREE OF COST

Subscriptions need not all be sent at once. They may be sent in installments as taken and credit will be given on account. When the required number is obtained the premium earned will be shipped.

These Offers are subject to change without notice.

TO ANY PERSON SENDING ME

TWO yearly subscriptions to RECREATION at \$1 each, I will send a copy of *Hunting in the Great West*, cloth; or a Zar Camera, listed at \$1; or an Ingersoll Watch or Cyclometer, listed at \$1; or a Recreation Waterproof Match Box, made by W. L. Marble and listed at \$1; or a Shakespeare Revolution Bait listed at 75 cents; or a Laughlin Fountain Pen; or a dozen Trout Flies, assorted, listed at \$1; or a pair of Attachable Eyeglass Temples, gold-plated, made by Gall & Lembke; or a Gold Medal Folding Camp Cot.

THREE subscriptions at \$1 each, a safety pocket ax, made by W. L. Marble and listed at \$2.50; or a dozen Bass Flies, assorted, listed at \$2; or 4 dozen Carbutt plates, 4x5 or 5x7; or a pair of chrome tanned horsehide hunting and driving gloves, listed at \$1.50, made by J. P. Luther Glove Co.

FOUR subscriptions at \$1 each, an Ideal Hunting Knife, made by W. L. Marble and listed at \$2.50; or a .32 caliber Automatic Forehand Revolver, made by the Hopkins & Allen Arms Co.; or a No. 822 Rifle made by the Hopkins & Allen Arms Co., listed at \$4.50.

FIVE subscriptions at \$1 each, a copy of *Cruisings in the Cascades*, cloth; or a set of Nehring's Convertible Ampliscopes, listed at \$5.00; or an Ideal Hunting Knife made by W. L. Marble, and listed at \$3; or a polished Buffalo Horn Gun Rack, made by E. W. Stiles; or a Conley Combination Hunting Coat; or a Forehand Gun, made by the Hopkins & Allen Arms Co., listed at \$6; or a pair of lock lever skates, made by Barney & Berry, listed at \$4.50; or a pair of gauntlets, for hunting and driving, ladies' size, listed at \$2.50, made by J. P. Luther Glove Co., or a J C Hand trap made by the Mitchell Mfg. Co., listed at \$4.

SIX subscriptions at \$1 each, a Hawkeye Refrigerating Basket made by the Burlington Basket Co., or one dozen Eureka golf balls listed at \$4; or a Century Camera, model 10, 4x5, listed at \$9; or a Forehand Gun made by the Hopkins & Allen Arms Co., listed at \$9.

SEVEN subscriptions at \$1 each, a copy of *The Big Game of North America*, or of *The American Book of the Dog*, cloth, or one set Lakewood golf clubs, 5 in number, listing at \$5; or a series 11B or 11D Korona Camera, made by the Gundlach Optical Co., listed at \$10.

EIGHT subscriptions at \$1 each, a 4x5 Weno Hawk-Eye Camera, made by the Blair Camera Co., and listed at \$8.

NINE subscriptions at \$1 each, an Acme single shot gun, made by the Davenport Arms Co., and listed at \$8.

TEN subscriptions at \$1 each, a Cut-Glass Salad Bowl, made by Higgins & Seiter, and listed at \$4.50; or a Yawman & Erbe Automatic Reel, listed at \$6 to \$9; or a Bristol Steel Fishing Rod, listed at \$6, or less; or a Waterproof Wall Tent 7x7, made by Abercrombie & Fitch, and listed at \$8; or a canvas hunting coat, made by H. J. Upthegrove & Son, listed at \$8; or a series 1, 4x5, Korona Camera, made by the Gundlach Optical Co., listed at \$12.

TWELVE subscriptions at \$1 each, a Peabody Carbine valued at \$12; or a No. 5 Sidle Telescope Rifle Sight, listed at \$18; or a Davenport Ejector Gun, listed at \$10; or a Century Camera, model 12, 4x5, listed at \$18.

FIFTEEN subscriptions at \$1 each, a Shakespeare Reel, Silver Plated, listed at \$15; or a set of rabbit plates made by Higgins & Seiter, and listed at \$8, or a pair of horsehide Hunting shoes, made by T. H. Guthrie, Newark, N. J., and listed at \$8, or a Field Glass made by Gall & Lembke; or a Kenwood Sleeping Bag, complete, with canvas cover, listed at \$16.

TWENTY subscriptions at \$1 each, a 14-karat Gold Hunting-case Watch, with Waltham Movement, listed at \$20; or a Repeating Rifle, listed at \$16 or less; or an Elita single shot gun, made by the Davenport Arms Co., and listed at \$18, or a pair of horsehide Hunting Boots, made by T. H. Guthrie, Newark, N. J., and listed at \$10; or an Acme Folding Canvas Boat, No. 1, Grade B, listed at \$20; or a Mullins Duck Boat, listed at \$20.

TWENTY-FIVE subscriptions at \$1 each, an 11-foot King Folding Canvas Boat, listed at \$38; or a Repeating Rifle, listed at \$20 or less; or a 4x5 Planatic lens, made by the Rochester Lens Co., and listed at \$25; or a Century Grand Camera, 4x5, listed at \$35; or a Syracuse Grade O, double hammerless Gun, made by the Syracuse Arms Co., and listed at \$30.

THIRTY subscriptions at \$1 each, a Repeating Rifle, listed at \$25 or less; or a Waterproof Tent, 14½ x 17, made by Abercrombie & Fitch, and listed at \$25; or a corduroy hunting suit, made by H. J. Upthegrove & Son, including coat, vest, trousers, and hat, listed at \$23.75; or an Ithaca, quality No. 1, plain, double barrel, hammerless breech loading shot gun, listed at \$40.

THIRTY-FIVE subscriptions at \$1 each, a 14-foot King Folding Canvas boat, listed at \$48.

FORTY subscriptions at \$1 each, a Savage .303 Repeating Rifle; or a No. 10 Gun Cabinet, made by the West End Furniture Co., and listed at \$32; or a Field Glass, made by C. P. Goerz.

FORTY-FIVE subscriptions at \$1 each, a Royal Anastigmat Lens, 4x5, series I, made by Rochester Lens Co., and listed at \$45.

FIFTY subscriptions at \$1 each, a No. 20 Gun Cabinet, made by the West End Furniture Co., and listed at \$38.

TWO HUNDRED subscriptions at \$1 each, a strictly first class upright piano, listed at \$750.

Address, **Recreation** 23 West 24th St.
New York



"The Whisky of his forefathers"

John Dewar & Sons, Limited

PERTH, SCOTLAND
LONDON, ENGLAND



Scotch Whisky Distillers

*By Royal Warrant to His Majesty
King Edward VII. and the Royal
Family.*

FREDERICK GLASSUP

*Sole Agent for the U. S.
New York*

SLAUGHTER OF BUFFALO.

Of the countless thousands of buffalo beneath whose hoofs the plains once trembled only a few score remain. Of these almost all are in captivity. A pitiful remnant still hide in the hills, and would be slain by any hunter who could get a shot; this to the shame of the hunter.

Last month at Helena, Montana, a dozen of these noble creatures were butchered so epicures might taste the meat. The act of butchery was a wanton and indecent cruelty, and the demand for the meat the evidence of gross perversion. The meat of the buffalo is fairly good to a hungry man, but not to be compared with beef, being coarse and tough. If buffalo were plentiful and cheap it would be on the tables of the poor, while the rich would scorn it. The fact that a market can be found for it is due to the same spirit of savagery that sacrifices a song bird for soup, or for purposes of ornamentation strips the heron of its mating-time aigrette.

Whether the epicures enjoyed their feast has not been related. The hope may be expressed that they did not, but acquired an indigestion that caused a buffalo with glaring, terrified eyes and a dripping throat to trample their stomachs the livelong night. As for the butchers who dragged the buffalo to the shambles, the only regrets are that they made money by the bloody speculation, and failed of having been horned and noosed by their victims.—
San Francisco paper.

HIGGINS & SEITER

Our Illustrated Catalogue with over 1000 illustrations, many in exact color and shape, or our interesting booklet "Serving a Dinner," by "Oscar" of the Waldorf-Astoria, either one or both, will be mailed on request. Ask for Catalogue 13 (U).

West 21st Street
West 22d Street
Near 6th Ave.
New York

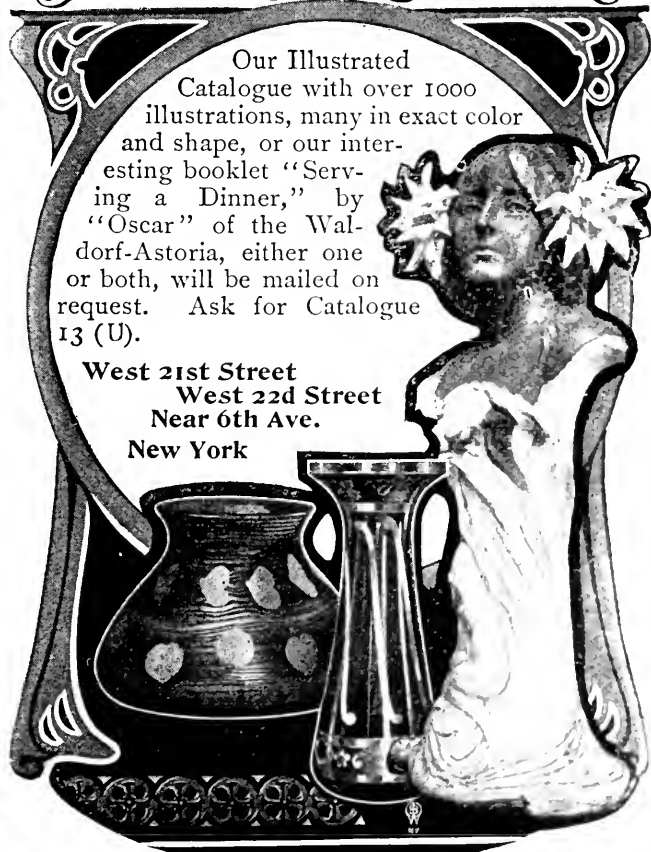

"BUY CHINA AND GLASS RIGHT"

P. O. Address,

Flagstaff, Ariz.

The Edward Smith Indian Post Trading Co.

of Arizona Territory



Moki Indian Snake Dancers

ATTENTION SPORTSMEN

Do you know
that no Christ-
mas or Holiday
Gift can equal
a fine

**NAVAJO
INDIAN
BLANKET
or RUG?**

No ideal Ameri-
can home or den
is complete with-
out these. Bear
in mind that we
own our trading

posts, and are in a position to serve you to
your advantage with almost cost prices
on everything.

INDIAN CURIOS and RELICS

Address all communications
to the company at

DETROIT, MICH.

Offices, BUHL BLOCK

Write for Circulars and Price Lists.

Do you want a Good, Reliable
Substantial, Well Made

Single Barrel Shot Gun

If so, send me

10 YEARLY SUBSCRIPTIONS

and I will send you such a
Gun as a premium

It is made by the *DAVENPORT ARMS
CO.*, and this means it is made of good
material and that only good workmanship
is put on it.

This is one of the many remarkable op-
portunities *RECREATION* is offering to
men and boys to fit themselves out com-
pletely for shooting and fishing.

Sample Copies for Use in Canvassing
Furnished on Application.

Address

RECREATION

23 W. 24th St., New York City

I have taken *RECREATION* ever since you
started it, with the exception of the first
2 or 3 numbers. It is worth more than
all of the other sportsmen's papers to-
gether. You show up the game hogs in
great shape.

H. C. Murphy, Middlefield, N. Y.

Just received my copy of May *RECRE-
ATION* and think the magazine is justly en-
titled to the name. It certainly is a pleas-
ure to enjoy through it a visit with the
sportsmen in different parts of the country.

H. A. Miller, El Dorado, Kan.

I received the Harrington & Richardson
shot gun and do not see how you can af-
ford to give such a gun as premium for a
few subscribers.

R. D. Prince, Leon, N. Y.

We all think *RECREATION* is the only
sportsmen's journal. My 2 boys are wild
over it every time it comes.

F. H. Churchill, Marseilles, Ill.

HAVE YOU A FRIEND
ANYWHERE IN THE WOODS,
IN THE MOUNTAINS
OR ON THE FARM,

WHO LONGS FOR SOMETHING TO READ
IN THE LONG WINTER EVENINGS, OR IN
THE LONG SUMMER DAYS?

SEND HIM *RECREATION*.
IT WILL PLEASE HIM A WHOLE YEAR
AND HE WILL RISE UP AND CALL YOU
BLESSED.

AND IT ONLY COSTS YOU \$1.

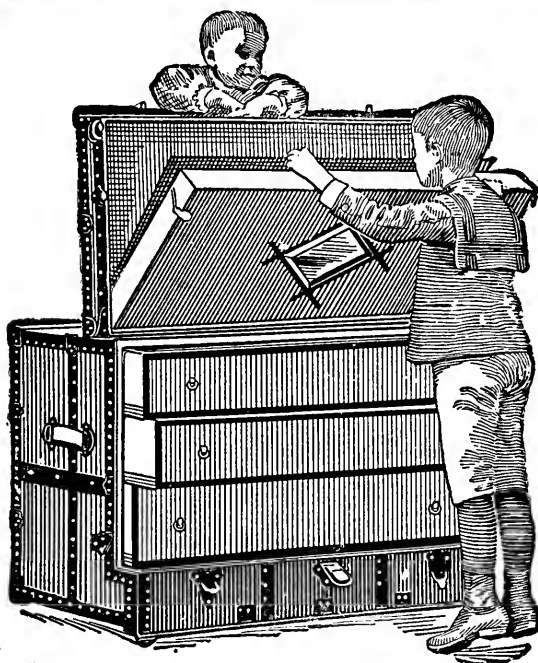

Stallman's Dresser Trunk

Have you seen one? It is
up-to-date. Think of it
everything within reach. No
heavy trays, but light, smooth
drawers. Holds as much and costs
no more than a good box trunk.
Hand riveted, almost indestructible.
Once tried, always recommended.
Sent C. O. D., privilege examination.

2c. stamp for catalogue. Mention *RECREATION*.

F. A. STALLMAN,

87 W. Spring St.,

Columbus, O.

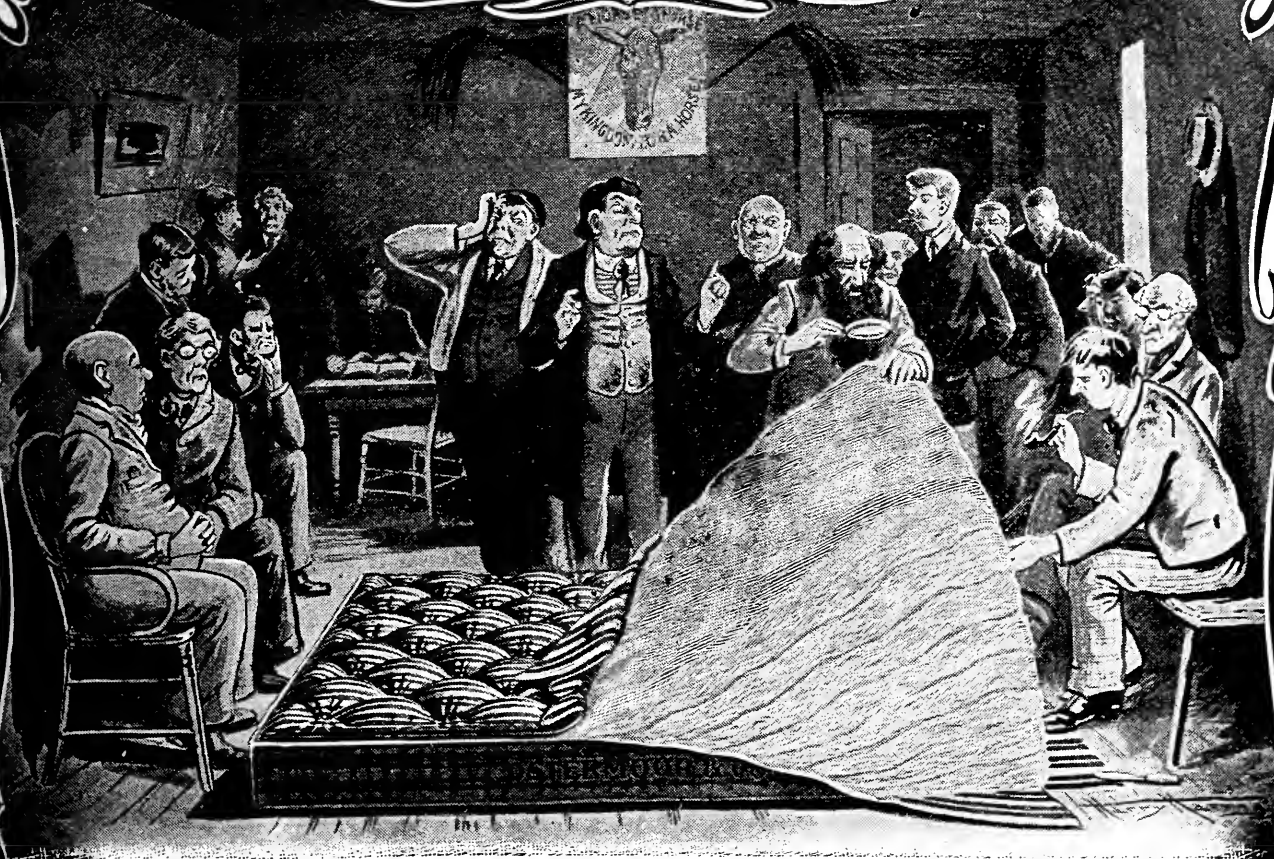
\$1,000 REWARD

Resolution passed at a recent meeting of the American Hair Mattress Renovators :

Whereas, a large and steadily increasing number of our patrons are discarding Hair Mattresses in favor of the Ostermoor Patent Elastic Felt Mattress, in spite of our combined efforts against them, therefore, be it

Resolved, that a reward of one thousand dollars (\$1,000.00) be paid by this society to any member finding an argument that will discourage their popularity and prevent their continued sale.

The Ostermoor Patent Elastic Felt Mattress, \$15. Express Charges Prepaid Anywhere

(Smaller sizes at smaller prices)

consists of airy, interlacing, fibrous sheets of snowy whiteness and great elasticity; closed in the tick by hand—constructed, not stuffed. Softer than hair—never mats or packs as hair does—and never needs remaking and is absolutely vermin-proof. In all respects practically un-wear-out-able, retaining its shape and elasticity under all sorts of conditions and hard usage.

SLEEP ON IT THIRTY NIGHTS and if it is not even all you have *hoped for*, if you don't believe it to be the equal in cleanliness, durability and comfort of any \$50 hair mattress ever made, you can get your money back by return mail.

Send For Our Handsome Book, "The Test of Time."

which costs us 25 cents but *costs you nothing* but the trouble to send for it. We don't ask you to buy, but we want you to *know*. You will be surprised at the beauty of this 80-page book.

REMEMBER:—Ostermoor Mattresses are not for sale by stores. Must be bought direct of us. Our name and guarantee on every mattress. Write us to-day without fail.

OSTERMOOR & CO., 114 Elizabeth Street, New York

We have cushioned 25,000 churches. Send for our book "Church Cushions."

Date, _____ 190

G. O. SHIELDS,

Editor and Manager of RECREATION, 23 West 24th St., New York.
Herewith find \$1.00 for which please send me RECREATION one year
beginning with _____ number.

Name, _____

Remit by P. O. or Express Money Order, or New York Draft.

DETACH THIS, FILL OUT, AND SEND IN.

AT DOCTORS H. R. PHILLIPS & WREAN'S RABBITRY, Penn Yan, N. Y., we breed for FOUNDATION STOCK

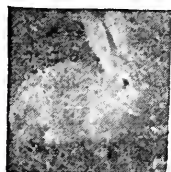

only, from the best strains of PEDIGREED STOCK-DOES, 6 to 10 months old, bred to IMPORTED BUCKS, for \$3 each. Fine

color and strictly O.K. We guarantee all stock as recommended. We have a fine line of BLACK PEDIGREED BELGIANS.

Mention RECREATION.

DRS. H. R. PHILLIPS & WREAN.

BELGIAN HARES
Healthy Red, Pedigreed.

For pets, fancy, food, or stocking preserves. In any quantity. Price \$1.00-\$2.00

F. M. PARK, M. D.,
Stoneham, Mass.

For Sale:—Bear Rugs: Fine furred, well made, 4 brown or cinnamon, \$30, \$40, \$50, and \$60. 1 large black, \$75. Elk head, 50 in., \$75. Mountain sheep (whole,) \$100. E. A. L. Box L. Laramie, Wyo.

Wanted: Union Hill, Schuetzen, or Schuetzen Jr., Ballard Rifle with worn out barrel. Give full description including weight, caliber and price. Louis Ervin, Bear Creek, Miss.

Puppy, By Jingo's Pearl Ex Hal's: Glory—Hal Pointer; white, liver and ticked; no better; write for prices and pedigree. E. E. Hiatt, Fairmount, Ind.

For Sale: Cummins Rifle Telescope, 24 inch. A fine Glass, costs \$12, price \$10, or exchange for a good rifle. Chas. W. Castle, Morris, Conn.

For Exchange: A very fine Hyde Violin, cost \$60. Want rifle, shot gun, or both. L. M. Gage, Bristol, Vt.

APPLICATION FOR MEMBERSHIP IN THE L. A. S.

ARTHUR F. RICE, Secretary L. A. S., 23 W. 24th St., New York.

DEAR SIR: Enclosed \$1 for membership fee for one year.

I certify that I am eligible to membership in the L. A. S. under the provisions of the constitution, and refer to 2 League members (or to 3 other reputable citizens) named hereon.

Name _____

Street or P. O. Box _____

City or Town _____

References

Detach this, fill out and send in.

"HOPKINS & ALLEN" Single Barrel Shot Guns

(Made for any powder and good with any shot.)

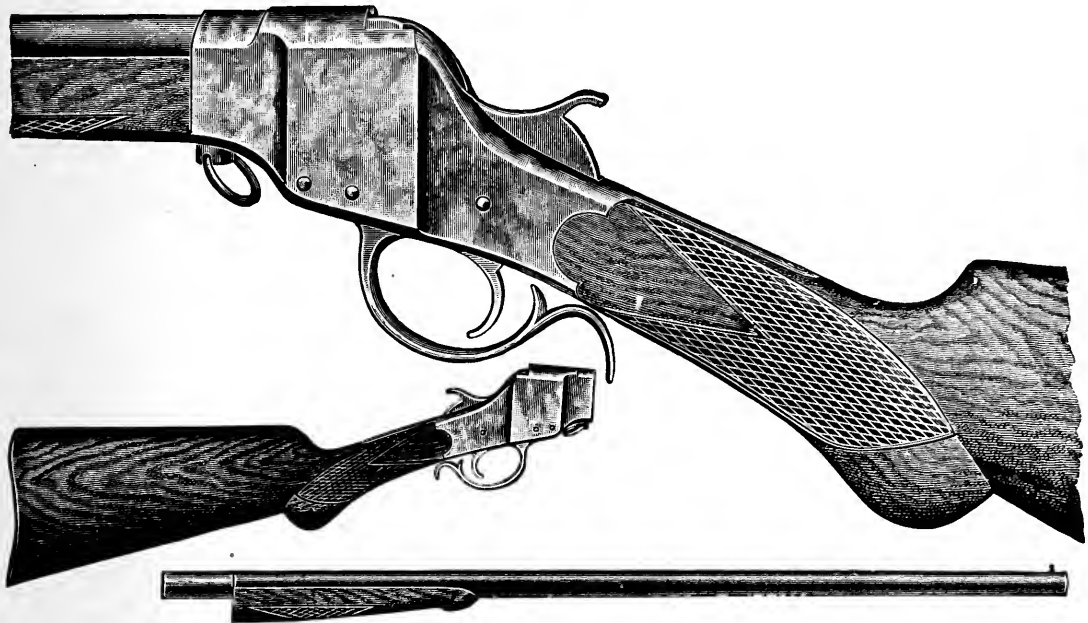

Our "Lever Action" has more friends than any single gun made, has stood the test of fifteen years' continued approval. Simple, durable and reliable.
12 and 16 gauge blued steel barrel..... \$8.00



Our new model top snap action, combining all up-to-date features of a modern gun, including patent compensating snap fore end. Automatic shell ejector, **Full Choke Bored**. 12, 16 and 20 gauge decarbonized steel barrel..... \$9.00
12 and 16 gauge Stubbs twist steel barrel.....\$10.00

We will ship, all charges prepaid, on receipt of remittance with order, to any express office in U. S. A.

The Hopkins & Allen Arms Co.,
NORWICH, CONN., U. S. A.

STILL ANOTHER GREAT OFFER

Send me 25 yearly subscriptions to
RECREATION and I will send you

A Grade O Syracuse Gun

Listed at \$30.

I have contracted for 20 of these
guns at a price which enables me to
offer them as above, and they will
doubtless all be taken within the next
three months.

If you want one of the Guns get a move on you

Sample copies of RECREATION for
use in canvassing furnished on application

RECREATION, 23 W. 24th Street, New York

HALF A CENTURY

Of practical experience is manifest in the SUPERIOR CONSTRUCTION and FINE SHOOTING QUALITIES of the

DAVENPORT GUNS

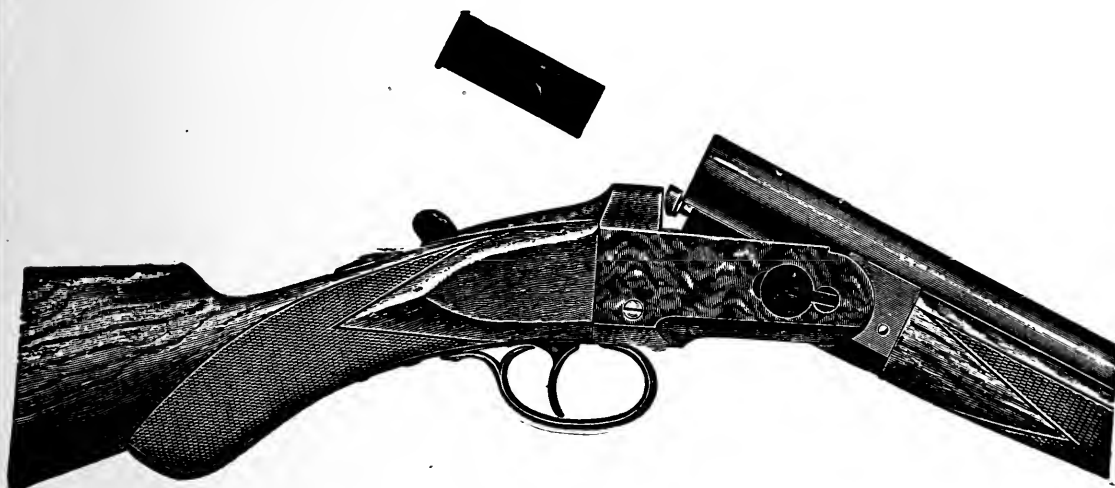

HAMMERLESS GUNS furnished in 12, 16, and 20 gauge, 28, 30 and 32 inch barrels,
HAMMER GUNS furnished in 8, 10, 12, 16 and 20
gauge, 28, 30, 32, 34 and 36 inch barrels.

SAFE, RELIABLE, DURABLE, ACCURATE AND SYMMETRICAL. Can any Sportsman wish for more?

They possess **FEATURES** as well as **QUALIFICATIONS** all their own.

Your attention is invited to our complete line of up-to-date arms, illustrated and described in our catalogue, which will be sent free upon application.

Your correspondence is solicited relative to our arms, the proper loading and use of same; we would be pleased to give you the benefit of our extensive experience in such matters. We can suggest something to your advantage and to our mutual benefit. We are at your service.

THE W. H. DAVENPORT FIRE ARMS CO.,
NORWICH, CONN.

GOING DUCK SHOOTING?

IF SO, YOU SHOULD HAVE A

Conley Combination Hunting Coat and Vest

MADE OF ENGLISH KHAKI

You can use it for

A LONG RAIN COAT

A SHORT HUNTING COAT

A DUCK BLIND

OR A SLEEPING BAG

Game pockets and cartridge holders *ad lib.*

Save yourself from dampness and cold.

Send me

5 Yearly Subscriptions to RECREATION

Name your size and I will send you one of these coats.

Sample copies of RECREATION, for use in canvassing, furnished on application.

One of the 9

Built for Business

“A” GRADE \$80 LIST

In offering this gun to the public, we have combined

ALL OF THE DISTINCTIVE IMPROVEMENTS

which have gained for the “Syracuse” its present prominent position among American Arms.

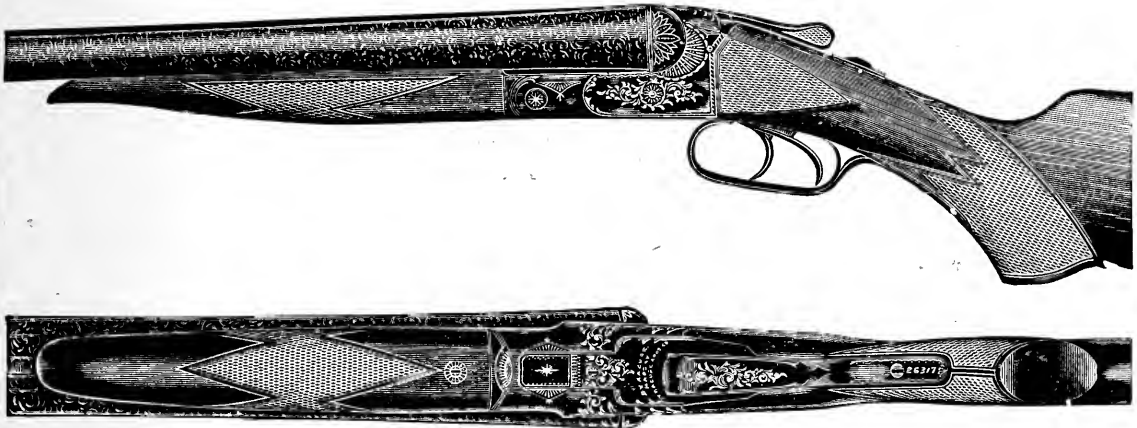

“A” GRADE

Condensed Description

BARRELS—Fine quality of Damascus Steel, or if desired, we will furnish Krupp Fluid Pressed Steel Barrels, made at the Krupp Works, Essen, Germany, and imported to our order.

STOCK—Imported Italian Walnut, finely figured and dark rich color. Full Pistol or Straight Grip as desired.

AUTOMATIC EJECTOR—With our Patented Non-Ejector device which allows the gun to be instantly changed from an Automatic to a Non-Automatic Ejector.

This model gun is handsomely engraved and cleanly finished, and will compare favorably with any gun on the market listing at \$100.00.

All “Syracuse” guns for 1903 will be built with our New Compensating Double Cross Bolt; and Frames Inletted into Stock, thus preventing the spreading or splitting of same.

Art Catalogue yours for the asking. Mention “Recreation.”

SYRACUSE ARMS CO. SYRACUSE, N.Y.

FINE GUNS

OUR SPECIALTY

SCOTT'S MONTE CARLO

Automatic Ejector Hammerless,

Established
1826

All the Prominent
English and
American Makes.

Also Westley Richards,
Greener, Purdy, Lang, Parker,
L. C. Smith, J. P. Clabrough
& Johnstone, Ithaca, Batimore
Arms Co., Forehand, etc.

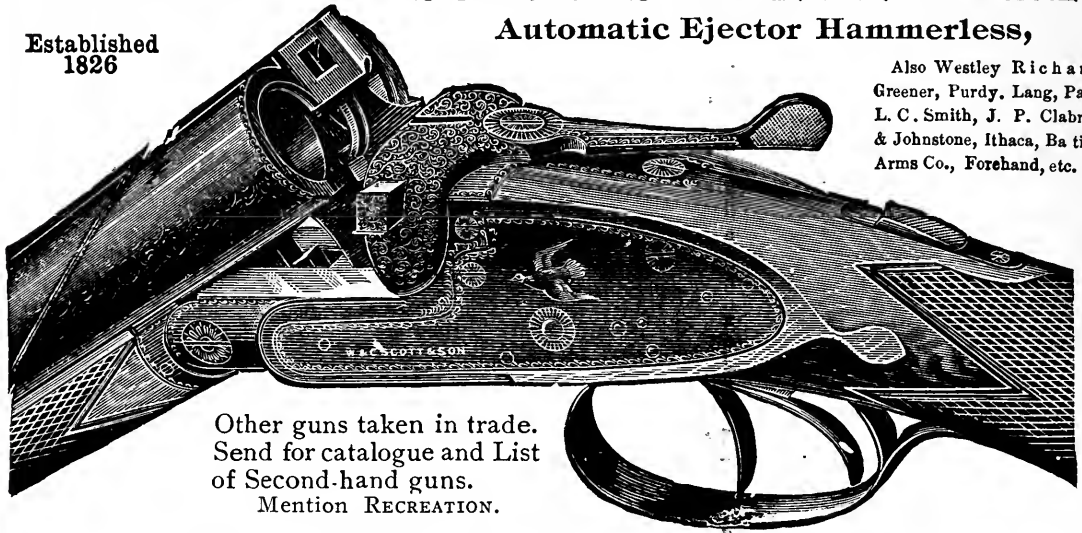

Other guns taken in trade.
Send for catalogue and List
of Second-hand guns.
Mention RECREATION.

SWEDISH LEATHER JACKETS

For Duck Shooting.

Soft as Kid.

Finest Quality, \$18.00

We take the entire product of the manufacturers of above Finest Jackets and this make cannot be obtained elsewhere in the United States

Gun Repairing

BY FIRST-CLASS GUN REPAIRERS
RESTOCKING, BROWNING, Etc., Etc.

Send for Catalogues

WM. READ & SONS,

107 Washington Street, BOSTON, MASS.

The Old Gun House. Established 1826

I returned May 1 from the Clearwater country, where I spent 30 days, having gone in by snowshoe route. I found game exceedingly plentiful. I wish the Nez Perce Indians could be kept from going in that country out of season. I think it could be done by notifying the supervisor of forestry at Salmon City, Idaho. I saw where the Indians camped last August. They must have killed a large number of elk, mostly cows.

Geo. W. Solleder, Darby, Mont.

The Sidle telescope sight which I received for 12 subscribers to RECREATION is something I prize highly and take pleasure in showing to my friends. I am using it on a 32-40 Winchester, and at my first trial I put 5 shots in a 2 inch circle at 110 yards. Your magazine is all any sportsman could ask.

E. H. Hunt, East Downington, Pa.

RECREATION is still all right. I have never missed a number since you first started. You do better each year. Success to you.

H. C. Baldrige, Albuquerque, N. M.



PERFECTION AT LAST!

To the "OLD RELIABLE"

has fallen the honor of making the FIRST and ONLY PERFECT score which has ever been made in : n all day tournament.

At Spirit Lake, Ia., Aug. 6th, 1902

Events 15 15 20 15 15 20 15 15 20 15 15 20—200

Score 15 15 20 15 15 20 15 15 20 15 15 20—200

The above score was made by

MR. FRED GILBERT WITH A PARKER GUN

Send for Catalogue

PARKER BROS., Meriden, Conn.

NEW YORK SALESROOM: No. 32 WARREN ST.

Mention RECREATION.



Write Now for My Book

You who need help and are waiting—
 You who are sick, and are hesitating—
 You who have prejudice—you who doubt—
 Let me convince you—write a postal to-day.

Then I will do this:

I will mail you a book, and an order on your druggist for six bottles of Dr. Shoop's Restorative. You may take it a month at my risk to learn what it can do. If it succeeds the cost is \$5.50. If it fails, I will pay your druggist myself. And I'll leave the decision to you.

You see this offer everywhere—all the time—year after year. Don't you realize that thousands every week are accepting it, and thousands are getting well?

In the past 12 years I have furnished my Restorative to over half a million sick ones on just those terms. My record shows that 39 out of each 40 have paid for the treatment gladly, because they were cured. I have paid for the rest.

I know what this remedy will do, and my faith in it is shown by my offer. I want you, to know it—you who need its help.

Just write me your name and your address, and I will do all the rest.

Why I Succeed

I have learned by a lifetime of labor how to strengthen the *inside* nerves.

My Restorative will always bring back that power which makes the vital organs act, and there is no other way to do it.

A weak organ shows weak nerve power, just as a weak engine indicates too little steam. All the skill in the world can never cure that weakness till the organ's nerves get strong enough to make it do its duty. That is why common treatments fail.

I know from a vast experience that in these chronic diseases my Restorative will accomplish all that medicine can do. And in most deep-seated cases there is absolutely no other way to a cure.

My book will tell you why.

Simply state which book you want, and address	Book No. 1 on Dyspepsia. Book No. 2 on the Heart. Book No. 3 on the Kidneys. Book No. 4 for Women. Book No. 5 for Men (sealed). Book No. 6 on Rheumatism.
---	--

Dr. Shoop, Box 214,
 Racine, Wis.

Mild cases, not chronic, are often cured by one or two bottles. At all druggists.



FAIRBANK'S GLYCERINE TAR SOAP

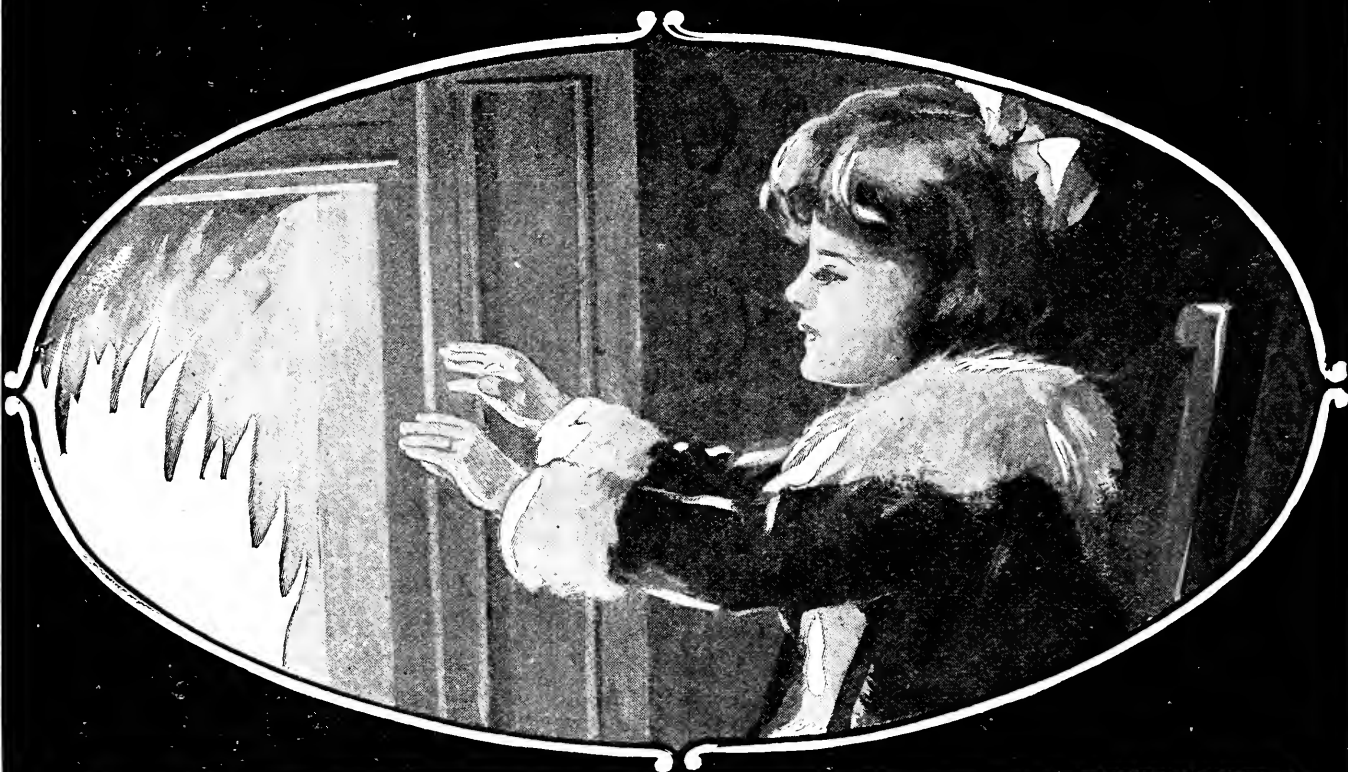

Chapped Hands

are the bane of the little tot's existence—and sometimes of older folks. Wintry winds raise havoc with tender skins.

FAIRBANK'S GLYCERINE TAR SOAP first cleanses the skin of all impurities, then heals, soothes and keeps it soft and velvety.

It makes a rich creamy lather and has pronounced antiseptic qualities. Removes grease and dirt like magic, and lathers in hard or soft, hot or cold water. Each cake is wrapped and packed in separate carton.

Ask for FAIRBANK'S GLYCERINE TAR SOAP at your drug or grocery store. If you fail to find it, send us name and address for free sample. It has an odor

Don't judge
of the quality
by the price—

5¢

“Like a Breath from the Pines”

THE N. K. FAIRBANK COMPANY, Department O, CHICAGO.

U.M.C.

shot shells and cartridges have 30 years of successful history behind them.

If you are planning a Southern hunting trip for quail or ducks or wish to take an occasional day's outing with the gun near home—in-
sist on buying ammunition of **V. M. C.** manufac-
ture. You will find it remarkably satisfactory.

The Union Metallic Cartridge Co.
BRIDGEPORT, CONN.
313 Broadway, New York, N. Y.

A Remington Hammerless Gun

FOR \$25.00 GUARANTEED FOR
NITRO POWDERS.

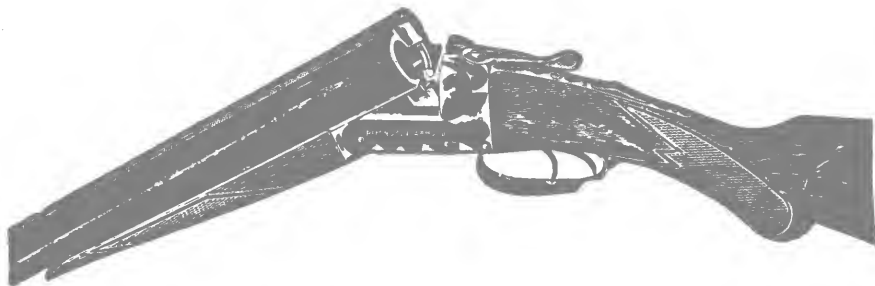

Grade K. Made with Remington blued steel barrels. \$25.00
Grade K E D. Made with Damascus barrels and Automatic Ejector, . . . 35.00

Send for handsome new Catalogue just issued, containing complete description of Guns, \$25.00 to \$750.00. Mailed free.

REMINGTON ARMS COMPANY
ILION, N. Y.

313-317 Broadway, New York. 86-88 First St., San Francisco, Cal.
Sold by All Gun Dealers. Not Retailed by the Manufacturers.

New York to Buffalo, via New York Central—Finest One-Day Railroad Ride in the World.

A New World's Record Made With

WINCHESTER

Greaseless Bullet Cartridges

THE severest kind of a test of the accuracy, cleanliness and general desirability of Winchester .22 Caliber Smokeless Powder Cartridges loaded with Winchester Greaseless Bullets was made in San Antonio, Texas, September 20th, by Adolph Toepperwein. Mr. Toepperwein, who held the World's Record for shooting flying targets with a rifle, having made a score of 979 hits, out of 1,000 shots, undertook to better this record. He succeeded, making the remarkable score of 986 hits out of 1,000 shots, the targets being 2½ inch clay discs thrown into the air by an assistant. In performing this feat, Mr. Toepperwein used two Winchester Model 1890 Repeating Rifles and .22 Caliber Cartridges of Winchester make loaded with Smokeless Powder and Winchester Greaseless Bullets. He shot 100 preliminary shots and 1,000 for the record without cleaning or cooling his guns, and at the conclusion of the test they were practically as clean as after firing the initial shots. Mr. Toepperwein attributes his success in improving his previous record to the fact that the new Winchester make of Greaseless Bullet Cartridges are so much cleaner than the lubricated bullet cartridges, which he used before.

.22 SHORT, .22 LONG AND. 22 W. R. F.

For Sale by All Dealers.

Feed Right
 Feel Right
 Think Right

PRETTY NEAR THE SAME

when it comes to writing them, aren't they? They are the same, in fact, for just so surely as you FEED RIGHT you will FEEL RIGHT and can THINK RIGHT.

Cut out the pasty, starchy or greasy foods for a few days and take on **GRAPE-NUTS**. In this famous food scientific processes have changed the starch to Grape-Sugar, and the tasty, nut-like little granules go into your spoon with the first period of digestion complete, just like nature does it, but with the brain-building elements still there.

That's why it is

THE FOOD FOR THOUGHT.

POSTUM CEREAL CO.. LTD., Batlle Creek, Mich.

Try them All



You'll go back to using

Naylor's

Best for PURITY, STRENGTH,
 QUALITY AND FLAVOR

SOLD BY ALL UP TO DATE GROCERS.

If not handled by yours send us his name
 and we will send free sample

Naylor's NEW YORK.

VOSE

PIANOS

have been established over 50 YEARS. By our system of payments every family in moderate circumstances can own a VOSE piano. We take old instruments in exchange and deliver the new piano in your home free of expense. Write for catalogue D and explanations.

VOSE & SONS PIANO CO., 160 Boylston St., Boston, MA

RECREATION

OFFICIAL ORGAN OF THE LEAGUE OF AMERICAN SPORTSMEN



AMATEUR PHOTO BY W. B. MURK.
 NEVER TOUCHED ME.
 Winner of 7th Prize in RECREATION'S 7th Annual Photo Competition.

PUBLISHED BY G. O. SHIELDS (COQUINA)
 23 WEST 24TH ST., NEW YORK

FIFTEEN PRIZE WINNING PHOTOGRAPHS REPRODUCED
 IN THIS ISSUE.

"The World is Good Enough"

SPECIALTY OF WINES AND SPIRITS

Buy where you can get the **BEST** and the **MOST** for your money!

The efforts of three generations of one family have been applied to the establishment and upbuilding of our business, which has been successfully conducted for fifty-two years. As a result of these efforts during the past twenty years our sales have increased more than a thousand per cent, good evidence of appreciation by our patrons.

Full measure, fair prices, excellent quality, complete satisfaction guaranteed to each patron every time and all the time is the foundation upon which we have built; is the reason, not the secret, of our success, which is as sure and secure as the operation of any law of nature.

On the basis of such an assurance and such a guarantee to each and every purchaser, we solicit a trial order for 6 full quart bottles of either or any of our special brands.

	Per Gal.		Per Gal.
Holiday Pure Rye - Eleven Years Old	4.00	Old Gold Bourbon - (Eleven Years Old)	\$4.00
Hermitage Rich & Rye Superior	4.00	Jewel Port	4.00
Five pounds of rock candy crystals to each gallon of seven year old Hermitage Rye whiskey, is used in the preparation of our Celebrated Rock and Rye.		From Silva & Cosens, Oporto. A choice product of the grape.	
Don Qui Cocktails -	4.00	Rainbow Brandy V.O.	4.00
Martini, Manhattan, Vermouth, Whiskey, Tom Gin and Holland Gin. Carefully prepared from the choicest materials, perfectly blended.		The product of one of the best American Vineyards, with all the medicinal qualities of French Brandy.	
Black Cherry	4.00	Jupiter Gin	4.00
From E. J. Gordon & Co. Warranted twenty years in the wood before bottling. Rich and fruity.		From the Swan Distillery, Schiedam, Holland, where Good Gin comes from. Tastes differ. Many people appreciate Good Gin. Jupiter is the best the world affords.	
		Medford Old Rum	4.00
		From Daniel Lawrence & Sons, Medford, Mass.	

The goods are warranted as represented, namely, the *best* of their class that money can buy or that intelligent, honest endeavor, fortified with long experience, can produce.

On receipt of your order with \$6.00 we will ship 6 full quarts, assorted to suit, transportation charges prepaid, to any railroad point in the United States where the charges for transportation do not exceed \$2.00. You cannot afford to let this chance go by. You never before had as good an offer.

Remit cash in registered letter or by express company or P. O. money order. References: Any bank in Boston, any mercantile agency, or any distiller of importance in the United States.

W. J. JONES & CO. Hanover & Blackstone Sts.,
BOSTON, MASS.

ESTABLISHED 1851

RECREATION

Copyright, December, 1902, by G. O. Shields

A Monthly Magazine Devoted to Everything the Name Implies

\$1.00 A YEAR.
10 CENTS A COPY.

G. O. SHIELDS (COQUINA),
Editor and Manager.

23 WEST 24TH STREET,
NEW YORK

CONTENTS OF THIS NUMBER

	PAGE
It Became a Free-for-All Fight.....	FRONTISPIECE
A Bear Fight in the Yellowstone Park. Illustrated.....	DAN BEARD 85
A Lullaby of the Sound. Poem.....	MRS. JEAN LE MUNYON 87
Bearding a Grizzly in His Den.....	A. L. DUHIG 89
Mr. Potter's Ovis Canadensis	STANLEY MAYALL 94
In the Arkansas Mountains.....	JOHN T. BAILEY 101
Some Place West of Kansas. Poem.....	MINNIE J. REYNOLDS 102
A Birchwood Fire. Poem.....	JAMES R. EDLIN 103
A Cushion Shot on Swartz Creek.....	C. A. HARMON 104
Outwitting a Mink.....	FRANK FARNER 105
Lost in a Tamarack Swamp. Illustrated.....	W. A. MASON 106
At a Rifleman's Fireside. Illustrated.....	W. H. NELSON 108
A Florida Kid on a Camp Hunt. VII.....	CHARLEY APOPKA 110
My First Adventure with a Buffalo.....	C. B. R., M.D. 112
My Big Trout.....	SENEX 113
From the Game Fields.....	115
Fish and Fishing	125
Guns and Ammunition	129
Natural History.....	137
The League of American Sportsmen	141
Forestry.....	145
Pure and Impure Foods.....	147
Publisher's Notes.....	149
Editor's Corner.....	151
Amateur Photography.....	157

Entered as Second-Class Matter at New York Post-Office, Oct. 17, 1894.



WELL DRESSED MEN

appreciate the great utility and
comfort of

WASHBURNE'S PATENT SCARF HOLDER

Little but effective. It cannot come loose or
ride up. Instantly attached and detached.

Scarf Holder - - -	10 Cents	} Sent Pre- paid.
Cuff Holders - - -	20 "	
Key Ring and Chain -	25 "	

They never come loose. A tiny lever with
a bulldog grip. Illustrated Catalogue Free.

AMERICAN RING CO., Dept. 44
Waterbury, Conn.

Sore Throat

Hoarseness, Quinsy, Tonsillitis
Laryngitis and other throat
troubles quickly relieved
and promptly cured
by the use of

Hydrozone

This scientific germicide is used and
endorsed by leading physicians every-
where. It is *absolutely harm-
less*, yet a most powerful healing
agent.

By killing the germs that cause
these diseases, without injury to the
tissue, Hydrozone cures the patient.
Sold by Leading Druggists. If not
at yours, will send bottle, prepaid,
on receipt of 25 cents.

Prof. Charles Marchand

(Dept. F-59) Prince Street, NEW YORK

CAMPING
HUNTING
PROSPECTING

Established 1840

Geo. B. Carpenter & Co.

MAKERS OF HIGH GRADE

TENTS, SAILS, CAMP FURNITURE

Folding Cots
Tables and Chairs

Oars, Paddles
Marine Hardware

Copyright 1899
Geo. B. Carpenter & Co.

The Largest and Most Complete Stock in the U. S.
Send 4c. in stamps for Tent and Camp Catalogue, or
6c. in stamps for Marine Hardware Catalogue.

200, 202, 204, 206, 208 S. Water St., Chicago, Ill.

DANIEL BROWN NY

GREAT COMBINATION OFFER

HICKORY PORCH SET

HERE is the greatest inducement we have ever offered you. A small sum will now make it possible for you to attractively furnish your veranda and lawn with the celebrated **Old Hickory Furniture**. Remember last summer, during the long, hot days, how you would have enjoyed this set?

All our furniture made from the finest hickory, attractive and stylish. The entire set as illustrated—

CHAIR, ROCKER AND SETTEE, \$7.75.
CHAIR AND ROCKER, \$3.50. SETTEE AND ROCKER, \$6.25.

Goods delivered free east of Mississippi River.

DESCRIPTION—Chair, Spindle Back; seat 18 inches wide, 16 inches deep; height, over all, 3 ft. 4 in. Rocker, same as chair. Settee, Spindle Back; seat, 36 inches long, 10 inches deep; height, over all, 36 inches.

If your dealer will not supply you, send direct to us. Don't miss this great offer. You are welcome to our 48-page illustrated catalogue, showing 125 patterns. Ask for it.

The Old Hickory Chair Co.

449 Cherry Street, MARTINSVILLE, IND.

20TH CENTURY LAUNCHES



STEAM YACHTS

SAIL YACHTS

ROW BOATS

CANOES

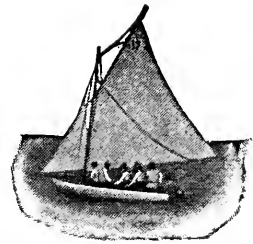
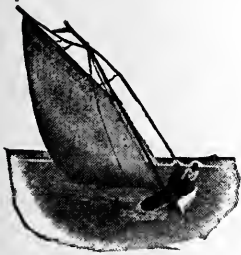

The Ideal Gentleman's Pleasure Craft used at the Pan-American Exposition because they were the best. Elegantly finished, simple, safe, reliable, and speedy. 15 ft. Fishing Launch, \$150. 16 ft. Family Launch, \$200. 35 ft. Cabin Launch, \$1,500. Send 10 cents for 80-page illustrated catalogue giving the truth in detail about the best boats built. Address

RACINE BOAT MFG. CO.
RIVERSIDE, RACINE, WIS.

We will have the largest exhibit ever made at the Sportsmen's Show, New York, of Sailing Craft, Launches, Row Boats, Hunting Boats and Canoes. Look for it Feb. 21st to March 7th

Please Take Notice

**ATLANTIC CITY
N. J.**

**Which is only about a three
hours' ride from
New York**

**Offers every inducement to the seeker after
Health or Pleasure.**

Write to

Haddon Hall

Open entire year

Ask for booklet

ALL KINDS OF PEOPLE are interested in **CAMPING-OUT,**
SHOOTING, FISHING and kindred

Out-door Sports. Follow the crowd to

ABERCROMBIE & FITCH'S

**EXHIBIT—SPORTSMAN'S SHOW, Madison Square Garden, February 21st to
 March 7th, inclusive.**



ABERCROMBIE & FITCH

MANUFACTURERS COMPLETE OUTFITS FOR

Explorers, Campers and Prospectors

Fishing Tackle, Guns, Revolvers, Cameras.

Our Photographic Department is the best in town. We
 guarantee satisfactory work in developing, printing, lantern
 slides, etc., etc., at reasonable prices.

Send for "Catalogue R."

314-316 Broadway, New York

Buffalo—Noble Animals!

ONLY A FEW OF THEM LEFT

We offer our herds of Buffalo and Elk for Sale. Every one is a beautiful specimen. Healthy and well acclimated. Breeding both species every year. We have kept these herds for years simply to show that

PAGE FENCE

will hold the strongest animals.

PAGE WOVEN WIRE FENCE CO.

BOX 39

ADRIAN, MICHIGAN

SPRATTS PATENT

(AMERICA) LIMITED.

14 Congress St., Newark, N. J.

NOTE:—As all are familiar with our staple foods we beg to draw their attention below to a few less well known specialties.

A FULL list of our products and a copy of Dog Culture will be mailed to any one upon application. To those interested in chickens, we shall be pleased to mail a copy of Poultry Culture with price list of foods, etc.

Spratts Patent Chick Meal, for chicks during first few weeks after hatching, \$6.00 per 100 lbs.; \$3.25 per 50 lbs.; \$1.75 per 25 lbs.; 75c. per 10 lbs. Cartons, 25c.

Spratts Patent Poultry Meal, used at the principal poultry shows all over the world. The most successful food for all kinds of poultry. \$6.00 per 100 lbs.; \$3.25 per 50 lbs.; \$1.75 per 25 lbs.; 75c. per 10 lbs. Cartons, 25c.

Spratts Patent Game Meal, for Young Pheasants, \$6.00 per 100 lbs.; \$3.25 per 50 lbs.; \$1.75 per 25 lbs.; 75c. per 10 lbs.

Spratts Patent "Crissel," for Poultry and Game. A preparation of Pure Meat, taking the place of Insect Life and Ants' Eggs. \$3.50 per 100 lbs.; \$1.75 per 50 lbs.; \$1.00 per 25 lbs.; 50c. per 10 lbs.

Spratts Patent Greyhound Meat Fibrine Dog Cakes, \$7.00 per 100 lbs.; \$3.50 per 50 lbs.; \$1.90 per 25 lbs. Contain 35 per cent. of meat and are made from the best oatmeal, wheatmeal, etc. Used by all the principal greyhound trainers.

Spratts Patent Cod Liver Oil Dog Biscuits, for Toy Dogs and Puppies, \$7.50 per 100 lbs.; \$3.75 per 50 lbs.; \$2.00 per 25 lbs.; 55c. per 5-lb. package, 35c. per 3-lb. package.

Spratts Patent "Terrier" Meat Fibrine Biscuits, \$7.00 per 100 lbs.; \$3.50 per 50 lbs.; \$1.90 per 25 lbs. Cartons, 25c.

Spratts Patent "Toy Pet" Meat Fibrine Dog Cakes, for very small Lap Dogs. Cartons, 25c.; 25 lbs. \$2.50.



GREAT DANE OR SPANIEL

and all intermediate species of dogs can be put in the best physical shape by

SERGEANT'S CONDITION PILLS

For the field—bench—companionship or stud a dog is not fit unless in **true condition.**

Like people he must have health or his efforts become—nil.

Probably no better formula for curing Dog ailments can ever be compounded than that of the veteran sportsman, **POLK MILLER**, Virginia's foremost sportsman, who has had 40 years practical experience in treating dogs and is possibly more familiar with their ailments than any veterinarian in this country.

SERGEANT'S CONDITION PILLS will improve a dog's appetite by curing disordered digestion, which, if allowed to develop into chronic dyspepsia allows of no peace to the best dog alive.

If a dog is attuned physically to all the requirements intended by nature, he doesn't need condition pills and he is better off without them, but dogs as a rule are subject to the same ailments that man is and are not immune any more than people; therefore, when your dog is suffering from **Distemper, Mange, Fever, Colds, Coughs, Constipation, Stomach Trouble, Indigestion, General Debility and Nervousness**, give him the best dog alterative and the only remedy for dogs that is standard wherever you may go.

SERGEANT'S CONDITION PILLS cost 50c. and \$1.00 per box at Druggists or by mail (prepaid) from

POLK MILLER DRUG CO.,
RICHMOND, VIRGINIA, BOX 217.

There isn't anywhere a dog lover or owner who wouldn't like to have our 48 page Treatise on Dogs. We will send it and a Pedigree Blank to any address for 3 cents in stamps which go to pay the postage.



Decorate Your Den

With a set of the most beautiful
Hunting and Fishing Pictures
 ever made.

15 Plates. Size for Framing, 18 x 24 inches

SUBJECTS:

ELK HUNTING	SALMON FISHING	} HY. SANDHAM
MOOSE HUNTING	TROUT FISHING	

MALLARD SHOOTING — BLACK BASS FISHING — C. E. DENTON

TARPON FISHING — BLUE FISHING — FRED. S. COZZENS

ANTELOPE HUNTING — GOOSE SHOOTING — FRED REMINGTON

GROUSE SHOOTING — WILD TURKEY HUNTING — R. F. ZOGBAUM

MUSKALONGE FISHING — F. H. TAYLOR

DEER HUNTING — A. B. FROST

ROCKY MOUNTAIN SHEEP HUNTING — E. KNOBEL

These 15 plates are lithographed in the true colors of nature and altogether make one of the finest series of pictures of outdoor sports ever published.

ORIGINALLY ISSUED AT \$50 A SET

I have bought the last of them and can furnish a complete set for 15 yearly subscriptions to RECREATION,

Or will Sell at \$10 a Set

I also have enlargements of the following photographs:

ROCKY MOUNTAIN GOATS

Published on pages 90, 91, 92, and 93 of this issue of RECREATION, \$5 a set.

WOOD DUCK SHOOTING

Published on page 95 of this issue of RECREATION, \$1.50 each.

Address: RECREATION, 23 West 24th Street, New York City



Go now to Winterless California

A favored land, unvexed by the tyranny of seasons. Here roses bloom outdoors in golden sunshine, while the East shivers with zero weather.

Delightful railway ride on a high-class train—THE CALIFORNIA LIMITED, Chicago to California in less than three days. You will be pleased with the dining car service—best in the world—and with the seclusion of the new compartment Pullmans. On the way visit *Grand Canyon of Arizona*.

Magnificent resort hotels in California.

Our illustrated books about California tour and Grand Canyon mailed free. Worth sending for and reading. Apply to agents The Atchison, Topeka & Santa Fe Railway System:

NEW YORK 377 Broadway—BOSTON 332 Washington St.—MONTREAL, QUE. 138 St. James St.—PHILADELPHIA 711 Chestnut St.—BUFFALO Ellicott Square Bldg.—DETROIT 151 Griswold St.—CLEVELAND Williamson Bldg.—CINCINNATI 417 Walnut St.—PITTSBURG 402 Park Bldg.—ST. LOUIS 108 N. 4th St.—CHICAGO 109 Adams St.—PEORIA 103 S. Adams St.—KANSAS CITY 905 Main St.—TOPEKA A. T. & S. F., Gen. Pass. Office—DES MOINES 409 Equitable Bldg.—MINNEAPOLIS 503 Guaranty Bldg.—DENVER 1700 Lawrence St.—SALT LAKE CITY 411 Dooly Block—LOS ANGELES 200 Spring St.—SAN FRANCISCO 641 Market St.—SANTA BARBARA 635½ State St.—GALVESTON 224 Tremont St.—DALLAS 246 Main St.—SAN ANTONIO 101 E. Commerce St.—EL PASO Mills Bk.—ATLANTA 16 N. Pryor St.—NEW ORLEANS 705 Gravier St.

Santa Fe

Santa Fe

**A
SAVING
OF
16 Hours
in
Time
Via**

UNION PACIFIC
WORLD'S PICTORIAL LINE

**A
Saving
of
278 Miles**

CHICAGO OMAHA SAN FRANCISCO



The Golden State Limited

Established less than three months ago, the Golden State Limited is already recognized as queen of trans-continental trains.

Innumerable letters of commendation have been received from passengers. Extracts from some of these letters appear below:

"Nothing could be more perfect." "The service is first-class." "The meals are as nicely prepared and served as in any of the large hotels in New York or Chicago." "The traveling public is lucky in securing such fine service." "The Golden State Limited has been on time at every stop." "We are glad we were passengers on the Golden State Limited."

The Golden State Limited leaves Chicago at 7.45 P.M., and Kansas City at 10.40 A.M. daily, and runs through to Pasadena, Los Angeles, Santa Barbara and San Francisco.

Route: Rock Island and El Paso-Northeastern Systems, Chicago to El Paso; Southern Pacific, El Paso to Los Angeles and San Francisco. No other train to Southern California makes faster time. No other train is so luxuriously equipped—electric lights; electric fans; barber shop; bathroom; Booklovers Library; compartment and standard sleepers; dining, buffet-library and observation cars.

Tickets and full information at all railroad ticket offices in the United States and Canada. Beautifully illustrated literature descriptive of California sent on receipt of six cents in stamps.

JOHN SEBASTIAN, Passenger Traffic Manager, Rock Island System, Chicago, Ill.

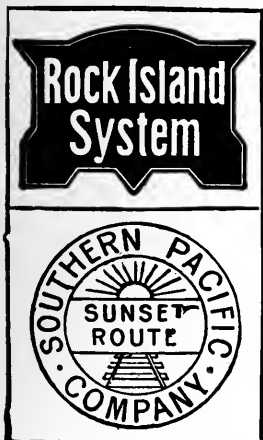



**EVERY DAY IN
THE YEAR AND
SUNDAYS, TOO**

Not the First,
Not the Last,
But the **ONLY**.

**The Missouri, Kansas
& Texas Railway Co.**

Operates First Class Drawing
Room Sleeping Cars between
St. Louis and the City of Mexico
Without change either of cars or train
attendants.

TRAIN LEAVES ST. LOUIS DAILY
AND SUNDAYS, TOO,
AT 8:32 P. M.

First day out it passes through the
beautiful Indian Territory, the second
morning it is at SAN ANTONIO, TEXAS,
the City of Missions. In the evening it
crosses the Rio Grande at Eagle Pass
(the Mexican Frontier). Thereafter the
route is via the most picturesque portion
of Old Mexico.

For a charming little book on this
picturesque country, and a souvenir Mex-
ican coin free, address

JAMES BARKER,
G. P. & T. A., M. K. & T. Ry., St. Louis.
N. B.—These are not Tourist Cars, but
the finest equipment of the Pullman Co.

“ U. S. FAST MAIL ROUTE ”

Southern Railway

TO ALL THE PRINCIPAL
WINTER RESORTS

SOUTH	CALIFORNIA
SOUTHEAST	FLORIDA
SOUTHWEST	CUBA
MEXICO and CENTRAL AMERICA	

OFFERS MANY INDUCEMENTS
TO THE TOURIST

Some Prominent Resorts are

St. Augustine, Palm Beach, Miami,
Jacksonville, Tampa, Port Tampa,
Brunswick, Savannah, Thomasville,
Charleston, Columbia, Aiken, Augusta,
Pinehurst, Camden, Summerville, Ashe-
ville, Hot Springs.

“ The Land of the Sky ” and
“ Sapphire Country ”

**PULLMAN, DRAWING AND STATE
ROOM, SLEEPING CARS; DIN-
ING, LIBRARY AND OBSERVATION
CARS OF THE HIGHEST STANDARD**

THE ROUTE OF THE
Southern's Palm Limited
NEW YORK AND ST. AUGUSTINE

**Washington & Southwestern
Limited**

AND **Sunset Limited**
NEW YORK AND LOS ANGELES AND
SAN FRANCISCO

Write for Descriptive Matter

NEW YORK OFFICES: 271 & 1185 Broadway
ALEX. S. THWEATT, Eastern Passenger Agt.
W. A. TURK, Passenger Traffic Mgr.
S. H. HARDWICK, General Passenger Agt.
WASHINGTON, D. C.

CUBA

The RIVIERA of America

**Direct
Service
New York
to
Havana**
thence along
the entire
North
Coast—an
ideal winter
trip.

**The
Munson
Line
Bulletin**
a beautifully
and
artistically
illustrated
monthly
about Cuba,
sent regularly
for the
asking.

Address
PASSEN-
CER
DEPART-
MENT.



MUNSON STEAMSHIP LINE
27 WILLIAM STREET - NEW YORK CITY
RAYMOND @ WHITCOMB CO., Ticket Agents
25 UNION SQUARE - - NEW YORK CITY

Game is Growing Scarce

SO ARE GAME FISHES

The time is coming when the only shooting or fishing worth while will be on private preserves.

HERE IS A CHANCE

To Join a Club that Will Always Have
PLENTY OF GAME and
PLENTY OF BROOK TROUT and
PLENTY OF BLACK BASS
 ON ITS OWN PROPERTY

Only 6 hours from New York City, 3 hours from Boston

20,000 acres of land, to be abundantly stocked with game of various kinds.

15 miles of trout streams to be stocked with trout.

Thousands of acres of lakes and ponds, to be stocked with black bass.

PINE FORESTS RICH IN OZONE

Hardwood forests, which are the natural home of the deer and ruffed grouse.

Old, abandoned farms, which will furnish ideal range for thousands of quail.

Golf grounds, polo grounds, tennis grounds, baseball grounds.

Fine roads for riding, driving, and automobiling.

Pure air, pure water, delightful scenery.

Address

L. A. TILLINGHAST

275 Westminster Street

Providence, R. I.

“FOR 34 YEARS A STANDARD PIANO.”

THE WING PIANO

YOU NEED THIS BOOK IF YOU INTEND TO BUY A PIANO. A book —not a catalogue—that gives you all the information possessed by experts. It makes the selection of a piano easy. If read carefully, it will make you a judge of tone, action, workmanship, and finish; will tell you how to know good from bad. It describes the materials used; gives pictures of all the different parts, and tells how they should be made and put together. It is the only book of its kind ever published. It contains 116 large pages, and is named “The Book of Complete Information About Pianos.” We send it free to anyone wishing to buy a piano. Write for it.

SAVE FROM \$100 TO \$200 We make the WING PIANO and sell it ourselves. It goes direct from our factory to your home. We do not employ any agents or salesmen. When you buy the WING PIANO you pay the actual cost of construction and our small wholesale profit. This profit is small because we sell thousands of pianos yearly. Most retail stores sell no more than twelve to twenty pianos yearly, and must charge from \$100 to \$200 profit on each. They can't help it.

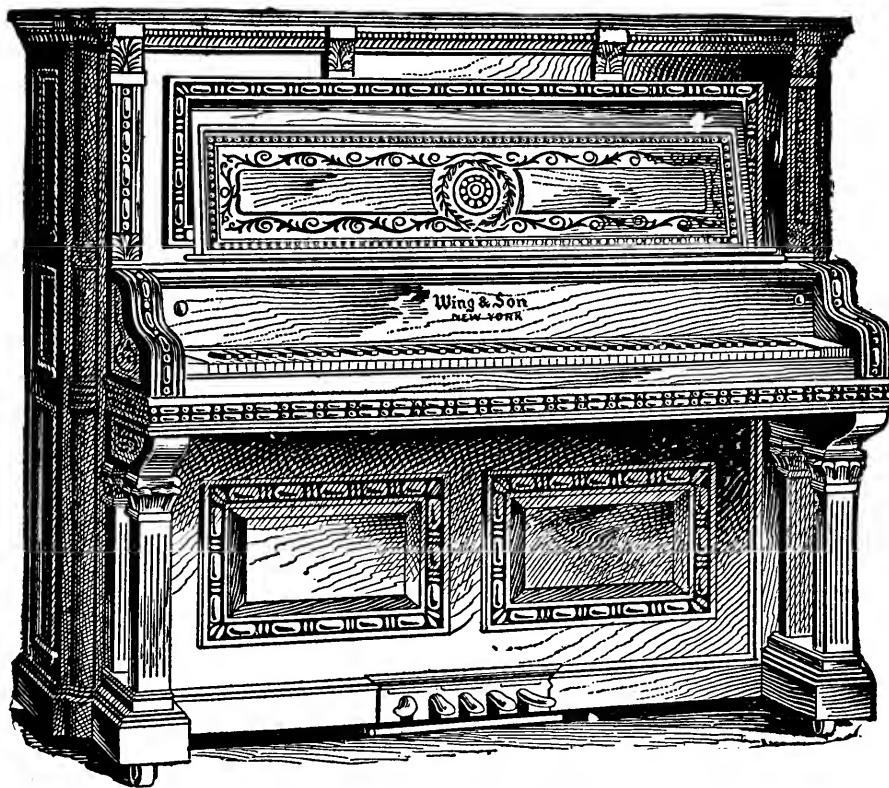

A Wing style—45 other styles to select from.

SENT ON TRIAL WE PAY FREIGHT. NO MONEY IN ADVANCE. We will send any WING PIANO to any part of the United States on trial. We pay freight in advance and do not ask for any advance payment or deposit. If the piano is not satisfactory *after twenty days' trial in your home, we take it back entirely at our expense.* You pay us nothing unless you keep the piano. There is absolutely no risk or expense to you.

Old instruments taken in exchange.

EASY MONTHLY PAYMENTS.

INSTRUMENTAL ATTACHMENT A special feature of the Wing Piano; it imitates perfectly the tones of the mandolin, guitar, harp, zither and banjo.

IN 34 YEARS 33,000 PIANOS We refer to over 33,000 satisfied purchasers in every part of the United States. WING PIANOS are guaranteed for twelve years against any defect in tone, action, workmanship, or material.

WING ORGANS Are just as carefully made as Wing Pianos. They have a sweet, powerful, lasting tone, easy action, very handsome appearance, need no tuning. Wing Organs are sold direct from the factory, sent on trial; are sold on easy monthly payments. For catalogue and prices write to

WING & SON, 226 and 228 East 12th St.,
NEW YORK.

1868—35th Year—1903.

THIRTY-SIX YEARS OF CONTINUOUS SUCCESS.

Just think what that means. Thirty-six years in business, each year more successful than the previous one, with never a backward movement, constantly growing larger, ever increasing in popular favor. How many concerns in this country have such a proud record? How many that were doing business 36 years ago are even in existence to-day? Very, very few. But thirty-six years of continuous success and still growing larger. Think of it! How has it been accomplished? In just this way. By selling absolutely pure whiskey, direct from our own distillery to the consumer, with all its original richness and flavor, saving him the enormous profits of the dealers, and by carrying out to the letter every statement or offer we make, thereby creating a confidence with our over a quarter of a million satisfied customers that cannot be broken.

HAYNER WHISKEY

4 FULL QUARTS \$3.20
EXPRESS CHARGES PAID BY US.

OUR OFFER. We will send you **FOUR FULL QUART BOTTLES** of **HAYNER'S SEVEN-YEAR-OLD RYE** for \$3.20, and we will pay the express charges. Try it and if you don't find it all right and as good as you ever used or can buy from anybody else at any price, then send it back at our expense and your \$3.20 will be returned to you by next mail. Just think that offer over. How could it be fairer? If you are not perfectly satisfied, you are not out a cent. Better let us send you a trial order. If you don't want four quarts yourself, get a friend to join you. Shipment made in a plain sealed case, no marks to show what's inside.

Orders for Arizona, California, Colorado, Idaho, Montana, Nevada, New Mexico, Oregon, Utah, Washington or Wyoming must be on the basis of 4 Quarts for \$4.00 by EXPRESS PREPAID or 20 Quarts for \$16.00 by FREIGHT PREPAID.

Write our nearest office and do it NOW.

ESTABLISHED
1866.

THE HAYNER DISTILLING COMPANY,
DAYTON, OHIO. ST. LOUIS, MO. ST. PAUL, MINN.

DISTILLERY,
TROY, OHIO.







IT BECAME A FREE-FOR-ALL FIGHT.

RECREATION

Volume XVIII.

FEBRUARY, 1903.

Number 2

G. O. SHIELDS (COQUINA,) Editor and Manager

A BEAR FIGHT IN THE YELLOWSTONE PARK.

DAN BEARD.

The transportation company's stages had emptied their loads of dust-covered sightseers at the open doors of the Fountain House, and the ink on the register was not yet dry where-with the newcomers had written their names, when the Fountain geyser began to grumble, hiss and send up clouds of steam, promising an early eruption. Following suit, all the finger holes and cracks in the formation, the hot springs and the baby geysers shot out jets of steam. The

overs in a stampede for the garbage heap on the white geyserite formation back of the house. Suddenly the crowd came to a halt.

"Gee!" exclaimed a small boy, as he pushed the button of his kodak.

"Waugh! waugh!" shouted the pilgrims from Medicine Hat and Rat Portage.

"Hey! May be rubberneck, what?" laughed the man from Moose Jaw.

"Say! she's a tough proposition,



NOSING AROUND FOR A LUNCH.

By courtesy of the Northern Pacific Railway.

Mammoth Paint Pot began to plop, plop, plop! and throw up gobs of pink, white and yellow mud into the air from its bowl full of scalding silicious clay. All this hubbub was a vain attempt to attract the tourist attention.

The Dante's Inferno in front of the hotel might have saved its steam and sulphur for another occasion, as it was unnoticed by the guests. The new arrivals were following the lay-



A WHIFF FROM THE KITCHEN.

an' she wears the straps all right," cried a guide; while the doctor from Chicago, the broker from New York, the officeholder from Ohio, the colonel from Kentucky and the dude from Honolulu all clapped their hands with delight.

Having dumped its load of table leavings and tin cans the hotel garbage wagon was rumbling back over

the formation to the stables, but it was not the wagon, team, driver or load of food scraps which called forth the applause and exclamations of pleasure from the guests of the Fountain House; it was 9 great black bears that interested us.

To the delight of the spectators the bears had given a short exhibition of their skill as boxers. It was a hot fight; but it did not last long. In fact, it was a mistake in the first

gaged in pawing over the garbage near by, when the indignant mother lifted her paw for a swinging blow, missed the culprit and landed with a resounding swat on the jowl of her benevolent appearing neighbor.

"Ough-oo-oo-ee-ee-eah!" cried Fatty, in a rage, as he rose on his hind legs and let go at the solar plexus of Old Spot. He had gained his name by breaking through the crust near the Paint Pot and covering one black



WAITING FOR THE GARBAGE WAGON.

By courtesy of the Northern Pacific Railway.

place; an impromptu affair not down on the menu. This is the way it happened.

A long legged cinnamon bear snatched the remains of some ribs of beef from under the nose of the big mother black bear at the moment she was calling her 2 little cubs to partake of the roast. A benevolent looking bruin, with a glossy black coat covering his rotund body, was busily en-

side with hot white mud. Spot's temper had been none of the best since that day, and in less time than it takes to tell it he let fly with his left and right at his nearest neighbor, and it became a free-for-all fight accompanied by a continued ough-oo-eah-ing in various keys.

During the *melee* the cinnamon bear who caused the riot was quietly eating the remnants of the roast beef,

gnawing the bones within 10 feet of the gallant Kentucky colonel, to the latter's great amusement.

Although nearly all the men present had cameras, only women and children took advantage of the sunlight and clear sky to photograph the scrapping bears. The sport-loving men stood around in a semicircle, with pleased grins on their faces, too much engaged in applauding the hairy gladiators to waste a thought on the black boxes under their arms.

Scarcely had the women and children time to wind up their films when the brown bear, elated over his former success, made another attempt to slip up unobserved to the garbage pile. To the casual onlooker it would appear that the black bears were all too busy seeking their own dinner to heed the brown's approach; but a close observer could not fail to notice that the beadlike eyes of the blacks were keenly alert. No sooner did Brownie come within reach than biff! biff! biff! came the great black

paws on his unprotected head. An elderly spinster, who seemed deeply interested in the zoological show, stood within 15 feet of the feeding brutes and directly in front of the cinnamon bear, when, with open mouth, it made a dash for safety. With a quick movement the frightened spinster gathered up her skirts, there was a flash of white petticoats, a twinkling of feet, and she was gone, never once looking back until she slammed the hotel door behind her.

The astonishingly rapid gait at which the terror stricken lady made her 100 yard dash called forth the wildest enthusiasm from the spectators, and the colonel pushed the button of his pocket camera 3 times without once winding up the film.

Of course the brown bear turned aside into the woods the moment he was out of reach of the powerful blows of his relatives, but it was of no use telling that to the spinster. She will always believe that the brute followed her to the hotel door.

A LULLABY OF THE SOUND.

MRS. JEAN LE MUNYON.

The restless waves, with murmurings low,
Are crooning a lullaby soft and sweet;
And the ebbing tide, with its steady flow
To'rd that mystic realm where the
surges meet,
Is bearing the ships that sail away,
And rocking my anchored barque to-
day.

Rocking so softly upon the tide,
I pleasantly, peacefully dream and sleep;
The gray gulls noiselessly o'er me glide,
And lightly skim o'er the ruffled deep
As they circle and dip in the foaming
waves,
Then speed away to their sheltered
caves.

As I gently rock on the heaving bay,
Watching the ships speed merrily on,
The falling wind and the shadows gray
Proclaim that the day is nearly gone;
But the deep sings on, through its
smiles and tears,
The song it has murmured for count-
less years.



AMATEUR PHOTO BY E. J. KERLEE.

TWO CANADA LYNXES.

Winner of 1st Prize in RECREATION'S 7th Annual Photo Competition.

BEARDING A GRIZZLY IN HIS DEN.

A. L. DUHIG.

Finding we could absent ourselves a few days from our posts at Thermopolis, Wyoming, without deadlocking the industries of that burg, my chum and I determined to take advantage of the discovery. We would ride forth, view the scenery and expose a few plates on such bits of it as evidenced good workmanship. In the canyon of the big Horn river, 10 miles North of Thermopolis, there is a plethora of scenery, a little chaotic, to be sure, but first rate of its kind.

Thither we rode one bright morning, equipped with a camera, blankets and provisions for several days. In addition, my companion, who, because of a genial Western custom and a light-colored poll, is known as Cotton Top, carried an old 44-caliber rifle. Though it contained a few cartridges, it was taken chiefly to enable Cotton to pose in the foreground of my prospective pictures.

The canyon is exceedingly rough. Therefore we left our horses at its mouth, and went in afoot. There are a number of rapids and falls about 5 miles up the gorge, and we intended to visit them. We went 3 miles or more, clambering over the rocky bed of the canyon. Coming to a narrower place we found it necessary to mount the side of the gorge a little way to avoid the clutter of boulders and loose rock. The slope was not great and I was pushing rapidly ahead when stopped by an exclamation from my friend. He was some distance in the rear and was pointing at something higher up. Not until I had retraced my steps to his side could I see what had attracted his attention. Under an overhanging ledge and hidden from most points of view by projecting rocks, was a hole about $3\frac{1}{2}$ feet in diameter.

"I say," cried Cotton, "s'pose it's Dolan's mine!"

Now among the stories told to children and other receptive persons in our part of the world is one which recites the adventures of a certain Dolan.

He was an oldtime prospector and for years went to and fro. His sole possessions were a pick, a disreputable Mexican dog and a thirst that would have cut him down ere his prime, had not misfortune and a total lack of credit preserved him to adorn a tale. Once he appeared suddenly at a mining camp with an air of mystery, a handful of nuggets and a shriveling drouth. Those good things he exploited at the nearest bar. Before becoming speechless he confided to the crowd, in strictest con-

fidence, that he had found an old Spanish or Indian mine. Its extraordinary richness, he added, could be judged from the fact that when he chanced to sneeze in the shaft, the echo loosened a half peck of nuggets from the roof and sides. As gentle hands laid Dolan in a bunk to get over it, he is said to have murmured that it was his firm intention, after his next visit to the mine, to buy the greater part of Wyoming as a playground for his dog. Alas! his modest ambition was never realized. A long enforced course of alkali water had so corroded his tank lining that that bright dream was his last.

Despite its gauzy probability the yarn had always appealed to my fancy. I was, therefore, very willing to follow Cotton into the hole, perchance to find ourselves joint heirs of the late Dolan.

We had 2 candles among our supplies. Lighting those and leaving our packs outside, we entered the hole. That the rifle remained hanging by its sling to Cotton's shoulder, was, I am sure, due only to his having forgotten it. The hole enlarged so rapidly that at 15 feet from the entrance it was perhaps 10 feet wide and so high we could stand almost erect. The walls were black and lusterless, with not one gleaming point that even a tenderfoot could fancy golden. I was about to voice my disappointment when we heard a clatter as of moving pebbles.

"What's that?" I cried.

"I don' know," said Cotton; "a wolf, perhaps."

That reminded him of the gun, and he was slipping it from his shoulder when, with a loud growl, a great beast charged out of the darkness. We both yelled, dropped the candles, and sprang aside. I was an instant too late. The brute's shoulder struck my hip and threw me against the wall with such force that I rebounded and fell, just clearing his hind feet as he passed. Why he did not attack us I can not imagine, unless it was because he was as frightened as we.

We lost no time in getting out of the cave. Its late occupant, a large grizzly bear, was slowly climbing the side of the canyon, about 150 yards away. Cotton threw the old gun to his shoulder and fired. Some benign chance steered the bullet and it broke the bear's spine. The big beast rolled down the slope, snarling and catching at rocks and shrubs with his forefeet. He landed at the bottom within easy range, and a head shot ended his troubles.



MOUNTAIN GOATS AT HOME.

One of the 2d Prize Winners in RECREATION'S 7th Annual Photo Competition



THE CLIMBERS.

One of the 2d Prize Winners in RECREATION'S 7th Annual Photo Competition.

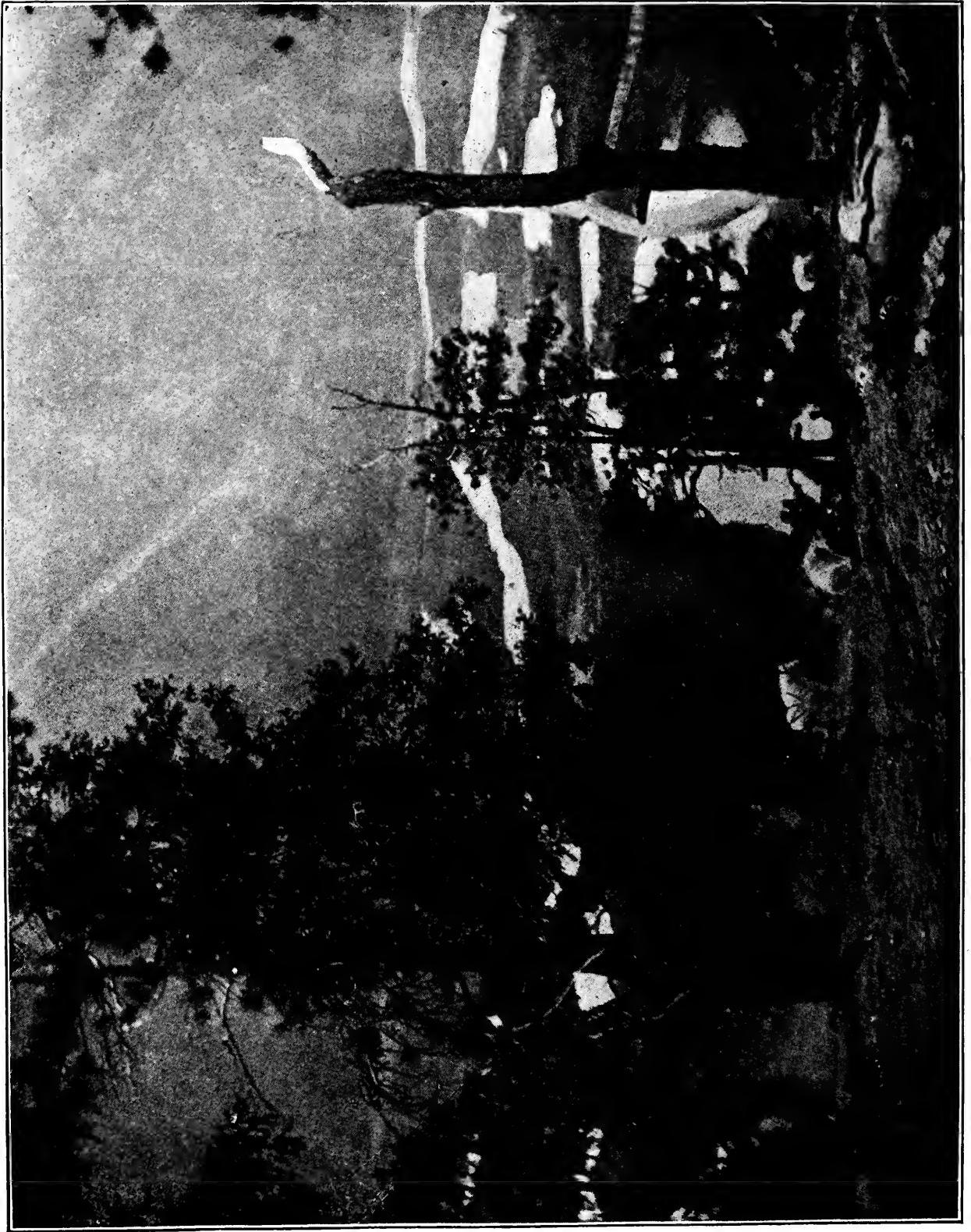

LOOKING BACKWARD.

One of the 2d Prize Winners in RECREATION'S 7th Annual Photo Competition.

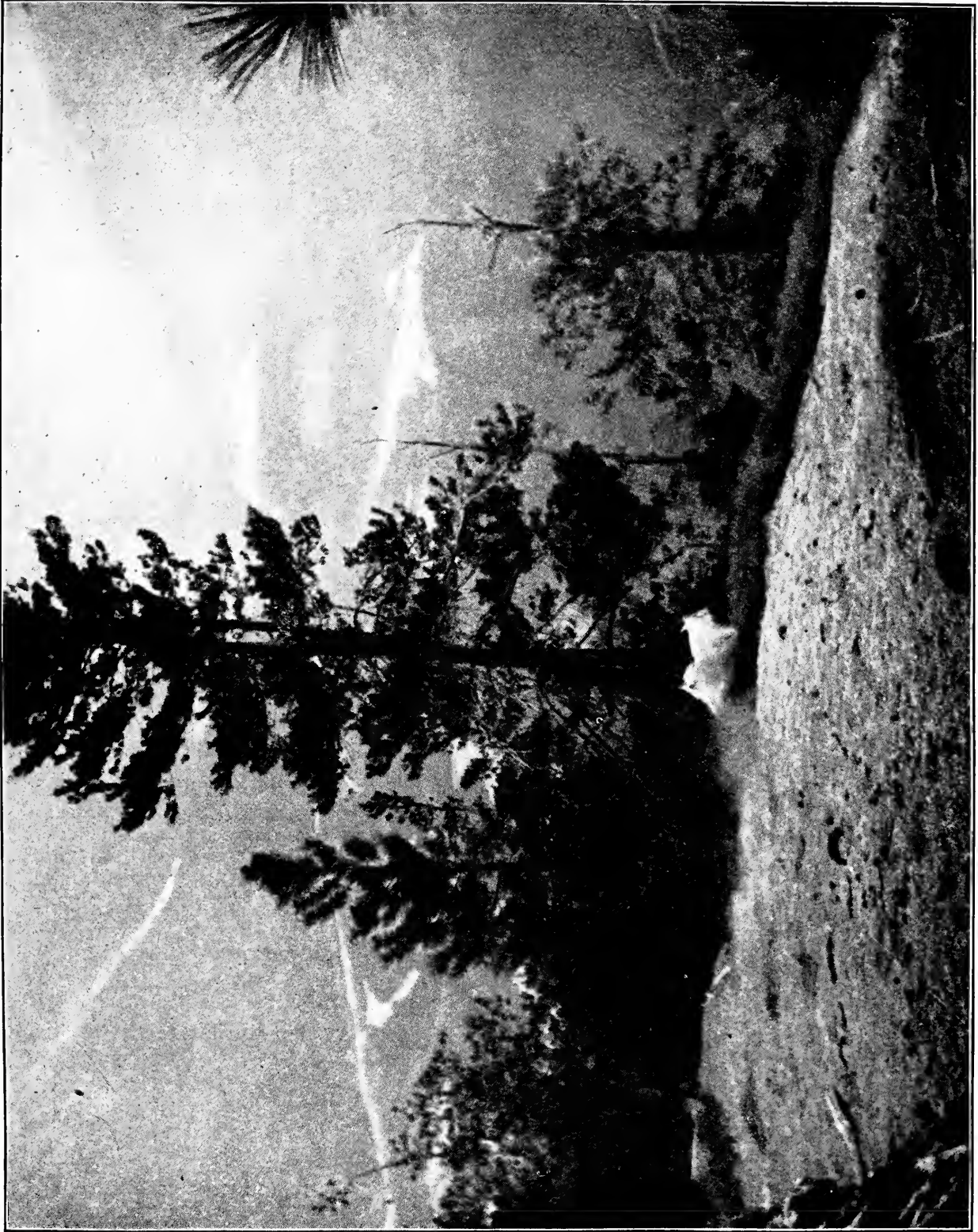

AMATEUR PHOTO BY A. M. COLLINS.

A HOME RUN.

One of the 2d Prize Winners in RECREATION'S 7th Annual Photo Competition.

MR. POTTER'S *OVIS CANADENSIS*.

STANLEY MAYALL.

Gregory N. Potter came from Boston and was never ashamed to let the people of Fire Gulch know it. The 2 towns and their surroundings are different, but Gregory sacrificed the luxuries, the joys and the oldtime institutions of the East in the blessed hope that he would bag a grizzly. He could hardly have found a likelier spot for big game. Deer and bear of various species, cougars, lynxes and other denizens of hill and forest were there. Gregory had plenty of money and was willing to pay for his sport, but somehow he had bad luck. Experienced guides escorted him for weeks together. He martyred himself hourly to secure some satisfactory booty. Housed miserably, fed abominably, sleeping anyhow, he had got up at daybreak or stayed awake all night, shivered, perspired, walked, climbed, rowed, rode or swam, torn his clothes to shreds, ripped his boots to ribbons, bumped, bruised and scraped every limb, and at the end of 4 weeks had not secured hide or head worth mention. He was only a second rate shot and an indifferent mountaineer, but taken at his worst something more than this was his due. His bags had been confined almost entirely to ducks, mountain grouse and pheasants, mostly out of season. He was getting discouraged. People ceased to apply his Christian name and called him "Hen Potter" only. He resented this and was so indiscreet as to remark that his guides were incompetent and that he would dispense with their services and save the cost.

Accordingly the next day he set out alone. He returned at night with a pleased expression, visited 2 or 3 of the saloons, drank more than usual, retired early and the next morning at daybreak set out again. On his return he was still hopeful, but not satisfied. The third day he once again disappeared early and returned at nightfall. He was tired, dirty, thirsty, but radiant with delight; for he had proved his ability as a hunter, and made his bag.

"Been after him 3 days, close on his tracks all the time, saw him at a distance the first day, lost him the second, bagged him the third. Bagged him first shot; just put an expander in the right place, and will have a magnificent head and hide."

He felt his trouble and expense had been repaid; but where were those blamed guides? He wanted to tell them about it; they would be jealous, as he believed this was the only specimen of its kind that had been killed in that locality for over 2 years. He had dressed it, suspended the carcass on

a bull pine and would have it brought in on a pack horse. What was it? A Rocky mountain sheep! A bighorn! What naturalists termed the *Ovis canadensis* and worth all the deer in the country.

One of the guides came into the saloon but did not like the turn of events. He was mortified, jealous, yet cordial.

Another said, "Mount'n sheep, eh! well, as Uncle Remuus says, it mout be and then again it moutn't"; darned ef I know where in thunder it strayed from, or 'ow in 'ell 'e found it when it did, or 'ow 'e 'it it when 'e saw it." A third, known as "Rain-in-the-Face" because of his pox pitted physiognomy, said still less, but apparently thought the more and left the saloon with a grin on his face.

"Gee wizz!" he ejaculated when outside, "ef et should only be! Ef et should only be! There'll be a hot time in the old town to-morrow. Pat 'll pound 'im into putty. There'll be merry hell in this 'ere burg, come Friday, or I'm mistaken. Gosh! This is the greatest fun since the boom."

Gregory went to bed that night the happiest man in the woolly West, full of honor and whiskey.

Next morning Potter's *Ovis canadensis* was early secured and deposited on the verandah sidewalk of the Waldorf hotel in Fire Gulch, and exposed to the admiring gaze of a curious crowd.

The general opinion was that a valuable trophy had been secured and that the kill had been correct. The ball had entered the left forequarter, pierced the lungs and having duly expanded had emerged through a large everted wound from the right shoulder. Much blood had escaped. Gregory was proud of himself. His 3 days' labor had ended in glorious success.

"Hang all guides," he once more ejaculated; then to an inquirer:

"What is its name? Oh, the *Ovis canadensis*, the mountain sheep; the big——"

"See here, stranger," a loud voice interjected, and a tall, heavy, stoutly built man, hoarse with passion, white with rage broke into the bar-side crowd, "See here, young man. I want you." He took Gregory roughly by the arm and led him to the door.

"What-in-the-name-of-'ell-did-you-do-that for?"

Gregory was no coward and as each word had been accompanied by an angry shake he bridled furiously.

"Let go, you hulking villain, let up, or you'll know about it."

"Know about it, eh! Who knows more?"

Know about it, eh! You gorn strimmed, farm yard, barn-storming murderer! You ought to bin born a nigger, you tender toed, bat-eyed roost robber.

"See here," he said once more, "this mounten sheep of yours, this wild monster of the 'ills wot you gallantly laid out with-in 300 yards o' my shack door, has some funny marks on 'im. I put 'em there an' I'd like to put same on you." He stooped and with his hand brushed heavily aside the clotted blood on the sheep's right shoulder. He further applied Potter's own pure white lawn handkerchief to the spot and exposed to the gaze of the astonished hunter the letters B. P. branded there.

"P. B.," he ejaculated "p double e P, b double e B.; short for Patrick Bolger, that's me. Patrick Bolger wot payed \$1,000 way East not 3 weeks ago for this same blessed imported, cup winning, long pedigree, stud ram; \$1,000; and come to think of it freight and duty besides; and you, you ornary, empty 'eaded, blanket-eyed, fumble footed son of a mummy, you wastes

good powder and lead turnin' it all into \$10 worth o' mutton. Guides come expensive, do they? So do mount'n sheep, and this special item's costing you just \$1,500. When are you goin' to pay?"

That night poor Gregory after much haggling and ignominy, a sadder, wiser and poorer man paid over to Patrick Bolger \$1,400 dollars good and lawful money of Canada and took in exchange a receipt for the stud ram Boxer; and unable to face the avalanche of derision which overwhelmed him left Fire Gulch forever by the 4 o'clock stage next morning. The night of settlement "Rain-in-the-Face" somehow developed into a capitalist. During the next few days he was known to invest nearly \$300 in whiskey and perhaps \$200 in real estate. "Mighty good notion o' your'n," said Pat to him. "Th'owd ram cost \$95 all told. That 'ill be \$800 for me and \$500 for you, clean profit, an' I hope Providence will soon send some more wise men from the East. Deer is cheap, sheep is dear, but asses is val'able beyond calkulation."



TWO GOOD SHOTS.

AMATEUR PHOTO BY R. C. CAMERON.

Conditional Winner of 3d Prize in RECREATION'S 7th Annual Photo Competition.

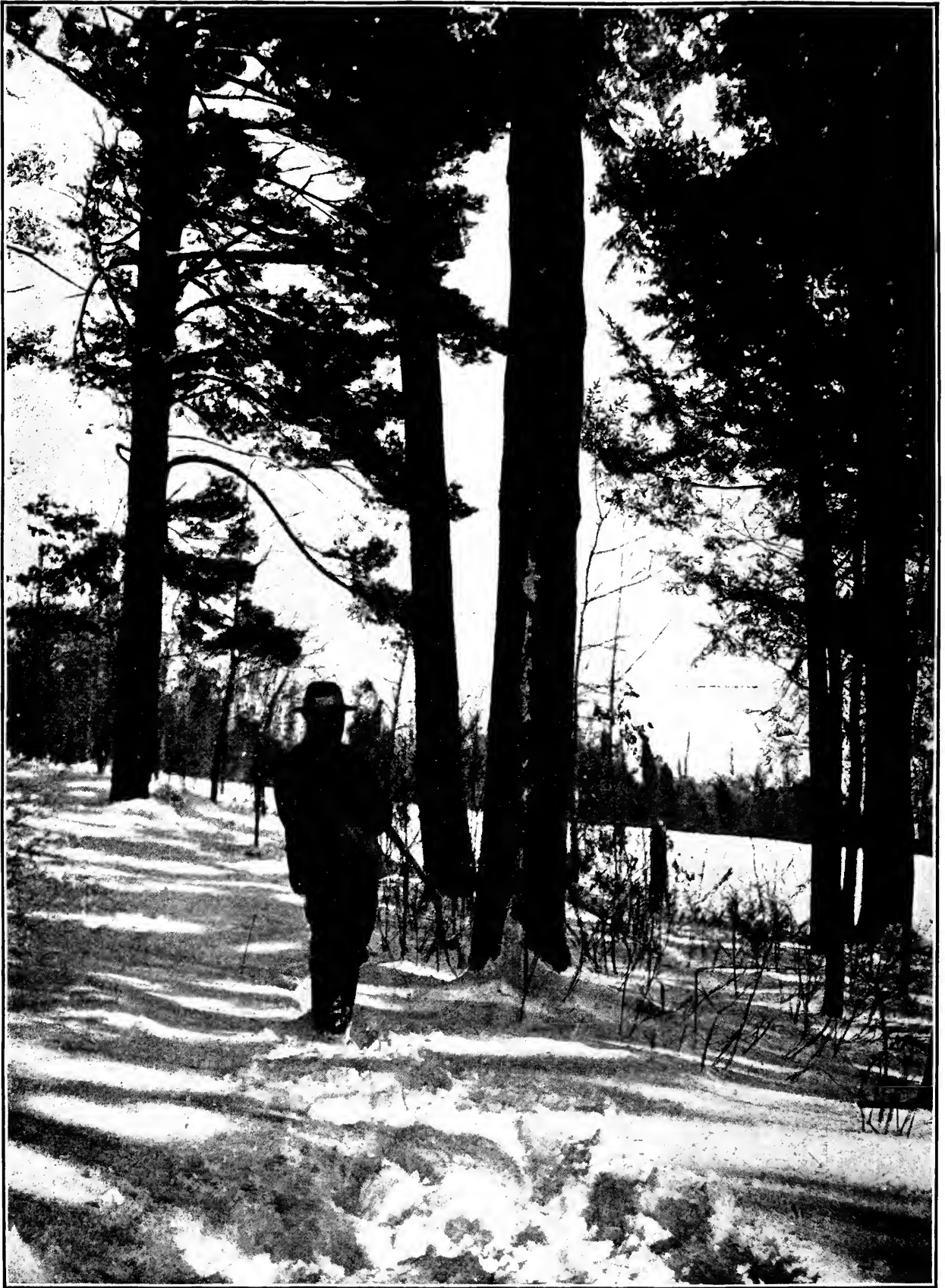

WATCHING.

One of the 4th Prize Winners in RECREATION'S 7th Annual Photo Competition.



GREAT BLUE HERON.

One of the 4th Prize Winners in RECREATION'S 7th Annual Photo Competition.

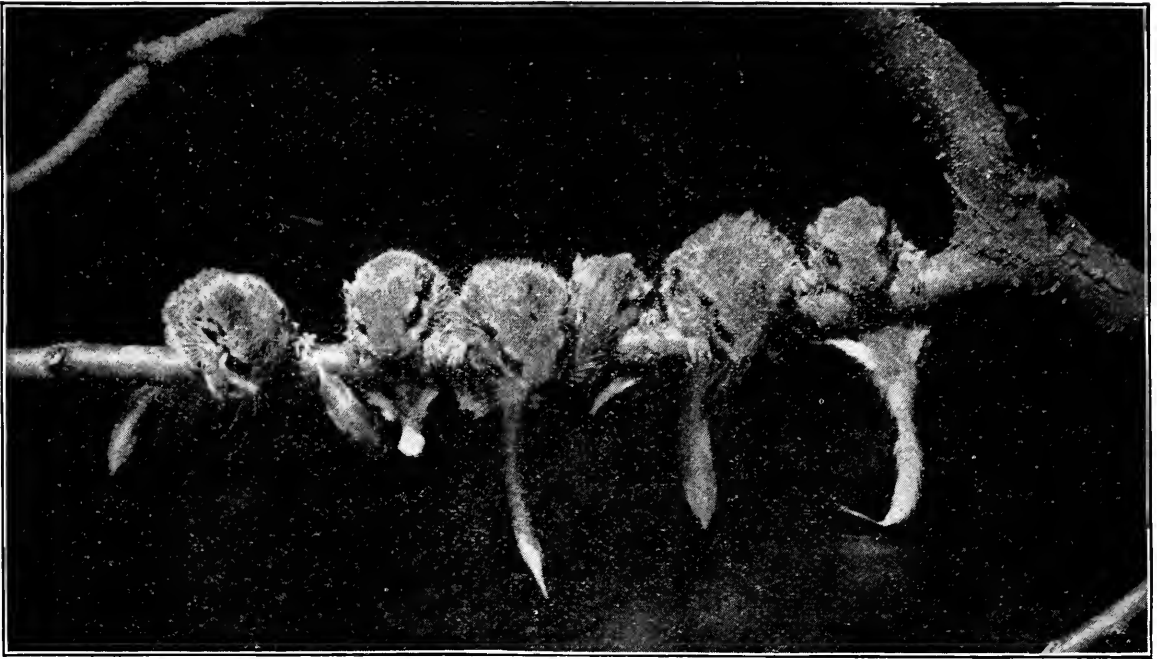

YOUNG FLYING SQUIRRELS.

One of the 4th Prize Winners in RECREATION'S 7th Annual Photo Competition.



YOUNG WOODCOCK.

One of the 4th Prize Winners in RECREATION'S 7th Annual Photo Competition.



YOUNG WOODCOCK.

One of the 4th Prize Winners in RECREATION'S 7th Annual Photo Competition.

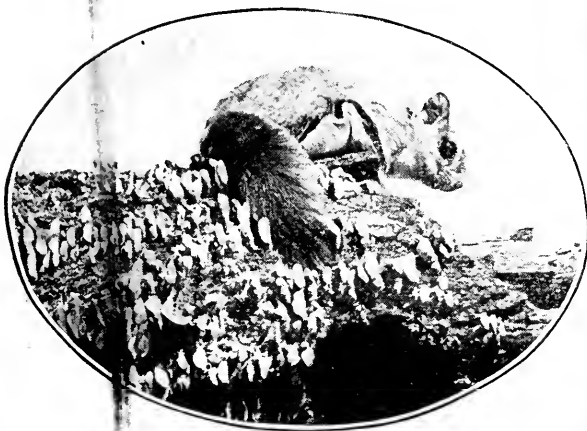

LIVE WILD FLYING SQUIRREL.

One of the 4th Prize Winners in RECREATION'S 7th Annual Photo Competition.



HIS PRIVATE PRESERVE.

One of the 4th Prize Winners in RECREATION'S 7th Annual Photo Competition.



ANOTHER POSE.

One of the 4th Prize Winners in RECREATION'S 7th Annual Photo Competition.



AMATEUR PHOTO BY DR. PARDOE

YOUNG BLUE JAYS.

One of the 4th Prize Winners in RECREATION'S 7th Annual Photo Competition.

Mr. Greatman—I wish you'd stop printing my portrait every time any little thing happens to me, or else get a new one. You've had that old plate in 17 times.

Editor—All right, my dear sir. Anything to oblige.

Assistant Foreman (a week later)—I can't find that picture of Sam, the sneak thief, anywhere.

Foreman—Well, dump in that old picture of Mr. Greatman. It ain't going to be used for him any more.—New York Weekly.

Mother—Perhaps the young man needs a little encouragement.

Daughter—Yes, mamma. I wish you would keep out of sight more when he is here.—Exchange.

"What are you doing here?" demanded the irate farmer of the boy he had surprised in his chestnut grove.

"Nutting, sir," replied the frank little chap.—Judge.

"What do you intend to do for a living?" asked the old gentleman, in disgust.

"I—aw—thought I'd marry," replied Perry, the shining light of society.—Exchange.

IN THE ARKANSAS MOUNTAINS.

JOHN T. BAILEY.

I had long wanted to see the Boston mountains of Arkansas, as I had heard the region was exceedingly wild and picturesque. Besides, I knew there were turkeys there, a chance for a deer, and ducks and squirrels galore; so about November 1st, Rob Dyer and I took the train for St. Louis. There we boarded the 'Frisco line to Eureka Springs, Arkansas, where we met Tom Basset, our guide, at the depot with his covered wagon and team of mules and 3 dogs. We started on our mountain drive about 9 a. m. Our guide's dogs first attracted our attention. Two were hounds and one was evidently a mongrel. We asked Basset what they were to be used for. He replied that the hounds were good turkey dogs and that the mongrel was the best coon dog of the settlement, while all earned a good living by finding rabbits and squirrels. After driving a few miles he suggested that one of the bird dogs be allowed to run along the road in order that we might have quails for dinner; so we turned Don, the older dog, out, and he was soon hunting vigorously. No quails were found, but before long Basset told us the road would soon turn at right angles, and if we wished to hunt a large weedy stubble which lay at our right, we could do so and strike the road again on the other side. We promptly climbed the rail fence and it was not long before birds were found. In fact the dogs found 3 beavies and we bagged 15 birds in less than 20 minutes. Not long after, one of the dogs pointed from the road and we got 3 more but did not follow the bevy. Several times one of the dogs made a staunch point and we climbed out of the wagon only to discover that a chipmunk in the fence was the object of attention, much to Rob's disgust.

When noon came we rested while Basset cooked us a good dinner. By nightfall we had made 20 miles and Basset's dogs had proved their worth by treeing 9 squirrels as we went along, we taking turns at getting out of the wagon and bagging the game. Basset and Rob had a great laugh at my expense over a fox squirrel which the dogs treed in a short hollow snag. I pushed an axe handle into the hole and pounded vigorously without result, so I announced that nothing was there. Basset, who resented the slur on the intelligence of his dogs, jumped out of the wagon and found the squirrel, pounded to a jelly and covered by rotton wood and dust.

We traveled 3 days in this manner most delightfully, shooting quails and squirrels

by the roadside, and one evening bagging 18 mallards at a river which we reached just in time for the evening flight. We never tired of the scenery. Every mountain top showed us another exquisite valley containing fresh beauty of hill, or bluff, or stream; and to the right or left of the road, or trail, little nooks, and caves, and grottoes were ever and anon disclosed and myriads of mountain springs. Toward evening of the third day, after following a mere trail in the forest some distance, we reached the camping spot our guide sought, and a finer one I have never seen. From a cave near the top of the mountain poured a large spring, which ran down a series of ledges until it reached a little glen about 50 yards in diameter. In this glen were beautiful trees and vines, moss and ferns adorned the rocks, and squirrels were barking everywhere around. At that spot we spent the most delightful week I ever enjoyed.

Basset promised to find us a bunch of turkeys, but we were becoming rather skeptical when several days had passed without a sign of the birds. One morning Rob and I took our dogs and went Southward along a level ridge after quails, while Basset and his hounds were scouring a parallel ridge not far away. We found nothing until noon, when both dogs came to a point at once on what proved the largest bunch of quails I ever saw. A hundred birds, at least, rose and flew in every direction. Rob took one dog and I the other, and until 3 o'clock we had glorious sport. By that time we got together and agreed that we had birds enough. Those mountain quails seemed larger and brighter colored than the birds we had found along the road and we were at a loss to understand why they collected in such large flocks.

While we were talking about it there arose a tremendous racket on the ridge opposite us. Basset was yelling like an Indian, while his dogs made the woods resound. Soon the guide was silent, though the hounds kept giving tongue. Presently came the report of Basset's Winchester and a yell of exultation. At this we ran down the mountain and up the other ridge. When we got over there Basset was standing by a dead turkey. Telling us to wait there for him he set off at a fast run with the hounds. For the next half hour we could hear the hounds trailing hither and thither through the woods, and then the guide returned alone, having sent the dogs to camp. He said he had killed the turkey while it

was standing in a tree watching the dogs, and that the noise he had made was to thoroughly frighten and scatter the flock. He added that we would have to wait again while he took our dogs and tied them up out of sight and hearing, and that then he would try to call up the turkeys.

When he returned he placed Rob in front of a big pine facing East and made me sit in front of another tree, facing West, my position being about 50 yards west of Rob's. Basset said we need not be afraid of the turkeys seeing us if we would remain motionless. He then took a position midway between us and began calling "keow, keow keow." At first he called loudly and frequently, but after hearing an answering yelp he called softly and at longer intervals. The first answer came from Rob's side. It was twice repeated in the next 10 minutes. Then there were 2 reports in quick succession. We went to where Rob was standing and found he had taken snap shots at a turkey about 60 yards away, and had missed. Basset cautioned him to wait longer next time and, assuring us there would be more chances, placed us again in our stations.

After he had called for 15 minutes an answer came from the West and soon 2 great birds pitched from the top of the opposite ridge and flew almost straight toward me. As they passed me at about 20 paces I fired at the leader and he fell, riddled with shot. Rob and I pulled on the other at the same instant. The bird fell, gathered itself together and started to run, but ere it had gone 10 yards the guide overtook it. He ordered us back to our places and soon I heard a turkey call, a little to my right. When Basset answered, the bird came running but suddenly stopped about 60 yards away. In all my hunting

experience my nerves were never so tested. I thought the bird saw me and that the next moment he would be off without giving me a shot, still I forced myself to obey Passet's instructions. In a few moments the guide yelped faintly, and then I understood why the bird had stopped. It was to listen, for as soon as the call sounded he ran straight on and at 2 rods distance saw me. It was a young gobbler and I shall never forget his look of dismay. For several seconds he stood as though turned to stone, then as I jumped to my feet he hurled himself into flight. I pulled the trigger and one more turkey was added to our bag. The guide called up 2 more, Rob getting one and I the other.

The next day Basset killed a yearling deer, and had we not had some mountaineer visitors much of our game would have spoiled on our hands. In some way our presence had become noised through the mountains and Sunday morning all the men and boys for miles around gathered at our camp. They came on foot, on mules, and on horses, and gazed amazedly at our hammerless guns and Rob's 30-30 rifle which our guide assured them would kill a deer 2 miles away.

We stayed in camp 10 days and I never before so enjoyed shooting or eating. Several times we went to a river near and shot ducks; and the quail shooting seemed all the more enjoyable after a change to ducks, squirrels, or turkeys. The walking was good, the woods were open, and there were no fences to climb. At night the hounds would tree coons and we would take our lantern and axe and bring them into camp. It took us nearly 4 days to make the journey back to the railroad, but it was all enjoyable, and Rob and I are looking forward to another trip with Basset.

SOME PLACE WEST OF KANSAS.

MINNIE J. REYNOLDS.

Ship me some place West of Kansas, where
the earth's not crowded so;
Where they have about four people to each
square mile or so;
Where the atmosphere's been washed and
dried, and ironed so smooth and fine,
That it seems a happy foretaste of some
elixir divine.

For I'm sick of all these people, swarming,
moiling to and fro;
Sick of twenty-storied scrapers and the
stony streets below;
And the homesick heart within me longs
for spaces wide and free
That stretch out West of Kansas, and it's
there I'd like to be.

Oh, I love the locomotive, when her head,
is pointed West,
And her wheels are swift revolving; 'tis
then I love her best.
Past the lake front at Chicago, corn fields
rich of old Mizzoo,
Past the bluffs at Kansas City, Westward
portals rolling through.

When my day's work is over, and I toil
and moil no more,
Don't bury me in sodden earth upon this
foggy shore.
Ship me some place West of Kansas,
where the great plains onward sweep;
'Neath the shadow of the Rockies let me
softly, sweetly sleep.

A BIRCHWOOD FIRE.

JAMES R. EDLIN.

When the cold night winds a-howlin',
 Set the ole hound a-growlin',
 An' shake an' rattle doors an' winders, fit
 to wake the dead;
 An' the winder panes is bright
 With the frost-reflected light
 A-shinin' from the birch logs in the fire-
 place, blazin' red;
 When I come a-stampin' in
 From the milkin', it's a sin
 The way I love to linger an' to stan' aroun'
 an' gaze
 In the fireplace, red an' roarin'
 With the flames that go a-pourin'
 Up the black an' smoky chimbley,
 From a
 Good
 Birch
 Blaze!

In the evenin', when the folks,
 With their laffin' an' their jokes,
 Make a ring about the fireside, an' pass
 roun' the cider jug;
 Then I love to watch the games
 Of the leapin', dancin' flames,
 As they wreath aroun' the forestick with
 a sort o' lovin' hug;
 Seems like they're full's kin be
 Of the good will an' the glee
 That's allus kind o' ketchin' in these crispy
 winter days;
 An' in all the world around
 Thar's nothin' to be found
 So comfortin' an' cheerful
 As a
 Good
 Birch
 Blaze!

Now, when I wuz down to York,
 I heerd our son's wife talk
 'Bout their *ole-fashion fireplace*; but, praise
 it as she would,
 Be dad-dinged ef I could
 See any earthly good
 In a fireplace made o' *gaspipes*, painted up
 to look like wood!
 So, when the rivers freeze,
 Jest give me, if ye please,
 A load o' seasoned birchwood, jest as big
 as you kin raise,
 An' enuf to eat an' drink;
 An' be danged ef I don't think
 I could set an' loaf *forever*
 By a
 Good
 Birch
 Blaze!



A CUSHION SHOT ON SWARTZ CREEK.

C. A. HARMON.

Loving peace above all things I have hitherto firmly suppressed the impulse to fasten the epithet of liar on certain people and, in spite of the fearful jar veracity sustained at the hands of the author of "A Racket in the Rockies," I again play the nobler part and set him herewith an example of fidelity to fact and detail which I prayerfully hope he may remember in the future, lest something awful happen to him.

Way back in the '90's I went into camp on Swartz creek, in a country where game was simply ubiquitous. I had to camp on an island to keep the wild creatures from disturbing me at night. Having packed in but a meager outfit from Piersonville, Mich., through a trackless wilderness, I had much difficulty in organizing a camp out of raw material; but by working overtime and exercising my inventiveness I finally completed a rude but serviceable 7-room cottage, with gas and hot and cold water, and a catamaran. By that time, however, I was entirely out of grub and hungry; so I took my trusty rifle and boarding the naphtha launch I set sail for the low lying, blurly wriggling, distant shore, which was under obligation for enchantment to 7 miles of the worst walking I ever saw. I arrived while the sun was yet an hour high and after tying the canoe to an iron ring in the breakwater, I walked down the railroad track to the first cattle-guard and had the good fortune to observe a large cinnamon elk drinking out of Swartz lake.

Although the distance was upward of 800 yards I took a Lyman rest over a milepost and applying my eye to the telescope, I planked the eland through the lower lobe of the solar plexus. He dropped as if shot.

Simultaneously with the shot I saw through the telescope dark objects fall from a limb on a tree at nearly right angles to where the doe had stood, but a good 80 rods to the West. Grasping my rifle firmly I started across the glassy, frozen surface and, after sticking the splendid buck, I hurried over to where the dum dum had glanced from his horn. I found to my amazement that it had split a limb 63 feet from the ground and shelled out 9 fat coons like peanuts. They were either killed or terribly injured by the fall.

While I was looking at them and thinking how lucky I was that morning, a thin

amber stream began falling into the high grass near the foot of the tree. Glancing aloft to ascertain its genesis I was still further astounded to find that the hard steel ball had, after settling the hash of the coons, drilled a hole into the trunk of the oak and by merest chance tapped a large deposit of wild honey. I needed the honey in my business, but for some time was at a loss to know how I was to save it. Then remembering the water-skins and wine-skins of the East, I muttered as I fumbled for my blade, "B'gosh! Why not honey skins?"

Quickly splitting those 11 coons across the North end and turning them out of their hides, I soon had really serviceable receptacles. I took one in each hand, wading back across the creek, skinned the bear and hung all but the saddle high up, to be taken in the next day.

Since coming to camp I had been so all-fired busy that I had neglected my mending and in my buckskin pants were numerous apertures through which brook trout to the number of 92 had rushed in terror, but found no escape as I waded back and forth carrying my honey and coons. It was an unusual way to catch shad, but there they were, to speak for themselves. Of course you have often heard a pike speak. As it was fast growing dark I hurriedly piled the honey and coons and meat and black bass onto the buffalo hide and grasping it by the tail I started for camp, drawing my load behind me.

It was pitch dark when I arrived. I started to drop the tail, to unload, and it all but slipped out of my hold, as a piece of stretched rubber would. Being incapable of further surprise I calmly tied the tail around a sapling and felt back for the load but it was not there. Back and back I reached, about 20 rods, when it dawned on me that the greenness of the hide, the heavy dew and the large deck-load had caused the buckskin to stretch. I was tired out. It was dark. I threw myself on the sofa and slept until long after sunrise. When I arose, the morning sun had shrunk the hide; and the 13 coons, the 93 perch and the hind quarters of the antelope were before my door.

The next day it rained.

Advt. Try Keely cure for rumatiz of the hair. 3tf.

Bill Damm's daughter, Grace, has scarlatina, and the whole Damm family is quarantined.—Ozark News.

OUTWITTING A MINK.

FRANK FARNER.

I saw his tracks, some feathers and other indications of his having his home beneath a log drift in the bed of a small creek. I could see that he was an old timer for his tracks were extremely large, and that he had lost some toes off one front foot, so I knew he would be wary, hard to catch and well worthy of my steel. I placed a carefully concealed trap some distance from his habitat and baited with the leg of a muskrat, which is a favorite food of the mink's. The next morning the bait was gone and the trap undisturbed. This occurred nightly for 4 consecutive nights and change as I might, he was too cunning. Next I buried the trap in the mud and under water about an inch in depth, and placed the bait so that to reach it from the bank, he would be compelled to pass over the trap. I figured this out with nicety, and felt satisfied I could bid him a cheery good morning the following day. I was there bright and early to do so; but the water had fallen in the creek, the trap was uncovered and I do not know but that mink was peeping at me from under a log and enjoying my discomfort. At any rate, I felt cheap.

The question of his capture became a

serious problem with me. I felt chagrined that a little mink with a head no bigger than a piece of chalk could play me who wear a $7\frac{1}{4}$ hat, and have been told all my life that I am smart. I sat down on the bank and evolved the following plan.

Choosing a spot where the water was about a foot deep, some 6 or 7 feet from the bank, I pushed a cordon of small sticks down into the mud and below the surface of the water in such form that they would hold a chunk of wood, which I had previously selected. I placed the trap on this wood and covered it carefully with mud. I thus had a little floating island with a trap ready for business covering its surface. I then floated a good sized pole and anchored it with stakes in such shape that one end rested on the shore and the other reached within 2 feet of the trap. When the mink reached the end of the pole, the alluring bait I had placed over the trap could only be reached from the island, to which he jumped. The next morning he was in the trap, caught by both front feet and drowned. I had to wear my hat on the back of my head all that day, but the swelling gradually went down.

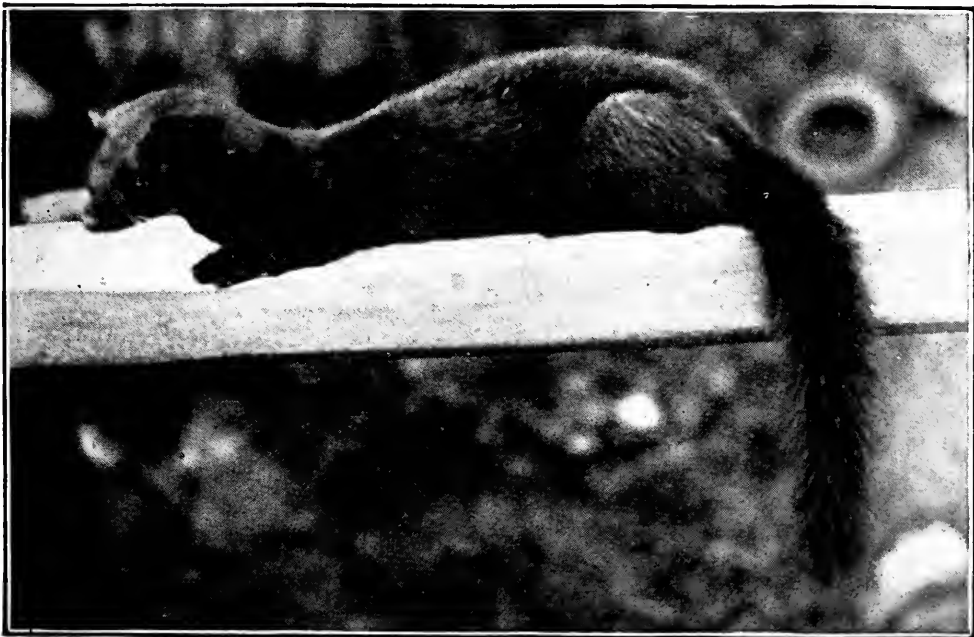

AMATEUR PHOTO BY W. STARK.

MINK. *MUSTELLA AMERICANA*.

Made with Collinear Lens

LOST IN A TAMARACK SWAMP.

W. A. MASON.

The morning of November 11, 1901, opened bright and clear in the Northern part of Beltrami county, Minnesota. We were out early. It was the second day of our stay in our hunting cabin. The day before we had looked over the country surrounding our camp and knew that deer were plentiful, as we had seen 3 bucks and an enormous number of tracks.

We were 4 in our party. We went together for about a mile South, where we

ridge, while Mr. Fuglestad went around on the South side. He had hardly got around before he started a big buck, but there was so much brush he only saw the deer's white tail and did not shoot. The buck crossed within 40 yards of me and I fired at his shoulder. He went down and I called to my friend that I had the deer; but as I looked again he scrambled to his feet. I fired a second shot as quickly as I could, but as I fired he passed a dry birch



AMATEUR PHOTO BY W. A. MASON

THE TREES WERE STANDING SO THICK WE COULD SEE BUT A FEW YARDS AHEAD.

separated, 2 of the boys going East, while Mr. Fuglestad and I went West. I had the only compass and as I seldom get turned around in the woods, I let one of the other boys have it. Mr. Fuglestad and I followed a creek about a half mile, when we came to a big slough. South of that was a long high ridge mostly covered with brush and dead birch trees. Beyond that lay a great tamarack swamp. North of the slough was higher ground and a long belt of Norway pine stretched Northward. We decided to cross over to the ridge, walk up along the West edge of the slough and hunt up through the big pines. In getting to the ridge we found many fresh deer signs. I walked along the top of the

stump and the bullet crashed into that, throwing splinters of wood all over the deer. That frightened him and he turned down the ridge into the tamarack swamp. I fired a third shot as he entered the swamp but missed.

The swamp stretched out as far as we could see, and we knew that unless the deer was badly wounded we would never get him. We examined his tracks and found much blood. We then ate our luncheon and waited a while, thinking he would not go far if not followed immediately. After about an hour we took up his tracks, which led almost straight into the swamp for at least a mile, when he began to go in every direction except out of the swamp.

We found less and less blood and feared that the game was up, but not wishing to leave a wounded deer we kept up the chase. All that time we had not noticed that the sky had become clouded and that it was steadily growing darker. At last it began to snow. We did not know how far we had walked as the deer had gone in every direction. Neither of us had kept track of the directions, and we could not tell by the wind, as it was entirely still. We then realized that we were in one of Minnesota's thickest and darkest swamps without a compass, and it was snowing. The trees stood so thick we could see but a few yards ahead. The snow covered our tracks in a short time, also the dangerous little pools of water that are all through these swamps. Mr. Fuglestad stepped in one of these and the water went up to his knee.

I climbed a big tamarack to see if I could tell where we were, but saw only tamarack in every direction. We took the direction which we thought was most likely to be right and went straight, for about a mile, when I again climbed a tree. That time I thought we were surely getting out of the swamp, as straight ahead about a half mile I saw higher ground and a few aspen trees. We went straight for that bunch but our hopes fell as we came to a little knoll with 3 aspen trees on it! We did not say much, and what we did say would not look well in print. I climbed the largest aspen and looked around, but saw only the brown, slender tamaracks; and as it had almost quit snowing and I was so high, I could see many miles. It was getting late in the afternoon and we knew we were in for the night, at least. We decided to stay where we were until something turned up. We knew that the swamp was over 20 miles across at that place and we must be far into it.

We gathered a big pile of dry wood, to keep a fire burning all night. We had no grub and had seen no game since we entered the swamp. To make things seem even more hideous, wolves began to howl about us. I disliked the idea of roosting with an empty stomach, so took my rifle and wandered about our dismal camp in search of anything with flesh and blood. I was much surprised to find a large flock of ruffed grouse. I soon had 6 down. The little 38-55 cut their heads clear off. We roasted them Indian fashion, plastering them over with mud and baking them in the coals. We ate 2 that night and they tasted exceedingly good. They were a little different from the ordinary ruffed grouse, being smaller, and darker in color.

We both slept some that night by lying close to a small fire. Toward the middle of the night the clouds became a little

lighter and I could see the milky way. I then knew the direction at once, as I knew how the milky way lay at that time, and it was clear that we had gone Southwest.

I did not say anything to my friend about it, but in the morning I said that I smelled the boys and was going straight for camp. Mr. Fuglestad said that he did not smell anything but tamarack and bog. After eating all we wanted of our birds we put the rest in our pockets. Mr. Fuglestad pointed out what he thought must be East and advised that we go that way until we got somewhere. I knew that he pointed Northwest, but did not say so. I only said I smelled the boys and was going to camp, and that if he did not wish to stay in the swamp and be eaten by wolves he would better follow me. I picked up my rifle and started straight East. My friend followed, although he said he knew we were going wrong. We kept on going as fast as we could nearly all that forenoon, when suddenly we came out at about the same place where we had started in the day before. We crossed the slough, which was frozen over, and came into a patch of hard maples.

I had just shot a grouse, not thinking we should see deer at that time. There were many big pine windfalls at that place and as I climbed over one of these I saw a big buck coming directly toward us. I was surprised. We had not walked quietly and I had just fired my rifle; still this deer seemed unaware of our presence. I aimed at his neck and fired, but just at that moment he leaped over a little windfall and the bullet only grazed his back, cutting much hair and making several bad holes in his hide. I had used smokeless powder, the deer had not seen me and he stopped short about 40 feet from me. I put a bullet behind his ear and he was our meat. Mr. Fuglestad had been some distance in the rear and did not see the deer until it was dead.

Our friends had heard the firing and soon met us. They had searched for us all the forenoon and had fired many signal shots, but we had not heard them. Our friends had also shot a deer and had seen a bull moose the day before, but as the season had not opened on moose they did not shoot.

Since that time I have never gone into the big woods without a compass, and I earnestly advise all other sportsmen to carry one when in the woods. We staid in camp about a week longer and got 2 deer apiece, with which we were satisfied.

Deer are numerous in Beltrami county. Many moose are also found there; but a better place for moose is along the Big Fork river in Itasca county. A few caribou are also found, but they are scarce and should not be shot. I am going up again in the fall of 1903. Who will go with me?

AT A RIFLEMAN'S FIRESIDE,

W. H. NELSON.

I have always been an enthusiast regarding the rifle, and have always been glad to meet kindred souls; but it has been reserved to me till now to have one of the most enjoyable experiences of my life.

C. W. Rowland, of Boulder, Colorado, is a devotee of the trigger to whom I point any brother who may come to the mountains for health or pleasure, as one who knows more about a rifle than any other man I ever met, and who not only can tell

its history related, its scores exhibited, and witness its owner's love and tenderness as I have done.

To get just what he wanted, Mr. Rowland first bought a 6½ Ballard, of which he preserved only the action, which thus cost him \$35. Into that he had inserted a .32—40 barrel, bored and rifled on a modern system. It is rifled with a gain twist and outfitted as a muzzle loader, with false muzzle. He has several different

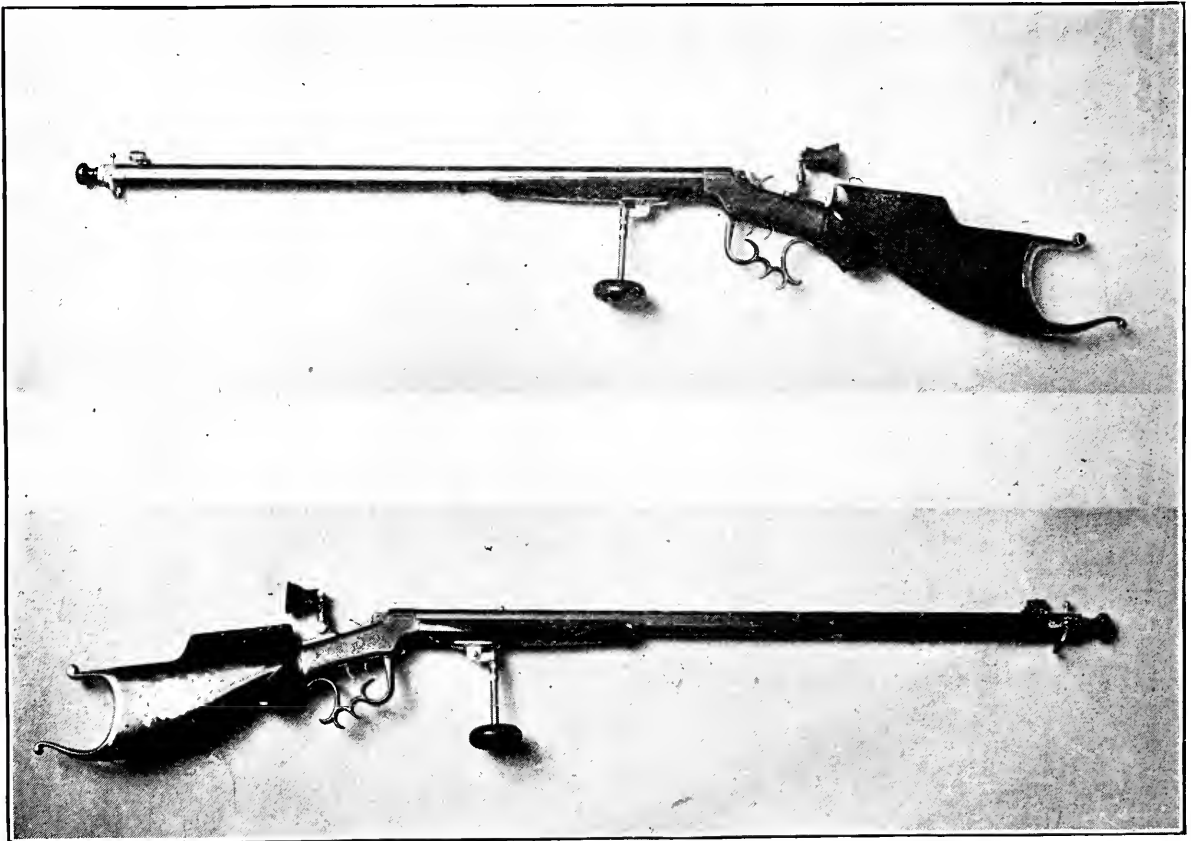

A TREASURED REMINGTON.

it all intelligibly, but who will do it gladly and with such evident interest in both the subject and his auditor as to make one feel that Mr. Rowland is receiving rather than conferring a favor. Mr. Rowland is the owner of the most perfectly appointed weapon possible to the craft, and cares for it with a love and devotion that compensate me for the jeers I have endured because of my tenderness toward my honest old Remington. I send you, herewith, a photograph which shows the piece in 2 aspects, presenting both sides to the view. To get a proper conception of its beauty one must see it, handle it, caress it, peer through its twisted heart, aim at imaginary bull's eyes, have it all explained to him,

styles of levers, but that exhibited in the picture, designed by Mr. Rowland himself, is the one he uses exclusively in doing his best work. The stock is a beautiful piece of walnut, which Nature in an artistic mood had fashioned into a dream in wood. This Mr. Rowland has had ornamented in the manner of the finest old Kentucky rifles, inlaying it with sterling silver, the right side having the old cap box let in. On the top, just where his cheek caresses it, he has put a strip of ebony, which adds much to a beauty already nearly perfect. The rifle is provided with double triggers which act at the lightest touch, yet will not move untouched and which have not the slightest creep. The sights are peep and

globe. The butt piece is the Schuetzen. The palm rest is reversible.

Mr. Rowland has recently received from a gunsmith in Denver, a supplementary barrel which he can put in place of the .32—40. It weighs $8\frac{1}{4}$ pounds, is 30 inches long, the same as the other, octagon, and chambered for the 22 long rifle cartridge.

I send you a number of targets, for which I trust you may find space, believing they will serve a good purpose in showing the student in this delightful field what may be accomplished by an earnest devotee, with a good weapon, properly equipped. The targets marked "Machine Rest," were shot simply for groups without regard to centers, but it seems to me the offhand work is marvelous.

Mr. Rowland has also a rifle built by a gunsmith in Scranton, Pa., which is a beautiful weapon but very heavy. It is intended only for rest work and only a Samson could hold it up offhand through a whole score. It is a muzzle loader, firing with the standard percussion lock. Its bullets are curiosities, however. They must be at least .45 caliber, and each consists of 2 parts, a hood of hardened lead and a core of pure, soft lead. The latter is inserted into the former, and driven home. The explosion drives the core into the hood, expanding it so as to fill the grooves and confine the gas.

Standing in the cabinet beside the rifles is also a beautiful Winchester repeater. In the various drawers and pigeon holes of the cabinet are sights which the owner has devised and tried, globes, apertures, cross hairs, etc. One sight in particular interested me. It was an aperture in which the perforation was conical, with the small end toward the eye, whereas the sides were

dressed conically on reverse lines, the large end toward the eye, the object being to cut off all light except what passed directly from the bull's eye. This idea has been used by manufacturers. The near sight now used on most hunting rifles as they come from the factory, namely, the elevation sight with a slide in it that may be elevated to any point and set with a screw, is Mr. Rowland's invention, but who ever heard of his name with it? It was not patented and the manufacturers used it, of course.

Jay Rowland, 10 years old, is almost as good a shot as his father. He is a most engaging boy, modest and reserved, composed and cool. He is unusually large for his age and when 10 more years shall have ripened his strength and his experience Mr. Rowland will have a rival worthy his steel.

Anyone looking at Mr. Rowland will be surprised to find him 5 feet 10, for he does not seem so tall. Instead of weighing 145 or 155 pounds, which would seem reasonable for his appearance, he pulls down 170. He is 43 years old, but his muscles are steel and his dark eyes have the gleam of the eagle's. A most peculiar thing is his sight. He can read ordinary newspaper type, held so close that the paper touches his nose, but if this be removed farther and farther till it exceed arm's length, he can read just the same without pain or sense of strain. He has chewed tobacco ever since he was 10, but does not feel that it has affected his nerves. That, however, is his only vice. His morals are otherwise an example. Faithful to his duties, busy, unassuming, genial, quiet, reserved, he is the respected citizen, the genial neighbor, the trusted friend, the ideal sovereign of the hearthside.

Gray—They are beginning to have typewriters on the stage.

Black—I know; but it's an affectation. No typewriter that ever was invented can write as rapidly as the average actor with the common, everyday pen.—Exchange.

A FLORIDA KID ON A CAMP HUNT.

CHARLEY APOPKA.

VII.

The nex' day an' the nex' we didn't do much huntin', occasion uv th' doe pa killed makin' us all the meat we wanted, but me an' Mr. Sam went to set th' traps, an' as we wuz a passin' by a grassy pond we hearn a fuss in hit like a big fat man a-laughin' way down in 'is paunch, an' somethin' wuz a-makin' a kimmotion in th' water, an' a-shakin' th' grass. I sez, "What's that, Mr. Sam?" an' he sez, "Ask me an' then guess, but we'll soon find out;" so we slipped down ter th' aidge uv th' pond back uv some grass, an' listened. 'Bout every minute th' ole thing, whatever hit wuz, 'ud make that funny fuss, an' rare round in th' grass an' water, but we couldnen see nothin'. We got tired uv that direckly, so we clim' a couple uv saplin's that growed clost ter th' pond, an' then we could see somethin' a swimmin' round in th' grass an' a-makin' a fuss. Hit wuz shore a dashin' 'bout fast, an' I didn't know what hit were, but Mr. Sam sez, "Hits otters, by grannies, but I never knowed they made that kind uv fuss before. Le's wade out an' seef we kaint git a shot at th' triflin' cusses." We slid down easy an' rolled our britches up far's they'd go, an' went in th' pond mighty quiet. Th' water weren't much over knee deep—but hit shore felt cold a-creepin' up my laigs. We waded out 'mong th' bunches uv grass, an' every other step we'd go in a hole up ter our middles an' slosh 'round, an' we thought shore th' otter 'ud tear out, but hit kep' a swimmin' 'bout th' fastes' I ever seen. Sometimes it 'ud come 'ithin 20 feet uv us, but hit kep' under th' grass an' we never could see hit, 'cept when hit dashed acrost some little open place.

Direckly though hit stopped under some grass right at Mr. Sam, an' he got sight uv hits head an' popped to hit with 'is Winchester. An' when he did we hearn some more tear off in th' pond, but we didn't get ter see 'em. Mr. Sam sez, "Well, by grannies, this ole otter beats my fishin'. I never seen one that brave before." But when we got hit ter land we seen hit wuz a big ole she otter, an' looked like she'd been sucklin' young uns, so we made up our min's hit wuz that what made 'er so spunky. We hung 'er up an' cased 'er an' hit shore is a job an' I woulden fool yer. The hide has ter be took off whole, same as turnin' a sock wrong side out'ards, an' hit took us 'bout an hour.

We took off round th' pond, an' at th' far end, where there wuz a lot uv high palmetter, we seen a lot uv sign leadin' into hit, an' up in there wuz a sort uv mound 'mong th' roots, an' hit wuz more plum smooth,

an' lots uv sign 'round hit. So we went on ter where th' traps wuz hid, an' brought back 4 uv 'em, an' set 'em in th' best places. Then, hit bein' 'bout noon, an' us hungry as maggots, we lef' th' rest uv th' traps fer next day, an' tore out fer camp. We jumped 3 deer on th' way an' th' biggest bunch uv poterges I ever seen. I reckon they wuz 40 in th' bunch.

When we got ter camp, pa 'n Uncle Dick wuz at th' branch a fishin', but they had lef' a skillet uv biscuits an' a pan uv venison steaks by th' fire, an' I set down an' et till I wuz in misery. Pa sez th' ole otter shore had young uns er we never 'ud a seen 'er. He'd hearn 'em make that fuss many a time, but mostly at night. That night we laid round th' fire an' cooked ribs over th' coals, an' they wuz th' best I ever et.

Nex' mornin' pa 'n me et a stack an' lit out 'fore sun up, ter set th' traps, an' look at th' ones me 'n Mr. Sam had set yistiddy. On th' way we seen th' purtiest kind uv a fox, but we didn't git ter shoot 'im. When we got ter th' pond, dinged if we didn't have 2 uv th' purtiest little half grown otters you ever seen. Pa sez he'd a turned 'em loose but one had 'is leg broke, so he give 'em a lick apiece on th' head, an' they never knowed what hit 'em. Their fur wuz th' softest an' finest I ever seen, an' pa sez they'd bring a couple uv dollars apiece. We went on an' set th' traps in likely lookin' places, an' jumped a little buck on th' way. He wuz layin' in a bunch uv palmetter, an' we wuz right on 'im 'fore he knowed hit, an' you'd orter seen 'im tear out. If I could run 's fas' as a deer I woulden' take nothin' fer hit.

As we wuz goin' 'long through th' woods we hearn a curious fuss back uv a bunch uv bushes, like goats a buttin' one 'nother, an' we went ter see, an' what do you reckon hit wuz? Two big ole tortoises wuz a fightin', an' th' way they'd do, they'd git off a little piece, an' run tergether, an' try ter butt one 'nother over, which would shore settle it, fer they kaint turn over when they git on their back. We watched 'em a while, an' then I parted 'em, an' I had ter kick 'em apart, they was so mad.

We had lots uv fun ketchin' perch ter bait th' coon traps. They wuz thick ez wiggletails in a rain barrel an' hit took our best ter quit 'em. There wuz 3 ole whoopin' cranes walkin' 'bout in th' woods a lookin' at us, an' a hollerin' th' loudest I ever seen.

When we got ter camp Uncle Dick an'

Mr. Sam wuz gone, an' they wuz a bunch uv poterges right in camp a pickin' 'round where we fed th' horse. They wuz so purty we never bothered 'em, but they run off when they seen us.

It wuz gittin' to'rds sundown, an' every few minutes we'd hear a gun go er-o-o-m off in th' hammock, an' we knowed Uncle Dick an' Mr. Sam wuz gittin' us a mess uv somethin', so we baked a skillet uv biskits an' buried some pertaters in th' ashes. A little after dark Uncle Dick an' Mr. Sam come in with a mess uv squir'ls all ready cleaned. Mr. Sam rolled 'em in batter an' throwed 'em in th' fry pan, an' in less 'en a short time we wuz a settin' down to hit.

I sailed inter th' squir'ls an' et till pa sez, "stop, son, fer pity sake; you'll kill yoreseff." But look like th' more I et th' better they tasted.

That night, as we laid 'round th' fire, we hearn th' panthers holler ag'in, off in th' swamp, an' pa sez, "I reckon we'll have ter take a day off purty soon an' see 'f we kaint run them varmints down an' git a shot at 'em." Uncle Dick sez they had roosted a bunch uv turkeys in th' aidge uv th' hammock, an me 'n him 'ud git up 'fore sun in th' mornin' an' kill a couple. They got ter tellin' varmint tales then an' some uv 'em wuz plum scary, an' I went ter bed with shivers runnin' down my back.

A 4-LEGGED HORSE THIEF.

I send you herewith a photo of a mountain lion shot in these mountains last fall by a settler living here. The lion jumped the settler's colt, 3 days old. The man fought him off until the colt died. The next morning at daylight the settler laid for the brute and when he returned to feast on the body of the colt the settler sent 2 rifle balls through him. The lion was 6 feet long.

Capt. F. L. Clarke, Fredalba, Cal.

"Yes, ma'am," says the saleslady; "this is the new game of ping-pong-let."

"But it is so little," objects the customer. "It looks like a toy."

"It is quite popular," declares the saleslady. "It is a miniature of the other game, and is especially designed to be played in a flat."—Exchange.

Said Mr. Goodson to his pretty niece, "Do you work for the poor?"

"Indeed I do!" she replied. "I go to every charity ball there is."—Exchange.

Farmer Scudder—I s'pose them New Yorkers are a purty frisky lot o' sports?

Farmer Selleck (just back)—Frisky? Well, say! I didn't get back to my hotel one night till arter 9 o'clock, an' they hadn't got th' doors locked then.—Judge.

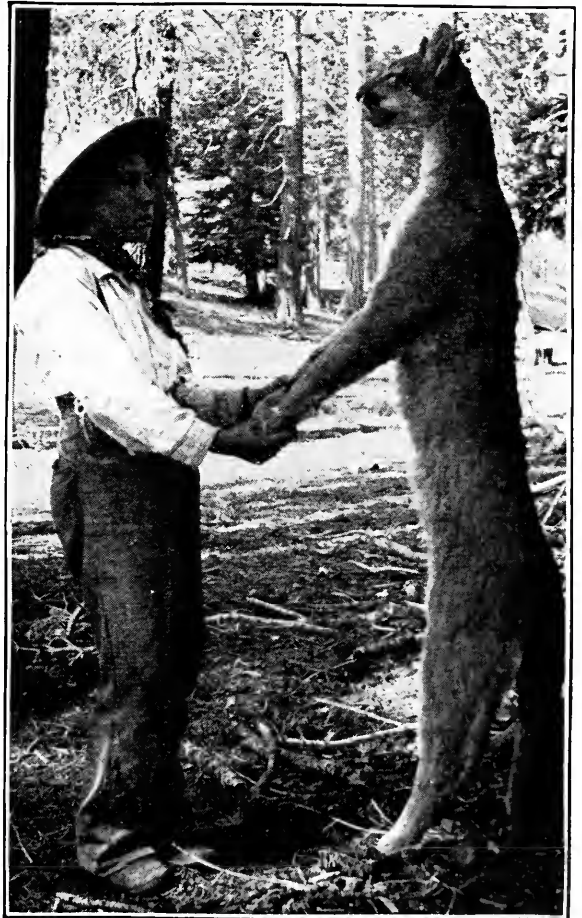

AMATEUR PHOTO BY CAPT. F. L. CLARKE.

PLEASED TO MEET YOU.

MY FIRST ADVENTURE WITH A BUFFALO.

C. B. R., M. D.

In 1869 I had charge of a wagon train on the plains, freighting between Sheridan and Kit Carson, in Western Kansas, to Santa Fe, Fort Union, Las Vegas, Albuquerque and all points in New Mexico and lower Colorado. Sheridan and Kit Carson were then the Western termini of the Kansas Pacific Railroad. I had a light rifle, made by Mr. Ben Mills, of Harrodsburg, Ky., for a long range target gun. It was on the plan of the old Maynard rifle and was a fine shooter. I had killed many deer and antelope with it, but had no experience with buffalo.

On the trip from our home ranch on the La Cimaron Saco (Dry Cimaron), New Mexico, where we had been resting a few weeks, to the railroad terminus, we went across the country in a line from the Dry Cimaron by way of Fort Lyon, Colorado, were caught in a fearful snow storm and had to camp until it passed. It lasted several days and nights, leaving at least 2 feet of snow and still cloudy weather. As a natural consequence, we got lost. For 3 days we wandered around with 16 4 to 6 mule wagons. Every fellow thought he knew the way to Fort Lyon. To make things lively 50 or 60 Indians got after us. They were afraid to charge, as we were about 25 in number and well armed. They would run up toward us, wave their blankets at us, make all kinds of noises and keep us scared out of our senses most of the time. To add to our misery, our provisions gave out. We had nothing for several days but corn meal and coffee; nothing to season our bread, nothing to go in the meal but salt. We were a hungry crowd. Toward evening of the fourth day we saw a little bunch of buffalo about a mile away, and everybody wanted buffalo beef; but no one was brave enough to make the attempt to kill one for fear of the Indians. Fortunately the game was on good ground for a hunter to get near enough for a shot. I, being wagon boss, finally told the men I

would slip around and shoot one if they would come to my assistance in case the Indians attempted to cut me off from the train. All promised, and I knew some of them were brave men, for I had been through Indian scares and races with them before. Arming myself well I started after meat. I got close to the buffalo and selected a large dark one, the dark ones being always the fattest. I made a good shot at a young cow. When the bullet struck her she saw the smoke of my gun and my head and shoulders above a buffalo wallow, and came at me full tilt. I had not time to load my rifle. I held on to it, however, but drew an old Remington .44 cap and ball revolver and shot her in the face several times, jumping around and running toward the wagon every time I had a chance. Finally I made a run, thinking I could beat her through the deep snow, but she got so near me she blew blood from her nostrils all over me. I thought I was gone. I tried to pray, but was so badly scared I could not think what to say. I finally said "Amen," for I thought it was Amen time with me. I yelled "Amen" at every jump until the poor thing came down on her haunches and then rolled over dead. The rifle bullet had gone through her lungs and she ran me until she died from loss of blood. I was so badly scared I did not once think of Indians and could hardly walk, but trudged on slowly toward the wagons that were coming to me. When I met the men they asked me if I were not going to help skin the game. I said:

"No, I have furnished the meat, and I think you can afford to skin and cook it."

Talk of buck ague! Nothing ever made me tremble so much as that buffalo, except a silvertip, a few years later, of which I will write you. That night we had a feast; corn bread made with melted snow and salt, black coffee and fried buffalo meat. Several of the boys ate so much they were sick all night.

TWO CURES.

JOHN L. WOODBURY.

Two prescriptions he got for poor shooting,

From a doctor, wise, and a friend.

"Smoke less," read the doctor's instruction;

"Smokeless" was the other's trend.

MY BIG TROUT.

SENEX.

Last summer I accompanied a party of young men on a fishing excursion, as guide, philosopher and friend. The philosophy and friendship were all right, but at times I suspected the boys were rather sceptical as to the intrinsic value of the guidance. However, they were jolly good fellows, gave me the lightest part of the drudgery, most cheerfully took the hard work on themselves, and were so good natured as to accept my acquaintance with the locality, and experience as a camper, as squaring the account; which was generous of them, and very comforting to me. We camped a fortnight on Snake lake, at the Narrows, something like 100 miles North of Montreal. The greater part of the journey was by rail, but the last 30 miles we drove in wagons along a colonization road through the mountains, arriving at our camping place a short time before dark. The boys had a large army tent, which was at once dining-room and bedroom, while I preferred my little wall tent and solitude. The air was cool and deliciously pure and bracing, and it was a delight simply to exist. The lake was well stocked with grey and spotted trout, the former running up to about 4 pounds weight, and the latter to 2 pounds. They were ready biters, and gamy, and we had no difficulty in keeping the larder well supplied, notwithstanding our prodigious appetites. We had the best luck toward evening, from about an hour's sun till dusk. We had an easy time for some days, but even fishing may become monotonous and we began to wish to catch larger fish. After discussing the question, we concluded that the big fish got up earlier in the morning than we had been accustomed to do, and we determined to surprise them; so instead of going out on the lake as usual toward night we built a huge fire on the shore as it became dark, and turned our attention to catching minnows for the proposed early fishing.

The next morning, as dawn began to show, I turned sleepily out of my blankets, and tried to rouse the boys in the other tent; but sleep was too sweet, and the chances of rare sport were by no means so attractive as the night before. I, therefore, unwillingly set off alone. It was a beautiful morning, the East rosy with the coming dawn, the lake like glass, with here and there little wisps of fog on the surface of the water, while streamers of fog rose from hollows along the sides of the mountains bordering on the lake.

On the East side of the lake, about half a mile from camp, the cliff descended steep-

ly to the shore, and the water a few feet from the edge was 40 feet deep. I determined to try my luck there. The morning was so still that an anchor was unnecessary. Stopping the motion of the boat, I affixed a minnow to the hook and dropped the line into the water. My equipment was of the rudest; a cane rod with the tip broken off, so that the small end was about as thick as my little finger, a fine linen line, a No. 4 hook hung on double gut, and nary a reel. My boat was one of Mullins' "Get There" duck boats. I settled myself comfortably to rest and to enjoy the beautiful morning. Soon a gentle pull at my line drew my attention. Waiting a little to give the fish a chance to pouch the minnow, I gave a quick pull to fix the hook, but found it immovable, and concluded that it had caught in a sunken log, or in a crevice of a rock. I was soon undeceived, for the point of my rod was suddenly and forcibly drawn under water, and I became convinced that something more than an ordinary gray trout was at the end of the line. I put what strain I dared on the line. After a while the fish gave some to the pull, and I recovered my rod, but from the strength he exhibited, I knew I had hold of a heavy fish; so heavy indeed that I had small hope of landing him with so inflexible a rod, and so fine a line. To maintain the connection for a while was all I could expect. The fish next made a dart sideways, but the light boat whirled around like a top and by keeping the line taut I met that movement successfully. His next effort was a dart ahead in a straight line, but the boat followed easily and I kept the point of the rod up. He soon tired of that, and went for the bottom and sulked a while. After a few minutes he responded to the jerking of the line by another rush, darting now this way, now that, and then rushing ahead. Two things were in my favor; the boat was light, facile, yielding almost instantly to each impulse of the fish, whirling quickly or moving ahead as occasion required, and the fish kept at the bottom, thus enabling me to keep the line at right angles to the rod. Had the fish risen and attempted to make off and thus get the line and the rod in a straight line, my hold would have been worthless.

How many times the fish repeated these manœuvres, or how long a time elapsed, I have no idea. I lost all sense of time, forgot all about the lovely morning, forgot camp and breakfast, completely absorbed in the exciting though almost hopeless contest. At last the fish's efforts became sens-

ibly weaker and slower, his rests longer, he yielded to the upward lift of the rod, and I began to think there were some chances for success. Finally he gave enough so that I threw the rod back sufficiently to grasp the line in my hands. I pulled it in slowly, carefully, I may say, tremblingly, foot after foot, expecting every instant that he would make another lunge, but ready to pay out the line if I must. He did not do so, however, contrary to my expectations, and greatly to my relief. Finally I drew him alongside of the boat, leaned over, slipped my left hand into his gills, and with a quick movement drew him into the boat. Then I seized the little hatchet that I always keep under the seat, gave him a tap over the nose, and the prize was mine. I rested and chuckled and hugged myself.

It was a landlocked salmon; not only by far the largest I had ever caught, but the largest I had ever seen. After my excitement had somewhat subsided, thoughts of breakfast began to insinuate themselves, and with them the desire to exhibit my treasure to the boys. I returned to camp, where the big fish was duly admired and conjectures were made as to its weight, for unfortunately the only scales we had were inadequate to the weighing of so large a fish. One of the boys had a pocket rule, however, and the fish proved to be 3 feet 4 inches from tip to tip, 9½ inches in depth from back to belly, and stout in proportion. There was no trouble after that about getting up early to go fishing, and the boys caught some choice large fish; but not one that could quite rival my "big trout."

A PENNSYLVANIA FISH HOG.

Herewith I send a picture of 13 tarpons, the largest catch ever made in one day. This picture was taken at Tarpon, Texas, at the fishing grounds. Mr. J. R. Wainwright has beaten the world's record for a catch and broken the season's record for an individual, having caught 169 tarpons up to this date. Length of fish 5 feet 10 inches to 6 feet 3 inches.

S. Smith, San Antonio, Texas.

gave them away to his friends. He simply fished for a record. He was ambitious to be photographed with the victims of his insatiate thirst for blood. Then the fish would have to be thrown away to rot, or be fed to the 4-legged hogs, which are models of decency as compared with this 2-legged specimen.

It appears that you are a professional photographer; that you make pictures for

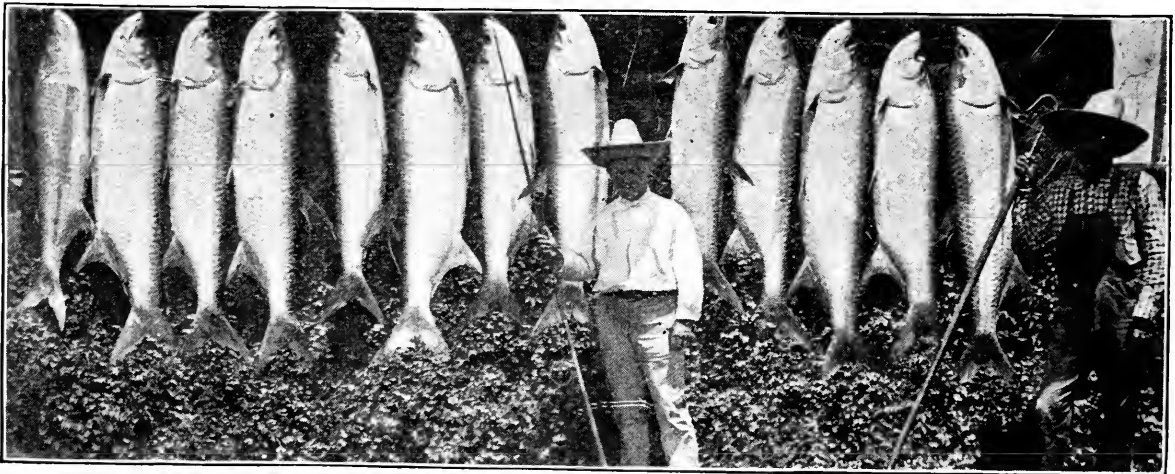

COPYRIGHT BY S. SMITH, 1902.

Here is one of the most revolting cases of slaughter that has come to my notice in many a day. Thirteen fish, which vary in length from 5 feet 10 inches to 6 feet 3 inches. The smallest of these fish would probably weigh 100 pounds, and the largest 150 pounds; so that the lot would aggregate 1,500 to 1,800 pounds. The tarpon is not fit to eat, so the brute who committed this butchery has not the pitiable excuse that many men put up, to the effect that he

money. If I were in your place, I would not prostitute my art to such a despicable specimen of humanity as this man Wainwright, if he should offer me \$1,000 for such a picture. However, since you took the photograph, I regret you did not get a better light on his face, in order that sportsmen might be able to know him by sight in future and shun him as they would a viper.—EDITOR.

FROM THE GAME FIELDS.

The man who quits when he gets enough, with plenty of game still in sight, is a real sportsman.

A NEW HUNTING GROUND.

During the last 6 years I have been living in a country which abounds in game and possesses so many natural advantages as a game country that it is destined to be the greatest shooting ground on the continent. During the years spent here I have participated in many a hunt, the history of which would fill my fellow sportsmen with that malady which compels a man to take to the forest with his gun.

I have had something of a monopoly of this hunting ground. About 3 years ago, while on a prospecting trip, I found a tract of land shut off from the rest of the upper peninsula by an almost endless swamp, known as Munoskong bay, and having a number of high ridges running well out into the lake. On examination I found all the country swarming with deer and small game, and to my knowledge, there had never been another party hunting on the grounds. The bays were alive with ducks. I decided to establish a sort of reservation there, and the following season I planted the bays with wild rice. Last fall there were hundreds of acres of rice, and mallards came there in thousands.

I was late last year in getting to the grounds. I found my guide already there and eager for the hunt. Next morning we arose by daylight and decided to hunt together, one to do the driving and the other to watch the runway, which was a well beaten path. Before going far, I selected a point on which to wait and started the guide on his course. I had not been waiting more than half an hour when I heard a twig crack, and looking down the runway I saw a large doe coming straight toward me. I incautiously raised my rifle too hurriedly. She bounded from the runway and stopped squarely behind a large pine stump, leaving exposed only the top of her spinal column. I fancied I could kill her and took careful aim at her spine. When I pulled the trigger, the doe leaped into the air, and with one bound was in thick timber, causing me to lose a second chance. She had not gone more than 10 rods before I heard the crack of my guide's .30-30 and going over to help him I found he had taken only a chance snap shot at my doe, as she was going 40 miles an hour through the bush. On going back to where I had shot, we found a few drops of blood, and decided to follow the doe, but after traveling about 2 miles, we gave up the chase.

We then went along the river bank a

short distance and came on the fresh tracks of a large buck, which had swum the river. I went around to cut off his advance on a runway crossing, and left the guide to follow the runway. I waited a short time and along came the buck, on the bound. I opened fire, breaking a front leg at the first shot. He seemed to go faster than ever. I fired a second time and on going to where he had been standing, I found a large piece of bone. He went straight ahead. I followed him 2 miles, and he again crossed the river. As it was too deep for me to cross, I had to go a mile up stream to get my boat. On getting around to where he had crossed, I jumped him within 40 feet of the river bank and killed him with a 38-55, through the head. I was somewhat surprised to find on examining him that my second shot had cut the bone of the other fore leg, nearly in the middle. The bullet had carried away a piece of the bone. The deer had run 2 miles with only half of the bone of one fore leg, the other being completely broken. He was a magnificent fellow, and his hide and horns now adorn my study. This was only one of the many adventures of our hunt, which lasted several days.

Next season, I shall spend my holiday there and should be more than pleased to have the company of a few good companions. My camp is commodious and is free to friends. The ground is so located that a number of sportsmen can be placed to advantage; and any who would care to visit a country where hunters have not despoiled the game may go with me and enjoy a glorious hunt. Of course the accommodations are limited, but I like the society of true sportsmen, and will gladly share with a few good men, not of the game hog family.

J. A. Cameron, M. D., Pickford, Mich.

HOW TO MAKE A BEAR TRAP

COL. W. H. ROOT.

Many people suppose that hunting bears is dangerous work, but as a matter of fact it is the safest of all pastimes. Of course, amateur hunters who do not understand the nature of the beast sometimes attack a bear at close quarters and get the worst of the fight, but the professional hunter works in a different manner. All professional bear hunters use traps. The bear is first caught in a trap and then killed. The bear is a stupid, cowardly animal, and if given an opportunity it invariably runs from a

man. In many ways it resembles a hog. It likes to wallow in mud and filth. If sufficient food is at hand it will eat until it falls down in a stupor. It is omnivorous, and its food consists of whatever it can find. In summer it lives on roots and berries. At other seasons it preys on cattle, sheep, pigs, poultry or other animals. Often it eats carcasses.

Some years ago I was trying to fill an order for several pine martens. A prospector named "Charcoal" Brown lived in a cabin on Douglas creek, near Laramie, Wyoming, and I went out there hoping to trap a few martens in that vicinity. One day, while Charcoal and I were away from the cabin, a bear broke in and created havoc with our provisions. He ripped open the sack of flour in the middle of the floor and then smashed open the keg of molasses on top of the flour. After eating his fill of this mixture he wallowed in the remainder. Then he lay down on Charcoal's bed and went to sleep.

It was just getting dark when Charcoal and I returned. Charcoal, noticing that the door of the cabin was open, said,

"That old bum, Dirty Pete, has been up here helpin' hisself to our grub agin."

He stepped inside and called out, "Yes, an' the old sot's drunk an' snorin' on my bed. I'll poke him out with a shovel handle."

An instant later I heard a commotion and a yell from Charcoal. The bear ran against him and knocked him into the puddle of flour and molasses as it rushed for the door.

That bear gave us considerable trouble that fall. About once a week he would break into the cabin while we were away and ruin our provisions. Among other valuable assets Charcoal had an 8 gallon beer keg which had been left there by some expert who had come out to look at the mine. I knocked the top out of this keg and drove a number of sharpened spikes through the sides, slanting downward. Then I poured about a quart of molasses into the keg and set it in a place where the bear would find it.

That evening as Charcoal and I were sitting in front of the cabin we saw Mr. Bear up on the hill, sniffing the air with his nose pointed toward the keg. He had smelled the molasses, and there is nothing a bear likes better than molasses. He did not see us and we sat still and waited for results. He walked in a line for the keg, sniffing and licking his chops as he went. When he reached the keg he plunged his head in after the molasses without making any investigation. Charcoal shouted and the bear attempted to withdraw his head, but the spikes caught him. First he stood on his hind feet and struck the keg with

his paws and squealed. Then he tried to back out of the keg. Then he started to run. He plunged squarely against a tree and forced the keg farther over his head. Charcoal ran to the place and began beating the bear with a long handled shovel, shouting between strokes,

"Ye will git in my bed, will ye?"

One badly aimed blow knocked the keg off the bear's head. Charcoal ran one way and the bear the other.

Charcoal afterward caught a number of bears with that trap. Nowadays these beer-keg traps are used all over the Western country. Perhaps a third of the bears killed are captured in beer-keg traps. I invented the trap as a matter of necessity, but at that time I did not think it would prove so popular.

ADVICE TO YOUNG SPORTSMEN.

O. L. B.

If you wish to be a successful hunter, never marry. True, a wife can be got for \$2.50, while a good setter pup costs \$20 to \$25; but, generally speaking, the pup is much the more valuable of the 2 animals. To be sure, the pup may be taken with rabies, and bite you; but he won't make your life miserable if you happen to wink at a pretty girl, and he won't nag you if you should not turn out to be a nickel plated, ball-bearing saint. Heaven protect and prosper the pups.

A wife may object to washing the dishes, but your dog will be only too glad of the chance to perform this necessary household labor. About every so often your wife would want a "perfect dream of a hat," and would pull down the heavens if you didn't hand over the necessary dough; while for the price of this "dream" you could buy 40 loaded shells which the pup would gladly help you use. Your dog would never ask for a hat, but would contentedly gulp down hunks of liver, and cold potatoes, and look on you as a model of generosity for giving them to him.

A dog is great company. A wife, too, might be fair company if she had the time, but as most of a woman's life is spent in combing her hair and in studying the fashion plates, the married man must go to his club when he wants company, or sit on the back stoop and cultivate the sociability of his neighbors' chickens.

A wife is no good as an exhibit in class A. You can't call in your friends to note her good points; she would get hot too quick if you should do that. You can't, as you artistically distribute tobacco juice over the stove, tell how she snapped up a rabbit before it had made 2 jumps, after you had driven the unfortunate bunny out of its burrow, with a ferret. Special advice: Never use a ferret. The man who

would hunt rabbits with a ferret would steal onions out of a blind huckster's cart, and would save his chews of tobacco for use a second time. No one but an all around sneak will ever use a ferret.

Do you suppose for a moment that your wife would sleep in the yard and not kick about it? Do you think she would work patiently for you in the woods or fields all day, and then expect nothing from you for her devotion but a few kicks in the ribs? Can you believe she would stand by you and love you above all others, even though you should become a ragged, beery sot, shunned by all mankind? Certainly not. Yet a dog will do all this, and will, apparently, extract some happiness from life. In a word, there is but one advantage which a wife could possibly possess over a dog, and that is, she might not have quite so many fleas.

Finally, do not be a game hog. There may exist lower beings than game and fish hogs, but if so, they have not yet been found and classified. You can, of course, derive much joy and satisfaction from catching a ton of fish or shooting 700 ducks, and then, standing behind your trophies, have an amateur camera fiend photograph the whole outfit; but your happiness is likely to be short lived, for the pictures may fall into the hands of a man who makes it his business to wallop human swine. As this chap is backed by several hundred thousands of good sportsmen, he rather has the bulge on the game hogs. As long as he and RECREATION exist, and I trust they will hold on for some time yet, hunters would better sail shy of the hog business. It doesn't pay a man to have the whole race of true sportsmen sit down on him and squash him so flat that even his dog would fail to recognize him.

But don't get a wife. Stick to the setter pup, and let the other fellow have the wife. If you should ever get tired of the dog you can easily find all the wives you want, for the supply is always greater than the demand; but you would better hold to the dog, even though he should be possessed of more fleas than are really necessary.

A DEER HUNT IN PUGET SOUND.

UNCLE JOE.

In October last a party of 12, comprising gentlemen from Norway, England, New York and Tennessee, and some native Washingtonians, embarked at Edison on the schooner Fram. We were bound for Schley inlet on Dewey island, one of Puget Sound archipelago.

The trip was made partly in pursuit of venison and partly for recreation; and, of course, we took RECREATION with us. Nothing of interest occurred during the

voyage, save when Neptune exacted tribute from 2 of our party. They paid conscientiously, keeping nothing back. We arrived safe at our destination, unloaded our duffle, pitched our tents and built a great log fire.

After supper an election of officers for the campaign was held. It resulted as follows: F. Flemmings, captain; D. Arcy, lieutenant; Watkinson, orator and supe; H. Stump, secretary; C. Taylor, treasurer; J. Kerr and A. Jackson, vocalists; J. Martin, star gazer and taker of altitudes. Your Uncle Joe was favored with a multiplicity of offices, being elected commissary, physician and historian.

Monday morning, directly after breakfast, Captain Flemmings issued orders for the day. The commissary gave notice that a little venison would add variety to the bill of fare. Vocalist Jackman took the hint and brought in a deer, thus securing the medal for first blood.

The tally for Tuesday was 2 deer, some misses (the compositor is warned that if he fails to use a lower case "m" the club will sue him for libel) and many "ifs."

Wednesday brought us a variety of game; one deer, a brace of grouse and a coon. The gentlemen from Tennessee were in favor of roasting the coon. During the roasting process the dogs one by one retired from the vicinity of the fire to a distance exactly proportioned to their individual keenness of scent. We all had severe colds and for awhile could not account for the discourteous withdrawal of our canine friends. Subsequent developments convinced us that our coon had for a long time been dieting on decayed salmon and Limburger cheese. The fact was palpable; no combination of condiments would hide it. That roast was condemned by an extemporaneous board of health; and we took it away and buried it in the trackless forest, where murmuring cedars shall ever sentinel its lonely grave. Then, with what appetities we could, we returned to our *entremets*.

The following day a large buck returned with us to camp, causing unstinted comment and comparison. Friday we surprised ourselves by killing 2 deer and spent the evening singing "O deer, what can the matter be?"

No venison on Saturday; nothing but disappointment and cuss words. Thereupon we voted to go home the next morning; but morning brought no wind, so we were forced to put in another day hunting. One of our members, of eccentric disposition, left his gun in camp, and, armed with a handsaw, went in search of laurel or madrone canes, and a nice bit of ironwood to send Coquina to make a new handle

for that sticking fork. When a man has no gun he is sure to meet with something gunable. That is what happened to our friend. He came face to face with a large deer; one looked silly and the other simple. It wasn't the deer that looked silly.

THEN AND NOW.

Nearly 25 years ago I made my first trip across the Continental Divide, near Tennessee pass, which is now in Eagle county, Colorado. Descending the Eagle river I was amazed at the quantity of game of various kinds. In those days it was nothing unusual to see 500 to 1,000 deer in a few hours' travel, and they were as tame as sheep in a clover field.

Mountain sheep and elk were also abundant and many a fine specimen fell to my rifle. There were also many cinnamon, black and silvertip bears, and mountain lions, lynx and bobcats, galore. The mountains were covered with grouse; in early days we seldom killed one, as large game was so abundant. In this country the grouse always go up near timber line to winter, coming down in early spring to nest. They start up about November 1st and generally follow the high ridges. I have seen them, in hot dry weather, picking drops of dew from the leaves and blades of grass; I have also noticed them drinking from springs and brooks. A grouse can go a long time without water. He will spend the entire winter, which here lasts 4 or 5 months, near timber line, where there is no water, nor is there vegetation of any kind, except large pine trees; the ground being covered by 15 to 40 feet of snow. I suppose the birds must eat snow in place of water and find something on the pines for food. They are as fat and plump in winter and early spring as in summer.

The game in this country was a great blessing to the early settlers; salt meat was a luxury. I have been almost famished for bacon or ham; no one can really appreciate salt meat, until he has lived 6 or 8 months on straight venison. In those days we packed everything in here either on our own backs or the backs of pack jacks, or, perhaps, horses.

We began to raise vegetables about 16 years ago; now we have some fine farms, well stocked, well watered and with everything modern. We have a railroad now, and on the tract of land where I have seen game so abundant, and where I planted a pre-emption stake, 25 years ago, now stands the thriving little town of Minturn, which I later on staked out as a town site. The game has gone, the locomotive has come and with it came a class of people who would shoot at a deer as long as they

could see it and then set the dogs after it and chase it clear out of the country.

Hounds could be heard in every direction until the game was practically gone. There still remain a few deer, bear, some grouse and occasionally an elk or a mountain sheep in this vicinity, but if an unlucky beast pokes his head over the ridge in sight of town the residents are up and after him in hot pursuit.

The game law seems a dead letter, but I predict the time is drawing near when the slaughter of game will no longer be tolerated by law abiding people. The L. A. S., of which I am a member, was only recently organized here and through its influence, I trust, the game may find rest and protection.

George G. Booco, Minturn, Colo.

THE OTHER SIDE.

J. C. WATSON.

Perhaps you do not realize the great benefit we, the so called lower animals, have received from that wonderful discovery, "The Transference of Thought." At the beginning of the century we had a secret conclave where each had a voice and our rights and wrongs were discussed. By unanimous vote it was resolved to present our cause before the League of American Sportsmen for a hearing. The undersigned were requested to present it.

Great credit was given the L. A. S. for the passage of the Lacey bill. There have been other laws passed that were good as far as they went; for instance, the one forbidding the jacking or hounding of deer for 5 years. But, Mr. Editor, what would you think of a law to protect you and your family for 5 years and then give you over to the tender mercy of thugs and robbers, with no redress whatever? Another law is that no person shall kill more than 2 deer in any one season. How many do you think of the 67 guides listed in RECREATION pretend to obey that law? Do not 75 per cent. of them kill 4 or more?

The State claims to own all game within its boundary lines. If that be true, each citizen owns an equal share of all kinds of game, and his rights should be respected, whether he be a poor man or a millionaire. A man in Florida writes that 2 millionaires (we assume they call themselves sportsmen) have bought immense tracts of marsh land and have posted notices of no trespassing thereon in order that they may themselves be able to shoot ducks by the thousand. Whose game are they killing? Does all game on those tracts belong to 2 game hogs? If all game on a tract of land belongs to the man who owns the land, why is a law made to prevent him from killing but 2 deer each season? If these ducks are not owned by these millionaires

why not stop them from killing more than their share of the State's ducks?

Another question came up. Our enemies, the bear, panther and mountain lion, do not hire professional guides, neither do they give information from Dan to Beer-sheba as to where we live, as do all the sportmen's papers. We think we claim nothing more than is fair when we ask that each person who comes after game shall get it himself, without help from guides. Put yourself in our place for a while. We have many enemies that destroy us, but our most deadly enemy is man. Though armed with a weapon with which he can kill us at a great distance, he is not content with that; but must get a specialist and pay him big wages to lead him to our homes. Do you call that fair play? And then when the tenderfoot shoots at us and misses, what does the guide do? He shoots us for keeps. Shame on him!

Now, Mr. Editor, we should like to know what your readers have to say regarding these matters; also, what you think would be fair and just, supposing we changed places for 5 years?

Buck Deer,
Wood Duck.

ONLY A MATTER OF TASTE.

I call your attention to the enclosed clipping from the Mail and Express supplement. Besides the awful slaughter of these pheasants, I notice, with much amusement the shooting rigs, etc., of Webb's crowd. Some resemble explorers, others the villain in the show, and I want you to get on to the chap in the rear, who is holding his gun upside down.

It seems as if it was up to you to start a female department in your pen. You might get some candidates from this bunch. Can't you roast 'em?

J. F. Case, New York City.

The clipping to which Mr. Case refers shows the picture of a hunting party at Dr. Seward Webb's Shelburne Farms, and the pheasants bagged in one day. On receipt of Mr. Case's letter I replied:

Dr. Seward Webb has raised a lot of tame pheasants, and has the same right to go into his fields, or even on his open ground, and kill them that he would have to kill his chickens, ducks, geese or turkeys. Any farmer may go into his barnyard and kill a dozen or 100 or 1,000 domestic fowls without making a hog of himself. So Dr. Webb and his friends may kill his whole batch of tame pheasants in one day or in one hour if they see fit, and no one else has a right to kick. In my judgment, the farmer I have mentioned would be having just as much fun as these people did shooting pheasants; but different people look at

things with different eyes. My work is in trying to save the wild birds and animals from slaughter, and it keeps me busy.

To this letter Mr. Case replied:

Even though Doctor Webb raised those birds himself and slaughtered them on his own farm, the pheasant is strictly a game bird and should always be treated as such, whether domesticated or wild. When any one slaughters pheasants, whether he be a market hunter or an individual like Doctor Webb, something should be said in behalf of the birds. Many persons who see the photo we have reference to will argue that if Doctor Webb has the right to kill his own birds in any way and to any number so may they, who are not fortunate enough to have their own farm, slaughter, with equal right, pheasants, whether wild or not. I do not strictly mean that Doctor Webb should be roasted, but it seems to me that something said about this matter in RECREATION could not fail to do good. For instance, Doctor Webb has the right and power to slaughter his own pheasants, but how much more noble it would have been on his part if he had taken this 100 or so shown in the photo and stocked some bit of public woods with them. Perhaps he has never thought of this, but possibly a word would open his eyes. I am not the only man who thinks this way, and am speaking directly for at least a dozen other sportsmen in this city.

J. F. Case, New York City.

ADIRONDACK LAW BREAKERS.

I have recently been investigating violations of the State game laws, and trying to prevent the killing of deer with dogs by making charges to the State game commission against parties who use hounds. I have come to the conclusion that what is needed is for the L. A. S. to appoint some one person to take charge of the matter, and for each member of the League to report any facts, that can be supported by affidavits, where there has been a violation of the law which has been reported to the commission, and in which there was no investigation by the commission. That there are many such cases I am convinced, but for one person to gather them into form is impossible. I tried to do it, but soon found that I could accomplish little alone. I found some members of the League reluctant to reply to my letters, and one member, who is also a warden, failed to reply. Whoever opposes the commission will find it difficult, unless strongly supported by corroborative evidence and aided by other sportsmen. That there is great need of some members of the commission being removed is apparent to anyone conversant with the workings of that body.

The expenses of such an investigation must be met by the League, and a fund should be set apart for that purpose. If some member living in or near Albany would take up this work we might expect results that would give satisfaction to all. Having read the articles on the subject in August and November RECREATION, I am sure that only such a course will overthrow the combine, which is as corrupt as the police force of New York City; and it will take energy and positive conviction of the right of the matter to do it.

We shall soon see reports from the commission telling how many deer have been shot during the open season, and how numerous they are; but if there is such a remarkable increase as they report, why do they advocate shortening the hunting season? There seems to be a studied effort to deceive the public in regard to the work of the commission, and if any man can get any information from their reports I should like to hear from him. There is no attempt to show who has been complained of, who has been fined, the places where violations are most common, or many other things that an honest report should show. Men often outlive their usefulness, and there seem to be some of that class in our game commission. Let the League take hold of the matter with spirit and we will have a commission that is a credit to our State.

A. D. E., North Granville, N. Y.

AN EXPENSIVE QUAIL HUNT.

One Sunday morning Sid and I called our dogs and, shouldering our guns, started for an old millet field where we knew we could find quails in plenty. We spent several hours walking around behind the dogs, but they could find no trace of birds. Finally Sid's pointer stopped almost under my feet and made one of the prettiest points I ever saw. The other dogs were not far behind and backed him up like veterans. I walked in and kicked the birds up. A covey of at least 50 scattered in all directions. I turned loose with my double gun and got 2 with my first barrel and one with the second. Sid did a little better. He had a pump gun and being a good shot knocked out 5. The birds scattered so we could find only 2 more. Those we got and being tired we started for home.

On the way a big farmer walked up, grabbed my arm and said, "Gimme yer gun." I could not see it that way and took pains to tell him so, whereupon he pulled out an old horse pistol and stuck it in my face. I realized then that to argue would make matters worse, so handed over my beloved gun. He then went through my pockets and took possession of my 4 birds, explaining that he was a county po-

liceman and as we had been hunting on Sunday we must take the consequences. Then he gathered in Sid, who submitted gracefully. We were taken to Louisville and put in the county jail. We soon got some one to go our bond and had the case set for Monday. Early Monday morning we were sitting in the court room and County Judge Jas. Gregory was looking down on us, over his glasses. After asking us a few questions he imposed the small fine of \$5 and costs for each offense, and each bird we had was a separate offense. I got off with \$25, but poor Sid had to give \$35 for knowing how to shoot a little better than I. It was the first intimation we had had that Kentucky has a law against Sunday hunting. You can bet we'll hunt on week days after this.

R. L. Lukenbile, Louisville, Ky.

CARATUNK NOTES.

October 15 I went to Moxy pond with W. Bodwell, C. Bodwell and L. Wilcox, of Sanford, Me. They killed 2 bull moose and 5 deer. I went, October 27, to my camp on Squaretown, with R. Jarman, of Brooklyn. He killed 2 bucks. One dressed 180 pounds, the other 270. A few days later he got a bull moose which dressed 800 pounds.

On these 2 trips we started 30 moose; they never were so numerous in this section before.

C. Bodwell and his son, Verna, of Sanford, Me., went into my camp on Squaretown, November 12. The next day Verna, who is only 14 years old, killed a large bull moose within 2 miles of camp. He also got a buck. A few days later 2 friends of Mr. Bodwell, from Boston, joined us at camp. They got 3 deer, one a buck that dressed 216 pounds.

The 20th W. Davis, of Manchester, N. H., and E. Goodwin and B. Paige, of Antrim, N. H., came to camp. The third day after his arrival Mr. Davis killed a bull moose within 3 miles of camp. He also shot a deer. Mr. Goodwin secured a buck and Mr. Paige 2 bucks.

The last 3 days of the season I spent trying to show A. Donigan, of Bingham, Me., a moose. We saw nothing but small bulls and cows and calves until late on the afternoon of November 30. Then we found a yard of large moose but did not have time to hunt them. I went to Pierce Pond, 13 miles from Caratunk, December 11 with N. McQuillan and F. Pooler, of Skowhegan, Me. They shot 4 bucks in one day.

During the hunting season of 1900, 9 sportsmen whom I guided, killed, in the vicinity of Caratunk, between October 8 and November 27, 16 deer and 3 moose. Deer and moose are every year becoming

more abundant here. All guides in this region hope the game laws will remain unchanged.

Geo. C. Jones, Reg. Guide, Caratunk, Me.

CALIFORNIA TO BLAME.

Enclosed you will find a clipping from a local paper, giving an account of a duck hunt that surpasses anything of its kind as a wholesale slaughter:

There was a hunt at lower Otay reservoir today, the following 9 hunters, Dr. J. B. Starkey, George Nolan, Dr. H. W. Taylor, F. Keissig, Mr. Essen, James Scripps, Dr. Frazer, Henry Seebolt and E. S. Babcock, composing the party. The hunt began at 9 o'clock. The first round before noon brought down 1,200 birds, and the second round in the afternoon added 800 more to the score, making a total of 2,000 for the day.

Something ought to be done to prevent such another day's shooting. That 9 men, in one day, could be guilty of killing 2,000 ducks, which makes an average of 222 to a man, is almost beyond believing. All sportsmen should demand and see that the law protecting game is enforced. It is a shame to manhood that anyone could commit such a crime, for such it certainly is. Knowing that your magazine takes hold of such cases in the right way, I send the clipping that you may do with it as you see fit and help to get justice done. There is a law and I believe such lawbreakers should suffer the extreme penalty.

W. F. Klages, Los Angeles, Cal.

ANSWER.

These annual butchering matches of Babcock and his fellow razorbacks have aroused the indignation of thousands of decent men everywhere, yet the sportsmen of California, who are directly interested, stand idly by and allow the slaughter to go on without recourse to the law. California has on her statute books a law limiting the number of ducks which any man may kill in a day to 50. The Babcock herd usually plead exemption from this statute by claiming that most of the birds they kill are mud hens and that these are not ducks; yet if the game wardens of that State would do their duty they would no doubt be able to convict some of these ornery brutes of killing more than 50 real ducks each in a day.—EDITOR.

PLEASE WRITE HIM.

I have seen a great many letters concerning game hogs in your paper. Many of them are unjust. If a man has the true sporting spirit and wishes to make a good bag during his vacation, is there any need of your making his exploits notorious?

I did a little hunting last fall and I am not ashamed to tell of it. I went down to Wareham on a 2 days' trip with a good

supply of ammunition, but I did not expect to have such good success. I bagged 133 ducks, also many smaller birds, the exact number of which I do not recall. I do not say this to boast, and I hope you will not take it as such; but just to show you I am not ashamed to back up my opinion as to your injustice to so called game hogs. I assure you I do not object to having this published if you think it worthy of notice. I should like to read your answer in RECREATION; or, if you dare not print a letter in opposition to your views, address your reply to

James R. Cohenstein, Boston, Mass.

You are different from some of the other swine from whom I have heard. In fact I have heard from some thousands of men who say they had slaughtered game for years and knew no better, but that they are now ashamed of it and will never do it again. You seem to be beyond the reach of any appeal, even to your better sense, if you have any. I have printed hundreds of letters from decent sportsmen, expressing their condemnation of just such butchery as you confess to having committed. Still you affect to believe that I am alone in my views regarding slaughter of game. In order to convince you, if possible, that I am not, I now request a few hundred readers of RECREATION to write you direct and tell you what they think of a man who kills 133 ducks and a lot of other birds in 2 days and in these times of scarcity of game.—EDITOR.

RANCHERS MAY BE TRUSTED.

After a steady diet on "sow-belly," beans and flapjacks, when a man hasn't had a mouthful of fresh meat in his house for weeks, he and his family craving it, and then refuses to shoot at a doe or a fawn, it seems to me that the future of our deer is in safe hands. That is the example I had on a recent trip up in Routt county, Colorado. I saw lots of deer, and when on little trips from our camp on Troutt creek, near Pinnacle, with ranchers living near there, we had several opportunities each day at does or fawns, but the ranchers paid no more attention to them than if they had been a cow and a calf strayed from a neighbor's bunch of cattle. To a tenderfoot this seemed little short of heroic. All the inhabitants I met in that country frown on anyone guilty of killing a doe or a fawn. This sentiment among them goes much farther toward preserving the game than any law that could be enacted, and it is not with those men the result of any fear of the law. The campers who swarm the best hunting grounds quickly become aware of this sentiment, and they fear the ranchers much

more than they do game wardens. I do not mean to speak disparagingly of our game laws nor of the brave men who are employed to enforce them. Every one of our provisions for the preservation of our game and fish is, as far as it goes, wise and good; but every man feels that he would rather have the respect of his fellows than the mere satisfaction of not being a law breaker. If this feeling is prevalent among ranchers throughout the country, as it certainly exists in the Northwestern part of Colorado, and is fostered and strengthened, is it not the most likely solution of the future of our game? The slaughter of game can not be laid at the door of the rancher.

John M. Fairfield, Denver, Colo.

A GRINGO IN MEXICO.

Since using the Savage rifle I am more than pleased with it. It shoots well, and with little recoil. There is only one thing I can find fault with. The Savage Arms Co. recommends the miniature bullet for 100 yards, but I find it worthless beyond 25 yards. All our miniatures were loaded by the Winchester people for the Savage rifle. It may be they are not the same as the cartridge furnished by the S. A. Co. The soft nose and the full jacketed are all any sportsmen could desire.

The other morning the Indians who were working in the pit came to my tent, calling "Mucho venado." Grabbing my Savage, I followed their direction and saw 2 deer across the river on a hillside fully 600 yards distant. This was a chance I had been looking for; and I confess that my respiration, temperature and pulse were such that I should have been rejected for insurance if examined at that time.

My rifle is fitted with an ivory front sight and open rear sight.

The first deer was dropped with a full jacketed bullet through the shoulder; and the other, with a soft nose through the head. The latter showed its expanding or explosive effect when we found the skull nearly cleared of brains and 4 holes blown through its roof.

Our deer are small, weighing 100 to 150 pounds, and on account of their color are difficult to see at this time of year. They are plentiful and are never shot at except by "Gringos."

There are also a few wild hogs, which are hard to find, difficult to shoot, and dangerous to tackle when brought to bay. They are good eating. The woods and fields are full of Mexican quails, with russet topknots on their heads. They are exceedingly tame and will often run along a trail in front of my horse 50 yards before rising.

Enrique, Alamos, Sonora, Mexico.

OHIO LAW SHOULD BE CHANGED.

We are enforcing the game and fish laws out here to the best of our ability with the limited means we have. If our last Legislature had given us a gun license law we should have had money enough to pay 2 wardens in each county, and then we could have enforced the laws. As it is, our wardens have to be satisfied with the fees in each case, and the fine if a conviction is secured. The whole system is wrong in principle. Wardens should have a fixed salary in addition to fees and fines collected. We hope to secure the passage of a gun or hunting license law at the next meeting of our Legislature, and then we will not have to seek men to take wardenships, but good men will seek the position. Our sportsmen wish such a law. The only opposition comes from the farmers, and we think they stand in their own light. They are willing, in fact anxious, for the State to do police duty for them, enforce the trespass law, arrest every person hunting without a written permit, etc.; but when it comes to paying a gun tax of \$1 or a license fee of \$1 when they wish to hunt on land other than their own, they have not so far been willing to put up the dollar to aid in securing the enforcement of the laws they so much desire. The game commission and the chief warden are doing everything in their power to secure the sympathy and co-operation of our farmer friends in this good cause, and we trust our efforts may not be in vain; so that when our law makers next meet we can go before them united in our aims and purposes to secure the best fish and game laws possible, with ways and means of enforcing them. RECREATION has a large circulation in our State, and has done much good in the cause of fish and game protection. We are thankful for your aid in the past, and ask a continuance of it.

D. W. Greene, Dayton, Ohio.

SHOW YOUR MONEY.

Along our Virginia coast there are 8 or 10 Northern shooting clubs which have bought all the beaches, meadows and shooting points. Each of these clubs has 15 to 30 members who shoot and hunt, so 250 or more shooters come down here every May and shoot our shore creek birds. They have been at this for the last 10 or 12 years, and have so depleted the birds that our game association will, at the next session of our Legislature, stop spring shooting on these birds. We ask the aid of the L. A. S. to stop this spring shooting in Maryland, Delaware and New Jersey. If this is not done, our curlew, willet, gray-back, robin, snipe, plover, etc., will soon be things of the past. I trust L. A. S. divisions in these States will take up the matter and push it as fast as possible. Our

game association will take care of the Virginia counties, but much of the spring slaughter is done in Delaware and New Jersey meadows bordering on the seacoast.

Henry E. Byrd, Temperanceville, Va.

Why don't you and all other good sportsmen in Virginia join this League? It is strange that you should call on us for aid in amending your game laws when only a handful of sportsmen in Virginia belong to the League. I have spent hundreds of dollars of my own money in trying to induce Virginia sportsmen to join the League. I could have written thousands of letters to Virginians and have sent probably a ton of printed matter into that State in the interest of this League's work. Now you come to me and want me to do more of this, yet have failed to put in your dollar toward it. Consistency is a jewel. Let me see a sample of your money.—EDITOR.

FOR OUR WILD CREATURES.

It is sickening to read the daily accounts we see of the ruthless waste of animal life by so-called sportsmen. Much as I love field sports I have been so utterly disgusted with the wanton slaughter wrought under the name of sport, that I have been tempted to sell my guns and wash my hands of the whole business. Yet as that would not aid in protecting the game I determined to do what I could to save our wild creatures and joined the League of American Sportsmen. I hope every sportsman in this country will do likewise.

The L. A. S. is working to secure effective laws throughout the United States and appoint capable wardens who will see that they are enforced. We must all do our part in the protection of game if we expect to have any to hunt in the years to come. The game butchers must not be permitted to continue their high handed destruction of God's creatures, slaying everything they can put to death just for the sake of killing something. We are now face to face with the fact that some species of animals and birds that were created for all to enjoy are being completely wiped out of existence by thoughtless people.

Through the efforts of the League I hope we may see in a few years, instead of a list of several extinct species of game, a history only of the extinct game hog. The best way to hasten that day is to respond immediately to the call of the L. A. S. and enroll your name at once with the army that is to protect our wild creatures.

Orrin D. Bartlett, Arlington, N. Y.

DOVES SHOULD BE PROTECTED.

I enclose clipping from the Los Angeles Herald. Do you not think the bag limit should be reduced from 50 a day to 15?

C. I. Harlow, Danby, Cal.

Ed C. Dieter and H. E. Maxson, who opened the dove season near Fernando in the hills, had a good shoot, both getting the limit. Dave Lewellyn, Frank B. Harbert and 2 others were also shooting. They killed 200 birds, all the law allows for 4. There was a terrific cannonading going on.

The early train on the Santa Fe going out toward El Monte will be used by a party who expect to get the limit. Kent Kane and his party are shooting at Etiwanda with every prospect of getting the limit. Count Jaro von Schmidt and several friends have been killing big bags of doves. Good reports of sport at Gardena are coming in, and those who opened the season in that vicinity made limit killings in short time.

I not only agree with you that the bag limit on doves should be reduced, but I go farther and claim, as I have frequently said editorially, that the dove is not a legitimate game bird and should not be killed at any time. It is a beautiful and harmless creature, too pretty and too innocent to be regarded as game. Thousands of the best sportsmen in the country agree with me in this and there are few States in the Union where sportsmen continue to kill these birds. I hope to live to see the time when the Legislatures of these few States will pass laws prohibiting the killing of doves at any time.—EDITOR.

GAME NOTES.

I do not believe there is another spot in the Rocky mountains where game is more abundant than here. December 3, '99, W. C. Stickly, Corporal Watson and I fellow-members of E troop, First U. S. Cavalry, left Fort Washakie for a morning's shooting on the adjacent prairie. In half an hour we killed 9 mallard ducks and a jack rabbit weighing 18 pounds. At Bull lake, 30 miles North from the post, big game is plentiful. While with a party in that region I saw several mule deer, also antelope, mountain sheep, and bear. Farther up we succeeded in killing an elk. At Bull lake we caught any number of mountain trout, and fresh water ling. Six miles West of the post runs Little Wind river. There I once caught, in less than 2 hours, 35 mountain trout running from 1½ pounds up. Of course one has to abide by the game law of the State, and that law is somewhat strict. Each party must have its guide, and no party is allowed to kill more than 2 elk during a season.

Clark J. Rainey, Fort Washakie, Wyo.

I am much interested in RECREATION as its sentiments about game hogs coincide with mine. Game about here is scarce and has been for 3 or 4 years. The true sportsmen of the section appreciate a man who has pluck enough to voice their sentiments publicly, as you do. There is one thing which I should like to bring to your attention. A hunter will go through the

woods and never shoot a red squirrel, but will be eager for a grey. I have done the same thing; but one day I sat waiting for greys when I heard a terrible squealing and standing up I saw 3 reds fighting one grey. I shot at them and got all 4. They were all males. You probably understand this mode of attack so it is useless to go into details. After that I saw a number of encounters of the same kind, always 3 or 4 reds to one grey. That was 5 years ago and since then I have never passed a red squirrel without getting him if I could.

E. Sturdevant, Jr., Danbury, Conn.

Quails are scarce, and it is no wonder. Our Legislature having repealed the rabbit law, quails suffered in consequence. Many coveys were found just before the open season that were nearly shot out and the birds left would, when flushed, scatter in every direction. So long as rabbits may be hunted at any time, so long will quails be illegally killed. Louie Wagner, of Sidney, Ohio, has men hunting for him by the day. I am told by good authority that his men killed 95 quails in one day. No wonder our game birds are getting scarce. There is no game warden within 50 miles of this place. People here are afraid to bring trespassers to justice. I hope the time will speedily come when all game law violators will be so closely pursued that they will quit their lawlessness or quit hunting.

Dan M. Wogaman, Quincy, O.

I should like to offer a suggestion for the further protection of song birds. Every non-resident should be taxed say \$10 for the privilege of carrying a gun or rifle in the open air during the months of June, July and August. During those months thousands of song birds are annually killed by men and boys from the cities. I heard men, last summer, brag of killing 200 king-birds, swallows and robins. I told them I would have them arrested if I caught them at it. The 22-caliber rifle is mostly to blame. I think the Stevens people ought to devise some other ad than the one showing 2 boys in the woods, armed with Favorite rifles, looking through the branches for song birds. At least the picture conveys that idea.

J. H. Geideman, Centerville, N. Y.

This is a great game country. Ducks are so thick and so tame that it is no sport to shoot them. Deer, antelope, and bear abound in the mountains around us.

There is but one store here, consequently they charge what they wish. For instance, condensed milk is 65 cents a can; tea, \$1.70 a pound; sugar, 15 cents a pound; bread, 25 cents a loaf. It would be advisable for

sportsmen coming here to bring with them all they could from the States and not wait to outfit here. We paid \$3 for a box of 25 shells, and could only get 3 ounces of powder at that. Cartridges for 30-30 cost \$2.50 for 20. A tin coffee pot, 2 quarts, costs \$1.15. Bull Durham tobacco costs 40 cents for a 10 cent package.

J. H. Uhle,
Casas Grandes, Chihuahua, Mexico.

ARRESTED FOR GAME LAW VIOLATION.

Emerson Hulsapple, of Troy, was arraigned before Justice Turner at West Sandlake yesterday afternoon by Stephen Horton, of the Rensselaer County Rod and Gun club, on the charge of shooting and possessing a gray squirrel during the close season. He pleaded guilty to the charge and paid a fine and costs amounting to \$18.90. The season for black and gray squirrel hunting does not open until October 1.—Troy (N. Y.) Recorder.

A big price to pay for one little squirrel, isn't it Em? You could have bought a whole hog for that money, that would have fed you and your family a whole month. Obey the law, Em, and you will come out away ahead of any law breaker at the end of the race.—EDITOR.

I have been buying RECREATION about 4 years, and would not be without it for twice what it costs. I have all the copies I have ever bought.

There are many squirrels, quails and rabbits here, also a few deer, and a good many black bears in the Black mountains, about 25 miles from here. Deer are well protected here. I was in camp in October, 1901, at the foot of Mitchell's peak. There were 4 of us, and we killed one 4 prong buck. The largest number of quails killed here by one man last year was about 150. The average number would be under 75.

J. F. Harris, Marion, N. C.

Though I heartily approve RECREATION'S work for game protection, I dissent from its demand for gun and non-resident licenses. That seems an unfair discrimination against the poor man. A better way would be to shorten the season, and stop the sale of game until it becomes more abundant.

E. G. Pettit, Fairmount, W. Va.

I have sold my gun and my dogs are dead; but the old spirit of fair play in hunting is still in me and I congratulate you on your splendid work against game murder.

Geo. E. Eyrich, Jackson, Mich.

Two deer, an old doe and a yearling, came into a field just back of my house and remained some time. It was a treat to watch the graceful creatures.

W. H. Young, Whitefield, N. H.

FISH AND FISHING.

FLY FISHING FOR PICKEREL.

THEODORE GORDON.

Many of the busiest workers in our large cities are ardent devotees of the fly rod, preferring fly fishing to any other recreation. No other sport can be compared with it in affording rest for the mind harassed by cares and anxieties, and just sufficient exercise for the body and limbs. Unfortunately the strenuous endeavor required to insure success, or even a modest livelihood at the present time, prohibits indulgence in this favorite sport during the spring months, when trout fishing is at its best. A day or 2 may be stolen now and then, but not often with a mind at ease. One fears that some serious loss may be incurred or mistake made by those left in charge of the business or affairs.

The vacation time for most men comes in July, August or September, when the weather is hot and fly fishing for trout uncertain and unsatisfactory, except after a cool change with rain and a rise in the water. Even then success is by no means assured; and for real recreation the tired man must have some sport, have something to show as the result of a long summer day out of doors. He may be a keen observer and enjoy all the natural beauties which meet his eyes, but unless he has caught fish and has some story of sport to tell he returns to his temporary home tired and with a sense of failure.

Thinking of these things, and having the greatest sympathy for those who love fly fishing, but whose opportunities are limited. I venture a few suggestions which may enable them to enjoy some sport when the conditions of the weather and the mood of the fish make fly fishing for trout a toil instead of a pleasure. Trout are not the only fish that will rise to an artificial fly. In some waters black bass take it freely, but I refer more particularly to the common pike, or pickerel, which inhabits nearly all the ponds and lakes in the Eastern States. Do not look down on this long nosed gentleman. He is a free riser to the fly, if it is properly made and presented. Fished for with the ordinary fly rod he is a much better game fish than he is reputed to be. Usually this fish is lugged out of his native element with a clothes prop and a meat hook without a chance to show any fight whatever. With light tackle the pickerel is not to be despised as an antagonist; and days spent in its pursuits, among agreeable surroundings, perhaps with a pleasant companion, are often delightful. There is the

drive or walk in the early morning, when the air is fresh and cool, and even if the day is warm the heat is not felt on the water, as there is usually a breeze. Enough rises may be expected to keep the mind from straying from the object in hand, and on a body of open water there is a clear and unobstructed view of the surrounding country.

If there are pickerel in a lake there are usually plenty of them. If the larger fish are not moving you can at least have some fun with the small ones, though that is not much sport. The possibilities, however, are great, as the common pickerel grows to a considerable size, sometimes weighing 7 or 8 pounds, and occasionally these big fish will rise. I have had this experience more than once, only to lose the fish by having the gut leader cut by his sharp teeth. The sensation of having one of these sharklike fish rise in plain sight and seize your fly is something to be remembered.

If there are black bass in the lake you may strike a large one in deep water with the flies used for pickerel; but pickerel are likely to be more numerous where no bass are found, though this is not always the case. Of course a bass must be rather hungry or in a fierce mood to strike at a pickerel fly. Fish do not always take a fly because they are hungry. Many of our most distinguished salmon anglers believe that the salmon takes no food in fresh water and that it rises to a fly only because it is angry or tantalized. Black and red in combination are supposed to annoy salmon, particularly on a hot, bright day. Life is given to the fly by a series of short pulls or movements of the rod, and all game fishes are apt to strike at any small object having this appearance. This is particularly true of the pickerel, and I have designed several flies for their special temptation. The following formula may be of service:

Tag, flat silver tinsel; tail, 2 small feathers from the scarlet ibis, back to back, and quite straight on the hook; butt, scarlet chenille; body, white silk chenille, white ostrich or any soft, white fur, with 2 or 3 turns of red mohair or pig's wool at shoulder; rib, flat or oval silver tinsel; wings, double strips of white swan or goose, with sprigs of scarlet ibis; legs, a white furnace hackle, white with black center, or a good badger hackle, the larger the hackle the better. Over the wing I like a bright teal or widgeon feather. It shows more there than if it is put on with the other hackle.

There can hardly be too much hackle on

this fly. The head may be well tied down and plainly varnished, or it may be made of scarlet, white or yellow chenille. I sometimes add jungle fowl to the wings, but it is not worth the trouble if you expect pickerel only.

This makes a conspicuous fly. If the wings are tied on the sides of the hook, not too low down, they have more play and give life to the fly. Playing it by short jerks, or pulls, of the rod top is most killing, and by pulling in line with the left hand the fly can be made to work effectively as close as desired. This method enables the angler to cover much more water with less effort. Some people may look down on this sport, but I think that any angler trying it for the first time on a good pickerel pond will find real pleasure in it. The fly can be seen and every fish as he rushes out of the weeds or rises from the depths. Larger fish may be taken by sinking the fly with a large shot. I never fancied this. If the fish do not take the fly firmly and are not well hooked cut a small piece from the belly of a little pickerel and stick it on the hook under the tail. This will give a taste of fish to the fly, and if a pickerel misses it he will be likely to come again.

Our long nosed friend is a good table fish and is sold in New York, under the name of brook pickerel, at 2 cents a pound more than pike or the great Northern pickerel. The species must be prolific under favorable conditions, as I know of lakes that are fished nearly all the year through and from which tons and tons of pickerel are taken annually. It is a favorite with country anglers, and on the Delaware I have heard complaints among the older people that the introduction of the black bass has reduced their supply of fish by killing out the pickerel in many of the lakes and streams. They say that formerly a man could go to the river or to one of the many small lakes near and catch a good string of pickerel and perch for his family. Now there are plenty of bass, but they are so capricious that there is no certainty in a day's fishing. Sometimes bass take helgramites; or, again, crayfish; or frogs, crickets, minnows, grasshoppers or nothing at all, just as they happen to feel inclined. Lamperns are also a favorite bait on the Delaware. Bass begin to feed late in the Delaware, and quit early in the season. This is quite an indictment against our noble friend, the small mouth black bass. The only truth in it is, probably, that the bass is a fighter and not afraid of any other fish. He drives the pickerel off his feeding ground and no doubt swallows the smaller ones when sharp set. He multiplies rapidly and takes most of the food supply, leaving only the scraps for pike. Judging

by the rapid growth of the fish, food must be abundant in those ponds in which the bass is not native, and that is why they are such uncertain risers at the fly there. When they do take, great sport may be expected. There is no sturdier fighter, and I think it was Col. Fred Mather who said that, pound for pound, he is the equal or superior of any fish that swims.

Nevertheless, do not despise the pickerel if your vacation time is in July, August or September, and no better fish is to be had. The fish is much better than its reputation. If you lose all your flies, skitter with the ventral fins attached to a narrow piece of flesh which is white and attractive. You may troll if you like or spin a minnow or fish with live bait. Pickerel bite fast sometimes on a cool September or October morning, and really large fish are often taken. Two years ago a friend and I caught 60 good pickerel in an afternoon, using flies until all we had were bit off, and then skittering. We would have had more fish if I had not gone off for an hour in pursuit of a suppositious summer duck.

AT NOTTOWA LAKE.

At 4 a.m. on October 6th, 1899, I was awakened from a sound sleep by a tremendous poke in the ribs and the voice of my wife saying: "Come, do you know it is time we were stirring if we mean to fish today?"

After rustling a breakfast we set out on a 9 mile drive to Nottowa lake, arriving soon after 6. We took only rods and lines, knowing we could procure boat and bait at the lake.

When I shoved off my wife sat in the bow, and cast her fly in ever increasing lengths, but to no purpose, until we both grew impatient and the best half of the day was gone. "Try a frog," I said. She reeled in, took off the bucktail, put on a hook, adjusted the frog, and cast again. There was a rise, but the bass missed the bait, as the canoe was moving too fast. I knew a bass would not rise twice to bait immediately, so we made a circle and came up again farther out. A few careful casts and another rise; this time our fish was hooked and by the way the reel sang I knew it was a large one. He made a wild swerve and started for deep water. I followed with the canoe and soon we were far out. Then he dived.

"Thumb him," I cried.

"I am doing so. My thumb is nearly raw."

"There, hasn't he slacked some?"

"Yes," answered my wife, beginning to take in the slack. Five, 10, 15 yards were recovered, then the fish made a mad rush,

bending the rod nearly double. Out of the water he came, fully 2 feet, then back with a splash. More line recovered. One more rush, a weak struggle, and he lay in the bottom of the canoe; a 3½ pounder and a gamy one, too.

Then it was my turn at the rod and my wife took the paddle. I replaced the bucktail and fished in shore near the rushes. Several times I started a fish, but without getting a strike. Then I tried a frog and presently hooked a small fish, which I reeled in without ceremony.

I handed my wife the rod, and once more she began whipping. Soon there was a rush, a sharp strike, and the reel sang shrilly. Straight into deep water went the fish. Yard after yard of line went singing after him. I paddled hard, but the fish had the start and still the line ran out. There must have been at least 50 yards out before he halted. Then a little was reeled in before another rush for the upper lake. I knew if he tried to go through the narrows it was all off, for there were pond lilies and rushes there. My wife knew it, also, and did a risky thing; she gave him the butt. I expected to see the rod snap, but it stood to strain. The fish was snobbed and came to the surface. Then suddenly the line slackened and a few yards were reeled in. A second rush followed, but my wife handled him skillfully and soon halted him. Then it was a game of give and take, but we finally got him within gaffing distance. He proved a 6-pound pickerel.

It was then nearly 9 o'clock and we did not try fly, or bait casting, but fished for small fish. An hour gave us all the perch and blue gills we wanted.

Returning to the buggy we ate lunch. Then after resting a while we again took the canoe and went for more fish.

Getting out a spoon hook we trolled slowly around the upper lake, but it was too early. At about 4 o'clock we tried again with better success. Our total catch was 4 bass, weighing 10½ pounds, 3 pickerel scaling about 10, and about 25 perch and blue gills.

We could have caught a barrel of small fish, but we know when we have enough.

I should be pleased to go to the same lake with any reader of RECREATION who visits this vicinity.

Stanley Crandall, Union City, Mich.

BIG HAUL OF TROUT.

Four Negaunee boys, Leslie and Keith Maitland, John Broad and Albert Rough, took 275 trout from Green's creek. Most of the fish were of good size, so the catch was easily the finest made this season by local anglers. The boys fished only a few hours. The trout bit well and it was no trouble to catch them.—Marquette (Mich.) Mining Journal,

I wrote these young men for confirmation of this report and received the following reply:

The number of trout reported caught by myself and 3 friends, 275, is correct. These trout were caught at Green's creek, in the Southern part of Marquette county, Michigan. I have had a lot of experience in hunting and fishing, and any time I could give any information I should be glad to do so.

John Broad, Negaunee, Mich.

If you could give any information of any decent work you have done in the way of shooting and fishing, readers of RECREATION would be glad to have it, but they would not appreciate any further accounts of slaughter such as you admit having been guilty of. You have by this admission shown your bristles distinctly and decent sportsmen will shun you accordingly.—EDITOR.

TIMMS IS AFTER THEM.

About 18 miles South of Chicago lies Wolf lake. It is not a beautiful body of water, there being little timber. The shores are lined with bullrushes and large bunches of rushes are scattered all over the lake, making it appear like a large swamp; but many a pleasant day have I spent there. It is convenient for a day's fishing, and conditions being favorable one can get 8 or 10 bass and pickerel by working hard for them. If I could catch that number each time I went after them, I should be well satisfied. I have been told that Wolf lake has recently been restocked with large and small mouth bass. William Timms, who has been appointed deputy game warden of Whiting, Indiana, will do all he can to protect the new stock of bass. In fact, he has already been around to see the men who have gill nets and has told them they would better use their nets for fuel now, because they could have no other use for them. When I know of a good man in the right place, it does me good to mention him.

William Yardley, Chicago.

MORE OF THE VERMONT HERD.

Some time ago a subscriber in Vermont sent me a clipping from the Burlington Free Press, stating that Lewis Wood, Wm. Rivers and Jerry Donahue, of Montpelier, had recently returned from a fishing trip on which they caught 486 pounds of pike. I wrote all 3 of these alleged men and asked them if the statement was correct. Wood and Donahue failed to answer. Rivers sent an evasive reply, in which he

attempted to be funny. I responded to his letter by reminding him that he had not answered my question and requested that he tell me frankly whether or not the newspaper report was correct. I have had no response to that second letter; so we may safely assume that the printed statement was substantially correct. It therefore becomes the duty of all decent sportsmen to avoid these butchers in future as they would any other swine.—EDITOR.

NIBBLES.

Have any readers of RECREATION ever caught herring on a common hook and line? My friend, G. Coughlin, and I, while fishing at New Hamburg reef, in the Hudson river, caught 15 with a drop line baited with common earthworms. We also caught 14 large white perch and fish were still biting well when we left. I have never heard of anyone fishing at that reef and going home empty handed. One can always catch all the large white perch he may wish in one or 2 hours; that is, if he does not wear bristles. I have caught white perch that weighed over 2 pounds at Kent's cliff. I have preserved the skin of one which measured 15 inches and weighed 2 pounds one ounce. I have caught several weighing 1½ to 2 pounds. Have other readers of RECREATION caught perch that will beat this? If so I should like to hear from them through RECREATION.

G. W. Wood, Matteawan, N. Y.

September 2 I fished in Moore's lake, Gloucester county, New Jersey, about a mile from Clayton. The wind was from the Northwest, blowing light, and the sky was heavily clouded. After fishing a few minutes with a spoon I caught my first pike, weighing 1½ pounds. Then, finding a dead chub, and cutting him in pieces, I discarded my spoon and baited with chub, gut and underfins. I then caught 8 fish in the next 5 minutes. I followed the channel of the pond, letting the bait sink almost to the bottom and moving it slowly by sculling the boat. After 2 hours I had caught 45 pike, weighing about one pound apiece. The fish bit ferociously, and the day's sport was one of the finest I ever had with rod and reel.

Louis G. Fisher, Clayton, N. J.

Thus you put yourself on record as another specimen of the Jersey breed of bristlebacks.—EDITOR.

Lake Webber lies 6,500 feet above sea level in the heart of the Sierra Nevada mountains, 25 miles Northwest of Trucker. It contains Loch Leven, cutthroat, Eastern

brook, and common brown trout. They offer magnificent sport. I was on the lake and caught 27 trout that averaged 1½ pounds. Nine miles Southwest of Webber lake is an artificial reservoir called Fordyce lake, plentifully stocked with cutthroat trout. They are exceedingly game, giving the angler all the sport he wants. A few large mouth bass have been planted in the streams near this city and have increased wonderfully. They were given a close season of 3 years which has nearly expired. Webber lake is easy of access from San Francisco, Sacramento, Stockton and all the surrounding country.

Wm. G. Douglass, Stockton, Cal.

I am fighting against the men who are netting in Pelham bay. October 1st the fykes were set and I at once notified the owners to remove them which they refused to do. I therefore asked the aid of game protectors Overton and Dorlow, who arrested the chief malefactor, Rufus Morris. October 23 Morris was put under bail for trial in special sessions. Still the fykes were worked, day after day. I again appealed to Mr Overton, who came up again November 7th with Mr. Dorlow and lifted the fykes, removed 77 striped bass and destroyed the nets. In consequence there will be an action in the Supreme Court for about \$1,800, fines. This is the only way to cure these fellows, who claim the earth and all there is on it.

C. A. Kramer, No. 73, L. A. S.,
Baychester, N. Y.

The McGrath brothers are on record for a catch of 300 brook trout in half a day last season.—Minnesota paper.

I wrote Mr. McGrath, asking for confirmation of the report and received the following reply:

The report is fairly correct. We made a remarkable catch of brook trout last summer; the largest known in this region. Any further light that I can throw on this subject I will be ready to furnish.

W. H. McGrath, Minneapolis, Minn.

I do not care for further light, but I take this opportunity to hold you up to the public gaze as a typical specimen of the razor-back who likes to break the record and then blow about it.—EDITOR.

"Few men are as good as they pretend to be."

"Well, what of it? Few men want to be."—Judge.

"Always try to hit the nail on the head, my boy—don't hit the nail on your finger, for it hurts awful."

GUNS AND AMMUNITION.

Anybody can shoot all day, but a gentleman will quit when he gets enough.

AGAINST HAND LOADING.

In your November issue appears an article on the use of the revolver by Dr. Conyngham. He says therein, "Do not use factory ammunition. Buy the best shells and powder you can and load them yourself, starting with a 5 grain charge."

To this portion of the doctor's otherwise valuable paper, I take serious exception. Such advice in similar articles is becoming much too frequent. If every man who reads the article were an expert on powders, black and smokeless; understood their effects under all the physical conditions that surround their use; were able to say, within the truth, that he knew to a nicety the exact load the exceeding of which would wreck his weapon; then I should endorse such advice. Unfortunately, the vast majority of shooters do not know the difference between a high and a low pressure smokeless powder. They have little or no knowledge of their adaptability under varying service conditions, and because of the fact that the old black powders were safe under almost any reasonable conditions, assume unwisely that the various nitro compounds are equally safe. Nothing could be farther from the truth. The majority of expert amateurs, shooters with wide experience, mature judgment, and caution born of knowledge of the disastrous results likely to come from the improper use of high explosives, are loath to experiment, even in the most careful way, with the modern high pressure smokeless powders. Arms and ammunition manufacturers owe much to the loading experiments of the expert amateur. A large part of modern ballistic progress is attributable to their painstaking work; but to assume that anyone equipped with a reloading set, some powder, primers and lead is capable safely of making accurate, fixed ammunition, is dangerous and unwise.

If the fatal and maiming accidents that have resulted during the past 5 years from inexperienced use of smokeless powders could be tabulated, it would strongly emphasize my contention. There are certain nitro powders on the market which, under improper loading conditions, errors easily committed by the tyro, might detonate, and wreck any barrel or action. Sometimes the addition of 2 to 4 grains to the safe and proper load will produce, with these powders, breech pressures far

beyond the limit of safety which the weapon possesses. These dangers are equally common to rifle, shot gun and revolver.

Under the present status of nitro explosives, only the most expert should attempt to load with high pressure smokeless powders. The danger of confounding the various grades of rifle powders, even of the same manufacture, and of shot gun smokeless with rifle smokeless make such loading extremely hazardous. Unless one has had careful training in the production of home-made ammunition, he would far better purchase factory ammunition. In using the product of any of the leading American companies he is assured of more uniformity in every factor going to make up his load than he can hope to obtain by hand work. In the factory product, primers are correct for the powder employed, and are all seated to the same depth in the pocket; bullets are swaged in powerful, accurate machines to exact size; and no method, other than the use of the apothecaries' scales gives more accurate measure of the powder charge than do the factory charging machines. The variation in factory loads can be measured, if present at all, in fractions of grains.

There is, of course, in some branches of target shooting, more particularly in mid-range work, employing heavy, black powder, single shot rifles, ample scope for hand loading, and with a reasonable degree of safety. There is scarcely a village or town in the country which does not possess one or more experts in that sort of work. Practically all the target work done at present in the United States, except military long range shooting, is done with black powder or some modification of it, and a large part of the ammunition thus used is loaded by the shooters themselves. The character of black powder is so well known that small danger exists and I can see no reason why the careful experimental shooter, or the economical shooter (for hand loads are cheap) should be debarred from making his own ammunition for use in work as just indicated.

However, few except the superlatively expert, can hold as close as good factory ammunition can shoot. Therefore, unless you are expert, or can have the tutelage of one who surely is, do not accept the dictum that hand loading is as easy as a, b, c, and as safe as ping pong,

If, in spite of this and similar warnings, you still think you are able to do hand-loading, with safety to your weapon and yourself, take at least one parting bit of advice: follow the loading instructions of the powder makers absolutely. They have done the experimenting, and your safety as well as their reputation depends on the fidelity with which their directions are followed.

E. B. Guile, M. D., Utica, N. Y.

Dr. E. F. Conyngham, in his excellent article in November RECREATION entitled "The Pistol from a Western Standpoint," gives one bit of advice to your readers that should not be allowed to pass unchallenged. He says:

Nearly all shooters nowadays use smokeless powders. The .32 S. & W., for instance, is loaded at the factory with less than 2 grains of powder, and the .38 S. & W. with about 2½ grains. Should an experimenter, acting on the Doctor's advice, load one of these shells with 5 grains of powder and fire it, he would be likely to go up the golden stairs or down the others in a hurry. If the Doctor had said 5 grains of black powder his advice would have been all right; but as he did not specify almost anyone would take it for granted he meant smokeless.

It is perhaps well enough for an expert rifle or revolver or shot gun shooter, who devotes a great deal of time to the study of the science and who is extremely careful and methodical in his work, to reload shells; but it is not safe for any one else to undertake it. The novice, or the man who only shoots occasionally, should stick to factory ammunition. The large cartridge factories of this country expend many thousands of dollars each year in making careful experiments in the loading of shells for rifles, revolvers and shot guns, and in perfecting machinery for this purpose. Their machines are so skillfully made and so minutely adjusted as to load a million cartridges of any given pattern without making a variation of one grain in the powder charge of the entire lot. Furthermore, these machines seat the bullets in rifle and revolver cartridges with the utmost possible accuracy, while it is extremely difficult for any man loading shells by hand to avoid getting a bullet out of line now and then. All such cartridges must prove accurate.

Furthermore, there is but little to be saved by reloading cartridges. The consumer must buy his powder, lead and wads in comparatively small lots and pay accordingly. The cartridge factories buy their materials by the ton, and it is safe to say they buy them at one-half the price which an individual shooter would have to

pay. Factory cartridges are sold at such low prices, even in small lots, that it does not pay to reload them, even though you have your empty shells free to start with. It is far better therefore for the average shooter to buy factory loaded cartridges, and to throw away his empty shells as fast as fired. In the language of the ancient philosopher, don't monkey with the buzz-saw.

L. E. H., Syracuse, N. Y.

A NEW 30 CALIBER BULLET.

The past 6 years I have been experimenting, as leisure would permit, with 30 caliber rifles. Neither the Keptheart nor the Hudson bullet meets the requirements. Their inventors, however, have demonstrated 2 important points; namely, the advantage of a square fronted first band to scrape out fouling, and the necessity of having a bullet fit tightly to prevent upsetting with smokeless powder.

Some bullets I tried had lead points as long as ordinary jacketed points. When fed into the barrel from the magazine, coming up an incline as they do, the long point either bent or else the bullet was loosened in the shell. In consequence, they failed to group as well as bullets from the same shells when slipped into the barrel by hand. Some of these bullets when factory loaded in new shells did fairly well, and the shell had a tight grip on the ball; but when loaded by hand in old shells, I could never get them to group satisfactorily.

Finally I devised a new bullet. Mr. Barlow, of the Ideal Manufacturing Company, made a mold after my design, and I believe I am now using the first really all around ball. Its weight, when cast full length and greased, is 132 grains. It has 5 full bands, 5 full grooves and a narrow band in front, sharp and square on the forward edge; to scrape out what little fouling there may be. As a perfect heel is of more importance than a perfect point, this bullet is cast heel down in the mold. If there is a defect on one side of the heel, gas will rush out of the gun muzzle first at that side and deflect the ball. There is a sharp, square corner all around the heel, so grease can not get under it while being applied.

This bullet has a sharp point, projecting but little from the shell when crimped in, thus lessening the chance of injury while being carried in the pocket or fed from the magazine. I do not use shells creased or indented to prevent too deep seating of the ball. Instead, I use plain, smooth mouth shells, first firing one full load in each. This expands them so they fit the gun perfectly, and swells the muzzle so my .311 bullet will enter a .303 shell. I seat the bullet so the crimp will come just

behind the narrow band. This prevents the ball from pushing back on the powder, and enables me to use one length of shell for all loads. The bullet, if cast 10 to 1 and greased with Ideal lubricant, will not lead a gun.

Use a clean, low pressure smokeless, one giving little, if any, more velocity than black powder. The ball is so divided in bands and grooves that almost its entire length is in contact with the barrel. The narrow band in front gets all the grease it can handle at the first shot after the gun has been cleaned and oiled. Thereafter the band never touches the barrel, and what little fouling there is rolls up in front of it, gets under the band and is removed by the bands following.

My bullet makes the loaded cartridge about $\frac{3}{8}$ inch shorter than the standard load. It is, therefore, possible that some 30 caliber magazine guns will not handle it. In my gun, a Savage, the shortage makes no difference.

Rifle makers say a different adjustment of sights is needed for different loads. I am not going to dispute that as a general statement, but I have 2 loads that follow the same sighting. Some guns, at least, give a different drift to one load from what they do to another. I had supposed that varying loads of powder would make a gun shoot high or low, as the case might be, without causing lateral variation; but I find that is not so. One gun I tried would, with a light load of high pressure powder and a soft point ball, shoot below and to the left; when the load was increased it shot high and to the right. Another gun would make close groups with soft points and $22\frac{1}{2}$ grains Savage No. 1; increasing the load resulted in high and wild shooting. The gun I have at present will make good groups not only with that load, but with as much more powder as I can get into the shell. Each load will make good groups, but at different places on the target. I chose as a full load for my .303 Savage, $26\frac{1}{2}$ grains Savage No. 1, 1901 brand, smokeless powder, a U. M. C. No. 8 $\frac{1}{2}$ primer and a U. M. C. 195 grain soft pointed bullet. With the gun sighted to group in the center at 100 yards, it will group $\frac{3}{4}$ inch high at 50.

For a light load I use my new bullet, full length and sized .311, a U. M. C. 8 $\frac{1}{2}$ primer and 11 grains DuPont No. 2 smokeless rifle. With the same sighting as for the full load, this load will group on the center at 50 yards and about 2 inches low at 100. The new bullet in the 3 band, 88 grain size, with the same powder load, will group nicely at 50 yards, though a trifle high. I have tried many kinds of smokeless and for this load DuPont No. 2 suits me

best. It is fine grain and will measure in a charger with more uniformity than a coarser powder.

This powder retails at \$1 a can of one pound bulk, which contains 275 loads of 11 grains each. A pound of lead makes 50 full length bullets. By buying powder, lead and primers right, I get my light loads for about 50 cents a hundred. I use an Ideal dipper, pot and cover; an Ideal Perfection mold, chambered to make my bullet; and an Ideal lubricator and sizer, with .311 sizing die. I also use expanded shells and an Ideal No. 3 special tool having one chamber to crimp the standard soft point bullet, and an adjustable double chamber to seat and crimp my new bullet. The latter is designated in the Ideal Hand Book as bullet No. 308,234.



I believe my new bullet has more advantages than any other. It is simple, easy to mold, grease and load, accurate and serviceable, and much cleaner than others.

I used to think high power guns not so accurate as black powder weapons, but find it was because I did not know how to load smokeless. Some guns need just so much of a charge and no more. Others will shoot a variety of loads and bunch any of them well, though the drift of each will be different and the gun can be sighted to suit only one load. After adopting a full load, experiment until a light load is found that will follow the same sighting.

For accurate rest shooting the telescope sight is the thing. I have a No. 3, 20 power, Sidle, mounted on the side so as not to interfere with the Lymans. It has fine wind gauge and elevation adjustment. With it I can see .303 bullet holes plainly at 150 yards.

I am a poor off hand shot, and all my test shooting has been done at a rest. I built a frame of 6x6 inch stuff so the gun muzzle could rest on one end and my chest and arms on the other. Then I rigged a piece of board to rest the receiver of the rifle on, and filled 2 shot sacks with sand to steady each end of the gun. There was no guess work then; I could hold the cross hairs of the telescope on a tack head at 100 yards.

I always clean guns with a field wiper, a woolen flannel rag and any good machine oil. I never wet a gun. I keep a filler in my guns at all times when not in use, a wooden rod wound with greased wool flannel. Cotton is not good for a rifle wiper; it is not springy enough to enter the grooves as wool does.

E. P. Armstrong, Dewdrop, Pa.

NO PERFECT GUN.

I have never found the perfect rifle. But then, perfection is a hard thing to corral in this wicked world, and in the case of the rifle, I have come near enough to it for all practical purposes.

Everything has flaws if you can get to know them. One thinks the Savage the perfect gun. I admit it is good, but we have tested it here in competition with other rifles shooting a similar cartridge, and we fail to see just where it excels. It is more liable to jam and to freeze up than the Winchester 30-30, but in reloading the latter gun the lever must be carried so far forward to place a new cartridge in the magazine that there is danger of a balk.

We have found the Savage and the Winchester 30-30 good enough guns for deer and caribou; but they are too light for moose. Hitherto the U. S. 30-40 cartridge with the soft nose bullet has been found the best American made article to use on this game; but the new Winchester 35 cartridge should be much better than even that.

One correspondent wishes to hear from those who have used the Mauser pistol. It is, I think, the most ingeniously devised arm on the market. Its accuracy, range and penetration are beyond question; but to the inexperienced handler of firearms there is none quite so dangerous. It also has the fault, common to so many magazine weapons, that you never can tell without unloading, how many cartridges are in the magazine. The soft nose bullet, when fired from it, is not very expansive. Adam Moose, the celebrated guide, who used one last spring to kill trapped bears, thinks this is because the jacket covers too much of the point of the bullet; but I am inclined to ascribe a little of it to the comparatively low velocity of the gun.

There are hundreds who can give you the name of the best shot gun in the world, and in 9 cases out of 10 each one will name the particular gun he himself uses. If a man is rich he can afford to experiment, and if he does not get what he is looking for the first time, he is in a position to try again. But when a poor man errs in his choice the remedy is not so plain. For a man who feels that he needs 100 cents' worth of gun for each dollar he invests there is no better gun made anywhere than the Ithaca, and I do not know of any that I consider as good. It is cheap in comparison with the prices charged for other guns. It looks, wears, handles, and shoots well.

In October, '98, W. H. Lawrence, of Keswick Ridge, N. B., visited me for a few days' duck shooting. He was using an 8 pound, 12 gauge Ithaca. I was shooting a high grade Greener. One day we took it

into our heads to target our guns. In the penetration they gave there was no apparent difference. With No. 7 and 6 shot mine had a trifle the better of it, for it gave as regular a pattern as you could prick out with an awl. With Nos. 4 and 2 there was no difference that we could see, but with Nos. 1, B, and BB, mine was simply out of the competition. The Ithaca planted them as regularly as it did the No. 8's, while the shooting of my gun was wild. It makes a person feel uncomfortable to have his \$200 gun beaten by a \$60 one. At the same time it teaches him something.

L. I. Flower, Central Cambridge, N. B.

DEFINITION OF CALIBER AND GAUGE.

Kindly explain the exact meaning of the technical terms used to express the different rifle and shot gun gauges. Why is a certain caliber called 30-30, another 45-70, still another 45-70-330? Why is a shot gun a 10 gauge, a 12 or a 20?

F. J. Smith, Boston, Mass.

ANSWER.

Caliber refers to the diameter of the bore of rifles; gauge to the diameter of the bore of shot guns. Caliber is usually expressed in fractions of an inch, although many of the newer military cartridges, especially those of foreign origin, are expressed in millimeters. The figures indicating caliber really refer to the size of the bore of the rifle before the rifling or grooving is done. For instance, the 30-30 cartridge is used in a barrel bored to .300 inch, but the rifling increases the diameter of the bore, measuring from the bottom of one groove to the bottom of the opposite groove, to .308 inch, the grooves being cut .004 inch deep. A bullet to fit exactly would be .308 inch in diameter, but in practice is usually smaller; the present Winchester 30-30 bullet being about .307 inch.

When a cartridge is denominated in 3 figures, for example, 45-70-330, it means that the bore of the rifle is .450 inch before the grooving or rifling is cut, the powder charge is 70 grains and the weight of bullet 330 grains. The Winchester 45-70 ball is .456 inch, while the United States Government 45-70 is .45 inch. These figures do not always represent the exact data. For instance, the 38-55-255 when first brought out, using the old style folded head shell, held 55 grains of powder. When the new solid head shell came in vogue, the only thing to do was to reduce the powder charge, as the new shells held less powder than the old ones. The charge was therefore reduced to 48 grains, but the cartridge still retained its old name. Many other cartridges, as now made, do not correspond to the names they bear. The 38-40 ball is not .380

inch, but is .400 inch, while the 44-40 ball is a little more than .42 caliber. The original 30-30 had 30 grains of high pressure powder, but now carries about 22 grains of L. & R. Lightning, or 29 grains of Du Pont 30 caliber.

Years ago, when smooth bores were in vogue, and when they, as well as practically all rifles, used round balls, the gauge of caliber was based on the number of balls to the pound; a 20 gauge taking 20 balls to the pound, a 50 gauge taking 50 balls, and so on. The 50 gauge would measure about .450 inch, the 20 gauge over .610 inch, and the old fashioned 32 gauge, once a favorite in American hunting rifles, was nearly .530 caliber. This same system is still used in numbering shot guns; the 12 gauge being .729 inch bore, a round ball to fit weighing about 580 grains. But as the use of a patch requires the fit to be loose, the bullets are really only about 545 grains in weight. The 10 gauge is .775 caliber; the 16 gauge is .662 caliber; the 20 gauge is .615 caliber.—

EDITOR.

TARGET SHOOTING.

I wish to call the attention of readers of RECREATION to a target which I have used a number of years for rifle and pistol practice.

Those who shoot at a regular range use one of the standard targets; but many shooters use a home-made target, sometimes a bullseye on white paper, and often at a guessed distance. If there should be rings outside the bullseye, they are likely to be out of proportion to it. If such shooters would make a target of regular size and use it at the proper distance, the pleasure of shooting would be greatly increased.

After some experimenting, I found a target which I think is most satisfactory for ordinary practice. It is also good for match shooting. I call it the symmetrical target, because each ring is just the diameter of the bullseye larger than the next smaller one. Thus at 25 yards the bullseye is one inch and the rings are 2, 3, 4, 5 and 6 inches in diameter. The bullseye scores 10 and the rings 8, 6, 4, 2, 1. The bullseye is increased one inch every 25 yards; so at 100 yards it is 4 inches in diameter which is the standard size. The largest ring would be 24 inches. This target I use for off-hand shooting.

For rest shooting, use a target $\frac{1}{2}$ the regular size with regular sized bullseye. That is, at 100 yards use the 50 yard target, with 100 yard bullseye. The rings score, when shooting this way, 1, 2, 3, 4, 5, 6; 6 is the center of the bullseye.

For pistol shooting use the target, regular size, at 2-5 the distance that it is used

for a rifle; that is, the 50 yard target is used at 20 yards.

In making this target I use an implement which is easy to make. Take a strip of zinc an inch wide and a little over a foot long. About $\frac{1}{2}$ inch from one end make a hole large enough for a large pin, or, what is better, a small brad, to pass through easily.

Then make holes along the center, $\frac{1}{4}$ inch apart, for $\frac{1}{2}$ its length, then $\frac{1}{2}$ -inch to the end. They should be large enough for the point of a pencil to pass through. Be careful to get the holes exactly the right distance apart.

Then take a piece of paper the size you wish your target to be, and mark the center. Place it on a smooth surface, and put the pinhole over the center. Drive a pin or brad through into the wood underneath. Take a lead pencil and swing the circles that you wish. The bullseyes are better made of black paper and tacked on. Photographer's paper is good. Pastors are easily made and used. Don't use white paper for targets. Yellow, or light gray or brown is better. Always measure your distance.

E. E. W., Old Mystic, Conn.

THE LUGER AUTOMATIC PISTOL.

The board appointed by the Ordnance Department to test and recommend a small arm to replace the revolver in the Army and Navy, showed good judgment when it chose the Borchardt-Luger parabellum pistol, commonly known as the Luger automatic. It is one of the greatest weapons ever produced. In efficiency, range, accuracy and reliability it is perfect. Its durability can be demonstrated only by time and service. In action and manipulation it is superb. In a trial of the weapon a short time ago, at a distance of 23 yards, the bullet penetrated 9 inches of soft pine, but as the exit was a clear cut hole I am sure the limit of its power was not shown.

The recoil is scarcely discernible, while the automatic action of the heavy bolt incidental on extracting and reloading is unnoticeable either by eye or hand. This seems incredible when one considers the force necessary to work the bolt by hand. After having fired the pistol the automatic action to put it into position to again fire is unnoticed, and one hardly believes that it can be fired again by merely pressing the trigger.

The discharged shells fly back over the right shoulder about 5 feet. Should your position during firing remain unchanged, you will find them all in a 2-foot circle.

The target that can be made is surprising. Little care is necessary to group your shots in a 2-inch circle; and if your

form any of its functions. It is the most perfect of automatons.

Its extremely homely appearance does not at first prepossess one in its favor, but "handsome is that handsome does," and the weapon certainly does it.

Many men have of late become admirers of the modern small caliber; some at first trial, others after much study and thought, for it was hard to lay aside and forget the old favorites. So it will be with the good old 6-shooter; yet one trial of the new pistol will not fail to convince the most confirmed revolver advocate of its superiority.

The only drawback to the Luger pistol is the larger grip, incidental on the handle's containing the magazine. This makes the grip awkward in a small hand, but a little practice will overcome that.

E. E. Stokes, Brooklyn, N. Y.

WANTS POINTS ON AMERICAN GUNS.

Will some of your readers please give their experience of the arms mentioned in the list of questions below? I am anxious to get opinions on the latest American arms from those who have used them, before buying such of them as seem most satisfactory.

Which is the best repeating shot gun? Would such a gun with cylinder barrel shoot ball well; and would 12-bore cartridges loaded with ball work through the magazines and action without jamming?

Do those who have used both prefer them to double guns?

Do they and other American guns work equally as well with English cartridges as with American shells? Which is the best American double gun? How does it compare with English guns such as Greener's, Scotts' and others, of same price? Does the 50 caliber '86 model Winchester shoot the 50-100-450 and 50-110-300 cartridges in the same rifle and with same sighting? Can the shells be reloaded often and which are the best tools and powders? Which of the 2 cartridges gives the most accurate and deadly shooting? Which is the best repeater for the 30-30 smokeless cartridge? With a soft nosed bullet is it as deadly on game as the 50 Winchester? Is the 40-72-330, '95 model Winchester an accurate and hard hitting rifle for large game? Can anyone give his experiences with the new 32 Special Winchester? Is it a better cartridge on game than the 30-30?

How do the Mauser and Mannlicher rifles compare, as regards accuracy and target is not heavy and well backed your shots will go through it.

Never once is there a missfire or a failure on the part of the weapon to per-

forming power, with American smokeless powder small bore rifles, and for working of action, etc., with the Remington-Lee and Lee straight pull rifles?

Is the Lee straight pull rifle likely to be made in calibers larger than .236?

Is the Savage rifle preferable to the Winchester?

What are the best rifles and cartridges for shooting birds and small game and for target practice; the distance about 150 to 200 yards?

Britisher, Calcutta, India.

SAVAGE SAME AS WINCHESTER.

I notice in RECREATION a long letter signed J. Chester, Sarnia, Ont., and comparing Savage and Winchester rifles, as to their using, in the case of the Savage rifle, several cartridges of different loads, and in the Winchester only one load, the Winchester rifle being accurately sighted for that one cartridge only. The Winchester Arms Company was the first to manufacture the 30-30 smokeless cartridge and a rifle to take it, and if Mr. Chester, or any one interested, will look on page 103 of the Winchester catalogue, number 67, he will there find that they advertise to supply and sell for their 30-30 rifles 3 cartridges of different loads for the one gun, a fully jacketed bullet load, an expanding bullet load and a short range miniature load. The Savage Arms Company manufacture their 30-30 rifles to take these identical cartridges; therefore it is ridiculous to make any comparison between these 2 arms from that point of view; there is no difference on that point.

The Winchester Arms Company also manufactures 3 cartridges of different loads for their 30-40 rifle, which uses the United States present standard ammunition, the same combination as the 30-30. If, therefore, the Savage Company is to be condemned because it makes rifles to take different cartridges for the one arm, then it is in good company with the Winchester Arms Company, and to criticise one adversely is to criticise both.

Relative to sighting each rifle perfectly for any particular cartridge for the trade in general, Mr. Chester has yet to learn that no 2 people look through sights exactly alike, and any rifle sighted accurately by one man, will shoot many inches off when used by another person at even as short a range as 100 yards; so if the Winchester Company targets every rifle for a certain cartridge by a certain expert, everyone else who buys those rifles will be compelled to change the sights in order to get perfect results. I am ready to prove this statement at any time.

M. W. Miner, York, Neb.

AN INTERESTING RELIC.

I send you to-day another curio for your den. I hope you will place it beside the big Prince of Wales buffalo gun I sent you some years ago.

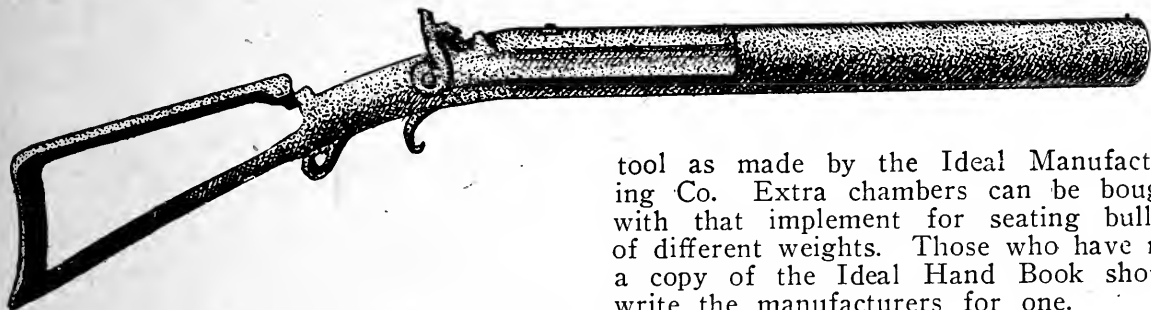

This gun is surely a novelty. I do not know how much it weighs, who owned it first, how it got there or for what it was used. Wish I did. What a history it must have! It was probably used as a whale gun! If so where is the hardy Norseman who put it to his shoulder? Did the brave fellow go down with the gun when years ago it went to the bottom of the sea off Port Valdes? Are his bones there yet? Hardly, for the condition of the old weapon, when dragged up by the anchor of a Dawson steamer shows that it must have lain there many years under many fathoms of water.

The gun was turned over by the Jackie who saved it to a hardware house here, in whose window I discovered it. Time evens all things and at last this interesting relic lands in your den.

If any of the good fellows who want big game come this way tell them to call on me.

C. F. Lundy, Seattle, Wash.

TO RELOAD 25-20 CARTRIDGES.

Please explain how to reload 25-20 single shot cartridges. Does a set of reloading tools, as sold, contain everything necessary for reloading these shells? What is meant by trajectory? What size shot is best for duck shooting?

Harry Deane, Mingo Junction, Ohio.

ANSWER.

The 25-20 single shot cartridge is regularly loaded with 19 grains of ffg or fg black powder, or its equivalent in bulk of Du Pont's smokeless rifle powder.

The weight of the regular bullet as made by the factory is 86 grains. There are reports of the 86 grain bullet staggering in some rifles. If such is the case, would advise the 77 grain bullet with an increase of 1 or 1½ grains of powder. For weights of different bullets that may be used in the 25-20 single shot, see series designated as No. 25,720 in the Ideal Hand Book, No. 14, on page 26. These various weights may be seated with the standard reloading tools as

made by the Winchester Arms Co. or the Ideal Manufacturing Co. If other bullets having different shaped points than the standard, such as No. 25,719 on the same page, are desired, I advise No. 3 special

tool as made by the Ideal Manufacturing Co. Extra chambers can be bought with that implement for seating bullets of different weights. Those who have not a copy of the Ideal Hand Book should write the manufacturers for one.

"Trajectory" means the curve which a bullet describes in its flight from the muzzle to the object aimed at. For example, if an imaginary straight line is drawn from the muzzle of the gun direct to the object aimed at, it will be found in actual test that the bullet on being fired first rises above and then gradually falls to this line.

No. 2 shot is generally used for duck shooting, though some use No. 1 and others smaller than No. 2.—EDITOR

WHY LOOK BACKWARD?

In JUNE RECREATION I find an article by J. A. Steele, headed, "Wanted to Return to the Muzzle Loader." Why not return to the flintlock or the arquebus?

There were a few muzzle loaders on the old farm and I have had experience with them. You pour in a handful of powder, more or less; wad with paper and ram all home until you bark your fingers. Then put in shot, gravel, nails or any old junk and more paper. Then you put on a cap, if your fingers are not too cold. G. D. caps were principally used in my time, though in speaking of them that abbreviation was never used. I have heard the name expanded to a shockingly profane length. Having got the weapon loaded we will suppose you put up a grouse. The gun goes to shoulder and you pull trigger. "Snap! S-s-s-s!" says the cap. Then there is a more or less prolonged silence. At this stage of the game the unduly curious were wont to look down the barrel to see what was coming next. They generally found out, but seldom tarried long to explain what they thought about it. Those strong minded enough to keep the gun pointed in the direction of the disappearing grouse were rewarded in time by hearing a most satisfying explosion. Sometimes even the grouse heard it, but as a rule he was out of earshot. An expert hunter would pull the trigger and then look for something to shoot; if he was in a decent game country he could find it before the gun went off.

By all means let us return to the muzzle loader, or, better yet, to the boomerang and bow and arrow.

H. L. Manchester, Tiverton, R. I.

HOW NOT TO LOAD A MAUSER.

As the Mauser rifle is receiving considerable attention in RECREATION, let me add my chip to the pile. In '99, when I returned from the Philippines, I brought back a Mauser and 100 cartridges for it. I also brought a lot of 45-70's, both black and smokeless. After using nearly all my Mauser shells at target practice one day I tried an experiment. I poured the powder out of a Mauser shell and replaced it with about the same quantity of 45-70 smokeless. Then I fired. When the other fellows picked me up I had a sprinkling of powder and steel in my head and face, but was not seriously hurt. We didn't pick up all of the gun. The explosion broke the receiver off the barrel, broke the stock and scattered bits of hardware over the whole township. The bolt handle was cracked off and the receiver bent like a rail fence. The front sight and the butt plate are intact, but the rest isn't worth 3 cents as old iron. A Mauser is all right in its way, but don't load it with 45-70 smokeless.

M. C. Manly, Gilmer, Wash.

SMALL SHOT.

I thank you for the bullet mould recently received. It was kind of you to order a premium not in your list for so small a number of subscriptions. It is for an old powder and ball Colt's, 45 caliber, which, as the barrel is in perfect condition is certainly worth a mould. I have an old German hand-made muzzle loading rifle which I recently had rebored to 45 caliber. It was rebored by the man who made it and will score with a modern breech loader. There are 3 of us in this town who delight in burning powder. Two shoot 25-20 Winchester's, while No. 3 shoots a 38-55 repeater. For an all around light rifle the 25 can not be beaten, especially for a squirrel gun. My 25 has been in constant use 9 years and the barrel is still perfect, though at least 6,000 shots have been fired from it. We all use Ideal tools and reload our shells.

H. E. Shaw, Madison, Wis.

Have noticed in recent issues of RECREATION information about loading the different rifle shells with smokeless powder. Nearly all writers advise putting in a few grains of black powder before the smokeless. I can not see any reason for so doing. It is unnecessary, causes smoke, dirty gun barrels and erratic shooting. I am

now using Blue Rival, New Rival and New Club shells, primed with Winchester No. 3 primer. I load with $2\frac{3}{4}$, 3 and $3\frac{1}{4}$ drams Du Pont smokeless for a 12 gauge gun. These shells are, I believe, all one needs for field shooting. Have always found them quick, sure fire and have never had a head blow off. Ed. J. Anderson is right in saying it takes a season's shooting to learn the ins and outs of a gun.

W. C. H., Augusta, Mich.

In answer to inquiries concerning the 25-20 cartridge, I would say I have had 2 rifles of that caliber. There is no better cartridge for game under deer. I recently bought a Winchester, model '92, 25-20 repeater. It is the neatest rifle I have seen for small game, and superior to the 32-20 in every way. I have had a Stevens No. 44 Ideal, 25-20 rifle, but prefer the Winchester as it is lighter. The Stevens uses the 25-20 single shot cartridge and the Winchester uses the 25-20 Winchester. The shooting qualities of the 2 are about the same, but being different in form, they will not fit the same chamber.

H. B., Campello, Mass.

I wish to select a good target rifle costing about \$25. Will any of your readers give me information as to what I would find best suited to my needs? I care for no decorations, but wish a perfectly plain, well made gun, with all necessary attachments.

Recreation Rifle Club is in flourishing condition and we have no reason to regret having adopted the name. Practically, RECREATION is our official organ.

H. P. Brown, Auburn, N. Y.

I am much interested in the gun and ammunition department of RECREATION. Though a gun crank, I am unfortunately not able to buy an expensive gun; so I ordered an Ithaca, No. 1, Special hammerless with nitro steel barrels for target use. The finish, balance and shooting qualities of the Ithaca surprised me. The new concealed cross bolt added to the old under fastening, makes a doubly secure fastening.

E. M. B., Trumansburg, N. Y.

Some time ago I bought a Hopkins & Allen 22 caliber rifle. Its finish was rather crude; but after cutting down the front sight, filing sharp edges off the hammer, tinkering the trigger and reaming the rear of chamber until it would admit the rim of a shell, I found I had a first class little gun. It has done great execution on woodchucks and sparrows. If you split the nose of a 22 long, it will tear a hole as big as a cent.

Lloyd Badger, Quaquaga, N. Y.

NATURAL HISTORY.

When a bird or a wild animal is killed, that is the end of it. If photographed, it may still live and its educational and scientific value is multiplied indefinitely.

PHEASANTS AS MOTHERS.

Pet stock fanciers of the United States are fast awakening to the fact that among the most beautiful and easily kept birds in the world is the pheasant family. The golden and Lady Amherst pheasants are preferred for aviary and park decoration. If they can be given a few square yards of lawn they will take great pleasure in exhibiting their gorgeous plumage while feeding on the clover, and the care of them will be reduced to a minimum.

Frequently their eggs lack fertility. When that is not the case the trick of hatching and rearing the young is as simple as raising domestic poultry.

I am a great advocate of pinioning the little fellows at about 2 weeks old, at which age there is but about $\frac{1}{4}$ inch of gristle to clip off with the scissors from each wing. That forever limits their flight, and as a bird carries that part of its wing out of sight the lack of it would never be noticed.

I have always understood that it was undesirable to allow pheasants to do the hatching, the reasons given being that these birds are prone to leave nests and eggs on the slightest provocation, that their timidity and lack of affection for the young chicks make them poor mothers and that if allowed to set the possible further egg production would be cut off. The latter objection is well founded; but the first 2 are, I think, groundless.

Last year my golden pheasant hen, after laying 18 eggs, desired to set. I readily dissuaded her by putting her off the nest 2 or 3 times. Two weeks thereafter she laid 3 more eggs, which were unfertile, and then ceased for the season. This spring, after laying 14 eggs, she became broody, and though I would not risk wasting any pheasant eggs under her, I determined to give her a chance to raise a little family. After she had kept an empty nest warm for 3 days without, as far as I could see, leaving it to feed, I placed 6 bantam eggs just inside her basket. She wasted no time before drawing them under her with her beak, and cuddling down on them as though they were little chickens. For the next 3 or 4 days I never found her off the nest, but sitting there with her head under her wing, apparently asleep, day and night. Having heard of hens setting themselves to death, I became somewhat anxious. I offered her

grain from my hand, which she scorned. I drove her off the nest and tossed her food, but with the same result. As soon as I allowed her she ran back to her basket and resumed her task of incubation. Up to the 21 days I never saw her off her nest of her own accord, and have come to the conclusion that she must have fed in the early dawn. Two of the eggs progressed to the point where their inmates endeavored to break through their lime walls, but died in the attempt. The other 4 are now each running around on 2 little legs and being sheltered and cared for by one of the most gentle and affectionate mothers that ever graced a poultry yard.

I have decided that if this golden pheasant tenders her services next spring I shall not hesitate in awarding her the contract to bring to life and raise some little golden or Amherst pheasants for me.

T. C. W. Rolls, Detroit, Mich.

THE DEATH LOCK.

M. L. MICHAEL.

In 1880 I learned that Catfish pond, situated on the summit of the Blue Ridge, 1,400 feet above the sea, and only 80 miles from New York City, contained signs of otters, minks, coons, and muskrats. November 2d of that year I repaired thither and was soon engaged in gathering the pelts of many animals. My only companions were 2 dogs trained to trail deer and foxes. These sharers of my solitude were surly fellows, never making friends with the hunters who occasionally passed my camp. I usually left the dogs on guard while I visited my traps, but once or twice I took them with me.

On one of these occasions they suddenly sprang forward, barking excitedly, and after running 100 yards stopped and barked fiercely. Supposing they had treed a bear I hurried forward, Winchester in hand, emerging into what, at first, seemed a small clearing, the underbrush being trodden down. In the center of this space were 2 bucks, one down, the other standing, with their antlers inseparably interlocked. They were enfeebled and emaciated beyond belief, mere skeletons with the skin stretched over them, a sight never to be forgotten.

Pitying the poor brutes, my first impulse was to free them. Laying down my rifle I stepped on an antler of the prostrate buck, and with my hands attempted to spread them. I should probably have

succeeded, but the standing deer twisted his head viciously, and ripped my calf with a spike, making a wound nearly an inch deep and 6 inches long. Luckily no arteries were ruptured, and while the wound bled profusely, it gave me no alarm. I thought of my hatchet, but that was in the tent. I had a small saw, but that, too, was at the camp. My next thought was to get the saw, but by that time I realized that both brutes were enraged. Their eyes blazed with green fires, which boded me no good could they but reach me.

Finally I picked up my rifle, stepped close to the foes, and placing the muzzle within a yard of the standing buck's antler I aimed at a point 3 inches from his forehead and pressed the trigger. With the release of tension caused by shattering the horn the owner of it fell. A feeble shake of his head released the other horn and he was free.

I retreated a little and called my dogs away. Staggering feebly to his feet the one-horned beast made straight for me, stumbling and falling as he came. I easily eluded him, and climbing into a fallen tree-top laughed at his futile rage.

The other buck made many attempts to rise, but was too weak. Thus I left them till the next afternoon, when curiosity took me to the scene again. The broken-horned buck was gone; his prostrate foe lay in much the same position as before, but gored to death. Forty yards from me his murderer, a large, 5-pronged fellow, darted from a patch of redbrush. I fired 3 times as he ran, and then heard his antlers rattle on the rocks. His spikes were covered with freshly dried blood. I had avenged the helpless one.

AN ENTERTAINING HOSTESS.

My family and I spent July 5th at Uneva lake, which is about 30 miles from Leadville, Colo. My 2 sons, my nephew and I decided to go to the top of the mountain. We left the cabin at 9 a. m. and reached the summit at 2 p. m. After resting awhile we started back. As we got some distance below timber-line, and were going down a steep part of the mountain, I nearly ran onto a mountain grouse before I could stop myself. She did not attempt to fly, so I sat down within reach of her. I then called the boys and had them come where I was, from the upper side, so as not to alarm the bird. When they had taken their places beside and above me, and we had admired the lady a few minutes, I commenced moving my cane toward her. When the stick got near enough she pecked at it 3 or 4 times, and when she found it did not harm her she allowed me to place the end of it on her back without alarm. This incited me to further overtures, so I laid the stick down and commenced putting my hand

toward her. She did not take alarm. She only picked my hand a few times and then quit. I put my hand under her and then raised her a little. Imagine our surprise and pleasure at finding a brood of little ones, the last one of which we saw kick himself free from the shell. The empty shells were still under her, and after I had taken them out and thrown them aside I took one of the little fellows in my hand for the boys' inspection, replacing it directly under its mother. By that time we seemed to understand each other, as she made no objections to my actions.

Feeling refreshed by our rest and experience, we were ready to proceed, but I could not resist the temptation to experiment further with the little mother. I placed my hand under her again and gently raised and pushed her off the nest. When she attempted to stand on her feet she slipped off the earthen shelf whereon the nest was located, so she could just look into the nest by stretching her neck. We immediately got up, shyed off to one side, and started down the mountain, at the same time watching our mountain grouse climb back on the nest, which she lost no time in doing. A. N. Flinn, Harlem, N. Dak.

FOUR WAYS TO KILL A MOLE.

Can you tell me any way to kill a pocket gopher? One of these animals has lived in my lawn the past 5 years and done no end of damage. Have tried poison, but without success. I get up in the morning and find half a dozen heaps of dirt the size of a peck measure scattered over the grass. F. A. Olds, Minneapolis, Minn.

I referred the foregoing letter to an expert trapper, who replied as follows:

The "pocket gopher" mentioned in the letter you referred to me, is undoubtedly a mole. The heaps of earth are thrown up in excavating chambers at the intersection of several tunnels or galleries.

The most successful method of taking the mole is by means of the mole-spear trap, found at hardware stores. Where the mole hills appear the animal can not be taken by a trap, for the reason that at those points the runway is too far beneath the surface; but usually within a few yards of a hill the runway comes so near the surface that the earth is upheaved in a well defined track. There is the place to set the spear. The mole, in passing through his tunnel, lifts the trigger of the trap and the tines of the poised spear descend and impale the animal.

Moles feed on grubs and angle worms almost entirely; vegetable matter not being eaten. If the galleries run so deep that the earth is not cracked on the surface, the trap can not be used. In that case I advise that a few worms or grubs be

broken, and sprinkled with Paris green, and dropped in the gallery, which must be again covered, but not filled, with a sód. The spear-trap, however, is far and away the best when it can be used, as moles do not take poisoned bait readily.

Where a mole is working in the early morning he may sometimes be located by the cracking earth. Thrust a spade deep down behind the worker and with a quick pry throw him out before he has time to turn to one side. The trap should be set immediately after a gallery cracking the surface has been made, as the mole is apt to go elsewhere on short notice. Another way to get rid of the rascal is by drowning him out.

J. A. Newton, Grand Rapids, Mich.

LOVERS OF BIRDS

In the creation of birds nature has seemed to express a love of beauty. Many birds appear to have no mission save to charm the senses. The artistic brilliancy of their coloring, the grace of their motion, the melody of their note, unite to add joy to the world. Thus the finer mind, such a mind as loves the flower, the verdure of the forest, and the matchless blue of the sky, loves the bird. To harm it would be a cruel impulse. One who would visit a gallery and thrust a knife through some splendid canvas would be handed over to the police; but there are those who will kill birds apparently for the purpose of seeing the gorgeous plumage disheveled and blood-stained, and the little body, incarnation of innocence and grace, fall quivering, as the song dies into silence. The spirit that makes possible these outrages is the outcropping of a latent savagery. Birds are slain that their feathers may adorn a hat. Perhaps this strikes the wearer of the hat as a trifle, but it is not a trifle; it is a monstrous perversion of instincts that should be gentle. As a symptom it is to be deplored. As to its visible effect, it robs the forests and the fields of their finest adornment. In the far land where the heron breeds hunters go for the purpose of securing trimming for the hats of womankind, rather than of kind for woman. At a certain season the heron seeks a mate and at that time he is adorned with a nuptial plume. The hunter desires this plume, and shoots the heron. The slender plume is used as an aigrette, and the lady who is proud of the stolen trophy waving above her has no thought of the female left mateless, and the fledglings that must have starved. If she stopped to think she would blush for shame and to her eyes there would come tears of pity. Fashion is a cruel mistress. Her dictates demand the slaying of the fairest of animate objects. The oriole, decked with flam-bent yellow, the robin with breast of red, the lark, the thrush, the linnet, the tiny hummer, scarce bigger than the bumblebee; the soaring eagle, the diving loon, the dove, emblematic of peace, all are claimed as victims of this cruel mistress. There can be no excuse. Wings and feathers on a hat are as surely barbaric as when they crown the war bonnet of an Indian chief. A bird society has been formed in Tacoma, and success be to it. In so far as it protects the birds it will do good, and in awakening an interest in the study of the habits and haunts of the messengers of the upper air it opens a field where investigation brings the student in close touch with one of the most captivating themes afforded by the material world. The society can discourage the murder of birds either by wanton boys or thoughtless people old enough to know better.—Tacoma (Wash.) Daily Ledger,

SPIDER BALLOONS.

Spider balloons, such as was seen by Mr. Bray are not uncommon here. It is most interesting to watch their construction and launching. The spider chooses a clear day with a light West wind. Climbing to the top of a rock or post, she faces the wind and raising the back part of her body, she throws out her web. Instead of joining the different threads as for an ordinary web, she keeps them apart and tangles them with her hind feet into a flossy, silvery white mass, 2 to 10 feet long and $\frac{1}{2}$ inch to 2 inches wide. Occasionally she will raise and lower her body as if to test the lifting power of the web. When satisfied it will carry her, she spins a thread that permits the balloon to float away a few inches. Then giving a little spring she sails away, head down, holding the thread with her hind feet. Toward night, as it becomes cool and damp, the balloon loses its buoyancy and slowly descends. When it is near the earth the spider lets herself down by a thread until she catches some object. Then she cuts the thread and lets the balloon go.

C. Riblet, Litchfield, Mich.

I have seen many spider balloons like the one described by J. B. Grey, though to me they seemed more like parachutes than balloons. I saw them in Northern Alabama, along the Tennessee river. The stream is there about $1\frac{1}{2}$ miles wide, and I have seen many spiders far out over the water, as if they intended crossing. They seem to have some control over the movements of the bunch of web. I once saw a spider rolling a long web as if he wished to change the angle of his parachute. The spiders were never large and the web seldom more than 3 or 4 inches across, with a pendant thread 50 feet or more in length. On this thread the spider stays, about 2 feet below the bunch of web.

W. H. T., Kyle, W. Va.

SHOULD TEACH NATURAL HISTORY.

During the past 25 years laws have been passed throughout our country, regulating, to a certain degree, what shall be taught in our public schools. The small wooden schoolhouses are being rapidly replaced, even in small villages, by better buildings and better equipments. The old-time standard of "the 3 R's" has gradually been changed, until now it is common to hear the school-boy talking of physiology, botany and geology, as well as of many subjects bearing on art and letters. With all that is being done, the birds and animals, the creatures that give us most pleasure, and that, too, at all seasons of the year, are left out of the curriculum. How common it is to find men and women who can not distinguish the chirp or song of the

robin from that of our many other songsters! How many there are who enjoy a summer outing in the country, and yet can not tell one from another a single species of our common birds. Would not even a small knowledge of the wild life they see on every hand add to the pleasures of their outing? Much might be said along this line alone, but pleasure is not the only object to be gained. If in the public schools an elementary knowledge of our common birds and animals could be gained, it would tend to a greater interest in them, because then observation would have a foundation to work from. Then in 25 years from now we would not have such a multitude of bird killers and game destroyers as we now have. The ideas of game protection and preservation would prevail throughout the land. The school-boy would stop robbing nests, and the live bird would be of more interest to him than the dead one.

Dr. C. B. A., Keene, N. H.

FOLLOW THIS EXAMPLE.

I have 2 fish ponds stocked with trout. I have not been very successful with the increase, but those sent me from the State hatchery grow very fast.

I am protecting a large family of beavers, having a mile and a half of river front. I have it fenced off so stock can not tread the bank where the beavers are and I leave them cottonwood and willow to work on. There are quails here in abundance. I stack my grain in the timber and cut corn and shock at the edge of the timber for the quails and prairie chickens to feed on. The timber squirrels feed on nuts and fruits of various kinds. If the winters are too severe they come to my granaries and cribs for feed. Next spring I expect to set some Chinese pheasant eggs. My plan is to set them under a turkey hen and let her take them to the woods and raise them. Can you give me any information in regard to raising pheasants?

J. B. Berry, Paddock, Neb.

Here is a Moses for the wild animals and birds. Would we had such farmers everywhere! I trust the time may soon come when we may have at least one such shining example as Mr. Berry in each county in the United States.—EDITOR.

WHAT SORT OF A WORM?

One day, noticing a commotion among my chickens, I went out to see what had frightened them. They acted like they had seen a snake. On the bare ground at the foot of a cherry tree was what appeared to be the head and neck of a small snake. It was reddish brown with a round head; and its wicked little green

eyes, circled with white, seemed to watch every motion. It swayed its head and neck to and fro and darted its tongue out repeatedly. I called to my daughter to come and see it. The head and neck was perhaps $\frac{1}{2}$ inch in thickness and $1\frac{1}{2}$ inches in length. Supposing its body was in the earth, we got the hoe to dig it up. To our surprise we found that what we had taken for a head and neck was the entire creature. We took it to the house, examined it with a reading glass, and discovered it had a small head, which it could project a little, and 2 eyes, which filled the whole front of this little head. The strange spots that looked so much like eyes were only spots, and the forked tongue was only the antennæ. I never saw anything like it before, and the chickens certainly believed it to be a snake.

Mrs. A. M. Marriott, Vernon, Ia.

NATURAL HISTORY NOTES.

Coming across the gulf from Havana, Cuba, to Mobile, last April, with a detachment of the 7th Cavalry, I was awakened on the morning of the 15th by the cries and squawks of many kinds of birds. It was just growing light and was foggy as I went on deck. I was astonished to see numbers of great blue herons, night herons, little green herons, least bitterns, kingfishers and kingbirds flying in and out of the fog and alighting on the rigging. A little bittern found his way down in the hold, among the horses and mules. He was captured, but soon released. When the fog cleared the larger birds left the boat, but some of the smaller ones remained several hours. The steamer was over 200 miles from land. The birds, of which there must have been over 100, seemed bewildered by the fog and glad of a resting place. They could not have been blown out to sea by a storm, as the weather for several days had been calm; so I suppose they were migrating North from the West Indies. Is it the habit of birds of such widely different varieties to migrate together?

C. O. Moseley, M. D., Lytle, Ga.

Have just read Fred Wahl's letter about providing homes for birds. I am glad there is one person who realizes that a bird house should resemble as much as possible the natural nesting place of the bird. Ornate little structures with doors, windows and gable roofs are absurd when one considers the purpose for which they are intended. The diameter of a hole that will admit tree swallows while excluding sparrows, could be easily found by experiment. It will be between 1 and $1\frac{1}{4}$ inches. For the tree swallow the entrance should be as near the top of the box as possible.

Edmond Sawyer, Englewood, N. J.

THE LEAGUE OF AMERICAN SPORTSMEN.

OFFICERS OF THE L. A. S.

President, G. O. Shields, 23 W. 24th St., New York.

1st Vice-President, E. T. Seton, 80 West 40th St., New York.

2d Vice-President, W. T. Hornaday, 2969 Decatur Ave., Bedford Park, N. Y.

3d Vice-President, Dr. T. S. Palmer, Dept. of Agriculture, Washington, D. C.

4th Vice-President, A. A. Anderson, 80 West 40th St., New York.

5th Vice-President, Hon. W. A. Richards, General Land Office, Washington, D. C.

Secretary, A. F. Rice, 155 Pennington Ave., Passaic, N. J.

Treasurer, Austin Corbin, of the Corbin Banking Co., 192 Broadway, New York City.

ARIZONA DIVISION.

M. J. Foley, Chief Warden, Jerome.

ARKANSAS DIVISION

W. R. Blockson, Chief Warden, Eureka Springs.

CALIFORNIA DIVISION.

Dr. David Starr Jordan, Chief Warden, Leland Stanford University. C. Barlow, Sec.-Treas., Santa Clara.

COLORADO DIVISION.

A. Whitehead, Chief Warden, 303 Tabor Building, Denver.

CONNECTICUT DIVISION.

Hon. F. P. Sherwood, Chief Warden, Southport; Dr. H. L. Ross, Vice-Warden, Canaan; H. C. Went, Sec.-Treas., Bridgeport.

DISTRICT OF COLUMBIA DIVISION.

C. H. Townsend, Chief Warden, U. S. Fish Commission.

FLORIDA DIVISION.

W. W. K. Decker, Chief Warden, Tarpon Springs

GEORGIA DIVISION.

J. J. Doughty, Chief Warden, Augusta.

IDAHO DIVISION.

L. A. Kerr, Chief Warden, Kendrick

ILLINOIS DIVISION.

M. D. Ewell, M.D., Chief Warden, 59 Clark St., Chicago; F. M. Taber, Vice Warden, 144 Kinzie St., Chicago; G. C. Davis, Sec.-Treas., 123 S. Central Ave., Austin.

INDIANA DIVISION.

Frank L. Littleton, Chief Warden, 30½ East Washington St., Indianapolis; J. J. Hildebrandt, Vice Warden, Logansport; T. J. Carter, Sec.-Treas., State House, Indianapolis.

IOWA DIVISION.

Carl Quimby, Chief Warden, Des Moines; C. C. Proper, Sec.-Treas., Des Moines.

KANSAS DIVISION.

O. B. Stocker, Chief Warden, Wichita; A. J. Applegate, Sec.-Treas., 113 E. 1st St., Wichita

KENTUCKY DIVISION.

Geo. C. Long, Chief Warden, Hopkinsville.

R. L. Brashear, Sec.-Treas., Bowling Green.

MAINE DIVISION.

Col. E. C. Farrington, Chief Warden, Augusta.

MARYLAND DIVISION

J. E. Tylor, Chief Warden, Baltimore.

MASSACHUSETTS DIVISION.

Heman S. Fay, Chief Warden, Hazleton Block, Marlboro; J. E. Tweedy, Vice-Warden, North Attleboro; A. C. Lamson, Sec.-Treas., 194 Main St., Marlboro.

MICHIGAN DIVISION.

J. Elmer Pratt, Chief Warden, Grand Rapids; R. S. Woodliffe, Vice-Warden, Jackson; A. B. Richmond, Sec.-Treas., Grand Rapids.

MINNESOTA DIVISION.

Dietrich Lange, Chief Warden, 2294 Commonwealth Ave. St. Paul; H. A. Morgan, Vice-Warden, Albert Lea; A. R. Bixby, Sec.-Treas., 101 Baldwin St., St. Paul.

MISSOURI DIVISION.

Bryan Snyder, Chief Warden, 726 Central Bldg., St. Louis.

MONTANA DIVISION.

Professor M. J. Elrod, Chief Warden, Missoula; Sidney M. Logan, Vice-Warden, Kalispell; R. A. Waagner, Sec.-Treas., Bozeman.

NEBRASKA DIVISION.

Fred. E. Mockett, Chief Warden, Lincoln; P. O'Mahony, Sec.-Treas., Lincoln.

NEVADA DIVISION.

Dr. W. H. Cavell, Chief Warden, Carson.

Geo. W. Cowing, Sec.-Treas., Carson.

NEW HAMPSHIRE DIVISION.

Dr. A. F. Barrett, Sentinel Bldg., Keene,

Sidney Conant, Sec.-Treas., Keene.

NEW JERSEY DIVISION.

A. W. Van Saun, Chief Warden, Pompton Plains; Dr. W. S. Colfax, Vice-Warden, Pompton Lakes; I. V. Dorland, Sec.-Treas., Arlington.

NEW MEXICO DIVISION.

W. M. Borrowdale, Chief Warden Magdalena.

NEW YORK DIVISION.

John R. Fanning, Chief Warden, Powers' Bldg., Rochester; Col. R. E. Moss, Vice-Warden, Wallack's Theatre, New York City; Dr. C. C. Curtis, Sec.-Treas., Columbia College, New York City.

NORTH DAKOTA DIVISION.

Dr. W. D. Jones, Chief Warden, Devil's Lake.

OHIO DIVISION.

W. E. Gleason, Chief Warden, Mitchell Bldg., Cincinnati; A. C. Thatcher, Vice-Warden, Urbana.

OKLAHOMA DIVISION.

W. M. Grant, Chief Warden, Oklahoma City.

ONTARIO DIVISION.

C. A. Hammond, Chief Warden, Box 701, St. Thomas; D. L. Mells, Sec.-Treas., St. Thomas.

OREGON DIVISION.

Robert F. Kelly, Chief Warden, Box 188, The Dalles; C. B. Cushing, Sec.-Treas., The Dalles.

PENNSYLVANIA DIVISION.

C. F. Emerson, Chief Warden, 189 N. Perry St., Titusville; Hon. C. B. Penrose, Vice-Warden, 1720 Spruce St., Philadelphia; E. Wager-Smith, Sec.-Treas., 1026 Ridge Ave., Philadelphia.

RHODE ISLAND DIVISION.

Zenas W. Bliss, Chief Warden, 49 Westminster St., Providence.

SOUTH CAROLINA DIVISION.

C. F. Dill, Chief Warden, Greenville.

SOUTH DAKOTA DIVISION.

D. C. Booth, Chief Warden, Spearfish; John C. Barber, Sec.-Treas., Lead.

TENNESSEE DIVISION.

Hon. G. C. Martin, Chief Warden, Clarksville; Hon. Austin Peay, Jr., Sec.-Treas., Clarksville.

TEXAS DIVISION.

Prof. S. W. Stanfield, Chief Warden, San Marcos; W. E. Heald, Sec.-Treas., San Angelo.

UTAH DIVISION.

Hon. John Sharp, Chief Warden, Salt Lake City.

VERMONT DIVISION.

W. E. Mack, Chief Warden, Woodstock; S. C. White, Sec.-Treas., Woodstock.

VIRGINIA DIVISION.

Franklin Stearns, Chief Warden, 13 N. 11th St., C. O. Saville, Vice-Warden, Richmond; M. D. Hart, Sec.-Treas., 1217 East Main St., Richmond.

WASHINGTON DIVISION.

F. S. Merrill, Chief Warden, Spokane; F. A. Pontius, Sec.-Treas., Seattle; Munro Wyckoff, Vice-Warden, Pt. Townsend.

WEST VIRGINIA DIVISION.

E. F. Smith, Chief Warden, Hinton,
WISCONSIN DIVISION.

Frank Kaufman, Chief Warden, Two Rivers; Dr.
A. Gropper, Sec.-Treas., Milwaukee.

WYOMING DIVISION.

H. E. Wadsworth, Chief Warden, Lander; Frank
Bond, Sec.-Treas., Cheyenne.

*Applications for membership and orders for badges
should be addressed to Arthur F. Rice, Secretary, 23 W.
24th St., New York.*

LOCAL WARDENS IN NEW YORK.

County.	Name of Warden.	Address.
New York,	Conrad L. Meyer,	46 W. Broadway.
Livingston	M. De La Vergne,	Lakeville.
	K. S. Chamberlain,	Mt. Morris.
Albany,	C. D. Johnson,	Newtonville.
"	Henry T. Newman,	"
"	Kenneth E. Bender,	Albany.
Broome,	John Sullivan,	Sanitaria Springs
"	R. R. Mathewson,	Binghamton.
Cayuga,	H. M. Haskell,	Weedsport.
Chemung,	Fred. Uhle,	Hendy Creek,
"	M. A. Baker,	Elmira.
Cortland,	James Edwards,	Cortland.
Erie,	E. P. Dorr,	103 D. S. Morgan Building, Buffalo.
"	Marvin H. Butler,	Morilla.
Essex,	W. H. Broughton,	Moriah.
Franklin,	Jas. Eccles,	St. Regis Falls.
Montgomery,	Charles W Scharf,	Canajoharie.
Oneida.	J. M. Scoville,	Clinton.
Orange,	Wilson Crans,	Middletown.
"	J. Hampton Kidd,	Newburgh.
"	Thomas Harris,	Port Jervis.
Richmond,	Lewis Morris,	Port Richmond.
St. Lawrence,	Dr. B. W. Severance,	Gouverneur.
"	A. N. Clark,	Sevey.
Schenectady,	J. W. Furnside,	Schenectady.
Suffolk,	F. J. Fellows,	Central Islip, L. I.
"	P. F. Tabor,	Orient, L. I.
Tioga,	Geo. Wood,	Owego.
Washington,	C. L. Allen,	Sandy Hill.
"	A. S. Temple,	Whitehall.
"	J. E. Barber,	Dresden.
Westchester,	George Poth,	Pleasantville.
"	Chas. Seacor,	57 Pelham Road, New Rochelle.
"	M. W. Smith,	Croton Falls.
"	Ralph Gorham,	Mt. Kisco
Dutchess,	A. B. Miller,	Jackson's Corners
Columbia,	James Lush,	Memphis.
Onondaga,	B. L. Wren,	Penn Yan.
Yates,	Symour Poineer,	Branch Port.
"	Chas. H. DeLong,	Pawling.
Dutchess,	Jacob Tompkins,	Billings.
Queens,	Gerard Van Nostrand,	Flushing, L. I.
"	W. S. Mygrant,	46 Elton Street, Brooklyn.
"	P. A. Geepel,	473 Grand Ave., Astoria, L. I.
"	L. B. Drowne,	119 Somers Street, Brooklyn.
Ulster,	M. A. DeVall,	The Corners.
"	Wm. S. Mead,	Woodstock.
Jefferson,	C. J. Smith,	Watertown.
Herkimer,	D. F. Sperry,	Old Forge.
Oswego,	J. E. Manning,	154 West Utica St.
Putnam,	H. L. Brady,	Mahopac Falls.
Schuyler,	G. C. Fordham,	Watkins.
Allegany,	G. A. Thomas,	Belvidere.
Schoharie,	O. E. Eigen,	Sharon Springs.
Warren,	Geo. McEchron,	Glen Falls.
Orleans,	J. H. Fearby,	E. Shelby.
Greene,	W. J. Soper,	Windham.

LOCAL WARDENS IN OHIO.

Stark,	A. Dangeleisen,	Massillon.
Franklin,	Brook L. Terry,	208 Woodward Av., Columbus.
Cuyahoga,	A. W. Hitch,	161 Osborn St., Cleveland.
Clark,	Fred C. Ross,	169 W. Main St., Springfield.
Erie,	David Sutton,	418 Jackson St., Sandusky.
Fulton,	L. C. Berry,	Swanton.
Hamilton,	W. C. Rippey,	4465 Eastern Ave., Cincinnati.

County.	Name of Warden.	Address.
Allen,	S. W. Knisely,	Lima.
Knox,	Grant Phillips,	Mt. Vernon.
Lorain,	T. J. Bates,	Elyria.
Ottawa,	Frank B. Shirley,	Lakeside.
Muskingum,	Frank D. Abell,	Zanesville.
Scioto,	J. F. Kelley,	Portsmouth.

LOCAL WARDENS IN CONNECTICUT.

Fairfield,	George B. Bliss.	2 Park Row, Stam- ford, Ct.
	Harvey C. Went,	11 Park St., Bridge- port, Ct.
Fairfield,	Samuel Waklee,	Box 373, Stratford.
Litchfield,	Dr. H. L. Ross,	P. O. Box 100, Can- naan, Ct.
Middlesex,	Sandford Brainerd,	Ivoryton.
New Haven,	Wilbur E. Beach,	318 Chapel Street, New Haven, Ct.
"	D. J. Ryan,	188 Elizabeth St., Derby.

LOCAL WARDENS IN MASSACHUSETTS.

Norfolk,	Orlando McKenzie,	Norfolk.
"	J. J. Blick,	Wrentham.
"	S. W. Fuller,	East Milton.
Suffolk,	Capt. W. J. Stone.	4 Tremont Row, Boston.
Worcester,	B. H. Mosher,	Athol.

LOCAL WARDENS IN NEW JERSEY.

Mercer,	Jos. Ashmore,	124 Taylor St., Trenton.
Mercer.	Edw. Vanderbilt,	Dentzville, Trenton.
"	Roland Mitchell,	739 Centre St., Trenton
Morris,	Joseph Pellet,	Pompton Plains.
"	Chas. W. Blake,	Dover.
"	Francis E. Cook,	Butler.
"	Calone Orr,	Hibernia.
Somerset,	G. E. Morris,	Somerville.
Sussex,	Isaac D. Williams,	Branchville.
Union,	A. H. Miller,	Cranford.
	C. M. Hawkins,	Roselle.
Warren,	{ Jacob Young, Reuben Warner, }	Phillipsburg.
Monmouth.	Dory-Hunt,	Wanaque.
Hudson,	A. W. Letts,	51 Newark St., Hoboken.

LOCAL WARDENS IN PENNSYLVANIA.

Jefferson,	John Noll,	Sykesville.
Perry,	Samuel Sundy,	Lebo.
Warren.	F. P. Sweet,	Goodwill Hill.
	Nelson Holmes,	Cornplanter.
Juniata,	Clifford Singer,	Oakland Mills.
	Ezra Phillips,	McAlesterville.
Venango,	G. D. Benedict,	Pleasantville.
Potter,	Ira Murphy,	Coudersport.
"	Wiley Barrows,	Austin.
"	Chas. Barrows,	Austin.
Crawford,	Jasper Tillotson,	Tillotson.
"	Geo. T. Meyers,	Titusville.
"	J. B. Lamb,	Buel.
Cambria,	W. H. Lambert,	720 Coleman Ave., Johnstown.
Butler,	F. J. Forquer,	Murrinsville.
Allegheny,	S. H. Allen,	Natrona.
Beaver,	N. H. Covert,	Beaver Falls.
	W. R. Keefer,	"
McKean,	C. A. Duke,	Duke Center.
"	L. P. Fessenden,	Granere.
"	Wm. Holsinger,	Stickney.
Lackawanna,	Wm. Weir,	Mosic.
"	Wm. Major,	"
Carbon,	Asa D. Hontz,	East Mauch Chunk.
Cumberland,	J. C. Gill,	Mechanicsburg.
Wyoming,	Cyrus Walter,	Tunkhannock.
Tioga,	E. B. Beaumont, Jr.,	Lawrenceville.
	G. H. Simmons,	Westfield.
Lycoming,	Jas. J. Brennan,	Oval.
"	B. D. Kurtz,	Cammal.
Delaware,	Walter Luson,	Ardmore.
Montgomery,	L. C. Parsons,	Academy.
Bradford,	Geo. B. Loop,	Sayre.
Clarion,	Isaac Keener,	New Bethlehem.
Cameron,	Harry Hemphill,	Emporium.
Clinton,	M. C. Kepler,	Renovo.
"	Geo. L. Kepler,	Renovo.
Northumber-land,	{ G. W. Roher, 505 Anthracite St., }	Shamokin.
Elk,	D. R. Lobaugh,	Ridgway.

LOCAL WARDENS IN MICHIGAN.

County.	Name of Warden.	Address.
Ottawa,	W. H. Dunham,	Drenthe.
Kalamazoo,	C. E. Miller,	Augusta.
Berrien,	W. A. Palmer,	Buchanan.
Cass,	Thomas Dewey,	Dowagiac.
Hillsdale,	C. A. Stone,	Hillsdale.
Lake,	John Trieber,	Peacock.

LOCAL WARDENS IN VIRGINIA.

Mecklenburg,	J. H. Ogburn,	South Hill.
King William,	N. H. Montague,	Palls.
Smythe,	J. M. Hughes,	Chatham Hill.
King & Queen,	R. D. Bates,	Newtown.
Louisa,	J. P. Harris,	Applegrove.
Henrico,	W. J. Lynham,	412 W. Marshall.
Richmond,		Richmond.
Harrisonburg,	E. J. Carickhoff,	Harrisonburg.

LOCAL WARDENS IN WYOMING.

Fremont,	Nelson Yarnall,	Dubois.
Uinta,	{ S. N. Leek,	} Jackson.
	{ F. L. Peterson,	
Carbon,	Kirk Dyer,	Medicine Bow.
Laramie,	Martin Breither,	Cheyenne.

LOCAL WARDENS IN TENNESSEE.

Sumner,	W. G. Harris,	Gallatin.
Stewart,	John H. Lory,	Bear Spring.
Robertson,	C. C. Bell,	Springfield.
Montgomery,	P. W. Humphrey,	Clarksville.
Madison,	H. T. Rushing,	Jackson.

LOCAL WARDENS IN NEBRASKA.

Hall,	E. C. Statler,	Grand Island
-------	----------------	--------------

LOCAL WARDENS IN NEW HAMPSHIRE.

Cheshire,	S. C. Ellis,	Keene.
Sullivan,	G. A. Blake,	Lempster.
"	J. W. Davidson,	Charlestown.

LOCAL WARDENS IN VERMONT.

Rutland,	Wm. J. Liddle,	Box 281, Fair Haven
Windsor,	F. A. Tarbell,	West Bridgewater.
Orleans,	E. G. Moulton,	Derby Line.
Essex,	H. S. Lund,	Granby.

LOCAL WARDENS IN ILLINOIS.

Rock Island,	D. M. Slottard,	12th Ave and 17th St., Moline.
Iroquois,	J. L. Peacock,	Sheldon.

LOCAL WARDENS IN OKLAHOMA.

Kiowa and Comanche Nation,	A. C. Cooper,	Ft. Sill.
----------------------------	---------------	-----------

LOCAL WARDENS IN IOWA.

Clinton,	D. L. Pascol,	Grand Mound.
Pottawattamie,	Dr. C. Engel,	Crescent.

LOCAL WARDENS IN WASHINGTON.

Okanogan,	James West,	Methow.
Stevens Co.,	Jacob Martin,	Newport.

LOCAL WARDENS IN UTAH.

Washington,	S. C. Goddard,	New Harmony.
"	J. A. Thornton,	Pinto.

LOCAL WARDENS IN KANSAS.

Ness,	Frank Lake,	Ransom.
-------	-------------	---------

LOCAL CHAPTERS.

Albert Lea, Minn.,	H. A. Morgan,	Rear Warden.
Angelica, N. Y.,	C. A. Lathrop,	"
Augusta, Mont.,	H. Sherman,	"
Austin, Minn.,	G. F. Baird,	"
Austin, Pa.,	W. S. Warner,	"
Boston, Mass.,	Capt. W. I. Stone,	"
Buffalo, N. Y.,	H. C. Gardiner,	"
Cammal, Pa.,	B. A. Ovenshire,	"
Champaign Co., O.,	Hy. F. MacCracken	"
Charlestown, N. H.,	W. M. Buswell,	"
Ch yenne, Wyo.,	J. Hennessy,	"
Choteau, Mont.,	G. A. Gorham,	"
Cincinnati, Ohio,	B. W. Morris,	"
Coudersport, Pa.,	I L. Murphy,	"
Cresco, Iowa,	J. L. Platt,	"
Davis, W. Va.,	J. Heltzen,	"
Dowagiac, Mich.,	W. F. Hoyt,	"
East Mauch Chunk, Pa.,	E. F. Pry,	"
Evansville, Ind.,	F. M. Gilbert,	"
Fontanet, Ind.,	W. H. Perry,	"
Ft. Wayne, Ind.,	W. L. Waltemarth	"
Great Falls, Mont.,	J. M. Gaunt,	"
Heron Lake, Minn.,	K. C. Buckeye,	"
Holidays'g, Pa.,	H. D. Hewit,	"
Hopkinsville, Ky.,	Hunter Wood,	"
Indianapolis, Ind.,	Joseph E. Bell,	"
Jerome, Ariz.,	Dr. L. A. Hawkins,	"
Johnsonburg, Pa.,	W. J. Stebbins,	"
Kalispell, Mont.,	John Eakright,	"

Keene, N. H.,	F. P. Beedle,	Rear Warden.
Kingfisher, Okla.,	A. C. Ambrose,	"
Lake Co., Ind.,	Dr. R. C. Mackey,	"
Lawton, O. T.,	Marion Miller,	"
Logansport, Ind.,	E. B. McConnell,	"
Ludington, Mich.,	G. R. Cartier,	"
Mechanicsburg, Pa.,	Dr. J. H. Swartz,	"
Minturn, Colo.,	A. B. Walter,	"
New Albany, Ind.,	Dr. J. F. Weathers,	"
New Bethlehem, Pa.,	Isaac Keener,	"
Penn Yan, N. Y.,	Dr. H. R. Phillips,	"
Princeton, Ind.,	H. A. Yeager,	"
Reynoldsville, Pa.,	C. F. Hoffman,	"
Ridgway, Pa.,	T. J. Maxwell,	"
Rochester, N. Y.,	C. H. McChesney	"
St Paul, Minn.,	O. T. Denny,	"
St. Thomas, Ont.,	L. J. Hall,	"
Schenectady, N. Y.,	J. W. Furnside,	"
Seattle, Wash.,	M. Kelly,	"
Syracuse, N. Y.,	C. C. Truesdell,	"
Terre Haute, Ind.,	C. F. Thiede,	"
The Dalles, Ore.,	C. B. Cushing,	"
Walden, N. Y.,	J. W. Reid,	"
Wichita, Kas.,	Gerald Volk,	"
Winona, Minn.,	C. M. Morse,	"

DISCOUNTS TO LEAGUE MEMBERS.

The following firms have agreed to give members of the L. A. S. a discount of 2 per cent. to 10 per cent. on all goods bought of them. In ordering please give L. A. S. number:

- Syracuse Arms Co., Syracuse, N. Y. Guns.
- Davenport Fire Arms Co., Norwich, Conn. Shot guns, rifles.
- Gundlach Optical Co., Rochester, N. Y. Photographic goods.
- Blair Camera Co., Rochester, N. Y. Photographic goods.
- The Bostwick Gun and Sporting Goods Co., 1528 Arapahoe St., Denver, Col.
- James Acheson, Talbot St., St. Thomas, Ontario, Sporting goods.
- Jespersen & Hines, 10 Park Place, New York City

LIFE MEMBERS OF THE LEAGUE.

- W. D. Ellis, 136 W. 72d street, New York City.
- A. F. Rice, 155 Pennington avenue, Passaic, N. J.
- Dr. W. A. Valentine, 5 W. 35th street, New York City.
- A. A. Anderson, 6 E. 38th street, New York City.
- A. V. Fraser, 478 Greenwich street, New York City.
- E. S. Towne, care National Bank Book Co., Holyoke, Mass.
- F. G. Miller, 108 Clinton street, Defiance, Ohio.
- Gen. J. F. Pierson, 20 W. 52d street, New York City.
- E. T. Seton, 80 W. 40th street, New York City.
- J. H. Seymour, 35 Wall street, New York City.
- A. G. Nesbitt, Maple street, Kingston, Pa.
- D. C. Beard, 204 Amity street, Flushing, L. I.
- C. H. Ferry, 1720 Old Colony Bldg., Chicago, Ill.
- Hon. Levi P. Morton, 681 5th avenue, New York City.
- H. Williams, P. O. Box 156, Butte, Mont.
- D. B. Fearing, Newport, R. I.
- E. H. Dickinson, Moosehead Lake, Me.
- Lorenzo Blackstone, Norwich, Conn.
- A. L. Prescott, 90 W. Broadway, New York City.
- G. S. Edgell, 192 Broadway, New York City.
- W. B. Mershon, Saginaw, Mich.
- Hon. H. W. Carey, East Lake, Mich.
- George Carnegie, Fernandina, Fla.
- Andrew Carnegie, 2nd, Fernandina, Fla.
- Morris Carnegie, Fernandina, Fla.
- W. L. Underwood, 52 Fulton street, Boston, Mass.
- C. E. Butler, Jerome, Ariz.
- Mansfield Ferry, 183 Lincoln Park, Boulevard, Chicago, Ill.
- Austin Corbin, 192 Broadway, New York City.
- J. Stanford Brown, 489 Fifth Ave., New York City.
- W. H. Smith, Bryn Mawr, Pa.
- E. B. Smith, Bourse Bldg., Philadelphia, Pa.
- A. J. McClure, 148 State street, Albany, N. Y.
- Walter Thompson, Times Bldg., New York City.
- Clinton Gilbert, 2 Wall St., New York City.

There are thousands of men in the United States who should be life members. Why don't they join? Will someone please take a club and wake them up?

WHAT ONE CHAPTER HAS DONE.

Editor RECREATION:

Becoming disgusted at the open violation of the game laws around El Paso, a few of us sportsmen joined the L. A. S. about 18 months ago. We at once served notice on the marketmen and express companies that violators would be punished. Result: Not a carcass to be seen last winter.

The building of the Sierra Madre road into Mexico opened up a game country; the like of which is not to be found elsewhere on the American continent. The Mormons began to establish colonies down there and soon game was coming in for sale. Mexico has no game laws and it looked as if we were "up against it;" but we went to work on the officials of the road and induced some of them to join the L. A. S. Then up went freight and express rates on game to 8 times regular rates; so we scored another victory and were happy.

The Sacramento mountains, 100 miles North of here, in New Mexico, have long been a game region. They are high and covered with heavy timber. Right on top, 9,000 feet above the set level, is Cloudcroft, the great cooling-off place for the arid Southwest. Nearly every business and professional man in El Paso owns a cabin in Cloudcroft, where his family can go to escape the heat. New Mexico has good game laws, but last summer League members visiting Cloudcroft could hear of game being killed by the squatters thereabout. One man, named Massey, was a notorious offender. It was all done in New Mexico and we live in Texas; but success had always perched on our banner and we went to work. We first wrote RECREATION, then Governor Otero. The El Paso daily papers took up the cause in the meantime and denounced the hogs. Soon Billy Smith was appointed warden and then Mr. Bristles began to subside, for Billy was known to be a terror to evil-doers. He has served many years on the police force of El Paso. It is said that when the chief gave Billy his star he told him to buy a revolver, but Billy replied that his fist was all he needed. When Governor Otero appointed him warden I met him on the street and said, "Now, Billy, go for them!" To-day, I met him again and he said, "Well, I caught one and have a warrant for another. No game is being killed up there now."

Thus the L. A. S. becomes a power in the land, reaching out its strong arm in every direction. RECREATION is on sale at all the news stands in El Paso. May it and the L. A. S. ever grow and may Coquina live 100 years.

Dr. J. I. Bush. El Paso, Texas.

Mr. Wm. Cunningham, of Attica, Ind., is doing some vigorous work in building up the League in that city and vicinity. He has sent in a large number of memberships already and has several other men on his list whom he is looking after. It is expected that he will eventually organize a strong chapter in Attica.

TO JACKOLA.

A. L. VERMILYA.

O Jackola,
Pianola,
Cocobola,
And such things,
Skip and patter,
Fly and scatter,
Or we'll ha'ter
Lend you wings.

O Jackola,
Give your soul a
Chance to roll a—
Round a few;
It needs raking
Out and shaking,
And then making
Over new.

Fish by millions,
Fish by billions,
Fish by trillions—
That's your style;
Gosh all thunder!
It's no wonder
Such a blunder
Stirs my bile.

When you're going,
Swiftly blowing
O'er the flowing
River Styx,
I am betting,
While you're fretting,
You'll be getting
In a fix.

You may gabble,
Scrap and scrabble
With the rabble
As you wish;
They'll not heed you,
For they'll need you,
And will feed you
To the fish.

Now, Jackola,
Pianola,
Cocobola,
Since it pays,
Cease your badness,
All your madness,
And with gladness
Mend your ways.

FORESTRY

EDITED BY DR. B. E. FERNOW,

Director of the New York School of Forestry, Cornell University, assisted by Dr. John C. Gifford of the same institution.

It takes 30 years to grow a tree and 30 minutes to cut it down and destroy it.

THE OUTLOOK FOR WOOD SUPPLIES.

Not more than 15 years ago most of the lumber journals were still expressing amusement at the efforts of those who attempted to influence methods of forest exploitation, on the ground that wood supplies are waning and that attention should be paid to their reproduction. At last it has dawned on the editors of these periodicals that even such "inexhaustible" supplies as the white pine were supposed to be come to an end. At present hardly a week's issue of these same journals is without some comment or some statement of fact which indicates the change of attitude. That the white pine, which is to date still the largest furnisher of wood material in the market, is doomed soon to be one of the rarer woods has for some time been admitted by the trade journals, and dates for its final exhaustion have been figured; a futile proceeding, since the rate of decimation must necessarily change as the supplies become smaller and the prices higher. It is interesting to note how one region after another is playing out, the latest being referred to by a lumber journal as follows:

La Crosse will not much longer be a lumber manufacturing point. For 50 years La Crosse was a great lumber city. Some of the finest white pine logs that ever grew in Wisconsin came down the old Black river and were sawed into lumber here. The lumber went out by rail and, previous to the days of railroads, by rafts, down the river to wholesale points. Those were busy days for this old town. Still, with the lumber manufacturing gone, other things have come to take its place, and La Crosse to-day is a more solid and substantial city than ever before. It is a practical illustration of the changes that are bound to come to all the Northern Wisconsin lumber towns of to-day, and if they all fare as well as La Crosse there can be no cause for complaint.

There will be no more logging of any importance done on Black river. The Black River Improvement Company has disposed of its interests to A. S. Trow & Co., who will hereafter personally take care of what logs they have coming down the river and those in the water belonging to other concerns. The next season will probably see all these logs down and sawed at La Crosse. What remains is mostly a few million feet of hemlock logs. The last white pine sawing will be done next year by the C. L. Colman Lumber Company. . . .

On another page the coming change is foreshadowed as follows:

While yellow pine and the Pacific coast woods are encroaching on the old white pine territory, the producers of the latter can comfort themselves with the reflection that their own home demand is fast increasing. The rapid settle-

ment of Minnesota and Northern Wisconsin and parts of Michigan, and the development of local industries, are annually requiring not only a much larger portion of the total lumber product of those States, but a much greater actual quantity. The time is not far distant when there will be what is practically a local demand for nearly the entire product.

The following editorial comment on the growing use of hard wood is also significant:

The present value of hard wood lumber, and particularly the value of hard wood stumpage, rests essentially on the same grounds on which have been established higher bases of value for Southern pine and Pacific coast timbers, namely, the waning supply of Northern pine. As white pine has become higher in price, substitutes have been sought, and while these have been found largely in other soft woods, hard woods also have contributed in no small degree.

In the year covered by the census reports, 1899, the hard wood output of the country was just about one-third that of the soft woods. It is probable that if a census could be taken for 1902 it would be found that the hard wood product might be two-fifths that of the conifers. . . .

It may be objected that the hard wood forests are disappearing as rapidly as those of pine. It is doubtful, however, if this be true, and certainly it is not true as regards many of the hard woods. They cover, more or less densely or mixed with coniferous growth, a large portion of the timbered area of the country. From the great lakes South to the Gulf States hard wood is the prevailing growth. Broad leaved trees are found mixed in larger or smaller proportions with the conifers in most States where the latter are the leading growth.

Some hard woods have been nearly wiped out. Such are walnut and cherry. Others have only begun to be utilized, like gum. It is probable that the present drain on the hard wood resources of the country will be met for a much longer period than will that on the pine resources, except on the Pacific coast, where the timber is almost entirely coniferous, and where, by its location, the coniferous woods lumber industry will be prolonged for generations.

The confidence in the holding out of these other resources to supply our present enormous demand is not based on safe grounds.

The same number of this trade journal contains reflections by a contributor which are worth quoting in this connection:

Few of the retail dealers appear to take any interest in the timber supply of the country. The merchant, as a rule, studies this subject less than the manufacturer. Let the saw mill man worry over the ammunition for his old mill! The yard man will buy one kind of lumber as long as he can get it and then he will buy some other kind. The merchant is the dispenser to the people, not the producer, and he most interests himself with his own line of work. Our lumber supply years hence will come from the West coast. Get

white pine, as a finish, out of the way; as dimension get hemlock out of the way; let our hard woods, in a larger measure than now, become exhausted, the beginning of the end of the Southern pine in sight, and what kind of an advantage do you think those West coast lumbermen will take of us? Shrewd white pine operators have bought billions of feet of timber, are buying it right along, and they are not in a hurry to manufacture it. It will be the last chance, and that means high prices.

In the light of these statements, coming from a trade journal that had always pooh-pooed the idea of waning supplies, the forest reservation policy of the Federal government and of the single State governments should be as rapidly as possible extended and the lumbermen should soon be made to see that there is need of looking out not so much for their future as the future of the community at large. Says the same trade journal:

Lumbermen who contemplate operating on government forest reserves are somewhat appalled by the following requirements embodied in their contracts with the government, backed by a bond:

I will pay in advance for all timber before cutting same. I promise to pay for all timber and material used in the construction of shanties or buildings of any kind; also for material used in the construction of skidways, corduroy, log roads, bridges and other improvements. I promise to leave no skids, logways, shanties, corduroy or other timbers I have used in the woods, and to haul bodily all tree tops and debris to the prescribed openings in the woods for burning. I promise to cut all tree tops into cordwood to blank inches in diameter, and see that no lodged trees are left behind.

There is no question that the observance of this regulation will assist the growth of the young timber and leave the reserves in fine shape, but the expense will make competition with ordinary logging operations almost impossible.

It is better that the lumbermen be somewhat appalled and perhaps be deterred from entering into such contracts until the need of looking after reproduction is thoroughly recognized by them, than to sacrifice the relatively small quantities of virgin timber now in the hands of the government.

DAMAGES BY THE LATE COAST FIRES.

While our legitimate needs for wood materials are large enough to make every foot of timber precious, we continue to allow wanton and negligent destruction by fire to decimate our supplies. The field agent of the forestry department of the Interior Department estimates that the forest fires which raged on the Pacific coast last September caused a total loss of \$12,767,100, of which \$3,910,000 fell to Oregon. This includes the value of timber, farm property and saw mills and their products which were destroyed. Owing to its nearness to market, however, much of the burned timber in Oregon will be saved, reducing the total loss as above set forth. It was found that 86 Oregon families were rendered

homeless, while 200 others suffered partial losses. In that State, farm property worth \$315,000 was burned, and saw mills suffered losses aggregating \$149,000. It is estimated that 2,124,000,000 feet of standing timber went up in smoke in Oregon, largely Douglas fir, spruce, cedar and hemlock. The total loss in timber alone was over \$3,000,000. In all, 170,000 acres were burned over, all of which, save 50,000, were well timbered.

In Washington 434,000 acres were burned over. The timber was fully as heavy as the Oregon timber, and of better quality. It is estimated that 5,026,800,000 feet of Douglas spruce alone was killed, representing a value of \$5,026,800. Other timber to the value of \$725,000 was destroyed. The total loss in Cowlitz, Clark and Skamania counties, where the fires were most disastrous, was \$6,600,000, and in the other burned areas, \$2,256,300.

PRESIDENT FAVORS FOREST RESERVES.

In his recent message to Congress, President Roosevelt, in speaking of forests, grazing and irrigation in our West, recommends that "in view of the capital importance of these matters, they be given the earnest consideration of Congress; and if the Congress finds difficulty in dealing with them from lack of thorough knowledge of the subject, that provision be made for a commission of experts specially to investigate and report upon the complicated questions involved."

In referring to Alaska he says: "The forests of Alaska should be protected, and as a secondary but still important matter, the game also. At the same time it is imperative that the settlers should be allowed to cut timber under public regulations for their own use."

Of great importance in this connection is the forest reservation which has been recently established in Alaska. The whole of the magnificent Alexander Archipelago was set aside as a forest reserve on the 20th of August, 1902. This contains 4,506,240 acres. The Afognak Forest and Fish Culture Reserve, which was set aside on the 24th of December, 1892, contains 403,640 acres, and covers the whole of the island of Afognak with adjacent islands and rocks. There are thus almost 5,000,000 acres of reserved land in Alaska. Afognak island is practically the Northern limit of the Coast Forest.

The bulk of the forest of Alexander Archipelago consists of Sitka spruce and the coast hemlock. The forest is dense only here and there. The timber is of medium quality and the islands are so rough and rocky that lumbering would be difficult and probably unprofitable.

PURE AND IMPURE FOODS.

"What a Man Eats He Is."

Edited by C. F. LANGWORTHY, PH.D.

Author of "On Citraconic, Itaconic and Mesaconic Acids," "Fish as Food," etc.

TRUFFLES AND TRUFFLE GROWING.

The French call truffles "kitchen diamonds, *le diamant de la cuisine*," a title which, in the opinion of French cooks, they deserve, on account of their perfection for culinary purposes. Truffles are a species of edible fungi which develop under ground. They could not be readily found by ordinary means, and, therefore, are hunted with the aid of pigs and dogs which are trained to search for them, being guided, probably, by their sense of smell.

According to a recent writer "truffles are still considered a great luxury, although they are comparatively cheap to what they were 60 years ago. Until within 50 years, the civilized world did practically without this luxury, which was, however, known and appreciated by the Romans. Brillat-Savarin, in his famous work, says that from the time of the Romans to the beginning of the 19th century there was a long *interregnum*, and that the resurrection of the truffle was then quite recent. The popularity of truffles is not confined to France alone, for they are much used and highly esteemed as a great delicacy throughout Europe and America. The finest specimens are found in France. Those found in some parts of England are of an inferior color and quality to those obtained from France, and in consequence command only a low price. The part of France known as the Department of the Vaucluse, situated in the Southeastern part of the country, between the Alps and the mouth of the Rhône, is the chief truffle-growing center. There the annual output averages 900,000 pounds. The season commences in November and ends in March, and the old town of Carpentras is the principal truffle market. The sales begin about 7 o'clock in the morning on market days, and much of the business is done in a large *café*, where the wine growers also meet to bargain for vine roots.

"In former years truffles were not cultivated. The peasants of the neighborhood went out to seek them wherever by chance they could be found. Pigs and dogs are trained to hunt for the truffles, which have a pungent odor appealing to the animals' sense of smell. Pigs especially enjoy the delicacy, and care has to be taken that they do not devour what they find. The method employed is for the truffle hunter to go out accompanied by a pig and carrying 2 bags,

one empty for truffles, and the other containing acorns. When a place is reached where truffles are to be found the pig digs a large hole with its snout, scattering the earth and stones right and left. The hunter keeps close watch, and as soon as a truffle is found gives the animal a tap on the snout, takes the truffle, and replaces it by putting a few acorns in front of the pig, which are eaten instead. Young pigs begin their education in truffle hunting when a month old. They then accompany their mothers. After a time some pigs get to be so well trained that they will dig, find the truffle, seize it in their teeth, and throw it on one side; but such well educated animals are to be found only on artificial farms. Two large sows have been known to find 50 pounds of truffles, valued at \$120, in 4 hours.

"Dogs are also trained and used instead of pigs. They go more quickly and are easier to lead and manage. Basset hounds and sheep dogs are principally used, but as they only point at the truffles and do not dig, they are chiefly employed by young men, who do the digging. Old men, women and children hunt with the pigs.

"In former years the idea of cultivating truffles would have been scouted. It was discovered one day by an enterprising farmer in the neighborhood of Carpentras, that truffles grew only under a certain species of oak. He picked the acorns off these trees and sowed them in November, close together, in furrows about 6 yards apart, and running from North to South. Moderate warmth is necessary for the production of truffles, and not too much humidity or too great dryness. The object of sowing the acorns so close together was that, as they always attract rats, a great number would be destroyed, and the young plants could easily be thinned as they grew. The plot of ground selected was not favorable for grain, and had never returned more than \$20 an acre. As truffles do not produce any results for 6 to 10 years after the planting of the oak trees, the farmer planted vines between the furrows, which produced sufficient fruit to more than pay the cost of culture. At the end of 10 years the vines were choked by the roots of the oaks. Great care must be taken not to put manure near the roots of the trees, for that would be fatal to the truffles."

ARTIFICIAL COLORING OF FOOD.

Professor M. A. Scovell, in speaking of the color in foods says:

"Certain colors are associated with the different foods and their condition. Boiled flour, granulated sugar and starch are white. Fruits present different shades of color by means of which the ripeness of the respective fruit is judged. Pears, peaches, and apples, grapes and berries show varying shades of red, purple and yellow. The richness of milk is sometimes judged by the yellow tinge from the globules of butter fat it contains. Fresh meats have a color distinct from that of spoiled meats. Vegetables, pickles, and some other foods of a similar character are green, or they present their individual garden color.

"In the market, foods are selected largely by their color. At the table, the eye aids the taste in pleasing the senses. Color, therefore, is an important factor in foods, and when the natural color is wanting, or condemns the article, the manufacturer supplies it artificially, or changes it to the color of a better article.

"Pastry and confectionery are colored, and the uses of artificial coloring matters that are harmless seem legitimate under proper restrictions in this class of foods. Many foods have their colors changed in the process of preservation, and the manufacturers seek to restore the original by adding some artificial coloring matter, as is especially the case with fruit products. When green vegetables are canned, their colors are preserved or set with copper, zinc, lead or alum; thus the green of peas, beans and pickles is kept from changing to unappetizing shades when they are canned.

"Artificial coloring matters are employed to cover deficiencies and to make the imitation appear like real. Skimmed milk is colored in order that it may appear rich; spirit vinegar is colored in imitation of cider vinegar, and artificial jellies are colored to the respective shades of the fruits they are labeled to have been made from. When artificial coloring matter is used to such an extent, or of such a poisonous character that the purity of the food is sacrificed for appearance, such use should be prohibited. When color is used to cover defects, inferiorities, or to imitate, its use is a fraud."

In every case, in samples of food recently examined, where the Kentucky law does not prohibit coloring matter on account of its poisonous character or fraudulent intent, the law commands that its use shall be made known to the customer and consumer. The artificial coloring matters found were mostly the aniline dyes, of which there are many forms. These dyes are made from coal tar products.

RESULT OF FEEDING SAWDUST.

Reading an article in December RECREATION on the value of sawdust as a food for cattle reminds me of an incident that is said to have occurred to one of my fellow townsmen. Not being addicted to hard work he wished to make some money in the easiest possible way. The idea occurred to him that if he would start a henery, the hens could lay the eggs, the children could gather them and he would exert himself enough to market them. After he had secured some hens it dawned on his bright intellect that he had not taken into consideration the question of food for the fowls. If he had to buy that it would make great inroads on the gross profits of the business. He therefore bought a small batch of second rate wheat, went to a sawmill near, and gathered a sack of sawdust, which he toted home. He then began feeding the fowls a mixture of wheat and sawdust, at first putting in but a small portion of the cheaper commodity, but each day decreasing the quantity of wheat and increasing the quantity of sawdust until finally the wheat was abandoned entirely and those overworked hens had a regular diet of sawdust 3 times a day. Strange to relate they seemed to thrive amazingly.

About the time he had taught the hens to live exclusively on sawdust, he realized that he could make more money by incubating the eggs and marketing broilers. Accordingly as soon as he could persuade one of the hens to set he put 13 eggs under her. He then awaited the process of incubation, which though slow was sure of results.

On the expiration of the requisite number of days, he repaired to the smokehouse, where he had installed mother hen, and yanking her off the nest discovered that she had performed her part well. The eggs had hatched out 2 clothespins, 9 croquet balls and one jumping jack.

E. M. Dorsey, Alton, Ill.

"Pop," said Farmer Korntop's boy insinuatingly, as he leaned on his hoe, "Tommy Perkins says the fish are bitin' right lively up the creek today."

"Well," replied the old man, "you tell him if he'll come over here an' help you with yer hoein'"——

"Yes, sir."

"They won't git a chanst to bite him."——
Philadelphia Press.

An old man was troubled with gout, and a cheap wine merchant sent him some sherry which he warranted as a specific. Some time after, the dealer received this acknowledgment: "Sir, I have tasted your wine, and I prefer the gout."——Exchange.

PUBLISHER'S NOTES.

ONCE IN A LIFETIME.

The E. Smith Indian Post Trading Company, of Detroit, Mich., makes a remarkable offer in its ad in this issue of RECREATION to lovers of Indian goods. It will pay every reader of RECREATION to examine and consider this ad carefully. The Navajo Indians are becoming so rapidly civilized that it is difficult to get any of them to make the blankets or other goods which they formerly made for their own use. The white man supplies them with good, warm blankets at nominal prices, and few of the Indians are sufficiently enterprising or industrious to be willing to spend weeks or months in weaving their native blankets, even for sale. No doubt the time will soon come when none of these people can be induced to do this work. Therefore persons who want genuine Navajo blankets must buy them in the near future. No such offer as that made by the Smith Trading Co. has ever before been announced, and probably will not be hereafter. Therefore if you want a Navajo blanket you should take advantage of the present opportunity. In ordering please mention RECREATION.

A BEAUTIFUL BOOKLET.

The Keystone Watch-Case Co., of Philadelphia, whose advertisement appears elsewhere in this issue, is sending out to applicants an illustrated booklet of 34 pages which is one of the most artistic of the year. It exploits the merits of the Jas. Boss Stiffened Gold Case—relates its history, explains its construction, tells how to identify it and warns against the substitution of a "just as good." A folder in the back of the book illustrates some of the patterns in which the case is made.

The unusual quality of the engraving and printing in this booklet, the harmony in its color scheme and its artistic excellence throughout, no less than the quality of its reading matter, will well repay those who send for it. It is sent free, on application to The Keystone Watch Case Co., Philadelphia.

When you ask for it please mention RECREATION.

C. B. Ryan, G. P. A. Seaboard Air Line R. R., Portsmouth, Va., has issued 3 beautiful pamphlets entitled "The Land of Manatee." These describe and illustrate that section of Florida lying along the West coast and adjacent to the Manatee river. Book No. 1 deals with the ancient and modern history of that region; No. 2

with the fruit and vegetable interests, and No. 3 is designed for the information of tourists, sportsmen and investors. The books are all beautifully illustrated and may properly be classed as choice specimens of high art printing. They would easily be worth 50 cents a copy in the book trade, merely for the pictures, but may be had free of charge by writing Mr. Ryan and mentioning RECREATION.

You should read the ad of W. H. Jones & Co. on the 2d page of cover of this issue of RECREATION, especially if you use wines and liquors. If you are buying goods in this line, you may just as well have the best the market affords, when you can buy pure, high grade goods on mail orders cheaper than you can buy at home.

Jones & Co. make a series of special offers in this issue of RECREATION that should certainly appeal to every reader who likes good wine or good whiskey. Read the ad carefully, and I can promise you that if you order goods from these people you will be fairly and honorably dealt with. In writing please mention RECREATION.

Woodstock, N. Y.

Northern Rubber Co.,

Minneapolis, Minn.

Dear Sirs—I have had occasion to use the Banner rubber coat while making a 5 mile drive in an open wagon through a pouring rain and wind. There was not the slightest dampness on the inside of the coat and I was as dry as a powder horn.

I can safely say to the L. A. S. members, "If you want a good coat at a reasonable price buy one of the Northern Rubber Co." Sincerely yours,

W. S. Mead, L. A. S. 136.

The Baker Gun and Forging Co., Batavia, N. Y., has been extending its plant to meet the requirements of increased business, and now hopes to be able to keep close up to its orders for goods. The Company turned out a number of special high finished guns for the holiday trade. The Baker Gun enjoys an excellent reputation among lovers of fine shooting arms. Some of the guns now in process of making combine with the best known materials a high degree of ornate decoration. Any shooter who would like to know all about these guns should write for the latest Baker catalogue and should mention RECREATION.

The Savage Arms Co. has issued a beautiful calendar for 1903, and Mr. Savage writes that although a large edition of it was printed, the supply is already exhausted. The picture on the calendar is an attractive one and nearly every sportsman who saw an advanced copy of it, fell over himself in his efforts to get one. As a result the whole lot was cleaned out before the company really got ready to announce the calendar. I regret this, for there are thousands of hunters who would like to have had a Savage calendar for 1903. I trust that next year the company may print enough calendars to go around.

The Marble Safety Axe Company is still extending its lines of goods rapidly. Its latest device for sportsmen is a safety pocket knife, which is advertised in this issue of RECREATION. This is an article sportsmen have long needed, and I am glad Marble has provided for supplying the demand. His goods are made to use and to keep, and any man who buys one of his knives will be careful not to lose it. Send for a circular of this latest invention, and I feel confident that the next thing you do after reading the description will be to order one of the knives. When writing please mention RECREATION.

The Audubon calendar for 1903, issued by the Massachusetts Audubon Society, consists of 6 beautiful plates, each showing a reproduction of an important species of New England bird. These plates are printed in the exact natural colors of the different species and the drawings are scientifically accurate. Every bird lover should have a copy of this attractive calendar. The price is 50 cents and all orders should be addressed to Miss Harriet E. Richards, Secretary, 234 Berkeley St., Boston, Mass.

Messrs. Maher & Grosh,
Toledo, Ohio.

Some 10 to 12 years since I purchased of you by mail order the finest bit of steel it has ever been my good luck to own. I have often inquired of dealers for your goods but have never been able to procure any. I therefore ask you to send me as soon as convenient your catalogue of knives, cutlery, etc., and oblige,

S. E. Howkos, Douglas, Alaska.

Hoboken, N. J.

Century Camera Co.:

I received one of your cameras for getting subscriptions to RECREATION, and am more than pleased with it. I have used it under all conditions and can not make a failure

with a Century. All my work is done from a passenger train, running 45 miles an hour. I even obtained a fair photo at 6:30 a. m. one day last week.

Chas. Doell, Conductor O. & W. Ry.

D. M. Lefever Sons & Co. have issued their new catalogue for 1903, and among the many interesting things in it are the description and illustration of the Lefever single trigger device. This is one of the many labor saving and time saving inventions of the 20th Century, and all progressive shooters will be interested in knowing about it. A postal card will get you a copy of the catalogue if you mention RECREATION.

J. H. Barlow, manager of the Ideal Manufacturing Company, New Haven, Conn., has issued a book entitled Hints on Loading and Reloading Shot Gun Shells, which is full of valuable data. Anything that Barlow does not know of this subject is not worth while, and the thousands of sportsmen in the country who are seeking information on these lines, should write him for a copy of this new book.

Malone, N. Y.

Drs. Phillips & Wrean,
Penn Yan, N. Y.

I received the hares and am more than pleased with them. They are of a better breed and larger than I expected to receive for the money. I shall probably buy more in the future. Thanking you for your promptness in filling my order, I remain,
Geo. Frechette.

New York.

Messrs. Wing & Son:

Your superb instrument has more than pleased me. I heartily recommend it to prospective buyers as a perfect piano, both for tone and workmanship. Yours,
Anthony Pinto,
Leader Orchestra Grand Hotel.

The 9th annual sportsmen's show is announced to be held at Madison Square Garden, New York, February 21 to March 7, 1903. The management promises to build this show on broad and progressive lines; to make it at least equal to the 1902 show, and even superior to that in some respects.

Des Moines, Iowa.

West End Furniture Co.,

Dear Sirs:—I am much pleased with my gun cabinet and it is entirely satisfactory in every way.

Yours truly,
R. H. MacMullen.

EDITOR'S CORNER.

IN SELF DEFENSE, EH?

Doctor and Mrs. James Martin, of Boston, camped near Spednic lake, Maine, in October last to hunt bear. A dispatch from Vanceboro states that Mrs. Martin occasionally hunted over the line into New Brunswick. On her return from one of these trips she encountered a bull moose which she says disputed the trail with her. She tried to "shoo" him away, but he would not be "shooed." She said he came at her and she climbed a tree to get out of his way. Stranger still, she claims to have taken her rifle up the tree with her. The moose still pursued her, and she says that in order to save her life she reluctantly shot and killed him. When sure he was dead she came down, and darkness having come down too, she started to build a fire near the carcass of the moose, with a view to camping there over night. A search party found her, and later a New Brunswick game warden found her. She was taken into court and fined \$100 for killing a moose without first having taken out a hunting license. This story will prove highly amusing to all who know the wild, timid nature of the moose.

POST CHECK CURRENCY.

The proposed Post Check Currency would do away with the cumbrous money order machinery. A man can make out his order wherever he likes and it is payable only to the person designated. It saves time, expense and loss and is at once the most convenient, practical and sensible measure the wit of man has yet devised. One would think that its simplicity and safety would commend it at once to the postal authorities, but men in official position become so attached to old methods that they insensibly cling to them and persistently fight all innovations. It is precisely this class of men that the Post Check system has had to fight, but the members of Congress ought to be above such petty and feeble considerations. They ought to regard the measure as one fraught with inestimable benefit to the business interests of the country. I trust Congress may look at this from the high plane of statesmanship and not be influenced by the objections of interested parties.

HE IS ALL RIGHT ON GAME PROTECTION.

That President Roosevelt reads RECREATION carefully is shown by the following extract from his recent message to Congress:

Legislation should be provided for the protection of the game, and the

wild creatures generally, on the forest reserves. The senseless slaughter of game, which can by judicious protection be permanently preserved on our national reserves for the people as a whole, should be stopped at once. It is, for instance, a serious count against our national good sense to permit the present practice of butchering such a stately and beautiful creature as the elk for its antlers or tusks.

Such an appeal as this from the President should remove all objection to Congressman Lacey's timber reserve bill, and it should be passed by the present Congress.

Phillips Academy, Andover, Mass., has lately established a Department of Archaeology, and has appointed W. K. Moorehead, an old time contributor to RECREATION and a thorough sportsman and scientist, as curator. Mr. Moorehead invites readers of RECREATION to send him any Indian relics they may have which they do not care to keep. These will be safely stored in the Academy Museum, labeled with the names of the donors, and further credit will be given in the annual reports of the Academy. Stone or copper axes, pipes, spear heads, vessels, and all kinds of bead work, etc., are desired and will be thankfully received.

Some weak kneed man writes from Lockport, N. Y., to Secretary Rice a tale of woe about game law violations, and says he would like to have the League prosecute the offenders. He had not the courage to sign his name to his letter, so it went into the waste basket, where many anonymous communications go every day. All readers of RECREATION should have learned by this time that no communication can be considered in this office unless it be signed by the writer. Names of complainants are held confidential in all cases where requested, but I must know from whom a report comes before I can act on it.

RECREATION reaches me regularly, and I watch anxiously for it as for the coming of an old friend. The August number was on the ill-fated "Morgan City," which sank off the coast of Japan. But not even old ocean could keep RECREATION from me. After a delay of 3 weeks I received it, in readable condition, though wet, and smelling of bilge water.

RECREATION is the best magazine I ever read. A. L. Martin, Otego, N. Y.

MOWING A DEER.

FRANK CROFOOT.

I once knew an old man who had crossed the plains in '49 and liked nothing better than to tell of his adventures with wild beasts and wilder men during that eventful journey and during his boyhood days in the East. His favorite story and one he often repeated, though it generally varied in the telling, was as follows:

"When I was 20 years old I hired out to a Mr. Hill, for whom I worked nearly 3 years. His farm was a large clearing near the Southern edge of an immense forest that stretched miles Northward and was full of wild game of all kinds; while occasionally a small band of Redskins was to be met on their way from the Canada line to the settlements South of us to trade their furs for powder, bullets, tobacco, and firewater.

"During the winter we used to hunt and trap in those woods, and there I killed my first deer. It was in mid-summer and the killing was done in a peculiar manner.

"One day in July, with the mercury at 100 in the shade, old man Hill told me to go down to the North meadow and commence mowing, while he and his son finished hauling in the hay from the South meadow. I shouldered my scythe and with a whetstone in my hip pocket and a jug of water under my arm, started briskly, whistling.

"When I had reached the meadow and hidden the jug under a rock where the water would keep cool, I whetted my scythe and began mowing the timothy that stood higher than my head. I had worked some time and had a lot of grass down when I stopped to take a drink. The day was so hot that, although I wore only a thin shirt and pants, with a broad brimmed straw hat and no shoes, I was nearly done up and sat down to rest. Just then I saw some berries in the fence corner and commenced picking and eating them. It didn't take long to finish those berries, and I was looking for more when I heard a crash in the bushes and the next instant an immense buck came flying out of the woods and over the fence, through the tall grass toward me. He did not see me until he was within 10 feet of me. Then he whirled with a snort and disappeared in the forest.

"I was too quick for him. As he turned, I flung the scythe at him with all my strength. It struck him on the flank and cut a gash in his flesh, not deep enough, however, to stop him. He disappeared in the thick forest.

"I ran to the house, snatched old man Hill's muzzle loading rifle from the pegs and started in swift pursuit. Reaching the place where I had wounded the deer

I leaped over the fence and started rapidly on his trail.

"A light snow was falling and the earth was covered to a depth of 6 inches, while every few feet was a big splash of blood from the wound. Tracking was easy and before 15 minutes had elapsed I came in sight of the deer, which had lain down in the snow. Seeing me he sprang to his feet and started off with great speed before I was within range. This he repeated until the loss of blood began to tell on him, when I finally managed to bring him down with a bullet in the shoulder.

"Drawing my hunting knife, I bled him, and then commenced dressing the carcass and preparing the skin and choicest parts for carrying home. This took quite a while, but I finally finished my task and started for home, with the venison on my back. In the excitement of following the deer, however, I had lost all track of time and found myself a long distance from the farm. It was nearly sunset and the wind was blowing a gale, while the snow was 6 feet on the level, and coming down in great flakes. The air was cold and piercing, but I was warmly clad in furs and woollens and sped rapidly along on my snowshoes. After 2 hours' swift walking I reached the farm, hearing the blood curdling howls of wolves and the occasional scream of a panther in the forest around me. I climbed in safety, however, over the fence to where I had left my scythe. Picking it up, I started for the house, where I found the Hills, who had just brought in the last load of hay from the field and were about to go in search of me.

"With their assistance I finished dressing the venison, as well as I could in the face of mosquitoes that nearly ate us up. Mosquitoes were thick in the woods during the summer, and immense ones, too, twice as large as those we have here.

"That was my first deer. I have shot many since, and buffalo and grizzlies, too; but I have never felt so proud of them as of the deer I killed with a scythe."

RECREATION has taken all the game hog out of me. I try to induce others to read your excellent magazine.

R. E. Bassett, Bassett, N. J.

I would rather do without all other magazines than give up RECREATION.

Dr. G. C. Fordham, Watkins, N. Y.

A fair exchange is no robbery, unless it be a church fair.—Life.

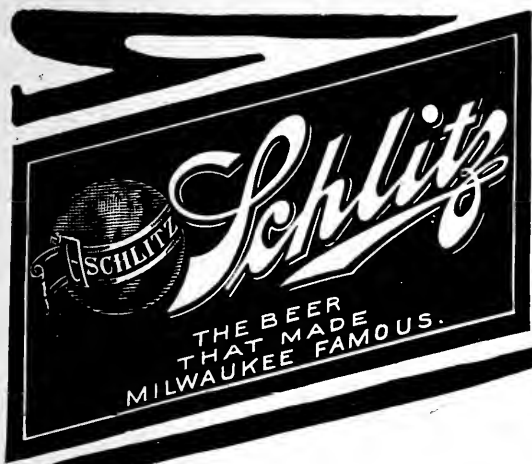

Our Costly Brewing

The water used in SCHLITZ Beer comes from six wells, driven down to rock.

The barley is the finest grown, selected personally by a partner in our concern.

The hops come mostly from Bohemia, and cost twice what common hops cost.

Every process of the brewing is in personal charge of two of the brothers who own the business.

All the air that touches SCHLITZ Beer is filtered. Every drop of SCHLITZ Beer is filtered through masses of white wood pulp.

Every bottle is cleaned by machinery *four times* before using.

After the bottle is filled and sealed, it is sterilized for 1½ hours by the process of M. Pasteur.

Common beer can be brewed for half the cost of SCHLITZ; but our extra cost is all spent to insure absolute purity. Yet common beer and SCHLITZ Beer cost you the same. Why not get the best for your money?

Ask for the Brewery Bottling.

BIG GAME IN THE SIERRA MADRES.

CHAS. M. BARBER.

With C., his partner S., his dog Julius Cæsar, and an outfit of traps, jack, etc., I dropped off the West edge of Horse mesa into the valley of a branch of the Rio de Alamos, Mexico, and made the first camp. We trapped the canyons near the higher country 3 weeks with moderate success. C. and S. killed the only bear at that camp, a female of good size. She trod on the pan of one of C's home-made traps, and after a few jumps broke the swivel. Thus released she made 2 or 3 miles into rough country; but there were good trailers behind her and though she held up the trap, they followed the sign and shot her.

As bear sign was not abundant, I decided that the animals must be lower down. Lions were abundant, however. We caught 6 at the first camp, and more were seen in the open. A lion in a 17-pound trap is tame sport. They are cowards at best, and could be killed with a club. They snarl and growl, but do not relish a fight, and show no desire to attack man. The worst scrapper among them was a young spotted kitten about the size of a bobcat. He was caught in a No. 3 trap, and was held by 2 toes. Fearing he might break loose, and not wishing to shoot him full of holes, I tossed a small rope over his head. I easily caught him; but after that I had to step high and lively until I had him hanging from a limb. This lion was of a new species recently described by a Washington naturalist, and was a most beautiful animal.

A hasty trip about 10 miles down the stream revealed fresh sign of bear, so we moved camp and traps. I set 2 traps while C. and S. toted the outfit. Next morning I staid in camp to clean some skins, thinking, of course, that my traps set the day before would have caught nothing.

C. and S., with a pack of traps and bait, left early to visit my traps, and I set more. The first trap was gone. They struck the trail before they reached the place of the setting, and following it about a mile, came upon the biggest bear they had ever seen. C. shot him at about 100 yards, killing him instantly. The boys did not care to go nearer to see whether he would fight or not. Later in the day, C. found the carcass of a 5-year old steer, which several bears were feeding on. They had dragged the steer about 100 feet. A trap was set, and we visited it the next day.

It was a long ride to the setting, and the skinning of a few foxes and a bobcat delayed us; but when we neared the spot we found fresh bear tracks leading toward it. A little nearer we saw where a bear had left the country on a dead run. We decided our game had been scared, and that

the traps would be empty. Leaving our horses on the hill we entered the little canyon, and found one trap gone and the other sprung. The track was that of a good sized bear, and as the country was rough, we trailed afoot. Cæsar, who is a slow trailer, led out and we followed closely. A mile and a half we trudged after that bear. How she could drag a 17-pound trap with a 75-pound pole, I do not know; but she seemed to do it easily enough. The trail led to the foot of a brushy mountain. I looked but could see nothing in the oak shrub, so kept the trail. Ten feet farther I heard the bear breathe. The dog had not seen nor winded her; but he heard her and into the brush he went. They came out together, and I shot her at 20 feet. That is closer than I care to get again. The big brutes handle the trap and themselves too well to suit me. This was an old female. They are smaller than the males, and will not run much over 500 pounds.

The largest male silvertip caught had a pad just 5 inches wide. A few days after the capture of the female above mentioned, a monster bear made a visit to the steer, and springing the traps, ate his fill and departed. Later he did it again, and then, as he never came back, I presume he turned in for a nap. The imprint of his pad measured 6 inches wide; I could not secure a good measure of its length. He seemed unusually heavy, pushing the dirt away down; and his stride was so wide that he stepped clear over a trap on one occasion.

Later, Mr. K., hearing that we were catching game, came and camped with us a few days. The first day he rode the trap line we had a lion and a good sized male silvertip. K. shot the lion with his camera and then with a rifle. As we approached the next trap we heard the roaring sound made by a mad bear. Bruin had gone only 50 yards, had wrapped the chain around a stout oak and was fast. As we rode up he made a lunge toward us, but could not get loose. We dismounted and I did the bodyguard act for K. while he, with rifle under one arm and camera in the other, walked up within 10 steps and photographed our game.

The last bear I did not see. C. and S. found him just as he broke loose from the trap, and crippled him. He charged. C. stuck a shell and S. tried to shoot an empty gun; then they both ran for tall timber. The dog held up the bear, or he would have got one or both of the men. They finally killed him by shooting him 9 times. I would have given any 10 days of life in town to see those scared Mormons warming their cold feet.

The bears trapped, 5 in all, were silver-tips; 2 old females, 2 large males, and a small male. Eight lions, 1 wolf, 4 cats, 12 foxes, 38 skunks, an owl, and deer and turkeys made up the 6 weeks' bag.



THE EQUITABLE

HENRY B. HYDE, Founder

J.W.ALEXANDER
PRESIDENT



J.H.HYDE
VICE PRESIDENT

WASHINGTON AND LINCOLN

defended and protected their country while they lived.

The Father of a family should defend and protect his family, not only while he lives but after he dies.

This can best be accomplished by Life Assurance. An Endowment policy in the Equitable will protect your family in the event of your death, and will provide for your own future if you live.

For full information fill out coupon below.

Vacancies in every State for men of character to act as representatives. Apply to Gage E. Tarbell, 2d Vice-Prest.

THE EQUITABLE LIFE ASSURANCE SOCIETY, OF THE UNITED STATES
120 Broadway, New York. Dept. No. 16

Please send me information regarding an Endowment for \$
if issued at years of age.

Name.....

Address.....

AMATEUR PHOTOGRAPHY.

"For sport the lens is better than the gun."

I wish to make this department of the utmost use to amateurs. I shall, therefore, be glad to answer any questions and to print any items sent me by practical amateurs relating to their experience in photography.

PRIZE WINNERS IN THE 7TH COMPETITION.

Once more the hopes of a number of enthusiastic amateur photographers are realized, and once more a larger number are disappointed. This must always be so in any competition. As in betting on horse races, there must be winners and losers. Unfortunately in these photo competitions there must be at least 10 losers to one winner. This is because I can not afford to offer prizes enough to reward all the good photographers.

There were 830 entries in RECREATION'S 7th Annual Competition, and I am proud to say the pictures, as a whole, ranked higher than in any of the 6 previous contests. As usual, many pictures were entered that were not quite good enough to win; but the work in this class ranked higher than ever before.

As in all such contests, many fine pictures were submitted that did not comply with the conditions, though these have been printed in every number of RECREATION for 6 months past. If photographers would only read these printed instructions carefully, they would not send in so many ineligible pictures. For instance, there were several groups of pretty children, simply posed before the camera as a portrait photographer would pose them. There were several groups of kittens, and one group of pigs. There were a number of fine pictures of waterfalls or of mountains. There was one view of a flock of sheep, and there were 2 or 3 others of herds of cattle. Such pictures do not represent any form of indoor or outdoor sport or recreation, hence could not be considered by the judges in awarding prizes. If the people who made some of these pictures had turned their attention to studies of some form of sport, or to wild animals or birds, they might to-day be enjoying the distinction of having won good prizes, instead of finding that their names are not included in the prize list.

The judges in this competition were A. S. Higgins, of Higgins & Seiter, glass and china ware, New York city; E. R. Sanborn, official photographer of the New York Zoological Park, and H. C. Christy, the famous pastel artist.

The judges spent 6 hours in assorting and classifying the pictures and in placing the awards, and it is safe to say no men ever studied harder or acted more con-

scientiously in any such position than these men did. They are, therefore, entitled to the hearty thanks and approval of every contestant, whether he won a prize or not.

The prizes were awarded as follows:

- 1st, A Pair of Lynxes in a Tree, E. J. Kerlee.
 - 2nd, Group of 4 pictures of White Goats on the Rocks, A. M. Collins.
 - 3rd, Wood Duck Shooting on Squawk Slough, R. C. Cameron, on condition that he satisfy the judges as to the bird shown in the picture.
 - 4th, Group of 12 pictures of Live Wild Animals and Birds, Dr. J. B. Pardoe.
 - 5th, Group of 10 pictures of Live Wild Animals and Birds, Wm. H. Fisher.
 - 6th, Group of 6 pictures of Moose, Dr. J. M. Rainie.
 - 7th, Mule Deer, W. B. More.
 - 8th, Group of 6 pictures of Live Wild Birds, and of Fishing Scenes, J. E. Stanley.
 - Special Prize, Group of 14 pictures of Live Wild Animals and Birds, J. E. Tylor.
 - 9th, Humming Bird, Morey Jamison.
 - 10th, "We Want our Mudder," G. E. Strobbridge.
 - 11th, Young Screech Owls, Walter W. Savery.
 - 12th, Still Life, W. T. Adderley.
 - 13th, Blue Heron at Home, and A Lazy Fisherman, W. H. Thurston.
 - 14th, Group of 3 bird pictures, A. L. Princehorn.
 - 15th, Black Bear at Home in the Rockies, J. Bauer.
 - 16th, Chipmunk and Squirrel, J. Bauer.
 - 17th, Group of bird pictures, James H. Miller.
 - 18th, Group of bird and chipmunk pictures, R. H. Beche.
 - 19th, Caught Napping, F. C. Evans.
 - 20th, Screech Owl and Nighthawk, C. C. Speight.
 - 21st, The Lone Fisherman, Gardner Cornett.
 - 22d, Yellow Bellied Sapsucker and Ruffed Grouse, Geo. C. Embody.
 - 23d, Ruffed Grouse on Nest, A. B. Gunderson.
 - 24th, On His Favorite Log, E. H. Nelson.
 - 25th, Curiosity Nearly Satisfied, A. N. Flinn.
 - 26th, Little Jack, Guy V. Rukke.
 - 27th, Grey Gopher, H. O. Bjornaas.
 - 28th, Ruffed Grouse on Nest, E. F. Worcester.
 - 29th, Preparing Supper, F. A. Burr.
 - 30th, Home of the Brook Trout, W. S. Kirby.
 - 31st, A Grand Stand Parry, The Foiled Re-poiste, A Narrow Margin, E. R. Logan.
 - 32d, A Hard One to Land and Duck on Nest, Perry Archibald.
 - 33d, Duck Pointing, Wm. R. Magee.
 - 34th, A Night in Camp, Chas. B. Wright.
 - 35th, Three Jolly Tars, E. S. Wilson.
 - 36th, The Finish at Sundown, The Conspirators, Right on Time, D. W. Flint.
 - 37th, Group of 5 camp pictures, Thos. A. Morgan.
 - 38th, Ruffed Grouse Drumming, David Spence.
- Only 38 prizes were offered in the competition, but there were so many good pictures in excess of that number that I have decided to award a special prize of a yearly subscription to RECREATION for each of the following:
- 39th, A Swan, George C. Hunt.
 - 40th, The Anxious Moment, Walter C. Nichol.
 - 41st, Nat, Mrs. W. N. Manchester.
 - 42d, Salmon Fishing in Newfoundland, Hugh H. Fraser.
 - Prairie Chickens, Chas. Birgin.
 - An Easy Shot, Sydney B. Thomas.
 - Swallow's Nest, W. C. Webster.
 - Young Kingbird, Louis Johnson.
 - Caught Napping, F. C. Evans.
 - A Wild Calf Moose, Hy. S. Walker, Jr.

- Florida Barred Owl, E. F. Pope.
- Three of a Kind, C. M. Whitney.
- Dangerous Canoeing, C. L. Baer.
- In the Swim, Harry G. Higbee.
- A Happy Family, Harry C. Robinson.
- Resting, Ward A. Baldwin.
- Good Sport for Pickerel, Alex. Berry.
- An Owl, Louis R. Christhief.
- Young Hawks, W. Stark.
- A Moonlight Sail, Thos. J. Curran.
- Dash, Pointing Quail, H. M. Beck.
- Ready to Strike, S. R. Symmes.
- Sportsmen Homeward Bound, Frank G. Rininsland.
- An Anxious Moment, B. F. Mahana.
- Gull on Nest, Rev. H. K. Job.
- The Anglers, Dr. G. A. Graham.
- Imitation Duck Shooting, R. C. W. Lett.
- A Day Off, D. H. Day.

The following were highly commended by the judges:

- A Patriarch, name of photographer unknown.
- Nest of Pied-billed Grebe, W. Stark.
- Nest of Green Heron, Mark Williams.
- Water Spider Resting on a Board, Harry G. Higbee.
- Ready to Strike, Stanley R. Symmes.
- Groundbird's Nest, W. C. Webster.
- Nest and Eggs of Meadow Lark, F. S. Andrus.
- Prairie Chickens, Chas. Birgin.
- Virginia Deer, John W. Jacobs.
- Mother Red Breast at Home, F. W. Wagner.
- Fishing in the Yuba, Edwin R. Jackson.
- A Coiled Rattlesnake, Stanley R. Symmes.
- Bob on Point, Roy B. Hindmarsh.
- Home of a Sandpiper, Mark Williams.
- Steady! (pointing grouse), Roy B. Hindmarsh.
- Anchored, A. N. Flinn.
- Catbird's Nest, W. C. Webster.
- A Summer Cottage in the Country, C. M. Whitney.
- Chestnut-sided Warbler on Nest, Harry G. Higbee.
- Nest of Sooty Grouse, C. V. Oden.
- Up Hill, C. M. Whitney.

A TONING AND FIXING SOLUTION.

Please give a formula to prevent films from curling. Also for a toning and fixing solution. Will it give better results than any on the market?

L. B. Johnson, Clark's Fork, Mo.

ANSWER.

When sufficient glycerine is used films will not curl. When the atmosphere is dry it may be necessary to use 3 to 4 ounces of glycerine to 32 ounces of water. If this leaves the negatives greasy, an indication that too much glycerine has been used, the surplus may be removed by going over the negatives quickly with naphtha on a tuft of cotton or piece of soft cloth. When not printing, store negatives in one of the albums made for that purpose by the Eastman Kodak Co. or in envelopes kept under enough pressure to exclude the air.

Following is formula for a perfect toning and fixing solution:

- A.—Hyposulphate of soda..... 8 ounces
- Alum (crystal)..... 6 ounces
- Sugar (granulated)..... 2 ounces
- Water80 ounces

Dissolve in cold water, and when dissolved add borax, 2 ounces; dissolved in

hot water, 8 ounces. Let stand over night and decant clear liquid.

- B.—Pure chloride of gold..... 7½ grains
- Or double the quantity of chloride of gold and sodium.
- Acetate of lead (sugar of lead)64 grains
- Water 8 ounces

Solution B should be shaken before using and not filtered.

To tone 15 cabinets take:

- Solution A.....8 ounces
- Solution B.....1 ounce

Place prints in the above without previous washing. Tone to the desired color and immerse prints 5 minutes in following salt solution to stop the toning:

- Salt1 ounce
- Water32 ounces

The extra fixing bath should be used to ensure thorough fixing. After the salt bath give one change of cold water and fix for 10 minutes in the following extra fixing bath:

- Hyposulphite of soda..... 1 ounce
- Sulphite of soda (crystals).....60 grains
- Borax¼ ounce
- Water20 ounces

Wash 1 hour in running cold water or in 16 changes of cold water, when prints may be mounted same as albumen prints.

The combined bath must be used cold, not above 50 degrees Fahr. This condition can be obtained by placing a piece of ice in the bath when toning. If the bath is too warm, it will cause yellow prints with a greenish cast in the half tones. Use a thermometer and keep it in toning bath all the time.

The combined bath is an acid solution. The borax neutralizes only the excess of acid in the alum. Any attempt to neutralize the bath will precipitate the alum. The combined bath should not be used a second time.

TO MAKE PURPLE TONES.

Will you please give, in RECREATION, a formula that will make purple tones on Aristo Platino. Are such tones permanent?

E. O. Dean, Cortland, N. Y.

Paper for purple tones should be at least 2 weeks old.

Print about the same as for gold toning, until high lights are slightly tinted. The exact depth of printing can best be determined by a few experiments of different shades. Wash prints through 5 changes of clear water; then run through a bath of one tablespoonful of salt to one gallon of

water. Handle prints through this bath one to 2 minutes, bringing the color to a bright golden yellow, then tone in gold bath made as follows:

64 ounces hot water.
1 dram Aristo gold.
½ teaspoonful of salt.

Borax enough to turn red litmus paper blue in 10 seconds.

This bath should be mixed at least one hour before using. Speed of bath should be 6 to 8 minutes. To strengthen this bath add gold when needed, always being careful to neutralize the gold before adding to the bath. Constant watch should be kept to see that the bath remain sufficiently alkaline.

Tone to a warm purple, until all traces of brick red have left the shadows. Throw prints from the gold bath into a tray of clear water. After a batch has been toned, wash by hand through 3 changes of clear water and place in a bath of one ounce saturated solution of alum to 64 ounces of water. The purpose of this alum bath is to set the color, and prevent hypo bath from changing it. Prints should be handled through this bath for 5 minutes and kept in constant motion; after which wash through 5 changes of clear water, and fix in hypo bath 18 degrees hydrometer test, for 15 minutes. Wash through 12 to 15 changes of clear water, handling each print separately, and they are ready to mount and dry.

FIRST PRIZE WINNER.

On receipt of the photograph by Mr. E. J. Kerlee, of Darby, Montana, showing 2 Canada lynxes up a tree, I wrote Mr. Kerlee as follows:

The question arises in my mind, as it will in that of every man who sees these pictures reproduced: Were the lynxes alive when the picture was made? They look alive, but a good taxidermist can make a dead animal look that way. If they were alive please give me full particulars as to the making of the picture. Was anyone with you when you made the picture? If so, give name and address; or better still, get him to write me a letter telling me all about it. The picture will naturally be attacked, and if it be genuine I should like to be forearmed.

In reply I received the following letters:

Darby, Mont., Nov. 3, 1902.

Those lynxes were alive. We chased them up the tree. You can plainly see in the photograph, that the dead limb is fast to the tree.
E. J. Kerlee.

Darby, Mont., Oct. 3, 1902.

Mr. E. J. Kerlee has shown me your letter in regard to the photo of 2 lynxes.

I was present when the photo was taken. The lynxes were very much alive, and absolutely without any trap, strings, wires or other contrivance to hold them. I am willing to make affidavit if necessary.

Warner Laird.

THIRD PRIZE WINNER.

The time I spent in getting the photograph entitled "Never Touched Me" was full of surprises. I saw about 300 deer, near and far. One day when I had neither Kodak nor gun I was for half an hour within 10 to 100 feet of 4 does and 6 fawns. My companion and I saw several does and one buck one morning and they apparently had no fear of us, as they came close. Although both of us had guns we did not shoot. One yearling buck finally headed down within 30 feet of us. We missed an unusual chance to photograph a big buck by leaving the camera at camp.

"Never Touched Me" was made with a No. 3 Eastman Folding Pocket Kodak.

Wm. B. More, Harrison, Colo.

COLORS LANTERN SLIDES.

If any of the readers of RECREATION want lantern slides colored they can not do better than to send them to Mrs. Buttles Smith, 606 W. 115th St., New York City. In my judgment she does as fine work in this line as any artist in the country. I have recently had her color a lot of slides for me, and though I have had a great deal of this work done by various artists, I have never had any that pleased me better than that done by Mrs. Smith.

SNAP SHOTS.

A simple formula for backing plates is as follows:

Caramel2 parts
Hot water.....2 parts
Alcohol1 part

To this may, if desired, be added a small quantity of sienna. If the paste dries, it may be powdered and made ready for use again by the addition of a little glycerine.

Can you instruct me through RECREATION how to sensitize postal cards for Velox printing?

W. R. Smith Hoosick Falls, N. Y.

You will find it cheaper to buy cards already sensitized than to sensitize them yourself. It is difficult for an amateur to sensitize successfully with the bromide emulsion.—EDITOR.

Rub a freshly cut slice of potato over a photograph to be colored or retouched and the color will stick immediately, which it will not otherwise do.—The Photo-American.

*You press the button—
—then do the rest.*

Anybody can develop and print
their own pictures now that the

K O D A K

Developing Machine

==== *has* =====

**Abolished the
Dark-Room**

Eastman Kodak Co.,

Rochester, N. Y.

Ask your dealer or write us for Booklet about the Developing Machine

Something New!

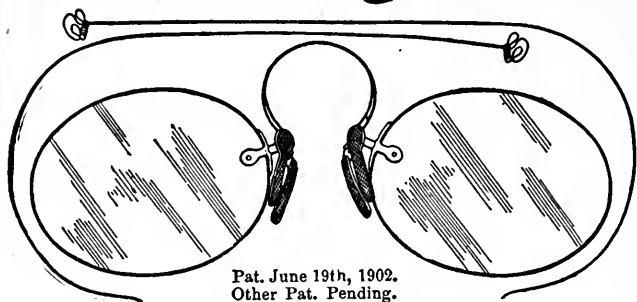

Pat. June 19th, 1902.
Other Pat. Pending.

PRESTO! CHANGE!

Attachable Eyeglass Temples

Every wearer of eyeglasses wishes occasionally that they were spectacles. Spectacles stay on, however violent one's exercise, however warm or stormy the weather. This little device can be readily attached or detached without injury to the lenses, thus in a second giving you the choice of either spectacle or eyeglass. Just the thing for outdoor sports. The Temple Attachment will fit any of your eyeglasses and can be carried in the same case with them.

Send thickness of lens when ordering by mail.

Price in Nickel, 50 cents a pair
Price in Gilt, 75 cents a pair.

Send for Circular.

Our illustrated catalogue can be had for the asking

We carry everything in the Optical and Photographic line. Eyeglasses, Spectacles, Cameras, Opera, Field or Marine Glasses, Thermometers, Barometers, Telescopes, Hygrometers, Sun-dials, etc.

GALL & LEMBKE, Department C.

Established 1842. 21 Union Sq., New York

DO YOU WANT A CAMERA?

If so, you can get it
Without \$1 of Expense

A Model 10, Century Camera. Listed at \$9.
For six yearly subscriptions to
Recreation.

A Model 12, Century Camera. Listed at
\$18. For 12 yearly subscriptions to
Recreation.

A 5x7 Century Grand. Long Focus, Double
Swing, with Wide Angle Lens. Listed
at \$60. For 40 yearly subscriptions to
Recreation.

Such opportunities were never before
offered.

I have but a few of these Cameras on
hand, and when the supply is exhausted
this offer will be withdrawn.

Sample copies of *Recreation* for use in
canvassing furnished on application.
Address

Recreation, 23 West 24th St.

New York City

TEACH CHILDREN TO BE GENTLE.

For some time I have been wondering if it were possible for me to continue reading your magazine without giving vent to my own thoughts concerning game hogs. Although a woman, I am a lover of all game and can thoroughly enjoy myself on a hunting or fishing expedition, not by killing game, but by admiring and helping to carry it home. I have had much experience in dressing game, and no man can dress rabbits, squirrels, raccoons, woodchucks or birds better than I can.

In looking over your pictures of game hogs I have tried to imagine what their home life would be and if their wives, mothers or sweethearts approve of their needless and useless slaughter. If not, what a life a sensitive woman must endure; for if a man be a hog in a case where an inner sense of honor should govern him, he will be a greater one in his own home where he thinks no other man has aught to say. In many cases women are to blame, for they close their eyes to the early tendencies of their children toward brutality, and in many cases cultivate the habits that in after years cause them heart-aches. I have seen mothers give a puppy or a kitten to a baby to be tortured, and if the poor animal made its escape they would box its ears and give it again into the tiny savage's hands. Such teachings harden children, and as they grow older they torture smaller children, taking delight in the pain they inflict. Boys with air guns should be taught to regard life as something produced by a higher power than man, and never to take life unnecessarily. If they are allowed to take the life of any animal they choose, without being rebuked, they will think nothing of taking the life of a human being when animals have become small game. Few parents realize that each day of the present is but a part of the foundation on which children will build their lives. If you can but arouse the finer instinct in women, bringing into life the sympathy, love and protection for the helpless which every woman should have, you will have made great headway toward protection of game. When a woman makes up her mind to use her influence on a man, be it for good or ill, that same man is more helpless than game in the localities infested by game hogs.

Mrs. Geo. Andres, Bradford, Pa.

HAVE YOU A FRIEND
ANYWHERE IN THE WOODS,
IN THE MOUNTAINS
OR ON THE FARM,

WHO LONGS FOR SOMETHING TO READ
IN THE LONG WINTER EVENINGS, OR IN
THE LONG SUMMER DAYS?

SEND HIM RECREATION.

IT WILL PLEASE HIM A WHOLE YEAR
AND HE WILL RISE UP AND CALL YOU
BLESSED.

AND IT ONLY COSTS YOU \$1.

Winter pictures
should not be made
on any plate
but

R. O. C.

The Rochester Dry Plate

We would
like an opportunity
to tell you why

ROCHESTER OPTICAL AND CAMERA CO.

Rochester, New York, Chicago, London

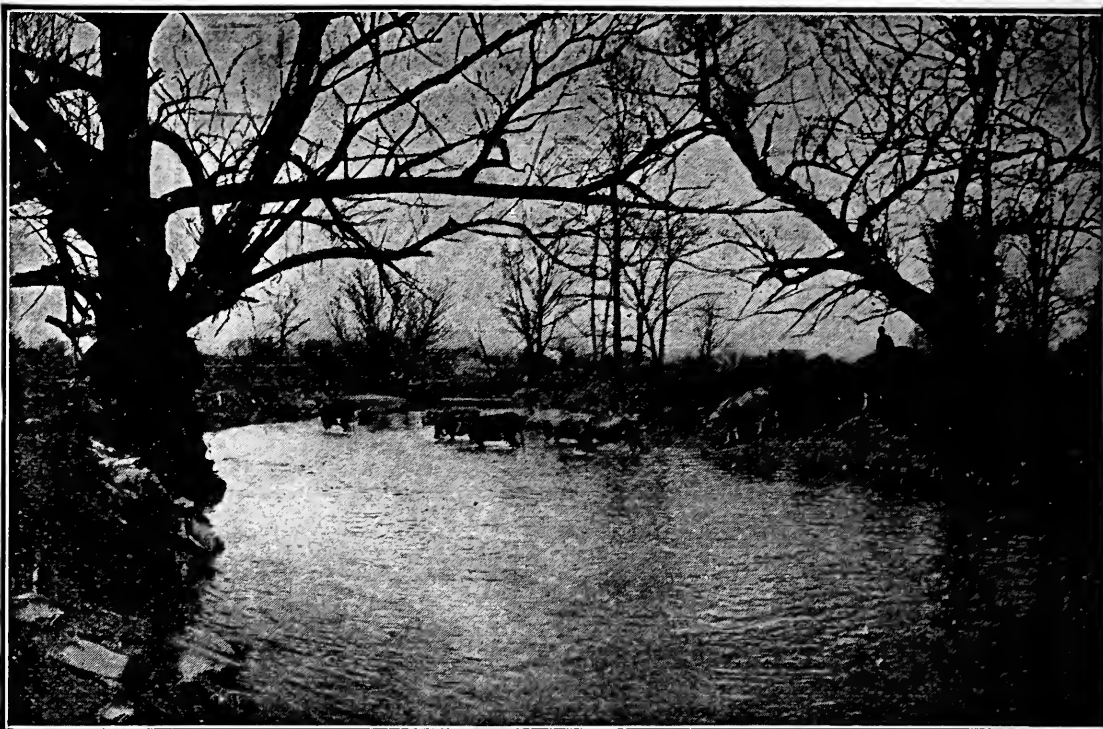

All in one picture, by the

take half-length views, or, with some models, stop the lens at five different places and thus make five different widths of pictures. This you can do in accordance with the view that you wish. No other camera possesses these advantages.

How often you find yourself on some high place with a view just in front of you, a part of which is not especially interesting, but the whole sweep of which view would make a delightful picture. You long for a camera that will record that whole view.

This is what the Al Vista will do!

We will send free on application our beautifully illustrated catalogue.

Multiscope & Film Co.
136 Jefferson St., Burlington, Wis.

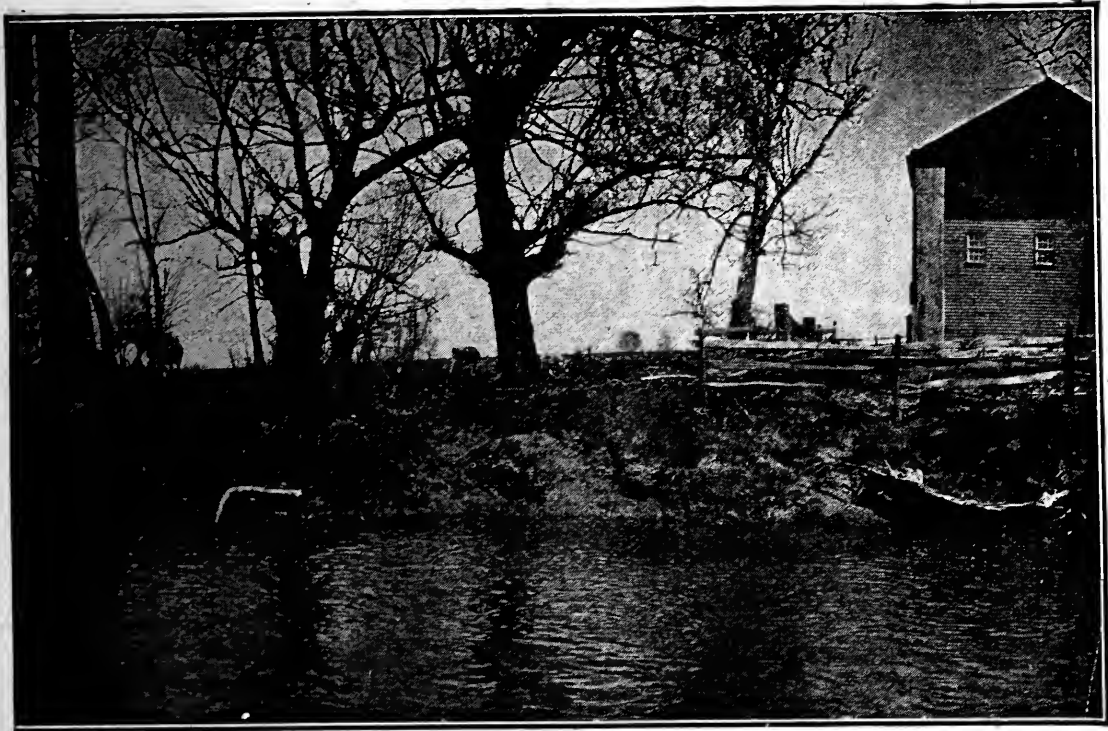

Al-Vista Camera, or you can

Our cameras are the most simply constructed of any in the world, and the easiest to manage when they are understood. We send with each outfit a complete book of instructions. We will be glad to send copy of this free to anyone who will apply for it.

Our Co-operative Plan

We are sending out now a large number of cameras on this Co-operative Plan. A small first payment being made, we ship you the camera, and you can use it while you pay the remainder in monthly installments. This plan appeals to a great many people and certainly shows our confidence in the quality of our goods. Write us for full information about it.

Multiscope & Film Co.

136 Jefferson St., Burlington, Wis.

Are You an Amateur Photographer?

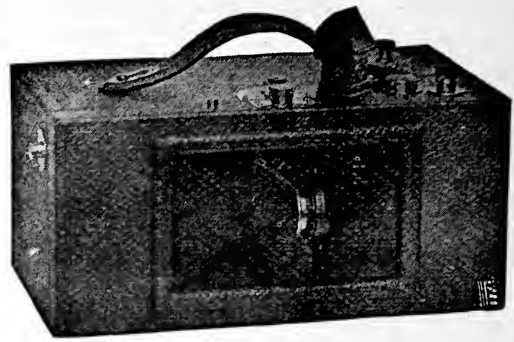

If so would you like a Camera
that will photograph

A whole range of mountains
A whole sweep of river
A whole army
A whole fleet of ships
A whole city

Or any other vast stretch of scenery or moving
objects? THE SWING LENS DOES IT

The Al Vista

Is the thing. It lists at \$30.

One of the greatest inventions of the age.
Given as a premium for 20 subscriptions.

For particulars Address

RECREATION

23 West 24th Street

NEW YORK CITY

IT'S ALL IN THE LENS

Series V Long Focus Korona

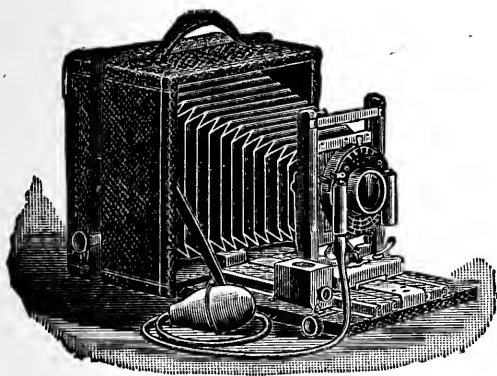

Can be used with equal facility for everyday, hand-camera

Snap Shots

Photographing Distant Views

Copying

or other work needing bellows capacity, and also with wide-angle lenses for interiors and kindred subjects.

ONE CAMERA DOES IT ALL

Every adjustment is a marvel of simplicity and mechanical ingenuity, and many of them are found exclusively on the Korona.

Note our patent auxiliary bed for use with wide-angle lenses, and compare it with

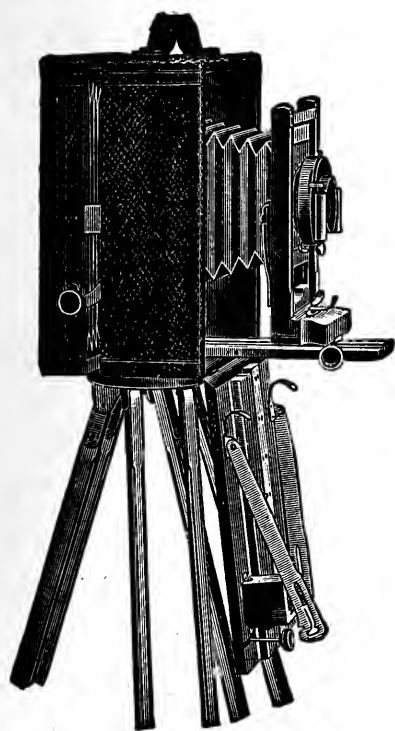
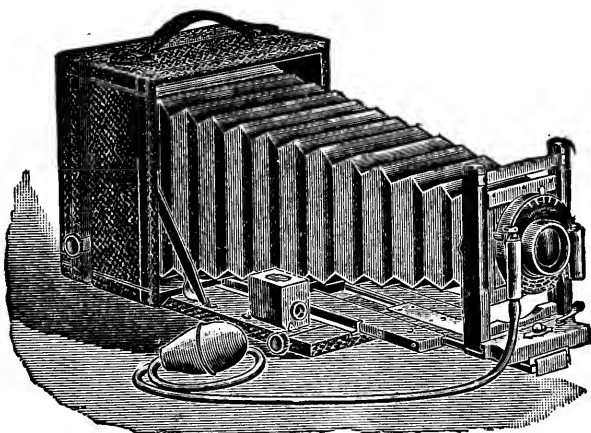

the clumsy methods used to obtain this result on other cameras.

Our patent automatic swing back operates from the center according to correct principles.

KORONA LONG FOCUS

Has a Convertible Lens, Automatic Shutter, and numerous other special advantages.

Catalogue gives full information

Gundlach-Manhattan Optical Co.

ROCHESTER, N. Y.



IN NAME—**ROYAL**—IN QUALITY
ARE

Royal Anastigmat Lenses

**Royal
Anastigmats
are
Winners**

WE know it and we want you to know it, as **GREAT RESULTS** are sure to be obtained by the users of a **ROYAL**. They have speed, fine definition and great covering power and will prove a delight to the connoisseur of high grade objectives.

We make them in three series, ranging in relative aperture from F. 7.5 to F. 5. We also make one of the very best Wide Angle Anastigmats on the market. Write and let us mail you our catalogue giving a detailed description of these lenses.

ROCHESTER LENS CO., 66 Atlantic Ave., ROCHESTER, N. Y.

Here is Another!

If you will send me

40 Yearly Subscriptions

to

RECREATION

I will send you

A No. 10 Goerz Trieder- Pinocular Field Glass

Listed at \$38.00

Every well-informed man knows the great power of this modern prismatic field glass. It is indispensable to every hunter, and is one of the latest and best on the market.

I have but a few of these instruments on hand and the offer will be withdrawn as soon as the supply is exhausted. Therefore, if you want one

START IMMEDIATELY.

Sample copies of **RECREATION** for use in canvassing furnished on application.

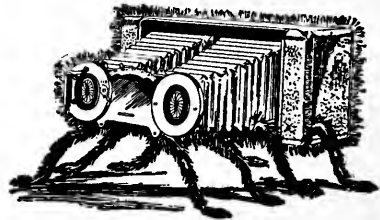

O! The Stereo Camera had a bad fall
And ruined her beautiful eyes.

She tried in vain each Stigmomat
That makers advertise;

But none of them gave to her ground-
glass brain

A picture bright and flat

'Till the Camera-oculist fitted her out

With a **B and L Plastigmat.**

HAVE YOU A FRIEND
ANYWHERE IN THE WOODS,
IN THE MOUNTAINS
OR ON THE FARM,
WHO LONGS FOR SOMETHING TO READ
IN THE LONG WINTER EVENINGS, OR IN
THE LONG SUMMER DAYS?
SEND HIM RECREATION.

IT WILL PLEASE HIM A WHOLE YEAR
AND HE WILL RISE UP AND CALL YOU
BLESSED.

AND IT ONLY COSTS YOU \$1.

Better get your name on our mailing list for a copy of the 1903 Catalogue of **Century Cameras**,—now in press. A postal request will bring it, soon as published. It will prove of more than usual interest to every photographer.

Century Camera Co.

Dept. F.

Rochester, N. Y.



White Mountain Views Free

To any person sending me a subscription to RECREATION accompanied by \$1. I will send two mounted photos, on velox paper taken among the White Mountains, size 6x8; one shows Mt. Washington snow capped. To any one sending 2 subscriptions with \$2 I will send a souvenir of the White Mountains, size 4½x5½ containing seven photos. Send P. O. Money Order

M. E. TUTTLE, Box 337, Dover, N. H.

Free: For 1 year's subscription of RECREATION, through me, will give 1 Bromide enlargement, any size up to 11x14 inches inclusive, from any negative not larger than 4x5; or from photographs. Negatives and Photos to be returned to the owner. Here is a rare chance to get a large Photo from your pet Negative, also RECREATION for \$1. A. F. Evarts, Meriden, Conn.

LANTERN SLIDES COLORED IN AN ARTISTIC MANNER

Special attention given to the wants of Amateur Photographers. Correspondence promptly attended to. I refer by permission to the Editor of RECREATION.

MRS. BUTTLES SMITH,
606 W. 115th Street, New York City.

FREE.

To any person sending me a subscription to RECREATION, accompanied by \$1, I will send one copy of the "Song of Songs," a drama in 5 acts, based on the Song of Solomon. This is an interesting, instructive and elevating play, written by my late husband, the Rev. Morse Rowell, Jr. The book is bound in paper and is alone worth \$1. In addition I have arranged with the editor of RECREATION to send the magazine to all subscribers who may send me their subscription on this plan.

Mrs. Belle J. E. Rowell,
Miller Place, L. I.

MAGIC LANTERNS

STEREOPTICONS and VIEWS

for Public Exhibitions, Church Entertainments, for illustrating sermons. Many sizes. All prices. Chance for men with little capital to make money. 260 page Catalogue FREE.

McALLISTER, Mfg. Optician, 49 Nassau St., N. Y.

LIFE BEHIND THE CABIN.

W. H. NELSON.

One summer I lived in a cabin in the mountains of Colorado, where I had frequent opportunities to observe the domestic habits of a few of the feathered and furry tenants of the wood. I planted a garden near my temporary home, and took much pride in the prospect of fresh peas and beets, greens and potatoes, with lettuce galore, when the summer rains and suns should have ripened them, aided, of course, by "the man with the hoe." Not a weed marred the smooth level of the earth; not a root was left to show that it was newly worked. The potatoes sprouted, the beets peeped up, the lettuce stole through the soil, and I was happy. Then came the magpies or chipmunks and left me not one stalk of lettuce. Followed a frost; and lo! I, the lord of the garden, found myself the victim of a night. My beautiful garden was gone.

Out near the farther end of the desolate garden my daughter threw scraps left from the table. The birds were on the watch and before she had reached the interior of the cabin, the scrap pile was undergoing inspection. Jays! It seems they were all married and had large families. They were fearless, saucy little beggars, and came to the trees beside the house, flitting from branch to branch, cocking their heads sidewise, and tilting their crests at all sorts of angles to see in at the window, or to examine the ground. No sooner was the scrap plate emptied, out by the little stump, than a jay alighted there and selected the choicest morsel. Flying into a tree with it, he ate enough from it to reduce it to the swallow size of his son, or daughter. That young person, quite as big as the mamma or papa, usually sat at a little distance, with gaping mouth and fluttering wings, begging for a bite. That his parents deftly put into his mouth at last and flew back to the stump for more, while the overgrown child waited and watched, with wings a-flutter and throat a-yawp.

Sometimes the parent's patience wore out and I caught a querulous note, as the weary provider flew away from the insatiable babe, plainly saying:

"You lazy thing! You're as big as I am. Hunt your own grub."

I saw a mother, or father—I can not tell them apart—trying to teach a youngster to catch grasshoppers, but it was not a success. The lazy lout easily kept abreast of his parent, but made no effort to catch the grasshopper. He knew a trick worth 2 of that. He waited till his parent had caught the insect, then squatted with fluttering wings and gaping throat begging to be fed. "Pity me! I am starving!"

A squirrel frequently shared a meal with the jays, and it was interesting to watch the performance. The furry gentleman is at perfect ease among his feathered friends, not seeming to be disturbed by them, nor to

wish to molest them; but if I move he seems to consider it a signal to break camp, and off he goes, his tail a wriggling wake in his rear.

One evening I saw a rabbit which had invaded the sacred territory. He nibbled along, here and there stopping to taste a bite, not at all disturbed by my presence, though I stood erect within 20 feet of him. For the time the jays were absent. However, just as Bunny stopped by the scrap stump a jay came from the woods on cleaving wing and alighted on the stump within 8 inches of the long eared invader's nose. It was amusing to see the look of surprise on the jay's face. He stood aghast, looking on while Bunny ate; then hopped down beside him and chipped in.

While crossing a meadow I came one day on a chipmunk which seemed so fearless that I stopped to examine him closely. He stood erect on the edge of his home, paws curved across his breast, and eyed me without a tremor. I slowly approached till within 3 feet of him. I could have hit him with my walking stick. After regarding me fixedly 2 or 3 minutes, he went down stairs to tell Mrs. Chipmunk, and the children about it; then came up again and went across to another hole 40 yards away, probably to tell his mother-in-law.

I found a coyote, a few evenings later, trying to catch young magpies. I do not know if he succeeded. As he sat down to take a rest, 150 yards away, I tried my Remington on him, off-hand, but missed. It was an easy shot, and I reproved myself back into the house. I had pulled too quickly. I scared him, however, as badly as if I had hit him between the eyes. He jerked the throttle wide open and burned half a mile of airhole into a cinder getting away.

Not long afterwards the same Remington, in other hands, killed a mother coyote, which, I found on skinning her, had a family of children somewhere that waited long for the footfall which never came, and died of starvation. She was only a wolf, and her children would have been thieves had they lived. A ranchman would have been glad, perhaps; but I could not help feeling a keen sorrow for the helpless, hungry babies, dying so miserably, and regret that I should have borne a share in her killing. How little mercy has man shown the other animals!

Quails have wintered well, and are unusually plentiful. When plowing stubble, it is not uncommon to have a covey of 10 or so fly up all around the horses. Rabbits are scarce. Can some reader of RECREATION inform me where I can get good deer and grouse shooting near here?

Thos. P. Neet, Versailles, Ky.

IF YOU WOULD LIVE NEXT TO
NATURE READ RECREATION.

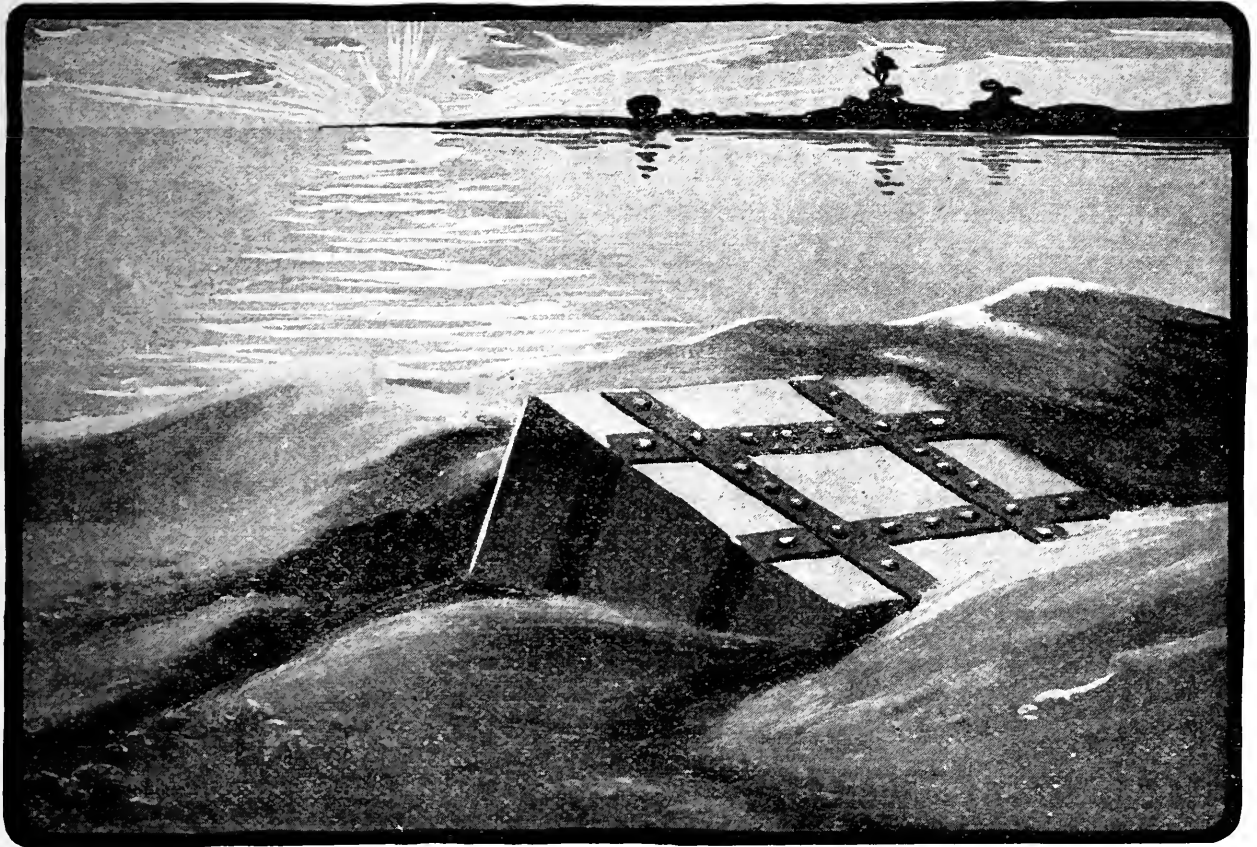

BURIED TREASURE.

Ever Try to Dig It Up?

The biggest boxes of gold are dug up out of a man's strong, money-making brain. No box of Capt. Kidd's ever held the gold owned by the money makers of the present day. And those same money makers keep the brain well, strong and of the money making sort by feeding on Grape-Nuts.

Ask the next millionaire or successful lawyer, author or business man if he eats Grape-Nuts. Try the experiment on several and learn something of how they feed. They may know a secret that would make you rich.

You can't keep a strong brain down and Grape-Nuts food makes strong brains for the brain making and rebuilding elements are there and the facts will come out in undeniable form after a trial of the famous food.

The tool that makes money is the brain.

Weak, dull tools don't do the work.

Brain absolutely must be fed on the right kind of food if results are to be had — Grape-Nuts is that food.

There is a reason.

You can prove it by trial ten days.

Dig up your buried treasure.

Cap'n Titus

By CLAY EMERY

Boston Globe

"Rich and racy salt-briny stories, depicting New England country folk to the life."

Washington, D. C., Evening Star

"Mr. Emery has artistically caught the spirit of the folk-life of New England."

Rochester Democrat and Chronicle

"Uproariously entertaining."

New York Times

"He is another David Harum in storytelling and trading."

Price, 75 cents

Postage Paid

DOUBLEDAY, PAGE & COMPANY
PUBLISHERS

34 Union Square

New York

It is all in The Lens

Any old box will answer the purpose if it does not leak light; but you must have a fine lens to make a fine picture.

You can get

**A Royal Anastigmat
Lens, 4 x 5, Series No. 1**

Made by the Rochester Lens Co., Rochester,
New York,

**And listed at \$45,
For 40 yearly subscrip-
tions to RECREATION**

You can get any other lens made by this Company on the basis of one subscription to each dollar of the list price of the lens.

Sample copies of RECREATION for use in soliciting furnished on application.

The Laughlin Fountain Pen

IS THE PEER OF ALL PENS AND
HAS NO EQUAL ANYWHERE

**Sent on Approval
to Responsible People**

**YOUR CHOICE
OF THESE TWO POP-
ULAR STYLES
FOR ONLY**

\$1.00

Post-paid
to
any
address

**By Registered Mail 8c
Extra**

**Superior to the \$3.00
Grades of
Other Makes**

**Our Extraordi-
nary Offer**

Send us one dollar and we will mail either of these two styles. You can try it for a week—if it don't suit you mail it back to us and we will return your dollar. Ever hear or read of anything fairer?

The Laughlin Fountain Pen holder is made of finest quality hard rubber, is fitted with highest grade, large size, 14k gold pen of any desired flexibility, and has the only perfect feeding device known. Either style richly gold mounted, for presentation purposes, \$1.00 extra.

Lay this magazine down and write now.



Laughlin Mfg. Co.

424 Griswold St.

DETROIT, MICH.

Follow the
Keystone

When you buy a watch, first select the works and then tell the jeweler you want a Jas. Boss Stiffened Gold Case. To protect yourself from deception be guided by the Keystone Trade-mark which you will find in every

JAS. BOSS
Stiffened
GOLD Watch Case

Better than an all-gold case because stronger; cheaper because no gold is wasted. The Jas. Boss Case is guaranteed for 25 years. Won't wear thin. Consult your jeweler. Write us for book.

THE KEYSTONE WATCH CASE COMPANY, Philadelphia.



Last fall I killed a whitetail buck having what I consider remarkable antlers. I submit a few measurements for comparison with other large heads: Widest spread, 22 inches; base of horn to longest point, 18 inches; base of horn to base of brow prong, 3 inches; base of horn to base of first prong, 10½ inches; brow prong, 6 inches; first prong, 10 inches; second prong, 8 inches; from tip to tip of front points, 14 inches; circumference of horn, ½ inch from base, 5¼ inches. Number of points, 16. The antlers are heavy and well proportioned.

N. J. Shields, Mandan, N. Dak.

We have still a fair number of deer and a few moose. In some parts of the State bear are plentiful. Grouse are much less abundant than they were 5 years ago.

G. W. McKay, Kelsey, Mich.

HYPNOTISM

Some people fear this mysterious power. It is because they do not understand it. In truth it is the most powerful of human influences for good. **A FREE HOME BOOK**, published by the American College of Sciences, contains the opinions of thirty distinguished men, Professors in the largest Colleges and Universities in America, on this subject, and its hidden mysteries are made perfectly clear. It gives simple directions for acquiring the secret power at home and tells how to cure bad habits; how parents can control their children and make their dispositions sweet and lovely; how homes not fully in accord can be reunited by bonds of love; how diseases can be cured without drugs or medicine; how hundreds of startling, mystifying and beneficial experiments can be performed. According to the honest statements of eminent Doctors, Lawyers and Clergymen, the book is worthy of a prominent place in any home. Remember it is **absolutely free**. Write for it to-day Address **American College of Sciences, Dept CN 5, 420 Walnut St., Philadelphia, Pa.**

No. 58

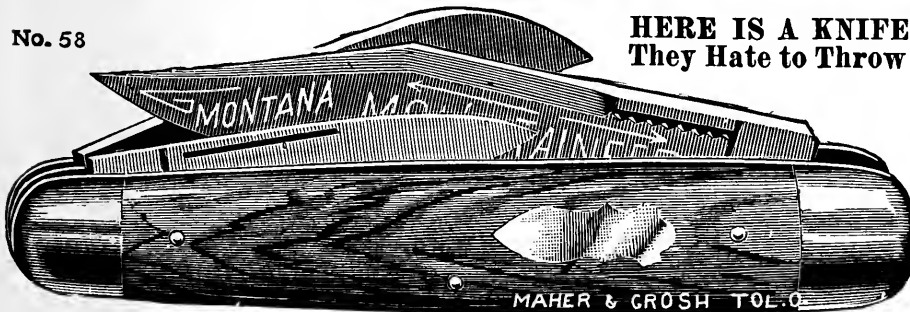

HERE IS A KNIFE Men Love So Much They Hate to Throw an Old Handle Away

No. 58. Cut is exact size; ebony handle, 3 blades, German silver ends. The long blade is for rough or fine work; the medium blade is as thin as a razor. Price, postpaid, \$1.00. 50,000 in use.

No. 34 we call 'Our Masterpiece'; weighs only 2 ozs.; 3 cutting blades; will cut a quill pen or an ax-handle; price, with ebony handle, postpaid, \$1.25; ivory, \$1.50; choicest pearl, \$2.00.

Our **Jack Knife** sells at 75c.; our special price is 48c., postpaid, 5 for \$2.00. All our blades file tested; warranted; replaced free if soft or faulty. Barbers' hollow ground **Razor and Strop** to suit, \$1.33. Send for free 80 page list and "How to Use a Razor."

MAHER & GROSH CO.
74 A Street Toledo, Ohio

No. 34

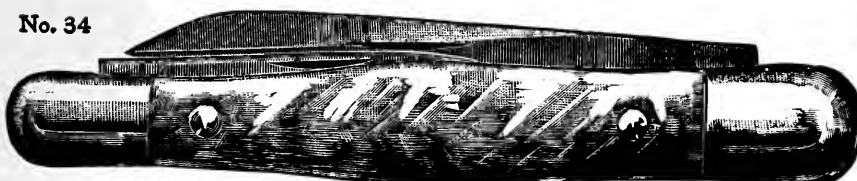

The Lamp of Steady Habits



The lamp that doesn't flare up or smoke, or cause you to use bad language; the lamp that looks good when you get it and stays good; the lamp that you never willingly part with, once you have it; that's

The New Rochester.

Other lamps may be offered you as "just as good"—they may be, in some respects, but for all around goodness, there's only one. *The New Rochester.* To make sure the lamp offered you is genuine, look for the name on it; every lamp has it. (300 Varieties.)

Old Lamps Made New.

We can fill every lamp want. No matter whether you want a new lamp or stove, an old one repaired or refinished, a vase mounted or other make of lamp transformed into a **New Rochester**, we can do it. Let us send you literature on the subject.

We are **SPECIALISTS** in the treatment of diseases of Lamps. Consultation FREE.

THE ROCHESTER LAMP CO., 38 Park Place & 33 Barclay St., New York.



For every deer hunter who spends a few weeks of each year away from civilization, there are 20 sportsmen whose greatest delight is to tramp for quails or grouse. Such men may not have the means to indulge in the expensive sport of big game hunting, and many of them would not if they had. To them a day afield with dog ranging the stubble, the sudden stop, the cautious advance and stiffening into a rigid point, the whir of wings, the successful shot and the retrieving of the birds, have more charms than an all-day hunt with one shot at a deer.

What woodcock shooter would ask for deer when the cock were rising in front of his brace of cocker spaniels? To him, the metallic whistle and darting forms among the bushes are more fascinating than the bay of hounds and a leaping buck.

Again the sportsman is among the wild hills in pursuit of the lordly ruffed grouse. He slowly makes his way down a ravine, its steep sides covered with pine, birch, and hemlock, while the knowing old pointer searches out every spot likely to hold a hiding bird.

Suddenly the dog comes to a point in a thick clump of pines, but before his master has taken half a dozen steps, a roar of wings is heard, and the bird is gone. All the hunter sees is a streak far up the gully, but he follows, in hope of a second rise. Soon the dog strikes the scene behind a fallen tree. The wily old bird rises on the other side of this and sails off at such a height the sportsman rightly concludes he has taken to a tree.

These disappointments only arouse the ardor of our friend. On he goes, making plenty of noise, which has the desired effect. The grouse dives out of a pine and flies toward a patch of thick brush, some hundreds of yards ahead. By this time the intelligent pointer is as anxious as his master, and makes straight for the cover.

• Time after time the grouse rises out of range, but the patient hunter follows, until

finally the demoralized bird lies close in some brush heap. When kicked out, he gives an easy straight-away, and as the hunter presses the trigger, a puff of feathers floats away on the breeze, while the dog eagerly darts forward to bring in the bird. Was not the successful finish well worth the trouble?

There is no other shooting so fascinating nor so difficult; yet few writers tell of their experiences with grouse and quails. If more sportsmen from different parts of the States and Canada would write of their observations of the haunts and habits of game birds, it would be a great help to beginners. J. A. MacKenzie.

Many of the presents which people give their friends afford pleasure only for a few days, or weeks. A subscription to RECREATION means solid comfort a whole year. It reminds your friends 12 times during the year of your kindness and generosity. There are many men and women who for 5 years past have annually sent in long lists of names of friends, accompanied with a check, in order that these friends might be made happy a whole year. Would it not be well for you to adopt this plan?

Try it and see how grateful the recipient will be.

The Bristol rod and case came and they are O. K. Please accept my thanks for them.

Chas. A. McNeill, Lebanon, N. H.

I received the King folding boat. Have it set up and am much pleased with it.

Harry S. Holmes, Ottumwa, Ia.

The Harrington & Richardson shot gun, which you forwarded as a premium, is entirely satisfactory.

F. N. Dutcher, St. Albans, Vt.

IF YOU WOULD LIVE NEXT TO NATURE, READ RECREATION.



GEORGE H. DANIELS,

GENERAL PASS. AGENT, N. Y. C. & H. R. R. R.

writes January 10, 1902: "The Ostermoor Patent Elastic Felt Mattresses that I bought of you nine years ago have proven perfectly satisfactory, and are all that you claim for them, besides vermin-proof and non-absorbent—a perfect success."



C. OLIVER ISELIN

CHIEF OWNER CUP DEFENDER "COLUMBIA"

writes April 24, 1897: "The Ostermoor Patent Elastic Felt Mattresses you furnished for my yacht, 'Titania,' give entire satisfaction, and should I build another yacht I should certainly give you another order."

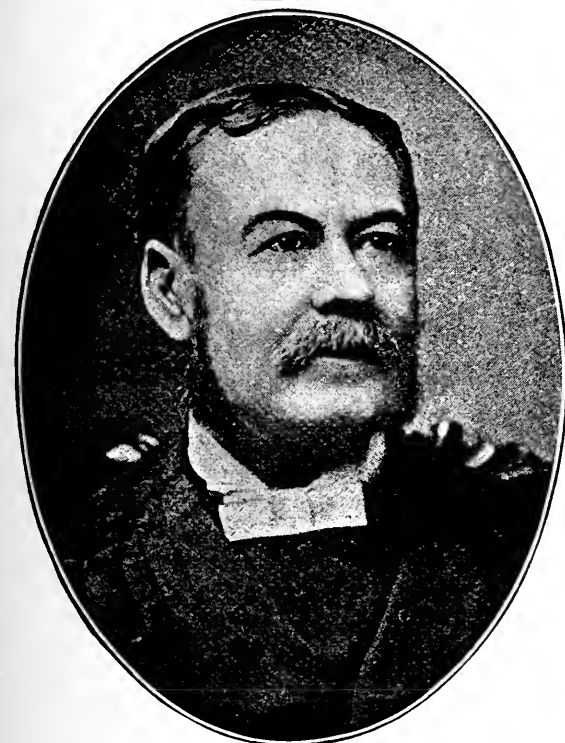

REV. R. S. MACARTHUR, D.D.

PASTOR CALVARY BAPTIST CHURCH, NEW YORK

writes on February 6, 1902: "The Ostermoor Patent Elastic Felt Church Cushions put in forty-nine years ago are still in most excellent condition. On going into our new church, we had you re-cover them and they are to-day as good as new."

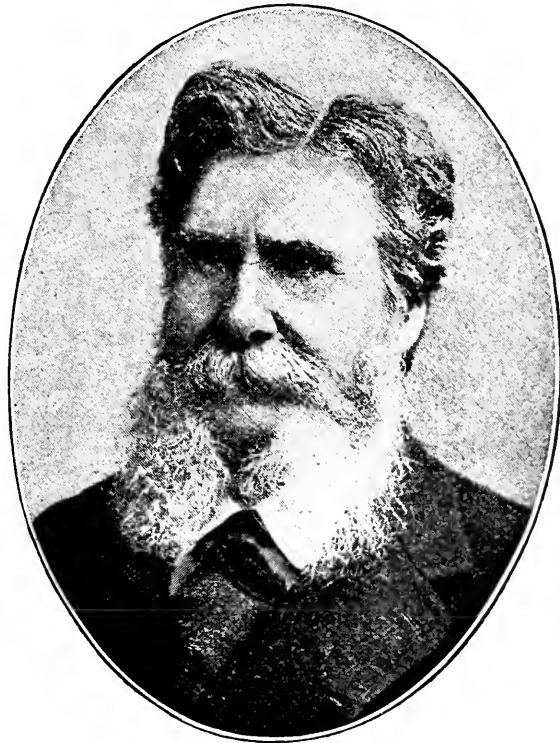

ALEXANDER E. ORR

RECENTLY PRESIDENT N. Y. CHAMBER OF COMMERCE

writes February 15, 1902: "The Ostermoor Cushions and Mattresses are still in use and in an admirable state of preservation and fully justify all you said concerning them at the time of the purchase, seventeen years ago."

If you wish to be posted on these wonderful Ostermoor Mattresses (even if you don't wish to buy), simply send your name on a postal for our handsome 96-page illustrated book, "The Test of Time"—mailed free. Beware of imitations trading on the name of "felt." Look for the name "Ostermoor" and our guarantee on every genuine mattress. Send your name to-day to Ostermoor & Co., 114 Elizabeth Street, New York.

For a Present to Your Best Girl

or your brother, or for some other girl's brother, or for any one you love, and who is fond of skating.

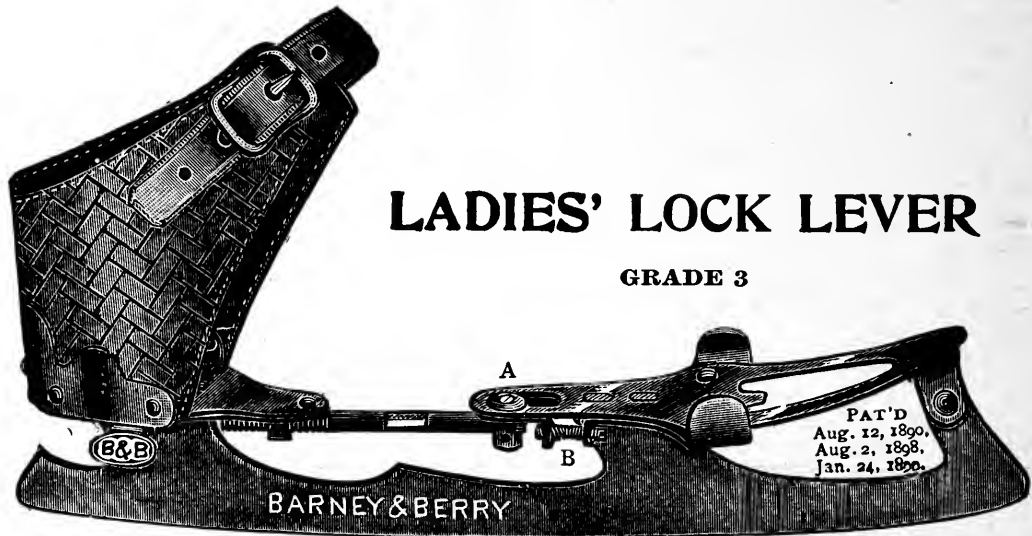

For 5 Yearly Subscriptions to **RECREATION**

I WILL SEND YOU

A pair of Lock Lever Skates

OR

A pair of Ladies' Lock Lever Skates

Grade 3, made by Barney & Berry, Springfield, Mass.

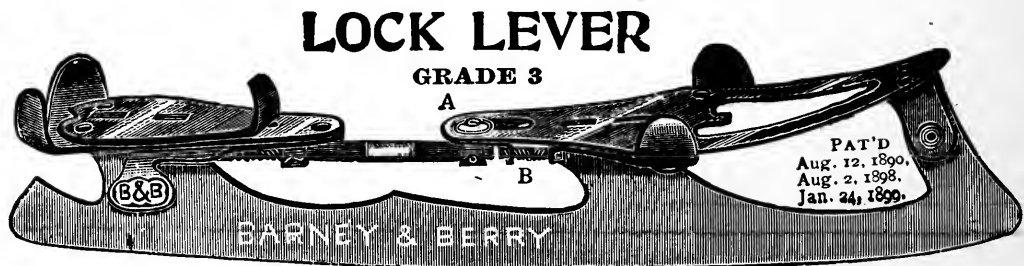

As every skater knows, these are the best skates made in the world. The winter season is here and you could scarcely select a more appropriate present

FOR A MAN, OR A WOMAN, A BOY OR A GIRL

than a pair of these high-grade skates. Only a limited stock on hand, and when these are gone this offer will be withdrawn.

Sample copies of **RECREATION** for use in canvassing furnished on application.

Our game laws are fairly good and are well enforced. During the past year some enormous fines were imposed on law breakers. In one case a man narrowly escaping imprisonment for perjury, was mulcted in fine and costs about \$300; all for shooting one pheasant. The population of the Province is so small that the wild regions are almost unexplored and are full of game. The Indians are perhaps the worst game hogs we have; no one knows the extent of the damage done by them annually. However, I really think the game will outlive the red man yet. You are doing a world of good in educating would be sportsmen in true sportsmanship. I know RECREATION has been an eye opener to me, for I was on the high road for the hog pen before I read it.

Dr. G. H. Manchester,
New Westminster, B. C., Can.

Conditions in the Sequoia National Park are not encouraging. A party traveling through the park last September passed, at Hockett meadows, the camp of the soldiers detailed to guard the park and its game, and saw a stack of deer hides in their possession. In August a party making roads in the park heard shooting. Soon a number of soldiers passed, 2 of them carrying on their saddle-bows what appeared to be carcasses of deer wrapped in blankets. While the soldiers were in the park last year shooting was heard nearly every day. A few civilian rangers would accomplish more good there than the entire army. No one ever hears of a soldier being punished for breaking the game law, though the settlers here will testify that they do it continually.

Otto Luhdorff, Visalia, Cal.

Received the Harrington & Richardson shot gun and am more than pleased with it. I thank you sincerely.

V. McGuire, Marshalltown, Ia.

The REAL SECRETS of HYPNOTISM

If you want to know the hidden mysteries of this strange mental influence, write us for a copy of our free book entitled "The Philosophy of Personal Influence." It is written by a man who made a fortune out of professional hypnotism. He fully explains the successful methods he used in private and on the stage, and gives such plain and simple directions, that they can be quickly learned at home. He tells how to acquire the subtle power of Personal Magnetism: how to exert a marvelous influence over others entirely without their knowledge; how to hypnotize instantaneously—quick as a flash and how to cure diseases and bad habits without drugs or medicine. The book fairly bristles with startling hypnotic revelations. Write to-day. Remember it is absolutely free. Address, New York Institute of Science, Dept. D. M. 5, Rochester, N. Y.

Not what is
said of it,
but what it does,
has made the
fame of the

Elgin Watch

and made 10,000,000
Elgins necessary to
the world's work.
Sold by every jeweler
in the land; guaran-
teed by the greatest
watch works. Illus-
trated art booklet free.

ELGIN NATIONAL WATCH CO.
ELGIN, ILLINOIS.

OIL--SMELTER--MINES!

DOUGLAS, LACEY & Co.

66 BROADWAY & 17 NEW ST., NEW YORK.

Bankers, Brokers, Fiscal Agents.

Members N. Y. Consolidated Stock Exchange, and
Los Angeles, Cal., Stock Exchange.

**Dividend-Paying Mining, Oil and Smelter
Stocks, Listed and Unlisted our Specialty.**

Booklets giving our successful plan for realizing the large
profits of legitimate Mining, Oil and Smelter Investments,
subscription blanks, full particulars, etc., sent free to any
interested on application.

BRANCHES. Boston, Philadelphia, Chicago, Cleveland, Cin-
cinnati, St. Louis, Baltimore, Washington,
Pittsburg, Buffalo, Prescott, Ariz.; Los Angeles, Cal.; Har-
ford, Halifax, N. S.; St. John, N. B., Montreal & Toronto.

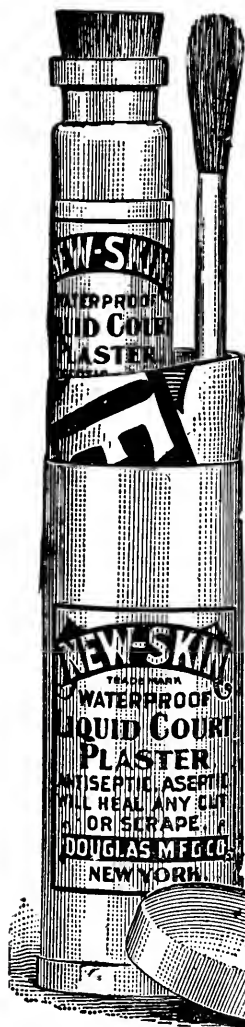

NEW-SKIN

TRADE MARK
REGISTERED

WATERPROOF

LIQUID COURT PLASTER

Heals Cuts, Abrasions, Hang-nails, Chapped and Split Lips or Fingers, Burns, Blisters, etc. Instantly Relieves Chilblains, Frosted Ears, Stings of Insects, Chafed or Blistered Feet, Callosities Spots, etc., etc.

A coating on the sensitive parts will protect the feet from being chafed or blistered by new or heavy shoes.

Applied with a brush and immediately dries, forming a tough, transparent, colorless waterproof coating.

**Mechanics, Sportsmen,
Bicyclists, Golfers' Etc.**

are all liable to bruise, scratch or scrape their skin. "NEW SKIN" will heal these injuries. WILL NOT WASH OFF, and after it is applied the injury is forgotten, as "NEW SKIN" makes a temporary new skin until the broken skin is healed under it.

Each
Pocket Size (Size of Illustration) . . . 10c.

Family Size 25c.

2 oz. Botts. (for Surgeons and Hospitals) 50c.

At the Druggists, or we will mail a package anywhere in the United States on receipt of price.

DOUGLAS MFG. CO.

Dept. W

107 Fulton St. New York



Lovely Complexion FREE.

A Trial Box Mailed FREE which will give any lady a beautiful complexion. It is not a face powder, cream, cosmetic or bleach, but is absolutely pure and you can use it privately at home. It permanently removes moth patches, redness, crow's feet, pimples, black

heads, fleshworms, sallowness, freckles, tan, sunburn, and all complexion disfigurements. Address,
MADAME M. RIBAUT, 4888 Elsa Bldg., Cincinnati, O.

Rheumatism

CURED WITHOUT MEDICINE.

What doctors, medicines and drugs fail to accomplish for the cure of rheumatism, gout, neuralgia, lumbago and sciatica, is quickly made certain by the employment of nature's mighty, mysterious force—magnetism. Absolutely guaranteed to cure any case, no matter how severe or of how long standing. Priceless book free to any sufferer for the asking. Address

**THACHER MAGNETIC SHIELD CO.,
116 Masonic Temple, Chicago, Ill.**

THE 1903 SPORTSMEN'S SHOW.

With the close of February, the 9th Annual Sportsmen's Show will be inaugurated at Madison Square Garden, New York City, and lovers of the gun, rod and rifle, as well as devotees of the canoe and paddle, the stream and the campfire, will be afforded the opportunity of spinning yarns with their fellows, and of gleaning information of practical value from experienced guides and hunters from nearly all game sections of the United States and Canada. The show will open Saturday, February 21st and will continue until Saturday, March 7, inclusive.

This year some notable additions to the shows of past years have been decided on. Representative guides from every game section of the country will be in attendance in greater number than ever before.

Perhaps the greatest attraction of this show will be the cantata of Hiawatha, to be rendered each afternoon and evening. The music will be produced by an orchestra of 45 pieces. A chorus of more than 60 voices, Indian and Caucasian, will support the score or more of Indian actors who will play the leading roles; and in every detail, the production promises to be a novelty to metropolitan amusement supporters as well as an unique departure in historic character portrayal and scenic effect.

Other features of the show will be a most interesting exhibit by the New York Zoological Society to which Director Hornaday is giving his personal and careful attention; an exhibit characteristic of the game resources of New Brunswick; interesting exhibits of modern launches, yachts, canoes and hunting boats; rifles, shot guns, fishing tackle and all other articles of equipment and supply known to 20th Century sportsmen. The display of Indian goods and handiwork will also be extensive and thoroughly representative. While details of many new features of this year's show have not yet been completed, enough has been accomplished to insure to sportsmen a rare treat in the Sportsmen's Show of 1903.

HAVE YOU A FRIEND
ANYWHERE IN THE WOODS,
IN THE MOUNTAINS
OR ON THE FARM,

WHO LONGS FOR SOMETHING TO READ
IN THE LONG WINTER EVENINGS, OR IN
THE LONG SUMMER DAYS?

SEND HIM RECREATION.

IT WILL PLEASE HIM A WHOLE YEAR
AND HE WILL RISE UP AND CALL YOU
BLESSED.

AND IT ONLY COSTS YOU \$1.

Sent Free: Ten varieties of Mexican postage and revenue stamps for one annual subscription to RECREATION sent in through me. Stamp collectors should not miss this chance to increase their collection of Mexican stamps. Albert M. Penn, Laredo, Tex

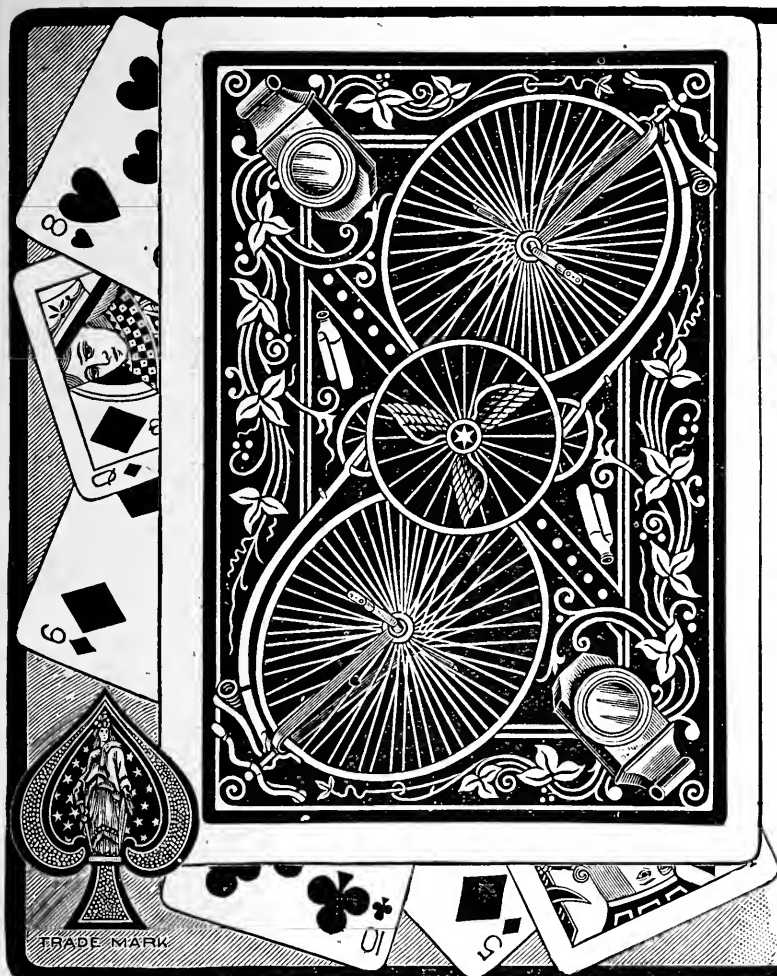

Why use poor cards when you can buy Bicycle Playing Cards

They wear well. Sold by dealers. Popular price. 29 backs. Back shown is "Wheel." Order by name.

The U. S. Playing Card Company,
Cincinnati, U. S. A

We will send 128-page Condensed Hoyle for 10 cents in stamps, if addressed to Department 23

The Rocky Mountain Goat

Is a shy, wary animal that ranges
8,000 to 15,000 feet
above sea level

and has rarely been photographed. Mr. A. M. Collins, one of RECREATION's prize winning photographers, has recently made 4 of the finest goat pictures ever produced. I HAVE had enlargements made from these, 13 x 15 inches, and will sell them

At \$5.00 a Set.

A rare and valuable group for sportsmen, amateur photographers and nature students. Address

**RECREATION, 23 WEST 24th ST.
NEW YORK CITY**



Club Cocktails

Famous the world over for purity. They never vary. The secret of their perfect blend is that they are kept six months before being drawn off and bottled. Be sure you have them in your camp, on the yacht, and on your outing trips wherever you go. They are ready and require no mixing. Simply pour over cracked ice.

For Sale by all Fancy Grocers and Dealers

G. F. HEUBLEIN & BRO.
29 BROADWAY, N. Y. HARTFORD, CONN.



NERVE FORCE

Nerve Force is the motive and regulative power on which every functional activity of the body is dependent. Because this is true, physical and mental fitness—the prerequisite to success in all callings—is impossible when the nerves are not being properly nourished.

Nerve force depends for its power upon a healthy circulation. Stagnant circulation, such as is found in congested varicose veins, favors the generation of ptomaines (poisons), and in neglected cases results in the most severe form of paralysis and mental disturbances, even insanity.

I have had an extensive and successful experience in treating all forms of nervous diseases. I have originated a method of treating Varicocele that is curative in every case, no matter how complicated; it only requires a few days' personal treatment to effect this cure. I have written extensively on Varicocele and associated diseases, and will send my recent publication (the sealed postage is ten cents) to any man who is sincere in his desire to obtain the most perfect health and nerve force.

Write me the symptoms that trouble you the most, and I will advise you the best course to pursue. There is no expense for this service unless you come to my home for treatment. I hold consultation and give personal attention to private correspondence at Suite F, 119 Michigan Avenue, Chicago.

DELMER D. RICHARDSON, M.D.



Free Rupture Cure

If ruptured write to Dr. W. S. Rice, 1546 Main St., Adams, N. Y., and he will send free a trial of his wonderful method. Whether skeptical or not get this free method and try the remarkable invention that cures without pain, danger, operation or detention from work. Write to-day. Don't wait.

Have You \$100 or more to Invest in a Good Thing

I am going to manufacture a new Fire Resisting Material to be used in every building, and a powerful Fire Extinguisher, just perfected. Our field is larger and more profitable than that of the telegraph or telephone. I have been offered \$50,000 by a representative of the Standard Oil Co., for the formulæ. It is worth millions. I want more capital. Large investors would insist on controlling the business. I propose to do this myself. Therefore, I prefer small investors.

I made over a quarter of a million dollars for my stockholders in a Maine Corporation in less than 18 months in '91-'92. Paid each one of them \$1,320 in cash for every \$100 invested. This is history, known all over New England.

I make no promises but advise you to investigate. I will send you a little illustrated book that tells how I rose from farmer boy to Mayor in my own city. Just how I made the money and paid the largest dividends ever paid in New England. You may not want to invest but the book will interest you. Every statement you can investigate. Address, with stamp for postage

E. F. HANSON, Treasurer

The Uronon Fire Resisting Co.
Belfast, Maine

LOOK AT THIS!!! If you send your subscription to RECREATION through me or direct to the office to be placed to my credit, I will send you free of charge any one of the articles mentioned below:

Shot gun bench crimper, sells for 75 c., in 10-12-16-20 gauge.

Shot gun cleaning rod, 3 attachments, sells for 50c., in 10-12-16 gauge.

Micrometer powder and shot measure, adjustable, and for both black and smokeless powder; sells for 65c.

U. S. Government rifle cleaner, any caliber, with attachments, sells for 60c., packed in neat canvas bag.

A duck, or snipe, or turkey call, sells for 75c. each, best made.

Address Henry B. Floyd, 1365 Emerson St., N. E., Washington, D. C.

50c. SUPERFLUOUS HAIR REMOVED
I guarantee that a few drops of my liquid will remove hair instantaneously, effectively, and without the slightest harm, pain, burn or blister. Sent upon receipt of fifty cents with full instructions.
Mme. MARIE LEON,
905 E St. James Bldg., 1133 Broadway, New York.

FREE BOOK, WEAK MEN



My illustrated nature book on losses, varicocele, impotency, lame back, free, sealed, by mail. Much valuable advice and describes the new DR. SANDEN HERCULEX ELECTRIC BELT. Worn nights. No drugs. Currents soothing. Used by women also for rheumatic pains, etc. 5,000 cures 1901. Established 30 years. Advice free.

DR. G. B. SANDEN,
1155 Broadway, N. Y.

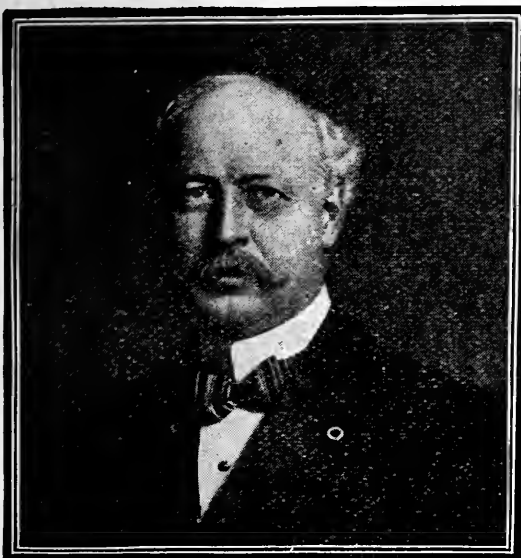

H. J. TILLOTSON, M. D.
The Master Specialist of Chicago, who Cures Varicocele,
Hydrocele, and treats patients personally.

Established 1880.

(COPYRIGHTED)

manent. My consultation will cost you nothing, and my charges for a perfect cure will be reasonable and not more than you will be willing to pay for the benefits conferred.

Certainty of Cure is what you want. I give a legal guaranty to cure or refund your money. What I have done for others I can do for you. I can cure you at home.

Correspondence Confidential. One personal visit at my office is preferred, but if it is impossible for you to call, write me your condition fully, and you will receive in plain envelope a scientific and honest opinion of your case, free of charge. **My home treatment is successful.** My books and lectures mailed free upon application.

H. J. TILLOTSON, M. D., 140 Tillotson Bldg, 84 Dearborn St., CHICAGO

Varicocele Hydrocele

**Cured to Stay Cured in 5 Days,
No Cutting or Pain. Guaranteed
Cure or Money Refunded.**

VARICOCELE. Under my treatment this insidious disease rapidly disappears. Pain ceases almost instantly. The stagnant blood is driven from the dilated veins and all soreness and swelling subsides. Every indication of Varicocele vanishes and in its stead comes the pleasure of perfect health. Many ailments are reflex, originating from other diseases. For instance, innumerable blood and nervous diseases result from poisonous taints in the system. Varicocele and Hydrocele, if neglected will undermine physical strength, depress the mental faculties, derange the nervous system, and ultimately produce complicated results. In treating diseases of men I always cure the effect as well as the cause. I desire that every person afflicted with these or allied diseases write me so I can explain my method of cure, which is safe and per-

GUN TALK.

The 25-35, 30-30, 30-40 and 7 mm. rifles have, with full jacketed bullet, greater penetration than any gun built for black powder and plain lead bullet. They have, also, a flatter trajectory. But with soft point bullets none of them will compare, for shock and penetration, with the 45-70-500. It must be remembered that the 45 cuts as large a hole at the entering point as the 30 does after it has expanded; and that a 45-500 grain bullet will expand to more than twice its origin size, with a penetration of 17 inches in soft pine. A 30-40 soft point will penetrate 14 inches in the same wood.

I have, with a Sharp's 45 rifle, 110 grains of black powder and 550 grain patched bullet, got a penetration of 26 inches in pine. At 200 yards, rest shooting, with the same gun and load, I made a score of 97 on the standard American off-hand target.

The Savage has a poor trigger pull and a slow lock; otherwise it is all right. I wish, those correspondents of RECREATION who praise the accuracy of the 25-35 would try their favorite weapon for a 10 shot string at 200 yards. I do not think they would care to report the results.

As to shot guns, I think the Ithaca one of the best. For duck shooting give me a 10 pound 10 bore; and I am no game hog, either.

O. E. Holdridge, North Adams, Mass.

Do You Keep a Gun?

If so, would you not like a rack for it?

**Do you keep more
than one gun?**

If so, would you not like racks for all
of them?

**For 5 yearly subscriptions to
RECREATION**

I will send you

a pair of buffalo horns

beautifully polished and mounted on nickel bases, which may be screwed on the wall.

A pair of these horns make a unique and convenient gun rack, and a valuable trophy of the grandest game animal America ever had.

These horns are easily worth

five dollars

a pair and sell readily at that price. I have been fortunate in securing a considerable number of them at a price that enables me to make this remarkable offer.

Send in your Club at once.

SOME RARE OPPORTUNITIES

These goods are all new, and will be shipped direct from factory. Prices named are those at which manufacturers and dealers usually sell. Here is a good chance to get

A Book, a Gun, a Camera
A Sleeping Bag, a Fishing Rod
A Reel, a Tent, } FREE OF COST

Subscriptions need not all be sent at once. They may be sent in installments as taken and credit will be given on account. When the required number is obtained the premium earned will be shipped.

These Offers are subject to change without notice.

TO ANY PERSON SENDING ME

TWO yearly subscriptions to RECREATION at \$1 each, I will send a copy of *Hunting in the Great West*, cloth; or a Zar Camera, listed at \$1; or an Ingersoll Watch or Cyclometer, listed at \$1; or a Recreation Waterproof Match Box, made by W. L. Marble and listed at \$1; or a Shakespeare Revolution Bait listed at 75 cents; or a Laughlin Fountain Pen; or a dozen Trout Flies, assorted, listed at \$1; or a pair of Attachable Eyeglass Temples, gold-plated, made by Gall & Lembke; or a Gold Medal Folding Camp Cot.

THREE subscriptions at \$1 each, a safety pocket ax, made by W. L. Marble and listed at \$2.50; or a dozen Bass Flies, assorted, listed at \$2; or 4 dozen Carbutt plates, 4x5 or 5x7; or a pair of chrome tanned horsehide hunting and driving gloves, listed at \$1.50, made by J. P. Luther Glove Co.

FOUR subscriptions at \$1 each, an Ideal Hunting Knife, made by W. L. Marble and listed at \$2.50; or a .32 caliber Automatic Forehand Revolver, made by the Hopkins & Allen Arms Co.; or a No. 822 Rifle made by the Hopkins & Allen Arms Co., listed at \$4.50.

FIVE subscriptions at \$1 each, a copy of *Cruisings in the Cascades*, cloth; or a set of Nehring's Convertible Ampliscopes, listed at \$5.00; or an Ideal Hunting Knife made by W. L. Marble, and listed at \$3; or a polished Buffalo Horn Gun Rack, made by E. W. Stiles; or a Forehand Gun, made by the Hopkins & Allen Arms Co., listed at \$6; or a pair of lock lever skates, made by Barney & Berry, listed at \$4.50; or a pair of gauntlets, for hunting and driving, ladies' size, listed at \$2.50, made by J. P. Luther Glove Co., or a J C Hand trap made by the Mitchell Mfg. Co., listed at \$4.

SIX subscriptions at \$1 each, a Hawkeye Refrigerating Basket made by the Burlington Basket Co., or one dozen Eureka golf balls listed at \$4; or a Century Camera, model 10, 4x5, listed at \$9; or a Forehand Gun made by the Hopkins & Allen Arms Co., listed at \$9.

SEVEN subscriptions at \$1 each, a copy of *The Big Game of North America*, or of *The American Book of the Dog*, cloth, or one set Lakewood golf clubs, 5 in number, listing at \$5; or a series IIB or IID Korona Camera, made by the Gundlach Optical Co., listed at \$10.

EIGHT subscriptions at \$1 each, a 4x5 Weno Hawk-Eye Camera, made by the Blair Camera Co., and listed at \$8.

NINE subscriptions at \$1 each, an Acme single shot gun, made by the Davenport Arms Co., and listed at \$8.

TEN subscriptions at \$1 each, a Cut-Glass Salad Bowl, made by Higgins & Seiter, and listed at \$4.50; or a Yawman & Erbe Automatic Reel, listed at \$6 to \$9; or a Bristol Steel Fishing Rod, listed at \$6, or less; or a Waterproof Wall Tent 7x7, made by Abercrombie & Fitch, and listed at \$8; or a canvas hunting coat, made by H. J. Upthegrove & Son, listed at \$8; or a series I, 4x5, Korona Camera, made by the Gundlach Optical Co., listed at \$12.

TWELVE subscriptions at \$1 each, a Peabody Carbine valued at \$12; or a No. 5 Side Telescope Rifle Sight, listed at \$18; or a Davenport Ejector Gun, listed at \$10; or a Century Camera, model 12, 4x5, listed at \$18.

FIFTEEN subscriptions at \$1 each, a Shakespeare Reel, Silver Plated, listed at \$15; or a set of rabbit plates made by Higgins & Seiter, and listed at \$8, or a pair of horsehide Hunting shoes, made by T. H. Guthrie, Newark, N. J., and listed at \$8, or a Field Glass made by Gall & Lembke; or a Kenwood Sleeping Bag, complete, with canvas cover, listed at \$16.

TWENTY subscriptions at \$1 each, a 14-karat Gold Hunting-case Watch, with Waltham Movement, listed at \$20; or a Repeating Rifle, listed at \$16 or less; or an Elita single shot gun, made by the Davenport Arms Co., and listed at \$18, or a pair of horsehide Hunting Boots, made by T. H. Guthrie, Newark, N. J., and listed at \$10; or an Acme Folding Canvas Boat, No. 1, Grade B, listed at \$20; or a Mullins Duck Boat, listed at \$20.

TWENTY-FIVE subscriptions at \$1 each, an 11-foot King Folding Canvas Boat, listed at \$38; or a Repeating Rifle, listed at \$20 or less; or a 4x5 Planatic lens, made by the Rochester Lens Co., and listed at \$25; or a Century Grand Camera, 4x5, listed at \$35; or a Syracuse Grade O, double hammerless Gun, made by the Syracuse Arms Co., and listed at \$30.

THIRTY subscriptions at \$1 each, a Repeating Rifle, listed at \$25 or less; or a Waterproof Tent, 14½ x 17, made by Abercrombie & Fitch, and listed at \$25; or a corduroy hunting suit, made by H. J. Upthegrove & Son, including coat, vest, trousers, and hat, listed at \$23.75; or an Ithaca, quality No. 1, plain, double barrel, hammerless breech loading shot gun, listed at \$40.

THIRTY-FIVE subscriptions at \$1 each, a 14-foot King Folding Canvas boat, listed at \$48.

FORTY subscriptions at \$1 each, a Savage .303 Repeating Rifle; or a No. 10 Gun Cabinet, made by the West End Furniture Co., and listed at \$32; or a Field Glass, made by C. P. Goerz.

FORTY-FIVE subscriptions at \$1 each, a Royal Anastigmat Lens, 4x5, series I, made by Rochester Lens Co., and listed at \$45.

FIFTY subscriptions at \$1 each, a No. 20 Gun Cabinet, made by the West End Furniture Co., and listed at \$38.

TWO HUNDRED subscriptions at \$1 each, a strictly first class upright piano, listed at \$750.

Address, **Recreation** 23 West 24th St.
New York

SHREDDED

WHEAT

WHOLE

BISCUIT

Split
Toast
Enjoy



106

No attempt to improve on the work of nature in making Shredded Wheat. The properties naturally organized are then scientifically cooked.

That is all.

Send for "THE VITAL QUESTION" (Cook Book, Illustrated in colors) FREE. Address

The NATURAL FOOD CO., Niagara Falls, N. Y.

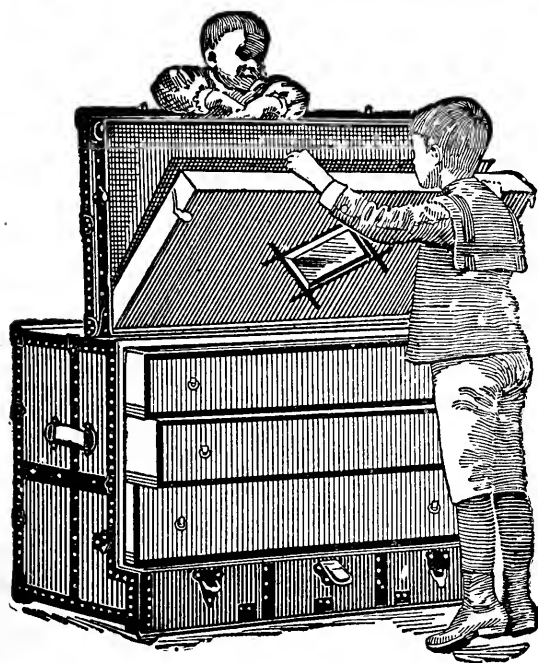

Stallman's Dresser Trunk

Have you seen one? It is up-to-date. Think of it, everything within reach. No heavy trays, but light, smooth drawers. Holds as much and costs no more than a good box trunk. Hand riveted, almost indestructible. Once tried, always recommended. Sent C. O. D., privilege examination. 2c. stamp for catalogue. Mention RECREATION.

F. A. STALLMAN,

87 W. Spring St.,

Columbus, O.

HIGGINS & SEITER



If you would like to be thoroughly well informed as to

CHINA and GLASS

with a view to obtaining it from the largest collection in the world, at

"1/4 Less than Elsewhere,"

Send for our Catalogue 13(u) carrying more than a thousand illustrations.

"How to Serve a Dinner," an elegant brochure by "Oscar" of the Waldorf-Astoria, also sent free to those really interested.

West 21st & 22d Sts., New York (Near 6th Avenue)

"BUY CHINA AND GLASS RIGHT"



ADDRESS
EUGEN SANDOW
 BOSTON, MASS.

I will send you a thorough trial course of my **FAMOUS SYSTEM** of **PHYSICAL DEVELOPMENT** free of all expense, if you will send a year's subscription, \$1.00 to

Sandow's Magazine for 1903

Each number will contain, among other valuable features, one of a series of the most perfect **Anatomical Charts** (in colors) ever published. During the year

SANDOW'S MAGAZINE

will contain more than **1,000** pages of the most authentic, valuable, and interesting information on

Physical Culture, Hygiene and Recreation

Send sex, age, height, weight, vocation, the general condition of your heart, lungs, stomach, and nerves, and I will immediately make up and forward you a **personal** course of exercises which, if **practised** a few minutes daily, will

Keep you in perfect health and fully demonstrate my system



This fold takes the weight of game and shells off the arms when they are raised in the act of shooting

This Patent

recommends itself and reminds you that on receipt of your name and address we will mail you our

Illustrated Catalogue

containing samples of

Corduroy, Canvas, Macintosh, Flannels, etc.,

also cuts, descriptions and blanks for measurement. Address

H. J. Upthegrove & Son,
 No. 2 Wood Street, VALPARAISO, IND.



Banner
(TRADE MARK)
Brand
Rubber
Coat

Pattern 28 Weight, 4¾ lbs.
Absolutely Waterproof
A Gentleman's Rain Coat

"Can you furnish a GOOD Rubber Coat, not too heavy and yet strong and serviceable, which I can use in my practice as well as on fishing trips; a d that will KEEP ME DRY?"
F. A. KNIGHTS, M.D., Minneapolis.

This order we filled with a "BANNER" RUBBER COAT, Pattern 28, and 6 months later the Doctor said: "It is just what I want and is the only coat I ever found that would REALLY SHED RAIN."

Sent express paid anywhere in United States on receipt of \$5.00. Sizes, 36 to 46 inches Length, 54 inches.
Give chest measure over ordinary coat.

Mackintoshes and Rain Coats made to order
All best quality Rubber Goods
Write for List No: 20

NORTHERN RUBBER CO.
P 3314 So. Ninth Avenue
Minneapolis, Minn.

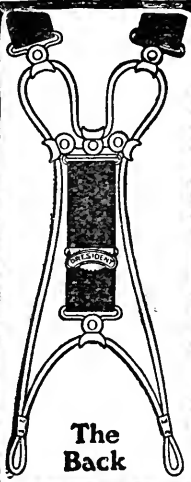

The why some shop-keepers do not sell
President Suspenders
is they make more money on imitations 50 cents and a dollar. Ask at favorite shop, or post prepaid from
C. A. Edgerton Mfg. Co.
Box 219-1 Shirley, Mass.
Send 6 cents for catalogue.

The Back

THE REMINGTON-LEE.

The Remington-Lee must be seen to be appreciated. No one who examines it can fail to see its many advantages over other sporting repeating rifles. It is extremely simple, being composed of fewer parts than some single shot rifles. The bolt, the main part of the mechanism, can be dismantled without tools and removed in 10 seconds. All working parts of the gun can be cleaned in a minute by using an oiled rag. With the bolt removed, the interior of barrel can be cleaned from the breech and an unobstructed view of the bore can be had.

When the hammer is at half cock the mechanism locks, making it impossible for the bolt to open accidentally. The firing pin can not reach the shell in the barrel until the bolt is up and locked. Having a hammer, it is not necessary to carry the gun at full cock when a shell is in the chamber, as is the case with a hammerless. The weapon balances perfectly and weighs but 6½ pounds. It is equipped with a detachable box magazine, and 3 extra magazines accompanying each gun enable the shooter to discharge 20 shots without stopping to re-fill the holders. By pressing the magazine catch in front of the trigger the magazine and contents can be instantly removed, thus avoiding the danger which always attends working the cartridges out through the action. E. W. H., Gans, Pa.

I have received \$19.50 for Miss Irene Murray's pet wolf fund, and have sent her a check for \$15. She asks \$40 for the wolf. The Director of the United States Zoological Park at Washington has agreed to take the wolf and care for it, and all who visit Washington within the next few years may see Robin in a comfortable and commodious home. Readers who have not yet sent in their contributions to this fund are requested to do so at once in order that Miss Murray may have the use of the money in completing her education. Any sum from 10c. to 50c. will be gratefully accepted. The list of contributors will be printed in RECREATION as soon as completed.

The Reason the LUTHER HAND-MADE GLOVE will not rid



Machine sewing cuts itself



Hand sewing cannot.



A Practical Hunting and Driving Glove

Made for practical, comfortable, durability. No Oil. No Odor. No Animal Glue. Practically seamless. Cannot Rip. Unaffected by moisture of any kind. If soiled, may be washed with soap and hot water, without injury. The Luther Fastener is adjustable, fits any wrist and cannot get out of order. Illustrated booklet, samples and self measurement rule on application.

you prefer to buy through your dealer send us his name

No. 308 Driving Glove postpaid anywhere **\$1.50**, made to measure **\$2.50**,
No. 320 Gauntlet, " " " **3**

J. P. LUTHER GLOVE CO., 536 Pearl St., Berlin, Wis.

CONLEY MFG. CO., St. Joseph, Missouri**Notice our Prices****Conley Combination Coat, Vest and Duck Blind, \$5**

Ordinary Field
Coat,
Corduroy Collar
and Cuffs
\$2.75



Field Trousers, Adjustable Belt, \$1.50
Coat and Pants, \$4

All our garments are now made of English Khaki Cloth same as adopted by the U. S. Government for Army Uniform. Light green color. Very light weight. Noiseless in the woods. Send for booklet and measurement blanks. Mention RECREATION.



Shooting Jacket
\$3.00

GUARANTEED all wool, seamless, elastic, close fitting, but not binding, comfortable and convenient. Designed especially for duck shooters, trap shooters, etc., but suitable for all out-door purposes. Must be seen to be appreciated. Made only in two colors—dead grass and Oxford Gray.

Send us your address for one of our Gun Catalogs.

The H. H. KIFFE CO., 523 Broadway, N. Y.

The Celebrated
THOMPSON-QUIMBY
Hunting
Boots,
Shoes and
Moccasins

I have on file measurements of all who bought Boots and Shoes of the W. Fred Quimby Co., of New York for the past 20 years, and I make the same grade of sportsmen's footwear as they made. I was superintendent of the shoe department of that firm and bought the right to make these boots and shoes. Get a pair now. They will last years and are the cheapest in the end. I refer by permission to the Editor of RECREATION. Measurement blanks and prices on application. Mention RECREATION.

T. H. GUTHRIE
33 William Street, NEWARK, N. J.

All Work Guaranteed

THOMPSON

THEY'RE MADE TO MEASURE

Putman Boots.

Go on like a glove *and* fit all over.

For a Quarter of a Century Putman Boots have been the Standard among Western Hunters, Prospectors, Ranchmen and Engineers (who demand the best) and we have learned through our personal contact with them how to make a perfect boot.

Putman Boots are in use in nearly every civilized country in the World. They are Genuine Hand Sewed, Water Proof, Made to measure, Delivery charges prepaid, and cost no more than others. Send for catalogue of over **30 Different Styles** of boots, and blank for self measurement. Also **Indian Tanned Moosehide Moccasins**.

Illustration shows No. 900, 14 inches high, Black or Brown Leather.

Made to measure and delivered in the U. S. Canada or Mex. for **\$7.50**

H. J. PUTMAN & CO.

36 Hennepin Ave.

MINNEAPOLIS, MINN.

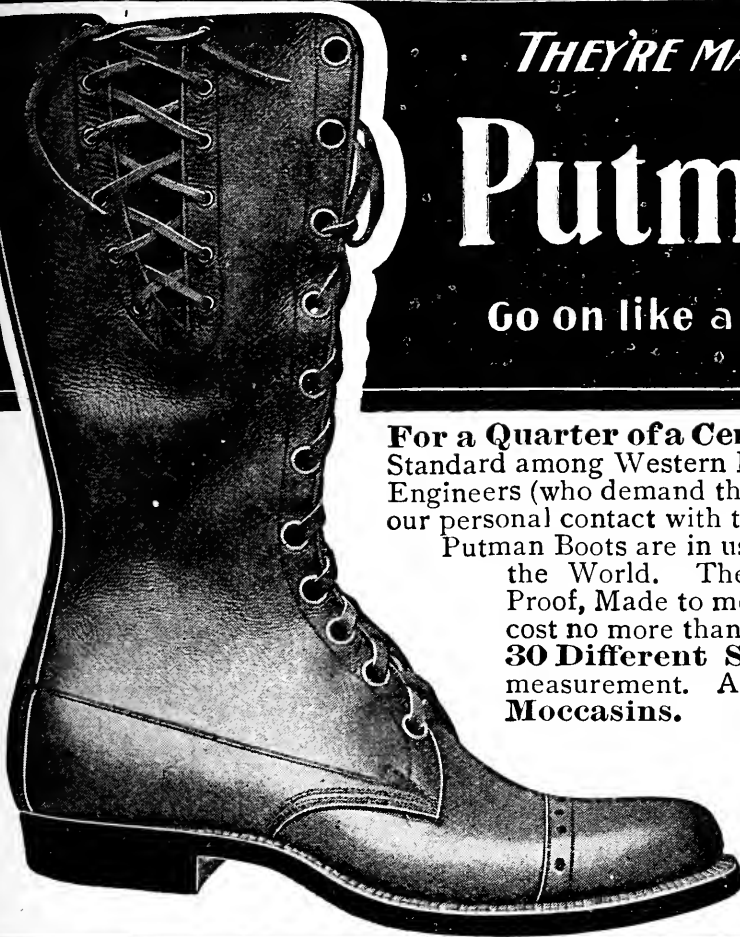

Last October I shot a large blacktail deer with a 30-30 Winchester. The animal was fully 225 yards away. I hit him in the right hind leg. The bullet, a soft nose, passed through the leg into the body, going through the heart and lodging in the left shoulder just beneath the skin. The lead spread over the copper jacket to the size of a 25 cent piece. I have been looking over my guns, which have been put away 4 to 7 months. We have had unusually wet weather, yet they are as bright as when they left the factory. To keep them so, I fill the barrels with vaseline.

W. H. LaBeurd, Dallas, Tex.

I am more than pleased with your magazine. Keep it up and give it to the game hogs. I used to be one, but RECREATION cured me and although I use a Winchester repeating shot gun, I stop in time.

J. Robertson, Wichita Falls, Tex.

Rescued From Drink

by a new discovery, odorless and tasteless, which any lady can give in tea, coffee or food. It does its work so silently and surely that while the devoted wife, sister or daughter looks on, the drunkard is reclaimed even against his will and without his knowledge or co-operation. Send your name and address to Dr. J. W. Haines, 2900 Glenn Building, Cincinnati, Ohio, and he will mail enough of the remedy free to show how it is used in tea, coffee or food.

SQUIRES' SIBERIAN MOOSE HUNTING BOOTS & SHOES

Made only by **HENRY C. SQUIRES & SON**
20 Cortlandt St., New York

The **leather** is waterproof, fine grained, tough and pliable. The

linings are russet calfskin. The **soles** are best waterproof anhydrous oak leather, **stitching** of silk, English back stays, bulldog toes, extra heavy **eyelets**, **Pratt fasteners** and **hand made throughout**. Price

\$7.50 net. Short Boots

\$8.50, Knee Boots

\$10, Cavalry Style

Boots **\$12**.

Special circular giving detailed information free for the asking.



Mention RECREATION.

Date, _____ 190

G. O. SHIELDS,

Editor and Manager of RECREATION, 23 West 24th St., New York.
Herewith find \$1.00 for which please send me RECREATION one year

beginning with _____ number.

Name, _____

Remit by P. O. or Express Money Order, or New York Draft.

DETACH THIS, FILL OUT, AND SEND IN.

AT DOCTORS H. R. PHILLIPS & WREAN'S RABBITRY, Penn Yan, N. Y., we breed for FOUNDATION STOCK

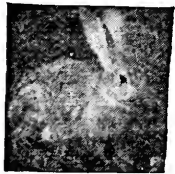

only, from the best strains of PEDIGREED STOCK. DOES, 6 to 10 months old, bred to IMPORTED BUCKS, for \$3 each. Fine color and strictly O.K. We guarantee all stock as recommended. We have a fine line of BLACK PEDIGREED BELGIANS.

Mention RECREATION.

DRS. H. R. PHILLIPS & WREAN.

Free: To anyone sending me \$3 for three subscriptions to RECREATION I will send a pair of pretty Flying Squirrels. For seven subscriptions I will give a fine pair of Fox Squirrels. E. F. Pope, Colmesneil, Texas.

IN ANSWERING ADS PLEASE MENTION RECREATION.

Another Good Offer. Send me \$1 for a subscription to RECREATION, or send it direct to RECREATION to be credited to my account, and I will send you free, a beautiful unmounted Mexican Opal, which would cost ordinarily from 50c to \$1. Don M. Harris-308 Crawford Road, Cleveland, Ohio.

Eggs Free: To all who send me 3 yearly subscriptions to RECREATION, at \$1 each, I will send one sitting of barred Plymouth rock eggs. America's best strains. Chas. Knisely, Prairie Depot. Ohio.

Mexican Opals Free: To any one subscribing to RECREATION through me, I will send a beautiful genuine Mexican Opal, as large as a bean.

A. Thomson, Box 332, San Antonio, Tex.

Received the Marble hunting knife sent best knife I ever saw. I thank you for it. me as a premium in good shape. It is the C. H. Bailey, Blue Hill, Me.

APPLICATION FOR MEMBERSHIP IN THE L. A. S.

ARTHUR F. RICE, Secretary L. A. S., 23 W. 24th St., New York.

DEAR SIR: Enclosed \$1 for membership fee for one year.

I certify that I am eligible to membership in the L. A. S. under the provisions of the constitution, and refer to 2 League members (or to 3 other reputable citizens) named hereon.

Name _____

Street or P. O. Box _____

City or Town _____

References

Detach this, fill out and send in.

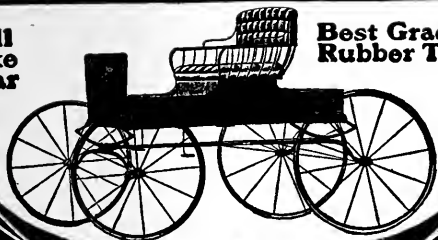
\$50 BUYS A RUNABOUTFull
Bike
GearBest Grade
Rubber Tires**SAVE
DEALERS
PROFITS**

The rapid increase in the volume of our business and the vast number of satisfied customers on our books prove we can serve your interests best.

We manufacture a full line of Buggies, Carriages, Wagons and Harness of very superior

**Quality—Style
Durability and Finish**

These four essentials are to be found in every vehicle and set of harness sent out by us. We employ only skilled mechanics in all departments and furnish them with the very best materials. With the entire output of two enormous modern factories and superb shipping facilities at our disposal, we are able to furnish high-grade vehicles at prices that—quality considered

Positively Defy Competition.

All goods guaranteed and shipped on approval. Money back if you are not satisfied. Write at once for our catalog and special inducement, it will interest you.

UNION BUGGY COMPANY, 495 Saginaw Street, Pontiac, Mich.

Taxidermist's Materials

Glass Eyes for Stuffed Birds and Animals
Oölogist's and Entomologist's Supplies

Send 5c. in stamps for Catalogue

FRED. KAEMPFER

88 State Street, Chicago, Ill.

Taxidermy work done in all its branches

FLORIDA BIRDS.

I have on hand a fair assortment of our Native Bird Skins, suitable for schools, museums or private collections.

During the season of 1903 I will collect any birds or mammals to order.

Finest mounted work a specialty.

R. D. HOYT, Taxidermist,
SEVEN OAKS, FLA.

**Hunter-Trapper**

Published monthly by an experienced hunter, trader and trapper—tells about hunting, trapping and raw furs. Contains 64 pages each month.

Sample copy, 10 cents, silver.

Address Hunter-Trapper-Trapper
Box 30, GALLIPOLIS, OHIO

**FINE MOUNTED GAME HEADS,
BIRDS, ETC.,** for sale at unheard-of prices.
Send 10 cents for photos.

JOHN CLAYTON, Taxidermist, Lincoln, Maine

IN ANSWERING ADS PLEASE
MENTION RECREATION.

A GREAT OFFER!**FOR 60 DAYS**

To thoroughly introduce our beautiful and gorgeously colored NAVAJO INDIAN BLANKETS in every appreciative American home, we the undersigned will, on receipt of TEN DOLLARS (\$10 in P.O. money order, bank draft, or express money order, send you a magnificent Closely Woven, Gorgeously Colored and Designed

\$20.00
FOR
\$10.00

**Navajo
Indian
Blanket**

that cannot be retailed by any other dealer at less than \$20. NOW DON'T DELAY, but write at once, and leave the picking out for us to decide. Your money back if not satisfied. No two blankets sold to any one person. Make remittances payable to this Company.

Parties west of the Mississippi River address

LEANDER SMITH, Post Trader,
Canon Diablo, Arizona.

East of the River:

**The EDWARD SMITH INDIAN POST
TRADING COMPANY,**
Detroit, Mich.

Squab Book Free

Squabs are raised in 1 month, bring big prices. Eager market. Astonishing profits. Easy for women and invalids. Use your spare time profitably. Small space and capital. Here is something worth looking into. Facts given in our FREE BOOK, "How to make money with Squabs." PLYMOUTH ROCK SQUAB CO., 11 Friend St., Boston, Mass.

WANTED—ALIVE

10,000 Pheasants, 60,000 Quail, 10,000 Squabs

The demand is greater than the supply. Why not breed them yourself and make money? We will buy all you raise. Send two stamps for book with colored pictures, which tells you how to succeed.

Our "February Flyer"—1 globe, 2 Jap. gold fish, box fish food, bunch water plants, book of instructions. All 50c. Value, \$1.75. Shipped safely anywhere.

HUB POULTRY AND SUPPLY CO., Boston, Mass.
Station A, No. 5

ESTABLISHED 1895.

Genesee Valley Poultry Yards,
AVON, N. Y.

S. C. White Leghorns—Large, White, Hardy, Great Layers. The 20th Century "Business Fowl," Mammoth Pekin Ducks, Prize-Winning Barred Rocks, Buff Wyandottes, Stock and Eggs. Remember next Spring. OUR eggs hatch. Write wants, we'll treat you right.



POULTRY PAPER, illust'd, 20 pages, 25 cents per year. 4 months' trial 10 cents. Sample Free. 64-page practical poultry book free to yearly subscribers. Book alone 10 cents. Catalogue of poultry books free. *Poultry Advocate, Syracuse, N.Y.*

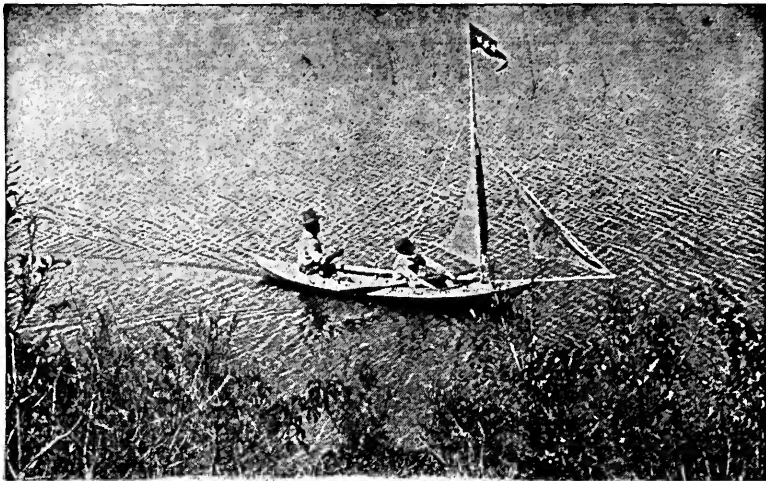

Recreation with the aid of a Mullins' Metal Boat or Canoe is as near perfect as you can get it.

Send for our handsome illustrated catalogue—FREE.

W. H. MULLINS
228 DEPOT STREET
SALEM, OHIO

“DINGER” WOODEN TAKE-DOWN DECOYS



Handy, substantial, light and portable. One dozen pack in smaller space and weigh less than two solid wooden decoys. Move about in lightest breeze; more alluring than stationary decoys. Cannot blow over. Price per doz. complete, \$5.00. Write for illustrated circular.

H. S. DILLS, Patentee, 21 11th St., Auburn, Ind.

Free: To anyone sending, through me, \$1 for yearly subscription to RECREATION, I will send free a No. 1 Sportsman's Medicine Case; for 2 subscriptions a Physician's Pocket Medicine Case; for 10 subscriptions 1,000 12-gauge primed paper shot shells. This offer is not open to old subscribers who formerly have sent in their subscriptions to the office of RECREATION, but to all others.
Walter Luson, Ardmore, Pa.

FREE To each person sending me \$1. (P.O. Money order) for one year's subscription to RECREATION, I will send his choice of the following.

A Genuine Briar Pipe with Genuine Amber Bit, or a Braided Leather Dog Whip with snap on end, or a Polished Steel Dog Chain with swivels, snaps, etc., or a MacMillan Shell Extractor for any size of shell from 8 gauge to 22 caliber, or a Pocket Compass, 1 in. dial open face, watch shape, with ring handle, bevel crystal

EDWARD S. ADAMS, Box 536, Manchester, N.H.

Warm Feet.

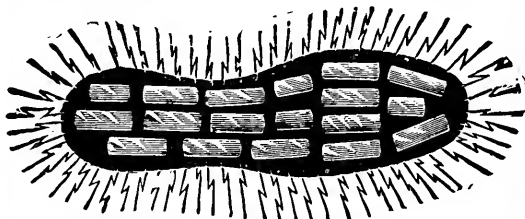

The greatest comfort and luxury of modern days; magnetic fire under your feet; the greatest life-protector known; your feet keep warm all the time, even if standing in water, snow and ice. Keeps rheumatism, colds and grippe out. Send for book full of information mailed FREE on request.

THACHER MAGNETIC SHIELD CO.,
Masonic Temple, 128 Chicago, Ill.

Huron Indian Work: To any one subscribing to RECREATION through me I will give a Bracelet and Ring worked in horse-hair, with any small inscription you like, your name, etc., woven in it with caribou hair; quite a curiosity, Send along your \$1. Walter Legare, 518½ John Street, Quebec, Canada.

FISHING. — Black Bass and Salmon. Illustrated Guide with Maps of the **RIDEAU, BEVERLEY & CHARLESTON LAKES, free.** Apply to E. A. GEIGER, Sup't Brockville, Westport & S. Ste. M. Ry., Brockville, Ont.

OLD DOMINION LINE

SHORT SEA TRIPS

POPULAR LINE FROM

**New York to
Old Point Comfort,
Norfolk,
Virginia Beach,
Richmond, Va.,
and
Washington, D. C.**

STEAMERS SAIL DAILY, EXCEPT SUNDAY AT
3.00 P.M.

Old Dominion Steamship Co.

H. B. WALKER, T. M. J. J. BROWN, G. P. A.
81 and 85 Beach Street New York

HIGH PRAISE FOR THE SAVAGE.

I am the owner of what I consider a most excellent weapon, a '99 model Savage. The balance of the arm is perfect, being equal to the highest grade shot gun in that respect. The shooting qualities are first class, the little lead miniatures shooting with the same regularity as the full range. This is one of the fine points of the Savage, and is not possessed by any other high pressure rifle that I know of. The Savage is a beautifully finished gun, strongly built and most simple in construction. It is well worth its price. I have used Savage and Lafin & Rand sporting rifle smokeless powders. I like the latter best for the miniatures; it can not of course be used in anything larger than miniature charges. I use 8 to 10 grains in the miniature lead cartridge, by Lafin & Rand powder measure. The bullet is the regular Savage miniature, Ideal No. 30810, weight 100 grains. This is a good all around short range bullet; its point being round it does not tear small game much.

I should like to hear from some of RECREATION'S readers what success they have had in using the paper patched Savage cartridge. I have my rifle fitted with a Lyman jack sight and Lyman leaf sight. I also have a Savage wind gauge peep sight, which fits on the tang. I note W. F. W.'s trouble with a Savage. He probably used a low front sight. If he puts on high front sight his rifle will, I think, shoot all right.

I prefer the rifle to any other arm, and my most enjoyable hours are spent with it. I have had more success with the Savage than with any other rifle I have owned, as it seems to suit every occasion.

The Savage people are most gentlemanly and obliging, and willing to make good any defects in their rifles.

G. L. W., Pasadena, Cal.

For Sale: 45-90 Winchester, good as new, also reloading tools and ammunition; reasonable. Chas. F. Wilken, 591 Broadway, New York.

FAY & BOWEN

MOTORS AND LAUNCHES

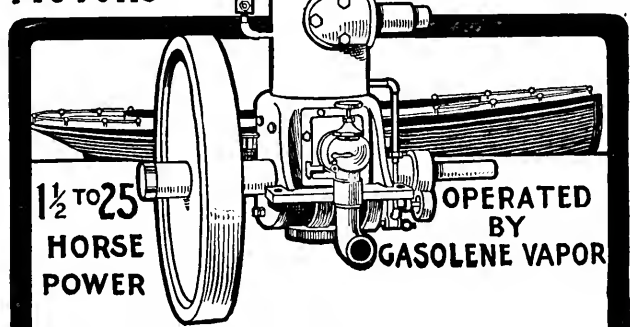

THE Fay & Bowen Marine Motor is a revelation to those who have used others. Reliable, safe, durable and easy to operate. Remarkable speed control. Best of all, it starts when you start it. No handle or crank is used. Our patented ignitor is absolutely unique and always instant and positive in action. It is really the only perfect and satisfactory ignitor.

Motors complete from 1½ to 25 H. P. ready for installation. We also build handsome launches with motors installed and ready to run.

Send for Catalogue.

Fay & Bowen,

28 Mill Street

Auburn, N. Y.

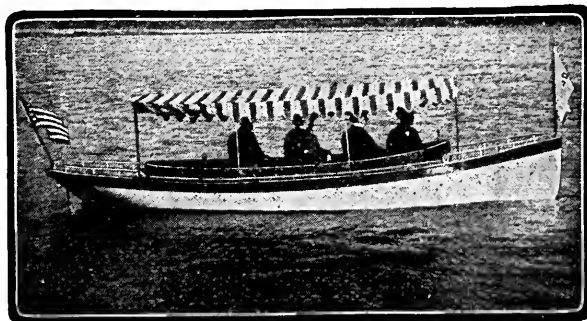

No Fire, Smoke, Heat. Absolutely Safe. Free Catalog.
TRUSCOTT BOAT MFG. CO., St. Joseph, Mich.

PALMER

Gasoline Engines and Launches

MARINE and STATIONARY ENGINES

of both two and four cycle type in stock.

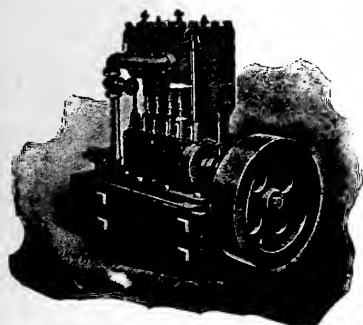

Special discount on launches ordered during winter months for Spring delivery

PALMER BROS., - Cos Cob, Conn.

WHITESTONE HOLLOW SPAR AND BOAT CO.

Successors to

The Spalding St. Lawrence Boat Co.,

Builders of { The FAMOUS St. Lawrence River Ships
Cedar Canoes
Canvas Covered Cedar Canoes
Speed Launches
YACHTS' DAVIT BOATS

Makers of

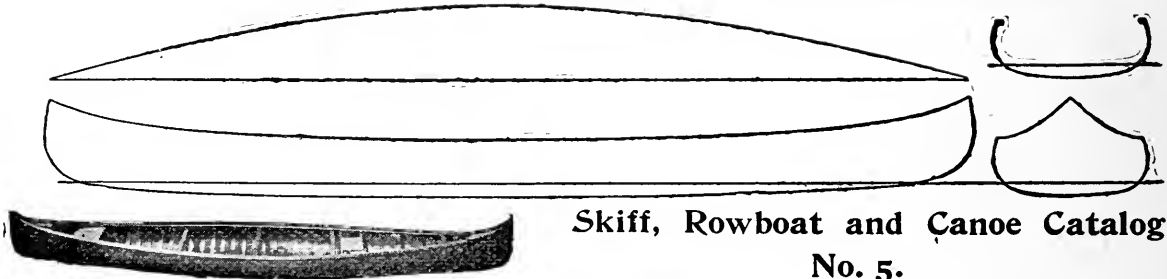
Send for Spar Book-
let No. 4.Skiff, Rowboat and Canoe Catalogue
No. 5.**WHITESTONE HOLLOW SPAR AND BOAT CO.**

J. G. FRASER, Manager

Whitestone Landing, Long Island, N. Y.

Received the rifle. Please accept my sincere thanks. It is hard for me to understand how it is possible for you to give such valuable premiums for a few subscribers. The premiums I have received from you are: a Syracuse hammerless; 3 Harrington & Richardson single guns; one watch; one special rifle.

George Burkhardt, Buffalo, N. Y.

I received the Shattuck double hammerless shot gun you sent me for 25 subscriptions to your magazine. Am well pleased with it. It is easy to get subscribers for RECREATION; in a few hours any one can earn a valuable premium.

L. L. Loomis, Lakewood, O.



U. S. Government who prefer our boats. Received medal and award at Chicago World's Fair. If you investigate we will get your order.

Send for catalogue of our full line of Folding Canvas Boats and Canoes, which have been adopted by Governments of United States, Canada and England. Just filled an order for

Mention RECREATION.

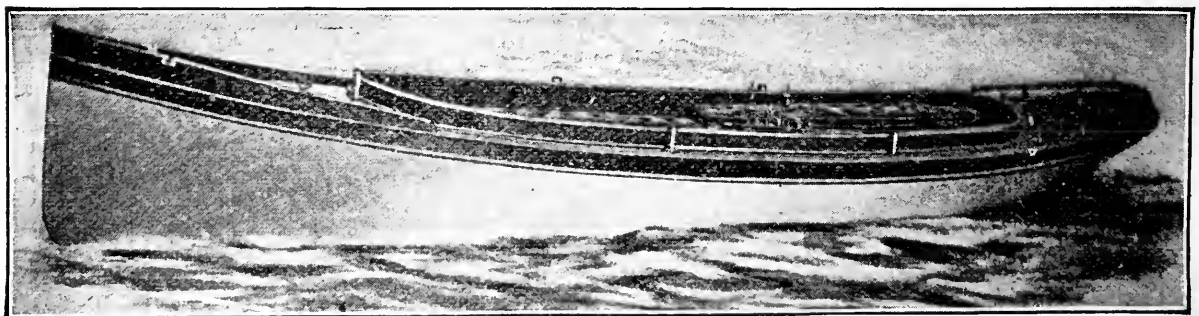
Acme Folding Boat Company, Miamisburg, O.**LEAMAN BOAT COMPANY**
WINNECONNE, WIS.

Manufacturers of Gasoline Launches, Sail, Row, and Hunting Boats. Our prices are low, our work guaranteed. Launches, \$150 up. Row Boats, \$22 up. Hunting Skiffs, \$20 up. The oldest Boat Company in the State. Write for Wants. Mention RECREATION.

EVERY SPORTSMAN and lover of boating recognizes the need of a well modeled and reliable boat which can be collapsed for convenience in carrying and storage. Several makes are on the market, but none which in any particular equals the **KING**.

A King Folding Canvas Boat

IS MADE TO GIVE YEARS OF HARD SERVICE

IS BUILT ENTIRELY BY HAND LABOR. Carefully framed and modeled by HAND, NOT BY MACHINERY. Its indestructible steel frame is made to stand salt water by heavy galvanizing. NO BAGGING between the ribs is possible owing to the automatic tension of the Spring Steel Frame of 12 longitudinal and 13 diagonal ribs. This ribbing is covered by U. S. patents. Makes the

SMALLEST AND NEATEST PACKAGE OF ANY FOLDING BOAT



11-foot Special

With Air Chambers

They Float 100 Pounds!

Bottom Boards

Rest on the Frame

Not on the Canvas

They are Stiffer than a Wooden Boat because the lines are fuller, and are much easier to row or paddle.

Send 6c. for Catalogue No. 7
60 illustrations and 250 testimonials

King Folding Canvas Boat Co.
Kalamazoo, Mich., U. S. A.

I recently bought a 30-40 Winchester, and it certainly is a great killer. I find much amusement in testing its marvelous penetration by shooting at $\frac{1}{2}$ -inch boiler plate cut to represent a grizzly bear. Large bones also furnish excellent and instructive targets. A soft nose bullet generally knocks them to flinders. Sometimes, too, I am fortunate enough to secure a dead horse for a mark. No other target better illustrates the fearful killing power of the 30-40. A soft point bullet leaves a scarcely perceptible mark at the entrance, but at the point of exit the orifice really reminds one of a woodchuck's excavation. It is diverting to hear the big bore cranks defend their old fashioned guns. Come, Brethren, be honest. Which is the most killing weapon: a gun like the 30-40, which will shoot through the shank of a 90-pound steel rail, or a 45-70, which will barely bulge it; a gun which will whip a bullet through a 6-foot oak, or one which shows a penetration little better than one foot in soft pine?

H. R. von Lommel, Pleasantville, N. Y.

I have known many shooters to use smokeless powder in black powder rifles and in each case it has proved disastrous to the life of the arm. They say "The factories load such ammunition and it must be all right." They find their mistake when it is too late.

The factories do load such cartridges for rifles and revolvers, but first class sporting goods houses now tag even the best revolvers that they are not guaranteed with smokeless powder. One retail store in St. Louis can tell of 3 burst revolvers in one day in that city.

I have not known of many burst black powder rifles from using factory loaded smokeless ammunition, but I have known of swollen chambers, and rifling stripped out. A friend spoiled 2 first class black powder rifles and I spoiled the barrel of a good 22 caliber repeater by using smokeless powder. My advice based on experience is: Use only black powder in rifles where barrels are not marked to show that the manufacturer recommends them for smokeless powder.

M. M. Conlon, Traverse City, Mich.

D.M. TUTTLE CO. 10 PINE STREET CANASTOTA, N.Y. **CATALOGUE FREE.**
BREAK SPARK. GASOLINE ENGINES & LAUNCHES. JUMP SPARK.

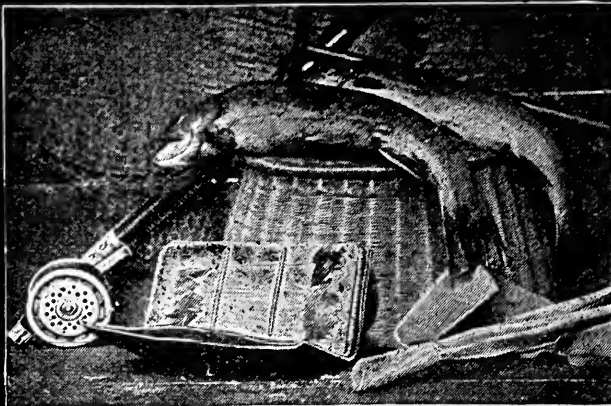

"The Automatic Reel did it."

Caught by H. H. Fraser, St. Johns, N. F.

No slack line—when fish is hooked, the little finger instantly releases spring which winds the line automatically. This continual pull prevents fish from dislodging hook from his mouth. When once hooked, he's your fish. Reel can be made free-running for casting.

Prizes

For particulars ask any sporting goods dealer, or send direct, for "Booklet X."

"Little finger does it!"

Yawman & Erbe Mfg. Co.,
ROCHESTER, N. Y.



To RECREATION Readers: I am organizing a club of subscribers for RECREATION, with a view to securing a premium, and I submit this offer; to each person sending me \$1 for yearly subscription to RECREATION, I will send a 25ct. Dominion of Canada bank note. There are but a few of these in circulation and I have succeeded in collecting a number of them. These are interesting souvenirs and are especially valuable to persons who are making collections of coins or other curios. Walter Legare, 518 John St., Quebec, Can.

FREE. To anyone subscribing to RECREATION through me I will give a cloth copy of one of Cooper's, Dickens', Dumas', Thackeray's or Conan Doyle's books. Address, J. M. RUGEN, 2108 West Lake St., Chicago, Ill.



THE FRED D. DIVINE CO.,
76 State Street,
UTICA, N. Y.

A Divine Rod

IS THE APPLE OF
AN ANGLER'S EYE

Hand-made from the toughest wood and finest bamboo; they are superior to all others. Cost a little more, perhaps, but are not so expensive as cheap rods that break with little use. A true sportsman is never quite satisfied with anything short of the best. Send for catalog.

Mention RECREATION.

The FRED D. DIVINE CO.,
76 State St., Utica, N. Y.

Do You Want a Drinking Cup Free?
Send me \$1 for a new subscription to RECREATION and I will send you either a fine nickel-plated folding drinking cup or a collapsible rubber cup. For 10 cents extra will send by registered mail. Thomas H. Walker, 295 Merrimac Street, Manchester, N. H.

FREE.

To any person sending me \$1 for one year's subscription to RECREATION, I will give free, a choice of the following:—
One dozen 5 x 7 Stanley dry plates; or one dozen 4 x 5 Seed dry plates; or one 8 x 10 bromide enlargement from your pet negative. Jay L. Robson, 64 Main St., Batavia, N. Y.

IF YOU WOULD LIVE NEXT TO
NATURE READ RECREATION.

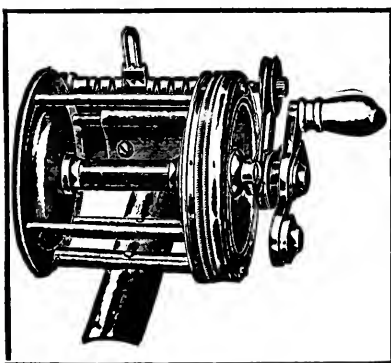

A. W. BISHOP & SON RACINE, WIS.

Patentees and Manufacturers of the latest invented and improved **Sporting Goods Specialties.** Catalogues free to all. Our **INDEPENDENT EVEN SPOOLING DEVICE** that transforms the ordinary quadruple Fishing Reel into an automatic Even Spooling Reel in five minutes is a wonderful invention, and that anglers know it to be a necessary adjunct to the Fishing Reel is evidenced by the letters pouring in from fishermen in all parts of the U.S. and Canada, the result of inserting only a small ad. twice in RECREATION.
High Grade Goods Sold Under a Guarantee. PRICES RIGHT
Write to-day for our 1903 Catalogue. Mention RECREATION.

THE "BRISTOL" STEEL FISHING ROD

The "last word"
in the art of
Rod Making

Write for Catalogue 21, FREE

THE HORTON
MANUFACTURING
COMPANY

BRISTOL, CONN., U.S.A.

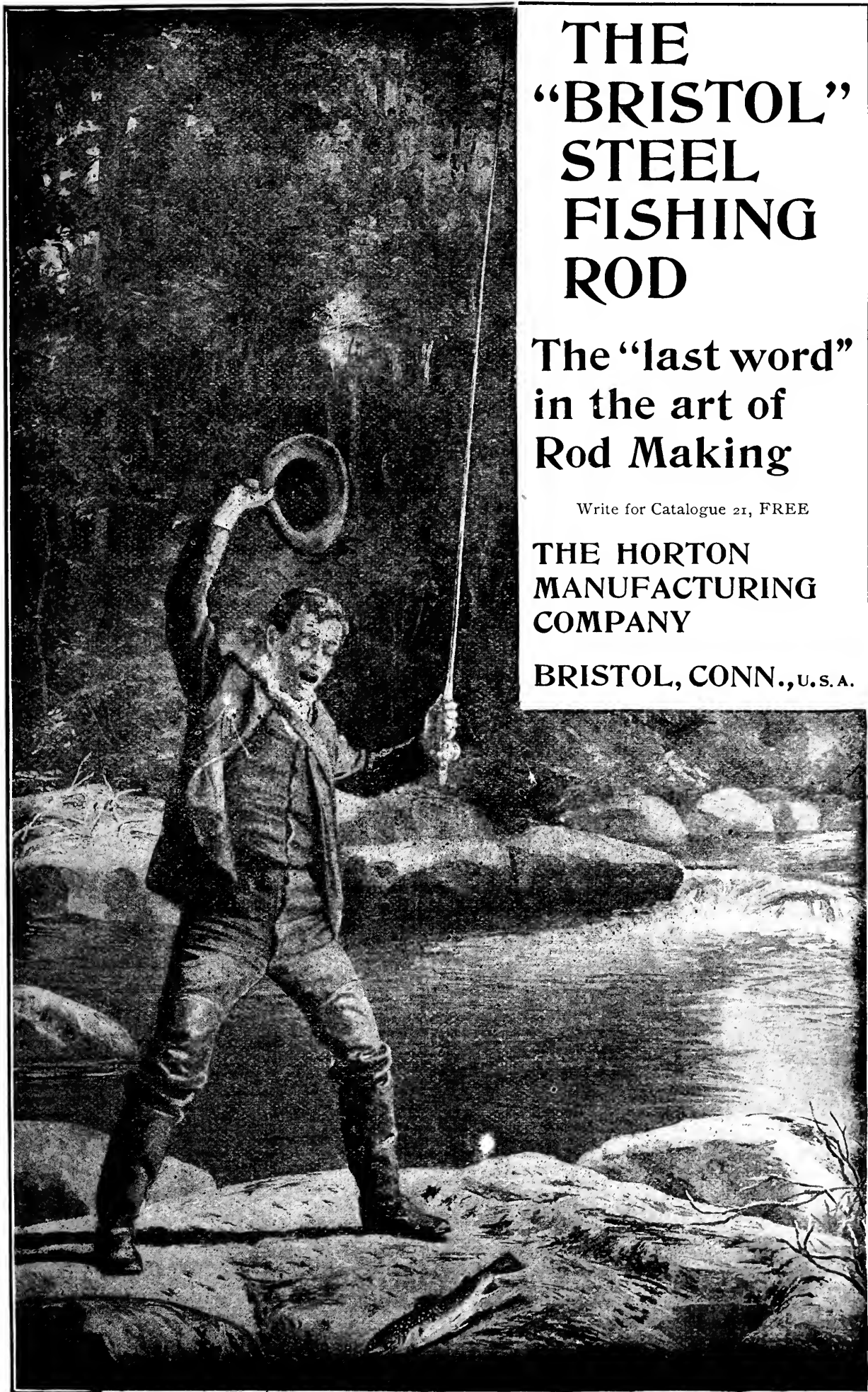

Marble's Safety Pocket Knife.

We offer something better in the way of a hunting knife. Not merely better than the old unreliable kind, but far and away the **BEST** folding hunting knife made, equal in quality to our celebrated Ideal hunting knives, and one of the latest and best of the Marble Tricks.

It has a five-inch blade which folds into a four-inch handle. When the knife is open the blade locks so firmly that no mischance can cause it to close. It is as rigid as a one-piece knife.

When it is closed it may be carried in the pocket or at the belt.

It is not a ramshackle toy but a thoroughly dependable knife, which will never fail in the hour of need.

It is hand tested and hand made from the very best steel—tempered to stand the hard knocks of field service, beautifully finished and it bears the

"MARBLE" guarantee of quality.

The price is **\$4.00**. Get one from your dealer or direct from the makers. Send for catalogue "A."

MARBLE SAFETY AXE CO.
Gladstone, Mich.

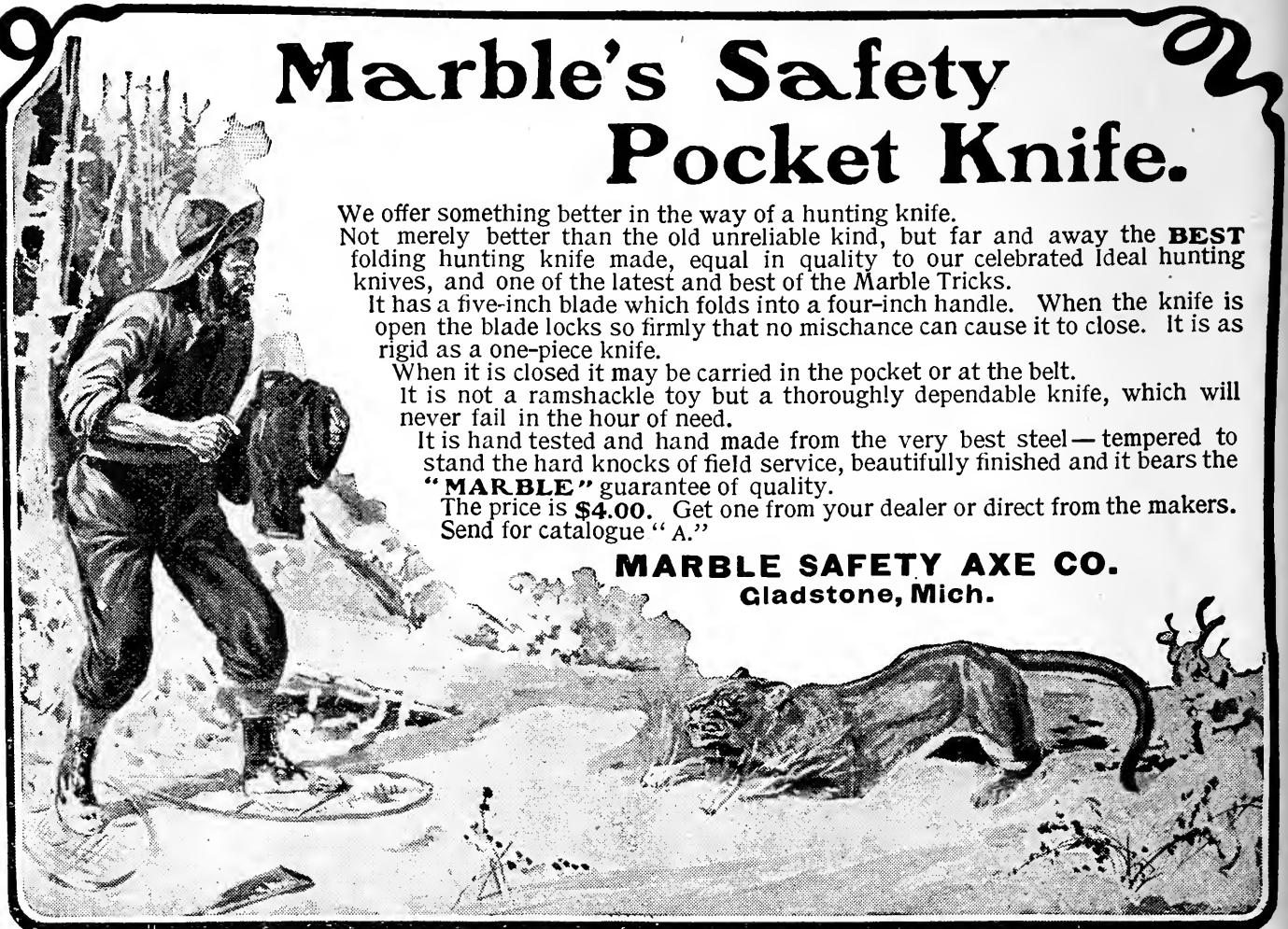

Have subscribed for your magazine during the last 2 years and would not be without it if it cost twice as much and came but once in 3 months.

F. G. Smith, San Francisco, Cal.

I received the Horton rod you sent me as a premium and am more than pleased with it.

R. E. Norway, Laconia, N. H.

I could no more afford to be without RECREATION than I could without my dinner.

H. J. Strehlau, Toledo, O.

RECREATION is the best journal in the United States.

A. L. Gutheil, Winchester, Ind.

I have taken your magazine a long time and read it with great pleasure. Go after the rooters until nothing is left but the bristles.

Wm. Henry, Jr., Shelbyville, Ill.

I have just received the Marble gaff hook as a premium for subscriptions to RECREATION and am much pleased with it. There is no better magazine than yours.

Oscar Holen, Argyle, Minn.

I received the Marble safety pocket axe you sent me. Am delighted with it. Please accept my thanks.

Chas. Seitsworth, Sturgeon, Pa.

RELICS OF A DISAPPEARING RACE

Buffalo Skulls

WITH POLISHED OR UNPOLISHED HORNS

Also polished or unpolished horns in pairs or single. Polished horns tipped with incandescent electric lights; polished hunting horns; mirrors hung in polished horns, etc. These are decided novelties and are in great demand for sportsmen's dens, offices, club-rooms, halls, tc. Send for illustrated catalog. Mention RECREATION.

E. W. STILES

141 Washington St. Hartford, Conn.





Seven Gold Medals and Five Diplomas of Honor
Bronze Medal Paris Exposition, 1900

"COLLAN OIL"

WATERPROOF
BOOT, HARNESS and
BELT DRESSING

Mention RECREATION.

Send for Circular

J. R. BUCKELEW, 111 Chambers Street
New York City

Practical Common Sense
in 6 Sizes.

CAMP STOVE

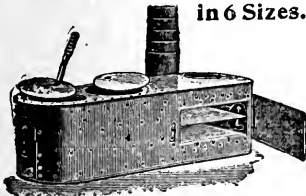

Either with or without oven. The lightest, strongest, most compact, practical stove made. Cast combination sheet steel top, smooth outside, heavy lining in fire

box and around oven, holds its shape, telescopic pipe carried inside the stove. Burns large wood and keeps fire longer than any other. Used by over 9,000 campers and only one stove returned.

For catalogue giving full particulars, mention RECREATION and address,

D. W. CREE, Manufacturer, Griggsville, Ill.

PATENTS

Quickly secured. OUR FEE DUE WHEN PATENT OBTAINED. Send model, sketch or photo. with description for free report as to patentability. 48-PAGE HAND-BOOK FREE. Contains references and full information. WRITE FOR COPY OF OUR SPECIAL OFFER. It is the most liberal proposition ever made by a patent attorney, and EVERY INVENTOR SHOULD READ IT before applying for patent. Address:

H. B. WILLSON & CO.

PATENT LAWYERS,
LoDroit Bldg., WASHINGTON, D. C.

**Brass Rod for
Cleaning Rifles**

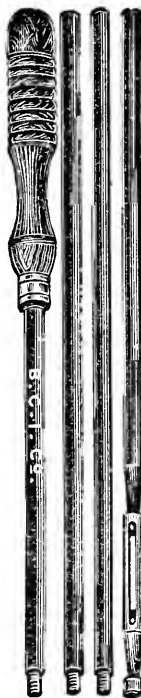

A four-jointed rod with
No. 246 bristle or No. 246
B brass wire brush . . .

MADE with revolving
snake wood handle
which allows the rod to turn
in the barrel and follow the
grooving without unscrewing.
Packed complete in bag. Cat-
alog price \$1.00 each.

*Send for complete Catalog
describing shot gun and
rifle implements*

The Bridgeport Gun Implement Co.,
313-317 Broadway, New York.



**INDIAN
CURIOS**

WHOLESALE & RETAIL
CURIO DEALERS'
SUPPLY DEPOT.

Bead Work, Baskets, Elk Teeth, Mexican
Goods, Fossils, Minerals, Arrow-Heads,
Pottery, Alaska Ivories, Shells, Agates,
Photos, Great stock, Big Catalogs, stamps.
Mention RECREATION. If a dealer, say so.

L. W. STILWELL
DEADWOOD SO. DAKOTA



IF YOU WOULD LIVE NEXT TO
NATURE, READ RECREATION.

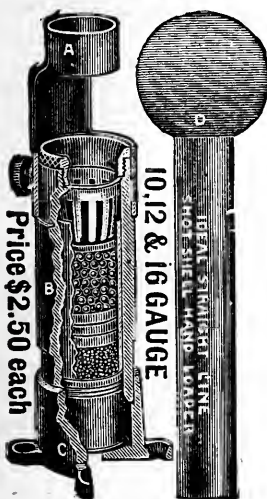

Price \$2.50 each

There is **ECONOMY** and **PLEASURE**

in *Loading and Re-Loading* your own
Shot Gun Shells if you have the proper
implements. There is an entire line of

NEW TOOLS UP TO DATE

for this purpose *Now Ready*. Full descrip-
tion and prices of all will be found in our new
booklet entitled "*Hints on Loading and
Reloading Shot Gun Shells*," which will
be sent to any address upon application to
IDEAL MANUF'G CO., 12 U St., New Haven, Conn., U. S. A.

THE PHIL. B. BEKEART CO., of San Francisco, Cal., Agents for Pacific Coast.

When you write please mention Recreation.



THERE are many pleasant days in Winter when one feels like shooting targets, but the gun club grounds are closed for the season. Every trap shooter should provide for these occasions by owning a J. C. Hand Trap. Does all the work of the ground trap and more. *Throws any target at any angle.* Weighs but six pounds and can be carried anywhere. Dealers write. Sent by prepaid express on receipt of price, \$4.00.

I took to Scotland the 5 x 7 Wizard I got from you over a year ago when I was at Rumford Falls. It was so much admired by my brothers that I left it with them, although I hated to part with it.

R. D. Wilson, Andover, Mass.

The Weno Hawk-Eye camera you sent me is a fine instrument. Accept my grateful thanks for it. I am trying to get more new subscriptions.

P. J. Benson, Provo, Utah.

I sincerely hope with the vast army of other earnest sympathizers that you may live to be an 100 years older to wage your war on the game hog.

F. M. Carpenter, Port Royal, Pa.

Enclosed please find my renewal for RECREATION, which is one of the most interesting magazines that I have had the good luck to secure.

Ernest S. Yates, Johnsonburg, Pa.

The Horton rod you sent me for 5 subscriptions is the best thing in that line I have ever seen.

V. H. Sawyer, Adrian, Mich.

Had I the dollars of Andrew Carnegie I would send RECREATION all over the earth. Chas. Vitons, East Pittsburg, Pa.

Newhouse Traps

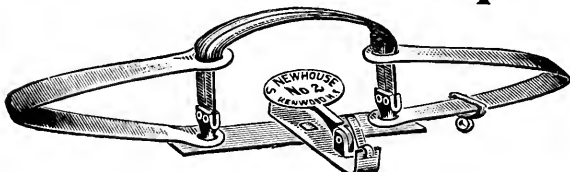

THE STANDARD FOR OVER FIFTY YEARS
Used by all professional hunters and trappers,
who find that

The Best Trap is the Cheapest
Complete illustrated catalogue on
application.

ONEIDA COMMUNITY, LTD., Kenwood, N. Y.

Do you want a Good, Reliable,
Substantial, Well Made

Single Barrel Shot Gun

If so, send me

10 YEARLY SUBSCRIPTIONS

and I will send you such a
Gun as a premium

It is made by the *DAVENPORT ARMS CO.*, and this means it is made of good material and that only good workmanship is put on it.

This is one of the many remarkable opportunities *RECREATION* is offering to men and boys to fit themselves out completely for shooting and fishing.

Sample Copies for Use in Canvassing
Furnished on Application.

Address

RECREATION

23 W. 24th St., New York City

BIG GAME !
ATTENTION SPORTSMEN !

Bears, Lions, Deer, Turkey, Antelope, Mountain Sheep, etc., are to be found in great numbers in the country contiguous to the Sierra Madre Linc, in Northern Mexico. For particulars address:

JNO. P. RAMSEY, Gen. Mgr.
Box 687, EL PASO, TEX.



B. Bernard

Buyer of Raw Furs and
Ginseng Root.

150 Bleecker St., New York.

Quotations sent on request.

THE ORIGINAL MODERN RIFLE TELESCOPE.

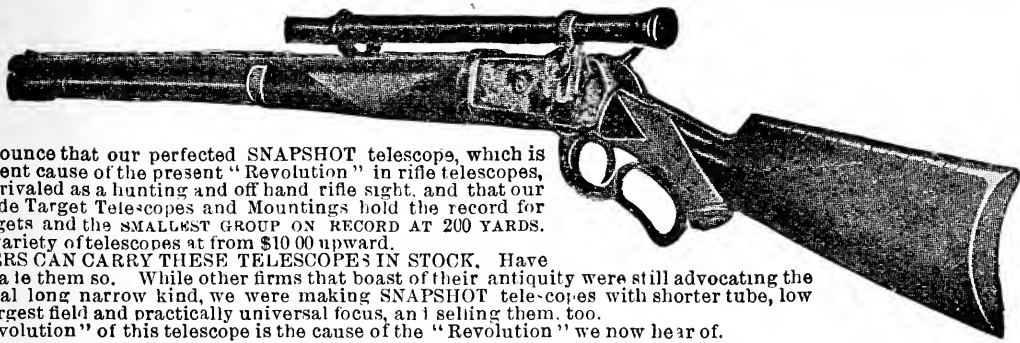

"Imitation is the sincerest flattery."

We announce that our perfected SNAPSHOT telescope, which is the innocent cause of the present "Revolution" in rifle telescopes, is still unrivaled as a hunting and off hand rifle sight, and that our High Grade Target Telescopes and Mountings hold the record for finest targets and the SMALLEST GROUP ON RECORD AT 200 YARDS. A great variety of telescopes at from \$10.00 upward.

DEALERS CAN CARRY THESE TELESCOPES IN STOCK. Have always made them so. While other firms that boast of their antiquity were still advocating the impractical long narrow kind, we were making SNAPSHOT telescopes with shorter tube, low power, largest field and practically universal focus, and selling them, too.

The "Evolution" of this telescope is the cause of the "Revolution" we now hear of.

Send for our List and Sheet on mounting up the telescope, adjustments of the same, etc.

JOHN W. SIDLE, 628 Race Street, Philadelphia Pa.
Mention RECREATION.

A Hunting Knife Free. To any person sending me three yearly subscriptions to RECREATION and \$3, I will send a pocket hunting knife with handle $5\frac{1}{2}$ inches long and blade 5 inches long. Fine steel, excellent workmanship. Your name and address and your L.A.S. number if desired inserted on a plate in the handle.

Geo. W. Mains, McKeesport, Pa.

I refer by permission to the editor of RECREATION.

For Sale: 500 horses; all ages; equally divided as to sex; weight 650 to 1,000 pounds; 200 colts thrown in (no charge). Price \$7 a head. F. O. B. cars. W. H. Root, 1063 1st St., Salt Lake City, Utah.

For Sale: A \$40 Al-Vista Camera. Will accept best offer. Nehring H. P. Telephoto Lens, \$4, and Focusing Finder, \$3; both new.

Harry G. Higbee, Hyde Park, Mass.

Wanted: 16 gauge Winchester repeater take down, for double 16 or rifles.

David S. Wegg, Jr., 293 Ontario St., Chicago, Ill.

Wanted: Small gasoline launch and Mullin's duck boat.

G. R. Dayton, Cedar Falls, Iowa.

For Sale: 2,300 acres of mountain and forest land in Wayne Co., Pa., 4 miles from Erie Railway station. Beautiful lake 2 miles long, well stocked with fish. Deer, grouse, squirrels and rabbits on and about this tract. J. S. Ames, Hawley, Pa.

Mention RECREATION.

For Sale or Exchange: One new, never used, No. 2, Recreation pneumatic camp mattress; cost \$23. Want 12 gauge double hammerless gun, duck-boat, small wall tent, S. & W. revolver, or best cash offer.

Chas. E. Arnold, Box 543, Lewisburg, Pa.

For Sale: Large size Regina music box, 27 in. plates; no reasonable offer refused. Or would exchange for sporting goods; 17 plates, with box. J. J. Seinroth, 11-15 Main St., Hartford, Conn.

For Sale or Exchange: \$42 Ballard rifle and complete reloading outfit; caliber 32-40; price \$25. Or will trade for a No. 1 shot gun. Rifle is practically as good as new. Edward C. Suffern, Atwood, Ill.

For Sale: A grandfather's clock, 90 to 100 years old, 8 feet tall; in good running order; wood movement; a perfect timepiece. Will take \$40 for it.

P. Breckenridge, Ashtabula, Ohio.

MAGNISCOPE RIFLE SIGHT CO.



\$4.00

A Magnifying sight used with any Peep Sight. Fits in rear barrel slot. Folds down and allows use of Peep Sight. Has all the advantages of a telescope. No tube. Not a single objectionable feature. Complete.

\$4

TUBELESS TELESCOPE
FITS IN REAR BARREL SLOT

Write for Folder. Mention Recreation.

YORK, NEBR.

IF YOU WISH THE BEST RESULTS

**SHOOTING DUCKS
OR IN THE FIELD**

**USE SHELLS LOADED WITH
NEW GREEN WALSRODE**

Schoverling, Daly & Gales

302-304 Broadway, - - - New York

Fins and Feathers

are plentiful along the line of the



St. Louis and San Francisco R. R. Co.

Kansas City, Memphis and Birmingham R. R.

SHORT LINE TO

**MISSOURI, KANSAS, ARKANSAS,
INDIAN AND OKLAHOMA TERRITORIES**

Texas and Mexico

VIA ST. LOUIS, KANSAS CITY, MO.,
OR MEMPHIS

Write for illustrated literature of interest to real sportsmen.

Vestibuled Pullman Buffet Sleeper, through without change between New York and Memphis, Tenn., via Washington, D. C., Atlanta, Ga., and Birmingham, Ala., in connection with Pennsylvania R. R. and Southern Ry.

F. D. RUSSELL
General Eastern Agent
385 B'way, New York

A. HILTON
General Passenger Agent
St. Louis, Mo.

I should not know what to do without RECREATION. It seems to go everywhere, and I get answers to my advertisement from the most unheard of places.

John W. Sidle, Philadelphia, Pa.

I am in receipt of Marble hunting knife. It is the handsomest knife I have ever seen and I thank you sincerely for it.

A. N. Wirls, Cleveland, O.

I received the Bristol steel fishing rod promptly and am greatly pleased with it. It is a daisy.

H. L. Krauth, Hamilton, O.

I received my Al Vista camera as a premium for 12 subscribers. It works satisfactorily in every way and I thank you for it.

J. Schauli, Woodhaven, N. Y.

Everybody swears by RECREATION. Long may she wave! B. F. Rawdon, Windsor, Ohio.

RECREATION is one of the best monthlies published.

E. N. Coon, De Ruyter, N.

**IF YOU WOULD LIVE NEXT TO
NATURE, READ RECREATION.**

A YEAR OF RECORDS

WITH

Du Pont Smokeless

During 1902, Fred. Gilbert, using Du Pont Smokeless, WON more first averages than any other shooter in the United States.

E. I. DU PONT DE NEMOURS & CO.
WILMINGTON, DEL.

I have used several makes of guns, and for fine shooting prefer the Remington. I now have 2 arms of that make. One is a double barrel, 12 gauge, 8¼ pounds, shot gun that seems specially built for No. 4 shot. A harder, closer shooting weapon has yet to be placed in my hands. Last fall I shot a fox at 4 rods with a U. M. C. shell, 3 drams Dupont's smokeless and 1½ ounces No. 4's; putting 81 pellets within a 4-inch circle, all but 3 passing entirely through the animal. This is one of many such shots. The second gun is a Remington No. 4, .22 caliber. For game or target it is a top notcher. With it I killed 5 woodchucks in an hour at 10 to 75 yards, using Winchester .22 long shells. People who think the .22 long is a popgun are mightily mistaken.

Warren W. Coombs, Antrim, N. H.

SPECIAL FREE OFFER

To any person sending me \$1.00 for one year's subscription to RECREATION I will give free a choice of the following: 50 fine Bristol Cards printed to copy in Gold Ink; or 50 Envelopes printed with return card and a cut representing an angler. With the words "If you don't catch him in 10 Days return to ;" or 50 Note-heads neatly printed. Write plainly to avoid mistake in printing. Samples of printing for stamp. Or I will give free a Bottle of Silver Plating Fluid for plating all kinds of metal surfaces; or a Bottle of White Rose Cream for the complexion. Either new or old subscribers may take hold of this offer. Send money by registered letter. Address

HENRY NELSON, ECKVOLL, MINN.

YES

There *are* other railroads between the east and the west.

BUT

it is always well to secure the *best* you can for the money.

THEREFORE

You should bear in mind this remark of an experienced traveler:

"For the excellence of its tracks, the speed of its trains, the safety and comfort of its patrons, the loveliness and variety of its scenery, the number and importance of its cities, and the uniformly correct character of its service, the New York Central & Hudson River Railroad is not surpassed by any similar institution on either side of the Atlantic."

Send to George H. Daniels, General Passenger Agent, Grand Central Station, New York, a 2-cent stamp for a 52-page illustrated Catalogue of the "Four-Track Series."



PERFECTION AT LAST!

To the "OLD RELIABLE"

has fallen the honor of making the FIRST and ONLY PERFECT score which has ever been made in an all day tournament.

At Spirit Lake, Ia., Aug. 6th, 1902

Events 15 15 20 15 15 20 15 15 20 15 15 20—200

Score 15 15 20 15 15 20 15 15 20 15 15 20—200

The above score was made by

MR. FRED GILBERT WITH A PARKER GUN

Send for Catalogue

PARKER BROS., Meriden, Conn.

NEW YORK SALESROOM: NO. 32 WARREN ST.

Mention RECREATION.

FOR WOODCHUCK HUNTERS.

I am a lover of the rifle, seldom using a shot gun. My ideal sport is hunting that cute combination of cunning and curiosity, the too little appreciated woodchuck. Undoubtedly there is enjoyment in a chase after deer or other big game; but if there is more satisfaction to be experienced than results from picking a chuck up by the tail after a successful shot then I have missed a whole lot.

At present I am shooting a single shot, chambered for the latest caliber, the 28-30-120. It is an all right little arm, killing like lightning when one puts the shot in the right place, which in a chuck is the head or neck. The only fault I have to find is that the shell is too long to suit me. I use semi smokeless powder, and think it perfection. The 28-30 shell will hold 32 grains of powder and a wad if desired, provided the shell is well tapped. I never compress semi smokeless. Using the 120 grain bullet, this gives a powerful and exceedingly

accurate load, comparing in the latter respect to the 32-40. I have hit woodchucks at 60 yards with this load, and rolled them over and over. However, I do not always pick them up, for unless dropped dead in his tracks this bundle of vitality usually manages to reach home. I think the hollow point bullet for the 28 should produce good results. I am not an advocate of small bore rifles using black powder for woodchuck hunting. Some claim all they want is a 22 long rifle cartridge in a good rifle for this kind of game, but it would not suit me. A woodchuck requires a load of great shocking power, one that will stop him even if not hit in the neck. No 22 will do this; my 28 will not do it. Let us hear from some of the boys who have hunted this wily little scamp, and are prepared to say just what is needed for him in the line of calibers. I am strongly inclined toward the 38-55 just now. One must needs take a long shot occasionally, and anything smaller than a 32 is likely to permit a retreat of the enemy at anything over 100 yards. I am anxious to hear what users of the 32 Ideal cartridge have to say regarding it. Has anyone ever tried it on woodchucks?

J. F. Roberts, Cassville, N. Y.

OUR NEW
SINGLE TRIGGER
Patented 1902. Others pending.

Field Guns as Light as
5¼ lbs.

Send stamp
for 1903
Catalogue
describing
our goods.

D. M. LEFEVER, SONS & CO.
Manufacturers of the "New Lefever"
SYRACUSE, N. Y.

Not connected with Lefever Arms Co.

TRAP GUNS
a specialty

Our Cleaner
by mail, 45c.

SAVAGE**TARGET SHOOTERS
AND HUNTERS**

of large and small game will be interested in the new line of

**Savage Hammerless
Repeating Rifles for 1903**

This extended line of calibers will meet the demand of those desiring the 25-35, 32-40 and 38-55 in a magazine rifle of the very latest and most modern type.

**The 1903 Model 22 Caliber
Savage**

is a Hammerless repeater containing features well worth your investigation. Our latest catalogue (G) is in the press and will be ready for distribution soon.

Write and get your name on the mailing list.

**Savage Arms
Company**

UTICA, N. Y., U.S.A.
Baker & Hamilton, San
Francisco and Sacramento,
Cal., Pacific Coast Agents.

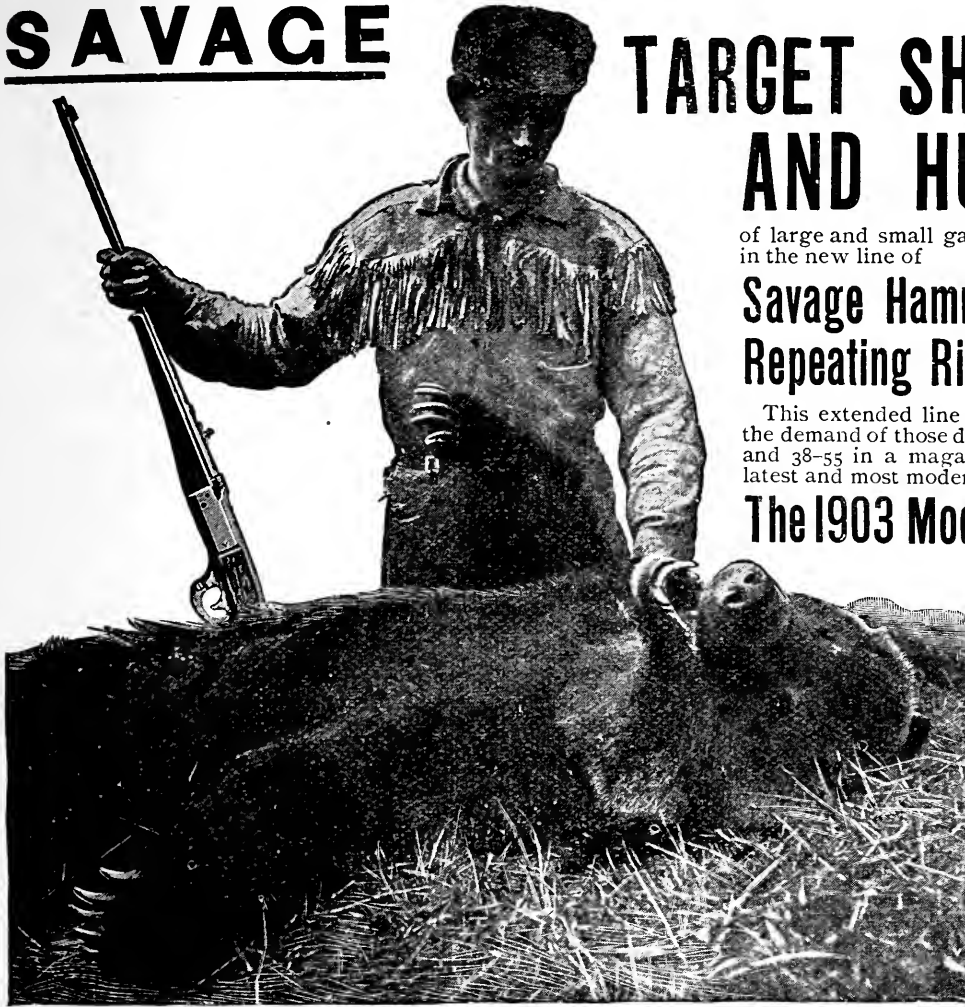

The Horton rod you sent me arrived promptly and in good condition. The Horton Mfg. Co. deserves great credit for the way it sends out goods. No use praising the rod; could not do it half justice. Like RECREATION, it is all to the good.

R. F. Draper, West Chester, Pa.

I received the Guthrie hunting boots yesterday and am delighted with them. They fit like a glove and are entirely satisfactory in every particular. I am well repaid for the little trouble I had in getting the required subscriptions.

E. W. Stevenson, Westerly, R. I.

I received the Forehand revolver. It is more than I expected for so little work. It was just like finding it and I was really surprised when I saw what a handsome premium I had. It is a formidable weapon and a good shooter. I shall always get subscribers when I have the time to spare. I thank you for such a valuable premium and the prompt attention you gave my letter.

L. B. Brooks, Martinsburg, W. Va.

The Marble hunting knife you gave me as a premium is a first class article.

H. Georgii, Cheboygan, Mich.

THE
DAVENPORT
1903 MODELS

Embody all the
Latest Improvements
in Modern Single Gun
Construction.

They are the
Standard of
Excellency.

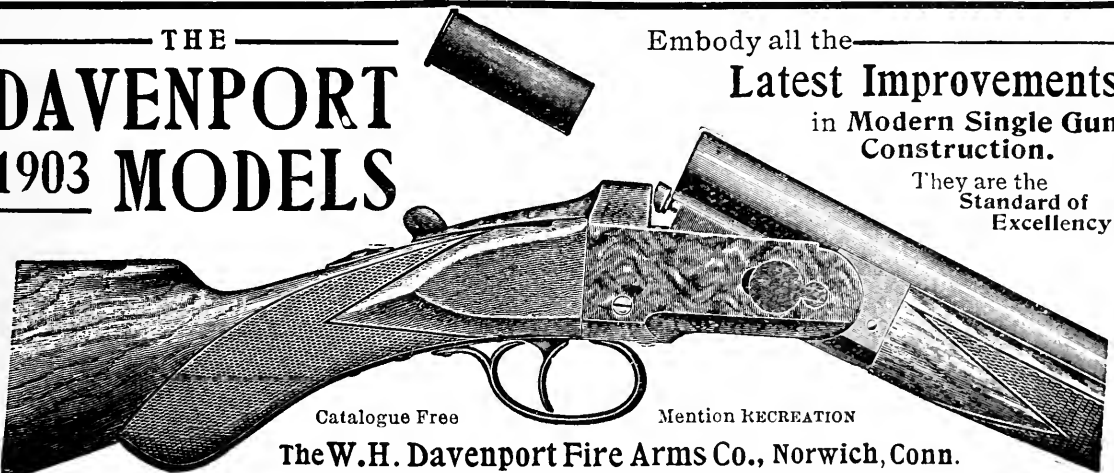

Catalogue Free

Mention RECREATION

The W. H. Davenport Fire Arms Co., Norwich, Conn.

STILL ANOTHER GREAT OFFER

Send me 25 yearly subscriptions to
RECREATION and I will send you

A Grade O Syracuse Gun

Listed at \$30.

I have contracted for 20 of these
guns at a price which enables me to
offer them as above, and they will
doubtless all be taken within the next
three months.

If you want one of the Guns get a move on you

Sample copies of RECREATION for
use in canvassing furnished on application

RECREATION, 23 W. 24th Street, New York

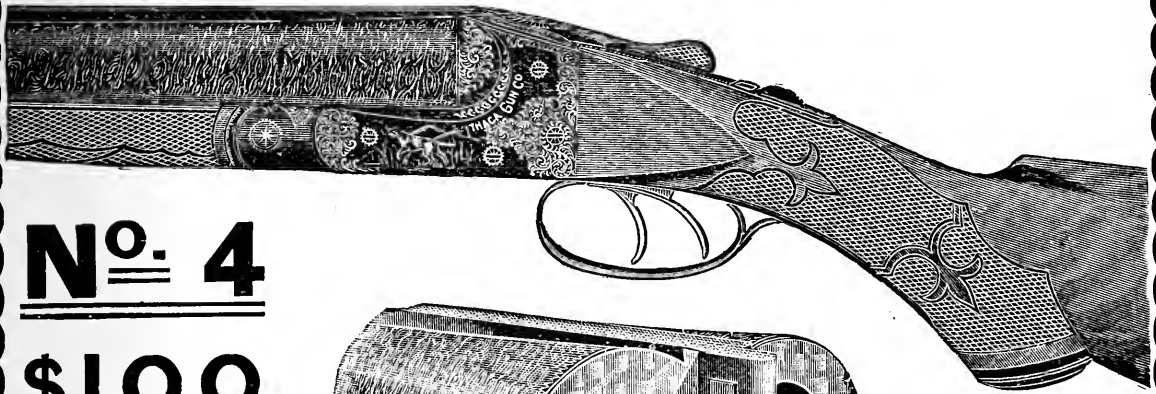

No. 4

\$100

LIST

ITHACA

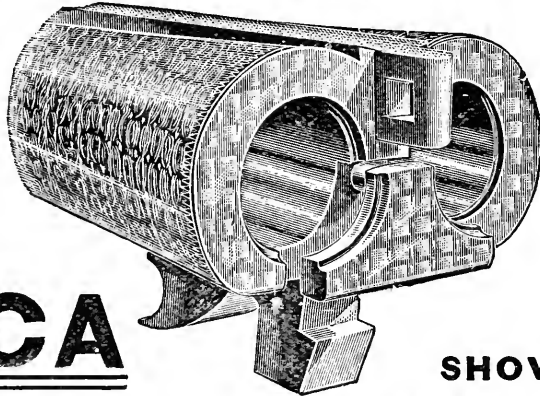

**THE
NITRO
BREECH**

**SHOWING NEW
CROSS BOLT**

**GUARANTEED to be worth \$25.00
more than any other make
of Gun at Same Cost.**

**Send for Catalogue Describing Sixteen
Different Grades of Guns, Ranging in
Price from \$19.50 to \$300.**

ITHACA GUN CO., Ithaca, N. Y.

Mention RECREATION.

H. & R. SINGLE SHOT GUN

Automatic and Non-Ejecting

The cheapest absolutely safe gun, with improvements found heretofore only in the highest priced.

**PERFECT IN MODEL
AND CONSTRUCTION**

**SIMPLEST "TAKE
DOWN" GUN MADE**

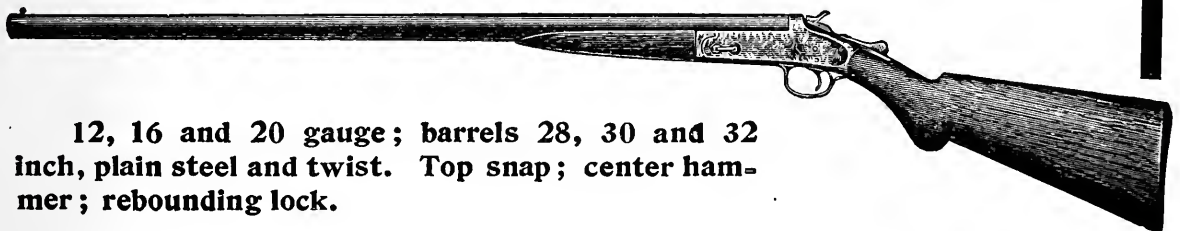

**12, 16 and 20 gauge; barrels 28, 30 and 32
inch, plain steel and twist. Top snap; center ham-
mer; rebounding lock.**

Your dealer can supply, or we will
sell to you direct. Write for Catalog.

HARRINGTON & RICHARDSON ARMS CO.

Dept. R, WORCESTER, MASS.

Makers of H. & R. Revolvers

Do You Want a Gun?

Send me 30 yearly subscriptions to
RECREATION and I will send you a

No. 1 Double Barrel Breech Loading Gun

**Made by the Ithaca Gun Co.
and Listed at \$40**

I have contracted for 20 of these
guns at a price which enables me to
offer them as above, and they will
doubtless all be taken within the next
3 months.

If You Want One Get Busy at Once

Sample copies of RECREATION for
use in canvassing furnished on application

RECREATION, 23 West 24th St., New York.

"HOPKINS & ALLEN" Single Barrel Shot Guns

(Made for any powder and good with any shot.)

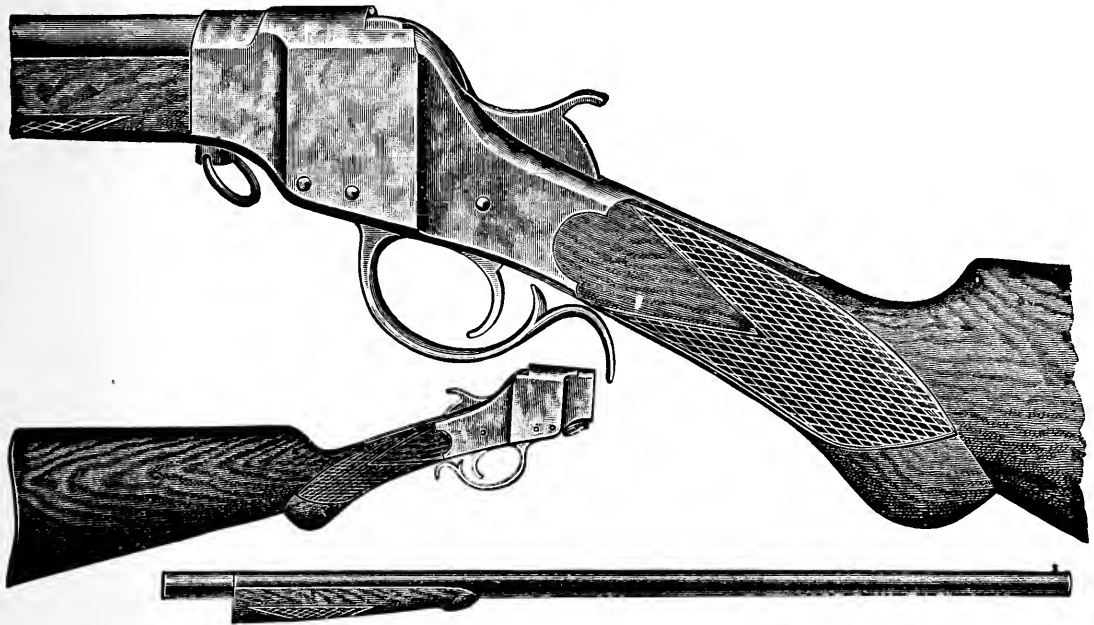

Our "Lever Action" has more friends than any single gun made, has stood the test of fifteen years' continued approval. Simple, durable and reliable.
12 and 16 gauge blued steel barrel..... **\$8.00**

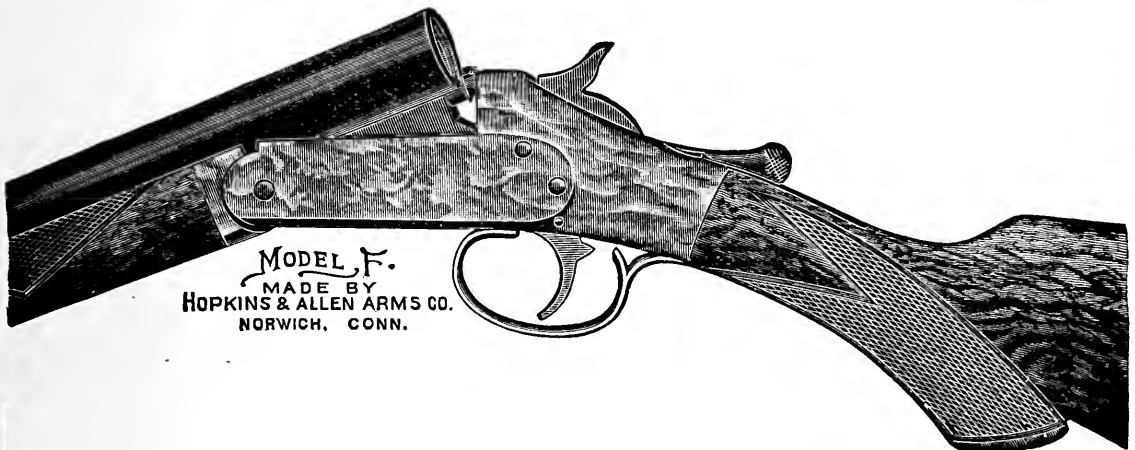

Our new model top snap action, combining all up-to-date features of a modern gun, including patent compensating snap fore end. Automatic shell ejector, **Full Choke Bored**, 12, 16 and 20 gauge decarbonized steel barrel..... **\$9.00**
12 and 16 gauge Stubbs twist steel barrel..... **\$10.00**

We will ship, all charges prepaid, on receipt of remittance with order, to any express office in U. S. A.

The Hopkins & Allen Arms Co.,
NORWICH, CONN., U. S. A.

Going Fishing?

Well fixed for rods? If not, send me 10 yearly subscriptions to RECREATION and get a Bristol Steel Rod—any one listing at \$6.00 or less.

Everybody knows what a Bristol Steel Rod is. It is equal in strength, durability, suppleness, and all the other good qualities to a split bamboo rod costing \$20.

This is a great opportunity and holds good only SIXTY days.

Sample copies of Recreation for use in canvassing furnished on application.

Guaranteed Not to Shoot LooseOne of the 9**“SYRACUSE”****Built for Business**

DAMASCUS BARRELS

AUTOMATIC EJECTOR

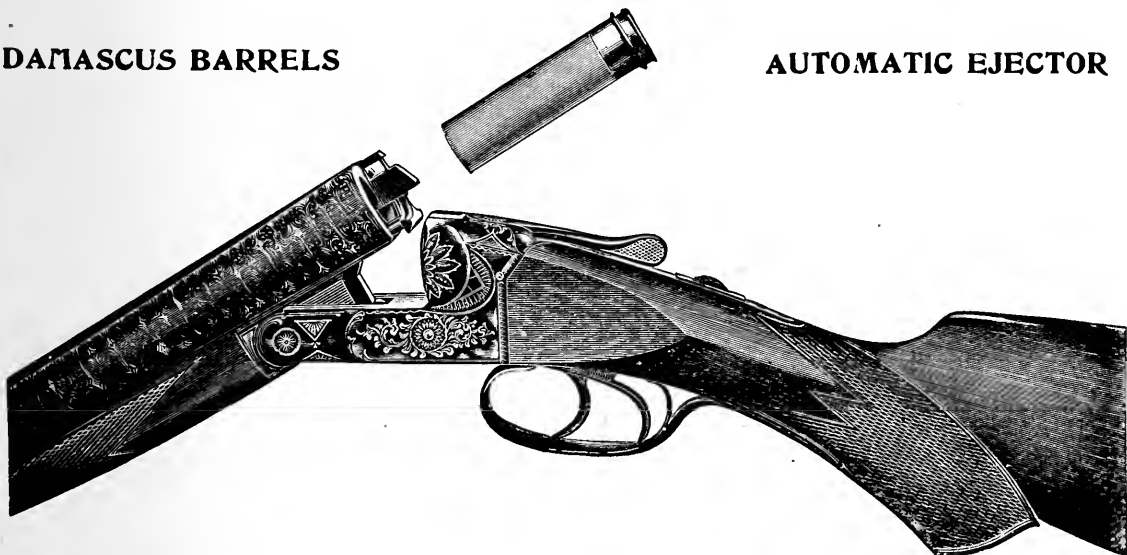
GRADE 3 EJECTOR**\$60 LIST**

In presenting this gun to your notice, we feel that it is the best value for the money that has ever been offered.

Excellent Damascus barrels, carefully selected, and bored by the particular method that has gained for the "Syracuse" the reputation of being the Hardest Hitting gun made. Stocked with Imported Walnut, Full Pistol Grip, handsomely checkered.

Engraving is hand cut, and gives that finishing touch that proclaims quality.

MADE IN 20, 16 OR 12 GAUGE

SYRACUSE ARMS CO. SYRACUSE, N.Y.*Art Catalogue yours for the asking. Mention "Recreation."*

FINE GUNS

OUR SPECIALTY

SCOTT'S MONTE CARLO

Automatic Ejector Hammerless,

Established
1826

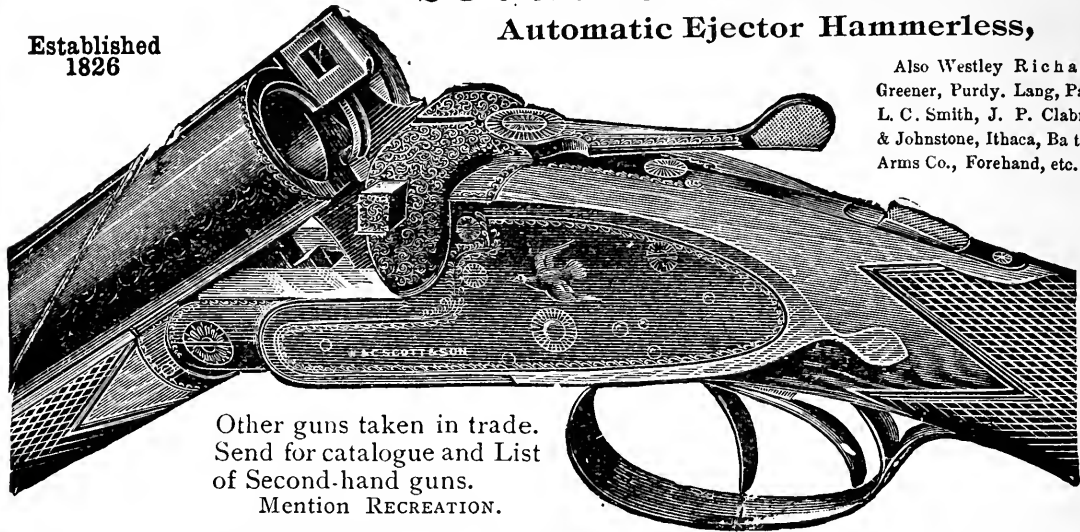

Other guns taken in trade.
Send for catalogue and List
of Second-hand guns.
Mention RECREATION.

All the Prominent
English and
American Makes.

Also Westley Richards,
Greener, Purdy, Lang, Parker,
L. C. Smith, J. P. Clabrough
& Johnstone, Ithaca, Baltimore
Arms Co., Forehand, etc.

SWEDISH LEATHER JACKETS

For Duck Shooting.

Soft as Kid.

Finest Quality, \$18.00

We take the entire product of the manufacturers of above Finest Jackets and this make cannot be obtained elsewhere in the United States

Gun Repairing

BY FIRST-CLASS GUN REPAIRERS
RESTOCKING, BROWNING, Etc., Etc.

Send for Catalogues

WM. READ & SONS,

107 Washington Street, BOSTON, MASS.

The Old Gun House. Established 1826

NEW MEXICAN MEMORIES.

New Mexico, with its game, its healthful climate and its sublime mountain scenery, seems to have been overlooked by writer-sportsmen. Last year it fell to my lot to hunt in that Territory, which is to-day more Spanish than American. There were 5 of us in the Bland mining camp with a few days of idle time on our hands, and we concluded that hunting would be the most enjoyable way to spend the time. The middle of the following afternoon found us on our way to Peralto canyon. We had our outfit packed on 4 lazy burros, which kept us so busy persuading them to keep the trail that we had no time to enjoy the scenery. Night was falling as we made camp among the firs and pines far up the winding canyon. We met a Mexican just before we made camp, who told us a flock of turkeys had crossed above there late that afternoon and we knew they could not have gone far before roosting.

By the morning's first gray the camp was astir. The boys did not take time to eat breakfast, as they wanted to find the turkeys before they left the roost. By lot it fell to me to stay and watch camp. They found the flock without difficulty. John scored 4 young turkeys and the boys were soon back, clamoring for breakfast.

After breakfast we moved camp a mile or 2 farther up the valley to a spring of sparkling, icy water. We were in the middle of what was generally a good game

country; but during the summer a large herd of sheep and cattle had been pastured in that section, and most of the game had been run out. When the boys came in that night all they brought was one little grouse.

The next day we moved across the mountains into another canyon, a few miles farther North, where the prospects for game seemed better. Up to that time nothing save turkey and small game had been seen. After camp had been pitched and dinner was over we started out with a firm resolve to kill something. We had gone but a short way from camp when I heard one of the boys shoot 3 times and then call to Shorty, who stayed at camp, to come and bring a burro. All of us were near him when he began to shoot and all stood in readiness, each expecting to see a deer rush past or rather make the attempt. After everything had again become quiet we went over to hold an inquest. Again John was the lucky man. This time he had brought down a fine buck. Shorty and I were deputized to take the deer to camp and do the butchering act, while the rest of the boys took up the hunt where they had left off. The sun was dropping among the pines when we finished the task allotted us. The returning hunters were greeted with that sweetest of perfumes, the odor of frying venison.

We hunted a day or 2 longer without much success and then took the narrow and tortuous trail that led to Bland.

J. W. McGee, Enfala, I. T.



Just Try To Get Well

Find out what I know.
Learn why my offer is possible
Write me a postal—that's all.

Then I will mail you an order—good at any drug store—for six bottles Dr. Shoop's Restorative, You may take it a month on trial. If it succeeds, the cost is \$5.50. If it fails, *I will pay the druggist myself*, and your mere word shall decide it.

Note What That Means

No matter about your prejudice and doubts. They are natural—but put them aside for once.

Look at it this way:—If my treatment succeeds, you are well. If it fails, it is free. Your whole risk is the postal you write.

And consider this:—You see this offer everywhere, and thousands every week accept it. Don't you realize that I must be curing these thousands, else the offer would ruin me?

And can't you believe—in view of the faith I show—that my vast experience may have solved a way to cure you?

Don't be too hesitating when your health is at stake. Just try for a month to get well. Then, if you are still doubtful, let your druggist send the bill to me.

My Method is This:

My Restorative strengthens the *inside* nerves. It is my discovery—the result of my lifetime's work.

Instead of doctoring the weak organ, I bring back the nerve power which alone makes each vital organ act. I give it the strength to do its duty, just as I would give a weak engine more steam.

I nearly always succeed. My records show that 39 out of each 40 who get my Restorative on trial, pay for it gladly, because they are cured. The best of other treatments cannot cure one chronic case in ten.

My book will tell you why.

Simply state which book you want, and address Dr. Shoop, Box 214, Racine, Wis.	Book No. 1 on Dyspepsia.
	Book No. 2 on the Heart.
	Book No. 3 on the Kidneys.
	Book No. 4 for Women.
	Book No. 5 for Men (sealed). Book No. 6 on Rheumatism.

Mild cases, not chronic, are often cured by one or two bottles. At all druggists.

FOR THE HEADS OF ALL NATIONS



THEO. ROOSEVELT
PRESIDENT OF U.S.



EDWARD VII
KING OF ENGLAND



WILLIAM II
EMPEROR OF GERMANY



NICOLAS II
CZAR OF RUSSIA



ALFONSO XIII
KING OF SPAIN

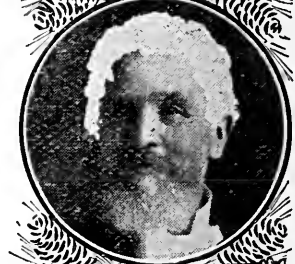

EMILE LOUBET
PRESIDENT OF FRANCE



MUZAFFAR-ED-DIN
SHAH OF PERSIA

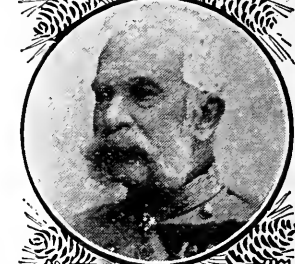

FRANZ JOSEF I
EMPEROR OF AUSTRIA



ABDUL-HAMID II
SULTAN OF TURKEY

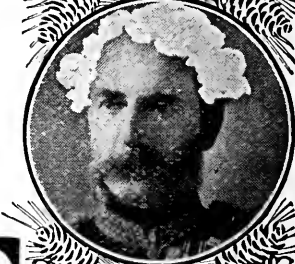

CHRISTIAN IX
KING OF DENMARK



VICTOR EMANUEL
KING OF ITALY

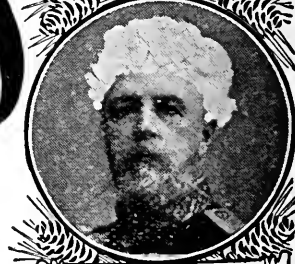

OSCAR II
KING OF NORWAY & SWEDEN

Hair Wealth and Health

The wealth of your hair depends upon the health of your hair. A healthy condition of the scalp is impossible unless you periodically cleanse it thoroughly.

FAIRBANK'S GLYCERINE TAR Soap is unequalled for this purpose. It makes a rich, creamy lather, thoroughly cleanses the scalp, feeds and tones the hair follicles, disperses dandruff and leaves the hair soft and glossy.

A superior article, too, for toilet and bath, as well as an excellent remedy for any disease of the skin and scalp. Its mildness combined with antiseptic and curative qualities render it the safest and most hygienic Soap for every toilet use.

If your Druggist or Grocer doesn't sell it, write us for a free sample cake.

Don't judge
of the quality
by the price—

5¢

THE N. K. FAIRBANK COMPANY, Dept. O, Chicago

CALENDAR FREE!

10 gold circles from 10 Fairbank Glycerine Tar Soap cartons, or 20c in stamps will secure the Fairy Plate Calendar for 1903. This is the handsomest and most artistic Calendar creation of the year. Besides the Calendar proper, it contains four perfect reproductions of hand-painted Vienna plates. Send to-day.

FAIRBANK'S GLYCERINE TAR SOAP

U.M.C.

Shot Shells add to the pleasure of a winter's day out of doors. New Club, Nitro Club and Arrow—they are the satisfactory kind. Specify U. M. C. ammunition.

The UNION METALLIC CARTRIDGE CO.
313 BROADWAY, NEW YORK, N. Y. BRIDGEPORT, CONN.

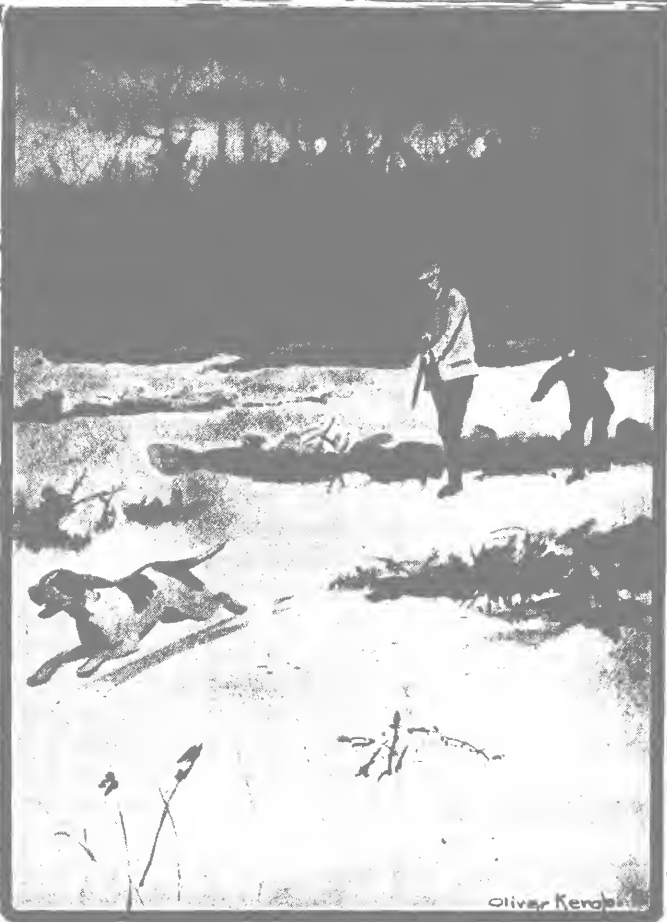

Oliver Kerola

A Remington Hammerless Gun

FOR \$25.00 GUARANTEED FOR NITRO POWDERS.



Grade K. Made with Remington blued steel barrels. \$25.00
Grade K E D. Made with Damascus barrels and Automatic Ejector, 35.00

Send for handsome new Catalogue just issued, containing complete description of Guns, \$25.00 to \$750.00. Mailed free.

REMINGTON ARMS COMPANY

ILION, N. Y.

313-317 Broadway, New York. 86-88 First St., San Francisco, Cal.

Sold by All Gun Dealers. Not Retailed by the Manufacturers.

The Great Passenger Line of America — NEW YORK CENTRAL.

WINCHESTER



REPEATING RIFLES FOR HUNTING

No matter what your ideas or preferences are about a rifle, some one of the eight different Winchester models will surely suit you. Winchester Rifles are made in all calibers, styles and weights; and whichever model you select, you can count on its being well made and finished, reliable in action and a strong, accurate shooter.

FREE—Send your name and address on a postal card for our 164 page illustrated catalogue.

WINCHESTER REPEATING ARMS CO. - NEW HAVEN, CONN.



Hang On.

Coffee Toppers as Bad as Others.

"A friend who lived with us a short time was a great coffee drinker and a continual sufferer with dyspepsia. He admitted that coffee disagreed with him, but you know how the coffee drinker will hold on to his coffee, even if he knows it causes dyspepsia.

"One day he said POSTUM FOOD COFFEE had been recommended and suggested that he would like to try it. I secured a package and made it strictly according to directions. He was delighted with the new beverage, as was every one of our family. He became very fond of it and in a short time his dyspepsia disappeared. He continued using the POSTUM and in about three months gained twelve pounds.

"My husband is a practising physician and regards Postum as the healthiest of all beverages. He never drinks coffee, but is very fond of Postum. In fact, all of our family are, and we never think of drinking coffee any more."

Written by the wife of a physician of Waterford, Va. Name given by Postum Co., Battle Creek, Mich.

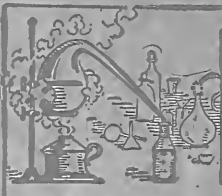

Certificate
OF AN
Eminent
CHEMIST.

I HAVE MADE A CAREFUL
CHEMICAL ANALYSIS OF

Sozodont

for the Teeth,

AND FIND NOTHING INJURIOUS
OR OBJECTIONABLE IN ITS COMPO-
SITION.

Julius G. Pohle, M.D.
Analytical Chemist.

FOR TWO SCORE YEARS AND TEN

Genteel Americans have cared for
their teeth with no fear of Acid,
Grit or other injurious substances

BY THE USE OF

SOZODONT

VOSE

PIANOS

have been established over 50 YEARS. By our system of payments every family in moderate circumstances can own a VOSE piano. We take old instruments in exchange and deliver the new piano in your home free of expense. Write for catalogue D and explanations.

VOSE & SONS PIANO CO., 160 Boylston St., Boston, Mass.

RECREATION

AMONG THE PRONGHORNS; By B. R. BEYER, with full page drawing by CARL RUNGIUS.

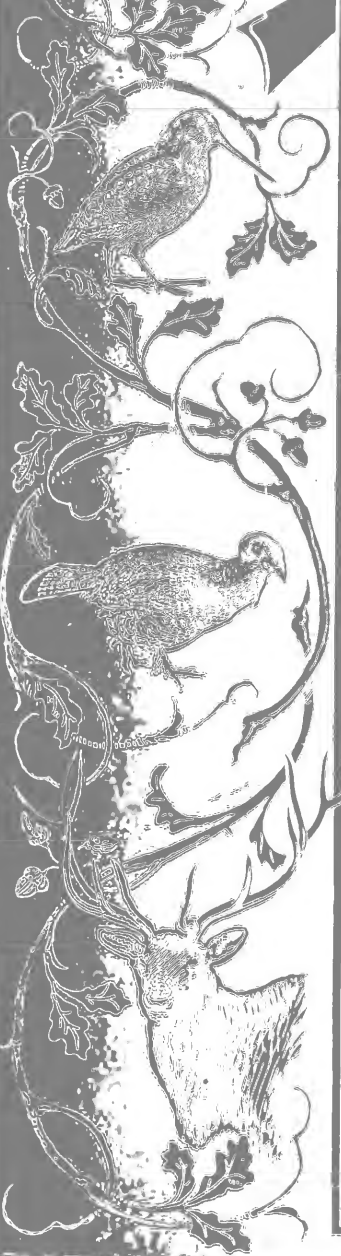
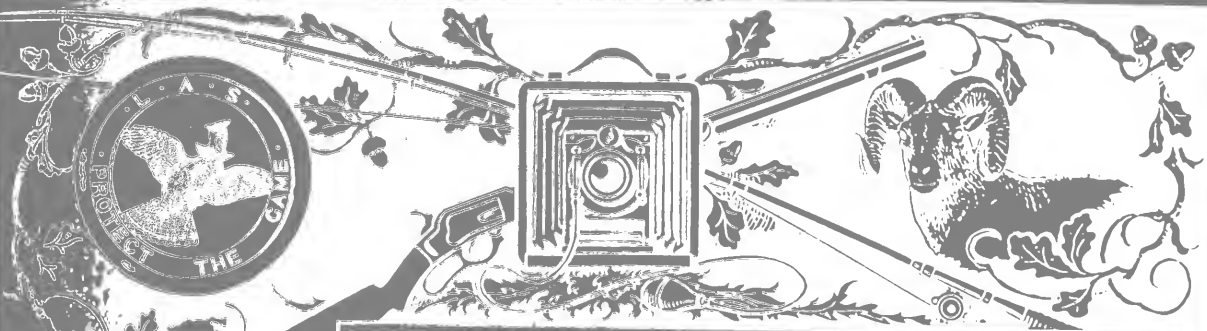

AMATEUR PHOTO BY J. E. TILOR.
TO THE VICTOR BELONG THE SPOILS.
One of the Special Prize Winners in RECREATION'S 7th Annual Photo Competition.

PUBLISHED BY G. O. SHIELDS (COQUINA)
23 WEST 24TH ST., NEW YORK

OFFICIAL ORGAN OF THE LEAGUE OF AMERICAN SPORTSMEN

FOURTEEN PRIZE-WINNING PHOTOGRAPHS REPRODUCED IN THIS ISSUE.

WHISKEY IS OF VERY ANCIENT ORIGIN

and was first made in Ireland in the early part of the twelfth century when it was called, "Usquebaugh" or "The Water of Life."

THE efforts of three generations of one family have been applied to the establishment and upbuilding of our business, which has been successfully conducted for fifty-two years. As a result of these efforts during the past twenty years our sales have increased more than a thousand per cent., good evidence of appreciation by our patrons

Full measure, fair prices, excellent quality, complete satisfaction guaranteed to each patron every time and all the time is the foundation upon which we have built; is the reason, not the secret, of our success, which is as sure and secure as the operation of any law of nature.

On the basis of such an assurance and such a guarantee to each and every purchaser, we solicit a trial order for 6 full quart bottles of either or any of our special brands.

<p style="text-align: right;">Per Gal.</p> <p>Holiday Pure Rye - 4.00 (Eleven Years Old)</p> <p>Hermitage Rock & Rye 4.00 <i>Superior</i></p> <p>Five pounds of rock candy crystals to each gallon of seven year old Hermitage Rye whiskey, is used in the preparation of our Celebrated Rock and Rye.</p> <p>Bon Ton Cocktails - 4.00 Martini, Manhattan, Vermouth, Whiskey, Tom Gin and Holland Gin. Carefully prepared from the choicest materials, perfectly blended.</p> <p>Ruthven Sherry - 4.00 From Duff, Gordon & Co. Warranted twenty years in the wood before bottling. Rich and fruity.</p>	<p style="text-align: right;">Per Gal.</p> <p>Old Gold Bourbon - \$4 00 (Eleven Years Old)</p> <p>Jewel Port - 4.00 From Silva & Cosens, Oporto. A choice product of the grape.</p> <p>Rainbow Brandy V.O. 4.00 The product of one of the best American Vineyards, with all the medicinal qualities of French Brandy.</p> <p>Jupiter Gin - 4.00 From the Swan Distillery, Schiedam, Holland, where Good Gin comes from. Tastes differ. Many people appreciate Good Gin. Jupiter is the best the world affords.</p> <p>Medford Old Rum - 4.00 From Daniel Lawrence & Sons, Medford, Mass.</p>
---	---

The goods are warranted as represented, namely, the *best* of their class that money can buy or that intelligent, honest endeavor, fortified with long experience, can produce.

On receipt of your order with \$6.00 we will ship 6 full quarts, assorted to suit, transportation charges prepaid, to any railroad point in the United States where the charges for transportation do not exceed \$2.00. You cannot afford to let this chance go by. You never before had as good an offer.

Remit cash in registered letter or by express company or P. O. money order. References: Any bank in Boston, any mercantile agency, or any distiller of importance in the United States.

W. H. JONES & CO., Hanover & Blackstone Sts.,
BOSTON, MASS.

ESTABLISHED 1851

RECREATION

Copyright, December, 1902, by G. O. Shields

A Monthly Magazine Devoted to Everything the Name Implies

\$1.00 A YEAR.
10 CENTS A COPY.

G. O. SHIELDS (COQUINA),
Editor and Manager.

23 WEST 24TH STREET,
NEW YORK

CONTENTS OF THIS NUMBER

	PAGE
Yellow Wolf . . . tried to dash into the post at the head of a dozen followers.	FRONTISPIECE
With the Best Intentions. Illustrated	F. M. BERNARD 167
A Girl's Life in the Rockies	MYRTIS B. BUTLER 180
A New Hampshire Coon Hunt	E. H. HUNTER 183
A Coon Hunt in Pennsylvania	CHAS. H. WEAVER 185
It Might Have Been. Poem	EDWARD BOURNE 185
Ned Buntline's Raquette River Bass	J. F. CLOSSON 186
A Glimpse of the Old Kentucky Home. Poem. Illustrated	GRAYSON JEMISON 187
A Florida Kid on a Camp Hunt	CHARLEY APOPKA 188
Among the Pronghorns. Illustrated	B. R. BEYMER 191
A Camping Trip in Argentina	L. S. MCCAIN 192
Merrimac Bait Catching	GEO. L. WHITMORE 193
From the Game Fields	197
Fish and Fishing	205
Guns and Ammunition	209
Natural History	215
The League of American Sportsmen	219
Forestry	223
Pure and Impure Foods	225
Book Notices	228
Publisher's Notes	229
Editor's Corner	233
Amateur Photography	238

Entered as Second-Class Matter at New York Post-Office, Oct. 17, 1894.

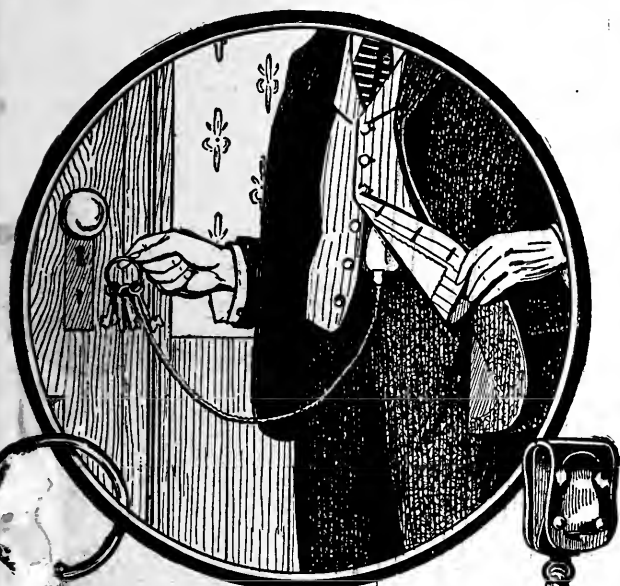

YOU CAN'T LOSE 'EM
WITH
ASHBURNE'S PATENT IMPROVED
STENER and KEY CHAIN

Y keys are always with you. You cannot lay them down or le them anywhere but in your pocket. At your dealers or se n receipt of price--Key Rings and Chain, 25c.; Cuff H. ., 20c. a pair; Scarf Holders, 10c. Send for illustrated cat og.

AMERICAN RING CO., Dept. 44, Waterbury, Conn.

Sore Throat

Hoarseness, Quinsy, Tonsillitis
Laryngitis and other throat
troubles quickly relieved
and promptly cured
by the use of

Hydrozone

This scientific germicide is used and endorsed by leading physicians every-where. It is *absolutely harm- less*, yet a most powerful healing agent.

By killing the germs that cause these diseases, without injury to the tissue, Hydrozone cures the patient. Sold by Leading Druggists. If not at yours, will send bottle, prepaid, on receipt of 25 cents.

Prof. Charles Marchand

(Dept. F-59) Prince Street, NEW YORK

20TH CENTURY LAUNCHES



STEAM YACHTS

SAIL YACHTS

ROW BOATS

CANOES

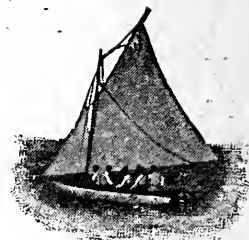
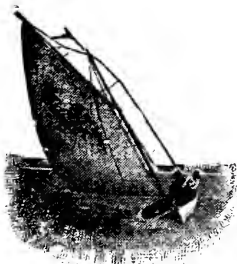

The Ideal Gentleman's Pleasure Craft used at the Pan-American Exposition because they were the best. Elegantly finished, simple, safe, reliable, and speedy. 15 ft. Fishing Launch, \$150. 16 ft. Family Launch, \$200. 35 ft. Cabin Launch, \$1,500. Send 10 cents for 80-page illustrated catalogue giving the truth in detail about the best boats built. Address

RACINE BOAT MFG. CO.
RIVERSIDE, RACINE, WIS.

We will have the largest exhibit ever made at the Sportsmen's Show, New York, of Sailing Craft, Launches, Row Boats, Hunting Boats and Canoes. Look for it Feb. 21st to March 7th



THE OLD WAY

THE BOAT as pictured below in every detail—length 15½ feet, beam 4 feet, with ¾ horse-power Blomstrom gasoline engine

\$100

*So simple a child can operate
with entire safety*

Catalogue D, including Marine Gasoline Engines of from ¼ to 80 horse-power at corresponding prices, free on request,

THE C. H. BLOMSTROM MOTOR CO.

1284-1294 River Street

Detroit, Mich.

THE NEW WAY





To look out for your comfort
 And make your trips complete,
 When on snow shoes or canoeing
 Or in the dry mesquit,
 When packing through the mountains
 Where they throw the diamond hitch,
 Is the object and the purpose
 Of **ABERCROMBIE & FITCH.**



We handle all **THINGS PRACTICAL,**
 To make life a treat,
 For **CAMPER** and **EXPLORER**
 When he leaves the busy street.
 The **FISHERMAN, PROSPECTOR**
 And others of that ilk
 Should try a tent of "Special"
 Or of "Waterproof Silk."

If you don't find what you want
 At once, call our attention,
 And from your pattern and design
 We'll make it as you mention.
 By all means get our catalogue
 And study well our goods
 For it surely will be needed
 In out-fitting for the woods.

Come and see us at our Camp,
 At 314 **BROADWAY,**
 Which some have called a club-room,
 And see our full display.
 You may perhaps find someone
 With whom a yarn to spin
 For travelers from every clime
 Are frequently dropping in.

WRITE FOR CATALOGUE R.

Abercrombie & Fitch
 314 and 316 Broadway
 NEW YORK, U. S. A.

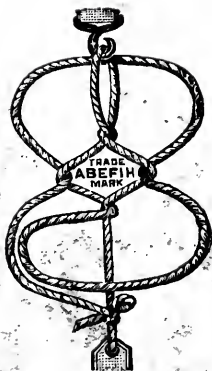

“Nothing so Rare as Resting on Air”

\$10 Worth of
Comfort for **\$2**

For
Every
Sportsman



INFLATED

For
Every
Canoeist

- A Yoke to save your shoulders
- A Swimming Collar for those who can't swim
- A Life Preserver in case of accident
- A Cushion while waiting for Moose
- A Cushion or Head Rest while waiting for Duck
- A Protection for your Shoulder if the Gun is heavy
- A Cushion for CAMP, BOAT, OFFICE or HOME

Carry It In Your Pocket
It Weighs Just One Pound

While you sit and listen for
The WHIRR of the Duck's Wings
The CALLING of the Moose
The APPROACH of the Bear
The RISING of the Fish
The many sounds that promise a good shot
or a Catch. You may be obliged to sit on a cold stone, a wet
log, the damp earth. At such times



ROLLED UP

YOU'D GIVE **\$10** FOR OUR SPORTSMAN'S CUSHION WE ASK ONLY **\$2**

Pneumatic Mattress and Cushion Company

35 BROADWAY, NEW YORK



If you mention this publication when ordering, we will pay your subscription to it for six months.

Game is Growing Scarce

SO ARE GAME FISHES

The time is coming when the only shooting or fishing worth while will be on private preserves.

HERE IS A CHANCE

To Join a Club that Will Always Have
PLENTY OF GAME and
PLENTY OF BROOK TROUT and
PLENTY OF BLACK BASS
 ON ITS OWN PROPERTY

Only 6 hours from New York City, 3 hours from Boston

20,000 acres of land, to be abundantly stocked with game of various kinds.

15 miles of trout streams to be stocked with trout.

Thousands of acres of lakes and ponds, to be stocked with black bass.

PINE FORESTS RICH IN OZONE

Hardwood forests, which are the natural home of the deer and ruffed grouse.

Old, abandoned farms, which will furnish ideal range for thousands of quail.

Golf grounds, polo grounds, tennis grounds, baseball grounds.

Fine roads for riding, driving, and automobiling.

Pure air, pure water, delightful scenery.

Address

L. A. TILLINGHAST

275 Westminster Street

Providence, R. I.



**FOR DOG WORMS ALWAYS USE
SERGEANT'S
"SURE SHOT."**

That's the name **POLK MILLER** gives his remedy for freeing dogs from worms,—generally worms from puppies.

Many finely bred dogs die before maturity when afflicted with worms. If they do not die, worms hold them back, destroy natural instincts, and often prevent the development of those qualities that ought to make puppies greater dogs than their parents.

Like children afflicted with worms, the pup becomes **inanimate, sickly and thin.**

Abnormal appetite that is bound to destroy the digestion and cause functional disorders which develop into chronic ailments **are the result of worms.**

If sometimes they do not die, worms leave them no good and a disgrace to their breeding.

Canine worms should be treated for immediately symptoms show.

All the time "**SURE SHOT**" is destroying worms it is putting into splendid condition the valuable pup patient. The pup will come out of his sickness with limpid eyes, keen sent, sleek coat, normal bone and muscle development. The following testimonial shows its efficacy. You may know the writer.

GREENBRIER, ALA.

"Sergeant's Sure Shot" is the only thing I have ever used with success. It has saved more than one dog for me, and I never expect to lose a dog from worms so long as I can get it." **WILLIAM M. HUNDLEY.**

SERGEANT'S SURE SHOT per bottle 50c. Sold by Druggists or Sporting Goods Dealers everywhere or mailed (prepaid) from

**POLK MILLER DRUG CO.,
RICHMOND, VIRGINIA, BOX 217.**

There isn't anywhere a dog lover or owner, who wouldn't like to have our 48 page Treatise on Dogs. We will send it and a Pedigree Blank to any address for 3 cents in stamps which go to pay the postage.

Decorate Your Den

With a set of the most beautiful
Hunting and Fishing Pictures
 ever made.

15 Plates. Size for Framing, 18 x 24 inches

SUBJECTS:

ELK HUNTING	SALMON FISHING	} HY. SANDHAM
MOOSE HUNTING	TROUT FISHING	

MALLARD SHOOTING — BLACK BASS FISHING — C. E. DENTON

TARPON FISHING — BLUE FISHING — FRED. S. COZZENS

ANTELOPE HUNTING — GOOSE SHOOTING — FRED REMINGTON

GROUSE SHOOTING — WILD TURKEY HUNTING — R. F. ZOGBAUM

MUSKALONGE FISHING — F. H. TAYLOR

DEER HUNTING — A. B. FROST

ROCKY MOUNTAIN SHEEP HUNTING — E. KNOBEL

These 15 plates are lithographed in the true colors of nature and altogether make one of the finest series of pictures of outdoor sports ever published.

ORIGINALLY ISSUED AT \$50 A SET

I have bought the last of them and can furnish a complete set for 15 yearly subscriptions to RECREATION,

Or will Sell at \$10 a Set

I also have enlargements of the following photographs:

ROCKY MOUNTAIN GOATS

Published on pages 90, 91, 92, and 93 of the February issue of RECREATION,
 \$5 a set.

WOOD DUCK SHOOTING

Published on page 95 of the February issue of RECREATION, \$1.50 each.

Address: RECREATION, 23 West 24th Street, New York City



"Wonderland 1903"

Will be Ready about **MARCH FIRST**

In it the Northern Pacific furnishes this entirely new series of articles, descriptive of the Northwest.

Priest and Explorer

Relates the travels and captivity of Father Hennepin, the Franciscan Priest, among the Indians in the Minnesota country in 1680. Hennepin wrote the first description of Niagara falls and discovered St. Anthony fall.

The Last of the Mandans

Describes a visit to the tribe of Mandan Indians, memorable in the annals of Lewis & Clark, and some of whom still live on the upper Missouri river.

Nature's Masterpiece

Which is Yellowstone Park, is newly described and illustrated. The Government is spending large sums in improving the roads in this WONDERLAND.

Irrigation in the Northwest

Shows the great progress made in irrigation in the far Northwest, and its adaptability to this region.

One Hundred and Fifty Miles with a Pack Train

Recounts an experience in the rough mountains of the Clearwater country, Idaho, with a pack train, while engaged in exploration.

In the Shadow of the Olympics

Describes that part of the Puget Sound region lying west of the Sound and in the vicinity of Port Townsend—an ideal health resort.

Columbia River and Mount Hood

Tells of the finest river and river scenery in the United States and one of its grandest snow capped mountains.

THE BOOK IS APPROPRIATELY ILLUSTRATED, ALSO HAS MAPS AND GIVES TOURIST RATES TO ALL POINTS IN THE NORTHWEST.

Send **SIX CENTS** for the Book to **CHAS. S. FEE, Gen'l Passenger Agent**
Saint Paul, Minnesota.



CUBA

The RIVIERA of America

**Direct
Service
New York
to
Havana**

thence along
the entire
North
Coast—an
ideal winter
trip.

**The
Munson
Line
Bulletin**

a beautifully
and
artistically
illustrated
monthly
about Cuba,
sent regularly
for the
asking.

Address
PASSEN-
GER
DEPART-
MENT.



MUNSON STEAMSHIP LINE
27 WILLIAM STREET - NEW YORK CITY
RAYMOND @ WHITCOMB CO., Ticket Agents
25 UNION SQUARE - - NEW YORK CITY



There is no more delightful holiday than a trip to California. And the best time to go is now—in March or April. California is at its best then. The hills and valleys are clothed in green; millions upon millions of wild-flowers are in bloom, and the air is as invigorating as a tonic.

Best of all, the Yosemite Valley opens April 1. You can visit it after you have seen southern and central California. The five day stage ride through this valley of wonders is a fitting culmination to the California pilgrimage.

The way to go to California is via the

Golden State Limited.

Newest, handsomest and most luxuriously equipped of trans-continental trains.

Leaves Chicago daily at 7.45 P.M., Kansas City at 10.40 A. M. Less than three days to Los Angeles. Through cars to Pasadena, Los Angeles, Santa Barbara and San Francisco. Lowest altitudes and most southerly course of any line across the continent. Compartment and standard sleeping cars; dining, buffet-library and observation cars. Electric lights; electric fans; bath; barber.

Route: Rock Island and El Paso-Northeastern Systems, Chicago to El Paso; Southern Pacific Company, El Paso to Los Angeles and San Francisco.

Tickets and full information at all railroad ticket offices in the United States and Canada. Beautifully illustrated literature descriptive of California sent on receipt of six cents in stamps.

JOHN SEBASTIAN, Passenger Traffic Manager, Rock Island System, Chicago, Ill





The People Expect

that greater care will be taken in the manufacture of every foot of Page Fence, and we are constantly trying to meet their expectations.

We Heartily Recommend

Page Fence for the worst breachy stock, and it does just as well for quiet stock.

Calves fenced with Page Fence never grow into breachy cattle.

PAGE WOVEN WIRE FENCE CO.

Box 39.

Adrian, Michigan

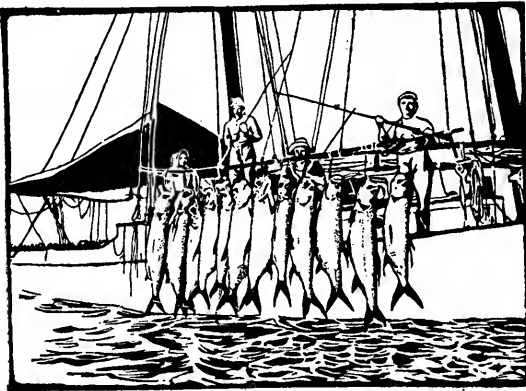

A CATCH OF TARPON

SEABOARD

Air Line Railway

Shortest Way to

FLORIDA

Seaboard Florida Limited

New York to St. Augustine. By the Fastest Schedule ever Run Through the South.

The **SEABOARD** is the Line to the Manatee Country and Sarasota Bay, the Home of the Tarpon. For Booklets on the "Land of the Manatee," and on "Hunting and Fishing on the Seaboard," apply to

J. L. ADAMS, Gen. Eastern Agt.
1183 Broadway, New York

CHARLES B. RYAN, Gen. Pass'r Agt.

EDWARD F. COST, Traffic Mgr.
Portsmouth, Va.

Exposition Flyer

Via

"Big Four"

From

Cincinnati

To

St. Louis

Write for Rates and Folders.

Warren J. Lynch. W. P. Deppe,
Gen'l Pass. & Tkt. Agt. Ass't Gen'l P. & T. A.
CINCINNATI, OHIO.

Santa Fe all the Way

You leave Chicago on the **California Limited**. In less than three days you are in California. It's Santa Fe all the way—train, track and management.

Ladies will be pleased with the cosy compartment Pullmans and sunny observation parlor. In latter are fashion journals, monthly magazines, stationery and a library. In buffet-smoking car gentlemen will find daily market reports, latest newspapers and an expert barber. Opportunity for a neighborly chat or smoke.

The six o'clock dinner—Harvey's best—is a social delight. The tables are resplendent with cut glass and silver. Electricity furnishes a rich flood of light. Every delicacy on the menu.

Chicago and Kansas City to Los Angeles, San Diego and San Francisco. Books about California tour and Grand Canyon of Arizona.

Atchison, Topeka &
Santa Fe R'y.

Santa Fe

Gen. Pass. Office
1312 Gt. Northern Bldg.
Chicago

The Only Line

REACHING

Old Point Comfort

WITHOUT CHANGE

OLD DOMINION STEAMSHIP CO.

Sailing Daily, Except Sunday
at 3 P.M. from

Pier 26, North River, New York

H. B. Walker, T. M. J. J. Brown, G. P. A.

81-85 BEACH STREET, NEW YORK

"A land of music and flowers and birds."

OLD MEXICO

Is a more "foreign" land and has more interesting places and strange customs to attract the traveler from the United States than any country of Europe, and it is right at home. A winter trip to Mexico is delightful, and can be best made by the

NEW YORK CENTRAL LINES

Lots of facts regarding Mexico can be had at either of our 77 information and Recreation Bureaus.

A copy of the 52-page Illustrated Catalogue of our Four Track Series sent free on receipt of a 2-cent stamp by George H. Daniels, General Passenger Agent, New York Central Railroad, Grand Central Station, New York.

The FOUR-TRACK NEWS for November, 1902, has an interesting article on Mexico. Sold by Newsdealers everywhere for 5 cents.

"FOR 34 YEARS A STANDARD PIANO."

THE WING PIANO

YOU NEED THIS BOOK IF YOU INTEND TO BUY A PIANO. A book —not a catalogue— that gives you all the information possessed by experts. It makes the selection of a piano easy. If read carefully, it will make you a judge of tone, action, workmanship, and finish; will tell you how to know good from bad. It describes the materials used; gives pictures of all the different parts, and tells how they should be made and put together. It is the only book of its kind ever published. It contains 116 large pages, and is named **"The Book of Complete Information About Pianos."** We send it free to anyone wishing to buy a piano. Write for it.

SAVE FROM \$100 TO \$200 We make the WING PIANO and sell it ourselves. It goes direct from our factory to your home. We do not employ any agents or salesmen. When you buy the WING PIANO you pay the actual cost of construction and our small wholesale profit. This profit is small because we sell thousands of pianos yearly. Most retail stores sell no more than twelve to twenty pianos yearly, and must charge from \$100 to \$200 profit on each. They can't help it.

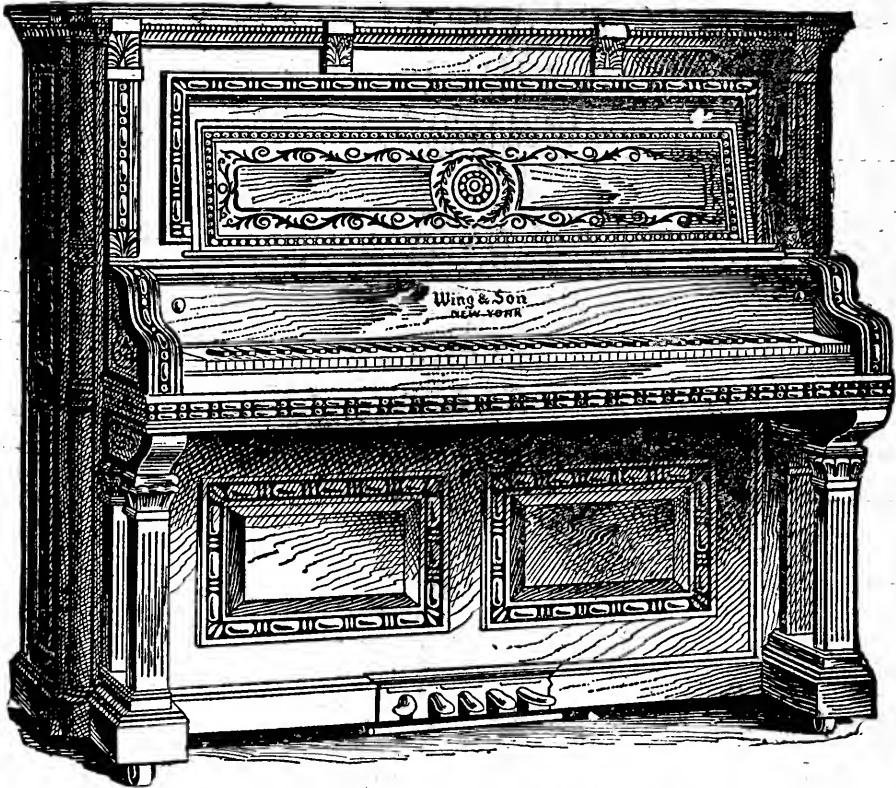

A Wing style—45 other styles to select from.

SENT ON TRIAL WE PAY FREIGHT. NO MONEY IN ADVANCE. We will send any WING PIANO to any part of the United States on trial. We pay freight in advance and do not ask for any advance payment or deposit. If the piano is not satisfactory *after twenty days' trial in your home, we take it back entirely at our expense.* You pay us nothing unless you keep the piano. There is absolutely no risk or expense to you.

Old instruments taken in exchange.

EASY MONTHLY PAYMENTS.

INSTRUMENTAL ATTACHMENT

the tones of the mandolin, guitar, harp, zither and banjo.

A special feature of the Wing Piano; it imitates perfectly

IN 34 YEARS 33,000 PIANOS

We refer to over 33,000 satisfied purchasers in every part of the United States. WING PIANOS are guaranteed for twelve years against any defect in tone, action, workmanship, or material.

WING ORGANS

Are just as carefully made as Wing Pianos. They have a sweet, powerful, lasting tone, easy action, very handsome appearance, need no tuning. Wing Organs are sold direct from the factory, sent on trial; are sold on easy monthly payments. For catalogue and prices write to

WING & SON, 226 and 228 East 12th St.,
NEW YORK.

1868—35th Year—1903.

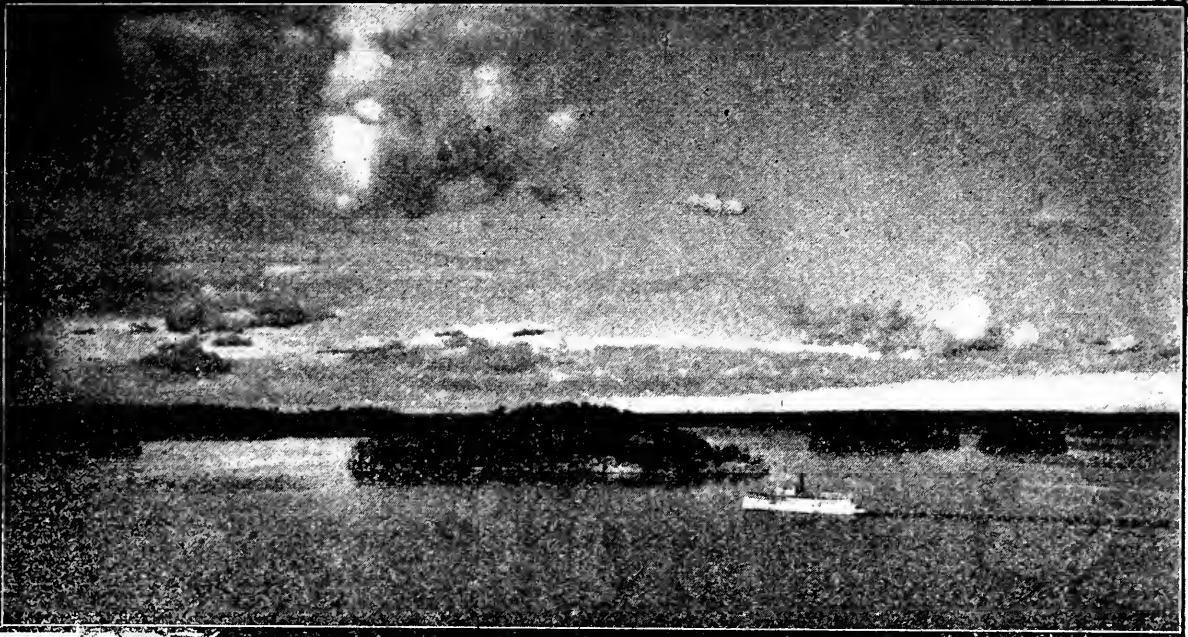

TYPICAL SCENE - MUSKOKA LAKES

THE "ROYAL MUSKOKA" HOTEL, MUSKOKA LAKES,
CANADA.

Is elegantly furnished,
fine cuisine, magnificent
surroundings, 1000 feet
above sea level.

Most charming summer
resort region in America.
Perfect immunity from
Hay Fever assured.

For full particulars, Illustrated descriptive literature, rates, maps,
and all information, apply to

G. T. BELL, Gen'l. Pass'r and Tkt. Agent,
GRAND TRUNK RAILWAY SYSTEM, MONTREAL, QUE.

OR TO
MUSKOKA NAVIGATION CO., LTD.,
TORONTO, CANADA.

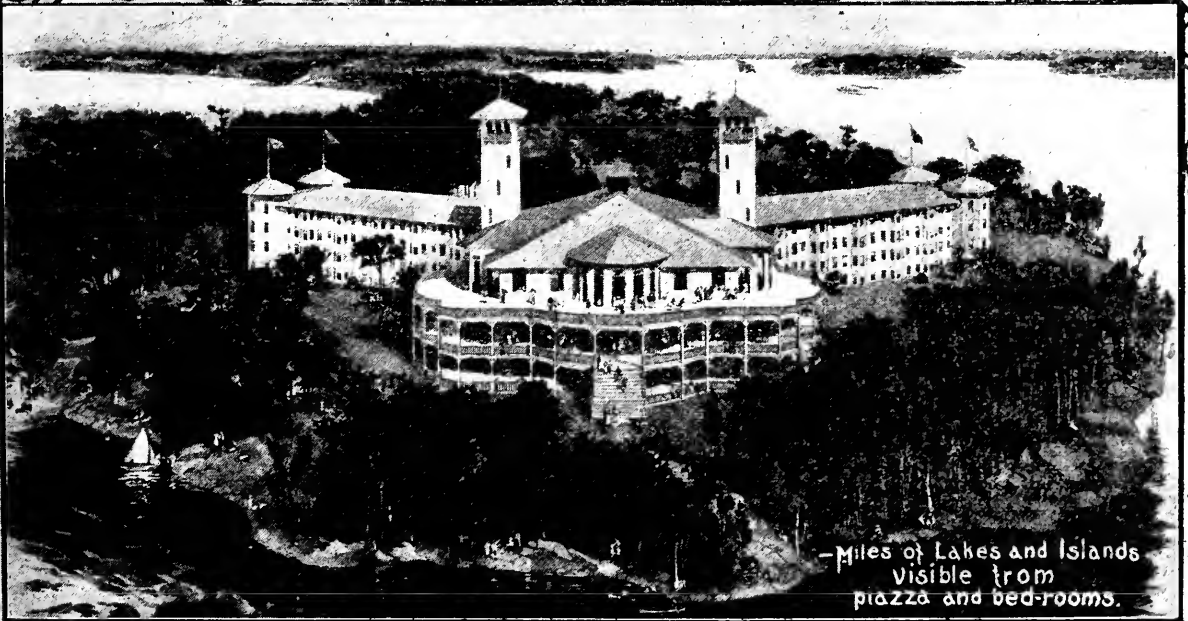

- Miles of Lakes and Islands
visible from
piazza and bed-rooms.

ROYAL MUSKOKA HOTEL

Mr. DOUBTER, A WORD WITH YOU!

DO YOU KNOW that choice grain and pure water are the two essentials for making good whiskey?

DO YOU KNOW that Government statistics prove that the Miami Valley, in the very heart of which our distillery is located, produces the best grain and has the purest water of any section of this country?

DO YOU KNOW that we have one of the largest and most completely equipped distilleries ever operated?

DO YOU KNOW that we have had over 37 years' experience in distilling good whiskey?

DO YOU KNOW that there is more HAYNER WHISKEY sold than any other brand of whiskey in the world?

DO YOU KNOW that we supply regularly with HAYNER WHISKEY nearly half a million of the most prominent and influential business and professional men in this country?

DO YOU KNOW that these are the very people who want the best and wouldn't be satisfied with anything else?

DO YOU KNOW that HAYNER WHISKEY goes direct from our distillery to you, with all its original strength, richness and flavor, thus assuring you of perfect purity and saving you the enormous profits of the dealers?

DO YOU KNOW that you cannot buy anything purer, better or more satisfactory than HAYNER WHISKEY no matter how much you pay?

IF YOU DIDN'T KNOW these facts before, you know them now, and, knowing them, how can you longer doubt our ability to please you? How can you hesitate to accept our offer? Your money back if you're not satisfied.

OUR OFFER.

We will send you **FOUR FULL QUART BOTTLES** of HAYNER'S SEVEN-YEAR-OLD RYE for \$3.20, and we will pay the express charges. Try it and if you don't find it all right and as good as you ever used or can buy from anybody else at any price, then send it back at our expense and your \$3.20 will be returned to you by next mail. Just think that offer over. How could it be fairer? If you are not perfectly satisfied you are not out a cent. Better let us send you a trial order. If you don't want four quarts yourself, get a friend to join you. We ship in a plain sealed case, no marks to show what's inside. Write our nearest office **NOW**.

Orders for Arizona, California, Colorado, Idaho, Montana, Nevada, New Mexico, Oregon, Utah, Washington or Wyoming must be on the basis of 4 QUARTS for \$4.00 by EXPRESS PREPAID or 20 QUARTS for \$16.00 by FREIGHT PREPAID.

ESTABLISHED
1866.

THE HAYNER DISTILLING COMPANY,

DISTILLERY,
TROY, OHIO.

DAYTON, OHIO. ST. LOUIS, MO. ST. PAUL, MINN. ATLANTA, GA.

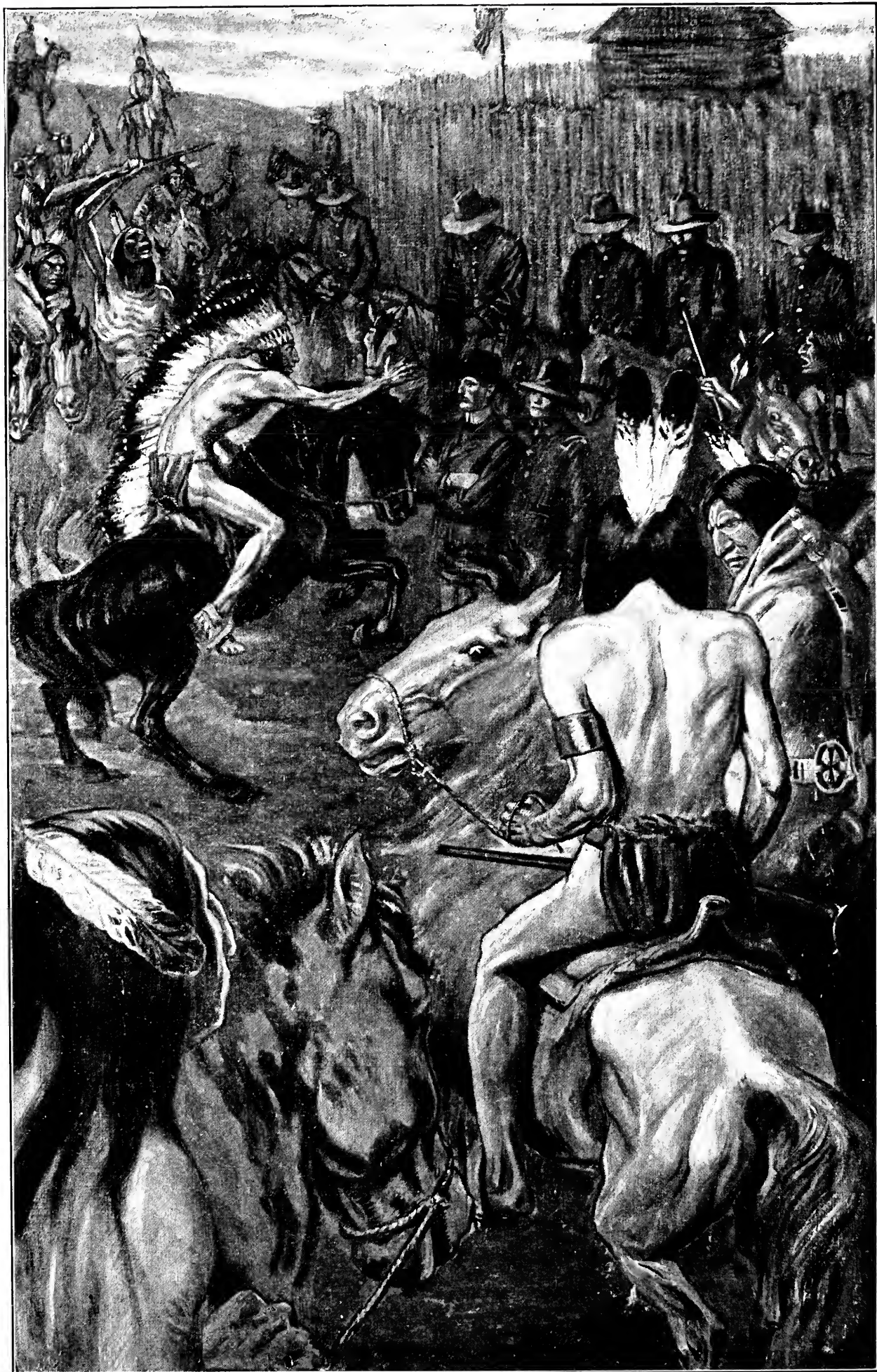

YELLOW WOLF . . . TRIED TO DASH INTO THE POST AT THE HEAD OF A DOZEN FOLLOWERS.

RECREATION

Volume XVIII.

MARCH, 1903.

Number 3.

G. O. SHIELDS (COQUINA,) Editor and Manager

WITH THE BEST INTENTIONS.

F. M. BERNARD.

"Please accept this as coming from one whose eyes are like yours," said Mr. Halsey Pyne, of New York, to an Indian girl with fine grey eyes, who, leaning against a pony, was standing guard over a lot of rations lying on the ground about her. As he spoke he held out a paper bag of the cheap candy beloved by the aboriginal palate.

By way of reply she gave him a timid, startled glance; not understanding a word he said, she could scarcely answer with words. He pressed his gift upon her. Shyly, with a delightful smile and drooping head, working the while the toe of her snow-white moccasin into the loose earth, murmuring low as a cooing dove something in choice Sioux, she looked across the bare plateau in front of the agency, alive and bustling as it always is on ration day; at Straight Oak, a young buck a few yards off, attired in the height of Indian elegance; at the sky; everywhere except at her white admirer. For the instant his thoughts strayed to the owner of another pair of grey eyes, in the East, that filled with tears when he bade her farewell, and would glow with pleasure on his return.

Suddenly there was a patter of feet, and a sack of flour, a side of bacon and a few other articles dropped on the ground from the head and shoulders of a middle-aged squaw, who straightened herself without a break in the cackle she had kept up since coming in sight. Question and answer passed between her and the girl,

then the latter, shrinking a bit, held out her hand and the bag fell into it.

"Thank you," said the youth. He would have said more only he saw the mother coolly take the parcel from the daughter and slip it into one of the many folds of the blanket thrown loosely around her shoulders and kept in place at the waist by a strap.

"Oh, see here, that's for the girl, not for you," he cried, emphasizing his words with what he imagined was sign language.

The old dame's retort raised shouts of laughter, whereupon she repeated it. Determined to carry out his intention, he demanded the return of the package, and when the old woman, keeping up her incessant chatter, showed plainly her intention to dishonor his demand, he attempted to take it; whereupon her voice rose to a shriek and the Indian men closed in on the pair. Undeterred by this, he kept up the pursuit, and the spectacle was presented of a society millionaire with high political ambitions, a zealous champion of the oppressed Indian, dodging about to the laughter of a crowd of red men and women, chasing a smoke-dried old squaw, who easily eluded him. Lieutenant Vivyan, with whom he was spending the summer at the neighboring fort, put an end to the scene by forcing himself into the throng.

"By Jove, old man, what are you up to now?" Vivyan demanded.

"Up to now!" retorted Pyne indignantly and a little blown. "Up to enough. I gave this girl some candy

and I'm blowed if this old hag didn't take it from her. I want her to give it back. Make her do it, Viv. You should have authority here."

"What do you want to be giving candy to Indian girls for?" began Vivyan; then, catching a full view of her face, "Ah, I see," he went on. "Well, all I have to say is, if you are going to bestow candy whenever you see a pair of beautiful eyes you'll be kept moving. Here, what's the trouble, Bob?" and he turned to a fat-faced half-breed, who stood near, grinning broadly.

"She say," replied Bob, after consulting the old woman, "that she the gal's mudder. She say she take it away to keep for the gal, so that the kids at home have some. She say if she didn't, the gal would eat it all herself."

"There! You see it is all right," interrupted Vivyan. "Come along."

"But the candy is the girl's, and she should have it," persisted Pyne.

"Oh, dash it," groaned Vivyan, "you can't change Indians' ways. Don't you see we are being laughed at?" and almost by force he dragged his friend away.

The young brave, Straight Oak, regarded the scene with great interest. When Pyne presented the candy, a scowl of hate and ferocity darkened his brow. When the mother appropriated the gift, his laughter was the loudest of all, but it was sardonic, not mirthful. The poor beggar was in love with the girl. He had painted his face in several colors and draped his heavily beaded blanket so as best to display his shining body for her sake; and that she might admire him to her heart's content he had posed in full view from where she guarded the family food. Then to have this pestilential white man come with his paper bags! No wonder his fingers fumbled the fastenings of his gun cover. Now and then the girl sent him an appealing glance, as if to say,

"I don't like it, but if gentlemen *will* admire me, I can't send them away."

This failed to propitiate him, and when the friends left he sprang on his pony and dashed off without so much as a glance at her. Half an hour later, as the 2 gentlemen were going back to the post on foot, Straight Oak passed them at a gallop, then returned and circled around them 2 or 3 times on a lessening radius, opening the vials of his wrath as he did so and pouring on the unconscious New Yorker the vilest epithets and grossest insults known to the Indian tongue.

"Ah," remarked Pyne, regarding the fellow with interest and smiling amiably at him. "There's a rider worth while! I noticed him at the agency. I suppose he is trying to entertain us. Gad! we should encourage him," and he waved his hand and called out, "Good enough, old chap!" which the Indian understood about as well as Pyne understood Sioux. Shaking his rifle savagely, Straight Oak turned and disappeared over the bank of the Blackwater; but if the white men had looked behind them when they entered Vivyan's door, they would have seen him lurking about the post entrance, watching them stealthily. The fires of jealousy were consuming him. Loving the girl, he thought Pyne's attentions must be prompted by feelings akin to his own, and it infuriated him. Besides, his own affair was in a doubtful state, which did not improve matters. He had not yet approached her father, knowing it would be useless; he owned not the number of ponies the elderly chief demanded for her hand, though he knew of a Crow village up country where he could easily steal them. Nor was he even sure of the damsel. Several times the 2, wrapped in one blanket, had stood in loving converse, but no pledges had passed. What wonder, then, if his soul burned when a stranger, and a white

man at that, cast his eyes in her direction?

About that time some malign spirit put in Halsey's head an idea that the runty, grass-fed Indian ponies would make capital polo ponies, and as with him action trod on the heels of thought, he at once set about gathering in a number. Ricketts, the agency butcher, as a dependable man was consulted.

"You want to see Yellow Wolf," the latter declared, readily. "He's got just what you want, but I'd best go with you, as the old cuss 'll cheat the hair offen your head," he concluded, not intimating that he accompanied the buyer in order to secure a share of the profits from the seller.

Yellow Wolf was the father of Long Hair, the heroine of the candy squabble, and the first time Halsey went to his lodge he was left alone with the girl. Of course, Straight Oak took that very moment to dash by and behold them. In fact, he saw them every time they were together, which was frequently, the transaction being considerably prolonged, not, as the lover believed, on account of Long Hair, but because of another member of the family.

When the New Yorker first visited the pony herd he found it in charge of a bright lad of 13 or 14 years, who handled it with the skill and ease of a man. Pyne was a born reformer, so he instantly conceived a plan to send the young herder to an Eastern school. He mentioned this scheme to Ricketts.

"Not on your life, my friend," responded that worthy; "unless you want to see the old man foam at the mouth. The last time they tried to take his kids away he took to the hills for a year. Anyway, pardner, keep mum till the deal is over," he concluded, concerned about the good thing in his hand. Halsey, however, could not keep silent.

Yellow Wolf did not foam at the

mouth when the subject was broached, but by the fierce energy of his refusal he startled and, to tell the truth, frightened our friend. The father found himself in a difficult position. He did not want to forego the great profits he was making. On the other hand, he feared to remain at the agency lest he lose his child. Pyne, with characteristic liberality, was always making the children bloom like a neglected garden with garish finery from the trader's store, and filling them with the edible delicacies thereof, which caused White Dove, the mother, sensible of these advantages, to array herself against her husband, knowing that he would not consent to part with his son. Thus was division created in a previously united wigwam. The harassed old chief did not keep his perplexities to himself, and as a consequence uneasiness and alarm replaced quiet and content at a peaceful agency.

All this while Straight Oak, wrapped up to his eyes in a blanket, stalked silent and suffering among his fellows brooding on vengeance. Driven to despair, he once approached Long Hair as she sat before the lodge door, but hardly was the greeting over when White Dove flew out and drove him away, soundly berating the ponyless lover for prowling around her cote, an unwise proceeding on her part.

One evening at dinner, Mr. Pyne remarked oratorically:

"You army men have a good deal to learn in your treatment of Indians. You don't view them as individuals. Now I have seen something of Yellow Wolf and have gained his confidence sufficiently to influence him. He knows I have his interest at heart and trusts me." Some discussion followed, but it was not pertinent.

A few hours later, as the East was brightening, Yellow Wolf, wildly excited, was halted at the guard-house

as he tried to dash into the post at the head of a dozen followers.

"He wants to see that tenderfoot at Lieutenant Vivyan's," said Private Spooner, whose slight knowledge of the Sioux language enabled him, after several attempts, to guess with reasonable certainty the meaning of the old man's cascade of words and frenzied gestures.

"Well, he can't do it at this time of day," declared the sergeant. The private was not equal to imparting this information, and his endeavors to do so only complicated matters. The chief, ably supported by White Dove, held to his purpose so energetically that the officer of the guard, who had taken a hand in the affair, sent for the interpreter. Soon after his appearance, Mr. Pyne, to whom a note had been dispatched, walked up, saying genially as he did so,

"Well, Wolf, what's the row?"

"You'd better hold his pony's head," advised the interpreter to the sergeant, for Yellow Wolf, his followers increased to 50 or 60, began to force his way toward Halsey.

"See here, Pyne, this old chap says you've stolen his daughter and sent her East," said the officer of the guard by way of beginning explanations.

"I've done nothing of the sort. What should I want with his daughter?" indignantly replied the thunder-struck young man.

"He say you've sent Long Hair to school," spoke up the interpreter. "He say she hasn't been home all night, her bedclothes all gone, that everybody knows you're here to steal kids and send them back East."

Pyne gasped out a few incoherent words.

"He say," went on the interpreter, "that if you'd do such a thing of course you'd lie about it."

"Here, we've had enough of this sort of thing. Sergeant, send this gang about its business," said the officer of the guard.

But that was a task beyond the sergeant's power. The gang evidently fancied it was attending to business. By the time the officer of the day, and with him Vivyan, arrived, matters were squally. Pyne, pale but plucky, was standing with a soldier on each side of him. Facing him at 2 yards' distance, sat Yellow Wolf, similarly provided; and 100 or more Indians were moving restlessly about, shouting to one another, ugly and threatening. White Dove, chattering without pause, made every once in a while a dash at Halsey.

"Great Scott," cried Vivyan when he reached his friend, "have you been monkeying with this old fool's children?"

"No," answered the harried young man, "I know no more than you."

"If that is the case," put in the officer of the day, coming up, "you would best go back to your quarters, Mr. Pyne."

Halsey, glad to get away legitimately, started at the words, but a great uproar arose at once. Yellow Wolf struck his pony a blow that made him jerk the man at his head 5 or 6 feet; several, galloping, placed themselves between Pyne and the post; the others closed in, brandishing their guns and yelling defiantly. White Dove worked her way out of the throng.

"They say he sha'n't go till he tells where the girl is. They say they will begin shooting first," exclaimed the interpreter breathlessly, as he ran up to the officer of the day.

"Oh, do they?" he returned sarcastically. "Stop a moment, Mr. Pyne. Mr. Stetson, form the guard."

The guard, 71 all told, appeared small opposed to the crowd of savages, and the officer of the day decided to keep them in place till the Post Commander, nowise pleased at being called out so early, should come up.

Poor Pyne went through another course of questions and denials, dur-

ing which White Dove scampered across the prairie as fast as Cayenne could carry her.

The commanding officer, after trying unsuccessfully to disperse the gathering, waved his handkerchief and a troop of cavalry trotted round the corner of the quartermaster's warehouse and formed into line. Contrary to expectations and habit, the Indians did not take flight, but stood their ground.

While the interpreter was giving them the last word, White Dove's voice, blithe as a spring morning, was heard, a shout went up and a break was made to where she was ambling along, driving Long Hair and Straight Oak in front of her, the former looking very foolish and scared, the latter most unnecessarily fierce.

Half-crazed by jealousy, by working on her fears and love, he had induced Long Hair to run off to an uncle in a neighboring village, to remain till he could visit the Crow village for the acquisition of ponies. But he counted without an aunt, a worthy woman, who, considering that a full tepee needed no more occupants, started Long Hair for home at early dawn.

"I did it with the best intentions, Colonel," said Mr. Pyne when reproached with interfering with Yellow Wolf's domestic affairs.

"Intentions be d——d!" snapped the Colonel. "Did you ever hear of a place that is paved with good intentions? Now, if you will work off your infernal philanthropy on some other tribe of redskins, I shall be greatly obliged to you."



I WISH MY PA WOULD COME.

One of the Special Prize Winners in RECREATION'S 7th Annual Photo Competition.



WHAT IS HOME WITHOUT A MOTHER?

One of the Special Prize Winners in RECREATION'S 7th Annual Photo Competition.



PROSPECTIVE HOUSEKEEPING.

One of the Special Prize Winners in RECREATION'S 7th Annual Photo Competition.



HARD TO DISLodge

One of the Special Prize Winners in RECREATION's 7th Annual Photo Competition.



A DESPERATE LEAP.

One of the Special Prize Winners in RECREATION'S 7th Annual Photo Competition.



SO NEAR AND YET SO FAR.

One of the Special Prize Winners in RECREATION'S 7th Annual Photo Competition.



A HOT CHASE.

One of the Special Prize Winners in RECREATION'S 7th Annual Photo Competition.



A SUDDEN CHARGE.

One of the Special Prize Winners in RECREATION'S 7th Annual Photo Competition.



THE CAPTURE.

One of the Special Prize Winners in RECREATION'S 7th Annual Photo Competition.



RETURNING HOME.

One of the Special Prize Winners in RECREATION'S 7th Annual Photo Competition.



A TENNESSEE CLIMBER.

One of the Special Prize Winners in RECREATION'S 7th Annual Photo Competition.

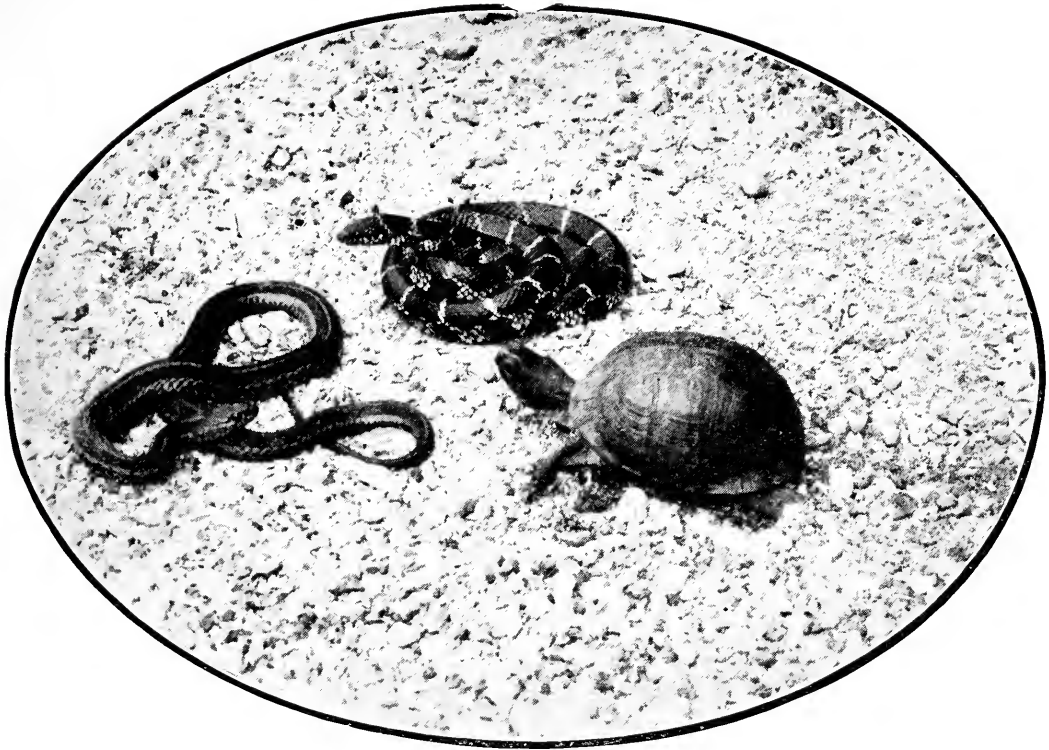

A THREE-SIDED ARGUMENT.

One of the Special Prize Winners in RECREATION'S 7th Annual Photo Competition.

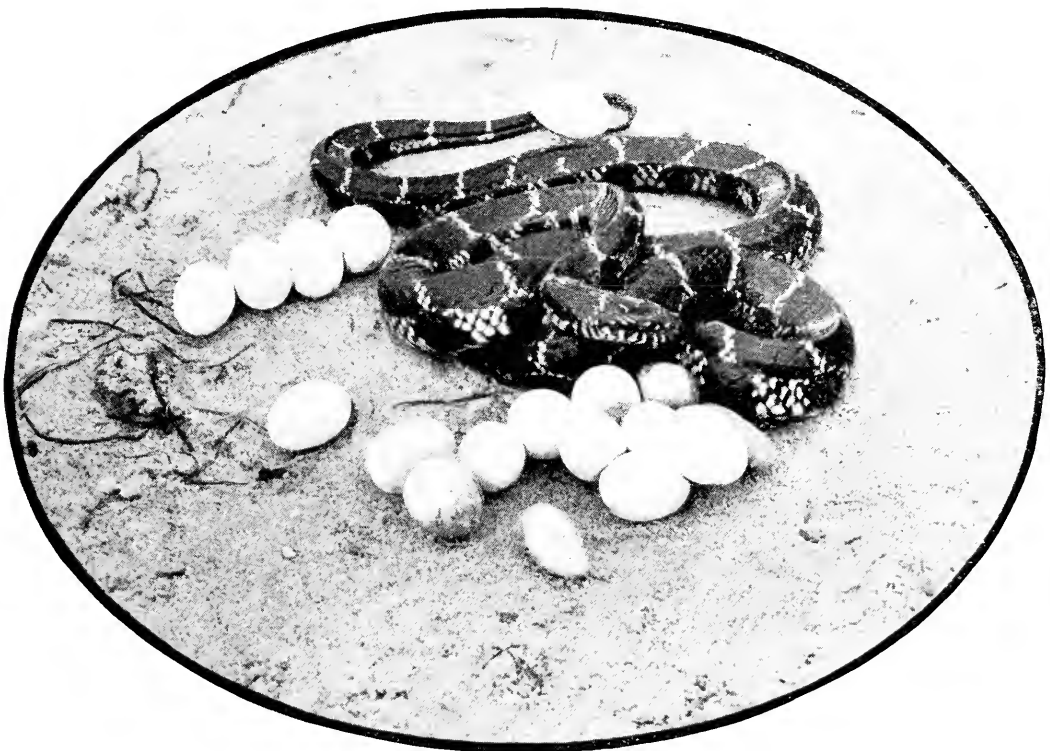

WAITING FOR A SUNBATH.

AMATEUR PHOTOS BY J. E. TYLOR.

One of the Special Prize Winners in RECREATION'S 7th Annual Photo Competition.
Made with Manhattan Camera.

A GIRL'S CAMP LIFE IN THE ROCKIES.

MYRTIS B. BUTLER.

My introduction to camp life took place when I was a girl just out of school, and consisted of a tour through Yellowstone Park, which I made with a party of 4 "grown-ups," 3 seated in our own buckboard, with only Cy, a cowboy driver, for guide by day, and a small wall tent for shelter by night. Every day we drove, pitching the tent where night overtook us. There I first learned how good are potatoes roasted in the ashes, and freshly caught trout fried over a camp fire. There, most wonderful of all, from a woman's point of view, I got sound wholesome sleep and rest, rolled in a blanket on the bare ground; for in such hurried camps as those there was not always time to cut fir boughs for a bed, even could they have been found. In that way we spent a fortnight of rarest pleasure, stopping where fancy took us, exploring all the well known beauties and interests of the great park, studying many lovely spots that the stage driver passes with a wave of his hand, and learning with it all how to enjoy as primitive a form of camping as one often finds in a party including women.

However, the place that I grew to regard as my camp home was Lake Chelan, a beautiful stretch of water that winds 20 miles among the Cascade mountains, at no place more than 3 miles wide, and often only one mile across. It is more accessible now, since the Great Northern has connected at Wenatchee with the Columbia river steamboats, but in the days of my first trips there it meant hard travel; 63 miles in a Concord coach, over the Great Bend country, where the weight of an almost springless vehicle carried us down through a foot or more of alkali dust to the broken, basaltic rock, on which we jarred and jolted, while the dust rolled in clouds over the wheels and hung on the travelers until we were scarcely recognizable after an hour. Twice I have made that trip in a summer day, between dawn and midnight; but at other times we broke the journey by a night at the ranch in Moses coulee, a wonderful great rent running across the plain, and the only green, cultivated spot in a waste of dust.

One might think the journey done with that, but no; there was the sudden descent, 300 feet in half a mile, to the Columbia river, which was crossed then in a hand-ferry, run by 2 Indians, besides another 6 miles to drive along a narrow, shelflike road through the canyon of the Chelan river, before we had even a first glimpse of

our Mecca, with a prospect then of a whole day on the steamer, as we were to go within 5 miles of the lake's head.

About the foot of the lake the shores are rolling, sparsely wooded prairie, glorious with flower life by spring, and rich in cultivated fruits and vegetables by fall. As one sails, each serpentine turn in the river-lake brings a change. The shores rise to hills and then to mountains. Along the last 20 miles the rugged peaks are snow-capped the year around, and great overhanging cliffs tower on either side, offering few good landing places and still fewer camping sites.

On the Northeastern shore we found a small cove, however, with a rocky point on one side, over which the spray dashed madly when the wind blew down the stream, and on the other side a somewhat gentler looking point, well wooded and with a rushing creek of snow-water tumbling through it. A few feet of sandy beach midway between these points, with a little brook that ran the year around at one side, offered a good site and became our camp. To that spot we went back again and again, seeing it at every season of the year, and finding each month so attractive in its own way and so totally different from others as to make us almost forget the joys of the last.

Even the rainy season was not left out. On one occasion we were pitching tents the 10th of October, about a week after the fall rains had set in. The natives had all folded their tents some weeks before and stolen back to cabin and shack. We afterward learned they thought us a set of lunatics, and were calculating on attending our funerals; but there we were, in all the mist and rain, and not one of the 3 women of that party what one could call robust. Yet we lived, and incidentally had a joyous time. During our 7 weeks' stay rain or snow fell some part of each day, and the appearances of the sun could be counted on the fingers of one hand. After the first 3 weeks, perhaps it was a risk, but no one caught cold. The 2 semi-invalids of the party came out strong and well; and while there was more than once a dissenting voice, when the water got too thick in the frying pan, and the food cooled before we could eat it, still the majority ruled and voted it well worth while. Those soft, cloudy days were made for long climbs on the benches, for the shooting was excellent. Many a hard pull we took up goat trails and over rocky slides, with none of the

fatigue of a sunny day. The lake, that had been so angry and rough all through the spring months, was calm and still, a joy to the oarsman.

We had taken canvas cots with us, quite an offering to the shrine of luxury we thought; but we soon went back to the softer, sweeter fir boughs, so close to the warmth of Mother Earth. On those we slept until late in November; in fact, until the snow broke the tents down over us, and we were glad of the shelter of the scarcely completed shack we were building near.

We ate our Thanksgiving grouse in camp, and crossed the coulee the next week in a snowstorm so blinding and heavy that the driver lost his way and had to give his horses their heads. To their good sense we owed a safe, though tardy, arrival.

The next year we made the trip on a construction train on the Great Northern, and after that our camp life had many of the comforts that go with a shelter of boards and tar paper. Yet my father and I sometimes longed for our old days of genuine roughing it, and would start off for a day or 2 on little expeditions of our own. Together we worked through the jungle, scrambled up the face of the rocky shores, or crawled and climbed many a mile along the creeks, with rod and axe and gun, or fished the lake for rainbow and Dolly Varden trout, and plundered the banks of flowers.

People sometimes ask me what a woman finds to do in camp. Why, the days are not long enough for the many pleasures of camp life. A woman has all the pastimes of a man in camp, except the very long, hard tramps, and she has her own as well. No matter how unskilled her fingers, they will twitch to hold a pencil, even though the poor results are made but for ridicule or destruction. If she has a camera, to the enjoyment it will afford there is no end. She will find flowers too new and charming to be thrown aside, and the old books and magazines will press them. Then the dried blossoms will require mounting. In one season I pressed over 70 varieties of wild flowers that sprang, each apparently from the ashes of the last, near our camp. There are whole days for reading and writing, while one rests from a hard tramp; and from all these things the attention will wander to the interesting animal life about.

In our first camp I once pretended to read, in order to watch the maneuvers of a chipmunk with a taste for gingersnaps. Softly he crawled down to the cupboard—a soap box nailed to a tree—watched his chance to slip over the side and break the paper bag that held the dainties, seized one and started up the tree, only to be met, all too soon, by an obtrusive twig, that dashed the treasure from his teeth to the ground.

Over and over he tried this, until he at last solved the problem by eating his way nearly to the center of a gingersnap, where he got a sufficiently firm hold to convey it safe to his home.

Like the chipmunk, the human dweller in the woods soon discovers how much or how little native genius he has for making much of his small materials. He learns what excellent shovels can be made from a cleft stick and a flattened tomato can; that an ideal refrigerator is a box with a small opening at each end lowered half its depth in a brook. Of course once in a while the cook may find Madame Snake taking a nap in its shelter; but if the cook be a woman she will soon learn to cover her dishes closely, and the poor snake will slide down the stream as soon as she is discovered.

That Eden of ours was unlike the original in that respect. Mention is made of but one serpent there. We killed in our yard about one every other day for 3 months, the first spring we were in the house. Where they had been the 2 seasons before, when we had no shelter, no one knows; for one August we used to go hunting them several miles down the lake. To start out deliberately for a rockslide to see how many rattlers one can get in an afternoon is a different proposition from having them shot in the path, within 3 feet of one's door, especially when one happens to be settled on the doorstep for an afternoon's reading. It was the only life we made a habit of taking. We fished only enough for our needs and those of a friend down the lake. In the warmer months the trout all seek the cool depths of the upper lake. When we occasionally needed fresh meat the men brought down venison from the rocks and valleys above us; and a pair or 2 of goat horns came in one early spring as trophies. The pretty creatures we came on while rowing close to the shore at twilight just raised a horned head and looked at us with large, startled eyes before quietly trotting off up the gulch, with now and then a look around, until we were out of sight. Then father would rest on his oars and say, "How could any one shoot that!"

What I always looked for and dreaded I never saw—a bear—though we came on fresh signs of monster bears more than once, and the bark torn off a dead tree seemed scarce an hour old. Bruin in the National Park, that stole our bacon at night, was all I heard, and the pet cub in a rancher's dooryard, now and then, all I saw.

The last year I was in camp I saw that grandest and most appalling of sights, a forest fire. For 4 months I had looked across a mile of water to the base of "Old Sawtooth," and had let my eyes wander up

its cliffs and ravines beyond the timber line to where the snow lay all the year, 11,000 feet straight up and above us. The altitude of Lake Chelan is not more than 1,000 feet. I had learned to love each patch of timber, and where to look for the heaviest growth of syringa. One August day a careless woodchopper turned all this beauty into a seething, crackling sheet. For a week our eyes and throats were burned and dry. We felt the heat across the lake and the air was full of cinders. At night the fire was awful in its fascination, creeping relentlessly on and up and along, run-

ning up the height of a great pine till the tree stood like a torch, and then, with a crash was only a part of the rest. That fire crept on and burned in spots, to be seen at night, until the first rains, 5 weeks later. When the worst was over, our beautiful mountain was blackened and bare in large patches, with a white crown its only glory.

Soon after that we went back to the world of men, and only in dreams have we seen our camp home since then; but the memory of it only grows dearer as the hope of seeing it again grows each year less.



AMATEUR PHOTO BY J. E. TYLOR.

TO THE VICTOR BELONG THE SPOILS.

One of the Special Prize Winners in RECREATION'S 7th Annual Photo Competition.
Made with Manhattan Camera.

A NEW HAMPSHIRE COON HUNT.

E. H. HUNTER.

Some of these critters that's ben huntin' coons around here the last 2 er 3 years are enough ter make a feller that knows anything about the business sick an' tired. I've heered 'em say so much about it that finally I went out one night jest ter see 'em maneuver. They hunted all over 2 er 3 towns with a pack of dogs, an' chased rabbits, skunks an' patridges 'round through the woods an' fields a'most all night, an' finally did manage ter git one coon. From what I see of these coon hunters that night they haint ary one of 'em has got the brains of a guinea hen. Ter begin with, they haint got any dogs that's worth leadin' home. I'd a gin a \$50 bill ter seen my old dog dropped down inter Bill Jones's corn field that night jest as good as he used ter be. The'd ben coons thar. I could tell by the actions; but the dogs couldn't seem ter trail 'em out any better 'n a pack of bull dogs. I'll bet a ton of hay agi'n a toothpick that my dog would 'ave took the track an' treed coons from that field inside of 10 minutes. I mean the one that I sold ter Clarke, of Manchester. Didn't I ever tell you about 'im?

Waal, yer see, John B. Clarke that used ter run the Manchester Mirror was an awful hand ter hunt coons, an' somehow er other he'd heered that I had a good dog. An' he come right up ter see about it. Now it happened so that I couldn't go out with 'im that night, an' he couldn't wait any longer, 'cause he was in a hurry, so I got Ab Parmelee ter take the dog an' go out with 'im. Yer see Ab had hunted so much that he knew the ins an' outs of the business as well as anyone, fer he an' I had ketched from 50 ter 75 coons right along, season after season, an' besides, old Sport seemed ter kind er take ter him.

Waal, they took the team an' along about night started out toward the Unity hills. An' it seems that all the way out thar Clarke kep' tellin' Ab about coon dogs he'd hunted with, an' how some on 'em would hunt all right, an' tree their game all right, but onless he was right thar pretty quick, they'd quit the tree an' come back ter him. An' that what he wanted was a dog that would stick even if the hunters didn't git thar fer an hour er 2. Of course that was all right, fer if a man goes among strangers ter buy a horse er a dog, he's supposed ter know what he's lookin' for, an' has got a right ter be pertickler. An' I've seen them that was a durned sight more fussy about such things than they

was when they went ter pick out a woman ter be their pardner fer life. They'd look up a hound's pedigree back fer 25 years ter see if thar was any yaller streaks anywhere, an' the dog would have ter be shaped jest so, an' be marked jest so, an' be jest such a kind of barkin' dog, an' have jest so long ears, an' such a shaped foot, an' so on; an', by thunder, them same men would pick ont a whinin', fussy, crosseyed woman that would talk faster an' louder than any hound ye ever see would bark a runnin' by sight. Yis, an' when they got wound up, an' got ter goin' on, 'twant no use ter talk back, fer they'd tree a critter less'n a minute an' they'd stick, too, you bet.

Anyway, Clarke said so much about the dog stickin' that it sort of riled Ab. He's a kind of odd critter, yer see; an' when he's riled he's contrary as a prayin' deacon in a hoss trade. Waal, they drove out toward Unity an' the dog struck out fer the hills an' disappeared, an' Clarke an' Ab went up on ter the side hill an' found a good snug place an' set down in a holler among some spruces, an' visited an' told huntin' yarns fer quite a spell. Bimeby Clarke got uneasy about old Sport's not comin' back, an' begun ter ask if it want likely he'd gone back home, er whar the deuce he had gone ter anyway. He didn't git much satisfaction out of Ab, you bet. Finally, he asked Ab about a dog that they could jest hear barkin' a long ways off; an' what dog he s'posed it was. It sounded like some farmer's watch dog, an' they'd heered it fer more'n an hour. Now you'd better believe he was a trifle surprised when Ab told 'im it was the old coon dog.

"What's he barkin' at?" said Clarke.

"A coon, of course," says Ab.

"Well then," says Clarke, "why in blazes don't we go over thar an' see about it?"

"Oh," says Ab, "thar's no hurry; s'pose we wait a while ter see if he'll stick."

Thar's whar Ab had 'im, fer he'd heered Sport barkin' all the evenin' an' was jest that contrary that he was willin' ter wait all night ter score a point in the game. Yis, that's Ab all over when you rile 'im. Pretty quick they started over ter whar the racket was, an' after quite a tramp found the dog barkin' at a hemlock about a foot through at the butt. He'd got his game up a small tree. That was one of his strong points. Yer see, when he struck a track he never'd yip, but would run it like fury until he treed before he'd bark once. Some dogs 'll bark on the track an' that

tells the coon they're comin', so Mr. Coon either puts it fer a hole in the ledges er else picks out the biggest tree within a mile an' goes up it. You can bet yer bottom dollar the coons know whar all the big trees be, too. This dog didn't give em a chance fer any funny business, an' sometimes he'd put 'em up a saplin' not more'n 3 inches through.

Waal, as I said, they found Sport barkin' up a hemlock, an' he was fussin', an' walkin' 'round it an' every now an' then puttin' his fore feet up on ter the butt as high as he could reach, an' waggin' his tail ter beat all, but never once takin' his eyes off the tree. Oh! He was a good one, I tell yer, an' it makes my old blood feel good jest ter think of 'im.

Waal, Ab clim the tree, up 'mongst the limbs out er Clarke's sight an' then hunted the tree over an' found the coon. Thar was a brush fence jest at the foot of the tree that seemed ter worry Clarke a good deal fer he thought mebbe Ab would shake the coon off an' the dog be on one side the fence an' the coon light on thother, an' then git a good start an' like as not git away from the dog inter the ledges; fer he'd seen 'em do it. So he hollered an' said:

"Can ye see 'im?"

"Eeup," says Ab.

"Which side the fence 'll he strike on?"

"I dunno," grunted Ab, mighty short.

"Wall, hadn't we better find out an' git the dog on ter the right side?" says Clarke, kind er easy like, fer he begun ter think he'd struck a queer combination of man an' dog.

"Y-o-u l-e-t t-h-e d-o-g a-l-o-n-e a-n' d-o-n't t-o-u-c-h 'i-m," says Ab, in a way that meant business.

Jest then he fired his revolver an' the coon went down through them hemlock limbs makin' more noise than a house fallin'.

"Did Sport git 'im?" yelled Ab.

"Git 'im," says Clarke, "the coon struck right in his mouth."

Then pretty quick he begun ter look ter see if he could find whar the bullet struck, but he couldn't, an' hollered an' told Ab so.

"Mebbe," says Ab mighty slow an moderate, "Mebbe," says he, "that I hit 'im in the eye," an' Clarke looked, an' found one eye was gone.

"Waal, waal, sure enough you have, by hokey!" says he. "Waal, ef that don't beat all, by hokey!"

After Ab looked the tree all over an' found thar want any more in it, he come down an' skinned the coon an' got ready ter move on again, fer he knew the dog could find some more; but Clarke said no, fer he'd seen enough ter satisfy him, so he was willin' ter go back ter town.

He told me all about it next day, an' said Ab was a queer feller; but, said he'd like ter go huntin' with 'im right along, fer, he said, he never enjoyed a coon hunt any better in his life.

"An," says he, when he told me about the coon bein' shot in the eye, "I've been thinkin' it over, an' have made up my mind that he knew all the time after he fired that he'd hit 'im in the eye."

He was right, fer Ab would git his bulls-eye ter strike a coon's face jest right, an' then fetch 'im in the eye a' most every time.

Waal, ter make a long story short, Clarke bought the dog, an' once after that I see 'im an' he told me that he took 'im down in Maine an' got 15 coons with 'im the first 3 nights. Says he:

"Do you know, I didn't believe half what you fellers told me about that dog, but he's a better dog than you said, fer I thought I'd seen coon dogs before, but I never had."

Oh! He was a rippin' good one, an' you might look fer 30 year, an' not find another like 'im.

What made me sell 'im? Waal, don't yer fergit one thing, I got a mighty good price fer 'im. I sha'n't say how much fer ef I did, mebbe you might not believe it.

"Do you believe that egotism and genius go together?"

"Not always. There would be a lot more genius if they did."—Judge.

A COON HUNT IN PENNSYLVANIA.

CHAS. H. WEAVER.

One warm afternoon of March, '96, George and I stood at the foot of what had once been a lordly black oak, 3 miles from Bethlehem, Pa. The tree was 2 feet in diameter and much decayed, only 30 feet of it still standing. It was without limbs, and near the top was a large hole. As we looked at the hole I remarked that it might be worth a climb. A few minutes later I was at the top, peering down into the hollow. Two feet from the mouth lay a large, snarling raccoon. Believing there were young with the big one, I asked George to bring me a chunk of wood to choke the opening above our game, and determined to capture them alive. George brought part of a stump, which I carried up and used as a plug at the opening.

With my little hatchet I cut a hole at the level of the coon, making it only wide enough to admit my hands. However, I took no liberties. I had a healthy regard for the snarling prisoner inside, who, with gaping mouth and shiny teeth, watched my motions. I soon made out the presence of 2 young, hairless and squirming, nestled under her. George gave me much encouragement with his mouth, but declined any active participation in the capture, leaving all the glory to me.

Introducing through the hole a strap with a noose I managed, after many failures, to lasso the coon, catching her around

the neck. To do this, clinging to that half decayed bark, and to hold her while I climbed down, using only one hand for clinging and my climbers for descending, was no easy job, for I was obliged to hold her at arm's length from me and from the tree; but it was at last safely accomplished.

I crowded her, half strangled, into a bag, which we tied, and we then had her safe for carrying. The baby coons I tucked into my coat to keep them snug and warm.

We placed the little family in a tin-lined box, where the babies soon became interesting pets, tame and contented; but the mother never lost her ferocity. She began a course of daily baths for her babies when they were 2 months old. I sometimes feared she would drown them in her earnestness, but she never did. All her food she washed before she would eat it, even rolling unbroken eggs about in the water before beginning her feast on them.*

After keeping the coons a few weeks I gave them to the late Dr. Detweiler, of Bethlehem. For a time they furnished him much amusement, but one morning they got out of their cage. One ate some soap lye in the next room and died there. The others disappeared.

*The coon always washes his food, even if it be obtained from the water, as in the case of crawfishes. If food be given him in captivity when water is not at hand, he goes through the motions of washing, then wiping it on his fur.—EDITOR.

IT MIGHT HAVE BEEN.

EDWARD BOURNE.

Is there aught so annoying or less worth
enjoying,
While you're overhauling your last summer's
load,
Mid direst confusion and hopeless profusion,
In trunks and tackle boxes where everything's
stowed;
While you ransack and rummage your last
season's dunnage,
And work like a beaver in spite of your
gout,
To find in the lining of your rain coat re-
clining
The hooks you can swear would have
saved that big trout?

NED BUNTLINE'S RAQUETTE RIVER BASS.

J. F. CLOSSON.

When E. C. Judson, the novelist, better known, perhaps, as "Ned Buntline," was living on the Raquette, in a cabin of his own building, Mr. Sidney Robbins was for a time his companion. In after years Mr. Robbins was fond of telling of their adventures in the wilderness. Having heard many of his stories I can vouch for their interest, if not for their authenticity. Mere mention of the name of his distinguished friend was sufficient to start the old gentleman off on a fresh narrative. One lead of mine in that direction was rewarded as follows:

"Judson and I," said Mr. Robbins, his brow furrowed and eyes half closed in an earnest effort to recall facts, "went down the Raquette one day and took along a pail of minnows and another of worms. Jud swore he would catch every fish in the river, but what he would have enough for a good dinner. We rowed a mile up stream, got the boat nicely anchored, and waited for a bite. Perhaps half an hour passed without incident. Then Judson sprang to his feet and began pulling in his line. It came slowly, though I could see Jud was putting all his muscle into the business. Presently there was a great surge at the end of the line, and the water boiled and foamed furiously.

"I've got him, all right," cried Jud, as a monster bass came in sight, "and he's the father of all fish!"

By main strength he hauled the big fellow alongside. We both grabbed him and despite his frantic struggles, fairly scooped him aboard. He was so big that we decided to call the sport off, and started for shore, reaching it in a few minutes. The fish lay quietly in the bottom of the boat, but when we attempted to lift him out trouble began and continued. Almost the first flop of his tail knocked me backward over the stern of the boat. When I got my head above water there was a royal melee in progress. Jud's hat was

floating down the river and he was making furious but futile grabs at his flopping opponent, meanwhile swearing hard enough to frighten an ordinary fish to death. I rushed back to the fray and wound my arms about the bass in a close and slimy embrace. Judson tried to settle the trouble by batting the fish over the head with a wooden bailing-scoop. One blow was so far misdirected that it took me squarely in the chest. Again I went overboard, taking the fish with me. Fortunately I fell on the old fellow and succeeded in pinning him to the bottom until Judson came to my assistance. We got him into the boat, which was by that time cleared of seats, oars, bait-pails and every other movable, and from there we carried him ashore.

"As the bass appeared thoroughly spent we left him on the ground while we went to recover as much of our property as had not sailed down stream. Returning with our salvage, we looked in vain for our prize. It was nowhere to be seen.

"Well, great Cæsar!" cried Judson, gazing up and down the shore. "This is a mysterious affair, isn't it?"

"Where the dickens could he have gone?" I said.

"Bust my jib-stay if I know," replied Judson: "I've clean lost the point o' compass. Turn to leeward, Sid, and cruise the bushes. That son of a shark can't have gone far."

We finally found our catch in a little pool at the river's edge, 25 feet from where we had left him. He was so completely exhausted that he made no resistance when I picked him up and shouldered him. We got him to the cabin and weighed him. The scales tipped at just 40 pounds, 4 ounces."

"Well," I exclaimed, "that was a monster, indeed!"

"Y-e-s," said the old gentleman, reflectively, "he was pretty big; but Judson and I caught some bigger ones."

Edith—Mertie says she intends to learn to skate this winter.

Marie—But she learned last winter.

Edith—Yes; but she broke her engagement to that fellow.—Exchange.

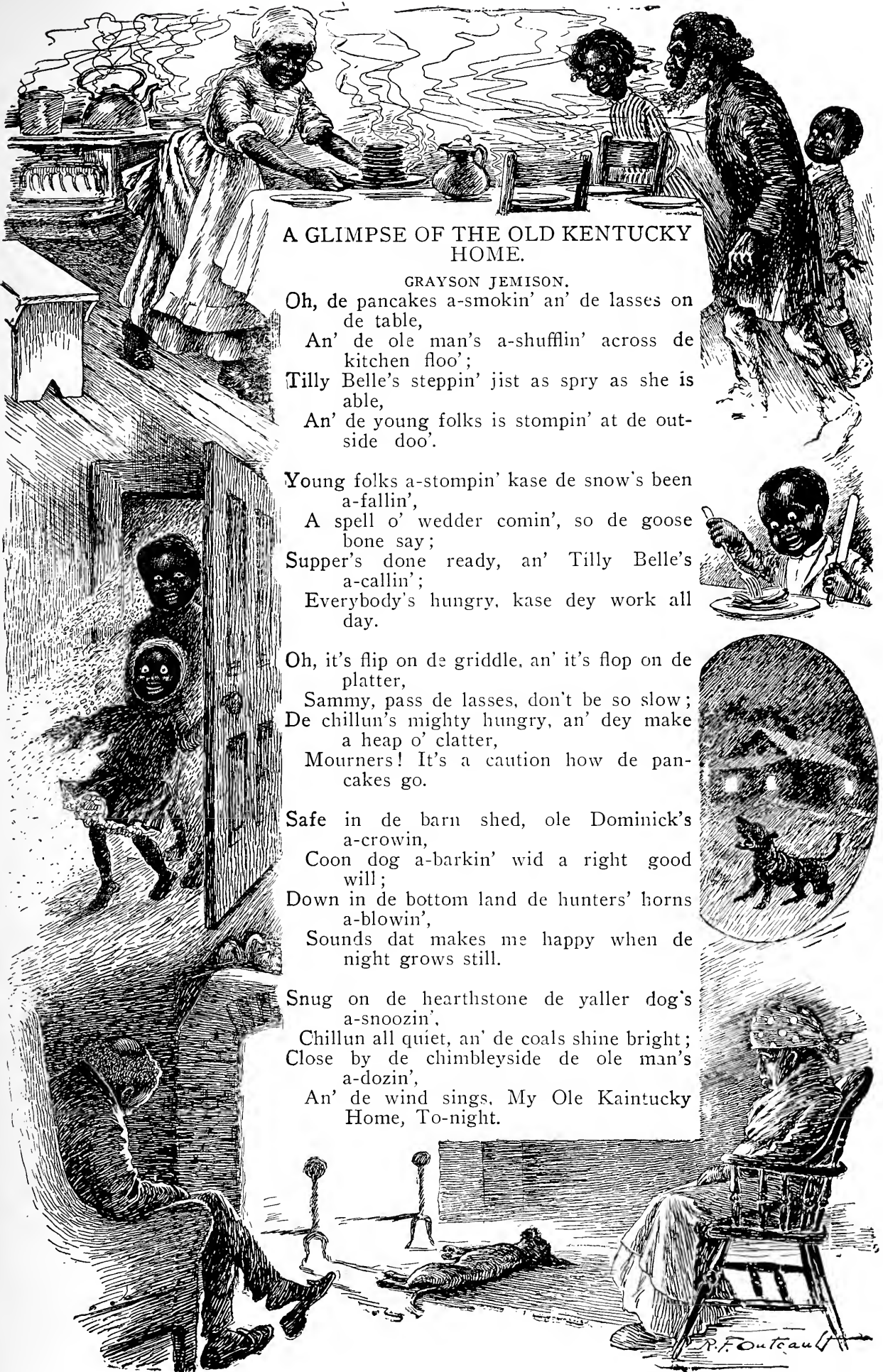

A GLIMPSE OF THE OLD KENTUCKY HOME.

GRAYSON JEMISON.

Oh, de pancakes a-smokin' an' de lasses on de table,
 An' de ole man's a-shufflin' across de kitchen floo';
 Tilly Belle's steppin' jist as spry as she is able,
 An' de young folks is stompin' at de outside doo'.

Young folks a-stompin' kase de snow's been a-fallin',
 A spell o' wedder comin', so de goose bone say;
 Supper's done ready, an' Tilly Belle's a-callin';
 Everybody's hungry, kase dey work all day.

Oh, it's flip on de griddle, an' it's flop on de platter,
 Sammy, pass de lasses, don't be so slow;
 De chillun's mighty hungry, an' dey make a heap o' clatter,
 Mourners! It's a caution how de pancakes go.

Safe in de barn shed, ole Dominick's a-crowin,
 Coon dog a-barkin' wid a right good will;
 Down in de bottom land de hunters' horns a-blowin',
 Sounds dat makes me happy when de night grows still.

Snug on de hearthstone de yaller dog's a-snoozin',
 Chillun all quiet, an' de coals shine bright;
 Close by de chimbleyside de ole man's a-dozin',
 An' de wind sings, My Ole Kaintucky Home, To-night.

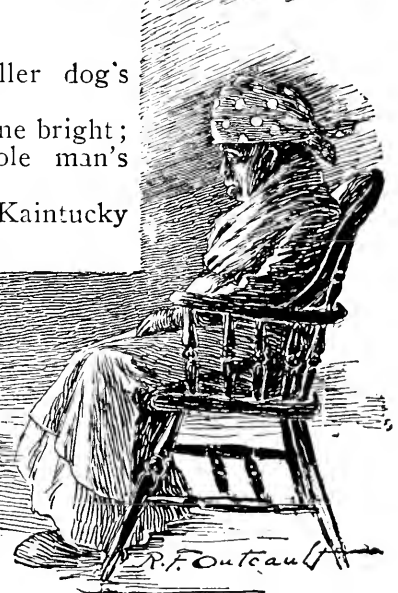

A FLORIDA KID ON A CAMP HUNT.

CHARLEY APOPKA.

IX.

'Way before day nex' mornin' Uncle Dick an' me wuz up an' on our way ter th' turkey roost. Th' day star wuz jest over th' tops uv th' trees, an' hit wuz shore th' brightest I ever seen. I love ter git up soon uv a mornin' when I'm in camps, an' see th' day star a shinin', but when I'm home I aint that way. There wuz a heavy dew on th' grass an' we got wet to our hips, an' hit wuz cold, an' I woulden fool yer. When we got in th' hammock thought wuz dry, 'casion uv th' trees bein' so thick overhead, hit wuz so dark we couldn hardly see our way. An, as we wuz a goin' 'long somethin' jumped out uv a low crooked live oak, an' went a tearin' off 20 feet to a kick. I sez "O-o-h-h!" an' Uncle Dick sez, "There goes a dinged ole catermount." Hit made chills run down me ter think s'posin' he'd a waited till we got under 'im, an' then dropped onter my neck an' went ter kickin' my close offen me with 'is claws.

One time, when pa wuz a young man, him an' some other men wuz a cuttin' cord wood in th' flatwoods, an' had 'em a little camp by a branch, an' they wuz a trail went down th' bank where they got water. One evenin' they come in twix' sundown an' dark, an' one uv 'em grabbed a bucket an' went down th' trail an' direckly they hearn 'im a squallin', "Help, boys, help; bring yore axs, they's a panter got me." They dashed out ter help 'im, an' th' varmint tore out when it seen 'em a comin'. Hit wuz a wild cat, an' th' feller sez when he went under a live oak that growed over th' trail, th' drotted critter dropped astraddle uv 'is neck, an' went ter clawin' like hit wuz gittin' paid fer hit. Hit weren't on a half a minute, but hit scratched 'im up scandalous, an' ruint 'is shirt. Pa sez he reckoned th' feller come under hit so sudden th' devilish thing didn't know what else ter do, an' lit on 'im an' went ter fightin'.

When we begun ter git clost ter where th' turkeys wuz, we went mighty easy, an' I wuz a strainin' my eyes inter th' tree tops an' firs' thing I knowed I hung my foot in a grape vine, an' fell down kerwop, an' made a turrible fuss, an' en old turkey sez, "prut," right over our heads. Doggone my cats if I weren't th' excitedest I ever wuz; but I managed fer Uncle Dick not ter know hit. By that time hit wuz a gettin' light in th' East, an' d'reckly we seen 3 big ole turkeys settin' on a limb, an' by grannies, they looked as big as yearlins

ter me. Uncle Dick whispers an' sez fer me ter git a good sight on 'em an' pull down, an' if I missed 'em he'd try an' git one. But hit wuz so dark till I couldn sight my gun. When I'd look at th' turkeys I couldn see th' sight, an' when I looked at th' sight I couldn see th' turkeys, so I had ter wait a little. Look like day come th' slowest I ever seen, but d'reckly hit got right, an' I poured hit to 'em with 'bout 4 thimblefuls uv turkey shot. My ole gun shore throws them blue pills, and at th' crack 2 uv 'em come a crashin' ter th' dirt, an' a lot more flew down that we hadn't seen. I let out a howl, an' Uncle Dick sez, "Hooraw fer you, Bud, 2 at a drag aint bad!" One uv 'em laid on th' ground an' jest give 'is wings a bat 'casionally, but th' biggest one, which wuz a gobbler, wuz a jumpin' round like a hen with 'is head cut off. I wuz afeared hit 'ud git away, so I throwed myself on 'em. Uncle Dick hollered, "Turn 'em loose, he'll tear yore close." But I wouldn a loosened 'im if he'd a had teeth like a 'gaitor. I rastled 'im in th' leaves till he wuz dead, but he hit me in th' face with 'is wings, an' blooded my nose. Doggone if he weren't th' strongest I ever seen. Well, sir, I wuz shore th' proud boy, an' I woulden fool you. I looked at 'em an' hefted 'em, an' I'd a give a purty if Ma 'n sis could a seen 'em, an' a had one ter eat.

We lit out fer camp, an' it look like th' squir'ls was th' thickest an' the sassiest I ever seen. Look like they knowed we didn't want 'em that mornin'. When we got ter camp Mr. Sam sez I wuz a hunter from way back. Pa never said much, but I could see he wuz mos' as well tickled as I wuz. They set out fer th' traps d'reckly after we come, an' Uncle Dick an' me went ter cleanin' th' turkeys. We cut up th' least one, an' throwed hit in th' pot, an' stuck fire to hit, an' had 'er a bilin' in less'en no time. I taken th' hearts an' livers an' fried 'em, an' they wuz shore fine. When th' ole turkey began ter git tender, Uncle Dick made up some dough, an' as soon's pa an' Mr. Sam come in sight he put hit in th' pot an' cooked up th' finest mess uv dumplins you ever seen. We taken th' pot offen th' fire, an' set round hit an' helped ourselves, an' by gracious, I never seen anythin' any better. The broth wuz jest like gravy, an' you bet hit wuz good. Pa brought back 5 coon hides, an' soon's my dinner got settled, I nailed 'em to trees, an' took down some

that wuz dried. 'Bout 3 o'clock pa split th' big gobbler in 2, so hit 'ud go in our bakin' skillet, an' put a little water in with hit, an' set hit on th' coals. He kep' a little water in hit till hit began ter git tender, an' then he taken some thin slashes uv bacon, an' laid on top uv th' turkey, an' let the water cook nearly out, an' when th' meat wuz nice an' brown, he taken hit out an' put a little flour in th' turkey juice, an' made gravy that 'ud make anybody water at th' mouth jest ter smell hit. By that time Mr. Sam had a pan uv biskets cooked up, th' purtiest I ever seen. Ever' one had a little brown spot on top, jest alike. We set down to hit a little after dark, an' I won't say much 'bout it, cause I've done talked too much already 'bout eatin', but I'm bliged ter say hit jest natchelly laid over anythin' I ever set down to before.

After supper they got ter tellin' huntin'

tales. Uncle Dick sez one time when he was 'bout 16 er 17 him an' another man wuz a trappin' an' one day they wuz a paddlin' up a creek through a big hammock in their canoes with th' other feller in th' lead. That feller happened ter see an ole buzzard a settin' on a limb, an' bein' a sorter funny feller, he grabbed 'is gun an' shot th' buzzard, an' hollered, "I've shot a turkey! I've shot a turkey! hurry, Dick, an' git 'im. He's only crippled." Uncle Dick sez he like ter busted hissself a paddlin' ashore an' a dashin' up th' bank, an' when he'd busted through th' bushes, there weren't nothin' but an ole turkey buzzard. Uncle Dick sez th' feller like to have killed hissself a laughin', but pa sez hit wuz a shame ter kill th' pore ole buzzard fer nothin'. Pa hates ter see anythin' killed that ain't uv no use. I went ter sleep studyin' 'bout turkeys, an' dreamt I killed one big's a steer.

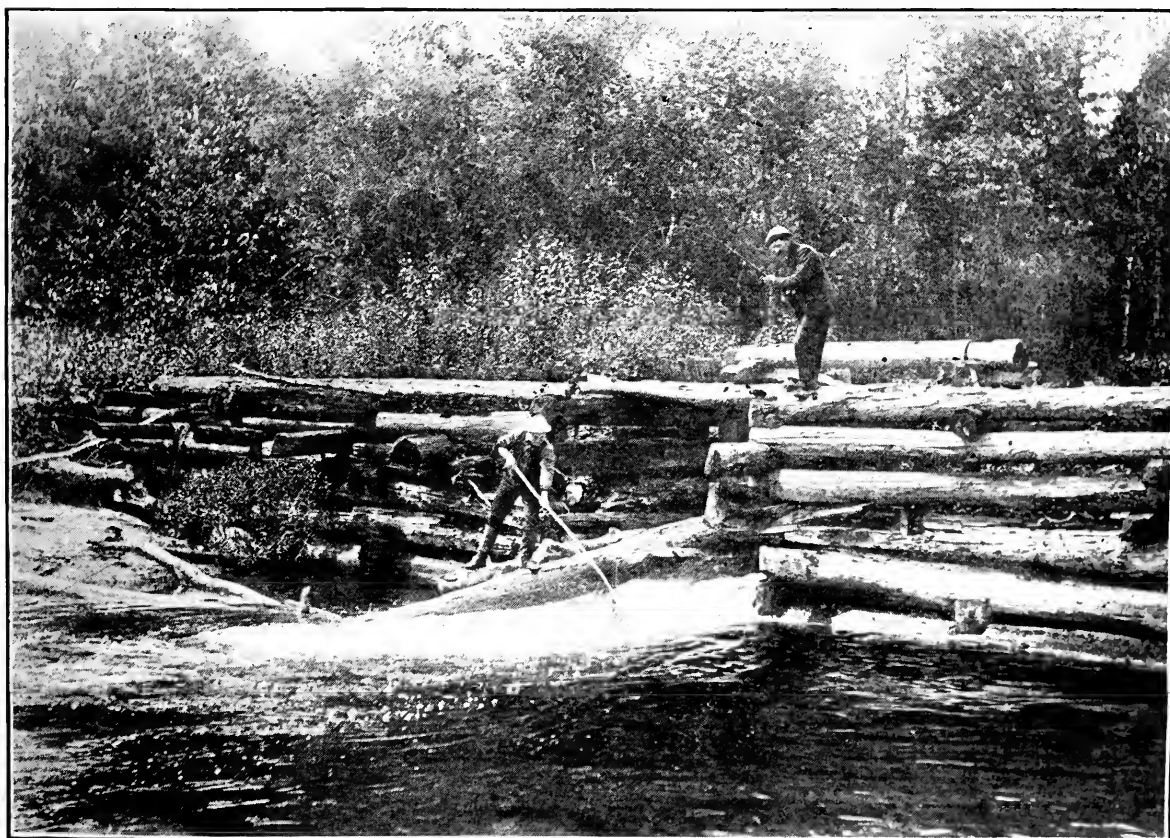

AMATEUR PHOTO BY R. C. W. LETT

WATCH YOUR CHANCE NOW!

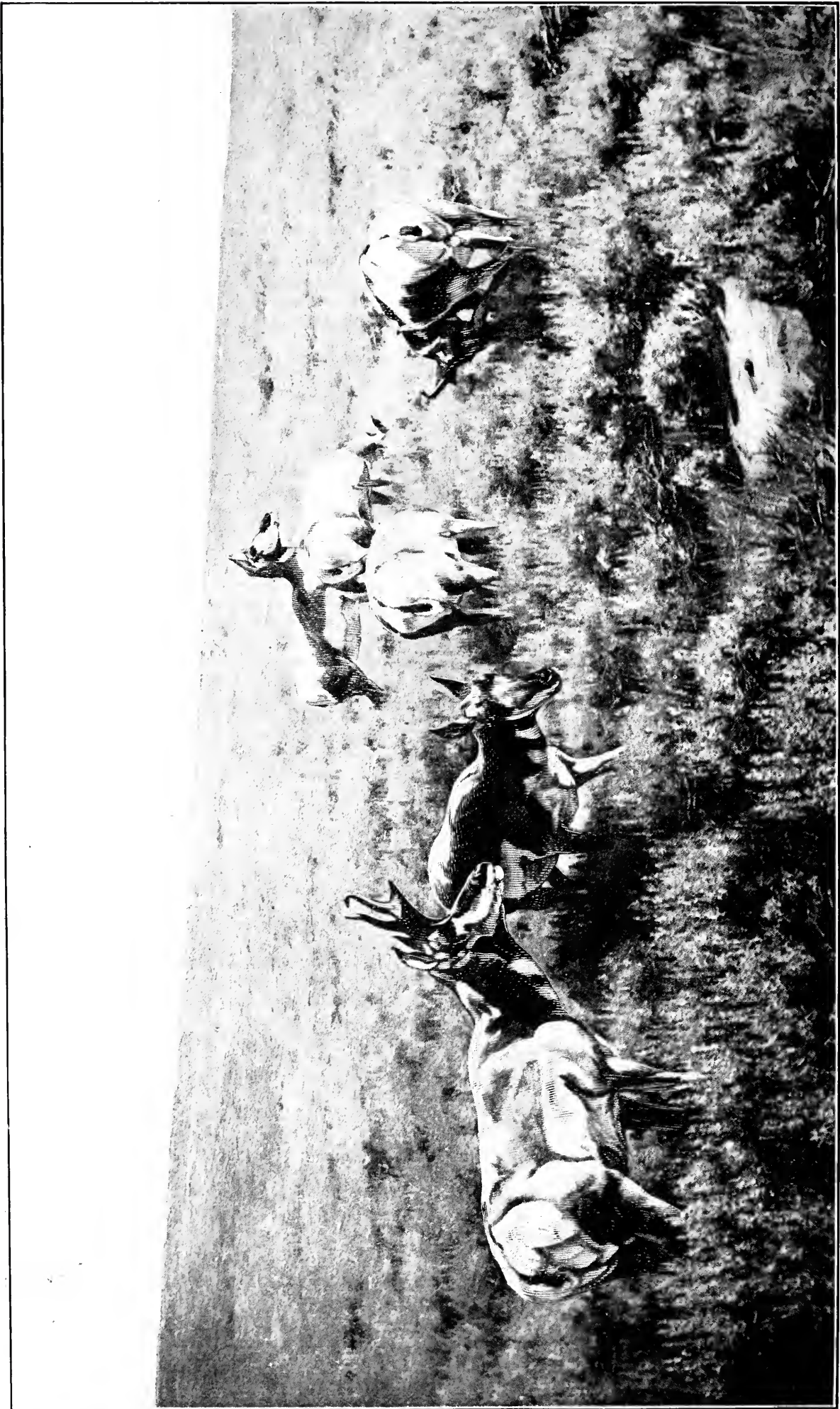

FROM A PAINTING BY CARL RUNGUIS.

IF THAT BUCK GETS AWAY MRS. WHITE WILL BE A WIDOW.

AMONG THE PRONGHORNS.

B. R. BEYMER.

It was nearing the middle of October, and the open season on antelope was drawing to a close, when my friend, A. C. White, and I started out to hunt for antelope in the sand hills on the Apishapaw river, 30 miles Southwest of Rocky Ford. After a long drive we reached the prospective hunting grounds. As we pulled up to the spring, our old camping ground, we found a party there who had had no success, and had decided to break camp and go home the next morning. We knew they had not found the antelope range and were glad of it, as our game would not be so wild if left undisturbed. We looked wise and kept mum, stretched our canvas and got supper.

We rolled in early and it seemed to me I was hardly in bed when I heard the other outfit getting breakfast. We soon had our breakfast on the smoke and when it was disposed of we saddled our ponies and made for the hills.

We had only gone about 2 miles from camp and were riding leisurely, not dreaming game was near, when to our right, about half a mile, I saw the sun glistening on a big herd of antelope. I tumbled off my horse and it didn't take White long to get next. He had not seen the game, but he smelt it. I told him what I had seen; we tied our horses and proceeded to investigate.

I surveyed the hills and valleys between the herd and us and picked out a course. We then made off through the low places with silent tongues and beating hearts, and soon reached the hill behind which was the game. I peered over and found they had fed South about 150 yards. I had marked them exactly.

I looked the herd over, and, to my surprise, I knew them. For 3 years had I seen their leader on different occasions, and had longed to draw my ivory bead on his breast. The opportunity had arrived.

I crawled back to White and motioned to him to follow me. When I had crawled up even with the bunch I stopped and whispered to White: "There is a buck over this hill as big as a cow. I have been trying for 3 years to get his head. I shall let you have the standing shot, and if that buck gets away, Mrs. White will be a widow." White grinned. He arose and I showed him his target.

I knew the buck was doomed by the way White's eyes glistened. It was an awful moment, but it was too good to last longer. White took careful aim and fired. I was

on my feet in a second and at first thought he had missed. The big buck started to run and I threw down on him intending to fix him the third time he hit the ground. He took 2 jumps as if untouched, but the third time he went up I saw him wilt. I knew White's aim had been true and instead of shooting him I turned and bored another buck which was showing us a cloud of sand mixed with hind feet and legs. My aim was true and I saw him stumble. I shot twice more but failed to down him. White's buck had left the bunch and stood on a little knoll, watching us, too weak to run away. I saw my game leave the rest and I knew we had him also. In the meantime the big buck had fallen and we went to him at once. We dressed him, dragged him to a big cactus and tied a handkerchief to it, so we could find him later. Going to where I saw my buck leave the herd, we flushed him from a little gully, and shot several times at him, but he went on. There in council we decided that White should follow the antelope and that I should cut in ahead and kill my buck, as I knew about where he would cross the hills.

I had got nearly to where he should cross when I almost stepped on a big rattlesnake. I stopped to kill it and while thus engaged the antelope passed about 200 yards ahead of me. I got to the top just in time to see him go into a big ravine about a quarter of a mile away. I waited until White came up and we made for the hill. I crawled up to the top and peeped over. There stood the buck, looking back to where we had been. I rested my elbow on my knee, held about 6 inches over his back and fired. He sprang into the air and fell on his head.

White stepped the distance, 290 yards. I struck the antelope on the hip and the ball went through him endways. We found that my 38-70 had broken a shoulder the first time I hit him. We dressed him and were quickly in camp. Dinner over we drove the wagon out and got our meat. We dreamed of antelope all that night, but early next morning were off for home, satisfied with our luck.

We reached home about 24 hours after the other boys and sent each of them a steak. White had the grandpa of those 20, and a prouder hunter never lived, as he hung the big fellow in a tree at home. White has since had the head of the big buck mounted and it is the largest head in these parts.

A CAMPING TRIP IN ARGENTINA.

L. S. MC CAIN.

If any of the dear readers of RECREATION wish to vary the dull monotony of existence, regardless of consequences, let them betake themselves to the sub-tropical regions of South America, and after experiencing the petty annoyances of bandits, snakes and yellow fever, return to the swamps of Arkansas, where a higher civilization prevails, and only mosquitoes serve to sustain one's interest in life.

Mr. J. K. Riffel and I started from Buenos Ayres with outfits and guides to accumulate specimens, fun and experience, our destination being the boundary between Bolivia and Peru. After a few days' travel, we met 3 Americans, all that remained of a large party who had gone into Bolivia after gold, some months previous. All the others had been killed by the Indians, who attacked them shortly after their arrival. The Peruvian government sent 20 men to explain to the Indians the errors of their ways, but the messengers were never afterward heard from.

Our guides, being good Christians, naturally objected to taking human life unnecessarily, even an Indian's; so when they heard of this state of affairs they quietly stole away by the light of the moon, with a cargo of our spare bedding, guns and ammunition. Not a man in Argentina could we find to go into Peru or Bolivia, except one Irishman, Pat, who informed us that the greatest trouble was to procure sacks large enough to hold the gold, which was lying around loose in large nuggets.

"Pat, what brought you to this country?" we asked.

"Strength of body and weakness of mind," he replied.

As we could not obtain more men, we reluctantly turned our steps toward the pampas of Western Argentina. After some days of railroad, horseback and boat travel, we reached the Colorado, a magnificent stream bounded by vast plains of sand or grass, with some timber near the hills and

spurs of the Andes. Game, of limited variety but in great numbers, abounded, among which were the guanacho, an animal resembling a small camel, minus the hump; deer; hares, or rabbits; armadillos; lions, or pumas; and occasionally wild cattle; all of which furnished us a valuable collection of skins and heads. Small furbearing animals are plentiful farther South, in the Patagonian regions, and several Americans are doing well in the trapping and hunting business.

We pushed South, following the Eastern slope of the Andes, a country of unbounded mineral resources, animal life, and timber and thousands of lakes, of wonderful depth, containing fishes of great variety. As there are absolutely no means of transportation or communication, the enormous wealth of this region will not for many years be opened to civilization. Sheep and cattle furnish the wealth of the country, as they require no feeding, and little work. Even some of the Pampas Indians possess thousands of sheep and cattle, but not realizing their wealth, continue to live in dirt and squalor, allowing their herds to grow wild, or be confiscated by an occasional white man with an eye to business and an elastic conscience.

At present our encampment is near a small lake in Rio Negros. As I write this, on a boulder overlooking the water, I can see the fish playing at a depth of 20 feet; and a few hundred yards out on the plain a herd of deer are grazing, oblivious of human presence. From here we will go to Punta Arenas, Chili, spending a year or 2 in short trips to Terra del Fuego and the neighboring islands.

Buenos Ayres has a zoological garden far superior, both in numbers and variety of animals, to any in the States. Any stranger contemplating a Southern trip will find it advisable to bring his entire outfit from the States, and to keep his money in his boots, to avoid awakening in the natives an undue eagerness for his company.

St. Peter: Where did you come from?
Arrival: I jumped down from the roof
of a New York office building.—Life.

MERRIMAC BAIT CATCHING.

GEO. L. WHITMORE.

Ever since fishing vessels have sailed from the ports of Massachusetts, the Merrimac river has been an important source of supply for bait. In olden times salted clams and porgie slivers were much used, but since the introduction of cold storage the demand is for fresh fish, though some skippers still cling to their "hammer bait," meaning cockles, which they strike with a hammer before placing on the hook, that being the only kind of bait a dogfish will not touch.

As the schools of bait, alewives, bluebacks, porgies, and herring, migrate along our coasts, they enter the Merrimac, and are kept there by dogfish and pollock at the river's mouth. After the migration has passed and the weirs and pounds are empty, bait can still be caught in the Merrimac.

Many methods are employed in catching fish. The purse seine plays an important part, especially in the capture of mackerel. The mesh net does its share in the general destruction of fish life, whether it be placed at the bottom or the top of the water; but the principal method is with the old fashioned, baited hook.

A little black steamer, loaded with herring, passes from vessel to vessel in Gloucester harbor, supplying them with bait. Let us get aboard her, go over to the Merrimac river, and see how the bait is caught. In response to our request, we are invited on board, and the steamer heads for the canal which connects Gloucester harbor with Anisquam river. Through the canal and down the river we glide. It is dark as we cross Ipswich bay, and we keep a lookout for Newburyport light.

"We're near the bar now. Here comes a roller," calls the captain.

The little steamer stands almost perpendicular on her bow as the water boils over her rail and on to her deck. The captain strikes 2 bells to stop the propeller, which is out of water, and we speed over the Newburyport bar as if shot from a gun.

"That was a close call," says the captain. "I wouldn't 'a'dared to come in if it had been daylight. These ground swells come in quick. Whv, I've been out here with a boatload of bait when it was smooth as a mill pond, and before we could get it bailed out we were dancing up and down alongside of the vessel, first above her rail and then down under her bilge. It's a nasty place!" Every skipper along the coast knows Plum island and the Newburyport bar.

"See those lights ahead? They are torch-

es. They hang a torch over the bow of their boat, and a man aft rows while the one forward bails the fish."

Here we overhaul one of them.

"See the fish come out of the water after that torch! He gets a netful every dip; but they are small. The big ones won't run."

By that time we are some distance up the river, and the captain says, "It's time to hear from the boys." Presently they hail us, and tell us to "run up a little farther," so as to give them room to haul. We keep on 150 yards more, and drop anchor.

"Now, you fellows tumble into the dory and go ashore," says the captain to us, "but first you go aft and get on longlegged boots and oilers. You'll find plenty of them there. You don't want to be wet all night in the month of December. It ain't pleasant."

We follow his advice, and are rowed ashore by the 2 men whose turn it is to go on the steamer and unload the bait. Meanwhile, the captain gets what sleep he can on the seat of the pilot house.

"Have you made a haul yet?" inquires a man from our boat.

"Yes," someone answers, "we hauled below there, but didn't strike them very solid. Got about 10 barrels. It's time they showed up now."

"Suppos'n we row the seine boat out a little way, and see if we can feel them?" We row out into the river, when someone says:

"There's a flip. I heard it, just below us."

"And there's a break above us."

"They're dipping all around us," say a number of voices. We push down our oars and feel the fish strike against them their whole length.

"Back her in, boys," says the man in command. "Here, you fellows on shore, catch this warp. Now, let her go, boys, and make a good turn. I can't throw the net and watch the boat too. Turn her a little more. That's right. Keep her the way she's going. Now row her in shore."

The other warp runs out over the stern of the boat, as fast as 6 men pulling an oar each can make it. We are fortunate enough to land at the proper place, and the way the men spring out of the boat is a caution to cripples.

"Come, bend on, here!" shouts a voice from the darkness. "Remember that hang above us. The tide is setting up strong, and we don't want to get torn up to-night. Race her in, boys. Now, pull all together."

"There they poodle! There they bunt her! Hear them rush!" are some of the expressions used by the men.

We pull and strain at the warps until someone inquires:

"What's the matter with her? We can't gain an inch. Is she hung up?"

"It's fish!" says the captain of the net. "Here, Jim, take the dory and go out and sink the corks, or we'll never get these ends ashore. Here they are up around my feet."

So Jim takes the dory and sinks the corks, and as the moon has risen above the horizon we can see better how to work.

"Now, boys, lift the lead lines and let some of these fish out. We've got more than we can handle, although the freezer wants 1,000 barrels, and 2 salters came in to-day. Somebody get the tag-boats, and go to bailing."

The tag-boats, holding about 50 barrels each, are made fast to the cork-line, and are bailed full of fish, some of the men wading up to their hips in the net, while others bail from the boats. We see the need of oil-clothes, for as soon as the net is dried up, by taking in the slack twine, the fish rush from side to side of the net with a noise that can be heard half a mile on a still night, and splash us from head to foot.

When the tag-boats are filled, they are rowed out to the steamer and the fish are bailed on to her deck until she has about 200 barrels aboard. Then we bid the seiners goodnight and start on our journey to Gloucester.

"Those nets must pick up a great variety of fish," we remark, as we resume our seats in the pilot house.

"Yes, we catch every kind that comes into the river," answers the captain, "from an eel to a horse-mackerel. I recollect one year when the river was full of horse-mackerel, and half a dozen boats at once were taking a ride all over the river, made fast to an iron in those fish. That was sport! Especially when they crossed lines! One fellow had a narrow escape. Jim dropped a handful of bluebacks overboard, and when a horse-mackerel rose up after them Jim put an iron into him. Somehow he got that line around his ankle, and overboard he went. Then the boat, not having anybody to steer it, yawed around, and over that went. When we got there, we had to right the boat before we could get to the line, and then we pulled in about 60 fathoms of line before we got to Jim. We took him ashore and rubbed him an hour before he showed any signs of coming to. You ought to talk with him. He knows all about horse-mackerel!

"We had an experience with bluefish a few years ago. We sat around a school

about where we were to-night. Thought they was pollock, or codfish, you know. We saved 8, I believe. Everyone of them fish bit a hole the size of his mouth in that net and went through it.

"We catch a big sturgeon once in a while. You'd think they'd tear the net? Not unless they roll up with it and then thrash. We sell them to a Dutchman in Newburyport. He sifts the roe through different-sized sieves, spices it up somehow—he won't tell how—and sends it to New York or Philadelphia, where them Dutchman pay a fancy price for it. They call it caviare. The meat goes to the same place. They call it Albany beef. Or else the canners put it up for salmon. You can tell it. The bones are soft. You can chew them. Salmon bones are hard."

"What'll the boys do with the rest of them fish? Oh, they'll probably take them up to the freezer. There's a vessel up to the wharf with a freezer aboard. She belongs over to Gloucester. They pay 50 cents a barrel, freeze them and keep them until the market is bare. Then they sell them by count, 2 or 3 cents apiece sometimes."

We are in Squam river again. The draw opens, and we glide into a swarm of dories and sailboats.

"I want a bucketful."

"Is that a bucket?" inquires the captain. Look what he calls a bucket! A candy pail! He wants it full, too. That fellow has a big butter firkin with a bail hitched on to it. This fellow wants a haddock basket full for a bushel. Well, boys, give them their bait, and take their names if you can spell them; I can't." Turning to us he explains:

"This is the bucket brigade. Most of them are Portuguese. They never have any money. So-and-so settles for their bait, and buys their fish; has them at both ends, you see."

"I want 40 barrels," calls a voice from a dory, "right away, too."

"All right, skipper, come aboard, and we'll be over there."

"What do you ask for bait?" cries another voice.

"Two dollars," answers our captain.

"I'll give you \$1.50 and take 20 barrels."

"You can't play that this morning. There's too many of you waiting. I ain't got enough for all of you, anyhow. You'd better take your turn now, and not be whining and offering \$5 after it's all gone."

In this manner we busy ourselves, going from one vessel to another, until the bait is all bailed off the steamer's deck. Then, seeing our opportunity, we spring on one of the wharves, after thanking the genial captain for his hospitality, and seek our homes.

GINSENG.

Please give me a description of ginseng root, its leaves and blossoms. I want to know about the wild kind. Also, if you can, give the address of a reliable firm that will buy it.

Robert Dudley, Manchester, Ia.

ANSWER.

Ginseng (*Panax quinquefolium*), is a smooth plant, 8 to 16 inches high. Roots are deep set, spindle shaped or branched. The leaves are compound, usually 5 on each stalk. The sketch will give an idea of their shape. I believe there are always 3 of these compound leaves at top of stem. The flowers arise from same point; a little cluster of greenish yellow flowers. Fruit is flattened somewhat, and bright crimson when ripe.

There are several German drug houses that are on the lookout for all kinds of roots; in fact, have men in the field all the time. Ginseng is perhaps the most valuable root in the market, but it is practically exterminated in the larger part of the United States.

There is good money in raising it. Regarding cultivation, send to Director of Publication, Department of Agriculture, Washington, D. C., for Bulletin No. 16, of Division of Botany. Or consult Kains' "Ginseng, Its Cultivation, Etc." Orange Judd Co., 1899. Cultivated roots command a higher price than the wild.—EDITOR.

She—The strain on the soldier in modern warfare must be very great.

He—It is. Sometimes the photographer isn't ready, and you have to wait hours, and then the pictures may prove failures.—Judge.

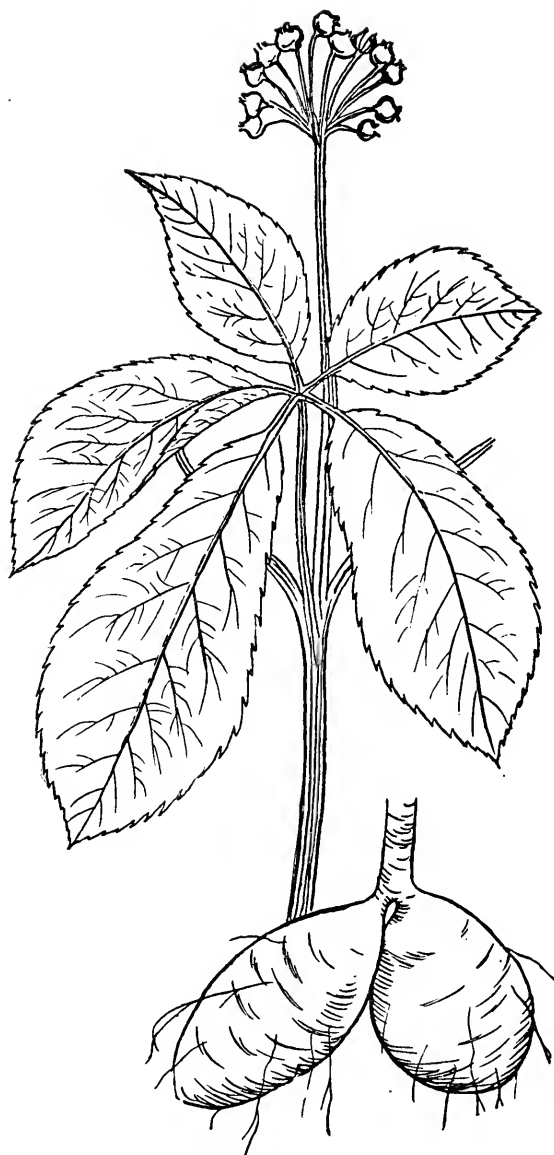

GINSENG.

"Do you think you could be happy with a man like me?" asked Willie Washington earnestly.

"Oh, yes," answered Miss Cayenne after a pause; "I think so—if he wasn't too much like you."—Washington Star.

"The world is more inclined to take a man at his own estimate of himself when he places it low than when he puts it high."—Exchange.

HOW SULFLOW SLAUGHTERS 'EM.

In July RECREATION there was a reproduction of a photo showing a catch of fish in Minnesota, accompanied by the proper remarks. I enclose a clipping from Minneapolis Tribune of July 2d, containing picture of another of the bristly breed whose education seems to have been neglected.

Henry A. Allen, Minneapolis, Minn.

The clipping referred to by Mr. Allen

picture of this catch which I will gladly forward to you if you wish it.

W. H. Sulflow, Minneapolis, Minn.

I have already secured a copy of the photograph and so need not trouble you for one. This and your letter show that you are another thoughtless, reckless, ignorant fish butcher. If you had kept pace with the thought and sentiment of decent sportsmen the last few years, you would know

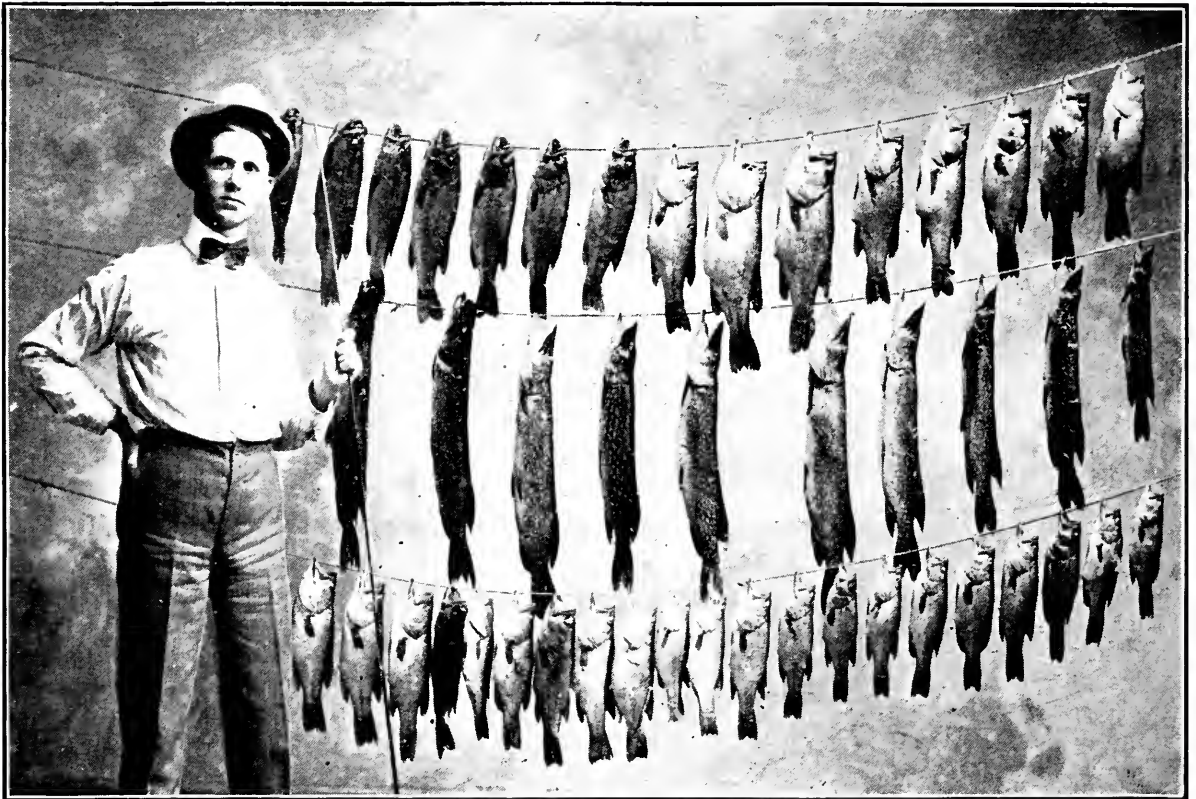

ANOTHER MINNEAPOLIS BUTCHER.

showed the photograph reproduced herewith, and the statement that W. H. Sulflow had caught 46 fish in one day. I wrote Mr. Sulflow, asking if the statement was true, and he replied:

The number is correct: 36 bass and 10 pickerel. They were caught between 6 and 10 o'clock in the morning. I have a good

that in taking this number of fish in one day you have disgraced yourself. You would also know that in having those fish strung up on clothes-lines, standing up alongside of them in the proud, boastful, vulgar manner you have assumed, and being photographed, you have placed yourself on record as another member of the unfortunately and disgracefully large herd of Minnesota swine.—EDITOR.

“O! she's so sweet, so angelic and fair,” sighed Lovett Fursyte. “But I know I shall never succeed in winning her love.”

“Nonsense!” exclaimed May Sharpe. “Lots of other men have succeeded. Why shouldn't you?”—Philadelphia Press.

FROM THE GAME FIELDS.

The man who quits when he gets enough, with plenty of game still in sight, is a real sportsman.

A PLEA FOR COLORADO GAME.

We of Colorado are in a dilemma. We have the deer and the elk, but how to keep them is the problem that confronts all sportsmen. Every year the would-be hunters come from the East in greatly increasing numbers, and every year they kill and cripple thousands of our cherished game, so that now it is only a question of a few years when a deer or an elk will exist only in the tales of the big hunter who can tell of the hundreds of them he has killed.

I have never killed an elk. I have not killed more than 30 deer, though I have lived in the West over 35 years and my calling has taken me to the front in all the places where I have lived. I have been in this State over 5 years and in the big game lands most of the time. Last year I, in company with 7 others, went to the Douglass Creek country to get a deer. We saw hundreds of deer during the 3 weeks of our stay; but we wanted some fine heads, so killed but few and none with over 4 points. There were about 50 does to one buck and nearly every deer we killed had been wounded, showing that nearly all had been severely hunted. Our season is August 15 to November 5, and this is what we should change. The season opening at such an early date allows anyone to kill 2 bucks at a time when meat can not be kept to ship home; and every year more meat is spoiled in that way than is saved. Also it gives tourists a chance to come early and stay late, so that men who have nothing to do but kill can do that freely. We have game wardens, but everyone knows that a man with plenty of money can come here and kill all the game he wishes and that no questions will be asked. I am not blaming the game wardens, for they must live and they must have money; yet this wholesale killing will take all our game if it is not stopped soon.

More deer are crippled by smokeless powder than are saved. A man who is new to big game hunting shoots at the first deer he sees, no matter if it is 600 yards away. He knows the gun will send lead there, and he is out to send lead. The result is he does not know how many deer he hits or misses. All he knows is he may kill one and then he will be It. I have been in localities where the firing began before it was light enough to see the front sight on a gun, and was kept up all day, so that we had to get out for fear some fool would send a stray bullet into one of us. One fellow made a mistake and took 3 shots at my partner after dark. He was so far away

that my partner could not locate him except by the flashes of the powder.

You may say I am too radical, but if you were here with me and could see the dead and crippled deer North of Rifle, Colorado, you would not wonder at what I say. Just North of Rifle the divide between the Grand and White rivers narrows down to 3 or 4 miles, and on the North side of this divide is the great winter runway of all the deer from the North of Rio Blanco and Routt counties. The deer all pass along there the last of October, and then the destruction begins. All summer law-breakers have been killing fawns and does up in the hills; and after the deer go to their winter feeding grounds, which are Northwest of this place, about 60 miles, the Indians finish hundreds of them.

I am against the smokeless rifle. It's a game hog's gun and no tenderfoot should be allowed to use one. My chief reason is that a man who has not had much experience will shoot at a deer when he is entirely out of range.

I have been in buffalo so thick that counting them was out of the question, and now where are they? Three years ago I could go out and kill all the deer I was allowed to in one day, and this fall everyone of our hunters had a hard time to get even one deer in a week. As to elk, none were killed from this point, although some men stayed 2 weeks.

The smokeless rifle does not give the deer a show to see where the enemy is. I use a 45-70 Winchester, 1886 model, and have used Winchesters for years. I find that over 500 yards with any gun is guesswork with most of us, shooting in timber and over the hill grounds in which the deer stay. I have seen hundreds of deer wounded with smokeless powder during the last 3 years, and the men who fired the shots never knew they had hit. We should make the season September 15 to October 5, and give one buck and one doe to each man, with a gun license of at least \$50 to non-residents. This might cause a howl from outsiders, but game belongs to the people of the State.

Please give the game hogs a hard one for us of the West. Few ranchers on the summer range will aid in stopping the slaughter, for they make money every year as guides. It is impossible to convict a man under the law as it is now, and the game wardens only use their positions as a pull. They arrest some men every year, but a jury lets them off free, so the county has the cost to pay. Let us have a better law;

one that makes possession a crime and that will give no recourse to the game hog but to pay and leave.

I read every issue of RECREATION and always shall as long as you keep up your present course of action.

E. H. Kern, Grand Junction, Colo.

GRIZZLIES AND GAME HOGS.

I can give Mr. Wright some of the information he asks for in his letter published on page 284 of your April issue. In 1889 I was detailed to catch a grizzly, and after a hunt of 5 months in the mountains of Southern California I returned to San Francisco with "Monarch," the bear that is now in the Golden Gate Park, San Francisco. The story of the capture of Monarch was stolen recently by one Gosman, alias Kemble, and told by him to the Youth's Companion as an account of his own adventures. For publishing his fraudulent stuff the editor of Youth's Companion has written to me an expression of his regrets and an explanation of the manner in which the thief took him in.

So much by way of introduction, to show that I am qualified to give the required information. Monarch was full grown when captured, but he was lean and hungry. He has not increased in height since, but is much broader and heavier. His present dimensions, taken by Louis Ohnimus, who had charge of him for several years, and who is now employed in Golden Gate Park, are as follows: Length from tip to tip, while standing naturally, 6 feet 6 inches; height at shoulder, 45 inches; breadth of head between ears, 12 inches; length of head from ear to tip of nose, 18 inches; breadth across chest, outside to outside of shoulder, 3 feet; length of track, 8½ inches; width of sole, 6 inches.

Monarch never has been weighed accurately, but many estimates of his weight have been made by persons accustomed to guessing the weight of cattle, horses, etc. These estimates vary greatly. Mr. Ohnimus, an expert menagerie man and an old-time vaquero, writes me that he believes Monarch's weight to be 1,800 pounds. This may be correct, but I have doubts and do not adopt the figures as my own. I always have discounted about 20 per cent. the highest guesses at the weight of Monarch, and I am inclined to believe that the scales would bear me out. I am skeptical about 1,800 pound bears. Monarch probably is the largest bear in captivity and a good specimen of the largest California grizzly, and if he weighs 1,400 pounds I am no guesser. Yet I may be wrong and Ohnimus, with his wider experience, may be right.

A word about bear tracks, at the risk of

using too much space. I have heard of 14-inch tracks, and have measured footprints of that apparent size on mountain trails, but I think I know how an error is made. A bear generally places his hind foot in the track of his fore foot and a little in advance. The hind foot obliterates the claw-marks of the fore foot and lengthens the imprint, and the double track is mistaken for the print of a single foot. The apparent width is similarly increased. Some old trackers may be able to verify or disprove this.

On exhibition in this city are the skins of 2 Alaskan grizzlies. The stretched hides are 10 feet long, 6 feet 3 inches wide. The heads are about the size of Monarch's. Whether the animals were larger is a question. I think not.

Your roast of Coronado game hogs was deserved and just. It is not true that all the ducks killed on False bay were retrieved and used. For 2 or 3 days after the slaughter boasted of by Mr. Babcock dead ducks were blown ashore. Babcock and his friends tried to justify themselves by asserting that all the birds were shot on the wing.

The same gang went down into Mexico and slaughtered quails in the same way and bragged of the enormous number they killed. One Captain Sedam, a visitor, seems to be the boss killer of the outfit. He claims to be the boss killer of the outfit. He claims to be champion wing shot of all creation. Babcock encourages this sort of thing because it attracts people to his home.

At Catalina fishing for record is prevalent, and tons of fish are thrown on the beach to spoil. The game hogs get all 4 feet into Southern California's trough, and the time will come when nothing else will be found in the trough.

Allen Kelly, Los Angeles, Cal.

PROHIBIT THE SALE OF GAME.

Mr. Boswell's discussion of the game selling question in a recent issue of RECREATION doubtless appears sound to the casual reader, but it will not bear close inspection by careful thinkers.

He bases his argument on the hypothesis that absolute prohibition of game selling would mean a deprivation to 99 per cent. of our people. As such prohibition can prove a deprivation only to those who now buy and eat game, leaving the dealers out of the discussion, it follows, from his hypothesis, that all but one per cent. of our people are game eaters.

This is not a fact, as everyone knows. That class of the people which Mr. B. designates as the most numerous—tradesmen, mechanics, artisans and laborers—seldom or never buy and eat game, owing to its present high price. Any money which remains after the beef and other domestic meats are

paid for is invested in mining stocks, real estate, brewery produce or tobacco.

A careful investigation of the subject shows that not more than 5 per cent of the inhabitants of our large cities now eat game. It shows also that the people who buy and eat game are wealthy enough to go into the fields and forests to secure it. It may properly be argued that the indolent members of our middle and wealthy classes who buy and eat nearly all of the game sold are those to whom the prohibition of all game selling will prove a hardship, but as these people are in a position to gratify their appetites by the exercise of their muscles in the fields and forests no sympathy need be wasted on them.

It may properly be argued also that a great increase in the number of our game animals, such as would result from the prohibition of all game selling, will enable many poor men, who can not now afford either to buy game or shoot it, to hunt and kill a fair quantity of game within a few miles of most of our cities. Thus it follows that the prohibition of game selling would benefit the poor man instead of working hardship on him.

As long as any selling of game is permitted, no matter how well planned and well framed the conditions attached to such selling may be, the market hunters will remain in business, and by the exercise of a little clever dishonesty will sell all the game they are able to kill. The very restrictions which are thrown around the sale of game for the purpose of regulating such selling act as obstacles to the prosecution and conviction of market hunters and game dealers who violate the laws.

The only measure which will positively prevent the constant killing of large quantities of game for market is one which will prohibit the selling and buying of game at all times, with severe prison penalties for every violation. The conviction of offenders, with all petty conditions and restrictions removed, would be easy and rapid; and a long prison sentence is relished by few.

In order to replenish our depleted fields and forests with game advise a more radical step even than the mere prohibition of game selling, namely, a closed season on all game for a period of 5 years.

G. H. Lehle, Chicago, Ill.

HUNTING ON MUSKEGO LAKE.

There is a body of water 12 miles South-west of Milwaukee known as Muskego lake. For the last 7 or 8 years, however, it has not been much of a lake, as the Wisconsin Drainage Company got a bill through the Legislature allowing it to drain off the water. Formerly the lake was a great resort for ducks and snipe; but when

drained it became a reeking bed of mud and quicksand. Through the efforts of property owners on its shores and of Milwaukee sportsmen the drainage has been choked off and the lake is slowly refilling.

On September 4 a friend and I drove to Holt's place, on what was once the lake shore. We hauled the skiffs out to the water on a small 2 wheeled cart and found it exceedingly hard work, as the sand was soft and deep.

Farmer Holt asked whether we would not like to hunt jacksnipes before trying the ducks. He said they had been thick as flies the preceding few days. As jacksnipes have been scarce in these parts for many years, I took his words with some grains of allowance. Nevertheless, I put 2 No. 8 shells in my gun and 4 more in my vest pocket. I had shed my coat owing to the intense heat. Farmer Holtz took a 10 gauge and 2 shells, and we walked along the shore a few steps to some reeds which grew on the former bottom of the lake. To the right sounded a "scaip," to the left another, in front half a dozen "scaips," and the air about us seemed alive with jacksnipe. Some went up singly, others in bunches of 8 or 10. None flew far, as the patch of weeds was not large. My first shot dropped a bird at about 20 yards; the other barrel one at 30. I then let fly at a line of 6 or 8 to my left and dropped one. Farmer Holtz killed 2 more in the meantime, and I ran back to the boat for more shells. I killed another bird, on which I nearly stepped.

I slipped on a pair of rubber boots and we started into the reeds again. We had no dog with us, so had to do our own flushing. I shot 17 snipe with 20 shots during the next hour. Then our small shot shells gave out and we returned to our boats.

We did not get any ducks that day, as our shooting frightened them away. Jacksnipe were not again plentiful at the lake last fall. Six days later I made a trip to the place on my wheel, but found only 6, of which I bagged 4. But I shot 5 green winged teal on the lake the same day. A week later I shot 2 spoonbills, 3 teal, and a string of plovers of several varieties.

Emil Koehn, Milwaukee, Wis.

HOW I GOT MY MOOSE.

In 1889 my father and uncle proposed a hunting trip to Northern Minnesota, and after a lot of coaxing on my part I was permitted to join the expedition. I was then 18 years of age and many a deer had fallen before my Winchester.

In a few days we set out for a 100 mile ride over the worst road imaginable. We traveled in the hardest of luck, and breakdowns were continuous. In 3 or 4 days we reached McMullan's ranch, at the foot

of Lake Itasca, and put up for the night. The following morning we pulled for Hennepin creek, 13 miles to the Southeast, and reached it about 3 o'clock in the afternoon. All hands set to work pitching camp and getting things in shape for a week's shooting.

When day broke a light tracking snow had fallen and we made an early start; father and uncle going up the creek and I down.

Two miles down I came on the tracks of a big moose and followed him about 8 miles. Then it began to snow and after a while I lost the track. Not being discouraged by this bad luck I kept on and after an hour or so was rewarded by starting a band of 3 moose. They escaped unharmed and I went on until dark. I gathered fire wood, built a brush house and got through the night as best I could. In the morning I ate my last morsel of lunch and after studying out my whereabouts I started for camp. I found another track and as it led in my direction I concluded to follow it. Before long I saw, in a hollow under a big pine, a large moose. I was not long in getting a bead on him and when I fired he went down. Throwing in another cartridge I started to where the animal lay apparently dead. I was going up the other side of the hollow when I saw my moose coming my way like a locomotive and not more than 30 yards from me. By the time I got my rifle to my face he was close enough for me to see his eye winkers and I cut loose. He went down again, dead this time for sure.

I went to him and saw that my first shot had creased his neck stunning him for a while, but my last was between his eyes.

The next day I laid in camp and my father and uncle succeeded in killing a small bull. That ended our hunt.

Robert Moak, St. Paul, Minn.

A WARDEN IN THE FIELD.

November 15, '98, 3 friends, Dr. Feeter, Wilber Blair, his brother Jay and I set out for a day among the quails and rabbits.

The place we fixed on is known as Blair's Thickets in the central part of Franklin county, Pa. We had selected this locality because it had not been hunted that season. The day was cloudy, just right for quails. Jay, he was along to carry the game, but not for swine. We stopped when we had a reasonable bag.

At the edge of a thicket we separated, the Dr. and Wilber with one dog, Jay and I with the other. The doctor soon started a covey of quails and it was amusing to see him try to shoot with an empty gun. He joined in the laugh, remarking:

"It was a mighty lucky thing for the birds."

We could not find the birds for a time, but while hunting for them I placed 5 rabbits to my credit. Soon after this my dog flushed one quail, which fell to my gun. We flushed the covey and 2 fell to our credit, one to the doctor, one to me.

Next we looked up the rest of the covey. We had not gone far when I added another rabbit to my string and after a few steps more both dogs came to a stand and one old quail rose. He swished and dodged, showing he knew what was coming. "Boom, boom," 2 cracks hastened his departure. We kept this up all forenoon, miss and hit, till it was time for the doctor to go.

When we got home we had 12 rabbits and 9 birds of which 9 rabbits and 4 birds fell to me; one rabbit and 5 birds to the doctor, and 2 rabbits to Wilber. Not a big bag to some, but we are no game hogs and were satisfied. We expect to have some fine sport in the near future on what was left.

The doctor is our game warden and has done much to break up the unlawful killing of game in our county. Since his appointment there have been 23 arrests and 23 convictions. \$635 in fines have been collected. The practice of killing game out of season is carried on in some parts of the county yet, but we hope to stop it in time.

B. J. Minter, Orrstown, Pa.

A VETERAN IN WASHINGTON.

I have been what young men of to-day call an old style sportsman, ever since I could wield a hickory fishpole, lift a gun or set a trap. Few sportsmen of to-day have used or seen the kind of shooting irons we hunted with 50 or 60 years ago.

In 1838, when I was 10 years old, my father moved from New York to the then Territory of Iowa. Eastern Iowa was then unsettled and full of game. Father was no hunter and disliked hunters. He was a born tiller of the soil and remained so all his life; but not so with me, his eldest son. I was the black sheep of the flock. I loved the woods and prairies and all that they contained far better than I did the cultivated fields. There was little time in pioneer days for a boy to hunt or fish; yet my good father, when I was 11 years old, allowed me to buy an old flint lock single barrel shot gun. I have owned many fine rifles since then, yet have never felt the same joy as when I first found myself possessor of that old gun.

With it I killed squirrels, ducks, quails, grouse and such small game as a boy will shoot. But, as the woods were full of turkeys and deer and as geese came in the grain fields by hundreds, I soon tired of my little gun and traded it for an old rifle running 60 round balls to the pound. That was the way we measured the bore of a

rifle in those days. That rifle had what was called a pill lock; instead of a tube on which to put a percussion cap there was a countersink in which we dropped a percussion pill, which the hammer exploded. There may be other old hunters who remember such fire locks; if there are I should like to swap hunting yarns with them through RECREATION.

I quit climbing these mountains for land game 5 or 6 years ago, but I still fish every summer. I have lived, fished and hunted here since 1888.

This old heart rejoices that I have lived to see such a crusade as is now being led by RECREATION against game hogs. Roast 'em, roast 'em brown!

H. N. Merritt, Chelna, Wash.

CAMPING IN THE NATION.

Chas. Drennen, Tim Ross, Fred Britt and Will Hayman were in camp 8 days on Illinois river, Cherokee Nation, early this month. They went to Illinois station on the Iron Mountain railway and with team 25 miles up the river to good camping grounds.

They had success both in shooting and fishing; the bass caught weighing 10 to 20 pounds, on the hook, but making the usual allowance for shrinkage after landing, the largest were estimated to weigh about 2½ pounds in the pan.

Britt wanted to catch whales and undertook to wade out to them, but every time he got out hip deep he would float and yell for help. Dennen told me this and tried to explain the cause. I did not fully understand the yarn, but it was something about Fred's "gall." After the second or third rescue Britt was forbidden to fish any more. An agreement was made that Hayman should furnish game for himself and the cook, Dennen to supply Ross and himself. A mangy, hungry stray dog took up with the camp the first day the party was out and to Britt was assigned the job of supplying meat for himself and the dog. He hunted 1½ days, used all the 12 gauge ammunition the party had and killed one squirrel. The cook had made elaborate preparations for a barbecue, and to carry out the program barbecued the squirrel. Fred ate it. The dog with ears half cocked watched hungrily for his share until satisfied that there was not going to be any share, then tucked his tail and sneaked away.

Ross was the most successful fisherman. Finding a surplus of both fish and game on hand 2 whole days were spent lolling in camp. The weather was right and they had a good time. Quails and squirrels were plentiful. Two turkeys were seen but no deer; but people shooting small game would hardly expect to see them.

B. Smith, Van Buren, Arkansas;

CAMPING ALONE.

For years I had thought of taking a trip alone in the woods and living a few weeks with only nature around me. Residing as I do here among thousands of people this thought was particularly attractive. This year I tried it, going into the woods about 20 miles from Ellis Junction, Wisconsin, to what is known as the Thunder Mountain country. I stayed out 10 days and saw only 2 persons after getting my camp pitched. These were exceedingly welcome; I busied myself to detain them as long as possible, and talked them tired.

Did I have a good time? Well, I did and I did not. I enjoyed the experience, had plenty to eat and was comfortable; but my advice to others is to camp with a companion. When you catch a big trout or bass you want some one to talk to about it; also, you want some one to swear to your catch when you get home. When you see a deer or possibly a bear you want to say something right then. There will be other times when you will want to talk, and will have to content yourself with thinking. When you make a good batch of bread or cook your trout just right, it is nice to have some one tell you what a good cook you are. Moreover, you will the better enjoy eating if you see a companion trying to show you how much food it takes to keep a man alive in that country. Again, he might come handy to carry water, help build fire, get wood and wash up things. If you have not missed him yet, wait until night comes and you sit looking in the fire and wondering what caused that crackling noise out in the woods. You finally turn your head to see, trying to make yourself believe you would have looked over there any way. If you don't believe me, and think you are perfectly satisfied to be alone, sing or whistle a good lively air; maybe you can, but I doubt it. After you get home you may say you had a fine time, but you will know you could have gone over the same ground with a companion and had 10 times the pleasure.

A. W. Lowdermilk, Chicago, Ill.

WHERE TO GET MOOSE.

We have here large numbers of moose and caribou. It is not unusual to see 10 to 60 caribou in a drove. It is not possible to go half a mile from the settlement without seeing moose tracks. Frequently these animals come out on the roads and fields. We have some deer, many bear and some of the best trout streams in America.

I have hunted big game and all sorts of fur-bearing animals for the last 30 years. In that time I have killed many bears, moose, caribou, deer, lynx and plenty of smaller fur. In this district the woods are so dense that, except across the lakes or barrens, it is impossible to see 100 feet from

where one is standing. This no doubt protects the game in a measure. About 4 years ago our Government appointed me a special game warden for New Brunswick and I am also a lumber estimator. I spend nearly all my time in the woods and am well posted as to our game. We have had several Americans here, and all to whom I gave license got moose, especially M. L. Shover, of Ostrander, Ohio, and F. H. Davis, of Worcester, Mass. They got the best heads I ever saw. This season Judge Bruce, of Massachusetts; Mr. James Smith, of Philadelphia; David and W. Collins, of Philadelphia; A. L. Cadwalater, of Yardly, Pa., and F. H. Davis, of Worcester, Mass., were here. They are true sportsmen and are satisfied with reasonable bags.

Our chief trouble here is pot hunters. It would take the eyes of a lynx to watch them. About 30 moose and some caribou have been killed here under local license, and no doubt some without, as those who kill illegally are sure to keep it to themselves.

I shall be happy to answer inquiries from any of your readers at any time and give them all the information in my power. RECREATION is a grand publication; just what is needed to put down pot hunters.

P. H. Welch, Chipman, New Brunswick.

THINKS HE KNEW OLD MOSE.

I read Mr. Beecher's story of the grizzly in December RECREATION with deep interest, more especially because I was hunting in that part of the country when Old Mose killed Radcliff. The story is true as far as it goes, but at one time Old Mose moved down on Eight Mile creek, East of Canyon City, and killed lots of cattle of Jeff Young, Ed Merritt and others. I hunted deer about Black mountain and the head of Badger creek, and saw Old Mose's tracks at different times. The bears often would find and eat some of the deer I killed and could not bring into camp the same day. I kept a bear trap set and caught one large grizzly and one black bear, which I took to Pueblo and sold at 10 cents a pound.

I was hunting in that part of the country once and a bear ate part of a deer that I had hung in a tree. I did not have the bear trap there, so I set 2 wolf traps and the next night a very large bear got in them, which we supposed to be Old Mose. He rolled all around and finally got out, leaving part of 2 toes. That taught him a lot about traps and probably accounts for his never getting into a bear trap to stay.

I set a trap at the carcass of a calf that had been killed by a mountain lion. Old Mose came along and sat down on the trap. It caught him by the rump and he jumped about 10 feet, tore the trap loose and left a big bunch of hair in it. He then went off

toward Turkey creek, and I have not seen a sign of him since.

W. J. Banta, Palisade, Colo.

NO GAME ON THE MONTANA RANGE.

Having just come East this winter, after working some time for cow outfits on the range, I can tell a little about game conditions out there of late. While on the roundups in Montana and Assiniboia last year, I noticed there was mighty little game in the country.

In Eastern Montana, North of the Missouri, antelopes are scarce. I saw only 7 or 8 in 2 months' riding. Local hunters said there was a bunch of 50 just South of the river, near the mouth of the Yellowstone, but I never saw them. There are a few deer in the hills and near the creeks, but not many. Wolves and coyotes are thick. Small game is fairly plenty, and would be more so were it not for the Sioux, who kill off everything.

In Canada game is just as scarce. The prairie seems empty and deserted, with no sign of life anywhere. Up there the half-breeds collect ducks' eggs in the spring, but how many they take or whether to eat or sell I do not know. We camped near several lakes where the ground was covered with broken egg shells left by them. At any rate it does not seem to have effected the supply of ducks, as we saw them in large numbers. Some people can not seem to realize that the slaughter of game in this country must be stopped.

R. L., Boston, Mass.

SLAUGHTER IN LUZON.

Since the outbreak of hostilities there has been no greater slaughter recorded than that which took place on Laguna de Bay as the result of a duck hunting trip under the direction of Thomas E. Evans. The party that accompanied Mr. Evans consisted of Messrs. Knight, Bell and Guy. The result was that 384 ducks were secured, and many hundreds killed which were not secured.

The party left Manila Saturday night at 11 o'clock in the launch Knight and steamed up to the lake near Napindan. The greater part of the night was taken up in making plans for the morning. Before sunrise they had taken up a position commanding the entire area of marsh which marks that portion of the lake.

They had no retriever and recovered only such birds as fell in the open, many hid in the thick growth of reeds. In all possibly 2,000 ducks were lost in this manner.—Manila American.

As a rule I pay no attention to foreign game hogs, but Luzon is American territory, and we may safely assume the men who committed this butchery were Americans. They therefore deserve to be branded just as if they had done their butchering in any one of the States. Congress will soon be called on to make a game law for the Philippines, and I trust public sentiment may in the meantime demand that a prison penalty be attached for men who commit such butchery.—EDITOR.

A GOOD CAPTURE.

Hurley, Wis.—The greatest haul ever made in this State was made recently by Game Warden Valentine Raeth, of Milwaukee, and Warden James Overholtzer, of Eagle River, between Van Buskirk and Hurley. The 2 wardens who had worked together for 2 weeks in Vilas county, received notice that men from Michigan were hunting deer on Saturdays or Sundays near the State line in Iron county. The wardens arrived here Saturday afternoon and began their work. Seven rifles, 4 bags of venison and 7 men under arrest were the result of their visit. Ole Kruken, James Anderson, Henry Hogan, Charles Larson, August Kruken, Oscar Larson and Ilif Brown, all of Ironwood, Mich., are the alleged hunters. They all work in mines near Ironwood.

The capture was made before the men knew officers of the law were about, and they were as suddenly stripped of their arms. Revolvers in the hands of the wardens quelled any thought of resistance, though one of the men is said to have drawn a knife.—Milwaukee Free Press.

Nothing succeeds like success. Nothing will so suddenly convince a man of the necessity of obeying the game and fish laws as to have a game warden push a 6 shooter into his face and take his gun and his game away from him, even as Raeth and Overholtzer did in this case. I would bet 10 to 1 that this herd of swine will do no more hunting in close season within the next 10 years.—EDITOR.

DISAPPROVES OF DOGS.

I have read J. A. Steele's comments on dogs and ferrets in June RECREATION and I fully agree with him. I, too, fail to see that it is more hoggish to hunt rabbits with a ferret than to shoot quails over a dog. Both bird dogs and ferrets are used here. I have known a man to go out in the morning with a ferret and come back before noon with all the rabbits he could carry. Then he took his dog out in the afternoon and shot 30 or 40 quails; thus proving himself a consistent all day hog. A real sportsman would no more take advantage of a quail by using a dog than he would of a rabbit by using a ferret. Yet note the unfairness of general sentiment on this subject. If a farmer's boy takes a \$2 ferret and an \$8 gun and gets more rabbits than he ought, he is a low bristleback; but the man with a \$50 setter and a \$100 gun who shoots quails without giving them any more chance than the boy gave the rabbits, is still a sportsman. If the ferret must go, and of course it must, I say send the bird dog with it.

Paul Mouser, Little Sandusky, O.

GAME NOTES.

The State Game Commission reports that 5,000 deer were killed in the Adirondacks last year, with an anti-hounding law in force. What would have been the total had dogging been permitted? Of course, we all know some hounding is done now, but there would be 10 times as much if it were

not for the law. A great fight will be made to get that law repealed. I hope the L. A. S. will do all in its power to have it extended another 5 years. We now have a few deer here, where a few years ago you could not find the track of one. Just as surely as they begin hounding again our deer will be driven away or killed. We are within 10 miles of Dresden's great hunting grounds, where there are lots of deer. Why? Because a hound is never allowed to run there, law or no law. Once a boat load of men and dogs came up Lake George and landed in Dresden. They brought 16 dogs and went home without a dog or a deer. Hurrah for Dresden!

Philip Kelsey, Comstock, N. Y.

In December RECREATION H. De Kalb, of Big Piney, Wyo., writes: "10,000 elk were seen in one day within 3 miles of the ranch, and many much nearer." H. De Kalb is a dreamer of dreams. Not an elk has been seen in those parts for 10 years. There may be a few antelope; but the Indians cleaned out all other game long ago. There are a few elk 100 miles West, near the Park line, but they are fast disappearing. Last year an effort was made to stop the slaughter, and some good resulted. Few elk were killed last fall. Deer are fairly plentiful. In our annual hunt last fall, we secured one bull elk and 2 deer. This is one of the best game regions in the West, as it gets the overflow from the Park. If the present laws are enforced game will increase greatly in a few years.

M. O. Newton, Cody, Wyo.

A long step forward in the way of game preservation has been made by our Legislature. The new law has many good points, one being the license clause. Every resident of our State who intends to hunt or fish must pay a yearly license of \$1. Non-residents are charged \$20. The proceeds go toward the creation of a game and fish protection fund; also to pay bounties.

I recently met our State Game Warden, Mr. Bartlett. He seemed much interested in his work, and at once asked if I were a member of the L. A. S. Receiving an affirmative answer, he said that though there were only 35 members in the State, they were a great help to him in protecting game.

RECREATION and the L. A. S. are a first class combination.

H. B. Bantzan, Moscow, Idaho.

I read RECREATION with much pleasure. When I came to America in September, 1872, the citizens passed jokes and condemnation on the game laws of England, and often railed me on the subject, saying no country had a right to impose such re-

strictions on its inhabitants; but England long ago found the necessity for game laws. Without that protection there would be no game on that island, and I for one am glad that the game laws are at last being enforced in this country. The land owners in England are not a mean class of people. They only hold their own against poachers. When the land owners kill their game they are generous in sending presents of game to all dwellers within their respective districts; even to the poorest cottagers.

W. L. Hartshorne, M. D.,
Junction City, Kas.

The Frog and Turtle Club, of Sayre, Pa., recently elected officers as follows: President, Jesse Daniels; Vice-President, Wm. Raymond; Treasurer, Ed. Freeman; Secretary, Chas. E. Wolf; Trustees, Joe Hay, Dell Higgins, John Hill; Guards, Dick Robinson, Fred Shaffer.

This club is making strenuous efforts to prevent any and all unlawful shooting and fishing in Bradford country. Mr. Charles F. Sinsabaugh is one of the most aggressive members of the club, and, in fact, its organization is largely due to his efforts. The club has 119 members, most of whom are subscribers to RECREATION.

We do not have much game here. Quails and chickens are scarce. Once in a while we find a few grouse. Please tell me what kinds of game are found in Oklahoma.

Max Metzner, Arapahoe, Neb.

ANSWER.

Quails, turkeys and deer are natives of Oklahoma. Ducks, geese, snipe and plover migrate across that region in the spring and fall, but should never be shot anywhere in spring.—EDITOR.

I left here November 8th last and went to Hubbard county, Minnesota, where I enjoyed myself immensely. I got 3 deer and had 2 fine heads mounted by J. D. Allen, Mandan, N. D., whom I can highly recommend. I used a 303 Savage. I was told by old settlers that game in Hubbard county is increasing. I enjoy RECREATION and am getting other people interested as fast as possible.

Henry Kelsey, Aurora county, S. D.

I appreciate fully the co-operative service the League has given me during the past year. It has resulted in deterring many violators of the game and fish laws as well as in bringing several to justice. If the protective departments of the several States would co-operate more actively with the L. A. S. their work could be made doubly effective.

Grant M. Morse, Portland, Mich.

Sanford Bell was hauling maple sap near Shokan and left his team a few minutes. A deer came scampering along and stampeded the horses. They in turn frightened the deer, whereupon it jumped against a wire fence and broke its back. Grouse and quails are abundant here. Rabbits are numerous; so are game hogs.

G. Van Beuschoten, Shokan, N. Y.

I have hundreds of quails and rabbits on my land, for the reason that I have not allowed any hunting for the past 5 years, and I do not kill them myself.

Norman Astley, Gibbs, N. C.

Moose, caribou and sheep are plentiful here. The woods abound with snowshoe rabbits and grouse, and in the willows are plenty of ptarmigan.

F. W. Fickardt,
Caribou Crossing, Yukon Ter.

Game wintered well and will be plentiful. We have a good law. It is being enforced, too, as several have found to their sorrow.

W. G. Kepford, Ishawood, Wyo.

About 250 passenger pigeons were seen recently flying in the direction of Oakland, their old roosting ground.

R. L. Brashear, Bowling Green, Ky.

We have a few deer, bear and grouse here and shall have more in future if the work of your League can only have proper support.

F. M. Wadkins, Baker City, Ore.

A yearly subscription to RECREATION is one of the most practicable and useful presents you could possibly give a man or boy who is interested in nature study, fishing, hunting, or amateur photography.

All boys instinctively love the woods. RECREATION teaches them to love and to study the birds and the animals to be found there. If you would have your son, your brother, your husband, or your sweetheart interested in nature, let him read RECREATION. It costs only \$1 a year and would make him happy 12 times a year.

RECREATION is doing more for the protection of our game than any other magazine that was ever published. It does me good to hear the hogs squeal when they reach the scalding vat. Find cash for renewal and count me for a life subscriber.

J. C. Banta, Topeka, Kansas.

Actress: I want you to mention the fact of my diamonds being stolen.

"When did it happen?"

"Next week."—Life.

FISH AND FISHING.

ALMANAC FOR SALT WATER FISHERMEN.

The following will be found accurate and valuable for the vicinity of New York City:

Kingfish—Barb, Sea-Mink, Whiting. June to September. Haunts: The surf and deep channels of strong tide streams. Baits: Blood worms, shedder crabs and beach crustaceans. Time and tide: Flood, early morning.

Plaice—Fluke, Turbot, Flounder. May 15 to November 30. Haunts: The surf, mouth of tidal streams. Baits: Shedder crabs, killi-fish, sand laut. Time and tide: Ebb, daytime exclusively.

Spanish mackerel—Haunts: The open sea, July to September. Baits: Menhaden, trolling—metal and cedar squids.

Striped Bass—Rock Fish, Green Head. April to November. Haunts: The surf, bays, estuaries and tidal streams. Baits: Blood worms, shedder crabs, Calico crabs, small eels, menhaden. Time and tide. Night, half flood to flood, to half ebb.

The Drums, Red and Black. June to November. Haunts: The surf and mouths of large bays. Bait: Skinner crab. Time and tide: Day, flood.

Blackfish—Tautog, April to November. Haunts: Surf, vicinity of piling and old wrecks in bays. Baits: Sand worm, blood worm, shedder crabs, clams. Time and tide: Daytime, flood.

Lafayette—Spot, Goody, Cape May Goody. August to October. Haunts: Channels of tidal streams. Baits: Shedder crabs, sand worms, clams. Time and Tide: Day and night flood.

Croker—July to October. Haunts: Deep channels of bays. Baits: Shedder crabs, mussels. Time and tide: Day, flood.

Snapper—Young of Blue Fish. August to November. Haunts: Rivers and all tide ways. Baits: Spearing and menhaden; trolling pearl squid. Time and tide: Day, all tides.

Sheepshead—June to October Haunts: Surf and bays, vicinity of old wrecks. Baits: Clams, mussels, shedder crabs. Time and tide: Day, flood only.

New England Whiting—Winter Weak-fish, Frost-fish. November to May. Haunts: The surf. Baits: Sand laut, spearing. Time and tide: Night, flood.

Hake—Ling. October to June. Haunts: Open sea surf, large bays. Baits: Clams, mussels, fish. Time and tide: Day and night, flood.

Weak-fish—Squeteague, Squit. June to October. Haunts: Surf, all tideways. Baits: Shedder crabs, surf mullet, menhaden, ledge mussels, sand laut, shrimp. Time and tide: Day and night, flood preferred.

Blue Fish—Horse Hackerel. June to November 1st. Haunts: Surf, open sea and large bays. Baits: Menhaden, surf mullet and trolling squid. Time and tide: Daytime; not affected by tides.

NOTES AND NOTIONS.

THEODORE GORDON.

When the katydid begins her song (?) I always feel that the best of the year is passed. The days are then much shorter and the songs of the birds have almost ceased. Frost may be expected, they say, in six weeks. The flight of theseasons is so rapid in this latitude that one has little time to become accustomed to any of the 4 until it has passed. Farther South this is not the case. The transitions are more gradual and extremes of temperature are not so great.

I know of no good fly fishing for trout

South of the mountains of Western North Carolina, but in the spring many fish of the perch tribe may be taken with fly in Southern waters. The big mouth, or Oswego, bass, of course; but blue or copper nose bream often take the fly well. In fact, they will almost swallow it sometimes, if it is not too large. This is a handsome fish, usually averaging about a pound in weight and is excellent on the table.

The approved style of fishing for bream used to be with a light cane rod, line of strong black thread, small cork float and hook baited with a lively worm. The bream collect in numbers, bedding it is called, in deep holes and the float is placed high enough to allow the worm to rest on the bottom.

Most anglers have a poor opinion of the pickerel found in so many of the ponds and lakes of the Eastern States, but I have had great sport in taking this fish with a fly rod and an artificial fly. They are free risers and if large will double up the rod in an interesting way. There is something fascinating in being able to see the fish rush up and close its long jaws on the fly.

I have taken a good many large wind-fish, or fall fish, with a fly. This fish probably resembles the English chub and is called chub in some localities. It is a silvery, shapely fish and when much fished for becomes very shy. The flesh is white, soft and rather sweet. I have known persons who preferred it to trout, but it is very bony.

A nearsighted old man who was fond of chub and who could not see the bones gratified his appetite by stuffing great chunks of chub into his mouth and combing the bones out afterward. It was an interesting sight, but proved rather trying to some of the ladies at the table.

I have many pleasant recollections of this fish and remember when I considered it good game. It sometimes reaches a weight of 3 pounds, but I never took one much over 2 pounds. If they refuse your flies or only follow them, grasshoppers, crickets, fresh water mussels and small frogs are all good baits. These fish often take your minnows, helgramites, crayfish and lamp-pens, when fishing for small mouth black bass in the Delaware river.

The common sun perch, or sunny, will sometimes take a small scarlet ibis fly, as fast as it can be cast to them. They are

not a bad pan fish if they were not so small. I have seen a few which may have weighed as much as half a pound each.

I once took a large gar on a fly, dressed on a number 6 hook. It rushed out from under some snags in a South coast river and took the fly, which, in some way, dug into the lower bill. By keeping the line taut, yet yielding to all the rushes of the fish, it was at last slid over the gunwale of the boat from which we were fishing.

I have heard a good deal of a Western fish sometimes called the grayling, which is said to take the fly freely, but, I understand, it is a species of whitefish. It seems to be confined to the Rocky mountain region, but I know little of the fish. Will some reader of RECREATION please enlighten me?

Probably there is no State in which such a variety of fish can be caught with the fly as in Florida. Friends of mine spending the winter at Homosassa years ago counted 13 species which they had taken at one time or another in the river near that place. I have had sport in purely salt water, however, and fly fishing on the lower coast is a well recognized sport. Redfish, or channel bass, sea trout, or spotted weakfish, crevalle, rovalle, bony fish and many others are caught. I have forgotten the names of many of the fish, but remember nothing more interesting in my Florida experience than ascending one of the small rivers on the West coast, which rise in immense springs and flow into the gulf. The tidal portions are, or were, crowded with fishes of nearly all the species which inhabit the gulf.

One pool, called the Alligator hole, in the Wickawatchee, was simply a great aquarium. Floating over it on a still day a wonderful sight was below us. On a bed of sand lay a large alligator which we had seen plunge in as we approached. Six great sawfish were slowly moving down stream. About some coral, or rock, were numbers of sheepshead and other fishes. There was a school of mullet and some large redfish. In fact, it was so interesting that one found it difficult to leave the show at all.

The redfish is widely and abundantly diffused along our Southern coast and is a fine fish for sport or the table. When small, say one to 3 pounds in weight, it is known as school bass. Those weighing 8 or 10 pounds are called stag bass; and the big fellows of 20 to 40 pounds become channel bass.

The reasons for all these cognomens are unknown to this deponent.

BE SURE YOU'RE RIGHT BEFORE YOU BUY.

While in New York I had occasion to buy a light salt-water rod. I asked where I might find a reliable sporting goods house, and was directed to J. B. Crook & Bro., 1180 Broadway. I went there, stated my wants and was shown a Horton steel rod. The price quoted me was \$10. Not being familiar with these rods and their prices, I paid the money and walked out. Later I went to Schoverling, Daly & Gales, where I was questioned as to the rod I was carrying with me. I showed it to the man who asked the question, told him what I had paid for it, and was shown exactly the same rod for \$6.75.

Naturally, I was not pleased at the thought that I had been "done" by Crook; so, on my way up town, I went back to their place and asked for an explanation. I was told by the clerk who sold me and the rod that it was impossible to duplicate it for less than \$10 in the city, as this was of finer material and was better made than the one I had seen at Schoverling, Daly & Gales'. He said he knew what rod they did handle, and that it was not good enough for the trade they (Crook & Bro.) were catering to. Naturally I believed him, as I did not think any man could make up such a lot of ramble without a particle of truth in it.

The next day I chanced to be in Saks Bros.' store, where I saw a rack of steel rods and asked as to their prices. I was told enough to know that Crook had lied to me. Since then I have written to the Horton Company and have their catalogue. The rod for which I paid \$10 is simply the one the company lists at \$6.75, and no other. I was therefore charged \$3.25 too much.

I ask you to print this so other L. A. S. members may look out for Crook & Bro.

E. H. Moulton, Jr., Seabreeze, Fla.

FISH PIRATES HELD UP.

In August last 2 Wisconsin game wardens captured 2 of the worst fish pirates in that State and had a high old time doing it. The names of the poachers are William and Charles Lawrence, and they had long had a reputation for being bad men. The officers dreaded a conflict with them, but the time finally came when the pair must be rounded up and corralled. Accordingly game wardens Gratz and Nelson went after them. The fight took place on the shore of Lake Mendota, near Pheasant Branch. The netters at first resisted the officers fiercely, kicking and beating them. Then the former took refuge in the water and refused to come out when ordered. One of the wardens leveled a rifle on the refugees and threatened to shoot unless the men came out. They did not like the looks of the inside of the rifle barrel, nor the temperature of

the lake water; so they finally threw up their hands and marched ashore. The officers then handcuffed them and took them to court, where William was fined \$75 and Charles \$25. William paid while Charles went to jail to think it over. The wardens captured a large seine and a basket of fish with the pirates. Game Warden Gratz took the fish and the seine to Madison in a wagon, while Nelson made the 2 prisoners row him across the lake in a boat. Later the wardens visited the rendezvous of the prisoners and burned their house and boats. It is hoped the Lawrence brothers will find some other means of making a living than that of stealing public property and selling it.

A DAY ON THE GUNNISON.

July 13, at 7 a. m., I left Cebolla, Colorado, with rod and basket, walked up stream one mile above Elk creek water tank and there entered the rapid riffles of the Gunnison. For the first half mile I only caught $\frac{1}{2}$ pound of trout. I felt, however, that my best fishing ground was just ahead. As I entered my favorite riffle at the second bend of the river above the tank I prepared to tackle the large rainbow from which I had received a strike on the previous day, not 4 feet from the same spot, just below a large rock in a dark, heavy riffle. I safely hooked the heavy weight that had so shrewdly puzzled me the day before. He headed down stream, and when the heavy drag of my Automatic persuaded him to change his course I had only a few feet of line remaining on the reel. The old boy fought deep and strong as he steered toward the deeper riffles among the rocks and sulked for a rest. I pulled on the line as hard as I dared and failed to move him. Soon he headed toward me and came to the quiet water, where he sighted his enemy and made for the riffles again. I let him have his own way and patiently waited till he turned up at my feet completely exhausted.

In another good riffle, not far below, I landed 2 rainbows a size smaller, and continued luckily until my basket was filled and its weight grew heavy on my shoulder. I reached the hotel at 1.30 p. m. with 16 $\frac{3}{4}$ pounds of fish, the largest a 4 $\frac{1}{2}$ pounder.

The Gunnison has proved a grand, beautiful and most interesting stream to me.

L. P. Ogg, Pueblo, Colo.

CAMPING IN MICHIGAN.

Last summer I spent 2 weeks on Long lake, 8 miles North of Alpena, Michigan. Fishing was our only sport, as all shooting is out of season in August. Fishing was only fair, consisting of spotted pike, bass, rock bass and perch. Our catches were small and we had only 6 or 7 messes of

fish for a party of 26. The largest fish caught was a 10 pound speckled pike, which I had the pleasure of hooking and landing easily with a Yawman & Erbe Combination Automatic reel. One bass weighed about 3 pounds. We used for bait largely shiners and 3 to 5 inch perch; also angle worms, at which the smaller fish bit freely. Bait is a troublesome question, minnows rather scarce and hard to get, worms small and scarce.

The only ground we could conveniently get to camp on was extremely rough, the boat landing was shallow, and boats had to be dragged ashore. This ground cost us \$5. All others wanted \$1 a day for a camp site. The most curious experience we had was in regard to the boat. We were charged \$1 a day for one boat or a dozen boats for one or a dozen weeks. We wanted 6 boats for 3 weeks. We had 2 or 3 boats that 2 days' rental should buy.

A man named Owens, on the North side of the lake, has a good farm, with excellent camping facilities and cottages. He will permit respectable people to camp free; cottage rental, boats and produce reasonable. I found him a gentleman and was sorry we had not known him before we set up camp.

L. C. Hughes, New Castle Junction, Pa.

MASSACHUSETTS BRISTLEBACKS IN MAINE.

I enclose clipping from the Standard, which I hope may furnish meat for a line or 2 in RECREATION. I am a reader of your magazine, and like to see the hogs roasted.

S. W. Budd, New Bedford, Mass.

The clipping referred to was:

Walter H. Butterfield has been for a few days at Dead river, Rangeley, Me., and has had excellent luck fly fishing. In one day he and a friend caught 87 trout, and another day 81. The largest weighed 2 $\frac{1}{2}$ pounds.

To my inquiry as to the truth of the report Mr. Butterfield replied:

On 2 out of the 5 days we were in camp at Black Brook we kept 160 trout. The other 3 days we kept 41, making a total of 201 trout. Seventy-nine were caught the last day, to take out from camp. There were 5 people in camp, but my friend and I were the only 2 that fished. The days we made our largest catches we fished the brooks, and most of the trout were small. We saved only enough to supply the wants of the camp. None of the fish were wasted. Walter H. Butterfield, New Bedford, Mass.

In the 2d paragraph of your letter, you practically contradict what you say in the 1st. However, accepting your statement as true, that you caught and kept 201 trout in 2 days and 79 in another, you and your friend appear to wear a good coat of bristles.—EDITOR.

NIBBLES.

It was reported to me that one day last summer W. H. Fisk and Ben Peabody, of Turtle Lake, Wisconsin, caught 130 bass in Pike lake. My inquiry as to the truth of this report elicited the following reply:

A friend and I caught 130 bass, besides some wall-eyed pike and pickerel out of Horse Shoe lake, $4\frac{1}{2}$ miles Northwest of Turtle Lake, using frogs for bait.

This is a fine country for fishing. The lakes are full of bass, pike and pickerel, besides lots of smaller fish; the rivers and brooks of rainbow and speckled trout.

B. D. Peabody, Turtle Lake, Wis.

It is not your fault that the lakes and streams in your vicinity are well stocked. If there were many such swine running at large as you and Fisk, your waters would have been depleted long ago. You and your kind will never be properly restrained in your work of slaughter until your State fixes a legal limit to the number of bass which anyone may take in a day and provides a prison penalty for violation.—
EDITOR.

A subscriber in Lexington, Ky., sends me a clipping from a local paper stating that 5 young men of that city recently went 4 miles from town after dark and began seining in a private pond belonging to N. F. Berry. The seiners were discovered in the act by A. G. Downing, L. F. Cassell, A. J. Campbell and H. E. Hall, who promptly opened fire on the poachers. The latter jumped into a buggy and a buckboard and started for home at top speed. The Downing party followed and kept on shooting until they entered the city, when the fugitives dodged into a side street and were lost to view. Two coats were picked up on the road, which were said to belong to 2 of the fugitives, and clots of blood were found on one of them, showing that one of the shots, at least, had taken effect. It is said that the party consisted of William Sargent, his father and Eugene Willis and 2 others, unknown to the pursuers. It is safe to bet these men will prefer to do their fishing in daylight hereafter and in accordance with the law.

It has just leaked out that Postmaster H. D. Hager, of Luzerne, got even with Deputy Game Warden Brewster, who caught him spearing trout. There is no justice at Luzerne, and Brewster had to take the postmaster 10 miles to Mio. Hager had the only team at Luzerne, and when the foxy postmaster collected his livery bill of \$6.50 he had enough to pay his fine and \$1.50 over. Brewster thinks traveling is expensive up here.—Exchange.

After all, Hager got only \$1.50 for the use of his team and his own time to drive from Luzerne to Mio and back, and it is not likely he would have cared to do the work at that price. Besides, Postmaster

Hager is now on the justice's docket as a lawbreaker and that is not flattering to a United States officer. The good people of Luzerne should make up a statement of this case, send it to the Postmaster General and ask that Mr. Hager be removed. The United States Government is spending many thousands of dollars every year in the propagation of fishes; and it is not likely that one of its departments would care to retain in office a man who violates a State law made to protect these fishes.—
EDITOR.

Roy Bingham, of this city, may be classed among your fish and game hogs. During the summer he fished in Bass lake, Willow, Ohio, and caught 453 small bass in one week, throwing almost all away.

Recently he was squirrel hunting, near Garrettsville, Ohio, and shot 234 grey squirrels in 3 days. What is your opinion of him?

Soak him hard!

Frank Belcher, Cleveland, Ohio.

I wrote Mr. Bingham asking if these statements were true and he replied:

It is correct and I don't think many can claim such a proud record.

Roy Bingham, East Cleveland, Ohio.

No decent man would be proud of such a record. No one but an ignorant, unprincipled man would be guilty of slaughtering fish and game as you say you have done; and even such a creature should be ashamed of it instead of boasting of it.—
EDITOR.

Peter Van Marin, of Grand Haven, fell into the hands of the Fish and Game Warden again yesterday, and for putting a net in Grand river he had to pay a fine of \$32.50. Complaint was made to Deputy Warden Brewster by A. B. Richmond and that official took the matter up at once. Van Marin was prosecuted by Deputy Warden Coulter before Justice Chappell, of Berlin, and the fine followed conviction. Van Marin was arrested one year ago for a similar offense, and on conviction he appealed to a higher court, where the verdict was confirmed. Deputy Brewster said last night that it is the policy of the department to give a prisoner a jail sentence, without alternative of a fine, on the third conviction.—
Grand Rapids (Mich.) Herald.

Mr. Richmond is a member of the League and this is not the first instance in which he has made trouble for lawbreakers.

It will be interesting to know whether Van Marin will break the law a third time and serve a term in jail. Will Mr. Richmond kindly keep me advised?—EDITOR.

If you wish to make a present to a man or boy who is interested in shooting, fishing, amateur photography, or nature study, give him a year's subscription to RECREATION. Nothing you can possibly buy for \$1 would give him so much pleasure as 12 issues of this magazine. Come early and avoid the rush.

GUNS AND AMMUNITION.

Anybody can shoot all day, but a gentleman will quit when he gets enough.

A HORSE GUN AS IS.

Some time ago a writer in the gun department of RECREATION made himself beautifully ridiculous by scoffing at the possibility of a 3,000 f. s. velocity. While I have long been a reader of RECREATION, I have not up to this time plunged into the ink well, but I am minded now to give this fatuously complacent critic another rag to chew.

It was my good fortune, while in England, a year ago, to become acquainted with the Hon. Seymour Kemp, a well known officer in the South African colonial service.

Planning a 2 months' trip Northwest from Delagoa bay, in search of elephants, he was having a rifle built that was to mark the limit in hand weapons. Like many writers to RECREATION, Kemp was a monomaniac on the subject of guns; and, like them, too, more of an oral expert than a hunter. But he had the money to gratify his peculiar crankism. He bossed, but he bossed with a roll of notes in his hand. Whitworth made the rough barrel and Purdy finished the contract.

The gun came to hand while we were staying with Lord Danvers on his magnificent estates near Trowbridge, lower Avon. The thing arrived one morning, handsomely crated. Kemp feverishly ripped open the covering, objecting that the servants would injure the weapon. His lordship, educated in the shooting of India, smiled good humoredly at Kemp's enthusiasm.

Finally the gun came to light, and a sweet weapon it was. The black barrel was nearly as thick as a baseball bat and the stock was that of a 4 bore shot gun. Kemp, who weighed 140 pounds, all told, tried to look pleased and picked up the cannon with an assumption of ease. He handed it to Lord Danvers.

"Eighteen pounds," said his lordship, shouldering it with some deliberation. He was right.

"I'll lay you 2 pounds that the recoil floors you," said he to Kemp.

"Done," returned Kemp, irritably.

A further investigation brought out a heavy parcel of cartridges, which, made on a special order, had cost the civil service man a shilling apiece, and a Woolwich test card.

This card, after a statement that the bullet weighed 500 grains and was patched with 31-100 inch hard copper, and the load 250 grains of cordite, gave the following interesting data. I have the card to-day: "Ten shots in 2 minutes; Wattfield

screen; temperature before firing, 72 degrees F.; velocity obtained, maximum, 4,032 f. s.; minimum, 3,918 f. s.; rise, 80 degrees, F.; penetration in oak, 76-80 in. var." This is an exact copy.

That afternoon we put up a target on an oak 6 feet in diameter, and, backing off 150 yards, Kemp fired his first and nearly last shot with the 45 smokeless. There was a detonation like the ripping of a steam pipe. Kemp went to the earth with a flapping of arms and legs. The bark flew from the oak; and 500 yards beyond and 300 to the right the chimney of a tenant's house silently exploded and threw its bricks in all directions. A woman emerged from the house and came across the meadow at a snail's pace. We were still chaffing Kemp when she came up. Lord Danvers reassured her and the tests ended for the day. Kemp could not be prevailed on to fire the rifle again and his lordship and I were also chary.

When we went out next day a man, leading a horse, was awaiting us near the great oak. I don't remember what ailed the brute, but he appeared very ill.

"Now, then, turn him loose, John," said Lord Danvers gaily. The man did so, and the cannon was brought to bear on the head of the animal, which was wearily clipping the grass. The horse fell as if he had trodden on a live wire and we rushed forward to investigate.

The remains could hardly be construed into a horse. The skull, in flinders, was distributed over half an acre of ground. Half of the spinal column had been removed, laying the breast open like a dressed fish. After smashing half of the pelvis the bullet made its exit near the root of the tail. While we were searching for pieces of bone Kemp suddenly uttered a cry of exultation; he had found the bullet. It was fused and battered almost beyond recognition. But Kemp gloated over it. I believe he has had it made into a watch charm.

Although he tried bravely to withstand the terrific recoil, Kemp was never able to do so and before I left England I secured it for a song. Kemp bought a 10 bore Paradox, and I have since heard he slew an elephant, though I do not believe that.

Home again, I had a machine rest and carriage built on my summer place and tested the experimental freak thoroughly. It was necessary. With a reduced load and a velocity of 2,000 f. s. it can be shot offhand with comfort, but with a velocity of 4,000 f. s. and a kick of heaven known

foot tons, a carriage and lanyard furnish the only way. The results are interesting:

As nearly as I can judge, the trajectory is 7 inches high at 500 yards. The penetration is $6\frac{1}{2}$ feet in seasoned oak, or $9\frac{1}{4}$ inches milled steel plates. The shells are about 12 bore and bottle necked to 45 caliber, and the load 250 grains of cordite, with a 500 grain copper patched ball. The breech bolt, which weighs 4 pounds, is held by quadruple lugs, superior to those of a certain rifle which uses only 3 and is crossbolted. The gun is, a single shot, weight 17 pounds 12 ounces. There is over an inch of metal around the chamber.

I should be glad to answer any question concerning this freak, and particularly I should like to hear from "40 caliber," to compare notes. I believe I have a winner as regards penetration, and am willing to back my belief to any reasonable amount.

R. Drummond, New York city.

HUNTING BIG GAME IN VERMONT.

It amuses me to hear the black-powder fossils praise their obsolete weapons. The old boys mean well, but they are behind the times. While their gun lore shows a certain insight, it lacks the keen perception which comes of sedulous catalogue study. Granted that most of them have killed tons of game, what do they know of the mutability of trajectory, the variable parabolic drift and the mystery of comparative foot pounds? Nothing! Absolutely nothing!

When they come on game at 200 or 300 yards they never stop to calculate the range, but blaze away with a 45-70 or an equally futile 45-90, and, intuitively allowing for the drop of the projectile, perforate their prey. Ask them how they do it, and they will reply: "Durned if I know; I just let the front sight stick up a ways, and let 'er go."

This may be crude art, but is it scientific? Are such methods consistent with the high plane of 20th century gunnery?

I am a scientific rifleman; ballistics is my business. I never travel without that shooter's encyclopædia—the Winchester catalogue, a book which should be read by every rifleman who aspires to be something more than an empiric. With 6 months' hard study you can learn the loading and the hunting-range trajectory of every cartridge of the American market; and in a year's time you will be an expert in ballistics and should be able to kill a deer at 1,000 yards by hypnotic suggestion.

I was once an advocate of black powder, and came to discard that evil smelling futility and align myself with the progressive spirit of the age in this way:

Two years ago I camped in the shadow

of Mount Mansfield, Vermont. I took my 50-100-450 Winchester, but at the last minute, mistrustful of its killing power, I also provided myself with a 4 bore slow twist, double-barrel elephant gun, burning 500 grains of powder and using a 4-ounce round ball. I knew I could rely on this weapon, for with that load I once shot clean through a dead horse, to the great detriment of its os occipital, os innominatum, os sacrum and other fundamental ossa.

While sitting before my tent, one morning, reading "Wild Animals I Have Punctured; or, The Autobiography of a Metal Patched Bullet," I perceived a bighorn clipping the grass on the very apex of the mountain. Dropping the book, I snatched up my telescopic range-finder and leveled at the unsuspecting animal. Adjusted to a sharp focus, the instrument indicated a range of 5,010 yards.

Here was a problem. The Winchester 50 caliber was sighted to only 4,090, and I feared the more powerful 4 bore would not prove accurate at such an extreme range. There being absolutely no cover, stalking was out of question.

I saw I must sacrifice principle and scientific calculation to the crude methods of old school hunters; I must hold over. So entering the tent I rolled out my pneumatic-tired, portable machine rest, and laid the Winchester in its carriage. After testing for wind and moisture, I made the necessary computation for the drift, screwed up the Vernier sight to its full height, and holding $2\frac{1}{2}$ inches over the animal's back, pulled the trigger. Forty seconds later, looking through the telescope, I saw the spent bullet strike the bighorn on the shoulder, and, rebounding from the fleecy armor, fall harmlessly to the ground. Then and there I became a smokeless powder convert. Seizing my jeweler's scales, I weighed out 690 grains of giant powder. Pouring this charge into the 4-bore, I rammed down 3 gilt edge wads and a 4-ounce copper patched ball. A little mental arithmetic deduced a variable velocity of 1,476 to 1,479 feet per second. This time I held on the head, realizing the large ball must otherwise inevitably spoil considerable meat. Then, after verifying my calculations I pulled the lanyard.

A dull boom shook the earth; the gun leaped under the thrust of the heavy charge; and the concussion inaugurated a small landslide.

But what was my horror immediately after to remember that I had neglected to allow for the drift, a deviation which, at that great range, would amount to 88 feet. But even as I stared anxiously through the glass the bighorn began to walk to the right at the rate of about 2 miles an hour. Hope swelled within my breast. I took out

my chronometer. The animal kept doggedly on, and at the end of exactly 30 seconds reached the line of fire and fell with a shattered skull.

Overcome at my great discovery I sat down and mopped my coldly perspiring brow. By a fortuitous accident I had stumbled on a new law of ballistics, to wit, "When shooting at a target moving to the right at the rate of 2 miles an hour, make no allowance for drift."

Only one trifling circumstance marred the joy of discovery. A slight chromatic aberration due to the imperfect lenses of my telescope had deluded me into shooting as a bighorn what proved only a common sheep. Its owner was wrathful and obdurate, and that droll mistake cost me \$25. But Galileo was also persecuted; and, after all, it's worth something to have made a discovery which totally eliminates the factor of drift from the problem of long range shooting, providing the object will kindly move in the right direction at the proper speed.

W. S. Crolley, St. Albans, Vt.

FOLLOW MANUFACTURER'S INSTRUCTIONS.

In his interesting article, "The Pistol from a Western Standpoint," printed in November RECREATION, Dr. E. F. Conyngham advises his readers not to use factory ammunition, but to load their own.

For some years I have loaded my revolver cartridges with Ideal tools. The results have been excellent; but I question the wisdom of the advice as a general proposition. There is no doubt that home loading sometimes produces velocity and penetration equal or even superior to those of the factory cartridges; but it rarely produces uniformity. The amateur may weigh his charges to a nicety and may load with the greatest skill and care, and still not obtain uniformity, without which accuracy is impossible. At short range, good work may be done, while long ranges show the defects of the ammunition to a surprising extent. The reason for the greater uniformity of factory loads will be appreciated when one stops to think that no 2 lots of powder, even from the same mill and formula, will give the same results. I am informed that the manufacturers of powder adopt a standard powder; that is, they say that a powder which gives a certain velocity when loaded in a certain way is the standard. Powders when so tested may develop velocities greater or less than the standard. By thoroughly blending lots of powder above and below standard an approximation to the standard may be obtained. To secure the standard velocity with powder not quite standard requires a slight change in the size of the charge. Cartridge factories, knowing the proper charge of each

lot of powder purchased, and loading thousands of rounds, are able to set their loading machines to secure the standard velocity. Unless the amateur possesses the same knowledge, he can not hope for the same results.

Factory loaded cartridges opened by amateurs are sometimes found to contain more or less powder than expected, and their inaccuracy is inferred. On the contrary, this variation in charge is proof of the care of the factory in loading.

The danger of loading is small to an expert, but great to the average amateur. The following story, told me by the powder expert of a well known powder company, illustrates this:

The expert was seated in his office one day, when a man entered carrying a pasteboard box. One arm was in a sling and he was generally torn up. In fact he looked as if he might be a game hog after an interview with Coquina.

"Are you the expert of this company?" he asked.

"Yes, sir," was the reply.

The visitor emptied his box on the table and spread out numerous twisted and broken fragments of metal and wood, some of which looked like pieces of a *ci devant* gun. Then, striking an attitude beside his relics, as if to include himself in the exhibit, he said,

"That's what your d——n powder did."

The expert gravely nodded.

"It seems to have developed considerable energy," he remarked.

"Well, what are you goin' to do about it?"

"Did you read and follow the instructions on the can?" asked the expert.

"Read 'em? Yes. Follow 'em? I guess I been shooting a gun 20 odd years, and when I can't shoot more than 2 drams in a 10 gauge gun, I'll quit shootin'. No, sir; I used 5 drams."

"What would you think of a man who put 10 drams of black powder in his gun?"

"He'd be a blamed fool."

"Well, sir, what you put in your gun was the equivalent of 10 drams of black powder. The inference is obvious. We furnish powder and instructions for its use, but we can not prevent their falling occasionally into the hands of 'blamed fools.' Good morning, sir."

R. R. Raymond, First Lieut., Corps of Engineers, U. S. A.

JAMMED A SAVAGE.

I had long anticipated a trip into the woods for the express purpose of killing a moose. I had a rifle which I knew was reliable, but having read so much about the Savage and its adaptation for killing large game, I decided to buy one and discard my

Winchester. I tried to persuade my friend, who was to accompany me, that he made a mistake in not buying one also, but he disagreed with me.

We went to Nova Scotia and engaged an exceptionally good guide. When ready for our first hunt I loaded the rifle in accordance with the instructions given by the Savage Company, but when I attempted to bring the lever lock back in place I could not close it. I worked over it 2 hours without effect, after which my friend, who is a good mechanic and understands a rifle thoroughly, took it in hand, but it was no use. One of the cartridges was stuck in the barrel in such a way that it was impossible for us to extract it or close the lever. There we were 38 miles from the nearest settlement and I had no rifle I could use. Fortunately, however, my guide had a Winchester which he let me take and with which I killed the largest moose brought to Shelbourne in many years.

When I reached home I succeeded in getting the shell extracted and took the rifle back to the dealer from whom I bought it. I told him I wanted to return it as, though it had been warranted in every way, it had proved worthless. A few days afterward I received a letter from the Savage Arms Company saying they regretted I should have had such an experience; that they had received the rifle and found it in perfect condition; that the trouble must have been with the ammunition and that I had not used that which they manufacture and recommend. But the fact was, I had used only their own ammunition, which I demonstrated by sending them the shell which was extracted after we reached home. They sent me a quantity of ammunition with the rifle when they returned it; but, I returned the weapon to the dealer and told him I did not want it at any price. All I wanted was to have the Savage people refund the money I had paid them. That, they refused to do. I would gladly have paid the price of the rifle twice over if I had found it reliable and could have killed a moose with it.

W. A. Cone, Springfield, Mass.

If the Savage people were as cranky as Marlin and Peters they would now withdraw their ad and bring a libel suit against me, as Paddy did. Keep your eye on Savage and see whether he follows Paddy's example.—EDITOR.

MINIATURE LOAD FOR 30-30.

Will someone explain through RECREATION why the Savage smokeless powder No. 1, 1899 brand, will not burn in a 30-30 W. C. F. shell? I loaded some of the shells for short range with 6 grains, according to directions, using No. 5 Win-

chester primers, and only about one-third of powder burned. Then I put in 12 grains and about 9 grains burned. My rifle is a '94 model Winchester carbine. The short range factory cartridges are all right.

A. L. Dawes, Harrison, Me.

ANSWER.

The W. C. F. shell is suitable; the powder is all right used as directed; the 6 grain charge is correct for the lead miniature and 10 to 12 grains is the proper charge for the metal jacketed miniature. The latter quantity also will answer for a hard 100 grain cast bullet, about one part tin to 8 or 9 parts lead; but the No. 5 Winchester primer should not have been used, as the directions on the can call for the No. 8½ U. M. C. primer. This is the only primer recommended by the Savage Company for use with their 1899 powder. At present they are using 2 powders; one for full loads and an entirely different grade for short range and reduced loads. Sometimes in using nitro powders, apparently some of the powder grains remain in the barrel unburned. Usually, however, this is debris or ash, remaining from the combustion of that part of the powder which did not burn in the chamber. If carefully collected and tested it will be found impossible to make it ignite. Try the 8½ U. M. C. primers, follow the loading directions exactly, and report if not satisfactory. Be sure the bullets you use for short range are the correct ones. The Winchester short range bullet is of lead, weighing 100 grains. The Savage has 2 short range bullets; one of lead and one metal jacketed with lead center, each weighing 100 grains. Push a lubricated lead bullet through the bore of your rifle carefully and see if it is a snug fit; if otherwise the small charge of nitro powder will not give sufficient upsettage, and gas cutting, with great inaccuracy will inevitably result. In using either the Winchester or Savage lead ball, employ little or no crimp, but with the Savage metal covered ball, a full crimp is necessary. The metal jacketed miniature stands up better than either of the lead balls, as more powder can be used. It also shoots cleaner with no danger of leading. The lead balls are inefficient at over 100 yards, while the metal jacketed balls hold up well at 200.—EDITOR.

A NEW SIGHT.

It is strange that in spite of the great advance in gun making, so little attention has been given to the improvement of sights. The same old coarse adjustment of the rear sight by graduated steps, with no thought of finer adjustment, save, perchance, the sight be fitted with a small

slide, controlled by a set screw, has been deemed all sufficient. A rifleman using such an equipment is likely to make his bull's eyes by luck if at all. There has been no provision for windage except by driving over one of the sights in its slot to the appropriate side, or by holding off; either makeshift giving but indifferent results. It has remained for A. W. Savage, of Savage rifle fame, to devise an improved rear site, which has been submitted to a number of riflemen for approval. The sight is made of tough steel, pressed by powerful dies into appropriate shape, and milled accurately to finish. At first glance it looks much like the ordinary rear V sight, and is made in either buckhorn style or with straight top. Though but slightly larger than the ordinary rear sight, it is provided with a fine, accurate, micrometer screw adjustment for both elevation and windage. The mechanism for elevation locks automatically, and windage, or lateral adjustment, can only be accomplished intentionally. The movements are adjustable to 1-1,000th inch, the graduations being clear and legible. A modification is provided by which the screws actuated by the fingers can be replaced by others actuated by screwdriver and pin. This latter provision was evidently an after thought of the inventor to circumvent the possible meddler. The dovetail base block is milled to standard size and will fit most modern rifles. The range of adjustment is ample; that for elevation being in considerable excess of that obtainable by the stepped elevator on the ordinary sporting rear sight. No one using open sights can fail to appreciate this new device.

E. B. G., Utica, N. Y.

ONE AS GOOD AS ANOTHER.

Nothing else I can find gives me so much real enjoyment as the articles in the Gun and Ammunition department of RECREATION. Some of the writers know a lot about guns and the others think they do; yet no 2 can agree as to the best gun, and they never will, since in the end skill counts more toward filling the game bag than any possible combination of wood, metal and gun powder. No one has yet seen an old blunderbuss whose fond owner would not say it was the best gun in the world. Thousands of us can testify to the great shots made and big bags of game secured with the old muzzle loaders. I doubt if better shooting is done now.

When it comes to rifles, all of us are paying the piper good and plenty for all we learn; and we are likely to continue doing so as long as new loads and calibers are introduced to keep us guessing.

I bought a Savage. "A good thing," they told me, "for anything from a quail

to a bear." After shooting it 1,000 times with different loads I doubt if I could today hit a barn door with it. On the other hand, I have a 32-40 Winchester which I have fired 5 times as often. It shoots better than when it was new. It has no recoil, is the most accurate load devised, and, for its power, the cheapest. If I were going elk hunting I should ask no better weapon.

Most of my large game shooting was done with a 73 model 44-40 Winchester, and of 42 deer hit by it I only lost 3. Most hunters shoot too quickly. With deliberate aim and steady holding one rifle will kill as well as another. I have a friend who uses a 22 Winchester for deer, and he gets them, too.

Wisconsin, Ottumwa, Ia.

THE REMINGTON-LEE NAVY.

I find in RECREATION many questions about the Remington-Lee rifle. I've used one of these guns 2 years with the greatest satisfaction. It is bored for United States Navy ammunition, .236 caliber. I consider this the finest cartridge made, and it would be difficult to persuade me to go back to larger calibers.

The Remington-Lee has many excellent points. It weighs but 6¾ pounds, is well balanced and neat in appearance. According to the Government test, made with the Lee straight pull, it has the greatest penetration, the flattest trajectory, and the highest velocity of any rifle made.

The velocity given by the Lee straight pull is 2,550 feet a second. Its penetration is 60 inches in dry pine. The penetration of the Krag-Jorgensen is 58 inches, and its velocity is but 1,960. The Remington-Lee, having the same rifling and shooting the same ammunition as the Lee straight pull, will doubtless shoot as well.

The Remington-Lee has excellent sights. It is, moreover, the fastest loader of any gun I know, the magazine being removable by simply touching a spring. Taking all things into consideration, I like it much better than the Savage or Winchester as a sporting rifle.

C. A. Goggin, Spearfish, S. D.

SMALL SHOT.

Please tell me if a 26-inch shot gun barrel will shoot as far and as hard as a 30 or 32 inch barrel. Also how much pressure should be used in loading nitro shells?

S. R. B., East Tilton, N. H.

ANSWER.

As between long and short barrels there is, with nitro powders, little difference in velocity. Both being choked the same, the longer barrel will give a better pattern than the other, and thus kill at a greater distance.

In high grade shells like the Winchester Leader and U. M. C. Smokeless, when

using a stiff, square crimp and a card wad next to powder, DuPont Smokeless requires about 50 pounds pressure; E. C. and Schultze, 40 pounds; the various dense powders, 40 to 60 pounds. For cheaper shells like the Winchester Repeater add 10 pounds pressure; for a round crimp add 5 more, and another 5 when a felt wad is used next the powder. Pressure should be made on first wad, after settling powder by tapping the shell. Put nearly as much pressure on each succeeding wad, except, of course, that over the shot.—EDITOR.

I recently had the pleasure of testing 2 Winchester 32 Specials, and I never shot a new rifle of any caliber that gave such good results, not excepting my favorite 32-40. Our range was 250 yards. We tried them thoroughly with full charge smokeless cartridges and afterward with same shells reloaded with black powder. Good close groups were made with each. While there is considerable recoil to the full charge smokeless there is little fouling, and an extremely flat trajectory for a medium twist barrel. I believe it will be the general purpose gun for hunters who want a long range rifle of great killing power, and for sportsmen generally, who like the 32-40. Those who have reloading tools for the latter need no change them. One good feature of the gun which will be appreciated is the fact that a Lyman rear might be used without removing the factory sight, as the latter can be lowered below point blank range.

F. M. Lewis, Chateaugay, N. Y.

In regard to using 16 gauge on wild fowl: While, of course, an 8 gauge would do more execution, still a man can get more real enjoyment with the smaller weapon. I use a 16 gauge Winchester repeater and Winchester Leader shells with $2\frac{1}{4}$ drams Schultze and $\frac{7}{8}$ ounces No. 7 chilled shot. For all game up to and including mallards I do not wish anything better. I made a score of 87 out of 98 clay pigeons last summer with this load at 15 yards rise. Made one run of 36. Because a man uses a repeating shot gun is no reason for branding him a hog. One good thing about the repeater is that you have more chances of stopping a wounded bird but I honestly believe I could get more game with a double barrel than with the repeater, because I have always been accustomed to the former weapon. Considering its price, the repeater has the best of the argument, as far as shooting and wearing qualities are concerned.

E. J. Selleck, Burnett Junction, Wis.

The article in December RECREATION,

page 462, over my signature, is not correct. It is misleading and was not authorized by me. The bullets mentioned in the article were not made by the National Projectile Works, but were made by hand and by an entirely different process from that used by the National Projectile Works. They were made by a process on which I hold a patent.

After the National Projectile Works completed their machines and commenced to make bullets, I carefully tested the bullets, and they did not prove satisfactory to me. I have never used them, and I have told the manager of the company that he must not use the statement, as, owing to the fact that the bullet as manufactured by the National Projectile Works had not given satisfaction, I considered the statement misleading and untrue.

Geo. H. Newell, Grand Rapids, Mich.

I notice some brother sportsmen have had trouble with their Winchesters while using Peters' shells. I have tried about every smokeless powder on the market. One day I bought 100 Peters' New Victor shells loaded with Kings smokeless. On arriving home and looking them over I discovered they had a square crimp and a poor one at that. I tried some through my Winchester and had trouble in forcing them into the chamber; but after I had run them through my round crimper they worked all right. They were $2\frac{3}{4}$ inch shells. Possibly there are some who do not know that a square crimped shell can not be successfully used in a Winchester shot gun.

F. Le Noir, Springfield, Mass.

After experimenting with various loads in the Savage rifle for short range for the past 4 years with poor success, I have adopted the 125 grain bullet as advised by Mr. Kephart in Ideal Hand Book. That bullet, cast 1 to 10, with 10 grains Savage powder is O. K. up to 100 yards. Beyond that to the horizon the full load soft nose is the thing; so for me the all around rifle is found. The bullet also works well with 10 grains Lafin & Rand Sporting Rifle smokeless.

T. W. Harrington, Greencastle, Ind.

I have a 25-20 Winchester single shot rifle, which I prize highly. It has killed woodchucks at 50 yards and squirrels at 40 yards. I like the 25 because it is effective, and does not tear the game. I should like to hear from RECREATION readers who have used smokeless powder in the Winchester 25-20.

H. H. Deane, Mingo Junction, Ohio.

NATURAL HISTORY.

When a bird or a wild animal is killed, that is the end of it. If photographed, it may still live and its educational and scientific value is multiplied indefinitely.

CIVILIZATION AND THE BIRDS.

ROY F. GREENE

Every student of bird life whose home is in the West, must have noted with interest the effect that civilization and settlement have had on the bird residents of that section.

In 1885 I first began to notice the feathered tribe that haunted the prairies, cliffs and timbered streams in what is now known as the Territory of Oklahoma. I was then living on my father's cattle ranch near the headwaters of Duck creek, a tributary of the Chicaskia river, in what was then the Cherokee strip, and is now Kay county. This ranch was 25 miles from the nearest town and postoffice, and at least 8 miles from any other ranch; so man's presence did not intrude over much on sylvan quietude.

Out on the prairies where long horn cattle grazed, the prairie hen made its nest and raised its brood undisturbed, and the lesser prairie hen was by no means an uncommon summer resident. The mountain plover nested abundantly on the wide prairie stretches and the snowy plover frequently raised its young on the alkali wastes and salt plains, a little farther Westward. I learned to know these birds well and frequently took clutches of their eggs, though I look back now with regret at my craze for oology in those days.

Marsh hawks, ferruginous, rough legs, poor wills, frosted poor wills, night hawks and Western night hawks were common on the prairies in the nesting season. Along the timbered creeks one could find in some high tree or low, some stubby bush or clump of poison vine, the nests of such interesting birds as the Mississippi kite, Cooper's hawk, red tailed hawk, red shouldered hawk, Swainson's hawk, American osprey, American long eared owl, and occasionally a bald eagle.

The vesper sparrow sang his song at dusk far from the haunts of men, and made his nest in a cavity of his own creation. The grasshopper sparrow, Henslow's sparrow, lark sparrow and prairie horned lark made the prairies their summer home, and when riding leisurely along on a cow-pony, I have had them fly up gingerly from their nests in the grass clumps only when the horse's hoofs had nearly touched their well hidden clutch of eggs.

Along the creek trails, flycatchers, Acadian flycatchers, wood pewees and the Western variety of the same, olive-sided

flycatchers, crested flycatchers, red-eyed vireos, white eyed vireos, Bell's vireos, yellow warblers, yellow breasted chats, long tailed chats, hooded warblers, American redstarts, mocking birds, catbirds, brown thrashers, wood thrushes, blue-gray gnat catchers and cardinals held merry carnivals of song, disported themselves among the tree tops and in the tangled thickets, and raised their little broods without fear of being dispossessed.

In 1893, only 9 years ago, but worrisome years for the feathered habitants, this prairie country was thrown open to white settlement. The grass lands, the wide prairie ranches, have been broken by the plow, and happy homes have been builded, towns and villages have sprung up, roads and bridges have been constructed, and the hand of man has carved the bust of civilization from the rough block of Nature.

Our quiet, unobtrusive birds have departed. The English sparrow seems to have been perched on the first settler's wagon that came into the new country. When the homesteader sank to slumber that first night on his virgin claim, the vesper sparrow sang him to sleep; when he awoke next morning the songster's belligerent British cousin had driven the soulful singer into the past. The mockingbird, the brown thrasher, the robin and the catbird decided to become civilized and stay. They have met the new conditions, and have seemingly prospered as well in the hedge fences as they did in the trees that skirted the prairie streams in the dear, dead years. The bronzed grackle, brewer's black bird, white rumped shrike and barn swallow nest in the settler's orchard and back yard, while the purple martin fights with the English sparrow for possession of the bird house by the barn.

The meadow lark still lives in the bit of prairie reserved for cow pasture, or in the fields of wheat; the Bob White, lark sparrow, dandy dickcissel, saucy chipping sparrow and mourning dove have remained; but our dearest loved ones have flown, to return perhaps no more.

The orchard and the Baltimore orioles nest where the vireos and warblers swung their grassy castles in air back in the used-to-be; the wood thrushes and gnat catchers have been replaced with the chattering blue jay and the pugnacious king bird. The scissor-tailed flycatcher, Bell's vireo, the yellow warbler and the long tailed chat are about all that are left us of our old time colony.

Out in the Western part of the new territory, where alkali lands and salt plains have proved uninviting to the homesteader, I am told that the black capped vireo and Cassin's sparrow nest now as they did in other days; and where a plot of prairie grass grows invitingly out there, the prairie hen, the snowy plover and mountain plover still make their nests; but civilization has driven my erstwhile bird neighbors of ranching days "out of the hitherwhere into the yon."

A RECORD-BREAKING GRIZZLY.

I am in sympathy with the spirit of G. H. Tremper's comment on Powell's bear story in October RECREATION, though I challenge the statement that there is no authentic record of a bear of what he calls "the preposterous" weight of 800 pounds dressed, or about 1,200 pounds live weight.

I agree that bears of that weight would be hard to find nowadays, except, perhaps, among the new species reported from Alaska; but I think that when grizzly bears were plentiful in California specimens of even greater size were encountered.

When I was a lad the fame of a man known as Grizzly Adams, a mighty hunter, filled the land. Many were the articles written about him, and the account of his capture of a particularly tremendous bear was known to everyone. The enormous tracks and wonderful doings of this bear were well known long before his capture.

Adams, determined to catch him alive, had a huge iron cage constructed in San Francisco and transported to the region frequented by the bear. It was arranged as a trap and baited, as I recall it, with honey and molasses. Adams was in the end successful in trapping the monster and exhibited it alive through the East. The weight claimed for it was 1,900 pounds.

There must be many persons still alive who remember Adams and his bear and can give us the facts in the case. I should very much like to see my recollection of this matter either corroborated or disproved.

C. H. Ames, W. Newton, Mass.

ANSWER.

There are few instances on record in which a grizzly bear has been weighed gross. In a great majority of reports as to the weights of these animals the figures have been based purely on guesswork. I have investigated a number of cases where men have said positively that grizzlies have been killed that weighed so-and-so, and in every case have learned that the bear was not weighed, but good judges who saw him estimated he would weigh so-and-so.

As I have several times said in RECREATION, I caused one large grizzly to be weighed accurately. This was old Bob, a famous bear that lived nearly his entire life in Union park, Chicago. He was taken there as a cub and died when a little over 18 years old. When it became known he was nearing his end, the Park Commissioners presented him to the College of Physicians and Surgeons, and I arranged with the curator of that institution to have the bear carefully weighed as soon as he died. This was accordingly done, and old "Bob" registered 1,153 pounds. Hundreds of old hunters and mountain men from the West, who saw Bob in his prime, said he was one of the largest bears they had ever seen, and they generally estimated his weight at anywhere from 1,500 to 2,500 pounds. For several years preceding his death he was so fat he could scarcely walk, and was in this condition when he died. So he may well be termed a record breaker.—EDITOR.

WHERE EAGLES ARE A PEST.

In September RECREATION you say in answer to Payson, "Yet I have never known an eagle to kill a domestic fowl or lamb, or to destroy any private property."

On the S. M. ranch, 20 miles Southeast of Roseburg, Oregon, eagles killed many lambs. At one time John Tilman, L. Robinson, Joseph Foreman and I saw 6 eagles eating lambs that they had killed.

The birds would alight in tree tops and often attack a lamb as soon as it was born. They would also kill lambs several days old, and always, so far as I know, devoured them on the ground, never carrying them away, as I had before supposed they did. When on the ground with the lamb you could ride up close before they would fly, often within 30 yards.

In this way 18 eagles were killed by our men during the spring of 1890. All were black, or rather gray, eagles, except one bald eagle.

I have no desire to enter into a controversy with you or Mr. Hornaday and simply state the facts as I saw them. All the persons named are alive, and if necessary I will send you their addresses.

At one time I rode within 30 feet of a large eagle sitting on a freshly killed lamb. The bird rose and alighted on a fir tree about 50 yards distant, where it was shot.

W. O. Marks, Portland, Ore.

ANSWER.

Mr. Marks's letter proves anew that there is no rule to which there are no exceptions. All fair-minded men must admit that the situation described indicates an abundance of eagles and an amount of de-

struction caused by them which is intolerable. I have visited many portions of our country, and nowhere have I found eagles so abundant and such a pest as in the locality mentioned by Mr. Marks. Undoubtedly there must be special reasons for this abundance; but whatever that may be, it is only fair to the ranchmen and sheep owners that the number of eagles should be reduced to a reasonable figure. I think it perfectly right, where such a condition exists, to kill off a certain number of eagles, and frighten the remainder into the hunting of fish and other prey more lawful than young lambs.—W. T. H.

UNDOUBTEDLY A BITTERN.

I see in October RECREATION a letter from P. P. Chase, of Ishpeming, asking about a certain bird he describes. I think it must be the same as seen some 7 years ago in that region. I was much interested in it at the time, but was unable to identify it. Some called it sandhill crane, but it was not. It resembled the turkey more than the crane, though its tail was short. The Rev. F. L. Forbes, of Pendleton, Oregon, secured a specimen which was shot at McMillan, Mich. He would gladly describe it for you though he is not a naturalist.

RECREATION comes in for a thorough reading each month. It is a sure relief for any symptoms of the blue Monday feeling that some preachers have. You are doing a great work in making unpopular the bristles and the greed of the game glutton.

Geo. W. Luther, Green Bay, Wis.

P. P. Chase, of Michigan, in October RECREATION describes a bird which has a striking resemblance to one we have here. This bird is called by the natives guareao. It is slightly smaller than a hen turkey, but has longer legs and bill. The bill is about 4 inches in length and resembles in shape the curlew's. Its color is dark brown with small white spots unevenly scattered over the back and wings. The under side is ashy white dotted with dark brown. Its call is a cackle or croak resembling somewhat that of the raven. The guareao frequents the low marshy grounds. In this locality these birds are numerous from March to June and are most seen and heard in the evening and early morning.

O. A. Fischer, Trinidad, Cuba.

In October RECREATION Mr. P. P. Chase asks someone to identify a bird which he noticed a short time ago while out driving. From the description he gives there is no doubt that the bird was an American bittern, *Botaurus lentiginosus*.

J. A. Loring, Owego, N. Y.

CALLING CROWS.

In many localities the crow has outgrown his usefulness by mere force of numbers. When we had but few of his kind they were a good thing and the law protected them, but to-day they may be found in flocks of countless thousands. Because of scarcity of food the crow has become more bold and now robs birds' nests wherever he can find them. He swoops down on a mother hen with her brood of little chicks and takes one at a time until there are none left. A farmer told me he had seen a flock of crows drive a turkey from her nest and destroy or carry off all the eggs before he could reach them. The crow is the only bird that has continued to increase in spite of breech loading guns, smokeless powder and chilled shot. He laughs at any attempt to fool him and knows just how far a gun will carry.

He goes on unmolested, robbing the nests of the song birds; the pheasant or grouse escapes him for a time perhaps, but he sees her hiding place at last and if himself unable to drive her off the nest he calls loudly for help. His fellows flock to his call and the first on the ground get a reward for hurrying, in the shape of an egg or chick. Lucky is the grouse that escapes the ever watchful eye of the crow.

Despite their cunning crows may be called like ducks to a blind. One can learn all the calls made by the crow; the call of distress, the call for help, the warning and all the other calls or caws. It will take some practice, but will yield more real sport than you have had for many a month. The only time I have ever thought I wanted a repeating shot gun was when calling crows. All crow calls can be imitated with the voice alone, and many of my friends in this community have learned to do this as successfully as I.

W. L. Blinn, Rockford, Ill.

REARING PHEASANTS.

I have been engaged for 3 years in rearing pheasants in a small way. My birds are cross between the Mongolian and the English varieties. The eggs hatch equally well under common hens and bantams; but the large fowls are more likely to crush the young birds. The chicks are rather tender until they are 3 weeks old.

No bird is more fond of grasshoppers and crickets than the young pheasant. Milk and eggs made into custard is the best food for young birds. When first hatched, the chicks easily escape from a coop that would not let a mouse through, and they will wander away from a hen if not confined. By the time they are 4 weeks old they have learned the call of the hen. Then the coops can be raised

enough to give the young birds their liberty.

The house cat will be found their greatest enemy; a cat that would not disturb domestic chickens will kill young pheasants without mercy. In fact, in this State at least, the homeless cat is the greatest destroyer of game and song birds.

The pugnacity of the cock pheasant will never make him any friends among farmers or poultry raisers. One of my neighbors unconsciously paraphrased Josh Billings by saying with great earnestness: "Pheasants are all right in their place, but Hades is the place for them." The thickly settled portions of the earth will never be the place for the pheasant; he belongs in the wilderness where there are no domestic fowls to bully.

The pheasant stands cold well. I never knew them to suffer in coops on open ground even when the mercury was 20 degrees below zero.

Geo. O. Greene, Princeton, Ill.

A TERRIER'S TRYST.

The article in November RECREATION headed "Can a dog think?" recalls an incident I had the pleasure of witnessing. Often since I have wondered whether or not dogs think.

One July evening in 1898 it was so hot that instead of retiring I decided to make myself as comfortable as possible sitting on a chair in front of the hotel at which I was staying. The landlord owned a Skye terrier named Mike. I saw Mike lying on the pavement near the curb with his head between his paws and his ears cocked, and at first I paid no particular attention to him. Finally I noticed that he got up every few minutes and looked intently up the street, always returning and assuming his previous attitude. This he continued almost an hour. Finally a mongrel about his own size came sauntering down the street and stopped opposite the hotel. Mike immediately crossed over and greeted him as dogs greet one another. They then started down the street, and as I had nothing to do I followed them to see what these canine friends had in view. Their objective point was the Susquehanna river, which is near the hotel. Arriving there Mike and his friend proceeded to take a bath, swimming about and chasing one another in the water until tired. They returned together. Mike stopped at his domicile, gave his friend a dog good-bye, stretched himself out on the pavement and soon was asleep.

The circumstances were so unusual that it looked to me as if these canine friends had had a previous understanding to meet and enjoy themselves in the cooling waters of the river.

F. M. Von Nieda, Harrisburg, Pa.

NATURAL HISTORY NOTES.

I am sorry to learn through your correspondent C. W. Gripp, of Pacific Beach, Col., that the road runner is becoming scarce. I first saw one when I was a boy in New Hampshire, where it was exhibited as the chaparral cock.

In after years I saw it in Texas and New Mexico where it was known as road runner, and I have heard, I think, 2 other names for it, "paiono" and another which I can not recall, but which I think was also Spanish.

What attracted my attention in Mr. Gripp's account was his statement that it was never killed to eat. I have never heard of the road runner as a game bird, but I have known of its being killed for food and eaten with relish. This being the case I have wondered why this bird, which is surely larger than many game birds, is not generally regarded as desirable for food. Is there any assignable reason for this?

C. H. Ames, W. Newton, Mass.

J. F. Cooper, of Half Rock, Me., who expresses his opinion in October RECREATION of the Belgian hare, evidently does not know much about his subject. The Belgian hare is one of the few animals that thrive better when confined than when given liberty. I have been breeding them some time. They furnish the most delicious and most digestible meat I have ever eaten. They thrive and do well in close confinement, if kept in a clean place. I venture to say that of the 200 I now have not one would be living in a month if they were given their liberty and not fed or protected. They are domestic animals and have been so long kept in confinement that they know nothing of self-protection or support. I do not think "the man who introduced them into this country" would have much to be "responsible for" in the way of damage done by them.

Dr. R. E. Franklin, Richmond, Va.

The article on the Richardson weasel recalls to my mind the following incident: One autumn day a friend and I, while skirting the edge of a wood, saw a large hawk high in air. It descended and rested on a stone pile a little distance from us. It had been there but a moment when it began to flutter its wings and appeared to be snapping at something. Then, with great effort, it took wing, but soon fell. It was dead when we reached it, and as we picked it up a small weasel fell from its body. We found the imprints of the rodent's teeth under one wing, where it had evidently been sucking the hawk's blood.

T. S. R., Rochester, N. Y.

THE LEAGUE OF AMERICAN SPORTSMEN.

OFFICERS OF THE L. A. S.

President, G. O. Shields, 23 W. 24th St., New York.

1st Vice-President, E. T. Seton, 80 West 40th St., New York.

2d Vice-President, W. T. Hornaday, 2969 Decatur Ave., Bedford Park, N. Y.

3d Vice-President, Dr. T. S. Palmer, Dept. of Agriculture, Washington, D. C.

4th Vice-President, A. A. Anderson, 80 West 40th St., New York.

5th Vice-President, Hon. W. A. Richards, General Land Office, Washington, D. C.

Secretary, A. F. Rice, 155 Pennington Ave., Passaic, N. J.

Treasurer, Austin Corbin, of the Corbin Banking Co., 192 Broadway, New York City.

ARIZONA DIVISION.

M. J. Foley, Chief Warden, Jerome.

ARKANSAS DIVISION

W. R. Blockson, Chief Warden, Eureka Springs.

CALIFORNIA DIVISION.

Dr. David Starr Jordan, Chief Warden, Leland Stanford University. C. Barlow, Sec.-Treas., Santa Clara.

COLORADO DIVISION.

A. Whitehead, Chief Warden, 303 Tabor Building, Denver.

CONNECTICUT DIVISION.

Hon. F. P. Sherwood, Chief Warden, Southport; Dr. H. L. Ross, Vice-Warden, Canaan; H. C. Went, Sec.-Treas., Bridgeport.

DISTRICT OF COLUMBIA DIVISION.

C. H. Townsend, Chief Warden, U. S. Fish Commission.

FLORIDA DIVISION.

W. W. K. Decker, Chief Warden, Tarpon Springs

GEORGIA DIVISION.

J. J. Doughty, Chief Warden, Augusta.

IDAHO DIVISION.

L. A. Kerr, Chief Warden, Kendrick

ILLINOIS DIVISION.

M. D. Ewell, M.D., Chief Warden, 59 Clark St., Chicago; F. M. Taber, Vice Warden, 144 Kinzie St., Chicago; G. C. Davis, Sec.-Treas., 123 S. Central Ave., Austin.

INDIANA DIVISION.

Frank L. Littleton, Chief Warden, 30½ East Washington St., Indianapolis; J. J. Hildebrandt, Vice Warden, Logansport; T. J. Carter, Sec.-Treas., State House, Indianapolis.

IOWA DIVISION.

Carl Quimby, Chief Warden, Des Moines; C. C. Proper, Sec.-Treas., Des Moines.

KANSAS DIVISION.

O. B. Stocker, Chief Warden, Wichita; A. J. Applegate, Sec.-Treas., 113 E. 1st St., Wichita

KENTUCKY DIVISION.

Geo. C. Long, Chief Warden, Hopkinsville.
R. L. Brashear, Sec.-Treas., Bowling Green.

MAINE DIVISION.

Col. E. C. Farrington, Chief Warden, Augusta.

MARYLAND DIVISION

J. E. Tylor, Chief Warden, Baltimore.

MASSACHUSETTS DIVISION.

Heman S. Fay, Chief Warden, Hazleton Block, Marlboro; J. E. Tweedy, Vice-Warden, North Attleboro; A. C. Lamson, Sec.-Treas., 194 Main St., Marlboro.

MICHIGAN DIVISION.

J. Elmer Pratt, Chief Warden, Grand Rapids; R. S. Woodliffe, Vice-Warden, Jackson; A. B. Richmond, Sec.-Treas., Grand Rapids.

MINNESOTA DIVISION.

Dietrich Lange, Chief Warden, 2294 Commonwealth Ave. St. Paul; H. A. Morgan, Vice-Warden, Albert Lea; A. R. Bixby, Sec.-Treas., 101 Baldwin St., St. Paul.

MISSOURI DIVISION.

Bryan Snyder, Chief Warden, 726 Central Bldg., St. Louis.

MONTANA DIVISION.

Professor M. J. Elrod, Chief Warden, Missoula; Sidney M. Logan, Vice-Warden, Kalispell; R. A. Waagner, Sec.-Treas., Bozeman.

NEBRASKA DIVISION.

Fred. E. Mockett, Chief Warden, Lincoln; P. O'Mahony, Sec.-Treas., Lincoln.

NEVADA DIVISION.

Dr. W. H. Cavell, Chief Warden, Carson.

Geo. W. Cowing, Sec.-Treas., Carson.

NEW HAMPSHIRE DIVISION.

Dr. A. F. Barrett, Sentinel Bldg., Keene, Sidney Conant, Sec.-Treas., Keene.

NEW JERSEY DIVISION.

Percy Johnson, Chief Warden, Bloomfield; Dr. W. S. Colfax, Vice-Warden, Pompton Lakes; I. V. Dorland, Sec.-Treas., Arlington.

NEW MEXICO DIVISION.

W. M. Borrowdale, Chief Warden Magdalena.

NEW YORK DIVISION.

John R. Fanning, Chief Warden, Powers' Bldg., Rochester; Col. R. E. Moss, Vice-Warden, Wallack's Theatre, New York City; Dr. C. C. Curtis, Sec.-Treas., Columbia College, New York City.

NORTH DAKOTA DIVISION.

Dr. W. D. Jones, Chief Warden, Devil's Lake.

OHIO DIVISION.

W. E. Gleason, Chief Warden, Mitchell Bldg., Cincinnati; A. C. Thatcher, Vice-Warden, Urbana.

OKLAHOMA DIVISION.

W. M. Grant, Chief Warden, Oklahoma City.

ONTARIO DIVISION.

C. A. Hammond, Chief Warden, Box 701, St. Thomas; D. L. Mells, Sec.-Treas., St. Thomas.

OREGON DIVISION.

Robert F. Kelly, Chief Warden, Box 188, The Dalles; C. B. Cushing, Sec.-Treas., The Dalles.

PENNSYLVANIA DIVISION.

C. F. Emerson, Chief Warden, 189 N. Perry St., Titusville; Hon. C. B. Penrose, Vice-Warden, 1720 Spruce St., Philadelphia; E. Wager-Smith, Sec.-Treas., 1026 Ridge Ave., Philadelphia.

RHODE ISLAND DIVISION.

Zenas W. Bliss, Chief Warden, 49 Westminster St., Providence.

SOUTH CAROLINA DIVISION.

C. F. Dill, Chief Warden, Greenville.

SOUTH DAKOTA DIVISION.

D. C. Booth, Chief Warden, Spearfish; John C. Barber, Sec.-Treas., Lead.

TENNESSEE DIVISION.

Hon. G. C. Martin, Chief Warden, Clarksville; Hon. Austin Peay, Jr., Sec.-Treas., Clarksville.

TEXAS DIVISION.

Prof. S. W. Stanfield, Chief Warden, Weatherford; W. E. Heald, Sec.-Treas., San Angelo.

UTAH DIVISION.

Hon. John Sharp, Chief Warden, Salt Lake City.

VERMONT DIVISION.

W. E. Mack, Chief Warden, Woodstock; S. C. White, Sec.-Treas., Woodstock.

VIRGINIA DIVISION.

Franklin Stearns, Chief Warden, 13 N. 11th St., C. O. Saville, Vice-Warden, Richmond; M. D. Hart, Sec.-Treas., 1217 East Main St., Richmond.

WASHINGTON DIVISION.

F. S. Merrill, Chief Warden, Spokane; F. A. Pontius, Sec.-Treas., Seattle; Munro Wyckoff, Vice-Warden, Pt. Townsend.

WEST VIRGINIA DIVISION.

E. F. Smith, Chief Warden, Hinton,
WISCONSIN DIVISION.Frank Kaufman, Chief Warden, Two Rivers; Dr.
A. Gropper, Sec.-Treas., Milwaukee.

WYOMING DIVISION.

H. E. Wadsworth, Chief Warden, Lander; Frank
Bond, Sec.-Treas., Cheyenne.*Applications for membership and orders for badges
should be addressed to Arthur F. Rice, Secretary, 23 W.
24th St., New York.*

LOCAL WARDENS IN NEW YORK.

County.	Name of Warden.	Address.
New York,	Conrad L. Meyer,	46 W. Broadway.
Livingston	M. De La Vergne,	Lakeville.
"	K. S. Chamberlain,	Mt. Morris.
Albany,	C. D. Johnson,	Newtonville.
"	Henry T. Newman,	"
"	Kenneth E. Bender,	Albany.
Broome,	John Sullivan,	Sanitaria Springs
"	R. R. Mathewson,	Binghamton.
Cayuga,	H. M. Haskell,	Weedsport.
Chemung,	Fred. Uhle,	Hendy Creek,
"	M. A. Baker,	Elmira.
Cortland,	James Edwards,	Cortland.
Erie,	E. P. Dorr,	103 D. S. Morgan Building, Buffalo.
"	Marvin H. Butler,	Morilla.
Essex,	W. H. Broughton,	Moriah.
Franklin,	Jas. Eccles,	St. Regis Falls.
Montgomery,	Charles W Scharf,	Canajoharie.
Oneida,	J. M. Scoville,	Clinton.
Orange,	Wilson Crans,	Middletown.
"	J. Hampton Kidd,	Newburgh.
"	Thomas Harris,	Port Jervis.
Richmond,	Lewis Morris,	Port Richmond.
St. Lawrence,	Dr. B. W. Severance,	Gouverneur.
"	A. N. Clark,	Sevey.
Schenectady,	J. W. Furnside,	Schenectady.
Suffolk,	F. J. Fellows,	Central Islip, L. I.
"	P. F. Tabor,	Orient, L. I.
Tioga,	Geo. Wood,	Owego.
Washington,	C. L. Allen,	Sandy Hill.
"	A. S. Temple,	Whitehall.
"	J. E. Barber,	Dresden.
Westchester,	George Poth,	Pleasantville.
"	Chas. Seacor,	57 Pelham Road, New Rochelle.
"	M. W. Smith,	Croton Falls.
"	Ralph Gorham,	Mt. Kisco
Dutchess,	A. B. Miller,	Jackson's Corners.
Columbia,	James Lush,	Memphis.
Onondaga,	B. L. Wren,	Penn Yan.
Yates,	Symour Poiner,	Branch Port.
"	Chas. H. DeLong,	Pawling.
Dutchess,	Jacob Tompkins,	Billings.
Queens,	Gerard Van Nostrand,	Flushing, L. I.
"	W. S. Mygrant,	46 Elton Street, Brooklyn.
"	P. A. Geepel,	473 Grand Ave., Astoria, L. I.
"	L. B. Drowne,	119 Somers Street, Brooklyn.
Ulster,	M. A. DeVall,	The Corners.
"	Wm. S. Mead,	Woodstock.
Jefferson,	C. J. Smith,	Watertown.
Herkimer,	D. F. Sperry,	Old Forge.
Oswego,	J. E. Manning,	154 West Utica St.
Putnam,	H. L. Brady,	Mahopac Falls.
Schuyler,	G. C. Fordham,	Watkins.
Allegany,	G. A. Thomas,	Belvidere.
Schoharie,	O. E. Eigen,	Sharon Springs.
Warren,	Geo. McEchron,	Glen Falls.
Orleans,	J. H. Fearby,	E. Shelby.
Greene,	W. J. Soper,	Windham.

LOCAL WARDENS IN OHIO.

Stark,	A. Dangeleisen,	Massillon.
Franklin,	Brook L. Terry,	208 Woodward Av., Columbus.
Cuyahoga,	A. W. Hitch,	161 Osborn St., Cleveland.
Clark,	Fred C. Ross,	169 W. Main St., Springfield.
Erie,	David Sutton,	418 Jackson St., Sandusky.
Fulton,	L. C. Berry,	Swanton.
Hamilton,	W. C. Rippey,	4465 Eastern Ave., Cincinnati.

County.	Name of Warden.	Address.
Allen,	S. W. Knisely,	Lima.
Knox,	Grant Phillips,	Mt. Vernon.
Lorain,	T. J. Bates,	Elyria.
Ottawa,	Frank B. Shirley,	Lakeside.
Muskingum,	Frank D. Abell,	Zanesville.
Scioto,	J. F. Kelley,	Portsmouth.

LOCAL WARDENS IN CONNECTICUT.		
Fairfield,	George B. Bliss.	2 Park Row, Stan- ford, Ct.
"	Harvey C. Went,	11 Park St., Bridge port, Ct.
Fairfield,	Samuel Waklee,	Box 373, Stratford.
Litchfield,	Dr. H. L. Ross,	P. O. Box 100, Ca- naan, Ct.
Middlesex,	Sandford Brainerd,	Ivoryton.
New Haven,	Wilbur E. Beach,	318 Chapel Street, New Haven, Ct.
"	D. J. Ryan,	188 Elizabeth St., Derby.

LOCAL WARDENS IN MASSACHUSETTS.		
Norfolk,	Orlando McKenzie,	Norfolk.
"	J. J. Blick,	Wrentham.
"	S. W. Fuller,	East Milton.
Suffolk,	Capt. W. J. Stone.	4 Tremont Row, Boston.
Worcester,	B. H. Mosher,	Athol.

LOCAL WARDENS IN NEW JERSEY.		
Mercer,	Jos. Ashmore,	124 Taylor St., Trenton
Mercer.	Edw. Vanderbilt,	Dentzville, Trenton
"	Roland Mitchell,	739 Centre St., Trenton.
Morris,	Joseph Pellet,	Pompton Plains
"	Chas. W. Blake,	Dover.
"	Francis E. Cook,	Butler.
"	Calone Orr,	Hibernia.
Somerset,	G. E. Morris,	Somerville.
Sussex,	Isaac D. Williams,	Branchville.
Union,	A. H. Miller,	Cranford.
"	C. M. Hawkins,	Roselle.
Warren,	{ Jacob Young,	{ Phillipsburg.
"	{ Reuben Warner,	{
Monmouth.	Dory-Hunt,	Wanaque.
Hudson,	A. W. Letts,	51 Newark St., Hoboken.

LOCAL WARDENS IN PENNSYLVANIA.		
Jefferson,	John Noll,	Sykesville.
Perry,	Samuel Sundry,	Lebo.
Warren.	F. P. Sweet,	Goodwill Hill.
"	Nelson Holmes,	Cornplanter.
Juniata,	Clifford Singer,	Oakland Mills.
"	Ezra Phillips,	McAlesterville.
Venango,	G. D. Benedict,	Pleasantville.
Potter,	Ira Murphy,	Coudersport.
"	Wiley Barrows,	Austin.
"	Chas. Barrows,	Austin.
Crawford,	Jasper Tillotson,	Tillotson.
"	Geo. T. Meyers,	Titusville.
"	J. B. Lamb,	Buel.
Cambria,	W. H. Lambert,	720 Coleman Ave., Johnstown.
Butler,	F. J. Forquer,	Murrinsville.
Allegheny,	S. H. Allen,	Natrona.
Beaver,	N. H. Covert,	Beaver Falls.
"	W. R. Keefer,	"
McKean,	C. A. Duke,	Duke Center.
"	L. P. Fessenden,	Granere.
"	Wm. Holsinger,	Stickney.
Lackawanna,	Wm. Weir,	Moosic.
"	Wm. Major,	"
Carbon,	Asa D. Hontz,	East Mauch Chunk.
Cumberland,	J. C. Gill,	Mechanicsburg.
Wyoming,	Cyrus Walter,	Tunkhannock.
Tioga,	E. B. Beaumont, Jr.,	Lawrenceville.
"	G. H. Simmons,	Westfield.
Lycoming,	Jas. J. Brennan,	Oval.
"	B. D. Kurtz,	Cammal.
Delaware,	Walter Luson,	Ardmore.
Montgomery,	L. C. Parsons,	Academy.
Bradford,	Geo. B. Loop,	Sayre.
Clarion,	Isaac Keener,	New Bethlehem.
Cameron,	Harry Hemphill,	Emporium.
Clinton,	M. C. Kepler,	Renovo.
"	Geo. L. Kepler,	Renovo.
Northumber-land,	{ G. W. Roher,	{
Elk,	{ 505 Anthracite St.,	{ Shamokin.
"	D. R. Lobaugh,	Ridgway.

LOCAL WARDENS IN MICHIGAN.

County	Name of Warden.	Address.
Ottawa,	W. H. Dunham,	Drenthe.
Kalamazoo,	C. E. Miller,	Augusta.
Berrien,	W. A. Palmer,	Buchanan.
Cass,	Thomas Dewey,	Dowagiac.
Hillsdale,	C. A. Stone,	Hillsdale.
Lake,	John Trieber,	Peacock.

LOCAL WARDENS IN VIRGINIA.

Mecklenburg,	J. H. Ogburn,	South Hill.
King William,	N. H. Montague,	Palls.
Smythe,	J. M. Hughes,	Chatham Hill.
King & Queen,	R. D. Bates,	Newtown.
Louisa,	J. P. Harris,	Applegate.
Henrico,	W. J. Lynham,	412 W. Marshall.
East Rockingham,	E. J. Carickhoff,	Richmond.
		Harrisonburg.

LOCAL WARDENS IN WYOMING.

Fremont,	Nelson Yarnall,	Dubois.
Uinta,	{ S. N. Leek,	{ Jackson.
	{ F. L. Peterson,	{
Carbon,	Kirk Dyer,	Medicine Bow.
Laramie,	Martin Breither,	Cheyenne.

LOCAL WARDENS IN TENNESSEE.

Sumner,	W. G. Harris,	Gallatin.
Stewart,	John H. Lory,	Bear Spring.
Robertson,	C. C. Bell,	Springfield.
Montgomery,	P. W. Humphrey,	Clarksville.
Madison,	H. T. Rushing,	Jackson.

LOCAL WARDENS IN NEBRASKA.

Hall,	E. C. Statler,	Grand Island
-------	----------------	--------------

LOCAL WARDENS IN NEW HAMPSHIRE.

Cheshire,	S. C. Ellis,	Keene.
Sullivan,	G. A. Blake,	Lempster.
"	J. W. Davidson,	Charlestown.

LOCAL WARDENS IN VERMONT.

Rutland,	Wm. J. Liddle,	Box 281, Fair Haven
Windsor,	F. A. Tarbell,	West Bridgewater.
Orleans,	E. G. Moulton,	Derby Line.
Essex,	H. S. Lund,	Granby.

LOCAL WARDENS IN ILLINOIS.

Rock Island,	D. M. Slottard,	12th Ave and 17th St., Moline.
Iroquois,	J. L. Peacock,	Sheldon.

LOCAL WARDENS IN OKLAHOMA.

Kiowa and Comanche Nation,	A. C. Cooper,	Ft. Sill.
----------------------------	---------------	-----------

LOCAL WARDENS IN IOWA.

Clinton,	D. L. Pascol,	Grand Mound.
Pottawattamie,	Dr. C. Engel,	Crescent.

LOCAL WARDENS IN WASHINGTON.

Okanogan,	James West,	Methow.
Stevens Co.,	Jacob Martin,	Newport.

LOCAL WARDENS IN UTAH.

Washington,	S. C. Goddard,	New Harmony.
"	J. A. Thornton,	Pinto.

LOCAL WARDENS IN KANSAS.

Ness,	Frank Lake,	Ransom.
-------	-------------	---------

LOCAL CHAPTERS.

		Rear Warden.
Albert Lea, Minn.,	H. A. Morgan,	"
Angelica, N. Y.,	C. A. Lathrop,	"
Augusta, Mont.,	H. Sherman,	"
Austin, Minn.,	G. F. Baird,	"
Austin, Pa.,	W. S. Warner,	"
Boston, Mass.,	Capt. W. I. Stone,	"
Buffalo, N. Y.,	H. C. Gardiner,	"
Cammal, Pa.,	B. A. Ovenshire,	"
Champaign Co., O.,	Hy. F. MacCracken	"
	Urbana,	"
Charlestown, N. H.,	W. M. Buswell,	"
Cheyenne, Wyo.,	J. Hennessy,	"
Choteau, Mont.,	G. A. Gorham,	"
Cincinnati, Ohio,	B. W. Morris,	"
Coudersport, Pa.,	I. L. Murphy,	"
Cresco, Iowa,	J. L. Platt,	"
Davis, W. Va.,	J. Heltzen,	"
Dowagiac, Mich.,	W. F. Hoyt,	"
East Mauch Chunk, Pa.,	E. F. Pry,	"
Evansville, Ind.,	F. M. Gilbert,	"
Fontanet, Ind.,	W. H. Perry,	"
Ft. Wayne, Ind.,	W. L. Waltemarth	"
Great Falls, Mont.,	J. M. Gaunt,	"
Heron Lake, Minn.,	K. C. Buckeye,	"
Hollidaysbg, Pa.,	H. D. Hewit,	"
Hopkinsville, Ky.,	Hunter Wood,	"
Indianapolis, Ind.,	Joseph E. Bell,	"
Jerome, Ariz.,	Dr. L. A. Hawkins,	"
Johnsonburg, Pa.,	W. J. Stebbins,	"
Kalispell, Mont.,	John Eakright,	"

Keene, N. H.,	F. P. Beedle,	Rear Warden.
Kingfisher, Okla.,	A. C. Ambrose,	"
Lake Co., Ind.,	Dr. R. C. Mackey,	"
Lawton, O. T.,	Marion Miller,	"
Logansport, Ind.,	E. B. McConnell,	"
Ludington, Mich.,	G. R. Cartier,	"
Mechanicsburg, Pa.,	Dr. J. H. Swartz,	"
Minturn, Colo.,	A. B. Walter,	"
New Albany, Ind.,	Dr. J. F. Weathers,	"
New Bethlehem, Pa.,	Isaac Keener,	"
Penn Yan, N. Y.,	Dr. H. R. Phillips,	"
Princeton, Ind.,	H. A. Yeager,	"
Reynoldsville, Pa.,	C. F. Hoffman,	"
Ridgway, Pa.,	T. J. Maxwell,	"
Rochester, N. Y.,	C. H. McChesney	"
St. Paul, Minn.,	O. T. Denny,	"
St. Thomas, Ont.,	L. J. Hall,	"
Schenectady, N. Y.,	J. W. Furnside,	"
Seattle, Wash.,	M. Kelly,	"
Syracuse, N. Y.,	C. C. Truesdell,	"
Terre Haute, Ind.,	C. F. Thiede,	"
The Dalles, Ore.,	C. B. Cushing,	"
Walden, N. Y.,	J. W. Reid,	"
Wichita, Kas.,	Gerald Volk,	"
Winona, Minn.,	C. M. Morse,	"

DISCOUNTS TO LEAGUE MEMBERS.

The following firms have agreed to give members of the L. A. S. a discount of 2 per cent. to 10 per cent. on all goods bought of them. In ordering please give L. A. S. number:

- Syracuse Arms Co., Syracuse, N. Y. Guns.
- Davenport Fire Arms Co., Norwich, Conn. Shot guns, rifles.
- Gundlach Optical Co., Rochester, N. Y. Photographic goods.
- Blair Camera Co., Rochester, N. Y. Photographic goods.
- The Bostwick Gun and Sporting Goods Co., 1528 Arapahoe St., Denver, Col.
- James Acheson, Talbot St., St. Thomas, Ontario, Sporting goods.
- Jespersen & Hines, 20 Park Place, New York City

LIFE MEMBERS OF THE LEAGUE.

- W. D. Ellis, 136 W. 72d street, New York City.
- A. F. Rice, 155 Pennington avenue, Passaic, N. J.
- Dr. W. A. Valentine, 5 W. 35th street, New York City.
- A. A. Anderson, 6 E. 38th street, New York City.
- A. V. Fraser, 478 Greenwich street, New York City.
- E. S. Towne, care National Bank Book Co., Holyoke, Mass.
- F. G. Miller, 108 Clinton street, Defiance, Ohio.
- Gen. J. F. Pierson, 20 W. 52d street, New York City.
- E. T. Seton, 80 W. 40th street, New York City.
- J. H. Seymour, 35 Wall street, New York City.
- A. G. Nesbitt, Maple street, Kingston, Pa.
- D. C. Beard, 204 Amity street, Flushing, L. I.
- C. H. Ferry, 1720 Old Colony Bldg., Chicago, Ill.
- Hon. Levi P. Morton, 681 5th avenue, New York City.
- H. Williams, P. O. Box 156, Butte, Mont.
- D. B. Fearing, Newport, R. I.
- E. H. Dickinson, Moosehead Lake, Me.
- Lorenzo Blackstone, Norwich, Conn.
- A. L. Prescott, 90 W. Broadway, New York City.
- G. S. Edgell, 192 Broadway, New York City.
- W. B. Mershon, Saginaw, Mich.
- Hon. H. W. Carey, East Lake, Mich.
- George Carnegie, Fernandina, Fla.
- Andrew Carnegie, 2nd, Fernandina, Fla.
- Morris Carnegie, Fernandina, Fla.
- W. L. Underwood, 52 Fulton street, Boston, Mass.
- C. E. Butler, Jerome, Ariz.
- Mansfield Ferry, 183 Lincoln Park, Boulevard, Chicago, Ill.
- Austin Corbin, 192 Broadway, New York City.
- J. Stanford Brown, 489 Fifth Ave., New York City.
- W. H. Smith, Bryn Mawr, Pa.
- E. B. Smith, Bourse Bldg., Philadelphia, Pa.
- A. J. McClure, 158 State street, Albany, N. Y.
- Walter Thompson, Times Bldg., New York City.
- Clinton Gilbert, 2 Wall St., New York City.

There are thousands of men in the United States who should be life members. Why don't they join? Will someone please take a club and wake them up?

OHIO'S CONTRADICTION GAME LAW.

I have investigated the alleged killing of pheasants at Chillicothe. It appears that the birds were ruffed grouse, perhaps crossed with Mongolian pheasants. They were shot during the open season. Even if we could prove they were Mongolians we could not, under our badly mixed game laws, prosecute any one for killing them, but only for having them in possession before 1903.

The farmer element of the last Legislature got the idea that all the legislation we proposed was for the benefit of city sportsmen. So by the end of the season the game laws were in a deplorable condition; one section permitting game to be killed at almost any time, while another section prohibits its possession during that time. We are getting along the best we can until the General Assembly again convenes and we can have things straightened out.

Despite the unfavorable conditions, our deputies collected over \$4,000 in fines last year. We put out over 2,000 Mongolian and English pheasants, besides distributing nearly 600 settings of eggs. All the birds are doing nicely as far as we can learn.

Compared to the amount of game in our State, the violations of law that escape our notice are few.

L. H. Reutinger, Athens, O.

The above was written more than a year ago.—EDITOR.

Our State Game Warden suggests a law to prohibit the giving away of protected game and fish. Such a law would undoubtedly have a good effect. I know men in this town, well fixed financially and expert shots, who spend 3 or 4 days afield every week during the open season. They slaughter 15 to 50 birds a day and give them to their friends. Some of these men go North where birds are more plentiful, and send down all they can kill. They are game butchers and game hogs in every sense of the word; yet they observe the law and do neither more nor less than the law gives them a right to do. They are doing more to exterminate game than any other class of hunters.

Things are well stirred up in this vicinity and popular sentiment is in favor of better protection for game. If a good bill is introduced in the Legislature and properly pushed, it will go through.

J. Elmer Pratt, Grand Rapids, Mich.

The work which RECREATION has accomplished in Michigan, together with the help it has had from the Division members, who have co-operated with the State officials, is remarkable. A great many important

arrests have been made and in nearly every instance a conviction has been secured. The deputies have also been aided by L. A. S. members in States adjoining us. J. Elmer Pratt, C. W. Mich Div. L. A. S., Grand Rapids, Mich.

THE GAME HOG.

R. R. R.

He was a hunter famed afar
For his astounding luck;
He loved to take a railroad car
And fill it up with duck.

And when he had arranged the pile,
Wild envy to awaken,
He'd conjure up his sweetest smile
And have his picture taken.

"See here," he cried, "my bid for fame;
And I should like to state
You'll find the number of my game
Nine hundred ninety-eight."

"Nine hundred ninety-eight?" said we,
"You must have missed the dog!
A thousand head of game we see,
You didn't count the hog."

But never word his hand could stay;
He swore that he would go
The even tenor of his way—
Why not? he'd like to know!

And so he would prepare to slay,
And hie him to the chase;
The even tenor of his way
Was very, very base.

His fill of game he still would get,
Whene'er he tramped the fields;
The little animals he met
Were much in need of Shields.

Herewith find \$1 for which please send me RECREATION for one year beginning with November number. I am, and have been ever since I first saw a copy of RECREATION, an ardent admirer of your magazine and of you and your work for the protection of game. I have read other magazines but I consider RECREATION by far the best of all. Your Gun and Ammunition department is especially interesting.

Walter M. Carlebach, New York City.

Mike—Begobs! we won th' shtrike, afther bein' out tin months.'

Pat—Tin months? But phwy ain't ye workin'?

Mike—Oh, we voted t' take a week off t' cilibrate th' victory.—Exchange.

FORESTRY.

EDITED BY DR. B. E. FERNOW,

Director of the New York School of Forestry, Cornell University, assisted by Dr. John C. Gifford of the same institution.

It takes 30 years to grow a tree and 30 minutes to cut it down and destroy it.

GAME AND FOREST PRESERVES.

The egotistic vandalism of cutting down and burning forests, by individuals indifferent to the welfare of the community, will prove a calamity for this country if strong measures are not taken to provide for the regeneration of the woods and game by establishing preserves, both governmental and private.

Game is a source of great revenue to many States; and the maintenance of the woods and agriculture depends largely on the wild animals and birds. Careless deforestation is especially destructive in Northern States, where the growth of animals and plants is less rapid than in Southern States.

In the East Indian Dutch colonies, with their tropical climate, a complete forest culture is established; but even in the British East Indies there is only crude forest preservation, often nothing but the prevention of forest fires. I have been in that part of the globe and in almost every country of Europe. Being a graduate of the Agricultural University of Halle and the Academy of Forestry, Munden, and having been in 6 States of this country, I am convinced that only a rigid protection of private forest and game preserves will prevent a calamity which is underestimated by most people. Private preserves will be more effective than government preserves. There is great need of good men and there is plenty of room for improvement and good advice.

A forest should be a producer, or at least a preserver of the woods, and a harvester only to such an extent as is needed to perpetuate and improve a forest. From a standpoint of profit, private preserves will win. In such preserves the objects are: The perpetuation of the woods; the protection of game; the purifying of the air and the tempering of the climate; the beautifying of the landscape; recreation, which includes sport, pleasure and health. The protection of the hillsides and the regulation of the water flow are natural consequences.

In such preserves the coppice system, with standards, should be partly used, as a first class game protection; or, if this is not possible and underbrush is not allowed, then game should be domesticated, as in European preserves.

C. Boudewijns, Hoboken, N. J.

The above letter is printed for some of

the suggestions it contains; some of the positions taken by the writer will, no doubt, amend on longer sojourn in this country.—
EDITOR.

Mistakes are often made in stocking forests and waters. Importing quails from Southern to Northern States need not be a failure. Neither cold nor snow will kill quails in well managed preserves.

Quail, *Colinus virginianus*, which is sometimes incorrectly called partridge, but which is not the same as the European partridge, *perdrix*, is to some extent migratory by nature, and will, therefore, when imported from warmer climates, that is, when not born on the spot to which it is taken, surely move to warmer, well protected places during the cold winters. They will not fly so far as does the European quail, *wachtel*, but they will leave the mountains for warmer places, or the treeless plains to find protection where there are plenty of underbrush, woods, hillsides, etc., for shelter. Snow does not kill quails; neither does cold, as long as they can find shelter under pine trees, rocks, berry bushes, shrubs, etc. Wet, cold weather kills them by flocks, even in summer.

To raise quails from eggs by incubators and brooders is not hard, but a thorough knowledge of the life of the birds is needed to keep them and have them multiplied on the preserve. A thorough knowledge of the bird's habits is also needed in transplanting grouse. This bird can not be successfully reared in pine woods or where underbrush is lacking. Neither is grouse at home near roads, factories, playgrounds, etc. However, as soon as the deciduous trees shed their leaves Mrs. Grouse moves to the pine woods, to return later to the first woods.

I have never had trouble in incubating and raising pheasants, quails, guinea hens, etc., but there is a great difference in the methods of raising these birds, even of different varieties of the same species. Geese eggs are the hardest to hatch; still I have found the secret of successfully hatching and raising them.

It is a mistake to try to raise pheasants by themselves. In that case they will seldom get sufficiently tame to be handled. Always mix about 1-5 their number of Crown Leghorn chickens of the same age with them. Another mistake is to raise

Belgian hares for game purposes. It is the same nonsense as to raise a high bred English pig for game. The Belgian hare is too innocent, and when matured and well fed too heavy and lazy, slow and stupid to make sport. I do not see anything wrong in shooting 25 or 50 more quails on private preserves, because the club bears the expenses of raising again as many or more quails and there is no fear of extermination; but to shoot a Belgian hare, an animal that is too dull, stupid and innocent to run away, is little less than murder. It is a good plan to cross the Western jack rabbit with the German rabbit; but one should know that jack rabbits never will stay where there are many hares. The restlessness of the latter causes a constant noise as they move in the fallen leaves.

A good advice for owners of large preserves where deer, elk, etc., are to be hunted is to prevent the accidental shooting of members.

Not fewer mistakes are made in stocking waters with different fishes. Even the same kind of fishes but from different waters kill each other out. California, native brook and German trout should never be planted out together. They will kill each other. After the eggs are hatched artificially the fry always separate in 2 bunches. The group of larger fishes are always found near where the water enters, the smaller ones near where the water leaves the trough. These 2 bunches should never be mixed and planted in the same water, except in a big lake and then far apart. As a rule the success of a preserve rests with the managing man.

C. Boudewijns, Hoboken, N. J.

SEEDLINGS.

The progress in establishing forestry as a profession in this country is exemplified in the rapid multiplication of forestry schools, and in the rapid growth of the existing ones. The 2 colleges at Cornell and Yale have together registered 110 students, over one-half being new accessions. These and the graduates from these and other forestry schools and other professional foresters in general in the country may now well number between 200 and 300, enough to warrant the publication of the first professional journal, the *Forestry Quarterly*, issued from the New York State College of Forestry, under a board of managers composed of students and a board of advisors composed of alumni and members of the faculty. It is to serve as "a means of communication among those who are building up the science and art of forestry in the United States." Although this journal is intended mainly to serve the technical needs of the profession, the subject is so

broad and interesting that many lay readers will find desirable instruction in its pages.

The subscription price is \$1, to be sent to the Business Editor *Forestry Quarterly*, Ithaca, N. Y.

It is not generally known, but there is apparently a distinction between the areas implied under the terms Adirondack Park and Adirondack Preserve. The Adirondack Park is the territory, both State and private, included by the heavy blue line which is marked on State maps. This includes 3,226,144 acres made up of 1,163,414 acres belonging to the State, 705,914 acres in private preserves and 1,356,816 acres belonging to individuals or companies.

The Adirondack Preserve is the State land inside and outside of the Adirondack Park. It contains in all 1,325,851 acres.

Among the new reservations which have been formed during the present year, of special interest are the Dismal River and Niobrara Forest Reserves in Nebraska. These consist of sand which is liable to be shifted by the wind in case the vegetative cover becomes too thin. They contain practically no trees, but are being planted by the Bureau of Forestry. It is remarkable that this sand is moist, and that when trees once get started in this region they grow with great rapidity.

Several changes have been made recently in the reservations around the Yellowstone park. The park is now bounded on the South by the large Teton Forest Reserve of 84,127,360 acres; on the East by the Yellowstone Forest Reserve, formerly the Yellowstone Park Timber Land Reserve, containing 1,834,240 acres; and near to the Northwest is the Madison Forest Reserve of 736,000, which was set aside August 16, 1902.

A recent magazine contains an interesting account of the life, duties and responsibilities of the forest ranger on the reservations of Southern California. The illustrations showing a mounted ranger in uniform, rangers dibbling in seed, cutting trails and gathering pine seed are tangible evidences that at last something is being done to repair the damage of years of neglect and abuse.

Baron Sonnino, a well known economist and leader of the Constitutional Opposition in the Italian Parliament, ascribes the sorrowful condition of the peasants of Southern Italy to "excessive deforestation, excessive taxation, usury and phylloxera."

PURE AND IMPURE FOODS.

"What a Man Eats He Is.

Edited by C. F. LANGWORTHY, PH.D.

Author of "On Citraconic, Itaconic and Mesaconic Acids," "Fish as Food," etc.

BOTTLED WATER.

The sale of simple, potable waters for table use has greatly increased during the past few years, and is now a considerable industry. This increasing use of special drinking waters is doubtless due to greater diffusion of knowledge of the danger of drinking sewage-contaminated water, but is also to be attributed to a growing demand for water with better physical characteristics than are found in the public supplies of many of our cities and villages.

According to H. E. Smith, of the Connecticut Agricultural Experiment Station, "the extensive use of special table waters in a community having a public water supply is, therefore, to be regarded as an expression of distrust in the public supply or, at least, dissatisfaction with it. The distrust may be well founded in a suspicion or belief that the water is sewage-contaminated, and, therefore, liable to produce serious diseases; or there may be dissatisfaction with the water because of its physical character, as its turbidity, high color, and objectionable taste or odor. Much more attention is paid to the character of our reservoirs and to the protection of the watersheds supplying them than formerly, especially in some of the larger cities; but there are still some supplies which are subject to dangerous contamination and there are inherent difficulties in protecting surface water supplies, especially in the case of small reservoirs, which are sure to result in at least occasional bad tastes and odors. Until public water supplies are practically safe and free from objectionable physical properties by some process of purification, as by filtration, it is reasonable to expect that there will be a demand for special table waters. These will be bought because they have desirable physical character. What waters are clear, odorless and of agreeable taste, it is easy for the buyer to ascertain, but he has in general no means of judging for himself whether a water either is or has been contaminated by sewage.

"Some waters found in the market are put out in a large way over considerable territory and after suitable precautions to ascertain the quality of the water and to maintain its purity during the process of preparation for market. Other waters are handled only in a small way by dealers who present no evidence that they have used suitable precautions to ascertain the pur-

ity of the water or that they possess the means of properly sterilizing the bottles or jugs in which the water is sold."

With the object of ascertaining the quality of the waters sold in Connecticut, a series of analyses of bottled waters was made by Professor Smith. Of the 25 samples examined, 11 were normal, and 14 showed signs of past contamination, although the majority had purified themselves until they were not at the time of examination regarded as harmful. Notwithstanding, there is no certainty that waters which had been contaminated might not become harmful under changing meteoric conditions, as for instance, more abundant rainfall, or a drought.

"No claim is made," he states, "that the spring waters examined and shown to be more or less contaminated are subject to specific infection, and are liable to cause typhoid fever, dysentery, or other specific disease; for the examinations which are made do not furnish sufficient data to justify an opinion as to the sources of the contamination. It is quite likely that many of the waters have been affected by drainage from distant houses, barnyards, or cultivated fields, where manure or some other form of fertilizer had been used."

In the opinion of Professor Smith, the exact nature of the contamination which is shown to exist in a spring water offered for sale is immaterial, for no water should be bought for table use if there is any suspicion of its impurity.

GRAVIES AND SAUCES.

Well made gravies and sauces are an agreeable addition to the diet and are economical since, usually, when they are freely used less butter is eaten. When, in making gravies or sauces, the flour is cooked in hot fat, the gravy is brought to a finish in less time than is possible if the flour is blended with cold water or stock and added to the bulk of the gravy, as then at least half an hour is required to cook the latter mixture so it will not taste raw and pasty. This is important for other reasons than flavor. In the raw state, the starch in the flour is not so easily digested as when it is cooked.

When the flour is cooked in hot water the temperature does not rise above the boiling point of water, 212 degrees, while when cooked in hot fat the temperature is much greater, reaching 400 degrees. In this hot fat, the starch is quickly cooked

5 minutes sufficing. Then, when the hot liquid used to thin the gravy, which may be either water, stock, or milk, is added, the particles of starch swell and break and after a few minutes' boiling, the sauce will be entirely free from any raw taste. In cooking for individual persons with delicate stomachs, it may be better to follow the rule of blending the flour with the cold liquid and then letting the sauce cook an hour or more, but in preparing ordinary meals, cooking the fat and flour together seems the more practical way. A poorly made gravy is unacceptable, but a well made gravy is a useful part of any dietary.

Every camp cook should know how to make gravies of different sorts, as they are welcome additions to the diet, while the materials required are few and such as are found in most camp outfits. Salt pork and bacon, staple dishes in most camps, are much improved when eaten with milk or cream gravy. Boiled fish needs drawn butter, and brown gravies are useful with all sorts of meat and game.

None of the dishes cooked years ago at a favorite camp on Lake Champlain is so distinctly remembered as a sauce made by one of the best of campers who is to-day a prominent figure in New York city politics. This sauce consisted of onions, fried a light brown with salt pork, tomatoes, red pepper, and chopped olives and was made after a recipe learned from some Spanish cook. The belief remains firm that it owed its excellence to something besides hunger, although that is undoubtedly the most important sauce of camp life.

TABLE RELICS.

From time to time articles of clothing and other personal relics of famous men have come into the market and are quickly bought by private collectors or by museums. Often a large price is paid for something of no value in itself; at other times the price seems small in comparison with the real value of the article sold. A writer in a current magazine discusses at length the auction sales of relics which have taken place in recent years. Especial interest attaches to the articles which famous men have used in their eating and drinking.

Not long ago a 2-handled silver cup, presented to Admiral Nelson by Lady Hamilton and inscribed "From Emma, July 2, 1798," sold for nearly \$600.

Mementoes of Oliver Cromwell are seldom offered for sale. Within a few months an old English "Beutel," resembling a military water bottle, mounted with 2 silver shields, having a medallion portrait of the Lord Protector and the royal arms engraved on it, and bearing the inscription,

"Oliver Cromwell, Lord Protector, 1653," sold for about \$420.

The Malacca cane and the cream-colored earthenware jug bequeathed by Shakespeare to his sister, Joan Hart, came into the market in 1900, realizing in the neighborhood of \$775. This proved to be one of the few lots of relics which did not show an enhanced value as judging by previous sales. Many years ago the jug sold for \$100 and the cane for \$25, but in 1893 the pair realized about \$810.

Relics of Napoleon are eagerly sought. At a comparatively recent sale a glass-tipped drinking goblet, or tumbler, used by Napoleon when traveling, was sold for \$75, about \$4 more than a small silver teapot, in an oak box, which was used by the Duke of Wellington during his campaign, and had a Dublin hallmark, and the date 1807.

These figures suggest that the state lumber rooms of the French government might be profitably searched, since at the last *battue*, at the one-time headquarter offices of the Paris garrison, in May, 1899, there were unearthed, in an old garret, all the pots, kettles, pans, and moulds, comprising the "*Batterie de cuisine*" of the officers of Napoleon's Imperial Guard. All the pieces were marked with the First Emperor crown, and the initials "G. I." and would probably command a considerable sum if offered for sale.

BAMBOO SEED.

Bamboos seldom blossom and bear fruit. In certain regions of India the flowering of the bamboo groves is almost historic, having occurred only at long intervals, perhaps once in 60 years. It is said that in 1812, at Orissa, a general flowering of the plant prevented a famine.

The culture of bamboo occupies 75,000 acres in India. During the recent famine in India, bamboos flowered abundantly in several regions, and afforded great relief to a large number of the starving population.

The bamboo seed most commonly eaten is the fruit of *Bambusa arundinacea*, and is called bamboo rice. It is about as large as an oat, cooks readily, and when boiled resembles rice in flavor. It contains some 12 per cent. protein, and 74 per cent. of starch. Judging by its composition, therefore, it must be considered a nutritious food. The seeds, when ripe, are beaten out of the bamboo heads, cleaned by sieving, and then ground to a sort of flour used for making a flat cake or bread called *chapatis*. The flour is sometimes mixed with rice, and poor people eat the seeds raw, but they are regarded as much more palatable if cooked. It is said that 2 women, in a day, can gather 8 pounds of bamboo seed, which will yield nearly 6

pounds of flour, or enough to make 30 cakes, 7 inches in diameter; a quantity sufficient to sustain a healthy man 6 days.

A more common bamboo food product is a vegetable which in taste and appearance suggests asparagus. This consists of the young bamboo shoots and is much prized in China, Japan and other regions of the Orient. Bamboo shoots are often preserved by pickling and are also canned. Many of the Chinese shops in the United States have canned bamboo shoots for sale.

It is not surprising that the bamboo should yield useful food products when we remember that it belongs to the great family of grasses which includes also such common food plants as wheat, corn, and other cereal grains. Perhaps the flowering of the bamboo is caused by drought, as dry weather frequently hurries the blooming of plants. In such cases it seems as if nature hurried the formation of seed so that unfavorable conditions might not hinder the continuation of any given form of plant life.

ACORNS AND THEIR USES.

The acorns from different species of oaks differ much in size, form, color and taste. In some the cup is deep and rough, in others smooth and shallow. While a few kinds of acorns are sweet and not unlike chestnuts in flavor, most are bitter and more or less astringent in taste, owing to the presence of quercin, or some similar bitter principle, and tannin. On an average fresh acorns have the following percentage composition: Water, 37.12; protein, 4.11; fat, 3.05; nitrogen free extract, 45.27; crude fiber, 8.95, and ash, 1.50. The shell makes up 14 per cent of the total fruit; the flesh, 85 per cent. They contain considerable nitrogen free extract, largely starch, and thus resemble chestnuts in composition more nearly than oily nuts like walnuts.

Acorns are a favorite food of wild hogs and have been used since earliest times as a feeding stuff for domestic animals, especially pigs. It is usually customary to let the pigs gather their own food. The agreeable flavor of the flesh, ham and bacon of the razorback hogs of the Southern United States is attributed in no small degree to the acorns eaten. It has been found that an excess of acorns produces soft, spongy flesh and oily lard. This may be obviated by feeding corn for 2 or 3 weeks before slaughtering, which is the usual custom.

In the United States acorns are not generally eaten by man. Under the name "bitotes" the fruit of *Quercus emoryii* is, however, eaten in the Southwest. Sweet acorns are eaten occasionally in other regions, usually by children. The Indians from the

Pacific coast region, from Northern California to Mexico, use many acorns. Dried and pounded, they are made into a sort of mush; also into a bread. Acorn meal is usually leached to free it from tannin and the bitter principle. Sometimes when used for bread a kind of clay is also mixed with it.

In Italy acorns made into a sort of bread, with the addition of 2-3 grain, are a common article of diet in several regions, notably Umbria, Tuscany, Emilia and Marchi. The bread is black and heavy and not thoroughly digested. Doubtless the only reason acorn bread is eaten is because the peasants are so poor that anything which will serve as food must be utilized.

Dried acorns are sometimes used as a coffee substitute.

RACCOON MEAT.

The wildest meat, in the opinion of a writer in one of the Southern papers, is that of the raccoon, which has a flavor about it not to be found in any other meat; an opinion based on many years spent in hunting in the wilder regions of this country, that afforded abundant opportunity to become familiar with the particular flavors of various kinds of game. Deer meat he considers almost tasteless, though it would hardly be fair to say it lacks a distinct flavor, for there is a suggestion of wildness about venison, if it is not too highly seasoned. Bear meat is just a trifle more gamy in flavor, but not wild enough to be offensive to the man whose taste is acquainted with more usual foods. 'Possum meat he regards as deceptive, for few persons can distinguish between well prepared and carefully cooked 'possum meat, particularly when it is eaten cold, and the meat of a young pig. Though fond of vegetable food, especially persimmons, the 'possum will feed on carrion also; hence it is the usual object of a 'possum hunt to secure the game alive and then feed the 'possum, carefully, long enough to free the flesh from any objectionable taste. Baked with sweet potatoes and served with the usual condiments, 'possum is regarded by many as appetizing, and not strong. Coon meat is different. There can be no mistake about the flesh of this animal. It is peculiarly strong and no amount of seasoning or flavoring will rob it of that taste of wildness which is peculiarly its own. It is not a bad taste, when one is used to it, provided the meat is properly prepared. Few persons know how to cook a coon, however; perhaps because the meat is rarely found in most sections. Some of the old time colored cooks were especially skillful in preparing coons and 'possums.

BOOK NOTICES.

ECONOMICS OF FORESTRY.

This is the title of a book written by Dr. B. E. Fernow, editor of the Forestry Department of RECREATION and director of the Cornell College of Forestry. It is a reference book for students of political economy and professional and lay students of forestry.

This work covers the subject of forestry from the standpoint and for the use of the student of political economy. It is not a mere popular discussion of the theme, but brings together with professional completeness and accuracy all that a student of economics needs to know, and should know, of this branch of soil-culture and of the significance of the forest resources in the household of the nation, with a view to formulating a forest policy for the State.

The forest and water supplies, declares President Roosevelt, are, perhaps, the most vital internal questions in the United States. It may readily be seen how the 2 go hand in hand. Stirred by the splendid results from scientific forestry, obtained in Germany and other countries, the Federal Government is, at last, fully awake to the situation. Already it has 40,000,000 acres of forest reservation; while the movement is spreading to private estates and preserves. What lends added prospect of forest salvation is the fact that owners of forest properties who hold them only for commercial profit are beginning to see that the forest is not a mine to be exhausted, but a wood farm to be sown as well as reaped.

The present volume contains an entirely new and thorough discussion of the whole history and practice of forestry. The author having been for 12 years in charge of the Federal Forestry Division in Washington during the period of its gradual development, which has made its present expansion into a Bureau possible, and as an active officer of the American Forestry Association during its entire existence, has had unusual opportunities to speak from personal observation and active participation in the development of these policies. He was a member of the Prussian Forest Department 8 years, so that his knowledge of the technical side of the subject and of the condition of European forestry comes, also from a wide personal experience.

The subject is discussed in 12 chapters, amplified by notes at the end of the volume. First comes an introductory chapter on "The Relation of the State to Natural Resources." The chapter on "The Forest as a Resource" is a summing up of the character of this national asset, "which is sec-

ond only to agriculture in its importance." Other suggestive titles are: "Methods of Forest Crop Production"; "Forest Economy"; "Forest Policies of Foreign Nations"; and "The Forestry Movement in the United States."

There is no other book in the English language which treats the subject in this comprehensive manner.

This book is of immediate importance not only to students of economics, but also to every thoughtful citizen in this country. The preservation of our national resources must go hand in hand with our prosperity and vigor as a nation. A wakeful intelligence, therefore, in public measures such as this is a prime necessity. The book is published by Crowell & Co., 426 West Broadway, New York, and sells at \$1.50.

Major E. S. Farrow, of the U. S. Army, who served many years in the Indian campaigns of the Northwest, and who for a time was detailed in command of Indian scouts in the Department of the Columbia, has written a book entitled "Camping on the Trail." He tells many of his interesting and thrilling experiences while serving on the frontier, and gives a great deal of valuable information as to how to outfit for such work, how to live in camp, and how to get the greatest possible comfort and enjoyment out of any hunting, mountain climbing or exploring trip. The book is published by the American Arms Co., of Philadelphia, and sells at \$1.50. Every man interested in hunting or mountain travel should have a copy of it.

Every man who likes a good horse, and that means nearly every sensible man, will be interested in a book just published by Little, Brown & Co., Boston, entitled First-Hand Bits of Stable Lore. The author, Mr. Francis M. Ware, is evidently a lover of horses and a good judge of horse quality. He is a fluent and pleasing writer and has put into this work a great deal of valuable teaching. The book is handsomely illustrated with photographs, and beautifully printed and bound.

"A Nature Wooing" is the name of a book written by W. S. Blatchley and published by the Nature Publishing Co., of Indianapolis. This book is a journal of a winter's experiences and observations in Florida, and deals largely with the animal life which Mr. Blatchley found and studied there. Any nature student will therefore find in this book a great deal of interesting information.

PUBLISHER'S NOTES.

WITH DOG AND GUN AT PINEHURST.

The latest enterprise of Leonard Tufts, owner of Pinehurst, the attractive North Carolina winter resort, is the establishment of a shooting preserve of 30,000 acres of the best quail lands in that State, for the exclusive benefit of the guests of the Pinehurst hotel and cottages. This magnificent tract, which comprises nearly 50 square miles, is adjacent to the village, and is easily reached by carriage. It is in this section of country that the annual Eastern Field Trials are held, a fact which sufficiently proves the abundance of birds. Quails, always plentiful here, are abundant this season. This is due to the enterprise of Mr. Tufts. During the past summer he caused about 100 large patches in various places throughout the shooting grounds to be planted with peas, in order to increase the food supply of the birds. The peas have been left out and the birds have thrived as never before. Apparently none have gone South because of scarcity of food, which has occasionally happened in former years.

The shooting privileges at Pinehurst are restricted to guests of the hotels, and sportsmen from the North will find here hunting facilities unequalled elsewhere in the South. Competent guides are always available, and a large kennel of well trained dogs is maintained for the use of visitors. Weekly trap shooting tournaments are held at Pinehurst, from February 1 till the end of the hunting season, thus enabling sportsmen to keep in good training for the field.

GOOD MUSIC IN CAMP.

The pleasure of camp life may be greatly enhanced by providing music for the long evenings and for rainy days. Many sportsmen have been carrying with them into the woods, or to their summer cottages, or on their yachts, gramophones or graphophones or phonographs, but these have all proven unsatisfactory, in one way or another, and most persons tire of them in a short time. A much better form of musical instrument is the old, standard Swiss music box, with metal cylinder. A high grade instrument of this class produces true musical tones and appeals to people of refined musical taste and education.

Mr. E. L. Cuendet, of 7 Barclay street, New York city, whose ad appears in this issue of RECREATION, handles a large line of these instruments, varying in size and in price from \$3.75 up to \$140. Any of the larger sizes can be conveniently carried on

a train or placed in a trunk and shipped as baggage, and any camping party supplied with one of these can always have high class music whenever wanted. Mr. Cuendet publishes a complete catalogue of musical instruments of various kinds, and every reader of RECREATION who is fond of music should have a copy of it.

OUR ROADS ASTONISH FOREIGNERS.

The development of passenger transportation in the United States astonishes all foreigners. Edwin A. Pratt, a representative of the London Times, was making some investigations recently at the Grand Central Station with a view to writing a comprehensive article on American railroads. His inquiries developed the fact that the New York Central has 8 passenger trains a day between New York and Chicago, and when he learned that the distance was 980 miles he remarked that it is a marvelous thing. He was still further astonished to find that 4 of the 8 trains make the 980 miles in 24 hours, and that one, the Twentieth Century Limited, goes the distance every day, in either direction, in 20 hours. His amazement grew when he was informed that the West bound Twentieth Century Limited carries only Chicago passengers, and will not take a passenger for any other point. He remarked that his people would be equally astonished on learning these facts.—New York Press.

HAVE MOVED CAMP.

Abercrombie & Fitch have moved to 314 Broadway, where they have taken much larger quarters than they had before, and they are now in the center of the sporting goods district, being next door to the Winchester Repeating Arms Co., Schoverling, Daly & Gales, the U. M. C. Co., the Remington Arms Co., and Hartley & Graham. As I have said before, Abercrombie & Fitch are both practical sportsmen and campers, and if anybody on earth knows how to outfit a man for a hunting or fishing trip, these men do. They have added to their stock complete lines of guns, ammunition, fishing tackle, hunting boots and shoes, pack saddles, aparejos, and so forth. Their silk and waterproof tents and sleeping bags are becoming more and more famous all the time. If you have not one of their catalogues, it is high time you should get one. In writing for it, do not forget to mention RECREATION, for thereby you make another mark to the credit of this magazine.

A 50-FOOT CALENDAR

N. W. Ayer & Son, the Philadelphia advertising agents, who have a national reputation for "keeping everlastingly at it," believe in sticking to a good thing when they have one. For instance, their calendar for 1903 follows the design used for several years past, but with new coloring. And in truth it would be hard to improve on their design; the dates are plainly readable at 50 feet, yet the calendar is not unpleasantly conspicuous; it is artistic, simple and useful and it is not surprising that it has become so popular an adjunct to business offices that the supply never equals the demand.

While they last, one will be mailed to any address for 25 cents, which barely covers cost and postage.

Readers of RECREATION who are fond of pure maple sugar and syrup should read the ad of V.I. Spear, which will be found on page xxxvii of this issue of RECREATION. He is at the head of the Vermont Maple Sugar Makers' Market, an association of farmers who make the real thing from the maple tree. Mr. Spear has given me the names of a number of people to whom he and his associates have been selling sugar and syrup a number of years. I have written these people, and they all pronounce his goods the best that can be made; so you may safely buy of him and feel that you are getting what you pay for.

The Marble Safety Axe Company, Gladstone, Mich., has made some important changes in the patterns of its famous pocket axes. A new circular has been issued showing cuts of these axes and of the knives, compasses and other sportsmen's implements made by this company. A copy of this circular would prove interesting to any and every sportsman. When you write for it do not forget to mention RECREATION.

Many celebrated plays are scheduled for revival by the Proctor Stock Co. during the early part of the new year. Among the number may be mentioned "Fedora," "Cleopatra," "La Tosca," "Under Two Flags," "Hearts Are Trumps," "Around the World in Eighty Days," "The Cherry Pickers," "Blue Jeans," "The Still Alarm" and several of the most successful comedies in the repertoire of the late Roland Reed.

Spratt's Patent, Newark, N. J., has issued its calendar for 1903, and any person desiring a copy can get it by sending a postal card mentioning RECREATION. As usual, the

pictorial portion of this calendar deals with dogs, cats, poultry, pigeons, hunting scenes, barnyard scenes, kennel scenes, etc. The drawings are spirited and humorous, and the calendar is well worth having.

New York.

Messrs. Wing & Son:

Having had occasion to examine and listen to your beautiful pianos, it is a pleasure to me to cheerfully recommend them to every one desiring a good piano.

Sincerely yours,

Gustav d'Agneau,
Musical Director Imperial Hotel.

Tacoma, Wash.

Century Camera Co.:

We compliment you on your line of cameras. This is the first season we have sold Century cameras, but we have disposed of a number and have yet to receive the first complaint. Next year we will sell more of them.

Washington Dental & Photo Supply Co.

Hotel Vendome, New York.

Messrs. Wing & Son:

The Wing piano has always given me entire satisfaction. Its action is perfect and it stands more hard usage than many other makes that I have used in my orchestral work. I find nothing but praise for your instrument.

Enos Johnson,
Musical Director.

The Ideal Manufacturing Company, New Haven, Conn., has designed and made up special bullets and reloading tools for the new 33 and 35 caliber Winchester rifles. Anyone interested can get an illustrated circular, by writing to the company, which gives full information regarding these new goods.

Allegheny, Pa.

West End Furniture Co.,

Dear Sirs:—The gun cabinet arrived today. Am well pleased with it, as it is the finest and best arranged article for the purpose that I have ever seen.

Respectfully yours,

L. P. Ittel.

Drs. H. R. Phillips and Wrean,

The trio of hares arrived yesterday in fine condition. I am thoroughly pleased with them and with the treatment I have received at your hands.

Robt. S. Lemmow, Englewood, N. J.

EDITOR'S CORNER.

MORE WORK FOR SPORTSMEN.

Here are copies of 2 very important bills now pending in Congress, in the interest of game protection:

s. 6689.

In the Senate, December 20, 1902, Mr. Perkins, of California, introduced the following bill, which was read twice and referred to the Committee of Forest Reservations and the Protection of Game:

Be it enacted by the Senate and House of Representatives of the United States of America in Congress assembled, That the President of the United States is hereby authorized to designate such areas in the public forest reserves as should, in his opinion, be set aside for the protection of wild animals, birds and fish, and be recognized as a breeding place therefor.

Sec. 2.—That when such areas have been designated as provided for in section one of this act, hunting, trapping, killing or capture of wild animals, birds and fish upon the lands and within the waters of the United States within the limits of said areas shall be unlawful, except under such regulations as may be subscribed, from time to time, by the Secretary of the Interior; and any person violating such regulations shall be deemed guilty of a misdemeanor, and shall, upon conviction in any United States court of competent jurisdiction, be fined in a sum not exceeding one thousand dollars, or be imprisoned for a period not exceeding one year, or shall suffer both fine and imprisonment in the discretion of the court.

Sec. 3.—That it is the purpose of this act to protect from trespass the public lands of the United States and the wild animals, birds and fish which may be thereon, and not to interfere with the operation of the local game laws as affecting private, State, or Territorial lands.

H. R. 16,060.

In the House of Representatives, December 15, 1902, Mr. McRae introduced the following bill, which was referred to the Committee on Public Lands and ordered printed:

A Bill for the protection of the public forest reserves and national parks of the United States.

Be it enacted by the Senate and House of Representatives of the United States of America in Congress assembled. That all persons employed in the forest reserve and national park service of the United States shall have authority to make arrests for the violation of the laws and regulations re-

lating to the forest reserves and national parks, and any person so arrested shall be taken before the nearest United States commissioner within whose jurisdiction the reservation or national park is located for trial; and upon sworn information by any competent person any United States commissioner in the proper jurisdiction shall issue process for the arrest of any person charged with the violation of said laws and regulations; but nothing herein contained shall be construed as preventing the arrest by any officer of the United States without process of any person taken in the act of violating said laws and regulations.

It now becomes necessary for every sportsman in the United States to write his Senator and Representative in Congress, urging favorable action on these bills. Every thoughtful and observing man knows that unless a number of national game preserves are established in the near future, the big game of this country will soon be extinct. Senator Perkins's bill provides for such game preserves in any of the forest reserves in the West.

Mr. McRae's bill proposes an important addition to the effectiveness of the force of forest rangers already employed to look after these reserves. At present these men have no authority to arrest a man accused of hunting without a license, of killing game out of season, of starting a forest fire, or of committing any other crime, without first obtaining a warrant. In many cases this means a ride of 50 to 200 miles, and the accused meantime has every opportunity to escape. The forest rangers should be authorized to arrest law breakers whenever and wherever found, without a warrant.

In writing your Congressmen and Senators, please refer to these bills by number, as given above. You should attend to this at once. There is no time to lose.

DON'T KILL THE SQUIRRELS.

I agree with you on game questions except that of killing squirrels. There I fail to note the difference.

J. E. Jones, Atoka, I. T.

ANSWER.

If you could take a walk with me in Central park and watch the gray squirrels there for an hour, I think you would readily see the difference between killing these animals and such others as deer, bears, lynxes, rabbits, and such birds as quails, prairie chickens, ruffed grouse, wild turkeys, etc. Of course, almost any wild ani-

mal or bird may be domesticated if taken when young and confined to a small space; but it is different with the gray squirrel. You may turn out one or 10 or 100 of these in a grove about your house, and if you will not allow them to be shot at or otherwise disturbed by men or dogs for 6 months, they will become almost as tame as your domestic animals and fowls. If you cultivate their acquaintance, walk among them, talk to them, and feed them every day, you will have them climbing over you, eating from your hand, and even searching your pockets for food, just as the squirrels do in Central park.

If you could come into my office and see Inkie climbing over the desks and over the people employed in the office; note how fond he is of them and how fond they are of him, you would see the difference between the killing of squirrels and other animals or birds. Hundreds of sportsmen who have seen this little creature, and who have made his acquaintance in my office, have said they would never kill another squirrel.

There are many towns and cities in the country whose inhabitants now systematically propagate squirrels in their parks, and they are proving the most important object lesson in nature study that has ever been placed before these people. You may turn a bunch of squirrels into any public park in any town, and at first sight the average town boy will go for them with a club or a rock; but let this boy be restrained and cautioned and reasoned with, and in a short time he will begin to admire the pleasant manners, the graceful movements, the beautiful eyes, and the waving plume of his new neighbor. The next day, or the next week, he will be ready to take a club or a stone to any dog or cat, or even any man or boy, who attempts to molest one of these squirrels. The next day, or the next week, you will find this same street gamin carrying peanuts, or corn, or other food, to the park, to feed the squirrels. In many of the towns or cities where squirrels were put a year ago, or a few years ago, you could scarcely hire a boy to kill one. All of the boys, whose natural instincts prompt them to kill every living thing they find in the woods, have learned that the gray squirrel is too beautiful, too interesting, too familiar, and too lovable, when once thoroughly known, to be considered an object of game.

Try it, brother Jones. Put out a few squirrels in the trees about your house. Put up some boxes for them. Cut a hole in the bottom of each box large enough for the squirrel to go in and out. If you cut the hole in the side of the box, the birds will appropriate it. If you cut it in the bot-

tom, they will not. Then the squirrels will not be disturbed in the occupancy of their houses. Put food under the trees every night, and let the squirrels find it there every morning when they come down. Protect your little neighbors rigidly from annoyance or disturbance of any kind, and in a few months you will be as radically opposed to the killing of squirrels as I am.—
EDITOR.

LOOK OUT FOR ENGEL.

Readers of RECREATION, and especially dealers in sporting goods, are cautioned against extending credit to Dr. C. Engel, Crescent, Ia. He has been buying goods on credit from various people, and using my name as reference, without my permission. He bought a pair of snow-shoes from A. N. Dunham, Norway, Me., and promised to remit as soon as the goods were received. He failed to keep this promise, and after having had the snow-shoes in his possession several months and on being urged to pay for them, he asked permission to return them. This was in November last. Mr. Dunham wrote Engel, accepting his proposition, but the shoes have not been returned.

Engel bought about \$12 worth of goods from Schoverling, Daly & Gales nearly 2 years ago, and has not paid a dollar on the account. When they write him, urging remittances, he ignores their letters. He ordered a \$200 gun from a German gun-maker, representing himself as one of the leading American sportsmen, and promising to pay for the gun promptly if it pleased him. The gun was shipped to Engel by express, and the maker has never heard from him since.

Engel is an unmitigated fraud, and should be locked up.

MORE CLERGYMEN IN TROUBLE.

Game Warden M. F. Hardesty, of Astoria, Oregon, recently made a remarkable haul while looking for law breakers. He found 4 Episcopalian clergymen and another man fishing for trout in the Necanicum river at night. An Oregon statute makes it a misdemeanor to even fish for trout between one hour after sunset and one hour before sunrise. These 4 reverend fish pirates were taken to court, but as it appeared that the Rev. J. E. Simpson, pastor of St. Mark's Episcopal Church, Portland, was the only man in the party who had caught any fish, he was fined \$20 and costs. The others were discharged. Mr. Simpson's accomplices in this law breaking were Rev. E. T. Simpson, pastor of All Saints' Church, Portland, a brother of the man who was fined; Rev. P. K. Hammond,

pastor of the Oregon City Episcopal Church; Rev. C. H. Lake, pastor of St. Paul's Episcopal Church, The Dalles; and a layman, named L. R. Kollock. It looks as if Mr. Hardesty had been unduly lenient in allowing the other 4 men to go free. It was not their fault that they had not caught any fish. They would doubtless have taken 100 pounds each if they could have got them, and they should have been punished for their effort at wrong doing.

FISH PIRATES RUN IN.

A State game and fish protector recently arrested 5 Hungarians for seining in the Mohawk river near Rotterdam Junction, N. Y. The men were caught in the act of hauling the seine, and were seen to dump a large number of black bass and other game fishes into the basket. Game Protector Jackson took the men into court, where they pleaded guilty and were fined \$10 each.

Special Protector J. W. Furnside, of Schenectady, who is also a member of the League, recently arrested 2 men for violating the fish laws and heavy fines were assessed against them.

A great many men who violate game and fish laws do not read newspapers or sportsmen's journals, but when one of these lawless characters is introduced to a justice of the peace and required to pay out money to the State, the news travels among his kind as rapidly as if it were printed in a yellow journal with scareheads 6 inches high. You rarely hear of a second prosecution of a game or fish law violator in any given locality within a year.

NOTES.

Another slaughtering match, otherwise known as a side hunt, was conducted in October last by the employes of a wagon factory at Canastota, N. Y. The butchers were divided into 2 gangs led respectively, or I should say disgracefully, by Edwin E. Jones and E. A. Worden. These contemptible wretches managed to pile up a total score of 16,880, from which it may be inferred that a large number of birds and animals were sacrificed. The game was fed to the swine who killed it in a local hall with musical accompaniment. I am sorry I cannot give the names of the other brutes who participated in this affair, but, of course, their neighbors know them and I trust my subscribers in Canastota will see that each gets a copy of this issue.

A subscriber in Whatcom, Wash., sent me a clipping from a local newspaper some months ago, stating that one J. Y. Johnson,

of Fairhaven, that State, broke all previous records of trout fishing in Silver lake "yesterday." The reporter says Johnson caught 371 trout, all over the average length of 10 inches; that he used worms for bait, and that he had to hire an express wagon to carry the trout home, and that he sold the catch for \$11.

I wrote Johnson, asking whether the report were true, and have had no reply. Therefore I deem it is. And therefore Johnson goes on record as a fish hog with bristles at least a foot long.

Some time ago a friend in Seattle sent me a clipping from the Times, of that city, stating that S. J. Williams, of Renton, Washington, had taken 253 trout in one day. I asked Williams if the report was true, but have not heard from him. As the letter has not been returned, I take it for granted it reached him all right and must therefore consider his silence as a confession of guilt. Thus I am under the necessity of adding one more occupant to the already overcrowded corral in which Washington fish hogs are confined.

John Barnes, Bennett Siding, Wis., was fined \$240 by Judge Haily for killing 3 deer out of season. The judge valued one deer at \$25 and the other 2 at \$100 each. When Barnes was eating these 2 deer he must have felt just as if he were eating money. Haily is a bully judge and I wish all the others in the country were like him.

WANTED.—To know the present whereabouts of H. H. Reitzenstein. This man took a number of subscriptions for RECREATION in Toledo, Ohio, Grand Junction, Mich., and other cities in that State, in December last, and has failed to send them to this office.

"Do you think, professor," inquired the musically ambitious youth, "that I can ever do anything with my voice?"

"Well, if you were a farmer it would come handy to drive cows with."—Exchange.

RECREATION outsells all other sportsmen's periodicals here.

A. B. Holbrook, Nashua, N. H.

RECREATION is the best sportsmen's journal out.

E. L. Marsh, Fort Dodge, Iowa.

A HUNT IN HUNTINGDON.

H. L. DEWITT.

I have hunted deer more or less the last 15 years. Previous to 1899 I used a shot gun loaded with a handful of black powder, buckshot and scrap iron. When she went off something got hurt, if it was only me. At rare intervals I would succeed in killing a deer. As a rule, however, I would only burn the hair off one side of my game. That fact coming to the notice of the S. P. C. A. I was threatened with arrest; the Society claiming that deer thus deprived of their winter coats were likely to perish of pneumonia. Therefore, I sold my old pelt dresser and bought a .30-30 rifle.

November 1st M. F. Gulick and I left here for the mountains of Huntingdon county, Pa., arriving at camp the same evening. We found another party on the ground, with which we joined forces. The next morning we were up by daylight and ready for the fray.

I was stationed on a small flat commanding the side of a ridge on which the drivers were advancing. Presently I saw a deer coming straight at me at top speed. Instantly realizing that with a rifle I could not mow a 10-foot swath at 30 yards. I steadied myself, brought the gun to my shoulder, and watched through the peep sight for further developments. My suspense was short. Into an open space, 40 yards away, bounded the deer, still heading toward me. I was seized with a desire to run, but it was too late; so, to do or be done, I let go my first .30-30 soft point at large game.

The effect of the shot on the deer was marvelous. He did not turn a flipflap and fall all in a heap, as I have seen others do. He was simply paralyzed in his tracks, his front knees knocked together and he fell on his side, with neck extended at full length. Before I reached him, however, my beautiful, 3-pronged, 160 pound chunk of venison began to kick violently. I fired a

second shot, which took effect in his neck and finished him.

My last shot was entirely unnecessary, as subsequent examination revealed. The first ball entered the neck about 4 inches from the shoulder, struck the neck bone, ranged backward through liver and intestines, and was found embedded in the backbone, back of kidneys. My second shot struck near the first, passed through neck bone and out the other side. At point of entering the holes were as large as those made by a .44 caliber. The hole at exit of second shot was an inch in diameter. These balls had flat ends and the one found in the backbone had mushroomed half its length.

This glorious success in my first experience with the .30 made me careless. A few days later I had a beautiful shot at a large doe standing in the open only 100 yards away. At the crack of the rifle she fell toward me, but immediately regained her feet and escaped without giving me a chance for a second shot. On the little ridge where she had stood I found blood and hair. I trailed the deer by blood for half a mile down the ravine, where she had entered a thicket of buck laurel and windfalls. The next morning I took up the trail again but was unable to follow it.

The blood on the leaves was frothy, suggestive of the deer having been shot through the lungs. Through over confidence in the .30-30 I failed to hold on the shoulder as I should have done.

Deer are becoming more plentiful here. Our new game law, now about 2 years old, explains this. The fines for violation are heavy; and half going to the informer, makes of each square hunter a game warden.

My friend, Gulick, was compelled to return home without getting a shot. He explained this by saying he did not want Shields to rip him up the back for being a game hog, such as I was.

HAVE YOU A FRIEND
ANYWHERE IN THE WOODS,
IN THE MOUNTAINS
OR ON THE FARM,
WHO LONGS FOR SOMETHING TO READ
IN THE LONG WINTER EVENINGS, OR IN
THE LONG SUMMER DAYS?
SEND HIM RECREATION.
IT WILL PLEASE HIM A WHOLE YEAR
AND HE WILL RISE UP AND CALL YOU
BLESSED.
AND IT ONLY COSTS YOU \$1.

What PURITY Means



Purity requires pure water.

We get it from six wells, driven down to rock. No purer water flows anywhere in the world.

Purity necessitates pure air.

All the air that touches Schlitz Beer, after the boiling process, passes first through an air filter.

Pure beer must be filtered.

Every drop of Schlitz Beer is filtered by machinery through masses of white wood pulp.

Pure beer contains no germs.

Schlitz Beer is sterilized after it is bottled and sealed, by a process invented by M. Pasteur, of France. It requires one and one-half hours.

That's how we double the necessary cost of our brewing. We do it to make purity certain—to make Schlitz Beer healthful.

Will you drink common beer, and pay just as much for it, when Schlitz Beer can be had for the asking.

Ask for the Brewery bottling.

A GREAT LOSS TO SCIENCE. • •

C. T. BORDWELL.

In the fall of 1901 M. W. Scofield, of Mayville, N. Y., L. D. Farman, of Jamestown, R. Hews, W. J., William and H. Cornell, of Chautauqua, and I went to Greenville, Me., where we secured Jim Gray as a guide. We went up Moosehead lake and across the Northeast carry, then by canoe and team 14 miles to where we pitched our tent for a few days' hunting. W. J. Cornell, Schofield and Farman getting their fill first, left us and went home. A few days later the others of the party broke camp. Hews and H. Cornell had left camp and were to meet us again at the river or the carry. Jim then told Will and me of a large moose that had been seen many times and by many people, and had always been reported as the king of its kind. It always managed to get away from its pursuers, and therefore the largest pair of moose horns known were still on a live moose.

As our party were short on horns, we concluded to visit the *rendezvous* of the moose, so on leaving the canoe we started through a thick, tangled growth of fir and cedar. For some time we saw no trace of game, except a few deer tracks. Our march was beginning to be tiresome when we finally came to an opening where at some former time timber had been cut and a camp had been made. The opening had partially grown up with small timber and brush. Across this open space, to the left, and on somewhat higher ground, I discovered what at first sight might have been taken for a mule, with its head under, or eating out of, a cart box, the kind with flaring top and sides, with many stakes on each side, still higher than the box proper. The animal and the box were end toward us. On seeing it I stopped short, which attracted the attention of Jim, who was next behind me. He looked in the direction and remarked, "It's a moose." I brought my gun up and fired, and before Will could fire it seemed as if I had fired into a mine, causing it to explode. The moose and all in its immediate vicinity seemed to be raised in the air, with sticks, stones and all the accompaniments of an underground explosion. This had settled down long before our consternation at the scene had ceased. When we had sufficiently recovered to make a forward move, we discovered that I had shot well under the moose. The ball had raked its belly nearly the entire length, then passed in and through the heart. The moose had his head lying on a stump, about 2 feet 10 inches in diameter, from which extended splits, or slivers, caused by the tree breaking over before the choppers had cut it entirely off. The moose, in springing backward, caught his head between those splits; and with such strength and weight did he

spring, that it caused the stump to be uprooted and all fell in a heap.

We estimated the weight of the trunk, with stones and roots attached to it, at 13¼ tons, broken and pulled out from the earth, not taking into consideration the pulling strength of the root, torn from between rocks.

Then the question arose, what would we do with the moose, or even its head, which we were desirous of preserving, as we felt confident there were no more like it. We were 17 or 18 rods from the Penobscot river, but Jim said even if the head was at the river the canoe would not carry it. We held a council. Jim went a few miles away and got a *bateau*, which was used as a ferry, and which he said would easily carry 1½ tons. Will always carried his hatchet, so we cut a road through to the river. Then, with Will's hunting knife, we took off the cape of the moose up to the head and there severed the head from the neck, leaving the head and cape attached. We then cut poles 5 or 6 inches in diameter, peeled them and placed them side by side in pairs, about 28 inches apart, making a slide such as timbermen use to slide logs on. It was down hill to the river, so we tried to start the head, but as we could not, we cut hand spikes and waited for Jim. After working hard we finally got the head at the end of the skids down to the river bank. Then we gathered up some of the slide poles and extended them over the *bateau*. With pulling, pushing and the use of hand spikes we got the head over the side of the *bateau*, when the timber broke, letting the head sink into the gunwale. That caused the *bateau* to careen just enough to ship a little water, when the head gently rolled outside and sank in 20 to 30 feet of swiftly running water. We did not get the measure of the horns, as the only measure we had with us was a foot rule.

Will and I were both with Van Dyke, of Red Lodge, in the fall of 1900, know him well and believe all he says in reference to the elk that broke the tree in its flight. Is not the turning over of the stump truly remarkable?

Decatur, Ill.

I take pleasure in acknowledging the receipt of cartridge belt and ampliscopes. Both are choice premiums and it is a mystery to all how you can offer such valuable prizes.

W. E. Marsh, Sinaluta, Assa.

I received the cartridge belt. It is perfectly satisfactory and better than I expected. I have had premiums from other magazines and they were not worth house room.

Harry Smith, Goshen, N. Y.

THE EQUITABLE

HENRY B. HYDE.
FOUNDER



J. W. ALEXANDER
PRESIDENT

J. H. HYDE
VICE PRESIDENT.

AN INCOME WITHOUT CAPITAL

can be created by means of the New
Continuous Instalment Endowment Bond of the
Equitable.

If you die, it will provide a permanent income
for your beneficiary just when he, or she, may need it.

If you live, it will provide an income for your-
self just when you may need it.

The income commences at once, if you die.
It will commence in twenty years, if you live
and will be paid as long as either you or the
beneficiary live.

It will be paid for twenty years in any event.

Send coupon below for particulars.

Vacancies in every State for men of character and energy to act as representatives. Apply to Gage E. Tarbell, 2d Vice-Pres.

THE EQUITABLE LIFE ASSURANCE SOCIETY OF THE UNITED STATES

120 Broadway, New York.

Dept. No. 16.

I would like to receive information regarding a Continuous Instalment Endowment Bond, issued
to a person aged.....years.

Name.....

Address.....

AMATEUR PHOTOGRAPHY

"For sport the lens is better than the gun."

I wish to make this department of the utmost use to amateurs. I shall, therefore, be glad to answer any questions and to print any items sent me by practical amateurs relating to their experience in photography.

UNDER EXPOSED PORTRAITS.

The commonest defect in amateur portrait work is under exposure, emphasized as it often is by over development. It is by no means unknown even in professional work, and there is no branch of photography in which it is more detrimental. Hard, chalky faces, and other results which the photographer who knows his business would desire to suppress, are emphasized. Exaggerated freckles and wrinkles and often deep, bronzed shadows, absolutely without detail, are its most evident manifestations. In the train of these come increased work and often impossible demands from the retoucher; and following from the hardness of the negatives are double tones in the prints, giving blue, washed-out high lights and red shadows.

A strong effect of lighting, sometimes known as a Rembrandt effect, is thought to be obtained by deficient lighting rather than by ample illumination suitably distributed. However powerful the result is to be, however much it is desired to suppress scattered high lights and to concentrate the brightest tones in one spot, this should be done as far as possible by adding light where it is wanted rather than by cutting it down. Whatever the result aimed at it should be obtained with the greatest quantity of light that will give it, that the exposure on the sitter may be at once full and short. Whether the effect desired be the softest which will give a satisfactory print, or the strongest that the printing paper will render, the negative should be a fully exposed one, and the result should be obtained by distribution of the light, not by its diminution.

One of the causes of under exposure in the case of many portraits is the use of a room or studio in which the glass is not so clean as it can be made. It is surprising how rapidly glass will become dirty, especially in large towns; but the extent to which dirty glass prolongs the exposure over the time which suffices when the glass is at its cleanest is even more surprising. A quantity of dirt will necessitate doubling the exposure, as an experiment will soon show. The moral of this is to see that this increase is never required.

The nature of subjects in many cases is such that a short and yet full exposure is difficult. Under such circumstances everything that can help to increase the light should be used. Dark woodwork about the

studio should be avoided; it absorbs light that might be usefully employed in making negatives. If at any time for any temporary purpose the light woodwork is a hindrance, it can be screened off. The paint should not merely be light to the eye, but light to the dry plate also. No trace of a red or yellow tinge should be used in it. Green is as bad or worse. Blue, slate, grey or white should be used as far as possible.

Amateurs should use the fastest plates they can for portrait work, not only because the makeshift studios within which they are most likely to work are never so well lighted as a professional's studio should be, but because amateurs probably will not have so fast a lens as a portrait lens. For work in ordinary rooms orthochromatic plates will almost always give better exposed results than ordinary plates of the same general rapidity.—Photography.

SEVERAL ANSWERS.

I notice that J. E. Bates, Spokane, Washington, writes he had trouble with Cyko paper blistering. I have had similar experience and have found that the trouble is in the hypo. If Mr. Bates will mix his hypo according to the following formula he will have no trouble:

Hypo, powdered.....	13	ounces
Water	64	ounces
Add the following solution:		
Water	5	ounces
Sodium sulphite, powdered....	¼	ounce
Acetic acid, No. 8.....	3	ounces
Alum, powdered.....	½	ounce

I should think that if Mr. Bates held his printing frame close enough to the light to blister the emulsion, the paper would be overprinted in the time it would take to get the glass warm enough to produce a blister. I have tried the same package of Cyko with plain hypo and with this other hypo. It would blister every time in plain hypo but never in the other. This hypo is equally good for plates and Velox or Solio paper and will always remain clear.

If A. M. P., Clifton, N. J., will get a 4x5 plate camera, either Premo, Poco, Korona or Century it would be as good as he would probably ever need. I have a friend who has a Century, 4x5, Model 12, and it is the best camera I ever saw. I have another friend who is trying to get one through RECREATION. He took 12 subscriptions in 3 days. A. M. P. might do the same and be money in.

I should like to know if any of RECREATION's readers have tried Argo paper made at Argo Park, Rochester, N. Y. It is fully as good as either Velox or Cyko and is cheaper. Their Metalotype is fine for

water scenes. I like it much; also Tolidol as a developer. I know of 10 photographers who are using Tolidol and they all praise it highly. I have used pyro, metol and hydro, but like Tolidol far better than any of them. Besides it does not stain.

Steven Mars, Taunton, Mass.

SNAP SHOTS.

Photographic impressions on ivory, suitable as prints for miniature paintings, can be made by applying the following solution with a brush.

Silver nitrate.....3 grammes
Nitrate uranium.....30 grammes
Alcohol.....100 cubic centimeters
Distilled water.....10 cubic centimeters

Dry the ivory plate in the dark, and expose in daylight under a negative in a printing frame. After the print is sufficiently strong fix in the following:

Water.....100 cubic centimeters
Nitric acid.....5 cubic centimeters

After which, wash in several changes of pure water, then dry. It is necessary, of course, that the ivory be thoroughly clean, as the slightest fatty or moist spots will give spotted pictures. A good method for cleaning the surface is to scrub it with a common scrubbing brush, using a solution of unslacked lime, after which thoroughly wash and dry.

I take great interest in your photo department. I have had troubles with my negatives. After they are fixed there are numerous opaque black spots on the film. I sent a negative to Seeds Dry Plate Company and they said the cause of this was that somebody had hit my water pipes and knocked off particles of iron. I have no water pipes and I use rain water. Seed should guess again. Do you think the water is the cause or have you had anything of this kind happen?

O. Denny, Martinsburg, Ind.

ANSWER.

It is not unusual to find the little black specks referred to. I have often had them when using plates and films near the sea, and leaving them some time before development. They may be deposits of iron from pipes, etc., or metallic silver. If the plates are fresh and are developed reasonably soon after exposure you should have no spots. If the spots continue under these conditions the fault must be with your chemicals or methods of development.—EDITOR.

Percarbonate of potash is given by several authorities as a most excellent elimi-

nator of hypo; but is both scarce and costly. It is quoted at \$4.50 a pound wholesale. Black silicate paint is excellent for blocking out and adheres to glass beautifully. Have used it to label bottles, blacken the inside of a cracker tin, blacken some bright brass, make a pocket slate; and have 3/4 of the can left.

When talking with a friend the other day about the addition of hypo to water having a cooling effect; we wondered how much it cooled it and made the test. We had ordinary tap water at about 74 degrees Fahr. To this we added enough hypo to make a saturated solution and then dropped in the thermometer again. Result, about 60 degrees Fahr. No wonder films sometimes blister when transferred from developer to cold hypo. Let the hypo stand some time before using and it will get to normal temperature.—Photo-American.

I would say to G. W. Damon that I do all my printing on Cyko and with a kerosene lamp. I use glossy and carbon Cyko and find them excellent, the glossy giving fine contrast. I use an ordinary sized lamp and place the printing frames around it; allowing 1/4 to 1 1/2 minutes according to density of negative. I should advise everybody to leave Dekko alone. It turns brown around the edges after being mounted less than a year, and development can not be forced, as it turns pink. I should like to hear from other readers of RECREATION who use 2 1/2 x 4 1/4 Kodaks if they have any trouble with Eastman film in that size. I have the past year had spots on all Eastman films of that size and none on other films and plates developed in the same developer at the same time. I have shown these spotted negatives to several experts and all say "defective manufacture."

Phokos, Guelph, Ont.

Most of our readers may know that there is such a thing as telephotography, and they may be aware of the fact that by simply attaching what seems to be another lens to the camera, the photographer is enabled to bring distant objects within range of the glass. Just as we can see through the telescope distant objects brought apparently within our reach, so the camera, with this additional lens, can see and reproduce objects that were hardly visible to the unaided sight. However, the general public evidently knows nothing of this new method of making pictures. An amusing incident, showing the dangers of telescopic photography, came under our notice last week. A picnic party on the Blue mountains, out for a day's pleasure, after a time missed 2 of their number, who had wandered 'a wee' on their own account. The photographer of the party, thinking he saw the lovers comfortably seated on a jutting rock, at some distance, adjusted his telephoto lens, focused the wanderers, and secured a telltale picture, which would at any time prove a most damaging line of evidence in a subsequent breach of promise case. Picnic parties should beware of telephoto lenses.—Australian Photographic Review.

Will you inform me through RECREATION where I can get a developing paper called albumen?

D. A. Vaught, Washington, Pa.

ANSWER.

Albumen paper is in a class by itself. None of the papers advertised come under this head. Albumen was the sensitized paper commonly used by professional photographers before the advent of gelatine and collodion emulsion papers. Albumen paper was in many cases entirely prepared by the professional photographer. Anthony & Company for a while had sensitized albumen paper on the market, but the demand for it was so limited, they discontinued it. They still carry regular albumen paper unsensitized.—EDITOR.

Last June I was talking with a man about taking photographs, and he said it was not hard to learn. I knew nothing whatever about photography, but I bought a camera and tried my luck at the business. I have had good success. I have exposed about 10 dozen plates and have lost only about a dozen. I have secured some excellent views and some photographs that are hard to beat with the experience I have had. I do my own developing, printing, toning and mounting. I take more pleasure in this work than in anything else I ever tried. I get more enjoyment with a camera in one week than I ever had with a gun in 6 months. I wish others would do as I have done, shoot with a camera instead of a gun.

J. F. Harris, Marion, N. C.

Recently I watched one of my photographic friends mix a new developer. He weighed out 4 ounces of sulphite, dumped it into a wide mouthed bottle; weighed out a like quantity of carbonate of soda and put that in another, and then poured water into both from an ordinary pitcher. I was astonished.

"Don't you know how much water you are adding?" I asked.

"Oh! sure; when I pasted the labels on the bottles I put them on so that their upper edges came even with the top of 16 ounces of water. Now I never have to use a graduate. I put in the required quantities of the sodas and then fill up to the top of the labels." The hint is a good one.—Western Camera Notes.

In your photo department I notice A. M. P., Clifton, N. J., wishes to know what is the best camera for amateurs to start with. Having had experience with several different makes when I was a beginner, I suggest a 4 x 5 Wizard or a Korona. I

found these 2 to be the simplest to manipulate and supplied with the best lenses, the Wizard especially having a lens that always cuts a clear, sharp picture, that gives encouragement to the tyro.

Your photo department excels any I have read, even in the photo journals.

Fred Boorman, Evelith, Minn.

I made a toning bath according to a formula printed in October RECREATION, the one including 30 grains of acetate of soda. It tones prints to a beautiful blue black, but they all have a pinkish hue. Can you tell me why? I have followed the directions accurately. It does not seem right to have the prints come out so pink.

Mrs. Carrie P. Hamilton, Lyrn, Mass.

ANSWER

I should say it was a case of double toning which probably comes from not neutralizing the toning bath properly.—EDITOR.

RECREATION has forwarded us the following query from you, namely: "If a dry plate be exposed, how long will it remain good?" In reply would say that the time elapsing between exposure before development can be almost unlimited. We have had instances brought to our attention where 5 years have elapsed. Of course it is advisable to develop as soon as you conveniently can after exposure, within 6 months or a year at most.

Carbutt Dry Plate and Film Co.

To use acetylene in a dark room, put a bicycle lamp outside the room and use rough, cathedral orange glass. The bicycle lamp will do business in rain, snow or fair weather and is built for outdoors. They now sell at only \$1.20 each. For fuel use calcium carbide, which costs 25 cents for a 2 pound can.—The Photo-American.

A peculiar flesh tone on p. o. p. may be had by dabbing hypo on the face and hands of the person on the print, then washing and toning as usual.—The Photo-American.

"Twinkle, twinkle, little star.
How I wonder what you are!"
"I'm a window 'way up high,
In a scraper of the sky."

—Exchange.

We cannot do without RECREATION and always look with pleasure for its coming.
W. G. Warren, Big Viney, Wyo.

RECREATION gets better every month.
E. T. Blossom, Otego, Mich.

No Dark-Room

is required in any part
of the work if you
make pictures in the

K O D A K

way. Ask your dealer
to show the Kodak
Developing Machine

*Send 10 cents in
stamps for the
Kodak Portfolio
containing 40 re-
productions from
prize winning pic-
tures in our recent
\$4,000 Competi-
tion.*

Eastman Kodak Co.

Rochester, N. Y.

Something New!

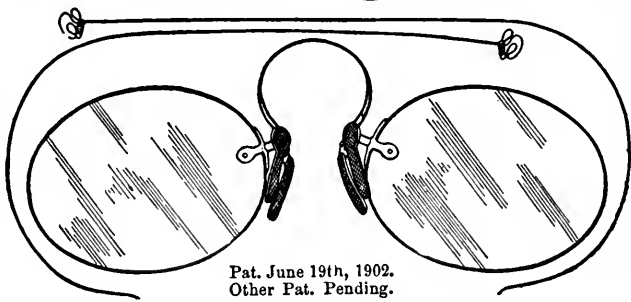

Pat. June 19th, 1902.
Other Pat. Pending.

PRESTO! CHANGE! Attachable Eyeglass Temples

Every wearer of eyeglasses wishes occasionally that they were spectacles. Spectacles stay on, however violent one's exercise, however warm or stormy the weather. This little device can be readily attached or detached without injury to the lenses, thus in a second giving you the choice of either spectacle or eyeglass. Just the thing for outdoor sports. The Temple Attachment will fit any of your eyeglasses and can be carried in the same case with them.

Send thickness of lens when ordering by mail.

Price in Nickel, 50 cents a pair
Price in Gilt, 75 cents a pair.

Send for Circular.

Our illustrated catalogue can be had for the asking

We carry everything in the Optical and Photographic line. Eyeglasses, Spectacles, Cameras, Opera, Field or Marine Glasses, Thermometers, Barometers, Telescopes, Hygrometers, Sun-dials, etc.

GALL & LEMBKE, Department C.

1 W. 42d Street 21 Union Sq., New York
Established 1842.

DO YOU WANT A CAMERA?

If so, you can get it
Without \$1 of Expense

- A Model 10, Century Camera. Listed at \$9.
For six yearly subscriptions to
Recreation.
- A Model 12, Century Camera. Listed at
\$18. For 12 yearly subscriptions to
Recreation.
- A 5x7 Century Grand. Long Focus, Double
Swing, with Wide Angle Lens. Listed
at \$60. For 40 yearly subscriptions to
Recreation.

Such opportunities were never before offered.

I have but a few of these Cameras on hand, and when the supply is exhausted this offer will be withdrawn.

Sample copies of *Recreation* for use in canvassing furnished on application. Address

Recreation, 23 West 24th St.
New York City

EVER NEW.

Dodgin' round among the boulders,
Whippin' with the bogus flies,
Rubberneck an' hump yer shoulders
Lookin' fur a speckled prize.
Peerin' through the wavin' willers
Eager fur to git a bite;
Holy smoke! I tell you fellers,
That's the acme of delight;
That's the sport that sends the spirit
Up to heaven, or mighty near it!

Waters on the rocks a dashin'
In their crystal, jolly fun,
Spray up in the air a flashin'
Liquid diamonds in the sun;
Songbirds in the trees a singin'
Sassy songs of music rare,
Butterflies around us wingin'
Jes' like spangles in the air,
Breezes in their merry freaks
Coolin' down the fevered cheeks.

Whiz! A hungry trout has lighted
On yer fly! Jes' see him spin!
Take it cool! Don't git excited!
Let him play an' reel him in!
How yer line does cut the water—
Holy Moses! See him jump!
Steady now! You hadn't oughter
Let him rattle you, you chump!
Give him line! What's that you say?
"—! —!! —!!! He got away!"

O! see here, now, stop yer cussin'!
Rippin' slivers from yer hat!
Doesn't help you out—sich fussin'
' Bout a little thing like that!
Runnin' swear-talk through yer throttle
Puts no sweetness in yer cup!
Hit the bait there in the bottle;
Mebbe it'll brace you up.
'Twan't your fault, fur fishers say
Big 'uns allus git away.

There's another! How he rushes!
Lordamighty, see him jump!
Line all tangled in the bushes!
There you go agin, you chump!
No, of course you didn't ketch him!
What the deuce you swearin' at?
How could you expect to fetch him
Through a network sich as that?
Git yer line ontangled, quick!
Lots more beauties in the crick.

Keeps a fishin' an' a r'arin'
Round till day begins to wane,
Then he starts for home a swearin'
He will never go again.
Meets a kid with fish—he eyes 'em—
Never was a finer string—
Nobody in sight—he buys 'em—
Then, a steppin' like a king,
Ambles homeward, mighty spry,
Loaded with the usual lie.
—James Barton Adams, in Denver Post.

IF YOU WOULD LIVE NEXT TO
NATURE, READ RECREATION.

R. O. C.

The Rochester Dry Plate

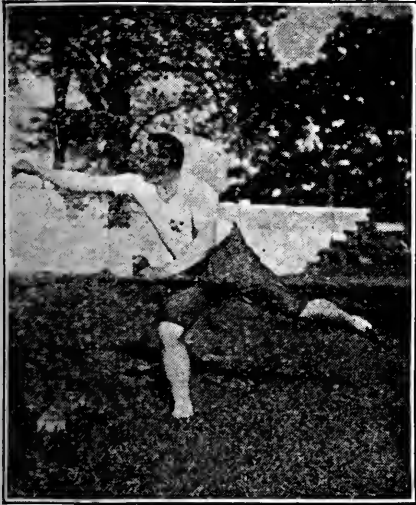

The speed of R. O. C. The Rochester Dry Plate is limited only by the speed of your lens.

It entirely upsets the old tradition that for good definition you must use a slow plate.

R. O. C. The Rochester Dry Plate, gets all there is to get, in the minimum of time.

Speed



Combined with the speed of R. O. C. The Rochester Dry Plate, is an orthochromatic quality, unusual in a plate for general purposes.

Indoors or out, there is no danger of meeting any condition of color or light for which R. O. C. The Rochester Dry Plate is not adapted.

Color

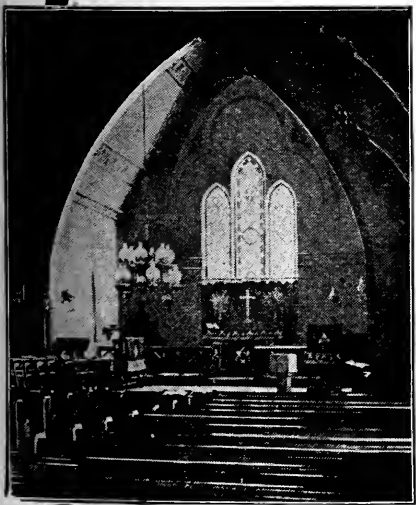

Halation is another problem reduced to the minimum by R. O. C. The Rochester Dry Plate. Here again is an advantage of having a plate of general utility.

R. O. C. The Rochester Dry Plate, very closely approaches universal perfection. We have a free book that tells you about it.

Light

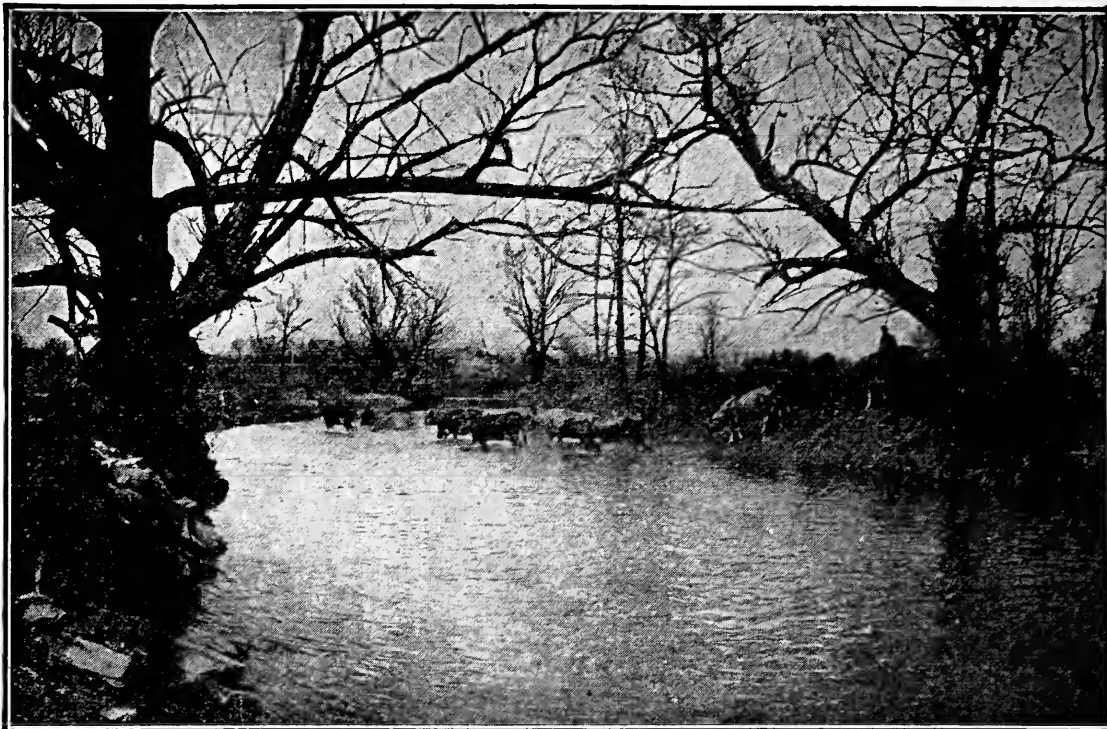

All in one picture, by the

take half-length views, or, with some models, stop the lens at five different places and thus make five different widths of pictures. This you can do in accordance with the view that you wish. No other camera possesses these advantages.

How often you find yourself on some high place with a view just in front of you, a part of which is not especially interesting, but the whole sweep of which view would make a delightful picture. You long for a camera that will record that whole view.

This is what the Al Vista will do!

We will send free on application our beautifully illustrated catalogue.

Multiscope & Film Co.

136 Jefferson St., Burlington, Wis.



Al-Vista Camera, or you can

Our cameras are the most simply constructed of any in the world, and the easiest to manage when they are understood. We send with each outfit a complete book of instructions. We will be glad to send copy of this free to anyone who will apply for it.

Our Co-operative Plan

We are sending out now a large number of cameras on this Co-operative Plan. A small first payment being made, we ship you the camera, and you can use it while you pay the remainder in monthly installments. This plan appeals to a great many people and certainly shows our confidence in the quality of our goods. Write us for full information about it.

Multiscope & Film Co.

136 Jefferson St., Burlington, Wis.

Are You an
Amateur
Photographer?



If so would you like a Camera
that will photograph

A whole range of mountains
A whole sweep of river
A whole army
A whole fleet of ships
A whole city

Or any other vast stretch of scenery or moving
objects? THE SWING LENS DOES IT

The Al Vista

Is the thing. It lists at \$30.

One of the greatest inventions of the age.
Given as a premium for 20 subscriptions,

For particulars Address

RECREATION

23 West 24th Street

NEW YORK CITY

IT'S ALL IN THE LENS

Series V Long Focus Korona

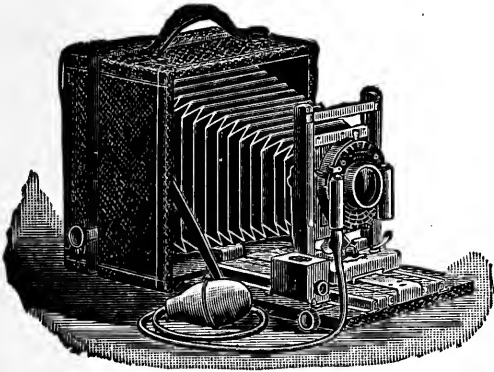

Can be used with equal facility for everyday, hand-camera

Snap Shots
Photographing Distant Views
Copying

or other work needing bellows capacity, and also with wide-angle lenses for interiors and kindred subjects.

ONE CAMERA DOES IT ALL

Every adjustment is a marvel of simplicity and mechanical ingenuity, and many of them are found exclusively on the Korona.

Note our patent auxiliary bed for use with wide-angle lenses, and compare it with

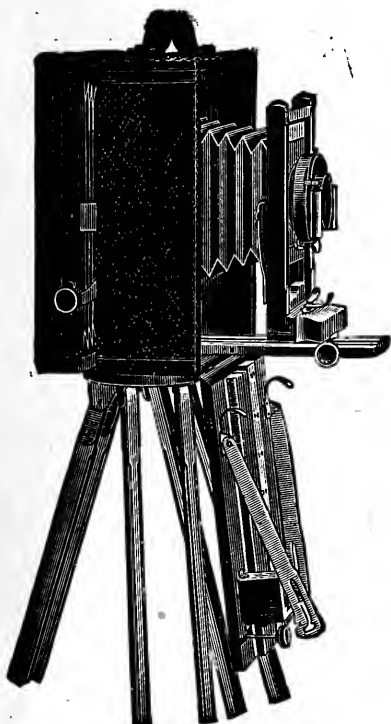
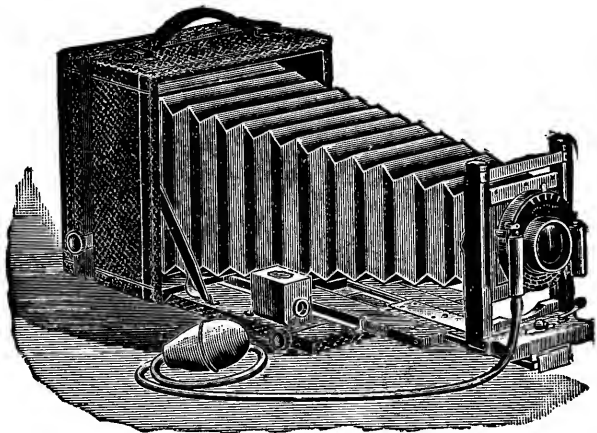

the clumsy methods used to obtain this result on other cameras.

Our patent automatic swing back operates from the center according to correct principles.

KORONA LONG FOCUS

Has a Convertible Lens, Automatic Shutter, and numerous other special advantages.

Catalogue gives full information

Gundlach-Manhattan Optical Co.

ROCHESTER, N. Y.



**Royals
Give
Results**

IN NAME—**ROYAL**—IN QUALITY
ARE

Royal Anastigmat Lenses

For success in Winter Photography, and especially for Indoor-Portraiture, a fast lens is a necessity, and in the **ROYAL** we offer one which will give results.

If you use a **ROYAL** you don't have to wait for the sunny days but can secure your subjects without the disappointing wait which is required when an ordinary lens is to be used. If you are not acquainted with the merits of these lenses, write and let us tell you some of the qualities, which we claim will interest you. New Catalogue now ready.

ROCHESTER LENS CO.
ROCHESTER, N. Y.

The Rocky Mountain Goat

Is a shy, wary animal that ranges
8,000 to 15,000 feet
above sea level

and has rarely been photographed. Mr. A. M. Collins, one of RECREATION's prize winning photographers, has recently made 4 of the finest goat pictures ever produced. I HAVE had enlargements made from these, 13 x 15 inches, and will sell them

At \$5.00 a Set.

A rare and valuable group for sportsmen, amateur photographers and nature students. Address

**RECREATION, 23 WEST 24th ST.
NEW YORK CITY**

FREE.

To any person sending me a subscription to RECREATION, accompanied by \$1, I will send one copy of the "Song of Songs," a drama in 5 acts, based on the Song of Solomon. This is an interesting, instructive and elevating play, written by my late husband, the Rev. Morse Rowell, Jr. The book is bound in paper and is alone worth \$1. In addition I have arranged with the editor of RECREATION to send the magazine to all subscribers who may send me their subscription on this plan.

Mrs. Belle J. E. Rowell,
Miller Place, L. I.

Free: To anyone sending, through me, \$1 for yearly subscription to RECREATION, I will send free a No. 1 Sportsman's Medicine Case; for 2 subscriptions a Physician's Pocket Medicine Case; for 10 subscriptions 1,000 12-gauge primed paper shot shells. This offer is not open to old subscribers who formerly have sent in their subscriptions to the office of RECREATION, but to all others.
Walter Luson, Ardmore, Pa.

I received the Harrington & Richardson gun promptly and find it satisfactory in every way. Please accept my sincere thanks.
C. G. Fisher, Piquet, O.

CENTURY CAMERAS

Better get your name on our mailing list for a copy of the 1903 Century Catalogue, now in press. It will illustrate and describe the finest line of Cameras ever made, and contain information of value to every photographer. A postal will bring it. **CENTURY CAMERA CO., Rochester, N. Y.**

A GOOD 20 BORE.

On selling a 10 pound double gun a few years ago I bought a 20 gauge single barrel Hopkins & Allen. My experience with this little gun has greatly exceeded my expectation. As a squirrel gun I do not see how it can be surpassed. I use brass shells with $2\frac{1}{2}$ drams of powder and $\frac{3}{4}$ ounce of shot. Two thick cardboard wads and one felt wad between, all 16 gauge, are forced in over the powder and 1 thin 16 gauge felt wad over shot. With No. 4 or No. 5 shot loaded in this way, squirrels in the tallest trees here invariably tumble. Out of 16 squirrels shot at last fall only one was missed, and that by a little too hasty pulling of the trigger. Among shots made with the gun was the killing of a rabbit 82 yards away. I have put 7 to 9 pellets of No. 4 in a 5 inch circle, at 40 yards. I can not see why it is necessary to use a larger gauge and more ammunition. The 10 and 12 gauges with $1\frac{1}{8}$ ounce or more of shot might mow a larger swath through a flock of quails, but I do not care to buy any game the 20 will not kill.

L. B. Mitchell, Hart, Mich.

Sent Free: Ten varieties of Mexican postage and revenue stamps for one annual subscription to RECREATION sent in through me. Stamp collectors should not miss this chance to increase their collection of Mexican stamps. Albert M. Penn, Laredo, Tex.

Colored Photography

accomplished by the use of

LOXOL

A new chemical compound which will produce prints colored true to nature.

Booklet sent free. Beautiful specimens of results produced, for 15c in stamps. Suitable for framing. Complete outfit from your dealer or sent by express on receipt of \$2.00.

ROCHESTER CHEMICAL CO.,
180 West Main Street, Rochester, N. Y.

LANTERN SLIDES COLORED IN AN ARTISTIC MANNER

Special attention given to the wants of Amateur Photographers. Correspondence promptly attended to. I refer by permission to the Editor of RECREATION.

MRS. BUTTLES SMITH,
606 W. 115th Street, New York City.

MAGIC LANTERNS STEREOPTICONS and VIEWS

for Public Exhibitions, Church Entertainments, for illustrating sermons. Many sizes. All prices. **Chance for men with little capital to make money. 260 page Catalogue FREE.**

McALLISTER, Mfg. Optician, 49 Nassau St., N. Y.

HUNTING CHAMOIS IN THE ALPS.

PETALUMA.

Some years ago my friend L. and I were strolling through the streets of Munich. As we were both officers of the German Forest Guard, our talk was naturally of the game at our respective stations. Suddenly a passing carriage pulled up, a young man jumped out and hailed us.

"Hello! you green boys!" he cried, alluding to the color of our uniforms, "why have you never come to hunt with me as you promised? I return home tomorrow and you must come with me. Your wives can visit my wife and doubtless they will all be glad to get rid of us woodcocks a while. There is plenty of room at the castle and we shall have a merry time."

It was von M., a former classmate. He would take no refusal, and the following day we accompanied him to his home. There we met Count P., who was in the woods to try conclusions with a certain old bull elk known as the devil. This animal had been on the open list 5 years, and many famous hunters had wasted time pursuing him.

Soon after the second day 3 couples, Count P. and an old forester, von M. and L., and a young ranger and I, left the castle, intending to hunt in different directions. We agreed to meet at nightfall on the following day at a log cabin 4 miles distant. My guide and I reached our camp at sundown. After we had supped we turned in, that we might be in shape to reach the chamois grounds before sunrise.

It was still pitch dark when we got away and we traveled an hour before we heard a sound. Then from far away came the mooning call of an old bull elk. "That is the 'Devil,'" my guide exclaimed. Immediately the call was re-echoed in many directions from younger throats, and from the hill above us came a call almost as loud as the first; but our business that day was not with elk, and we hastened on.

At last we reached a point which the guide said commanded 3 trails, and there we lighted our pipes and waited for daybreak and chamois. The first soon came; the other, not at all. It was perhaps 9 o'clock when my guide suggested that I climb a ridge he pointed out, and wait there while he cast about for game. When I reached the designated spot he was out of sight and I soon forgot why I was there. On one side lay the peaceful lowland, thousands of feet beneath me; on the other, towered countless mountain peaks. To the northeast I could make out a peak in the forest of which I had charge. To the North I could barely distinguish the towers of Munich.

Presently the falling of a stone attracted my attention, and I saw a bunch of chamois on a ridge just within rifle range. At first

I thought them all does until one came in sight whose short neck and general appearance proclaimed it a buck. I could not make out his horns, but as the bunch began moving, I fired. The animal rolled down hill, while its companions disappeared over the top. An hour later, when my guide returned, we found I had killed an old dry doe. However, it is lawful to kill such animals in the Alps. The guide put her in the back-sack that a German hunter always carries and we started for camp.

On our way was a little shack where we ate lunch and rested. While there my guide asked for my glass and presently pointed out some black spots, which he said were old bucks. It was then 3 o'clock and to sneak around behind them would have taken until dark. Our only chance was to cross an open flat in front of the game. On hands and knees we made the attempt. Reaching the first boulder we listened for a warning signal from the chamois. I told the guide to stay where he was, and I crept forward.

After half an hour of stalking I reached a point which I thought was within fair range of the bucks. Rising to my knees I saw 3 of them feeding tranquilly, but far beyond the reach of my double barreled 38-42. There was no chance to get closer without making a wide detour, and the light was rapidly failing. I was on the point of giving up when I saw a bunch of chamois coming down a nearer ridge. I risked a shot at a 3 year old, raising the sight to 350 yards. I saw the bullet fall short and knew I had made the common mistake of underestimating distance when shooting across a canyon.

At the report of my rifle the bunch went flying up the ridge, and at the same instant a big old buck came around a boulder not 40 yards from me. Up went the gun again, but as I aimed I saw I had forgotten to lower the sight. By the time I remedied the mistake the old fellow had taken the alarm and was running his best, 100 yards away. As I fired he rolled over and over, and being at the edge of a sheer fall, went down and out of sight. Finding it impossible to climb down after him I returned to the guide and, to my surprise, found he had the buck. He had kept track of my movements and, seeing the animal fall over the ledge, had known just where to find it.

An hour later we were at the log cabin, where we found our friends and all of von M.'s forest employees. L. had shot a buck and, having plenty of time, had picked a lot of chamois cress for our supper. Count P. had stalked and shot an elk that he supposed was the "Devil," only to find his kill an ordinary 12-pointer. Chamois liver, chamois cress, Munich beer and good company rounded off a glorious day with a jolly evening.

UNCLE SAM'S HEAVY LOAD

U S. USES 800 MILLION POUNDS OF COFFEE EVERY YEAR—OVER
10 LBS. PER CAPITA (see report International Coffee Commission, 1902.
COFFEE CONTAINS .008 OF CAFFEIN (M. Payen's analysis, accepted as
standard).

12 GRAINS OF CAFFEIN IS A FATAL DOSE (medical authorities).

A GRAIN IS $\frac{1}{7000}$ OF A POUND, AVOIRDUPOIS (Webster's Dictionary).

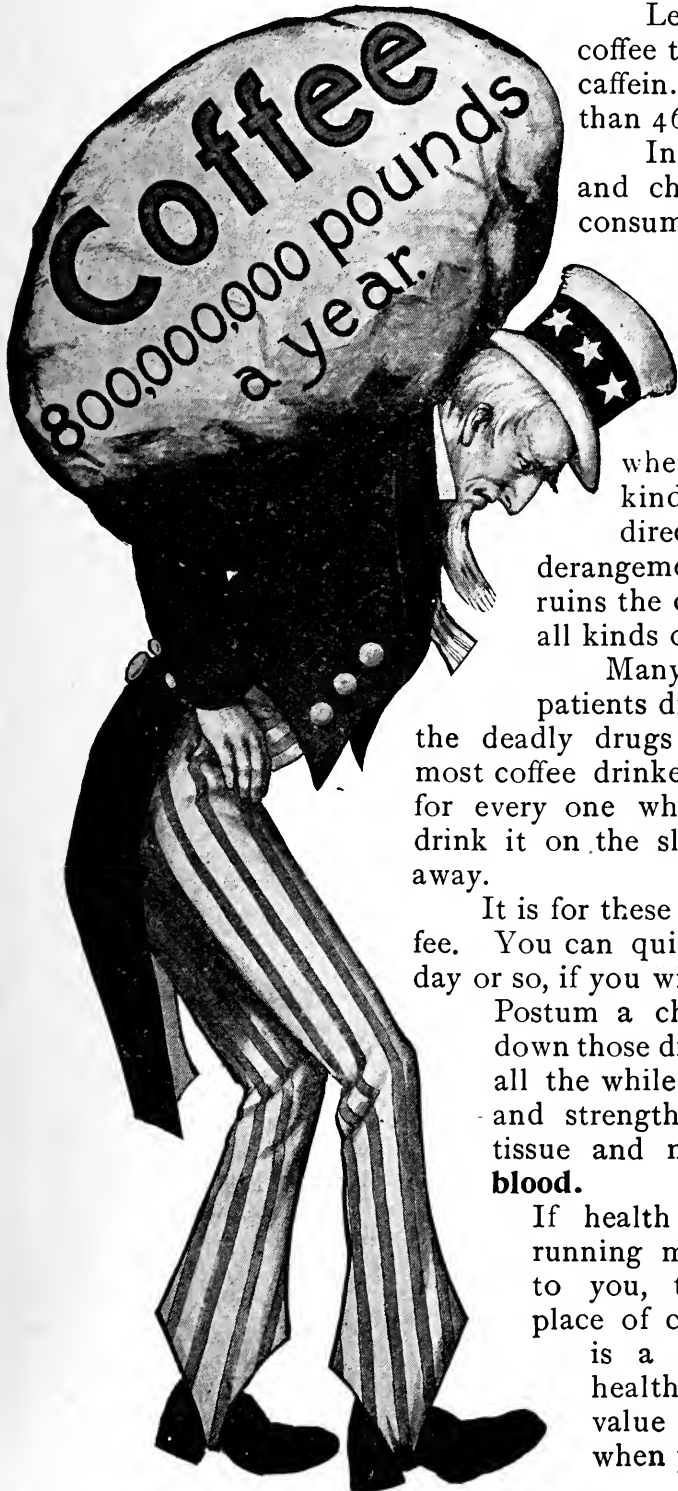

Let's figure it out. In 10 pounds of coffee there are $\frac{8}{100}$ pounds or 560 grains of caffein. Divided by 12 this equals more than 46 fatal doses of this deadly drug.

In other words, every man, woman and child (average) in the United States consumes little by little in one year enough of the poisonous alkaloid, caffein, to kill 46 people.

As the coffee drinker takes it in small doses and diluted, this caffein does not kill outright. But it is easy to believe medical science when it tells us that coffee sets up all kinds of diseases. Science says coffee directly attacks the vital organs, causes derangement of the heart, kidney troubles, ruins the coating of the stomach, and sets up all kinds of mental and nervous ails.

Many physicians now absolutely prohibit patients drinking tea or coffee, on account of the deadly drugs that these drinks contain. But most coffee drinkers are such slaves to the habit that for every one who stops coffee there are ten who drink it on the sly. They think they cannot break away.

It is for these that science invented Postum Coffee. You can quit instantly and never miss it after a day or so, if you will drink Postum in its place. Give Postum a chance and it will certainly knock down those diseases which coffee has set up. And all the while it is curing these it is nourishing and strengthening and building up muscular tissue and nerve matter. **It is making red blood.**

If health and happiness and a smoothly running mind and body are of any account to you, take on Postum for ten days in place of coffee, and see the result. Postum is a scientific food-drink made from health-giving grains, heavy with food value and delicious in taste and aroma, when properly made.



Five Little Beauties

and Their Marvelous Growth of Hair.

FREE TO ALL, a trial package of a new and wonderful remedy mailed free to convince people it actually grows hair, stops hair falling out, removes dandruff and quickly restores luxuriant growth to shining scalps, eyebrows, and eyelashes and restores the hair to its natural color. Send your name and address to the Altenheim Medical Dispensary, 7735 Foso Building, Cincinnati, Ohio, for a free trial package, enclosing a 2-cent stamp to cover postage. Write to-day.

First Hunter—It was your fault I didn't shoot that deer this morning.

Second Hunter—My fault?

"Yes; I saw something moving. When I said, 'Is that you, Jim?' the deer ran. Next time I'm going to say nothing and shoot, so look out."—Pittsburg Chronicle.

A publication of the character and merit of RECREATION ought to be encouraged.

David J. White, Pawtucket, R. I.

The International DENTIFRICE

Insures beautiful teeth, sweet mouth, agreeable breath. Preserves while it beautifies. No powder or liquid to spill or waste in use. Convenient, Economical.

25 Cents. At all druggists.

C. H. STRONG & CO., Chicago, U.S.A.



The Laughlin Fountain Pen

IS THE PEER OF ALL PENS AND HAS NO EQUAL ANYWHERE

Sent on Approval
to Responsible People

YOUR CHOICE
OF THESE TWO POP-
ULAR STYLES
FOR ONLY

\$1.00

Post-paid
to
any
address

By Registered Mail 8c
Extra

Superior to the \$3.00
Grades of
Other Makes

Our Extraordi- nary Offer

Send us one dollar and we will mail either of these two styles. You can try it for a week—if it don't suit you mail it back to us and we will return your dollar. Ever hear or read of anything fairer?

The Laughlin Fountain Pen holder is made of finest quality hard rubber, is fitted with highest grade, large size, 14k gold pen of any desired flexibility, and has the only perfect feeding device known. Either style richly gold mounted, for presentation purposes, \$1.00 extra.

Lay this magazine down and write now.



Laughlin Mfg. Co.

424 Griswold St.

DETROIT, MICH.

BUTTERFLY
FLOWER

FLORAL BUTTERFLY PLANT

No plant possesses so many good points as do these two glorious new Commelinas. Of graceful trailing habit, superb for carpet bedding or for hanging pots. *In pots they bloom every day in the year.* In the garden from May until frost, showing *daily* scores of large winged butterfly-like blossoms. Color (No. 1) the most beautiful blue to be found in any flower. A shade so exquisitely lovely as to baffle description. Thrives in sun or shade, wet or dry, rich or poor soil; as easily raised as a weed from seed or cuttings, grows rapidly, flowers at once, and propagates so easily that plants are very cheap. Blooms in 50 days from seed.

No. 1—Exquisite Blue, like tropical Butterflies.

No. 2—Rosy Pink, in other respects like No. 1.

Strong plants for blooming at once, by mail guaranteed to grow, 20c each; the 2 for 30c, 5 for 60c.

Seed of both colors mixed, 25 cts. per packet.

FREE OUR GREAT CATALOGUE of Flower and Vegetable Seeds, Bulbs, Plants and Rare New Fruits, Profusely Illustrated, Large Colored Plates—136 pages. Do not miss our great Novelties, Emperor Asparagus (crop in 11 months from seed), Early Lima, Perpetual Rhubarb, Pineapple Onion, Climbing Currant and Blackberry, Everblooming Wistaria, Tree, and Double Lilacs, etc. We have the finest Asters, Pansies, Peas, Stocks, Verbenas, Geraniums, Azaleas, Roses, Palms, Ferns, Begonias, Gloxinias, Violets, Phloxes, Gladiolus, Cannas, Dahlias, Lilies, Caladiums, Shrubs, Vines, New Fruits, and all Vegetables.

JOHN LEWIS CHILDS, Floral Park, N. Y.

One Sunday last fall a party of 10 left Los Angeles at 4 a. m. with a stage and 4 horses. When we reached our shooting ground, 3 hours later, we found 25 or 30 men ahead of us. They had cleaned out the birds completely, and instead of broiled quails for dinner we had to fall back on baked beans. Later in the day we succeeded in killing 14 quails, not an excessive bag for 10 men. Returning we met 4 men with 4 dogs. They claimed to have killed 100 birds each. We did not count the game, but saw a big pile of quails in their wagon. When they laughed at our poor luck, we told them that, though we had no objection to a fair bag, we would rather kill 5 birds each than 100. F. S. Herr, who was with us, had the pleasure of shooting a buck deer with a kodak at 25 yards. He had a gun with him and is an old hunter, but said he would not shoot a deer that seemed as tame as that one.

M. A. G., Pasadena, Cal.

FREE. To anyone subscribing to RECREATION through me I will give a cloth copy of one of Cooper's, Dickens', Dumas', Thackeray's or Conan Doyle's books. Address,

J. M. RUGEN, 2108 West Lake St., Chicago, Ill.

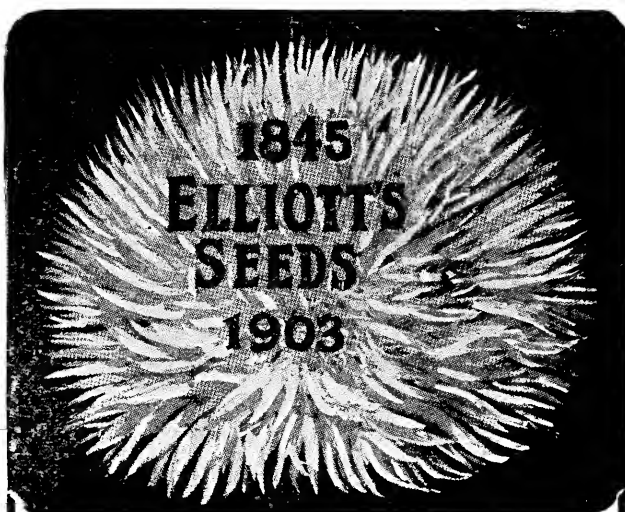

SWEET SULTAN

(*Centaurea*)

with large, pure white blossoms, richly scented, exquisitely sweet and graceful. Has long stems, and will last a fortnight in water.

For 10c, in Stamps or Silver we will mail you one packet of this choice seed and our annual, Free.

WM. ELLIOTT & SONS

Dept. X 54 & 56 Dey St., New York



The first dining car in the world, the "Delmonico," was run by the Chicago & Alton in 1868. Then the "Alton" was the best dining car line because it was the only one. To-day it is the best dining car line because it is "The Only Way"



PEOPLE YOU MEET IN THE DINING CAR

Pictures of an American Prince, an old maid, a drummer, a pretty girl, a farmer, and other types, are contained in a booklet, which will be sent for a two cent stamp. Address Geo. J. Charlton, Gen. Pass. Agt., C. & A. R'y, Chicago, Ill., who also has on hand a few Fencing Girl calendars at 25 cents each.



When you play with Bicycle Playing Cards you hold Good Cards.

Bicycle cards always wear well. Sold by dealers. Popular price. Order by name. 29 backs. Design shown is "Automobile" back, copyrighted, 1902, by

The U. S. Playing Card Co.
Cincinnati, U. S. A.

We will send 128-page Condensed Hoyle for 10c. in stamps, if addressed to Department: 23

Cap'n Titus

By **CLAY EMERY**

Boston Globe

"Rich and racy salt-briny stories, depicting New England country folk to the life."

Washington, D. C., Evening Star

"Mr. Emery has artistically caught the spirit of the folk-life of New England."

Rochester Democrat and Chronicle

"Uproariously entertaining."

New York Times

"He is another David Harum in story-telling and trading."

Price, 75 cents

Postage Paid

DOUBLEDAY, PAGE & COMPANY
PUBLISHERS

34 Union Square

New York

It is all in The Lens

Any old box will answer the purpose if it does not leak light; but you must have a fine lens to make a fine picture.

You can get

A Royal Anastigmat Lens, 4x5, Series No. 1

Made by the Rochester Lens Co., Rochester, New York,

**And listed at \$45,
For 40 yearly subscrip-
tions to RECREATION**

You can get any other lens made by this Company on the basis of one subscription to each dollar of the list price of the lens.

Sample copies of RECREATION for use in soliciting furnished on application.

FREE LINEN and LACE MATERIALS

We will send you **ABSOLUTELY FREE** 774-square inches of linen and lace materials, consisting of 1 Hollyberry and 1 Forget-me-not centrepiece, and 4 large doilies, Strawberry, Rose, Maiden Hair and Forget-me-not designs, 2 linen collars, prettiest and latest designs for neckwear, making 8 pieces of linen, all stamped in the most exclusive designs, **ALSO BATTENBURG** Lace Designs enough for 1 lace handkerchief, 1 tie end, 2 turnover collars, 2 large doilies, all on special satin-finished cambric, making **14 NEW DESIGNS**. We will send you the entire 14 pieces as described **ABSOLUTELY FREE**, if you will send us only twenty-five cents for a three-months' trial subscription to our most wonderful magazine, **THE MAGAZINE OF MYSTERIES**. Truly this is a marvelous offer, as the subscription price of our magazine alone is one dollar per year. Send to-day. Address **The Magazine of Mysteries, No. 22 North William Street, New York City.**

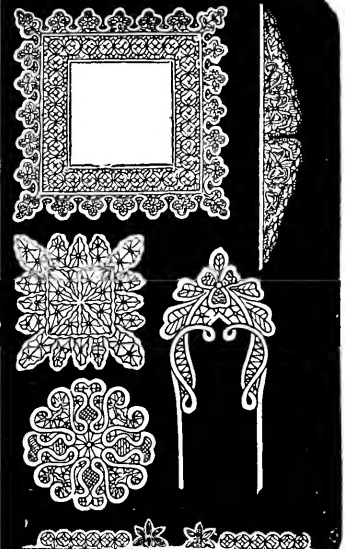
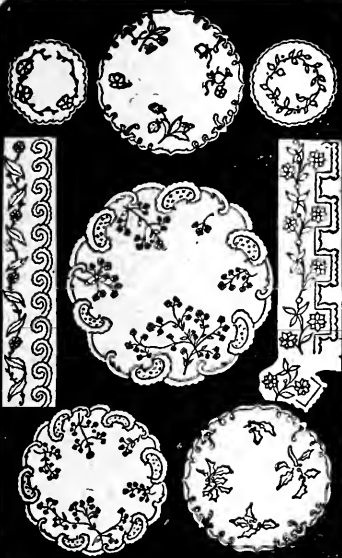

THE MAGAZINE OF MYSTERIES fully lives up to its name. There is not a dull thing between its covers.—Oakland (Cal.) Tribune.

During the past summer I visited the shooting grounds of the sportsmen's club of this city and from what I saw of the shooting done there, I am convinced that unless double guns and repeaters and also bird hunting dogs are heavily taxed the game must go. A bird has no chance when the hunter can get ready to shoot before it rises, as is the case when shooting over a dog. Game is scarce here, especially grouse and woodcock. I am happy to say RECREATION is having a great influence. It puts gentlemen on their honor and excites the fear of swine.

C. P. White, Worcester, Mass.

WRITE FOR MONEY



as our graduates are doing successfully. Send for free booklet, "Writing for Profit," tells how to succeed as newspaper correspondent, magazine-contributor, and short-story writer. Learn Journalism and Story-Writing by mail at home, during spare hours. MSS. criticised and revised; sold on commission. THORNTON WEST, Editor-in-Chief. Founded 1895. THE NATIONAL PRESS ASSOCIATION, No. 109 The Baldwin, Indianapolis, Ind.



"They tell me, professor, you have mastered all the modern tongues."

"Well, yes; all but my wife's and her mother's."—Pennsylvania Punch Bowl.



The "Victor" is the real talking machine; its sound is natural. Band playing, monologues, comic or religious songs, all are reproduced as clear as if the artist was present. When ordering, **get the latest styles**—we charge no more than others who offer you old styles. Get our full catalogue **FREE**.

E. L. Cuendet, 7 Barclay St., New York

No. 58

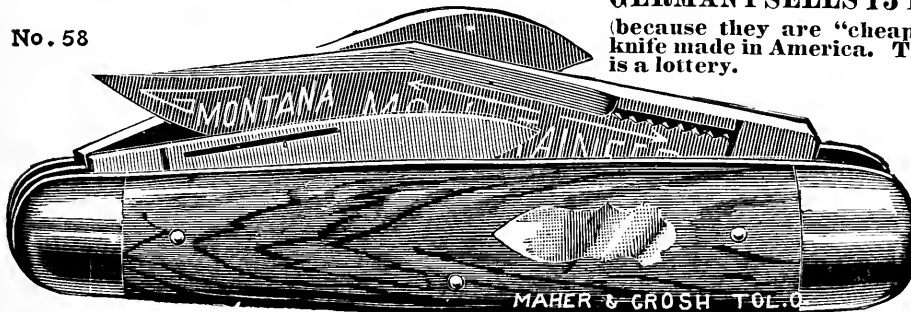

GERMANY SELLS 15 KNIVES IN THE U.S. (because they are "cheap" and showy) for every knife made in America. That's why buying cutlery is a lottery.

No. 58. Cut is exact size; ebony handle, 3 blades, German silver ends. The long blade is for rough or fine work; the medium blade is as thin as a razor. Price, postpaid, \$1.00. 50,000 in use.

No. 34 we call 'Our Masterpiece,' weighs only 2 ozs.; 3 cutting blades; will cut a quill pen or an ax-handle; price, with ebony handle, postpaid, \$1.25; ivory, \$1.50; choicest pearl, \$2.00.

No. 34

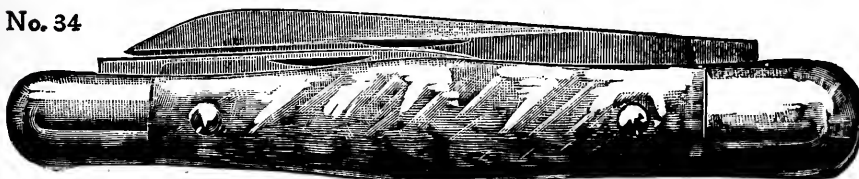

Our **Jack Knife** sells at 75c.; our special price is 48c. postpaid, 5 for \$2.00. All our blades file tested; warranted; replaced free if soft or flawed. Barbers' hollow ground **Razor and Strop** to suit, \$1.33. Send for free 80-page list and "How to Use a Razor."

MAHER & GROSH CO.
74 A Street Toledo, Ohio

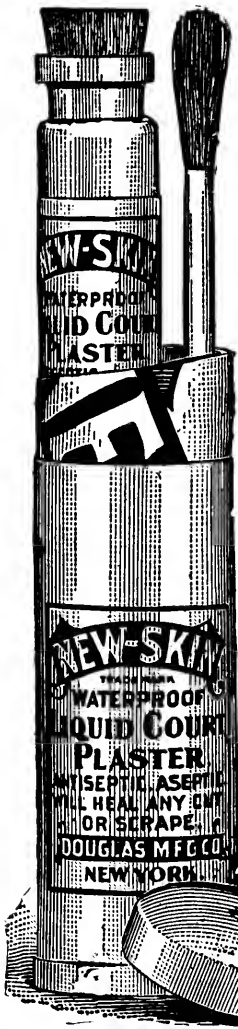

NEW-SKIN
TRADE MARK
REGISTERED
WATERPROOF
LIQUID COURT PLASTER

Heals Cuts, Abrasions, Hang-Nails, Chapped and Split Lips or Fingers, Burns, Blisters, etc. Instantly Relieves Chilblains, Frosted Ears, Stings of Insects, Chafed or Blistered Feet, Callosities, etc., etc.

A coating on the sensitive parts will protect the feet from being chafed or blistered by new or heavy shoes. Applied with a brush and immediately dries, forming a tough, transparent, colorless waterproof coating.

Mechanics, Sportsmen, Bicyclists, Golfers' Etc.

are all liable to bruise, scratch or scrape their skin. "NEW SKIN" will heal these injuries. WILL NOT WASH OFF, and after it is applied the injury is forgotten, as "NEW SKIN" makes a temporary new skin until the broken skin is healed under it.

EACH
Pocket Size (Size of Illustration) . . . 10c.
Family Size 25c.
2 oz. Botts. (for Surgeons and Hospitals) 50c.

At the Druggists, or we will mail a package anywhere in the United States on receipt of price.

DOUGLAS MFG. CO.
Dept. W
107 Fulton St. New York

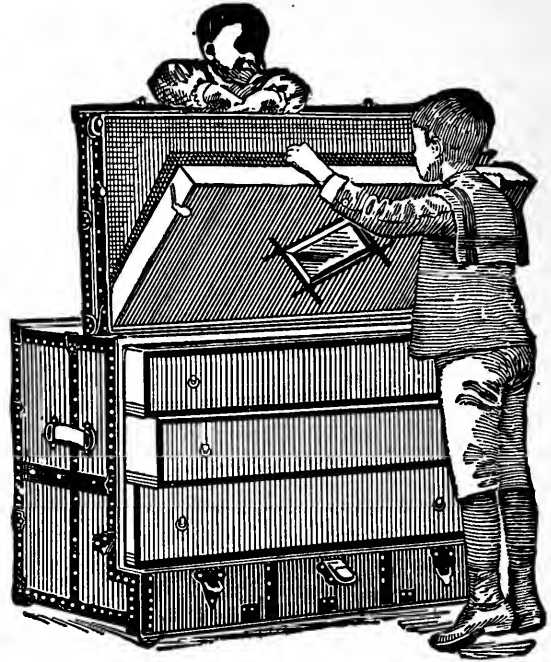

Stallman's Dresser Trunk
Have you seen one? It is up-to-date. Think of it, everything within reach. No heavy trays, but light, smooth drawers. Holds as much and costs no more than a good box trunk. Hand riveted, almost indestructible. Once tried, always recommended. Sent C. O. D., privilege examination. 2c. stamp for catalogue. Mention RECREATION.

F. A. STALLMAN,
87 W. Spring St., Columbus, O.

FREE HAIR FOOD

FALLING HAIR AND BALDNESS ABSOLUTELY CURED

There is but one way to tell the reason of baldness and falling hair, and that is by a microscopic examination of the hair itself. The particular disease with which your scalp is afflicted must be known before it can be intelligently treated. The use of dandruff cures and hair tonics, without knowing the specific cause of your disease, is like taking medicine without knowing what you are trying to cure. Send three fallen hairs from your combings, to Prof. J. H. Austin, the celebrated Bacteriologist, who will send you absolutely free a diagnosis of your case, a booklet on care of the hair and scalp, and a sample box of the remedy which he will prepare specially for you. Enclose 2c postage and write to-day.

PROF. J. H. AUSTIN
633 McVicker's Bldg., Chicago, Ill.

Do You Keep a Gun?

If so, would you not like a rack for it?

Do you keep more than one gun?

If so, would you not like racks for all of them?

For 5 yearly subscriptions to RECREATION

I will send you

a pair of buffalo horns

beautifully polished and mounted on nickel bases, which may be screwed on the wall.

A pair of these horns make a unique and convenient gun rack, and a valuable trophy of the grandest game animal America ever had.

These horns are easily worth

five dollars

a pair and sell readily at that price. I have been fortunate in securing a considerable number of them at a price that enables me to make this remarkable offer.

Send in your Club at once.

THE WILY FISHERMAN.

R. R. R.

It was a wily fisherman
Who went to catch a trout;
He stepped into his little boat
And gently pushed it out.

He had a little rod and line,
A basket full of lunch,
And a dainty little bottle that
Was full of whiskey punch.

Along there came a giant trout,
And, snapping at the fly,
He switched away the tackle in
The twinkling of an eye.

And then out spoke this fisherman,
"Now I must go ashore,
I've lost my rod and tackle and
I can't fish any more.

"But stay! I have a bright idea;
I'll wait with bated breath,
And when he comes, that mighty fish,
I'll lure him to his death."

He felt within his basket there
Until he got a bite;
And then he seized his bottle and
He pulled with all his might.

He pulled away until he saw
The bottle had grown hollow;
And then he found what he had caught
Was nothing but a swallow.

THREE OLD GUNS.

I have been much interested in accounts of long barreled guns of the olden time and it has been my fortune to see 3 of those ancient and honorable weapons.

The first was an 8 pound, bell muzzle, flintlock, with fancy brass mountings. It had a full length carved walnut stock and silver sights. The bore was 14 gauge, enlarged to 10 at the bell. The lock was marked Dublin Castle, and the barrel stamped with a crown, G. and 12. It was 6 feet 2 inches long and in serviceable condition, making a good target.

The second was of much clumsier make and weighed 11 pounds. Plain, brass mounted, full length butternut stock. It was 10 bore and about 8 at the bell. Stock marked 5-B-11. On the lock was stamped the date, 173—, the last figure being worn off. Barrel marked with a crown and a V.

The third was a Government smooth bore, flintlock, with trowel bayonet and walnut stock. Lock had brass pan and brass top. The gun was marked T. Wickham, London, 1834.

G. E. Morris, Somerville, N. J.

IN ANSWERING ADS PLEASE
MENTION RECREATION.

As TIME
is the stuff
Life's made of,
take
it from an

Elgin Watch

the timekeeper of a
lifetime—the world's
standard pocket time-
piece. Sold every-
where; fully guaran-
teed. Booklet free.

ELGIN NATIONAL WATCH CO.
ELGIN, ILLINOIS.

OIL--SMELTER--MINES!

DOUGLAS, LACEY & Co.

66 BROADWAY & 17 NEW ST., NEW YORK.

Bankers, Brokers, Fiscal Agents.

Members N. Y. Consolidated Stock Exchange, and
Los Angeles, Cal., Stock Exchange.

**Dividend-Paying Mining, Oil and Smelter
Stocks, Listed and Unlisted our Specialty.**

Booklets giving our successful plan for realizing the large
profits of legitimate Mining, Oil and Smelter Investments,
subscription blanks, full particulars, etc., sent free to any
interested on application.

BRANCHES. Boston, Philadelphia, Chicago, Cleveland, Cin-
cinnati, St. Louis, Baltimore, Washington,
Pittsburg, Buffalo, Prescott, Ariz.; Los Angeles, Cal.; Hart-
ford, Halifax, N. S.; St. John, N. B., Montreal & Toronto.



H. J. TILLOTSON, M. D.
The Master Specialist of Chicago, who Cures Varicocele,
Hydrocele, and treats patients personally.
Established 1880.
(COPYRIGHTED)

manent. My consultation will cost you nothing, and my charges for a perfect cure will be reasonable and not more than you will be willing to pay for the benefits conferred.

Certainty of Cure is what you want. I give a legal guaranty to cure or refund your money. What I have done for others I can do for you. I can cure you at home

Correspondence Confidential. One personal visit at my office is preferred, but if it is impossible for you to call, write me your condition fully, and you will receive in plain envelope a scientific and honest opinion of your case, Free of charge. **My home treatment is successful.** My books and lectures mailed free upon application.

H. J. TILLOTSON, M. D., 140 Tillotson Bldg, 84 Dearborn St., CHICAGO

Varicocele Hydrocele

**Cured to Stay Cured in 5 Days.
No Cutting or Pain. Guaranteed
Cure or Money Refunded.**

VARICOCELE. Under my treatment this insidious disease rapidly disappears. Pain ceases almost instantly. The stagnant blood is driven from the dilated veins and all soreness and swelling subsides. Every indication of Varicocele vanishes and in its stead comes the pleasure of perfect health. Many ailments are reflex, originating from other diseases. For instance, innumerable blood and nervous diseases result from poisonous taints in the system. Varicocele and Hydrocele, if neglected will undermine physical strength, depress the mental faculties, derange the nervous system, and ultimately produce complicated results. In treating diseases of men I always cure the effect as well as the cause. I desire that every person afflicted with these or allied diseases write me so I can explain my method of cure, which is safe and permanent.

White Mountain Views Free

To any person sending me a subscription to RECREATION accompanied by \$1. I will send two mounted photos, on velox paper taken among the White Mountains, size 6x8; one shows Mt. Washington snow capped. To any one sending 2 subscriptions with \$2 I will send a souvenir of the White Mountains, size 4½x5½ containing seven photos. Send P. O. Money Order

M. E. TUTTLE, Box 337, Dover, N. H.

Game will be abundant here in season, with plenty of good duck shooting.

J. W. Stapleton, York, Neb.

Another Good Offer. Send me \$1 for a subscription to RECREATION, or send it direct to RECREATION to be credited to my account, and I will send you free, a beautiful unmounted Mexican Opal, which would cost ordinarily from 50c to \$1. Don M. Harris-308 Crawford Road, Cleveland, Ohio.

The Guthrie hunting boots sent me as premium for securing 10 new subscribers to RECREATION came in good shape. They are the best of the kind I have seen and bearing the Guthrie trademark I feel sure they will give perfect satisfaction.

S. E. Putnam, Cleveland, O.

The Lamp of Steady Habits



The lamp that doesn't flare up or smoke, or cause you to use bad language; the lamp that looks good when you get it and stays good; the lamp that you never willingly part with, once you have it; that's

The New Rochester.

Other lamps may be offered you as "just as good"—they may be, in some respects, but for all around goodness, there's only one. *The New Rochester.* To make sure the lamp offered you is genuine, look for the name on it; every lamp has it. (300 Varieties.)

Old Lamps Made New.

We can fill every lamp want. No matter whether you want a new lamp or stove, an old one repaired or refinished, a vase mounted or other make of lamp transformed into a **New Rochester**, we can do it. Let us send you literature on the subject.

We are SPECIALISTS in the treatment of diseases of Lamps. Consultation FREE.

THE ROCHESTER LAMP CO., 38 Park Place & 33 Barclay St., New York.



THE Keeley Cure

**Alcohol,
Opium,
Tobacco
Using ***

Produce each a disease having definite pathology. The disease yields easily to the Treatment as administered at the following Keeley Institutes:

ALWAYS ADDRESS THE INSTITUTE NEAREST TO YOU.

Birmingham, Ala.	Crab Orchard, Ky.	Omaha, Neb.	Pittsburgh, Pa.,
Hot Springs, Ark.	New Orleans, La.,	Cor. Leavenworth	4246 Fifth Ave.
Los Angeles, Cal.	1628-38 Felicity St.	and 19th Streets	Providence, R. I.
San Francisco, Cal.,	Portland, Me.	Fargo, N. D.	Columbia, S. C.
1170 Market St.	Lexington, Mass.	North Conway, N. H.	Sioux Falls, S. D.
West Haven, Conn.	Detroit, Mich.,	Buffalo, N. Y.	Dallas, Tex.,
Washington, D. C.,	86 Lafayette St.	White Plains, N. Y.	Bellevue Place.
211 N. Capitol St.	Grand Rapids, Mich.	Columbus, O.	Salt Lake City, Utah.
Atlanta, Ga.	Kansas City, Mo.	Portland, Ore.	Richmond, Va.
Dwight, Ill.	St. Louis, Mo.	Harrisburg, Pa.	Seattle, Wash.
Charlestown, Ind.	Boulder Hot Springs,	Philadelphia, Pa.,	Waukesha, Wis.
Marion, Ind.	Boulder, Mont.	812 N. Broad St.	Toronto, Ont.
Des Moines, Ia.	Carson City, Nev.	Winnipeg, Man.	

"Non-Heredity, of Intemperance" by Dr. Leslie E. Keeley, mailed on application.



LESLIE E. KEELEY, M.D., LL.D.

**WHAT THE
RT. REV. JOHN SHANLEY
BISHOP OF NORTH DAKOTA, Says:**

It is because I know it does save them, because I know it is God's truth that I take the deepest interest in the Keeley Cure, and so long as I live I shall raise my voice in advocating its efficacy.

**Rt. Rev. JOHN SHANLEY,
Bishop of North Dakota.**

Details of treatment and proofs of its success sent free on application to any of the institutes named.

Please accept my thanks for the many articles you have sent me as premiums for getting subscribers for RECREATION; namely, a repeating rifle, a take down shot gun, a Harrington & Richardson revolver, a Marble pocket axe, and, last but not least, a No. 16 Bristol steel rod.

During a week's stay at Burt Lindsley's camp on Black river, where I had an excellent opportunity to test the rod and found it entirely satisfactorily, I succeeded in landing every trout hooked, several of which weighed 16 ounces each. I have had no chance to try the rifle on large game, but have tested it at target and can put 90 per cent of the bullets inside a 12 inch circle at 300 yards.

A. S. Seaman, Frankfort, N. Y.

FREE To each person sending me \$1. (P.O. Money order) for one year's subscription to RECREATION, I will send his choice of the following.

A Genuine Briar Pipe with Genuine Amber Bit, or a Braided Leather Dog Whip with snap on end, or a Polished Steel Dog Chain with swivels, snaps, etc., or a MacMillan Shell Extractor for any size of shell from 8 gauge to 22 caliber, or a Pocket Compass, 1 in. dial open face, watch shape, with ring handle, bevel crystal.

EDWARD S. ADAMS, Box 536, Manchester, N. H.

Quails are plentiful here this year, but ducks are scarce as yet.

J. W. Ashworth, Glensondale, Mass.

Magnetic Body Shields.

Not Electric.

Brevity here saves money. If we can state the truth forcibly enough to get you to write to us, it is all we ask. We want you to have a book of the most convincing testimonials ever collected from grateful patrons. They are from thousands of the world's best men and women who have worn under their clothing Dr. Thacher's Magnetic Vibration Batteries, the wonderful curative power of which depends on two well-known facts of science: First—Every drop of blood contains numberless atoms of iron. Second—Magnetic vibration affects iron in every form and through every medium.

The enormous number of 300,000 of the following have already been sold: Magnetic Leggings, to cure varicose veins, rheumatism, cramps, weak and swollen joints, ulcers, etc.; Magnetic Throat Shields and Lung Shields, to cure every form of throat and lung trouble, including tuberculosis; Abdominal Shields, to cure indigestion, kidney and bladder complaints, woman's ills, excessive fat, etc.; Magnetic Foot Batteries, worn as insoles in any shoe for cold feet, poor circulation and rheumatic pains; Magnetic Shoulder Caps and Wristlets, to cure rheumatism and weak and trembling wrists; Combination Shields, to cure paralysis and for nearly all chronic diseases. Dr. Thacher will give personal attention to all describing their case.

THE THACHER MAGNETIC SHIELD CO., Ltd.,
102 State and Adams Sts., Chicago, Ill.

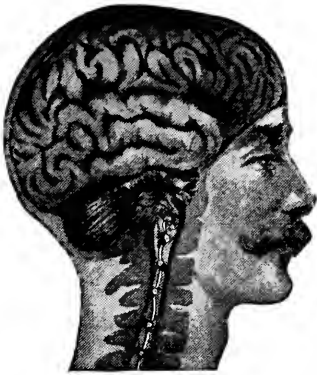

MIND-BRAIN

Mentality, in all its perfection and strength, is only possible when the brain as well as the other nerve-centers and vital organs is endowed with a vigorous circulation. Stagnation of blood, Varicocele, is responsible for more cases coming under the head of either weakened, obscured, or defective mentality, than all the other diseases that afflict and prematurely destroy mankind.

I have made an original and exhaustive study of mental diseases, nerve derangements and circulatory disturbances, and have limited my practice to the successful treatment of Varicocele and its associated or reflex diseases. I have found that the blood is practically the life of the mind as well as of the body.

I can not, in this short announcement, explain my theories—they have long since become demonstrated facts—but I will send to anyone afflicted with Varicocele my treatise on Special Diseases, which is both theoretical and practical. The sealed postage on this book is ten cents. If a description of symptoms is given I will write my professional opinion regarding the case, telling you whether it is necessary for you to come to my Home for treatment.

Men from all parts of the world are being treated at my sanitarium. I prefer giving personal attention to every patient, but if it is impossible for you to visit me at once, your letter will have my careful answer if addressed to



DELMER D. RICHARDSON, M. D.

Suite 103, 119 Michigan Avenue, Chicago.

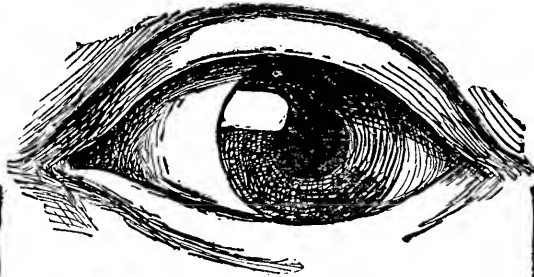

THE HYPNOTIC EYE

You have it, everyone has it for everyone is born a hypnotist. Would you like to develop your hypnotic powers and wield an influence over others? Would you like to sway the minds of men, make friends and achieve success? You can develop this power in the privacy of your room.

COSTS YOU NOTHING

It will cost you nothing to send for our free book and learn how to do it. Anybody can learn. The acquisition of this power brings happiness and health, develops the will; gratifies ambition; gives one the key to personal and social success and suggests many opportunities to make money. By our new system you can learn **THE PHILOSOPHY OF PERSONAL INFLUENCE** in a few days at your home, and not only achieve success yourself, but you can influence the minds, health and actions of others. We guarantee it.

LEARN AT HOME FREE

If at all interested, send for our free book, "The Philosophy of Personal Influence." It will reveal to you the secrets of success and will point out the causes of failure. Through the generosity of X. La Motte Sage, A.M., L.L.D., Ph.D., its author, we are permitted to distribute 10,000 copies absolutely free of all cost. A postal card will bring it. Address the New York Institute of Science, Department DM 6 Rochester, N. Y.

Free: For 1 year's subscription of RECREATION, through me, will give 1 Bromide enlargement, any size up to 11x14 inches inclusive, from any negative not larger than 4x5; or from photographs. Negatives and Photos to be returned to the owner. Here is a rare chance to get a large Photo from your pet Negative, also RECREATION for \$1. A. F. Evarts, Meriden, Conn.

50c. **SUPERFLUOUS HAIR REMOVED**
I guarantee that a few drops of my liquid will remove hair instantaneously, effectively, and without the slightest harm, pain, burn or blister. Sent upon receipt of fifty cents with full instructions. **Mme. MARIE LEON,**
905 E St. James Bldg., 1133 Broadway, New York

Free Rupture Cure

If ruptured write to Dr. W. S. Rice, 1546 Main St., Adams, N. Y., and he will send free a trial of his wonderful method. Whether skeptical or not get this free method and try the remarkable invention that cures without pain, danger, operation or detention from work. Write to-day. Don't wait.

FREE BOOK, WEAK MEN



My illustrated nature book on losses varicocele, impotency, lame back, free sealed, by mail. Much valuable advice and describes the new DR. SANDEN HERCULEX ELECTRIC BELT. Worn nights. No drugs. Currents soothing. Used by women also for rheumatic pains, etc. 5,000 cures 1901. Established 30 years. Advice free.

DR. G. B. SANDEN,
1155 Broadway, N. Y.

Guarantees to Cure Rupture.

A Syracuse Genius Has Discovered A
Marvelous Home Cure that Quickly
Heals Rupture and He Posi-
tively Guarantees This
Wonderful Result.

NO CURE—NO PAY IS HIS MOTTO.

Has Many Remarkable Testimonials From Those
Who Were Cured, Showing Unquestionably
That His Invention is Destined to
Completely Revolutionize the
Treatment of Rupture.

There has been invented, by a Syracuse genius,
a new and simple electrical appliance, which has
been trade-marked "Electrus." He sends it to
ruptured people with an absolute guarantee to cure



**JUDGE BARTOLETTE, of Kentucky, Cured of
Double Rupture After Suffering Over
20 Years.**

or no pay. This certainly marks a new era in
treating rupture and puts to flight a horde of truss
vendors, quacks, specialists and dangerous opera-
tions.

It combines not only the features of perfect
retention, but it sends into the ruptural opening
a steady current of electricity that thoroughly
enlivens the muscular tissue, and there is an al-
most instantaneous activity of nutrition and circula-
tion that heals up the ruptural opening quickly
and permanently. It is having a most remarkable
success in curing rupture. Old men, ruptured
for years and years, have been cured in a sur-
prisingly short time so they can walk or work and
exercise their muscles without fear of the rupture
breaking out afresh.

Send your name and address to The Electrus
Co., 577 Wood Building, Syracuse, N. Y., and
they will forward free the complete detail of this
wonderful cure for rupture. Keep abreast of the
times and learn what marvelous progress is shown
in this wonderful invention.



Club Cocktails

Famous the world
over for purity.
They never vary.
The secret of their
perfect blend is that
they are kept six
months before being
drawn off and bot-
tled. Be sure you
have them in your
camp, on the yacht,
and on your outing
trips wherever you
go. They are ready and require no
mixing. Simply pour over cracked ice.

For Sale by all Fancy Grocers and Dealers

G. F. HEUBLEIN & BRO.
29 BROADWAY, N. Y. HARTFORD, CONN.

A Missouri farmer, whose hog had been
killed by a train, and who imagined himself
to be something of a poet, wrote these lines
to the company's claim agent for settle-
ment:

My razorback strolled down your track
A week ago to-day;
Your 29 came down the line
And snuffed his light away.

You can't blame me—the hog, you see,
Slipped through a cattle gate;
So kindly pen a check for ten,
The debt to liquidate.

He was rather surprised a few days later
to receive the following:

Old 29 came down the line
And killed your hog, we know;
But razorbacks on railroad tracks
Quite often meet with woe.

Therefore, my friend, we cannot send
The check for which you pine.
Just plant the dead; place o'er his head
"Here lies a foolish swine."
—Milwaukee Evening Wisconsin.

IN ANSWERING ADS PLEASE
MENTION RECREATION.

SOME RARE OPPORTUNITIES

These goods are all new, and will be shipped direct from factory. Prices named are those at which manufacturers and dealers usually sell. Here is a good chance to get

A Book, a Gun, a Camera
A Sleeping Bag, a Fishing Rod
A Reel, a Tent, } **FREE OF COST**

Subscriptions need not all be sent at once. They may be sent in installments as taken and credit will be given on account. When the required number is obtained the premium earned will be shipped.

These Offers are subject to change without notice.

TO ANY PERSON SENDING ME

TWO yearly subscriptions to RECREATION at \$1 each, I will send a copy of *Hunting in the Great West*, cloth; or a Zar Camera, listed at \$1; or an Ingersoll Watch or Cyclometer, listed at \$1; or a Recreation Waterproof Match Box, made by W. L. Marble and listed at \$1; or a Shakespeare Revolution Bait listed at 75 cents; or a Laughlin Fountain Pen; or a dozen Trout Flies, assorted, listed at \$1; or a pair of Attachable Eyeglass Temples, gold-plated, made by Gall & Lembke.

THREE subscriptions at \$1 each, a safety pocket ax, made by W. L. Marble and listed at \$2.50; or a dozen Bass Flies, assorted, listed at \$2; or 4 dozen Carbutt plates, 4x5 or 5x7; or a pair of chrome tanned horsehide hunting and driving gloves, listed at \$1.50, made by J. P. Luther Glove Co.

FOUR subscriptions at \$1 each, an Ideal Hunting Knife, made by W. L. Marble and listed at \$2.50; or a .32 caliber Automatic Forehand Revolver, made by the Hopkins & Allen Arms Co.; or a No. 822 Rifle made by the Hopkins & Allen Arms Co., listed at \$4.50.

FIVE subscriptions at \$1 each, a copy of *Cruisings in the Cascades*, cloth; or a set of Nehring's Convertible Ampliscopes, listed at \$5.00; or an Ideal Hunting Knife made by W. L. Marble, and listed at \$3; or a polished Buffalo Horn Gun Rack, made by E. W. Stiles; or a Forehand Gun, made by the Hopkins & Allen Arms Co., listed at \$6; or a pair of lock lever skates, made by Barney & Berry, listed at \$4.50; or a pair of gauntlets, for hunting and driving, ladies' size, listed at \$2.50, made by J. P. Luther Glove Co., or a J C Hand trap made by the Mitchell Mfg. Co., listed at \$4.

SIX subscriptions at \$1 each, a Ila keye Refrigerating Basket made by the Burlington Basket Co., or one dozen Eureka golf balls listed at \$4; or a Century Camera, model 10, 4x5, listed at \$9; or a Forehand Gun made by the Hopkins & Allen Arms Co., listed at \$9.

SEVEN subscriptions at \$1 each, a copy of *The Big Game of North America*, or of *The American Book of the Dog*, cloth, or one set Lakewood golf clubs, 5 in number, listing at \$5; or a series IIB or IID Korona Camera, made by the Gundlach Optical Co., listed at \$10.

EIGHT subscriptions at \$1 each, a 4x5 Weno Hawk-Eye Camera, made by the Blair Camera Co., and listed at \$8.

NINE subscriptions at \$1 each, an Acme single shot gun, made by the Davenport Arms Co., and listed at \$8.

TEN subscriptions at \$1 each, a Cut-Glass Salad Bowl, made by Higgins & Seiter, and listed at \$4.50; or a Yawman & Erbe Automatic Reel, listed at \$6 to \$9; or a Bristol Steel Fishing Rod, listed at \$6, or less; or a Waterproof Wall Tent 7x7, made by Abercrombie & Fitch, and listed at \$8; or a canvas hunting coat, made by H. J. Upthegrove & Son, listed at \$8; or a series I, 4x5, Korona Camera, made by the Gundlach Optical Co., listed at \$12.

TWELVE subscriptions at \$1 each, a Peabody Carbine valued at \$12; or a No. 5 Side Telescope Rifle Sight, listed at \$18; or a Davenport Ejector Gun, listed at \$10; or a Century Camera, model 12, 4x5, listed at \$18.

FIFTEEN subscriptions at \$1 each, a Shakespeare Reel, Silver Plated, listed at \$15; or a set of rabbit plates made by Higgins & Seiter, and listed at \$8, or a pair of horsehide Hunting shoes, made by T. H. Guthrie, Newark, N. J., and listed at \$8, or a Field Glass made by Gall & Lembke; or a Kenwood Sleeping Bag, complete, with canvas cover, listed at \$16.

TWENTY subscriptions at \$1 each, a 14-karat Gold Hunting-case Watch, with Waltham Movement, listed at \$20; or a Repeating Rifle, listed at \$16 or less; or an Elita single shot gun, made by the Davenport Arms Co., and listed at \$18, or a pair of horsehide Hunting Boots, made by T. H. Guthrie, Newark, N. J., and listed at \$10; or an Acme Folding Canvas Boat, No. 1, Grade B, listed at \$20; or a Mullins Duck Boat, listed at \$20.

TWENTY-FIVE subscriptions at \$1 each, an 11-foot King Folding Canvas Boat, listed at \$38; or a Repeating Rifle, listed at \$20 or less; or a 4x5 Planatic lens, made by the Rochester Lens Co., and listed at \$25; or a Century Grand Camera, 4x5, listed at \$35; or a Syracuse Grade O, double hammerless Gun, made by the Syracuse Arms Co., and listed at \$30.

THIRTY subscriptions at \$1 each, a Repeating Rifle, listed at \$25 or less; or a Waterproof Tent, 14½ x 17, made by Abercrombie & Fitch, and listed at \$25; or a corduroy hunting suit, made by H. J. Upthegrove & Son, including coat, vest, trousers, and hat, listed at \$23.75; or an Ithaca, quality No. 1, plain, double barrel, hammerless breech loading shot gun, listed at \$40.

THIRTY-FIVE subscriptions at \$1 each, a 14-foot King Folding Canvas boat, listed at \$48.

FORTY subscriptions at \$1 each, a Savage .303 Repeating Rifle; or a No. 10 Gun Cabinet, made by the West End Furniture Co., and listed at \$32; or a Field Glass, made by C. P. Goerz.

FORTY-FIVE subscriptions at \$1 each, a Royal Anastigmat Lens, 4x5, series I, made by Rochester Lens Co., and listed at \$45.

FIFTY subscriptions at \$1 each, a No. 20 Gun Cabinet, made by the West End Furniture Co., and listed at \$38.

TWO HUNDRED subscriptions at \$1 each, a strictly first class upright piano, listed at \$750.

Address, **Recreation 23 West 24th St. New York**



John Dewar & Sons, Limited

PERTH, SCOTLAND
LONDON, ENGLAND



Scotch Whisky Distillers

*By Royal Warrant to His Majesty
King Edward VII. and the Royal
Family.*

FREDERICK GLASSUP
*Sole Agent for the U. S.
New York*

My friend Thompson and I arrived at DeBeque, Colo., October 22. The next day we set out with our guide for the hunting grounds, reaching them the 24th. We camped in an old log cabin from which we made little excursions each day in quest of deer, grouse and sage hens. Bear, lions and wildcats are plentiful within one day's drive from DeBeque. Our guide, F. R. Rehmenklau, of DeBeque, was always ready and willing to do all he could to make our stay enjoyable. He has 3 of the best dogs for bear and mountain lions I ever saw. I have been a reader of RECREATION some time and admire its attitude toward game hogs. It ought to be read in Colorado a little more. I was told while there that one man sold 600 deer skins last year. Dr. G. T. Cress, Sac City, Ia.

Lea—I wonder if Professor Kidder meant anything by it?

Perrins—By what?

Lea—He advertised to lecture on "Fools," and when I bought a ticket it was marked "Admit One."—Puck.

We have a few rabbits, squirrels, coons, prairie chickens, quails and ducks. Our game is fast disappearing and unless given better protection, will not outlive this decade.

Wesley Eiseman, Freeport, Ill.

HIGGINS & SEITER

**THE
NEXT BEST THING
TO VISITING**

The largest and most celebrated Glass and China Store in the World—the Great Present Store of the Metropolis—is to look through our expensively illustrated Catalogue, sent freely, on request—a veritable missionary of Ceramic Art.

ALSO, to all except the merely curious, the beautiful brochure,
"Serving a Dinner"
by the famous expert, Oscar, of the Waldorf-Astoria.

Write for Catalogue—No. 13 U.
West 21st and West 22d St.
(near 6th Ave.) NEW YORK.

"BUY CHINA & GLASS RIGHT"

How to Paint Your House Cheap

And Have it Guaranteed to Look Better, Wear Longer,
and Cost Less than the Best White Lead Paints.

**Never Fades, Cracks, Chalks,
Peels or Blisters and is Not
Affected by Gases.**

The cost of painting the house and barn, outbuildings and fences is a heavy burden. Cheap paints soon fade, peel or scrape off and white lead and oil costs so much and has to be replaced so often that it is a constant expense to keep the bright, clean appearance so desirable in the cozy cottage home or the elegant mansion. The following are a few of the large users of Carrara Paint:

Pennsylvania R. R. Co.; Pullman Palace Car Co.; Chicago Telephone Co.; Central Union Telephone Co.; Field Museum, Chicago; Kenwood Club, Chicago; Cincinnati Southern; C. & E. I. R. R. Co.; Denver & Rio Grande R. R.; Wellington Hotel, Chicago.

Carrara is used because it lasts longer, never fades, never cracks,



The Waldorf-Astoria, New York, one of the Most Magnificent Hotels in the World, Has Used Tons and Tons of the World Famous Carrara Paint.

Fifty Sample Colors and Illustrated Booklet Prepaid to Any Address Absolutely Free.

never blisters, never peels, covers more surface than the highest priced paints and costs less than the cheap mixed paints that injure instead of protect. There is but one Carrara. It is made by the Carrara Paint Agency, General Offices, 675 Carrara Bldg., Cincinnati, Ohio, and anyone having a house to paint should send for 50 free sample colors and our handsome booklet, showing many buildings reproduced in all the colors just as they are painted from this great paint that has stood the most rigid tests for 25 years, and, bear in mind, that it is the only paint ever manufactured that is backed by a positive guarantee in every case. Distributing depots in all principal cities. Write to-day and save half your paint bills in the future.

PAROID ROOFING

"IT LASTS"

Before you build your camp, barns, sheds, get a sample and the story of Paroid Roofing—the permanent ready roofing—each roll a complete roofing kit.

F. W. BIRD & SON

Mills and Main Office

East Walpole, Mass., U.S.A.

New York Chicago

\$26⁵⁰



**BUYS
A
BUGGY**

With top \$33.50

SAVE DEALERS PROFITS

The immense volume of our business and the vast number of satisfied customers on our books prove we can serve your interests best.

We manufacture a full line of Buggies, Carriages, Wagons and Harness of very superior

**Quality—Style—
Durability and Finish**

These four essentials are to be found in every vehicle and set of harness sent out by us. We employ only skilled mechanics in all departments and furnish them with the very best materials. This fact together with our plan, which unites the interests of the consumer and the manufacturer, enable us to give you the greatest value for your money.

With the entire output of two enormous modern factories and superb shipping facilities at our disposal, we are able to furnish high-grade vehicles at prices that—quality considered

Positively Defy Competition.

All goods guaranteed and shipped on approval. Money back if you are not satisfied.

Write at once for our catalogue and special inducement, it will interest you.

**UNION BUGGY COMPANY,
1495 Saginaw Street, Pontiac, Mich.**

Watch Accidents

will happen! That's why your watch works should be protected by a strong case. Gold alone is soft and bends easily. It's used for show only. The JAS. BOSS STIFFENED GOLD WATCH CASE resists jar and jolt. Keeps out the dust. Reduces the expense of repair. Adds many years to the life of your watch. Every JAS. BOSS CASE is guaranteed for **25 years** by a Keystone Trade-mark stamped inside. You must look for this trade-mark. Consult the jeweler. Write us for booklet.



The **KEYSTONE WATCH CASE COMPANY**, Philadelphia.

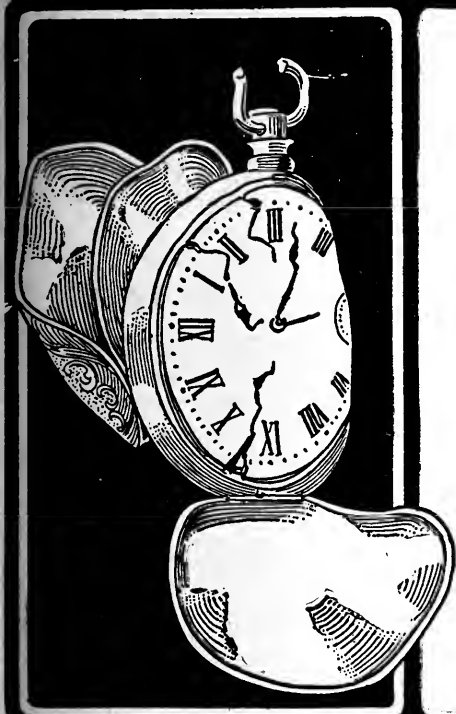

ACCIDENTS WILL HAPPEN

I have handled a Winchester ever since I could hold one; have always been careful and never had an accident until last summer.

H. Brown and I left Lowden's early one morning with the intention of killing a deer or 2. As we expected to travel some distance before beginning the hunt, we took saddle horses. I rode my favorite mare, and my companion one of the horses belonging to the ranch. At 6 o'clock we left our horses tied and started up the mountain. Deer sign was plentiful, but as the animals were in thick brush it was some time before we got a shot.

About noon, as we were coming up a long ridge, Brown, who was on the opposite side, jumped 2 large bucks. They crossed the ridge in my direction. So thick was the brush that I did not see either until one winded me and turned back on a run. I fired at him breaking his back. The other buck kept under cover and ran 300 yards before I could get a shot. I then fired twice, wounding him. Crossing the ridge and telling Brown to get the horses, I went back and dressed the deer I had killed. When my companion arrived with the horses we lashed the deer on his

horse and, riding my mare, he started homeward. Not knowing the country I directed him to keep the main ridge down to the ranch, and told him I would follow the trail of the wounded buck around the side of the hill. I followed his track $\frac{1}{2}$ mile and found him in dense cover. It was a running shot, and being hot and breathless, I missed him.

At the crack of the gun Brown yelled, "Look out where you are shooting! You have shot your horse!" I went to him and found that the ball, which was a 30 caliber, steel jacketed bullet, had ploughed through 60 yards of live oak brush and struck my mare just forward of the flank.

The ball had not gone through, but, being badly battered, had made a large hole from which the blood was pouring. As there was no chance to get her out of such a rough country, I told Brown to kill her.

Instead of following the ridge Brown had turned down the hill. That brought him in front of me, while I thought he was to my left and above. He had the mare by the bit steadying her down a rough place when the ball struck her.

I have regretted that shot many a time, but am thankful the man was not killed.

T. S. L., Lowden's Ranch, Cal.

Music Boxes

For the Home, it is company at all times, will cheer you when you are sad; a veritable need when you are lonely; an accompaniment to your song, and play **Dance** music in **perfect time**. A boon to all music lovers. Our variety is great; prices to suit all. Our No. 20 costs only \$2.50, while our No. 191 runs in the hundreds. Complete Catalogues FREE.

E. L. CUENDET, 7 Barclay St., New York



The Celebrated
THOMPSON-QUIMBY
 Hunting Boots, Shoes and Moccasins



All Work Guaranteed

T. H. CUTHRIE
 33 William Street, NEWARK, N. J.

THOMPSON

I have on file measurements of all who bought Boots and Shoes of the W. Fred Quimby Co., of New York for the past 20 years, and I make the same grade of sportsmen's footwear as they made. I was superintendent of the shoe department of that firm and bought the right to make these boots and shoes. Get a pair NOW. They will last years and are the cheapest in the end. I refer by permission to the Editor of RECREATION. Measurement blanks and prices on application. Mention RECREATION.

Here is Another!
 If you will send me
40 Yearly Subscriptions
 to
RECREATION
 I will send you
A No. 10 Goerz Trieder-Binocular Field Glass
 Listed at \$38.00

Every well-informed man knows the great power of this modern prismatic field glass. It is indispensable to every hunter, and is one of the latest and best on the market.

I have but a few of these instruments on hand and the offer will be withdrawn as soon as the supply is exhausted. Therefore, if you want one

START IMMEDIATELY.

Sample copies of RECREATION for use in canvassing furnished on application.

Wanted for Cash: Antlers of elk, moose, and caribou. Address, Caribou, Hoboken, N. J.

The Wizard B camera has arrived O. K. Many thanks for same.
 R. D. Harris, Fulsherr, Tex.

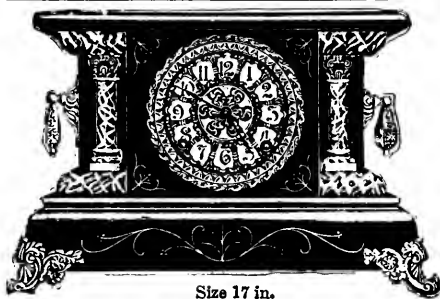

Size 17 in.

A skilled mechanic has invented lately a **Musical Clock** which, besides keeping perfect time, running 8 days with one winding, striking the hours and halves, will also **play favorite airs every half hour.** As the cost is very low, many prefer buying the clock with the musical attachment. Ask your jeweler for it or send to **E. L. CUENDET, Mfr., 7 Barclay Street, New York**

The Reason the LUTHER HAND-MADE GLOVE will not rip



Machine sewing cuts itself



Hand sewing cannot.



A Practical Hunting and Driving Glove

Made for practical, comfortable, durability. No Oil. No Odor. No Animal Glue. Practically seamless. Cannot Rip. Unaffected by moisture of any kind. If soiled, may be washed with soap and hot water, without injury. The Luther Fastener is adjustable, fits any wrist and cannot get out of order. Illustrated booklet, samples and self measurement rule on application.

If you prefer to buy through your dealer send us his name

No. 308 Driving Glove postpaid anywhere **\$1.50**, made to measure **\$2.50**,
No. 320 Gauntlet, " " " " **3**

J. P. LUTHER GLOVE CO., 536 Pearl St., Berlin, Wis.

As the mother rocks the cradle, love transforms it to a kind of loom whereon her fond fancy weaves a bright-colored future for her child. As the child grows the wise mother feeds his mind with precepts of integrity and industry; his brain and body with all-nourishing food in order that he may be strong for life's battle and find an honored place with men.

SHREDDED WHEAT BISCUIT

is the Natural Food—the food whose each integral part has an exact counterpart in the human body—the food that builds the perfect whole because it builds the perfect parts. The perfect food to *perfect man*. **SHREDDED**

WHEAT BISCUIT is more porous than any other food—that means more digestible. It is quickly transformed into rich blood, firm flesh, hardy muscles and an active brain. **Sold by all grocers.**

Send for "The Vital Question" (Cook Book, illustrated in colors) **FREE**. Address

THE NATURAL FOOD CO., NIAGARA FALLS, N. Y.



LOOK AT THIS!!! If you send your subscription to RECREATION through me or direct to the office to be placed to my credit, I will send you free of charge any one of the articles mentioned below:

Shot gun bench crimper, sells for 75 c., in 10-12-16-20 gauge.

Shot gun cleaning rod, 3 attachments, sells for 50c., in 10-12-16 gauge.

Micrometer powder and shot measure, adjustable, and for both black and smokeless powder; sells for 65c.

U. S. Government rifle cleaner, any caliber, with attachments, sells for 60c., packed in neat canvas bag.

A duck, or snipe, or turkey call, sells for 75c. each, best made.

Address Henry B. Floyd, 1365 Emerson St., N. E., Washington, D. C.

I am a regular reader of RECREATION, buying it each month from my newsdealer. I am pleased with the way you handle the game hogs; it is surely producing results.

I have been amused and disgusted by the appeals for support from an alleged sporting magazine that says: "We do not know what a game hog is. Send in your photos and we will publish them," or words to that effect. On inquiry I find that the newsdealers here have calls for 10 to 25 copies of RECREATION each month and not one call for the other magazine.

Dr. A. M. Kenney, Roxbury, Mass.

**P
U
R
E
M
A
P
L
E**

SUGAR 15 cts. a lb.
in pails or bricks

SYRUP \$1.25 a gal.
in Gallon Cans

Freight prepaid on order for 100 lbs. or more, East of Rocky Mountains. We guarantee safe arrival and quality. Price list on large or small orders on application.

Reference, Randolph National Bank.

**Vermont Maple Sugar
Makers' Market
RANDOLPH, VERMONT.**

Paris Exposition, 1900: Gold Medal and Highest Award.

THEY FIGHT FOR SPRATT'S



Spratts Patent Dog Cakes
Are the BEST and CHEAPEST.
Spratts Patent Dog Cakes
Will keep a dog in show form and working condition.
Spratts Patent Dog Cakes
Are fed exclusively at the leading dog shows of Canada, America, Great Britain, France, Germany, etc.
Spratts Patent Dog Cakes
Are used by the leading kennel owners and breeders throughout the world.
Spratts Patent Dog Cakes
Are sold by leading grocers, sporting goods dealers, druggists, etc.

Price in Cartons, 25c. and 40c.
In Bags, \$1.75, \$3.25 and \$6.50.

Write for our Catalogue "Dog Culture," with practical chapters on the feeding, kenneling and management of dogs, post free.

We also manufacture specially prepared food for dogs, puppies, rabbits, cats, poultry, game, pigeons, fish, birds, etc.

Spratts Patent (America) Limited

450 Market St., Newark, N. J. 714 S. 4th St., St. Louis, Mo.
1324 Valencia St., San Francisco, Cal.

Sold by Grocers, Seedsmen, Hardware and Bird Stores, Etc., Etc.

Squab Book Free



Squabs are raised in 1 month, bring big prices. Eager market. Astonishing profits. Easy for women and invalids. Use your spare time profitably. Small space and capital. Here is something worth looking into. Facts given in our FREE BOOK, "How to make money with Squabs." PLYMOUTH ROCK SQUAB CO., 11 Friend St., Boston, Mass.

Make Money Breeding Pheasants, Quail and Squabs.

We Start You. Send stamp for booklet telling you how to succeed. We buy all you raise.

For sale, all kinds of Pheasants, Poultry. Ducks, Geese, Wood and Mandarin Ducks, Gold Fish Globes, etc. We want agents to sell our Gold Fish, etc.

March Flyers—Imported Angora Cats, Male or Females, \$5.00 each. Good Ruff, Tail and Coat.

Hub Poultry and Supply Co.,

Station A No. 5. Boston, Mass.

ESTABLISHED 1895.

Genesee Valley Poultry Yards, AVON, N. Y.

S. C. White Leghorns—Large, White, Hardy, Great Layers. The 20th Century "Business Fowl," Mammoth Pekin Ducks, Prize-Winning Barred Rocks, Buff Wyandottes, Stock and Eggs. Remember next Spring. OUR eggs hatch. Write wants, we'll treat you right.



POULTRY PAPER, illust'd, 20 pages, 25 cents per year. 4 months' trial 10 cents. Sample free. 64-page practical poultry book free to yearly subscribers. Book alone 10 cents. Catalogue of poultry books free. Poultry Advocate, Syracuse, N. Y.

AT DOCTORS H. R. PHILLIPS & WREAN'S RABBITRY, Penn Yan, N. Y., we breed for FOUNDATION STOCK



only, from the best strain of PEDIGREED STOCK-DOES, 6 to 10 months old, bred to IMPORTED BUCKS, for \$3 each. Fine color and strictly O.K. We guarantee all stock as recommended. We have a fine line of BLACK PEDIGREED BELGIANS.

Mention RECREATION.

DRS. H. R. PHILLIPS & WREAN.

Taxidermist's Materials

Glass Eyes for Stuffed Birds and Animals. Oölogist's and Entomologist's Supplies

Send 5c. in stamps for Catalogue

FRED. KAEMPFER

88 State Street, Chicago, Ill.

Taxidermy work done in all its branches

FLORIDA BIRDS.

I have on hand a fair assortment of our Native Bird Skins, suitable for schools, museums or private collections.

During the season of 1903 I will collect any birds or mammals to order.

Finest mounted work a specialty.

R. D. HOYT, Taxidermist,
SEVEN OAKS, FLA.



Hunter-Trapper-Trapper

Published monthly by an experienced hunter, trader and trapper—tells about hunting, trapping and raw furs. Contains 64 pages each month.

Sample copy, 10 cents, silver.

Address Hunter-Trapper-Trapper
Box 30, GALLIPOLIS, OHIO

FINE MOUNTED GAME HEADS, BIRDS, ETC., for sale at unheard-of prices.

Send 10 cents for photos.

JOHN CLAYTON, Taxidermist, Lincoln, Maine.

To RECREATION Readers: I am organizing a club of subscribers for RECREATION, with a view to securing a premium, and I submit this offer; to each person sending me \$1 for yearly subscription to RECREATION, I will send a 25ct. Dominion of Canada bank note. There are but a few of these in in circulation and I have succeeded in collecting a number of them. These are interesting souvenirs and are especially valuable to persons who are making collections of coins or other curios. Walter Legare, 518 John St., Quebec, Can.

Cavies or Guinea Pigs.

Peruvian, Abyssinian or English Long or Short Haired. All colors. 400 to select from.

T. RACKHAM, East Orange, N. J.

Do You Sleep Well?



"Yes," said Mrs. Strenuous, "a change of climate for one's insomnia is not only expensive, but often very inconvenient. I tried a change of mattress instead, substituting the **Ostermoor Patent Elastic Felt Mattress** for my hair mattress. Am delighted! although I was taught to believe a good *hair* mattress could not be excelled."

The Ostermoor Patent Elastic Felt Mattress **\$15.**

We would like to send you our book "The Test of Time." It has 72 pages of text and handsome illustrations, all describing the Ostermoor mattress and its ancient rival, the hair mattress. A postal card will bring it. Perhaps you do not want to buy a mattress. You spend *one third of your life* in bed and you *should* be interested in knowing what you sleep on. We can convince you that hundreds of *well-known* persons find that "The Ostermoor" fulfills every demand of economy, comfort and sanitary precaution.

Send for Free Book, "The Test of Time."

The Ostermoor Mattress is not for sale at any store—no one sells it but us. Our name and guarantee on every genuine mattress.

Thirty Nights' Free Trial.

Sleep on it 30 nights, and if it is not even all you have *hoped for*, if you don't believe it to be the equal in cleanliness, durability and comfort of any \$50 hair mattress ever made, you can get your money back by return mail—"no questions asked." There will be no unpleasantness about it at all.

2 feet 6 inches wide, 25 lbs.,	\$ 8.35
3 feet wide, 30 lbs.,	10.00
3 feet 6 inches wide, 35 lbs.,	11.70
4 feet wide, 40 lbs.,	13.35
4 feet 6 inches wide, 45 lbs.,	15.00

All 6 feet 3 inches long. In two parts 50c. extra. Special sizes at special prices.

Express Charges Prepaid to Any Point

OSTERMOOR & COMPANY, 114 Elizabeth St., New York

We have cushioned 25,000 churches.

Send for free book "Church Cushions."

CANADIAN ADDRESS: 301 St. James St., Montreal.



Small Profits—Quick Sales

**TROUT
FLIES**

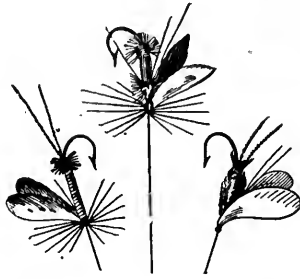

for trial—send us

- 15c for an assorted sample doz. Regular price, 24 cents. **Quality A Flies**
- 30c for an assorted sample doz. Regular price, 60 cents. **Quality B Flies**
- 60c for an assorted sample doz. Regular price, 84 cents. **Quality C Flies**
- 60c for an assorted dozen Regular price 84 cents. **Bass Flies**

SPLIT BAMBOO RODS

Fly Rods 10 feet, 6 ounces **57 cents** Bait Rods 9 feet, 8 ounces
With cork grip and extra tip, in wood form

Try our new Braided Silk Enamelled Waterproof

METAL CENTER LINE

Size No. 5, 4½ cents per yard. Size No. 4, 5½ cents per yard.
Put up in 10-yard lengths connected.

THE H. H. KIFFE CO.
523 Broadway, New York City

Catalogs of any of above goods free on application.
Mention RECREATION.



Banner
(TRADE MARK)
Brand
Rubber
Coat

Pattern 28 Weight 4¾ lbs.
Absolutely Waterproof
A Gentleman's Rain Coat

"Can you furnish a GOOD Rubber Coat, not too heavy and yet strong and serviceable, which I can use in my practice as well as on fishing trips; and that will KEEP ME DRY?"
F. A. KNIGHTS, M.D., Minneapolis.

This order we filled with a "BANNER" RUBBER COAT, Pattern 28, and 6 months later the Doctor said: "It is just what I want and is the only coat I ever found that would REALLY SHED RAIN."

Sent express paid anywhere in United States on receipt of \$5.00. Sizes, 36 to 46 inches Length, 54 inches.

Give chest measure over ordinary coat.

Mackintoshes and Rain Coats made to order
All best quality Rubber Goods

Write for List No. 20

NORTHERN RUBBER CO.
P 3314 So. Ninth Avenue
Minneapolis, Minn.

**TALES OF
ADVENTURE.**

Rare Hunting and Fishing Stories.

I have a few sets of Volume 3 of RECREATION, July to December, inclusive, 1895. These are handsomely bound in cloth, with leather backs and corners.

Here are the titles of a few of the choice stories in the book.

- Woodcock on the Islands.**
Illustrated. F. W. G. Johnson
- The Gordon Setter.**
Illustrated. Dr. J. Whitaker
- Salmon Fishing in Labrador.**
Illustrated. Col. Charles E. Fuller
- Coursing with the Greyhound**
Illustrated. L. F. Bartels
- A Bald-Faced Grizzly in Camp.**
Illustrated. M. W. Miner
- Where Leaps the Ouananiche.**
(Poem.) Dr. E. L. Tiffany
- Fly Fishing** Dr. M. G. Ellzey
- A Half Hour With the Quail.**
Dr. E. P. Kremer (Juvenis)
- A Deer Drive with Spokane Indians.**
Illustrated. Lieut. W. R. Abercrombie
- An Indian Horse Race.**
Maj. F. M. Bernard
- The Old Kentucky Rifle.** (Poem.)
Illustrated. Capt. J. W. Crawford
- A Mystery of the Tetons.**
Illustrated. Ed. H. Trafton
- Pheasant Shooting.**
Illustrated. Thomas G. Farrell
- Sitting Bull's Last Medicine.**
Illustrated. Margaret Gray Brooks
- Crossing the Plains 30 Years Ago.**
Illustrated. Gen. John Gibbon, U. S. A.
- A Mountain Lion Hunt by Night.**
Illustrated. Robert Meade Smith, M.D.
- Trouting on Clark's Fork.**
Illustrated. Gen. F. W. Benteen, U. S. A.
- Ducking off Machipongo.**
Illustrated. W. J. Bogert
- A Youthful Guide and a Prize Bighorn.**
Illustrated. Hon. I. N. Hibbs
- A Wild Goose Chase.**
Illustrated. A. E. McKenzie
- A Tempestuous Cruise.**
Illustrated. Commodore Chas. Pryer
- Hans the Wolf Hunter.**
(Poem.) Illustrated. S. N. McAdoo
- How Some Women Went Shooting.**
Illustrated. Julia C. Welles

These books will be sold at \$2.00 each, and when the present supply is exhausted there will never be any more. If you want a copy remit at once. Address,

RECREATION, 23 W. 24th St.,
New York City.

SQUIRES' SIBERIAN MOOSE HUNTING BOOTS & SHOES

Made only by **HENRY C. SQUIRES & SON**
20 Cortlandt St., New York

The **leather** is waterproof, fine grained, tough and pliable. The **linings** are russet calfskin. The **soles** are best waterproof anhydrous oak leather, **stitching** of silk, English back stays, bulldog toes, extra heavy **eyelets**, **Pratt fasteners** and **hand made throughout**. Price **\$7.50** net. Short Boots **\$8.50**, Knee Boots **\$10**, Cavalry Style Boots **\$12**. Special circular giving detailed information free for the asking.

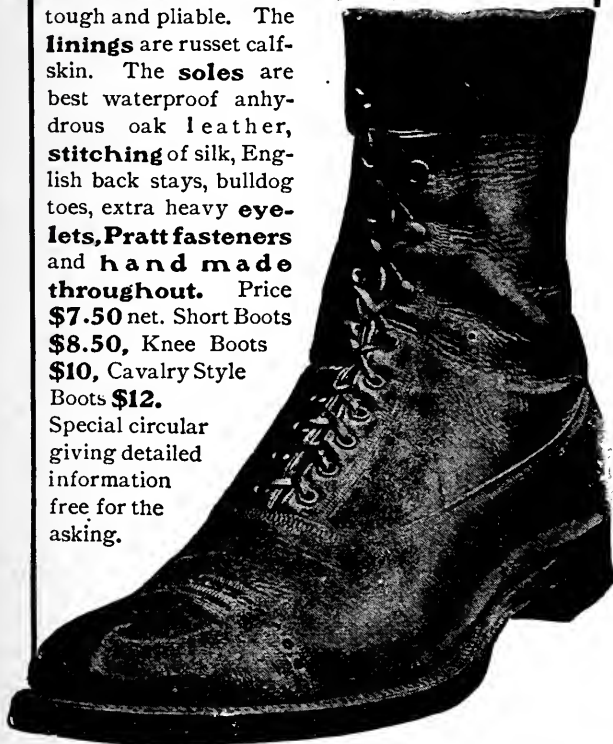

Mention RECREATION.

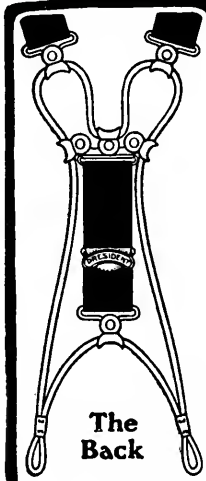

If you want most for your money insist on **President**

being stamped in the buckle when you buy **Suspenders**

50 cents and a dollar. Ask at favorite shop, or post prepaid from

C. A. Edgarton Mfg. Co.
Box 219 J, Shirley, Mass.
Send 6 cents for catalogue.

Deputy game warden Perry, of Grinnell, Ia., recently arrested C. F. Liske, of that city, for killing quails and selling them. Liske was taken before Justice Wilson, who fined him \$100 and costs. This is the kind of a Justice to have and I wish all the others in the county were like him.

Do You Want a Drinking Cup Free? Send me \$1 for a new subscription to RECREATION and I will send you either a fine nickel-plated folding drinking cup or a collapsible rubber cup. For 10 cents extra will send by registered mail. Thomas H. Walker, 295 Merrimac Street, Manchester, N. H.

THEY'RE MADE TO MEASURE

Putman Boots.

Go on like a glove *and* fit all over.

For a Quarter of a Century Putman Boots have been the Standard among Western Hunters, Prospectors, Ranchmen and Engineers (who demand the best) and we have learned through our personal contact with them **how** to make a perfect boot.

Putman Boots are in use in nearly every civilized country in the World. They are Genuine Hand Sewed, Water Proof, Made to measure, Delivery charges prepaid, and cost no more than others. Send for catalogue of over **30 Different Styles** of boots, and blank for self measurement. Also **Indian Tanned Moosehide Moccasins**.

Illustration shows No. 900, 14 inches high, Black or Brown Leather.

Made to measure and delivered in the U. S. Canada or Mex. for **\$7.50**

H. J. PUTMAN & CO.

36 Hennepin Ave. MINNEAPOLIS, MINN.

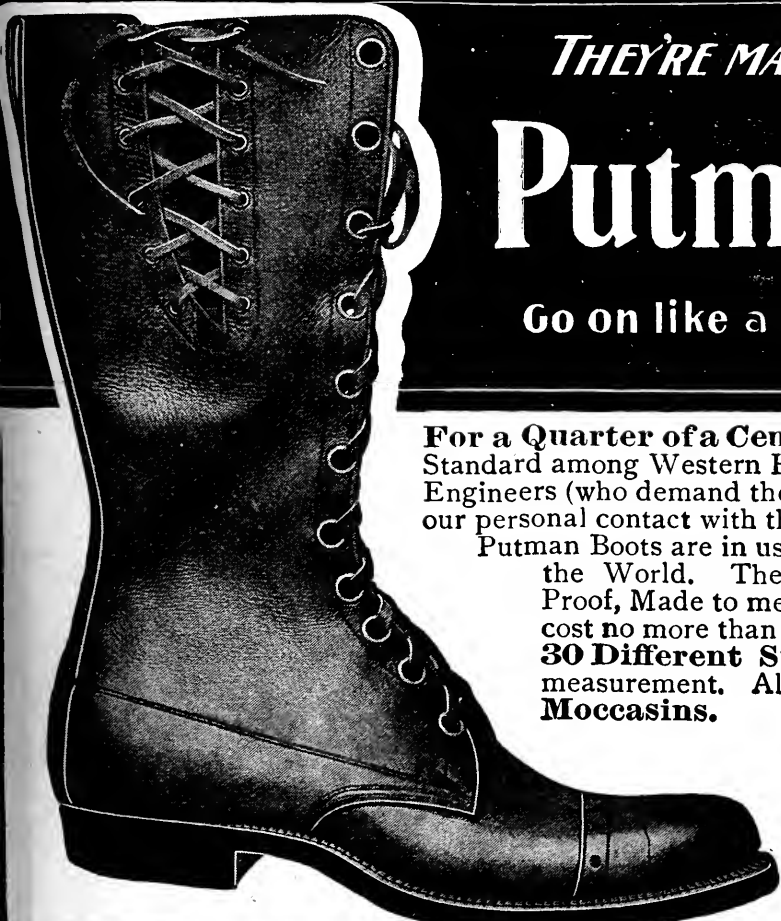



PRIZE AWARDS

For 1902 Contest Automatic Reel:

CLASS I. \$25.00

For heaviest Trout caught with "Y. & E." Automatic Reel during 1902. To A. B. BEAN, POCATELLO, IDAHO.

CLASS II. \$25.00

For heaviest fish of any other kind caught with "Y. & E." Automatic Reel during 1902. To WM. A. TEALL, EAU CLAIRE, W.S.

"The little finger does it."

"Automatic, Combination," Style B., Diameter, 3 3/8 inches. Weight, 11 ounces. Carries 300ft. Winds 90 ft. automatically without re-winding. Price

\$8.00

"The little finger does it."



For all-'round fishing the finest Reel in existence.

The 1902 Contest recorded some interesting battles—stiff fights with gamey fish, under all sorts of difficult conditions.

"Y. & E." 1903 Contest

FIVE MONEY PRIZES:

Three for Grown-ups, - \$25.00 each
Two for Young People not over 16, - 15.00 each

There are no "strings" to these prizes, no "entry" fees of any kind. They will be given for best catches made with "Y & E." Automatic Reels, and anybody, anywhere may compete. Write to-day for free contest blank R-300.

At your dealer's or mailed pre-paid anywhere in the U. S. and Canada. 4 other styles.

Yawman & Erbe Mfg. Co.,

Rochester, N. Y.

Write for Catalogue 299 R.



No. 1. HAS THREE COMPARTMENTS. FLOATS.

HALL'S TELESCOPIC BUCKETS

FROGS MINNOWS ICE

5 STYLES JAPANNED FINISHED AND OXYDIZED COPPER NOT CONFLICTING WITH NATURAL LAWS IN DESIGN OR MAKE WE ARE THE ORIGINAL AND MAKERS OF THE ONLY DEVICES NATURAL TO MINNOWS AND FROGS LIFE IN CONFINEMENT WE MAKE THE LARGEST LINE OF WALKER AND OUTING BUCKETS IN THE WORLD ANY GOOD TACKLE DEALER WILL SHOW YOU HALL'S LINE IF NOT WRITE US DIRECT

PAT. AUG. 5TH 1902. CANADA PENDING PATENTS.

\$10000 WILL BE PAID ANY PURCHASER OF THIS BUCKET WHO WILL SUGGEST AN EFFECTIVE IMPROVEMENT.

WRITE DEPT. D. **HALL MFG. CO. CLEVELAND, O.** 16-20 HIGH ST.

"DINGER" WOODEN TAKE-DOWN DECOYS



Handy, substantial, light and portable. One dozen pack in smaller space and weigh less than two solid wooden decoys. Move about in lightest breeze; more alluring than stationary decoys. Cannot blow over. Price per doz. complete, \$5.00. Write for illustrated circular.

H. S. DILLS, Patentee, 21 11th St., Auburn, Ind.

FISHING. — Black Bass and Salmon.

Illustrated Guide with Maps of the

RIDEAU, BEVERLEY & CHARLESTON LAKES, free

Apply to E. A. GEIGER, Sup't Brockville, Westport & S. Ste. M. Ry., Brockville, Ont.

No Other Reel Will Give

Satisfaction after you have seen the



"TALBOT"

A thing more perfect was never wrought in metal. In tournaments always a victor. Among fishermen's treasures, the chief.

Send for Booklet F:

W. H. TALBOT, Nevada, Mo.



Fine Fishing Tackle Free.

The Famous Shakespeare Reels and Baits
That Catch Fish, Free to Any
Enthusiastic Angler Who Sends
Name and Address.

Who Will Catch the \$100.00 Prize Large or Small Mouth Black Bass This Year?

I want every enthusiastic fisherman, whether amateur, beginner or professional to have a personal knowledge of the fine points of the Shakespeare Reels and the marvelous catching qualities of the Shakespeare Baits—and to do this I propose to send to every man or woman who fishes for the real sport there is in it, one of my reels and baits for free trial on their next fishing trip. Write to-day. Send your name and address and the name and address of the leading sporting goods dealer of your city to Wm. Shakespeare, Jr., 244 Shakespeare Bldg., Kalamazoo, Mich. The Shakespeare Reel is specially designed for accurate and long-distance casting, and it is without doubt the best reel in the world, and you will say so when you see it. The metal used in the manufacture of the Shakespeare Reel is hard-drawn brass and the finest English Stubbs steel—the best obtainable. Painstaking care is used to secure perfect accuracy in every detail. In beauty of design, and simplicity of construction it is unequaled. Its easy, silent running suggests perpetual motion and it is fitted with the most perfect drag and click ever invented. Words will not describe its beauty, its usefulness and its many advantages over all other reels. My reels and baits are for sale by all first-class dealers, but I want you to see them and try them for yourself and I will send them to you direct, express prepaid, for a free trial on your next fishing trip. The Shakespeare Baits are really marvelous. With them the fisherman is sure of a good catch, no matter where the fish are, in the lake or stream. If they are in deep water, Shakespeare makes the bait that attracts them. If they are in shallow water, Shakespeare makes the bait that catches them. If they are hidden in the lily pads or moss, Shakespeare makes the bait that makes them strike. And Shakespeare offers \$100 in prizes for the photograph and authentic dimensions of the biggest large or small mouth bass caught this year. Write to-day for particulars. His little booklets, "How to Catch Bass," "Fine Points About Tackle" and "The Art of Bait Casting" are free to every angler. Write to-day and send your name and address,

IT NEVER FAILS

The S. & W. Artificial Bait



Is the most successful bait made. When in motion it resembles a minnow so closely that it never fails to delude the fish. Its construction makes it almost impossible for a fish to strike and not get caught.

A GREAT SELLER

Do you fish? Buy one. You will never be without one afterward. Why? It will catch fish. Can be used with rod or hand line.

Dealers send for illustrated booklet and get our prices.

If your dealer cannot supply you, send 50c. at once for one (post paid) to

STARK & WECKESSER

57 S. Main St. :: : DAYTON, OHIO, U. S. A.

Do you want A Folding Canvas Boat?

IF SO, SEND ME

35 yearly subscriptions to RECREATION

AND I WILL SEND YOU

A 14 ft. folding canvas boat listed at \$48

capable of carrying 2 men and an ordinary camp outfit. There are thousands of these boats in use, and nearly every man who is using one of them praises it on every occasion.

Sample copies of RECREATION for use in canvassing will be furnished on application.

Address 23 W. 24th St., N. Y.

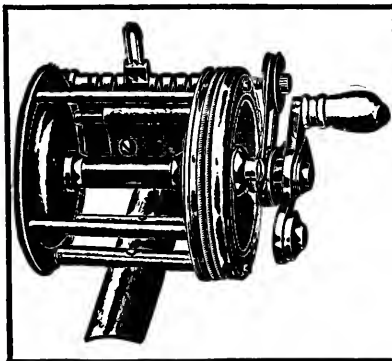

A UNIQUE INVENTION

Patented Jan. 13, 1903.

An Independent Even Spooling Device that can be attached to many kinds of quadruple Fishing Reels, converting them into level winding Reels in less than five minutes. It takes the entire care of line and is all right for casting. Our prices for Reels fitted with Spooler is no more than the usual price charged for the same grade of Reels without Spooler. We sell none of the lower grade of Reels, and we agree to refund your money if on inspection goods are not just as represented and satisfactory. Write for a descriptive catalog of Reels, Independent Even Spoolers, Fish Hook Shield, Lightning Fish Scaler, Spring Shot Gun Cleaner, and Little Giant Small-bore Rifle Cleaner.

A. W. BISHOP & SON, Racine, Wis.



Send for catalogue of our full line of Folding Canvas Boats and Canoes, which have been adopted by Governments of United States, Canada and England. Just filled an order for Received medal and award at Chicago World's Fair. Mention RECREATION.

U. S. Government who prefer our boats. If you investigate we will get your order.

Acme Folding Boat Company, Miamisburg, O.

For Sale: Acme Folding canvas boat No. 2, 12 feet, complete. Only used last fall and in perfect condition. Extra set of rowlocks. Steady boat to shoot from. Price, \$22.

Dr. J. A. Bliss,
Ruthven, Iowa.

For Exchange: A fine old violin in good order; age and maker unknown. Wanted heavy twelve bore double breech loader or repeater.

H. Van W. Myer,
Madison, N. J.

D.M. TUTTLE CO. 10 PINE STREET CANASTOTA, N.Y. **CATALOGUE FREE.**

BREAK SPARK. **GASOLINE ENGINES & LAUNCHES.** JUMP SPARK.

"It's All Up
With Me"

said Mr. Fish.

"That man has

a

Bristol Steel Rod

I can tell that by the *Spring.*"

The "spring" of the Bristol Rod hooks your fish so securely that he stays hooked.

The "back-bone" of the Bristol Rod will land your fish no matter how big he is.

This combination of "spring" and "back-bone" is what puts the Bristol Rod in a class by itself—a Rod that will last longer and give you more fun for your money than any other rod costing two or three times as much.

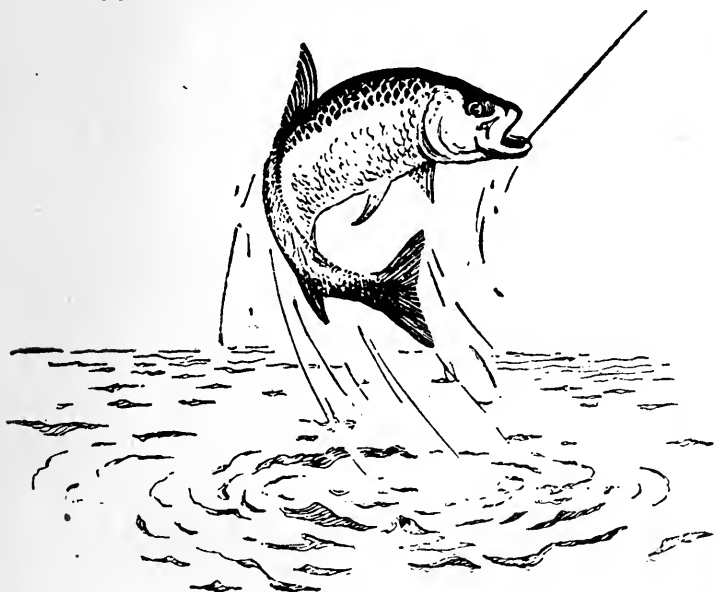

Nothing to Warp or Swell
Nothing to Split or Shrink

Send for catalog "R" describing 25 styles finished in almost anything from black enamel to oxidized silver, costing from \$3.50 to \$17.00. Sold by all up-to-date dealers.

**THE HORTON
MANUFACTURING
COMPANY**

Bristol, Conn., U. S. A.

Two Views of one of Our 54 Models.

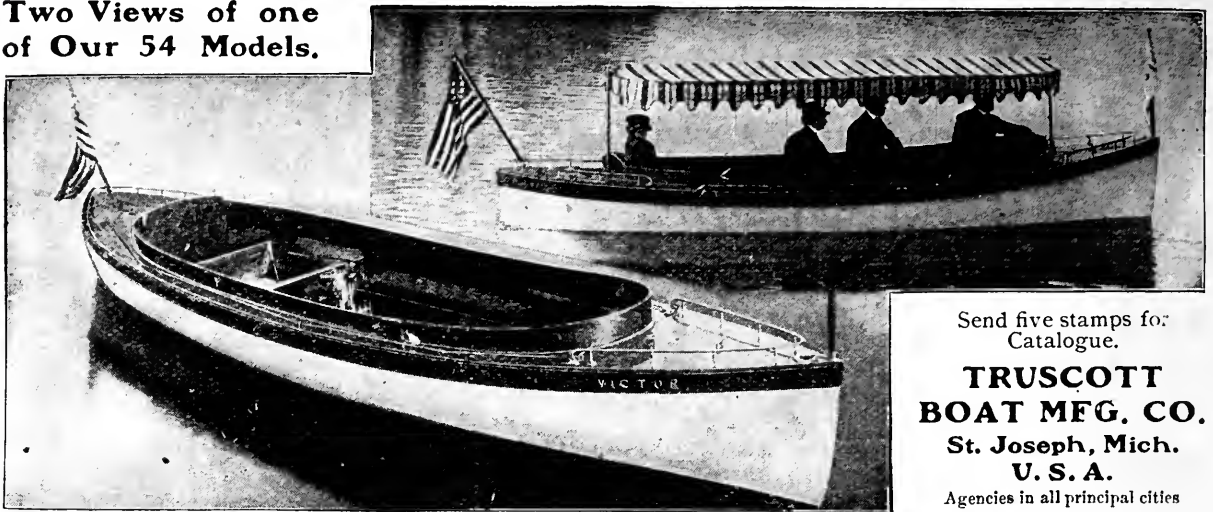

Send five stamps for Catalogue.

TRUSCOTT BOAT MFG. CO.
St. Joseph, Mich.
U. S. A.

Agencies in all principal cities

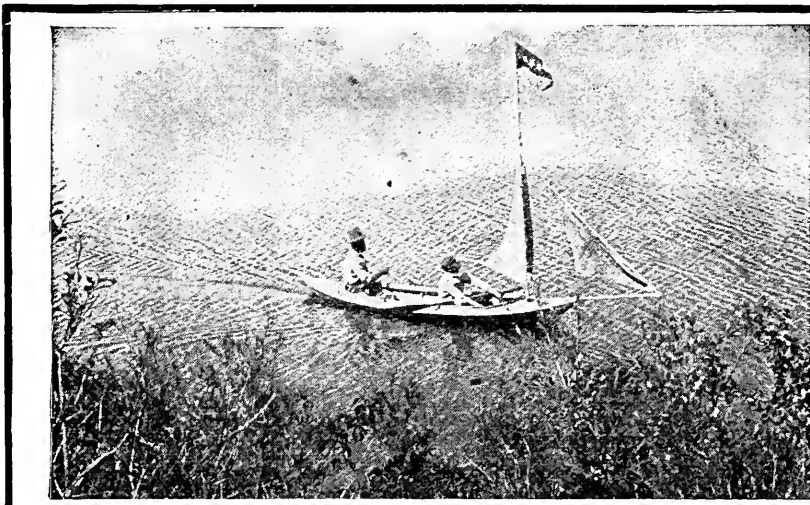

Recreation with the aid of a Mullins' Metal Boat or Canoe is as near perfect as you can get it.

Send for our handsome illustrated catalogue—FREE.

W. H. MULLINS
228 DEPOT STREET
SALEM, OHIO

WHITESTONE HOLLOW SPAR AND BOAT CO.

Successors to

The Spalding St. Lawrence Boat Co.,

Builders of { The FAMOUS St. Lawrence River Skiffs
Cedar Canoes
Canvas Covered Cedar Canoes
Speed Launches
YACHTS' DAVIT BOATS

Makers of

Send for Spar Book—let No. 4.

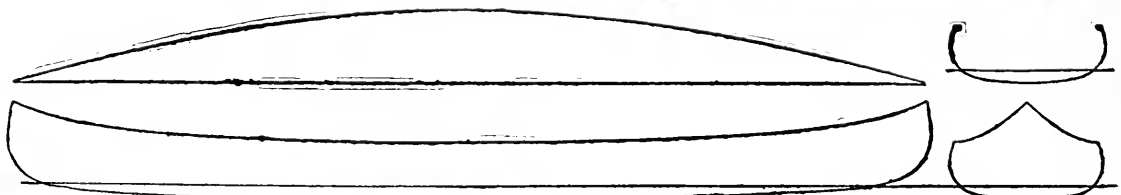

Skiff, Rowboat and Canoe Catalogue No. 5.

WHITESTONE HOLLOW SPAR AND BOAT CO.

J. G. FRASER, Manager

Whitestone Landing, Long Island, N. Y.



**BULLARD STEEL LAUNCHES,
ROW AND PLEASURE BOATS,
ARE EVERLASTING!**

Safer than wood; have greater carrying capacity; always dry; no bolts or nails to rust.

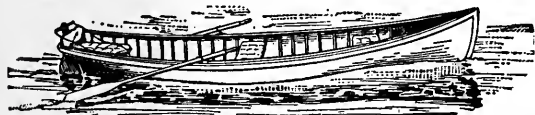

Boat Liveries equipped with the Bullard Steel Boats. Always have dry boats, that last a lifetime.

STEEL BOATS CHEAPER THAN WOOD.

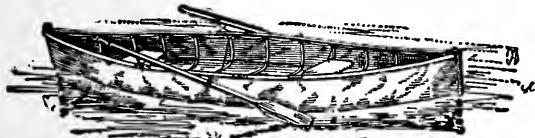

THE OSGOOD FOLDING CANVAS BOATS

Original Canvas Boat; made for 30 years. Sold all over the world; used by U. S. Government; best Fishing and Hunting is where there are no boats, take one with you in trunk or bag. Non-puncturable. Folded or extended in one minute.

Send for catalogue illustrating all improved popular designs of Steel, Wood, and Canvas Boats, and Marine Engines.

MICHIGAN CONSOLIDATED BOAT CO., LTD.
505 Main St., Battle Creek, Mich.

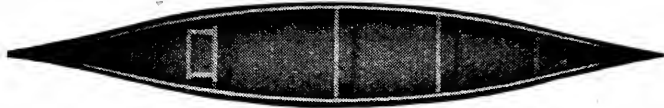

RUSHTON CANOES



"INDIAN GIRL" MODEL, 15, 16, 17, 18 feet, \$30 to \$43.

Are Leaders!

My boats combine strength and speed with lightness and beauty.

My models are the result of 29 years of experience—the materials and workmanship are the very best.

I use air-seasoned Michigan white cedar exclusively in my canoes, and make a specialty of canvas-covered and all cedar canoes.

Send for my complete catalogue of pleasure boats, canoes and fittings.

J. H. RUSHTON,

817 Water Street,

Canton, N.Y., U.S.A.

SAILING. CAMPING. PROSPECTING. FISHING. HUNTING.

Established 1840

GEO. B. CARPENTER & CO.

MAKERS OF HIGH GRADE

**TENTS, SAILS
CAMP FURNITURE**

Folding Cots
Tables and Chairs

Oars, Paddles
Marine Hardware

Copyright 1899
Geo. B. Carpenter & Co.

**The Largest and Most
Complete Stock in the U. S.**

Send 4c. in stamps for Tent and Camp Catalogue, or
6c. in stamps for Marine Hardware Catalogue.

200, 202, 204, 206, 208 S. Water St.
CHICAGO, ILL.

KING FOLDING CANVAS BOAT CO.,

January 21st, 1903.

Kalamazoo, Mich.

Dear Sirs:—My business is hunting, trapping and guiding. Last year my canoe got smashed shooting rapids and a friend of mine who had one of your boats let me take his for about two months and it got all kinds of hard usage and I guided several parties in it. I answered enough questions as to who was the maker, where made, and if it was any good, to fill a diary. I don't know whether any of them ever bought a boat afterward or not but they all said it was just what they would like to have, and some of them saw a good test of the boat with me and they all liked the boat. In my line of business I have to have a boat that will stand hard usage and yours had some pretty hard trips and stood the racket O. K. It was a good ad for you and if I had had the boat earlier, it would have been more so.

Yours for luck,
BOB WOODMAN, Jr.,
 Temporary address, 225 Leyden St.,
 Orient Heights,
 East Boston, Mass.



11-foot Special

With Air Chambers
They Float 100 Pounds!

Bottom Boards
Rest on the Frame
Not on the Canvas

They are **Stiffer and Safer** than a Wooden Boat because the lines are fuller, and are much easier to row or paddle.

Send 6c. for Catalogue No. 7
 60 illustrations and 350 testimonials

King Folding Canvas Boat Co.
 Kalamazoo, Mich., U. S. A.

PALMER

Gasoline Engines and Launches

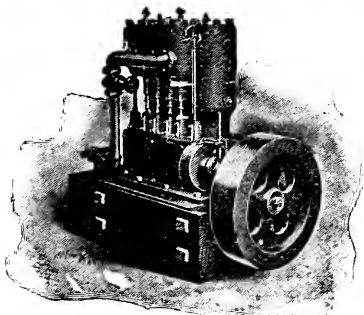

MARINE and STATIONARY ENGINES

of both two and four cycle type in stock.

*Special discount on launches ordered during
 winter months for Spring delivery*

PALMER BROS., = Cos Cob, Conn.

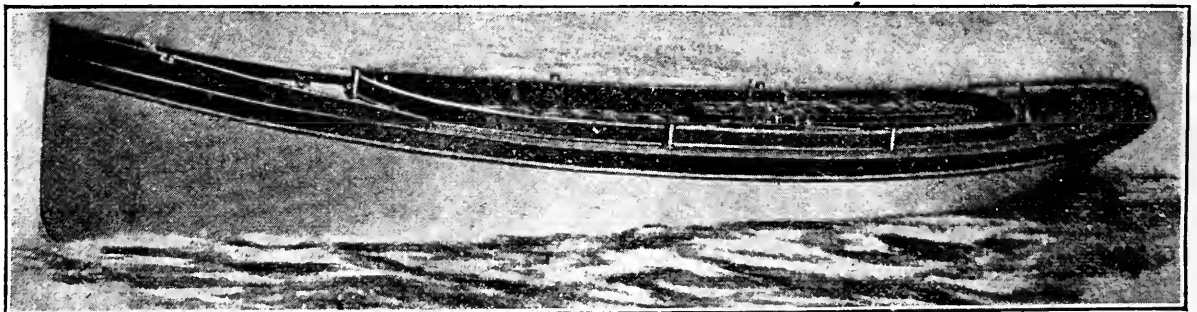

LEAMAN BOAT COMPANY

WINNECONNE, WIS.

Manufacturers of Gasoline Launches, Sail, Row, and Hunting Boats. Our prices are low, our work guaranteed. Launches, \$150 up. Row Boats, \$22 up. Hunting Skiffs, \$20 up. The oldest Boat Company in the State. Write for Wants. Mention RECREATION.

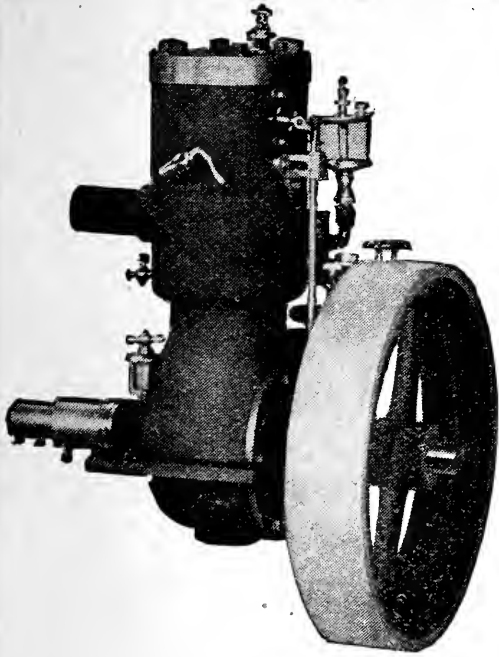

“Miss Simplicity”

All that the name implies. Sold under a guarantee that there is nothing **higher grade** in either material, workmanship or equipment on the market; that it will run perfectly and continue so.

2 H. P., \$120.00. 3 3-4 H. P., \$155.00.
5 1-2 H. P., \$200.00.

Immediate deliveries. Circular giving full description for the asking.

ST. JOSEPH MOTOR CO., St. Joseph, Mich.

Ella—Bella told me that you told her that secret I told you not to tell her.

Stella—She's a mean thing—I told her not to tell you I told her.

Ella—Well! I told her I wouldn't tell you she told me; so don't tell her I did.—Exchange.

Huron Indian Work: To any one subscribing to RECREATION through me I will give a Bracelet and Ring worked in horse-hair, with any small inscription you like, your name, etc., woven in it with caribou hair; quite a curiosity, Send along your \$1. Walter Legare, 518½ John Street, Quebec, Canada.

Points on Angling

More complete than ever before.

The Habits and Haunts of
GAME FISH
and How to Catch Them

Mailed free on application

THE SPECIALTY MFG. COMPANY
Goshen, Indiana

FAY & BOWEN

Motors & Launches

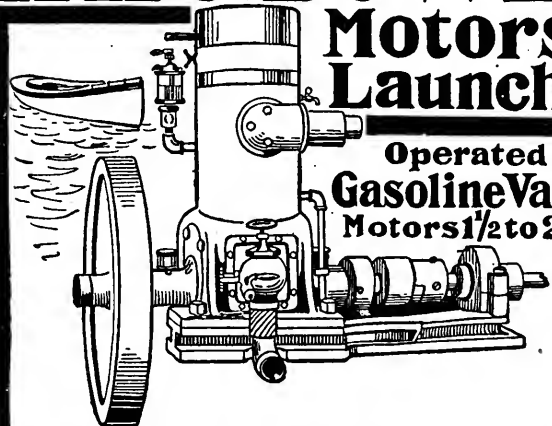

Operated by
Gasoline Vapor
Motors 1½ to 25 H.P.

THE Fay & Bowen Marine Motor is a revelation to those who have used others. Reliable, safe, durable and easy to operate. Remarkable speed control. Best of all, it starts when you start it. No handle or crank is used. Our patented ignitor is absolutely unique and always instant and positive in action. It is really the only perfect and satisfactory ignitor.

Motors complete from 1½ to 25 H. P. ready for installation. We also build handsome launches with motors installed and ready to run.

Send for Catalogue.

Fay & Bowen,
28 Mill Street Auburn, N. Y.

Cowboy Outfit

A Genuine Cowboy Combined Cartridge and Money Belt

of fine special prepared tanned russet leather; made in all sizes; $2\frac{3}{4}$ ins. wide; large, nickel buckle. Strong and durable. Just the thing for sportsmen. Postpaid anywhere for \$3.00.

Hand Carved Tanned Russet Leather Cowboy Holsters

to match belt, and in all sizes. Postpaid anywhere for \$2.00 each.

Cowboy Riding Pants

made from the best oiled leather, of special prepared stock; solid leather waist band, laced together; fringe down sides of legs; two pockets; waist measurement not necessary; weight, $5\frac{1}{2}$ to $6\frac{1}{2}$ pounds. Prepaid express anywhere in United States for \$10.50 per pair.

Good Durable Cartridge Belts and Holsters to match at \$1.75, postpaid.

Fine Pack Saddles and Outfits When writing enclose stamp for reply.

Remittances should be addressed to the

Edward Smith Indian Post Trading Co.

General Eastern Office

Buhl Block, DETROIT, MICH.



INDIAN CURIOS

WHOLESALE & RETAIL
CURIO DEALERS'
SUPPLY DEPOT.

Bead Work, Baskets, Elk Teeth, Mexican Goods, Fossils, Minerals, Arrow-Heads, Pottery, Alaska Ivories, Shells, Agates, Photos, Great stock, Big Cata. 5c., stamps. Mention RECREATION. If a dealer, say so.

L. W. STILWELL

DEADWOOD SO. DAKOTA



J. BLAKE

Buyer and Exporter of
RAW FURS
1 WEST THIRD ST.

NEW YORK

Write for price list

Practical Common Sense
in 6 Sizes.

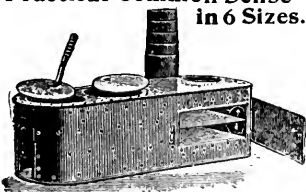

CAMP STOVE

Either with or without oven. The lightest, strongest, most compact, practical stove made. Cast combination sheet steel top, smooth outside, heavy lining in fire

box and around oven, holds its shape, telescopic pipe carried inside the stove. Burns larger wood and keeps fire longer than any other. Used by over 9,000 campers and only one stove returned.

For catalogue giving full particulars, mention RECREATION and address,

D. W. CREE, Manufacturer, Griggsville, Ill.

50 BUYS A RUNABOUT

Full
Bike
Gear

Best Grade
Rubber Tires

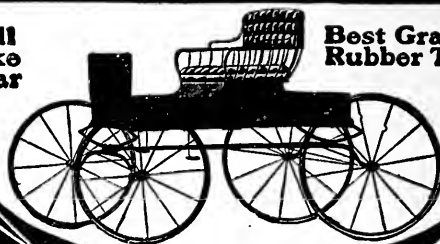

SAVE DEALERS PROFITS

The rapid increase in the volume of our business and the vast number of satisfied customers on our books prove we can serve your interests best.

We manufacture a full line of Buggies, Carriages, Wagons and Harness of very superior

Quality—Style Durability and Finish

These four essentials are to be found in every vehicle and set of harness sent out by us. We employ only skilled mechanics in all departments and furnish them with the very best materials. With the entire output of two enormous modern factories and superb shipping facilities at our disposal, we are able to furnish high-grade vehicles at prices that—quality considered

Positively Defy Competition.

All goods guaranteed and shipped on approval. Money back if you are not satisfied. Write at once for our catalog and special inducement, it will interest you.

UNION BUGGY COMPANY, 495 Saginaw Street, Pontiac, Mich.

Do you want a Good, Reliable,
Substantial, Well Made

Single Barrel Shot Gun

If so, send me

10 YEARLY SUBSCRIPTIONS

and I will send you such a
Gun as a premium

It is made by the *DAVENPORT ARMS CO.*, and this means it is made of good material and that only good workmanship is put on it.

This is one of the many remarkable opportunities *RECREATION* is offering to men and boys to fit themselves out completely for shooting and fishing.

Sample Copies for Use in Canvassing
Furnished on Application.

Address

RECREATION

23 W. 24th St., New York City,

The Automobile that Solves the Problem

Questions of power, control, speed, weight, convenience, comfort—all the problems that have racked the brain of manufacturers and chauffeurs since motor cars were first made, have been solved in the

CADILLAC

Automobile

It is new from every aspect. If you know of an auto that you'll find it corrected in the Cadillac. One of its novel features is the independent tonneau that converts a graceful runabout for two into a substantial touring car for four. Write for free descriptive booklet K, and name of nearby dealer.

CADILLAC AUTOMOBILE COMPANY
Detroit, Michigan

The Best Offer Yet—To any person who will subscribe to RECREATION for one year through me I will send free a small water-color landscape, hand painted, suitable for framing; or a hand painted silk bookmark. For two subscriptions I will send a fine Mexican opal scarf pin worth ordinarily from \$1.00 to \$1.50.

Don M. Harris, 308 Crawford Road,
Cleveland, Ohio.

Mexican Opals Free: To any one subscribing to RECREATION through me, I will send a beautiful genuine Mexican Opal, large as a bean.

A. Thomson, Box 332, San Antonio, Tex.

Game and fish hogs are plentiful here. They delight in making big catches of pick-erel and shooting all the squirrels. A person here shot 17 greys one day last week and came through the village exhibiting them. I wish New Hampshire would limit the season for grey squirrels to November and December. Now it opens before the animals are full grown, and any fool with a gun can kill 18 or 20 a day while the leaves are on the trees. I never shot more than 5 in a day and not over 15 in a season.

F. H. Leavitt, Merrimack, N. H.

RELICS OF A DISAPPEARING RACE

Buffalo Skulls

WITH POLISHED OR
UNPOLISHED HORNS

Also polished or unpolished horns in pairs or single. Polished horns tipped with incandescent electric lights; polished hunting horns; mirrors hung in polished horns, etc. These are decided novelties and are in great demand for sportsmen's dens, offices, club-rooms, halls, etc. Send for illustrated catalog. Mention RECREATION.

E. W. STILES

141 Washington St.

Hartford, Conn.

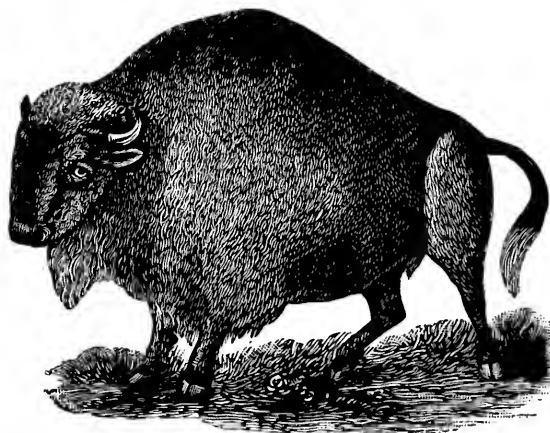

Marble's Safety Pocket Knife.

We offer something better in the way of a hunting knife. Not merely better than the old unreliable kind, but far and away the **BEST** folding hunting knife made, equal in quality to our celebrated Ideal hunting knives, and one of the latest and best of the Marble Tricks.

It has a five-inch blade which folds into a four-inch handle. When the knife is open the blade locks so firmly that no mischance can cause it to close. It is as rigid as a one-piece knife.

When it is closed it may be carried in the pocket or at the belt.

It is not a ramshackle toy but a thoroughly dependable knife, which will never fail in the hour of need.

It is hand tested and hand made from the very best steel—tempered to stand the hard knocks of field service, beautifully finished and it bears the "**MARBLE**" guarantee of quality.

The price is **\$4.00**. Get one from your dealer or direct from the makers. Send for catalogue "A."

MARBLE SAFETY AXE CO.
Gladstone, Mich.

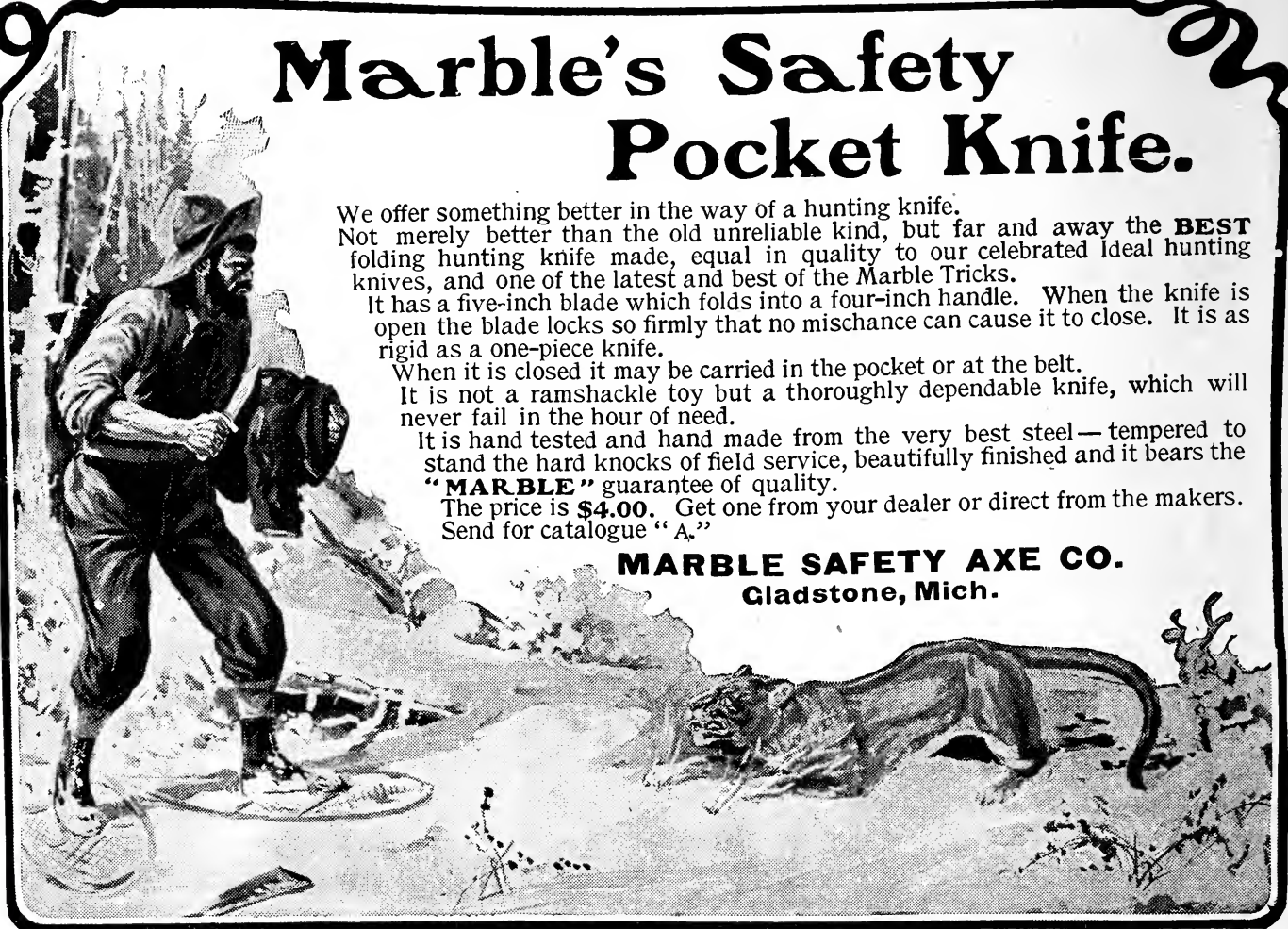

THE BRADLEY SHOT GUN SIGHT!



Wing Shooting is made easy and certain by using this gun sight. Scores at trap and in field

greatly increased by its use. Right and left birds are bagged as easily as straight-away birds.

Price 50 Cents, Postpaid.

C. L. BRADLEY, Inventor, CLARKSVILLE, TENN

I received the tent from G. B. Carpenter & Co., Chicago, Ill. I am more than pleased with it. The quality of the canvas and of the workmanship is perfect.

A. E. Peterson, Geneseo, Ill.

Telescopic Sights

FOR HARD USE AND FINE WORK

ADDRESS FOR CIRCULAR

L. N. MOGG, Marcellus, N. Y.

Mention RECREATION

The Forehand revolver you sent me as a premium for subscriptions to RECREATION is a beauty. I thank you sincerely for sending me such a fine present.

Walter F. Wheeler, Racine, Wis.



THERE are many pleasant days in Winter when one feels like shooting tar-gets, but the gun club grounds are closed for the season. Every trap shooter should provide for these occasions by owning a J. C. Hand Trap. Does all the work of the ground trap and more. *Throws any target at any angle.* Weighs but six pounds and can be carried anywhere. Dealers write. Sent by prepaid express on receipt of price, \$4.00.



Seven Gold Medals and Five Diplomas of Honor
Bronze Medal Paris Exposition, 1900

“COLLAN OIL”

WATERPROOF
BOOT, HARNESS and
BELT DRESSING

Mention RECREATION.

Send for Circular

J. R. BUCKELEW, 111 Chambers Street
New York City

PATENTS

Quickly secured. **OUR FEE DUE WHEN PATENT OBTAINED.** Send model, sketch or photo. with description for free report as to patentability. **48-PAGE HAND-BOOK FREE.** Contains references and full information. **WRITE FOR COPY OF OUR SPECIAL OFFER.** It is the most liberal proposition ever made by a patent attorney, and **EVERY INVENTOR SHOULD READ IT** before applying for patent. Address:

H. B. WILLSON & CO.
PATENT LAWYERS,
Le Droit Bldg., WASHINGTON, D. C.

“I want to see the cook right after dinner.”

“You are not going to discharge her, George?”

“Discharge her? No, indeed. I want to get the recipe from her for this pudding sauce. It ought to make the best kind of office mucilage.”—Cleveland Plain Dealer.

For Sale or Exchange: A Ray Camera, 2½ x 2½, and complete outfit. Cost \$7.50. Has been used but little. Will exchange for tent, rifle, boat or anything of use in camping, or sell for \$5. Also some Belgian Hares and Barred Plymouth Rock Fowls. S. A. Anderegg, Westernville, N. Y.

Brass Rod for Cleaning Rifles

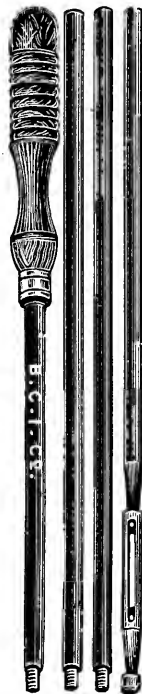

A four-jointed rod with
No. 246 bristle or No. 246
B brass wire brush . . .

MADE with revolving snakewood handle which allows the rod to turn in the barrel and follow the grooving without unscrewing. Packed complete in bag. Catalog price \$1.00 each.

Send for complete Catalog describing shot gun and rifle implements

The Bridgeport Gun Implement Co.,
313-317 Broadway, New York.

Newhouse Traps

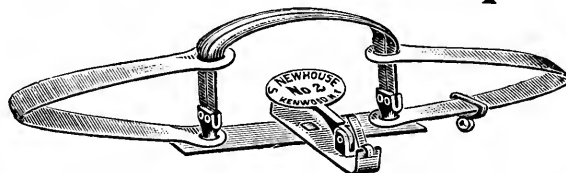

THE STANDARD FOR OVER FIFTY YEARS
Used by all professional hunters and trappers,
who find that

The Best Trap is the Cheapest
Complete illustrated catalogue on application.

ONEIDA COMMUNITY, LTD, Kenwood, N. Y.

THE IDEAL

“STRAIGHT LINE” RE & DE CAPPER

is the **only one** that will de-cap and re-cap properly, all Shot Gun Shells with a central fire hole, Brass or Paper, Domestic or Foreign make, whatever the inside shape may be, **high or low base.** It will seat any and all sizes and shapes of primers, **straight** in the pocket of the shell, **positively all the same depth, without concaving**

the head, or disturbing the fulminate which causes miss-fires. Send us six cents in stamps for **HAND BOOK No. 15**, giving full information of New Goods and much new matter of interest to shooters. Address,

IDEAL MANUF'G CO., 12 U St., New Haven, Conn., U. S. A.

THE PHIL. B. BEKEART CO., of San Francisco, Cal., Agents for Pacific Coast.

When you write please mention Recreation.



Price
\$1.50 each.

MENTION GAUGE WANTED.

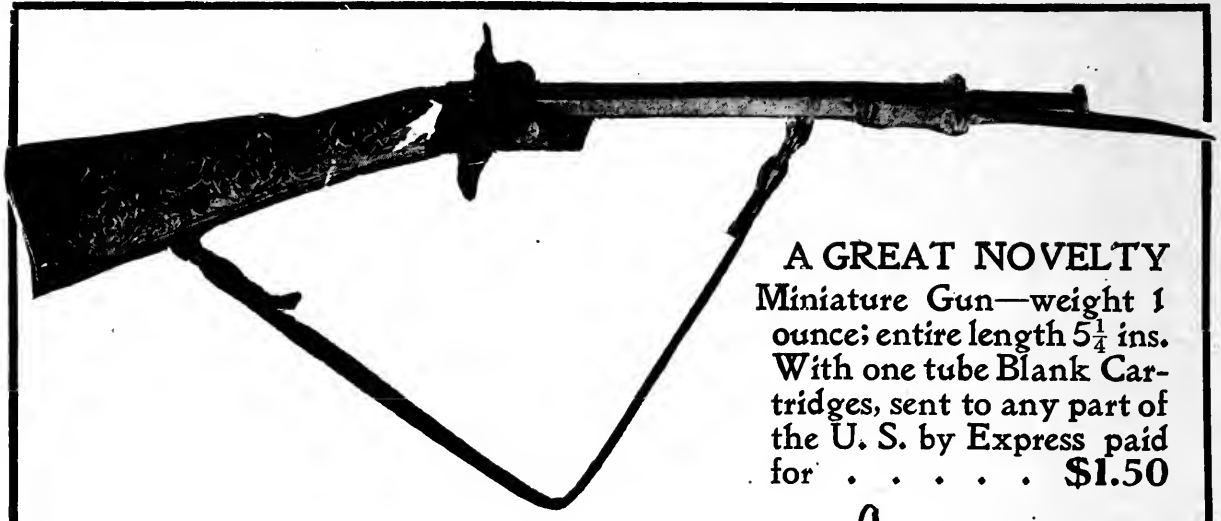

A GREAT NOVELTY
 Miniature Gun—weight 1
 ounce; entire length $5\frac{1}{4}$ ins.
 With one tube Blank Car-
 tridges, sent to any part of
 the U. S. by Express paid
 for \$1.50

Charm Pistol (weighing 1 ounce),
 with one tube Blank Cartridges,
 sent free for \$1.00

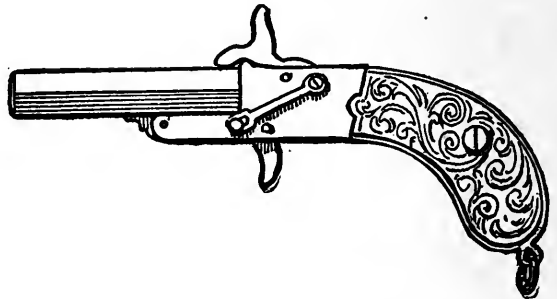

SCHOVERLING, DALY & GALES
 302-304 BROADWAY = = NEW YORK

KOENIG'S SHELL EXTRACTOR.



Every shooter should
 have one—carry it in a
 vest pocket. Fits any
 gauge shell. Koenig's
 Gun Catalogue, Free.

10 Cts. Postpaid.
E. G. KOENIG, NEW JERSEY'S LARGEST GUN HOUSE
 SOUTH BROAD STREET,
NEWARK, N. J.

For Sale: 22 Ligne Bardou Rifle Range
 Telescope, in first-class condition. Cost
 \$20, but will sell for \$12; a bargain to the
 one wanting a good glass. M. E. Arm-
 strong, Le Roy, Minn.

"Queen of Sea Routes"

TO
Florida and the South
MERCHANTS & MINERS TRANS.
COMPANY STEAMSHIP LINES

between Baltimore and Savannah; Boston, Nor-
 folk and Baltimore. Philadelphia and Savannah;
 Providence, Norfolk and Baltimore.

Accommodations and Cuisine Unsurpassed
"Finest Coastwise Trips in the World."

Send for Winter Excursion Book
J. C. WHITNEY, 2d V. P. and T. M. W. P. TURNER, G. P. A.
General Offices: BALTIMORE, MD.

THE NEW LEFEVER

16 and 20 guages as light as $5\frac{1}{4}$ lbs.
 12 guage as light as $5\frac{3}{4}$ lbs.

**Ejectors Automatic or Non-Automatic at
 will of Operator.**

All wearing parts thoroughly compensated.
 We give more Options than any other manufacturer.

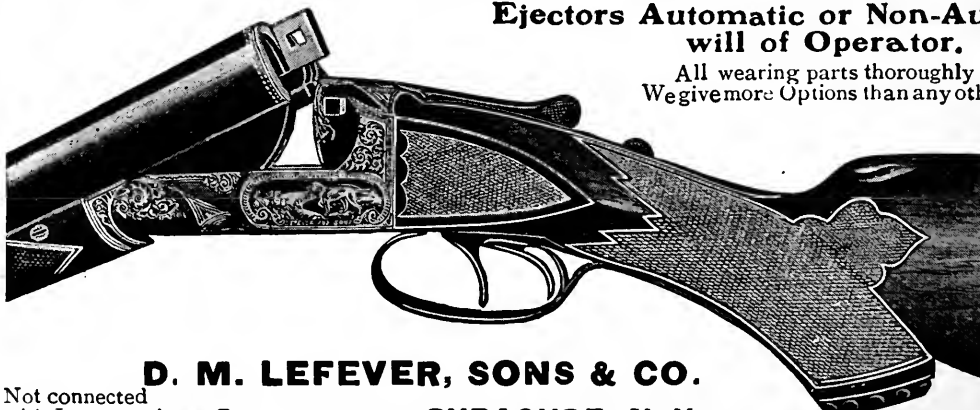

Strong and sim-
 ple in Construc-
 tion. Beautiful
 in Proportions,

**Our Perfect
 Gun Clean-
 er by mail,
 45 cents.**

D. M. LEFEVER, SONS & CO.
 SYRACUSE, N. Y.

Not connected
 with LEFEVER ARMS Co.

Mention
 Recreation.

DUPONT SMOKELESS

WINS MORE HIGH AVERAGES THAN ALL OTHER POWDERS.

ITS UNIFORMITY, VELOCITY, AND CLOSE PATTERN ARE DEMONSTRATED BY THOUSANDS OF TRAP SHOOTERS THROUGHOUT THE COUNTRY.

E. I. DUPONT DENEMOURS & Co.

WILMINGTON, DELAWARE

POWDER MAKERS FOR A CENTURY

For 15 years I have been working for the protection of game. I assisted in having a law passed in this State forbidding the sale of quails. I hope to see similar laws in all other States; also laws prohibiting the marketing of ducks.

L. S. Eddins, Sedalia, Mo.

The Korona camera sent me as a premium came to hand all right. I thank you for it, and you may be sure I will do everything for RECREATION I can.

G. F. Granville, Effingham, N. H.

FREE.

To any person sending me \$1 for one year's subscription to RECREATION, I will give free, a choice of the following:—

One dozen 5 x 7 Stanley dry plates; or one dozen 4 x 5 Seed dry plates; or one 8 x 10 bromide enlargement from your pet negative. Jay L. Robson, 64 Main St., Batavia, N. Y.

Eggs Free: To all who send me 3 yearly subscriptions to RECREATION, at \$1 each, I will send one sitting of barred Plymouth rock eggs. America's best strains. Chas. Knisely, Prairie Depot. Ohio.



PERFECTION AT LAST!

To the "OLD RELIABLE"

has fallen the honor of making the FIRST and ONLY PERFECT score which has ever been made in an all day tournament.

At Spirit Lake, Ia., Aug. 6th, 1902

Events 15 15 20 15 15 20 15 15 20 15 15 20—200
Score 15 15 20 15 15 20 15 15 20 15 15 20—200

The above score was made by

MR. FRED GILBERT WITH A PARKER GUN

Send for Catalogue

PARKER BROS., Meriden, Conn.

NEW YORK SALESROOM: No. 32 WARREN ST.

Mention RECREATION.

STILL ANOTHER GREAT OFFER

Send me 25 yearly subscriptions to
RECREATION and I will send you

A Grade O Syracuse Gun

Listed at \$30.

I have contracted for 20 of these
guns at a price which enables me to
offer them as above, and they will
doubtless all be taken within the
next three months.

If you want one of the Guns get a move on you

Sample copies of RECREATION
for use in canvassing furnished on
application

RECREATION, 23 W. 24th Street, New York

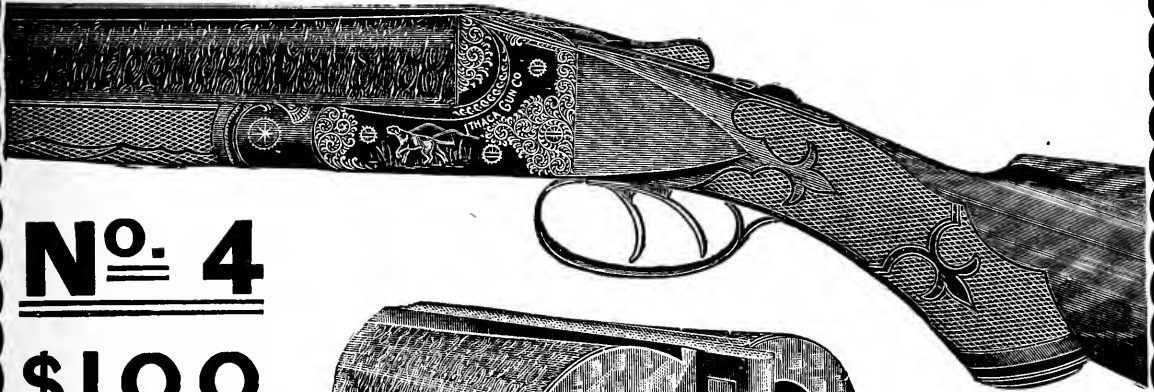

No. 4

\$100

LIST

ITHACA

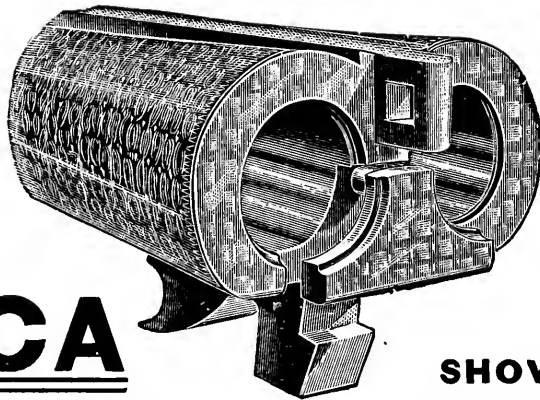

**THE
NITRO
BREECH**

**SHOWING NEW
CROSS BOLT**

**GUARANTEED to be worth \$25.00
more than any other make
of Gun at Same Cost.**

**Send for Catalogue Describing Sixteen
Different Grades of Guns, Ranging in
Price from \$19.50 to \$300.**

ITHACA GUN CO., Ithaca, N. Y.

Mention RECREATION.

H. & R. SINGLE SHOT GUN

Automatic and Non-Ejecting

The cheapest absolutely safe gun, with improvements found heretofore only in the highest priced.

**PERFECT IN MODEL
AND CONSTRUCTION**

**SIMPLEST "TAKE
DOWN" GUN MADE**

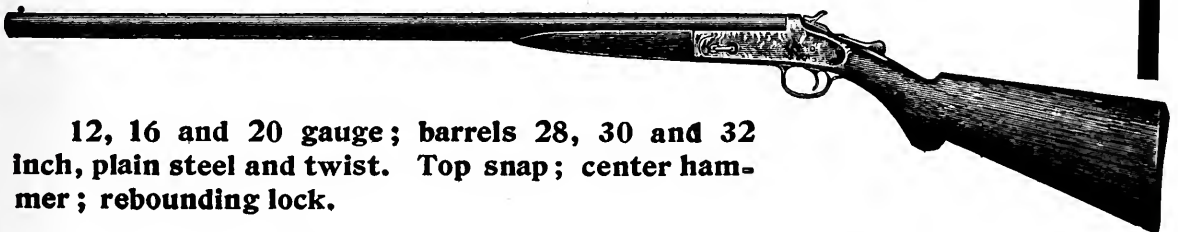

12, 16 and 20 gauge; barrels 28, 30 and 32 inch, plain steel and twist. Top snap; center hammer; rebounding lock.

Your dealer can supply, or we will sell to you direct. Write for Catalog.

HARRINGTON & RICHARDSON ARMS CO.

Dept. R, WORCESTER, MASS.

Makers of H. & R. Revolvers

Do You Want a Gun?

Send me 30 yearly subscriptions to
RECREATION and I will send you a

No. 1 Double Barrel Breech Loading Gun

Made by the Ithaca Gun Co.
and Listed at \$40

I have contracted for 20 of these
guns at a price which enables me to
offer them as above, and they will
doubtless all be taken within the next
3 months.

If You Want One Get Busy at Once

Sample copies of RECREATION for
use in canvassing furnished on application

RECREATION, 23 West 24th St., New York

"HOPKINS & ALLEN" Single Barrel Shot Guns

(Made for any powder and good with any shot.)

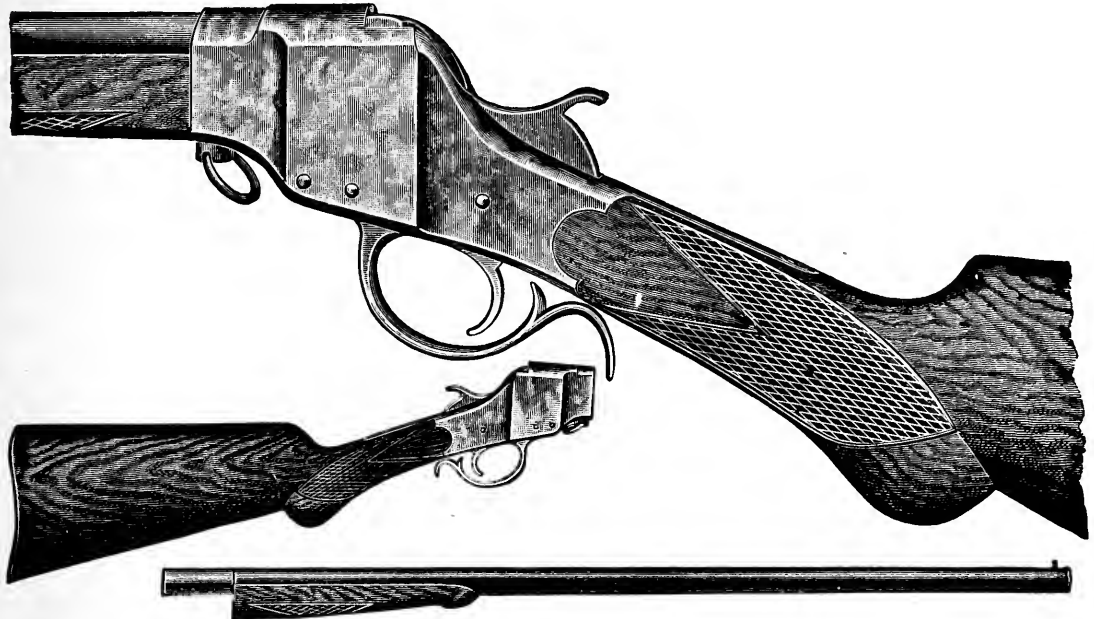

Our "Lever Action" has more friends than any single gun made, has stood the test of fifteen years' continued approval. Simple, durable and reliable.
12 and 16 gauge blued steel barrel..... **\$8.00**



Our new model top snap action, combining all up-to-date features of a modern gun, including patent compensating snap fore end. Automatic shell ejector, **Full Choke Bored**. 12, 16 and 20 gauge decarbonized steel barrel..... **\$9.00**
12 and 16 gauge Stubbs twist steel barrel..... **\$10.00**

We will ship, all charges prepaid, on receipt of remittance with order, to any express office in U. S. A.

The Hopkins & Allen Arms Co.,
NORWICH, CONN., U. S. A.

FINE GUNS

OUR SPECIALTY

SCOTT'S MONTE CARLO

Automatic Ejector Hammerless,

Established
1826

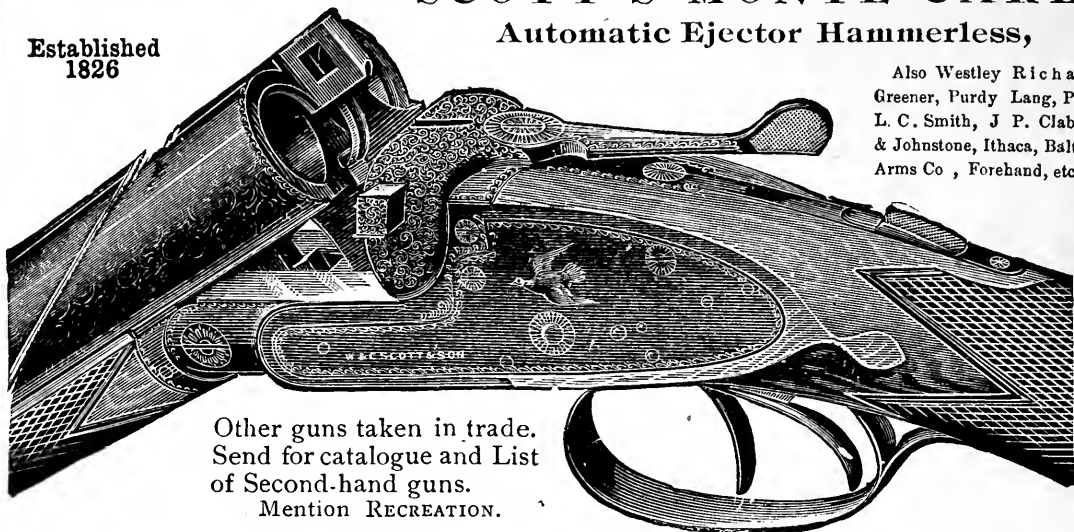

Other guns taken in trade.
Send for catalogue and List
of Second-hand guns.
Mention RECREATION.

Also Westley Richards,
Greener, Purdy Lang, Parker,
L. C. Smith, J. P. Clabrough
& Johnstone, Ithaca, Baltimore
Arms Co., Forehand, etc

SWEDISH LEATHER JACKETS

For Duck Shooting. Soft as Kid. Finest Quality, \$18.00

☞ We take the entire product of the manufacturers of above Finest Jackets and this make cannot be obtained elsewhere in the United States

Gun Repairing BY FIRST-CLASS GUN REPAIRERS
RESTOCKING, BROWNING, Etc., Etc.

Send for Catalogues

WM. READ & SONS, 107 Washington Street, BOSTON, MASS.

The Old Gun House. Established 1826

For Sale: A fine location for sportsmen's hotel and winter resort in Florida, 3 miles from Osprey; 38 acres with 2,000 feet frontage on Little Sarasota Bay and 1/4 mile from Boca Grande. Extension of Seaboard Air Line Railway. Buildings and fruit trees. Best of fishing, including tarpon, and game plenty. Write for full description and price. Dr. J. H. Bissell, Sarasota, Fla.

For Sale: Smith & Wesson Military revolver, 38 caliber, target sights, 6 1/2-inch barrel; nickel, with set Ideal reloading tools, holster and cartridge belt, B. G. I. cleaner, 50 cartridges, 40 shells. All new and in perfect condition. Cost \$21, will take \$15. No exchanges or postals answered.

J. W. Fream, Harney, Md.

For Sale: A Syracuse Hammerless shot gun; grade O. List \$30, 12 gauge; 30-inch barrels, 7 1/4 pounds. With gun case and Powers Combination Cleaning Rod. Condition of gun, perfect. Price, \$20.

W. O. Isaacson, Corry, Pa.

FOR SALE.

Remington, No. 4; Stevens, No. 21; Union Hill Ballard, 32-40; Ballard, 25-21; Remington, 32-40; Remington, 28-30-120. All have telescopes attached. Can take Colt Automatic, or revolver; or S. & W. revolver in trade. L. N. FOGG, Mar. ellus, N. Y.

For Sale: New Al Vista Camera, listed at \$45. Takes views 5 x 4, 5 x 6, 5 x 8, 5 x 10, 5 x 12 on films; also 4 x 5 on plates. Will sell cheap.

Frank Wilson, Box J.,
Elk Rapids, Mich.

THE "BROWNIE" RIFLE

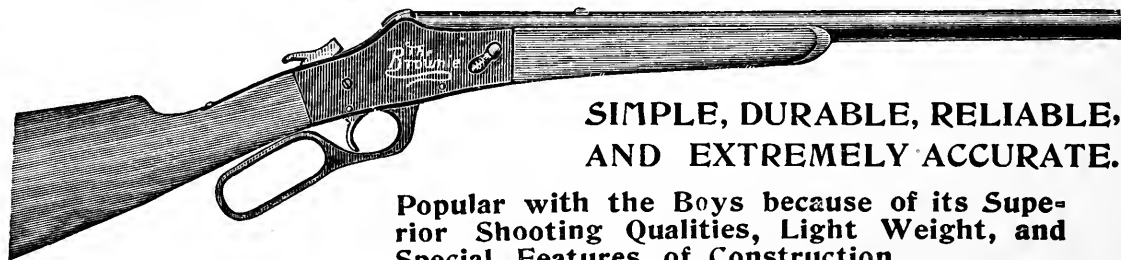

**SIMPLE, DURABLE, RELIABLE,
AND EXTREMELY ACCURATE.**

Popular with the Boys because of its Superior Shooting Qualities, Light Weight, and Special Features of Construction.

Furnished in 22 caliber only. Weight 4 1/4 to 4 1/2 pounds. It is supplied by RECREATION as a Premium. Write for Catalogue

The W. H. Davenport Fire Arms Co., Norwich, Conn.

Guaranteed Not to Shoot Loose**One of the 9****“SYRACUSE”****Built for Business**

DAMASCUS BARRELS

AUTOMATIC EJECTOR

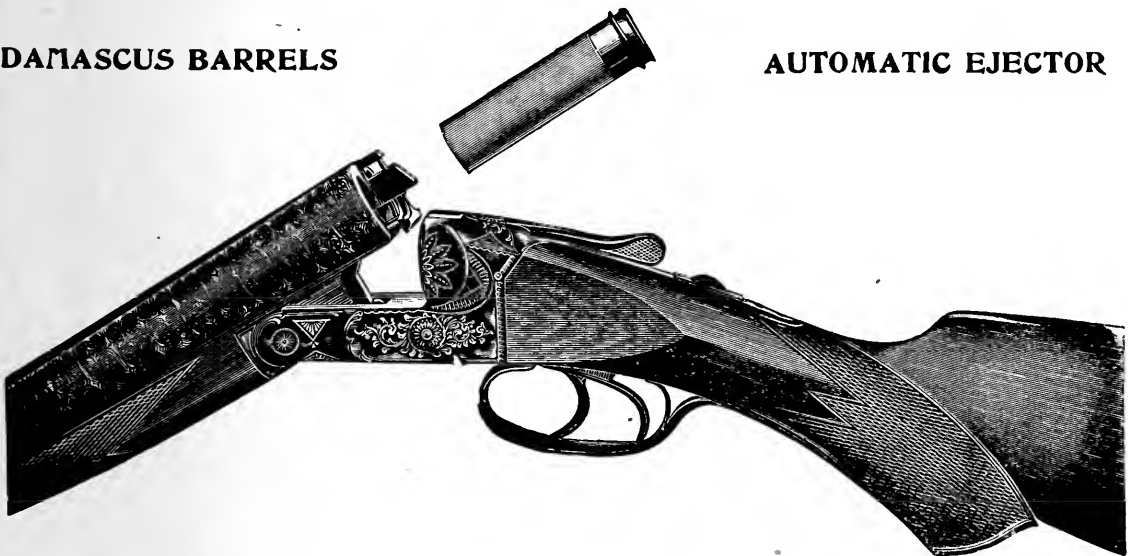
**GRADE 3 EJECTOR****\$60 LIST**

In presenting this gun to your notice, we feel that it is the best value for the money that has ever been offered.

Excellent Damascus barrels, carefully selected, and bored by the particular method that has gained for the “Syracuse” the reputation of being the Hardest Hitting gun made. Stocked with Imported Walnut, Full Pistol Grip, handsomely checkered.

Engraving is hand cut, and gives that finishing touch that proclaims quality.

MADE IN 20, 16 OR 12 GAUGE

SYRACUSE ARMS CO. SYRACUSE, N.Y.



Let Me Convince You

You who are sick and discouraged—
 You who are doctoring without results—
 Be fair with yourselves—ask me for the facts
 Learn how half a million others got well.

What Proof do you Want?

I have 65,000 letters from cured ones, and will send all you care to read.

I have a circular giving the names and addresses of one thousand people *in one city* whom my Restorative has cured in just the past six months. Do you want it?

I have actual records of over half a million chronic cases which I have cured in the past 12 years. Almost every neighborhood in America has its living witnesses to what my Restorative will do. Just ask for evidence and I can overwhelm you with it, for the evidence is everywhere.

My Restorative has made these cures by strengthening the *inside* nerves. It will do that with you. It will bring back the nerve power which alone operates the vital organs. It will give the weak organ power to do its duty.

It does that invariably, and the results are permanent. I speak from a lifetime's experience with diseases that no common treatment cures. It will make you well all over.

A Month on Trial

Simply write me a postal card, stating which book you need. I will then mail you an order on your druggist for six bottles Dr. Shoop's Restorative. You may take it a month at my risk. If it succeeds, the cost is \$5.50. If it fails I will pay the druggist myself. And your mere word shall decide it.

That offer itself is the best evidence of merit that a remedy ever had.

Those who accept it are those who doubt that their cases are reachable. Yet you must know that I cure them, else the offer would ruin me.

Now if you are not well, you need that help. A postal will secure it. All the proofs you want are waiting. Won't you write today?

Simply state which book you want, and address

Dr. Shoop, Box 214,
 Racine, Wis.

Book No. 1 on Dyspepsia.
 Book No. 2 on the Heart.
 Book No. 3 on the Kidneys.
 Book No. 4 for Women.
 Book No. 5 for Men (sealed).
 Book No. 6 on Rheumatism.

Mild cases, not chronic, are often cured by one or two bottles. At all druggists.

E.M.C.

Shot and ... the pleasure of a winter's ... *New Club Nitro* ... are the satisfactory ... ammunition.

The **E.M.C. METALLIC CARTRIDGE CO.**
 BRIDGEPORT, CONN.



Oliver Kerop

Remington Hammerless Gun

FOR **\$25.00** GUARANTEED FOR NITRO POWDERS.



- Grade ... Made with Remington blued steel barrels. **\$25.00**
- Grade ... Made with Damascus barrels and Automatic Ejector, **35.00**

Send for handsome new Catalogue just issued, containing complete description of Guns, \$25.00 to \$750.00. Mailed free.

REMINGTON ARMS COMPANY

ILION, N. Y.

317-7 Broadway, New York. 86-88 First St., San Francisco, Cal.

Sold by All Gun Dealers. No Retailed by the Manufacturers.

Savage Hunting and Target Sight

For All Kinds of SHOOTING and For All Kinds of RIFLES

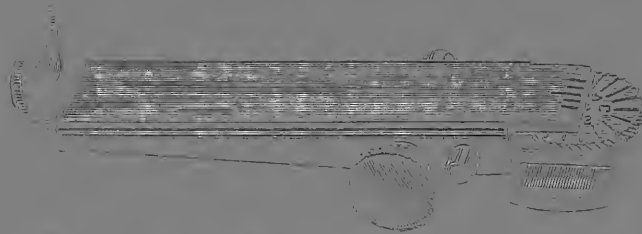

Savage Micrometer Wind Gauge Hunting and Target Sight, No. 21. \$2.00

THIS new departure in the well-known Buck-horn pattern, overcomes all previous sighting difficulties—finely threaded screws allow of adjustment in any direction to one thousandths of an inch. Constructed of the finest materials; simple and strong. Discard your old sight, which neither permits of side adjustment nor of accurate elevation and use a modern sight on a modern rifle. Send for circular.

AND CONVENIENT.

Our new Catalogue E, now in the press, contains full information on the new line of Savage Hammerless Repeating Rifles. Have your name put on the Mailing List.

SAVAGE ARMS COMPANY

LYNCH, N. Y., U. S. A.

READ INSTRUCTIONS
 PREPARED BY
 THE GRAPPE-NUTS
 COMPANY
 100 N. 3rd St. Philadelphia, Pa.
 TRADE MARK
 WARNING: Do not eat Grappe-Nuts if you are
 suffering from any of the following ailments:
 Indigestion, Stomach Trouble, Headache,
 Dizziness, Nervousness, or any other
 ailment of the digestive system.
 SERVE DRY.
 GRAPPE-NUTS
 THE FOOD FOR THOUGHT

Brains
 Repaired
 Taste
 Good

Brains rule the world. Americans have brains. They think big things. They think money. The brain is the tool that does the big things and makes the money.

Brain must be fed on the proper food or it will grow sluggish and dull. Can't work with dull tools. GRAPPE-NUTS, the most scientific food in the world (ask any physician), will strengthen and sharpen the brain.

The stomach is so delicate it will not accept Grappe-Nuts.

Give the brain a chance. Feed it on Grappe-Nuts—

THE FOOD FOR THOUGHT

No Member of your Family should be without an Individual Stick of

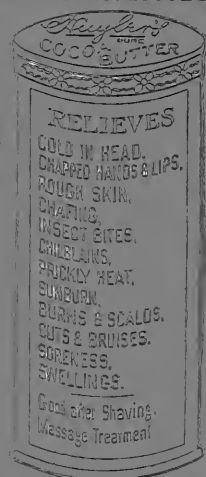

PURE
 COCOA
 BUTTER

RELIEVES
 COLD IN HEAD,
 CHAPPED HANDS & LIPS,
 ROUGH SKIN,
 CHAFING,
 INSECT BITES,
 CHINBLAINS,
 PRICKLY HEAT,
 SUNBURN,
 BURNS & SCALDS,
 CUTS & BRUISES,
 SORENESS,
 SWELLINGS.
 Good after Shaving.
 Massage Treatment

(10¢ POCKET TINS.)

Relieves Colds, Rough Skin,
 Bruises, Soreness &c

ALL DRUGGISTS,

OR BY MAIL
 ON RECEIPT OF PRICE
 IN SILVER OR STAMPS.

Taylor's

363 BROADWAY, N.Y.

VOSE PIANOS

have been established over 50 YEARS. By our system of payments every family in moderate circumstances can own a VOSE piano. We take old instruments in exchange and deliver the new piano in your home free of expense. Write for catalogue D and explanations.

VOSE & SONS PIANO CO., 160 Boylston St., Boston, Mass.

RECREATION

A TALE OF A TRAIL;
By VICTOR SCHOOLMAN, with full page drawing
by WILLIAM SCHUTTE.

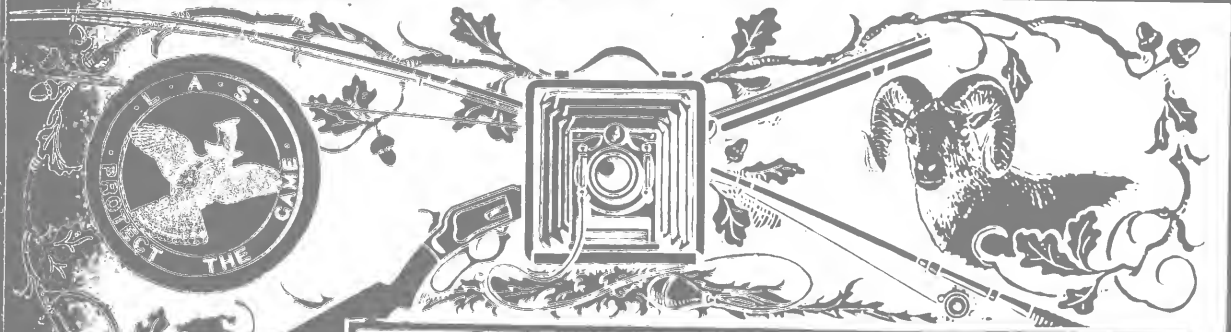

AMATEUR PHOTO BY WM. H. FISHER.
FISH HAWK'S NEST.
One of the 5th Prize Winners in RECREATION'S 7th Annual Photo Competition.

PUBLISHED BY G. O. SHIELDS (COQUINA)
23 WEST 24TH ST., NEW YORK

OFFICIAL ORGAN OF THE LEAGUE OF AMERICAN SPORTSMEN

TOURING IN THE CANADIAN ROCKIES;
By STANLEY WASHBURN, illustrated with photos by the author.

SAVING IS A MART.

Relation of price to quality must be carefully considered. Quantity is also an important factor. Full measure, fair prices, superior quality. On these three points we rest our case.

THE efforts of three generations of one family have been applied to the establishment and rebuilding of our business, which has been successfully conducted for fifty-two years. As a result of these efforts during the past twenty years our sales have increased more than a thousand per cent., good evidence of appreciation by our patrons.

Full measure, fair prices, excellent quality, complete satisfaction guaranteed to each patron every time and all the time is the foundation upon which we have built; is the reason, not the secret, of our success, which is as sure and secure as the operation of any law of nature.

On the basis of such an assurance and such a guarantee to each and every purchaser, we solicit a trial order for 6 full quart bottles of either or any of our special brands.

	Per Gal.		Per Gal.
Holiday Pure Rye (Eleven Years Old),	4.00	Old Bill Bourbon (Eleven Years Old),	\$4.00
Hermitage Rock & Rye Superior	4.00	Newell Port	4.00
Five pounds of rock candy crystals to each gallon of seven year old Hermitage Rye whiskey, is used in the preparation of our Celebrated Rock and Rye.		From Silva & Cosens, Oporto. A choice product of the grape.	
Bon Ton Cocktails	4.00	Rainbow Brandy V.O.	4.00
Martini, Manhattan, Vermouth, Whiskey, Tom. Gin and Holland Gin. Carefully prepared from the choicest materials, perfectly blended.		The product of one of the best American Vineyards, with all the medicinal qualities of French Brandy.	
Ruthven Sherry	4.00	Jupiter Gin	4.00
From Duff, Gordon & Co. Warranted twenty years in the wood before bottling. Rich and fruity.		From the Swan Distillery, Schiedam, Holland, where Good Gin comes from. Tastes differ. Many people appreciate Good Gin. Jupiter is the best the world affords.	
		Medicated Old Rum	4.00
		From Daniel Lawrence & Sons, Medford, Mass.	

The goods are warranted as represented, namely, the best of their class that money can buy or that intelligent, honest endeavor, fortified with long experience, can produce.

On receipt of your order with \$6.00 we will ship 6 full quarts, assorted to suit, transportation charges prepaid, to any railroad point in the United States where the charges for transportation do not exceed \$2.00. You cannot afford to let this chance go by. You never before had as good an offer.

Remit cash in registered letter or by express company or P. O. money order. References: Any bank in Boston, any mercantile agency, or any distiller of importance in the United States.

THE HOUSE OF BROWN, 100 Hanover & Blackstone Sts., BOSTON, MASS.

ESTABLISHED 1851

RECREATION

Copyright, December, 1902, by G. O. Shields

A Monthly Magazine Devoted to Everything the Name Implies

\$1.00 A YEAR.
10 CENTS A COPY.

G. O. SHIELDS (COQUINA),
Editor and Manager.

23 WEST 24TH STREET,
NEW YORK

CONTENTS OF THIS NUMBER

	PAGE
The Wounded Buck Was a Roaring Murderous Force. William Schutte.....	FRONTISPIECE
A Tale of a Trail. Illustrated.....	VICTOR SCHOOLMAN 249
A Song of the Hills. Poem.....	R. S. STRINGFELLOW 255
Ontario's Great Play Ground. Illustrated.....	FRANK YEIGH 257
Hunting in New Mexioo	J. F. FOLEY 260
In Lonely Ways.....	FRANK H. SWEET 262
Touring in the Canadian Rockies. Illustrated.....	STANLEY WASHBURN 263
Some Bear Stories.....	S. N. LEEK 272
The Keiley Glycerine Process. Illustrated.....	K. ROWA 273
The Spring Poets. Poem.....	A. L. VERMILYA 275
A Mashipacong Tragedy. Poem. Illustrated.....	A. C. RUGGERI 276
Why Not? Poem.....	W. H. NELSON 278
From the Game Fields.....	279
Fish and Fishing.....	287
Guns and Ammunition.....	291
Natural History.....	299
The League of American Sportsmen	302
Forestry.....	308
Pure and Impure Foods.....	310
Book Notices.....	313
Publisher's Notes.....	314
Editor's Corner.....	316
Amateur Photography.....	320

Entered as Second-Class Matter at New York Post-Office, Oct, 17, 1894.



TIDINESS
and **COMFORT**
for all men by using
WASHBURNE'S
Cuff Holders

Instantly Attached or Detached.

Sent Prepaid for 20 Cents.
Scarf Holder 10 Cents.
Key Ring and Chain 25 Cents.

They never come loose—a tiny lever with a bulldog grip.

Illustrated Catalogue of others on request.

AMERICAN RING CO., Dept. 44, Waterbury, Conn

Sore Throat

Hoarseness, Quinsy, Tonsillitis
Laryngitis and other throat
troubles quickly relieved
and promptly cured
by the use of

Hydrozone

This scientific germicide is used and endorsed by leading physicians everywhere. It is *absolutely harmless*, yet a most powerful healing agent.

By killing the germs that cause these diseases, without injury to the tissue, Hydrozone cures the patient. Sold by Leading Druggists. If not at yours, will send bottle, prepaid, on receipt of 25 cents.

Prof. Charles Marchand

(Dept. F-59) Prince Street, NEW YORK

20TH CENTURY LAUNCHES



STEAM YACHTS

SAIL YACHTS

ROW BOATS

CANOES

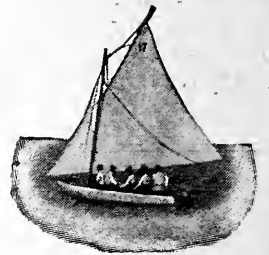
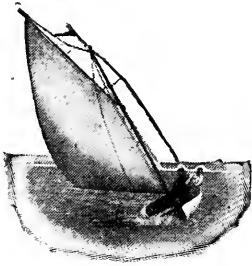

The Ideal Gentleman's Pleasure Craft used at the Pan-American Exposition because they were the best. Elegantly finished, simple, safe, reliable, and speedy. 15 ft. Fishing Launch, \$150. 16 ft. Family Launch, \$200. 35 ft. Cabin Launch, \$1,500. Send 10 cents for 80-page illustrated catalogue giving the truth in detail about the best boats built. Address

RACINE BOAT MFG. CO.

RIVERSIDE, RACINE, WIS.

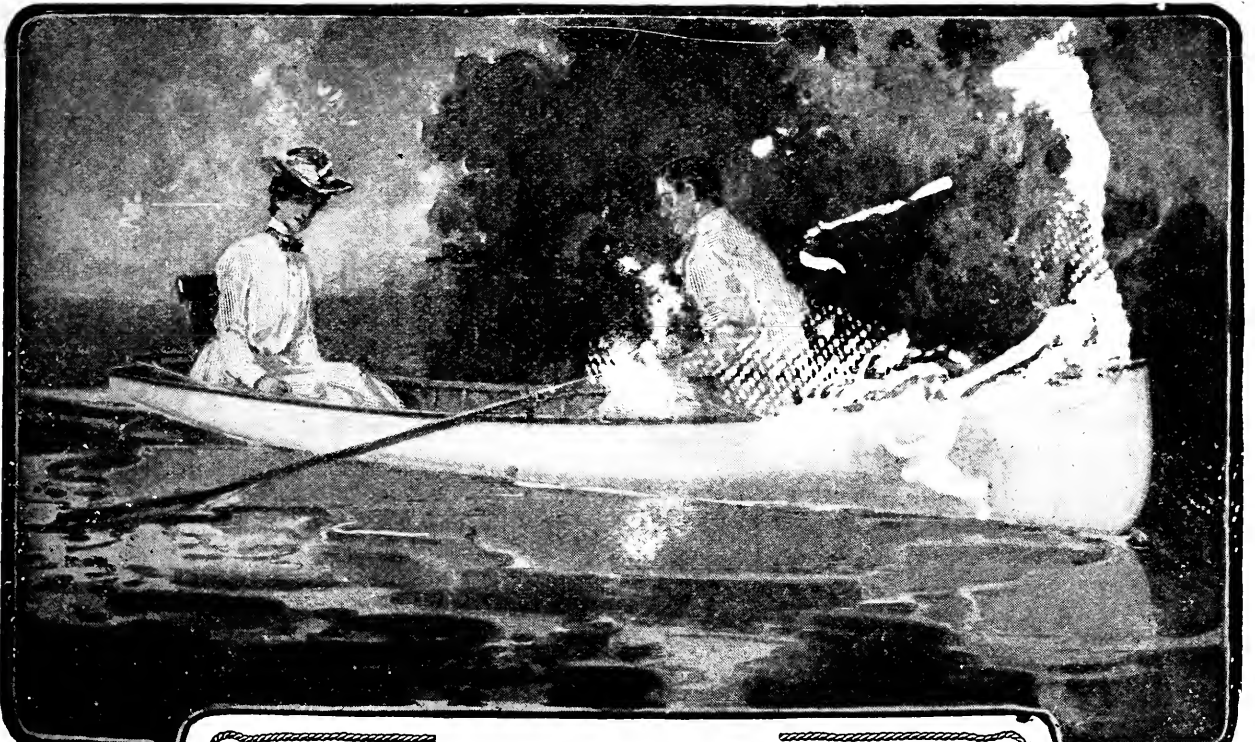

THE OLD WAY

THE BOAT as pictured below in every detail—length $15\frac{1}{2}$ feet, beam 4 feet, with $\frac{3}{4}$ horse-power Blomstrom gasoline engine

\$100

*So simple a child can operate
with entire safety*

Catalogue D, including Marine Gasoline Engines of from $\frac{3}{4}$ to 80 horse-power at corresponding prices, free on request.

THE C. H. BLOMSTROM MOTOR CO.

1284-1294 River Street

Detroit, Mich.

THE NEW WAY





To look out for your comfort
 And make your trips complete,
 When on snow shoes or canoeing
 Or in the dry mesquit,
 When packing through the mountains
 Where they throw the diamond hitch,
 Is the object and the purpose
 Of ABERCROMBIE & FITCH.



We handle all THINGS PRACTICAL,
 To make life a treat,
 For CAMPER and EXPLORER
 When he leaves the busy street.
 The FISHERMAN, PROSPECTOR
 And others of that ilk
 Should try a tent of "Special"
 Or of "Waterproof Silk."

If you don't find what you want
 At once, call our attention,
 And from your pattern and design
 We'll make it as you mention.
 By all means get our catalogue
 And study well our goods
 For it surely will be needed
 In out-fitting for the woods.

Come and see us at our Camp,
 At 314 BROADWAY,
 Which some have called a club-room,
 And see our full display.
 You may perhaps find someone
 With whom a yarn to spin
 For travelers from every clime
 Are frequently dropping in.

WRITE FOR CATALOGUE R

Abercrombie & Fitch

**314 and 316 Broadway
 NEW YORK, U. S. A.**



"Nothing so Rare as Resting on Air"

The Pneumatic Mattress

AN IDEAL BED

"I will have all my mattresses blown up, not stuffed. Down is too hard."—Ben Jonson.

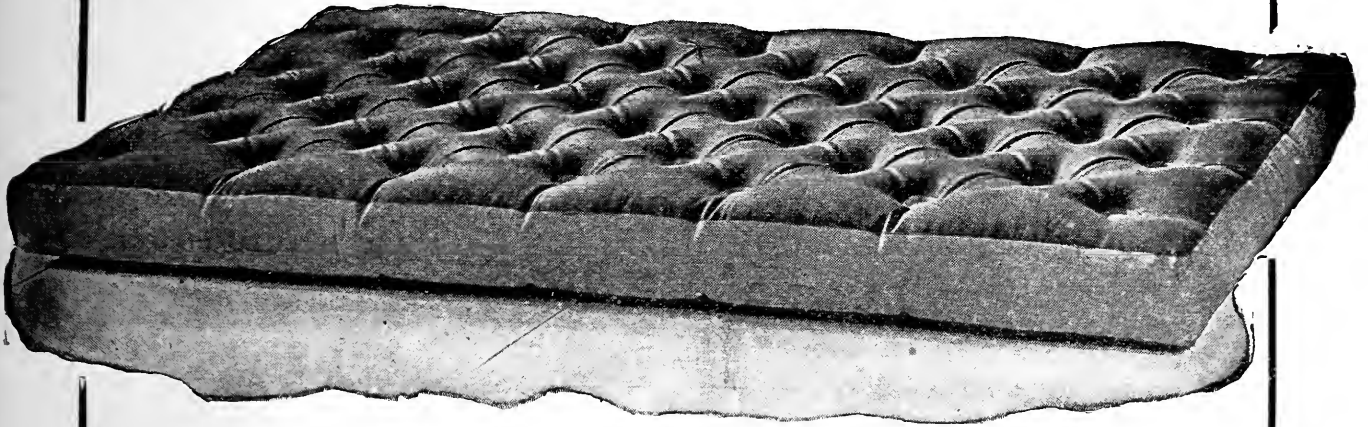

THE PNEUMATIC MATTRESS is as far superior to any other mattress as the pneumatic bicycle tire is superior to the solid tire. It fits the body perfectly. You cannot find an uncomfortable position on the Pneumatic Mattress. It conforms to all positions of the body, thereby resting all parts equally. Did you ever think how unsanitary the ordinary hair, wool or other mattress is? All the perspiration from the body permeates the substance of the mattress and *remains there*. No amount of airing will remove any disease germs that may have lodged there. Nothing can enter the Air Mattress. **It is the only sanitary mattress in existence.** There is no place for dust to lodge; there is no home for vermin. The Pneumatic Mattress need no turning, as **air never mats down.** It is always smooth and requires no manipulation to take out the inequalities. No odor, and never musty. It can be regulated to any degree of hardness or softness by admitting or expelling a little air. It weighs when deflated about 18 pounds.

We make these mattresses in three sizes: $\frac{1}{2}$, $\frac{3}{4}$ and full size; the latter is also made in two parts divided lengthwise in center; thus if two people sleep together and one wants a hard bed, the other a soft bed, both can be accommodated.

No springs are required with the Air Mattress; we furnish iron slats for iron beds. It should rest on ordinary wood slats on wood beds.

Durability: The air sack is protected by a covering of the best quality ticking. With ordinary care this mattress will last a lifetime. Should it by any accident become punctured it can be easily repaired.

FREE TRIAL So sure are we that this mattress will give universal satisfaction that we will send you one and allow you to use it **THIRTY NIGHTS.** If you do not find it the **best mattress you ever slept on**, or do not like it for any reason, return it and we will refund your money and pay shipping charges both ways. Price \$22.00 up according to size, including air pump and slats. Delivered free.

This Offer Does Not Apply to Mattresses Used in Camp.

"I plainly see that you have gotten me into trouble over those *air mattresses*, as my wife is already fascinated with them, and I myself, am inclined to think we cannot get along without them."
J. S. TICHENOR, Sec'y Naval Y. M. C. A., Sept. 11th, 1902.

"I find the *mattress* as you represent it. I find it a great joy and comfort. My hair mattress is nothing compared with your *Pneumatic* for sleeping. My friends admire it very much, and tell me they will order for themselves."
W. M. NEVITT, Bozeman, Mont., July 1st, 1902.

"After my boat, 'Azalea,' went out of commission last fall, I sent the *mattress* had of you home; and now the women folks won't let me take it away, and so will have to ask you to send another *mattress* of same size."
COL. FRED'K G. AGEUS, Newark, N. J., May 13th, 1902.

Our illustrated booklet, "Evolution of the Air Bed" and Catalog of Pneumatic Cushions, Pillows, Yacht Cushions, etc., sent free on request.

PNEUMATIC MATTRESS & CUSHION CO.,

2 R, SOUTH STREET, NEW YORK, N. Y., U. S. A.

Decorate Your Den

With a set of the most beautiful
Hunting and Fishing Pictures
 ever made.

15 Plates. Size for Framing, 18 x 24 inches

SUBJECTS:

ELK HUNTING	SALMON FISHING	} HY. SANDHAM
MOOSE HUNTING	TROUT FISHING	

MALLARD SHOOTING — BLACK BASS FISHING — C. E. DENTON

TARPON FISHING — BLUE FISHING — FRED. S. COZZENS

ANTELOPE HUNTING — GOOSE SHOOTING — FRED REMINGTON

GROUSE SHOOTING — WILD TURKEY HUNTING — R. F. ZOGBAUM

MUSKALONGE FISHING — F. H. TAYLOR

DEER HUNTING — A. B. FROST

ROCKY MOUNTAIN SHEEP HUNTING — E. KNOBEL

These 15 plates are lithographed in the true colors of nature and altogether make one of the finest series of pictures of outdoor sports ever published.

ORIGINALLY ISSUED AT \$50 A SET

I have bought the last of them and can furnish a complete set for 15 yearly subscriptions to RECREATION,

Or will Sell at \$10 a Set

I also have enlargements of the following photographs:

ROCKY MOUNTAIN GOATS

Published on pages 90, 91, 92, and 93 of the February issue of RECREATION,
 \$5 a set.

WOOD DUCK SHOOTING

Published on page 95 of the February issue of RECREATION, \$1.50 each.

Address: RECREATION, 23 West 24th Street, New York City

A Canadian Trout Pool

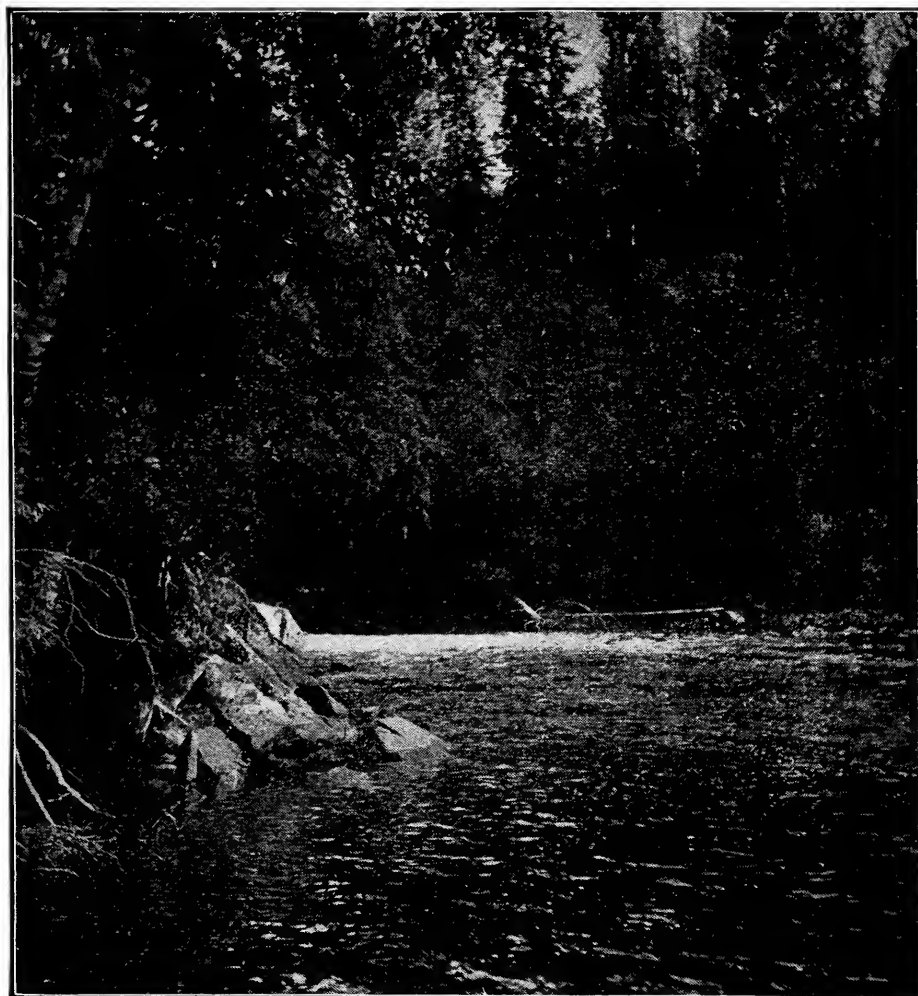

Once more the wild, game trout of the Canadian wilderness are lawful prizes.

Spring has come, and from the Gulf of St. Lawrence to Superior the icy bonds of winter are melting away.

It will soon be time for the fishermen to be up and doing.

OPEN SEASONS

New Brunswick	-	-	-	-	April	1 to September	30
Quebec	-	-	-	-	May	1 to October	30
Ontario	-	-	-	-	May	1 to September	14
British Columbia	-	-	-	-	March 16 to October		14

Trustworthy information as to fishing resorts will be furnished by any Agent of the

CANADIAN PACIFIC RAILWAY,

OR BY

ROBERT KERR, *Passenger Traffic Manager*, MONTREAL



DELAWARE WATER GAP

**Lackawanna
Railroad**

In the Blue Ridge Mountains of Pennsylvania, surrounded by delightful resorts at Stroudsburg and throughout the Delaware Valley; an ideal region for spring and summer. A beautifully illustrated book describing these resorts and containing a fascinating love story entitled "For Reasons of State," will be sent on receipt of 4 cents in stamps. Address T. W. LEE, General Passenger Agent, Lackawanna Railroad, New York City.

1
J. Wright

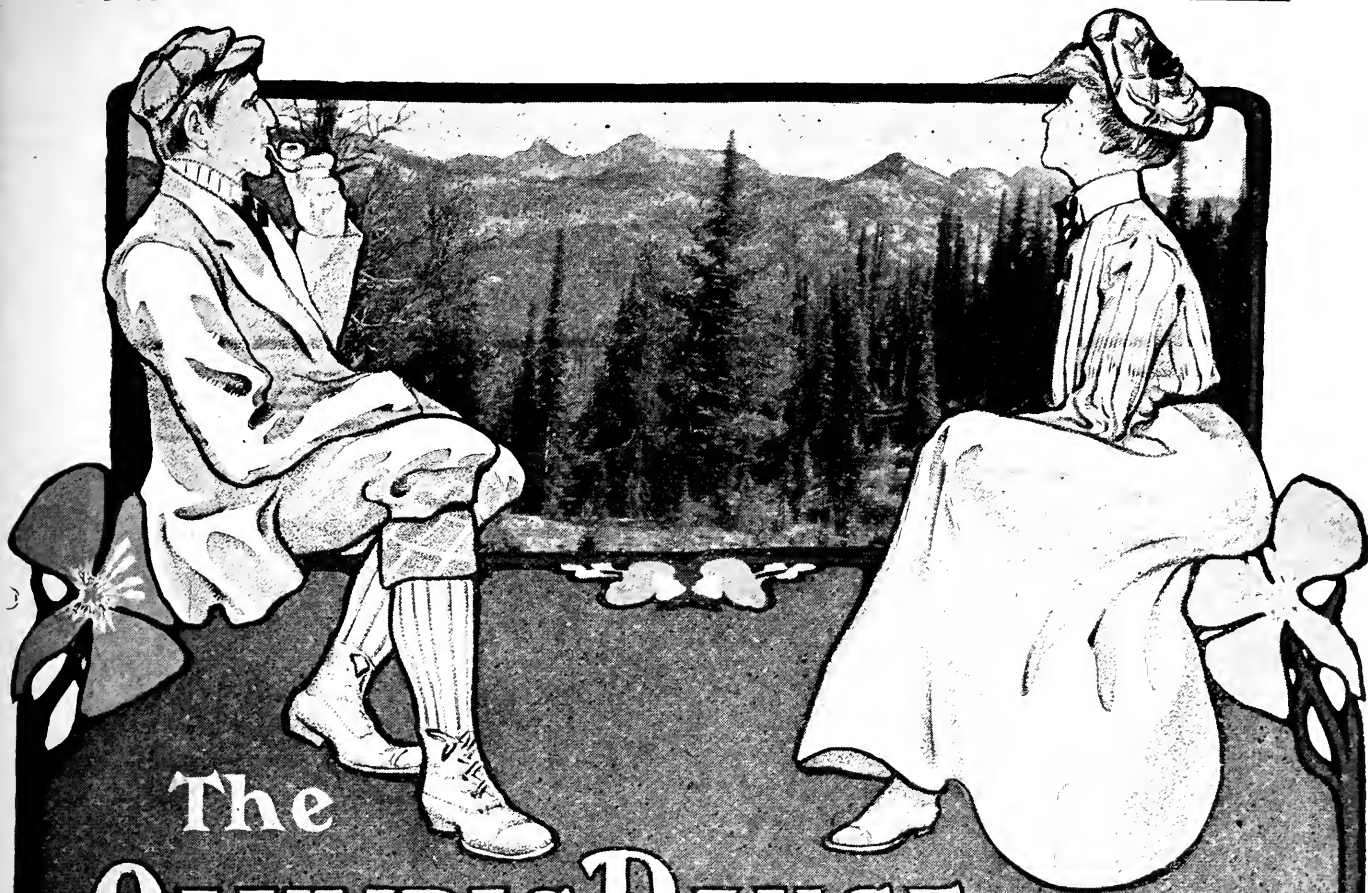

The
OLYMPIC RANGE
 and **PUGET SOUND**

will satisfy either for **ORDINARY RECREATION** or for **HUNTING** or **FISHING** or **MOUNTAINEERING**
It isn't the stereotyped thing.

"WONDERLAND 1903"
elaborates its advantages.
Send for it, - only SIX CENTS.

CHAS. S. FEE,
 GEN. PASS'GR AGENT



ST. PAUL,
MINNESOTA.

HERE IS A CHANCE

To Join a Club that Will Always Have
PLENTY OF GAME,
PLENTY OF BROOK TROUT,
and PLENTY OF BLACK BASS

ON ITS OWN PROPERTY.

Only 6 hours from New York City, 3 hours from Boston

20,000 acres of land, to be abundantly stocked with game of various kinds
15 miles of trout streams to be stocked with trout.

Thousands of acres of lakes and ponds, to be stocked with black bass.

PINE FORESTS RICH IN OZONE

Hardwood forests, which are the natural home of the deer, and ruffed grouse.

Old, abandoned farms, which will furnish ideal cover for thousands of quail

Golf grounds, polo grounds, tennis grounds, baseball grounds,

Fine roads for riding, driving, and automobiling.

Pure air, pure water, delightful scenery.

Address

L. A. TILLINGHAST

275 Westminster Street

Providence, R. I.

A SUMMER PARADISE

**GRAND
TRUNK
RAILWAY
SYSTEM**



HIGHLANDS OF ONTARIO

1000 FEET ABOVE SEA LEVEL.
**MOST CHARMING SUMMER
 RESORTS IN AMERICA**
 INCLUDING
**MUSKOKA LAKES
 LAKE OF BAYS
 MAGNETAWAN RIVER
 30,000 ISLANDS OF GEORGIAN
 BAY
 KAWARTHA LAKES
 LAKES SIMCOE
 AND COUCHICHING
 LAKE NIPISSING
 AND FRENCH RIVER**

EASY OF ACCESS. PERFECT IMMUNITY FROM HAY FEVER.
 GOOD HOTEL ACCOMMODATIONS.
 RATES TO SUIT ALL POCKETS.

THE "ROYAL MUSKOKA"
 FINEST SUMMER HOTEL IN CANADA.

FREE ILLUSTRATED PUBLICATIONS

CAN BE HAD FROM GRAND TRUNK RAILWAY
SYSTEM. ADDRESS NEAREST OFFICE.

- | | | |
|---------------------|-------------------|--------------------------------------|
| BOSTON, MASS. | T. W. Byrne | 298 Washington Street |
| BUFFALO, N. Y. | Chas. L. Cochrane | 265 Main St. (Hillcott Square Bldg.) |
| CHICAGO, ILL. | G. W. Vaux | 517 Merchants Loan and Trust Bldg. |
| | J. H. Burgess | 215 Clark St. cor. Jackson Louvard |
| DETROIT, MICH. | G. W. Watson | 124 Woodward Avenue |
| LOS ANGELES, CAL. | W. H. Butler | 205 Wilcox Building |
| MONTREAL, QUE. | J. Quilley | Bonaventure Station |
| | E. W. H. Clancy | 137 24 Fabre Street |
| NEW YORK, N. Y. | F. P. Dwyer | Dun Building, 290 Broadway |
| SAN FRANCISCO, CAL. | W. O. Johnson | 12 Front Street |
| ST. PAUL, MINN. | David Brown, Jr. | 111 Eastcott Arcade |
| | J. D. McDonald | Union Station |
| TORONTO, ONT. | J. W. Ryder | N. W. cor. King and Yonge streets |

OR TO G. T. BELL,
 GENERAL PASSENGER AND TICKET AGENT.
MONTREAL, CANADA.

MENTION THIS MAGAZINE.



Grand Canyon of Arizona

Pictures of it: For 25 cents will send the season's novelty—a Grand Canyon photochrome view, uniquely mounted for desk use; accurately reproduces the Canyon tints. Or, for same price, a set of four black-and-white prints, ready for framing.

Books about it: For 50 cents will send a Grand Canyon book, 128 pages, 93 illustrations, map and cover in colors; contains articles by noted authors, travelers and scientists. Worthy a place in any library. Or will mail free pamphlet, "Titan of Chasms."

Visit it: Take the Santa Fe for California. Stop off at Williams, Ariz., and go by rail only 64 miles to Grand Canyon. Stay there one, two or more days. You have seen Earth's greatest wonder, the titan of chasms, a mile deep, many miles wide.

General Passenger Office
Atchison, Topeka & Santa Fe Railway
1324 Great Northern B'ld'g, Chicago

Santa Fe

"The Busy Man's Train."

Appropriate in its Name,

Appropriate in its Route,

Appropriate in its Character —

"THE 20th CENTURY LIMITED."

This is *The Century* of all the ages. The New York Central's 20-hour train between New York and Chicago (the two great commercial centres of America) is *The* train of the century, and is appropriately named

"THE 20th CENTURY LIMITED."

A copy of the "Four-Track News," containing a picture of "The 20th Century Limited," and a deal of useful information regarding places to visit, modes of travel, etc., will be sent free, postpaid, on receipt of five cents, by George H. Daniels, General Passenger Agent, New York Central, Grand Central Station, New York.

"Big Four"

The
World's Fair Route

From the

Leading Cities of
Ohio, Indiana
and Illinois

To

St. Louis

Write for Folders.

Warren J. Lynch,
Gen'l Pass. Agt.

W. P. Deppe,
Ass't Gen'l P. A.

CINCINNATI, OHIO.



SEEING THE SIGHTS

of San Francisco's Chinatown, with a Guide, is a novel experience. It is perfectly safe and proper, too, but is only one of thousands of equally entertaining possibilities of a California trip. The Springtime is California's most attractive and Healthful season. **GO NOW!** The journey is accomplished with comfort and safety, if you place yourself in the hands of the expert attendants on the

Golden State Limited.

Newest and most luxurious of transcontinental trains.

Leaves Chicago daily at 7.45 P.M., Kansas City at 10.40 A. M. Less than three days to Los Angeles. Through cars to Pasadena, Los Angeles, Santa Barbara and San Francisco. Lowest altitudes and most southerly course of any line across the continent. Compartment and standard sleeping cars; dining, buffet-library and observation cars. Electric lights; electric fans; daily market reports, bath; barber.

Route: Rock Island and El Paso-Northeastern Systems, Chicago to El Paso; Southern Pacific Company, El Paso to Los Angeles and San Francisco.

Tickets and full information at all railroad ticket offices in the United States and Canada. Beautifully illustrated literature descriptive of California sent on receipt of six cents in stamps.

JOHN SEBASTIAN, Passenger Traffic Manager, Rock Island System, Chicago, Ill.



"FOR 34 YEARS A STANDARD PIANO."

THE WING PIANO

YOU NEED THIS BOOK IF YOU INTEND TO BUY A PIANO. A book —not a catalogue—that gives you all the information possessed by experts. It makes the selection of a piano easy. If read carefully, it will make you a judge of tone, action, workmanship, and finish; will tell you how to know good from bad. It describes the materials used; gives pictures of all the different parts, and tells how they should be made and put together. It is the only book of its kind ever published. It contains 116 large pages, and is named "**The Book of Complete Information About Pianos.**" We send it free to anyone wishing to buy a piano. Write for it.

SAVE FROM \$100 TO \$200 We make the WING PIANO and sell it ourselves. It goes direct from our factory to your home. We do not employ any agents or salesmen. When you buy the WING PIANO you pay the actual cost of construction and our small wholesale profit. This profit is small because we sell thousands of pianos yearly. Most retail stores sell no more than twelve to twenty pianos yearly, and must charge from \$100 to \$200 profit on each. They can't help it.

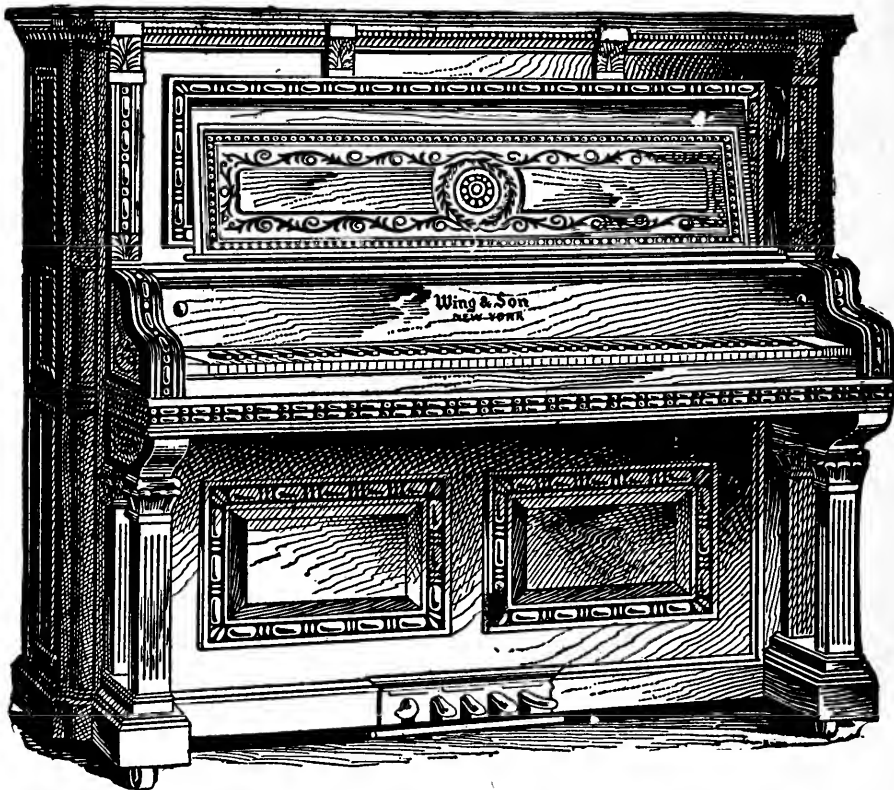

A Wing style—45 other styles to select from.

SENT ON TRIAL WE PAY FREIGHT. NO MONEY IN ADVANCE. We will send any WING PIANO to any part of the United States on trial. We pay freight in advance and do not ask for any advance payment or deposit. If the piano is not satisfactory *after twenty days' trial in your home, we take it back entirely at our expense.* You pay us nothing unless you keep the piano. There is absolutely no risk or expense to you.

Old instruments taken in exchange.

EASY MONTHLY PAYMENTS.

INSTRUMENTAL ATTACHMENT A special feature of the Wing Piano; it imitates perfectly the tones of the mandolin, guitar, harp, zither and banjo.

IN 34 YEARS 33,000 PIANOS We refer to over 33,000 satisfied purchasers in every part of the United States. WING PIANOS are guaranteed for twelve years against any defect in tone, action, workmanship, or material.

WING ORGANS Are just as carefully made as Wing Pianos. They have a sweet, powerful, lasting tone, easy action, very handsome appearance, need no tuning. Wing Organs are sold direct from the factory, sent on trial; are sold on easy monthly payments. For catalogue and prices write to

WING & SON, 226 and 228 East 12th St.,
NEW YORK.

1868—35th Year—1903.

SERGEANTS' CONDITION PILLS

POLK MILLER DRUG CO.

IS SYNONYMOUS WITH

DOG REMEDIES.

SERGEANT'S CONDITION PILLS have to do especially with the health of a dog.

Every dog should be in a healthful state—just as much so as a person. You can't expect a dog to work right in the field, stud or bench show if he is ailing. He is bound to ail; just as much as human beings, and they you know, are always ailing—either through neglect, change, confinement, accident or over-work.

You will find a dog bothered just as much as a person when it comes to sickness.

SERGEANT'S CONDITION PILLS do for a dog what thousands of good remedies do for a man—they cure.

They will cure the dog of Indigestion, Nervousness, General Debility, Sleeplessness, Fretfulness, Meanness, Chills, Fever, Ague, Mange, Distemper, Chronic Dyspepsia, Anaemia, Catarrh, Short Sightedness, and Loss of Scent.

SERGEANT'S CONDITION PILLS build a dog up.

They put life into a dog, eradicate all weariness, physic and strengthen him.

The only difference in this medicine for dogs and that made for man is, that it is made of a formula stronger in its ingredients, for, when it comes to medicine a dog can stand more than man.

SERGEANT'S CONDITION PILLS cost 50c. and \$1.00 per box at Druggists or by mail (prepaid) from

POLK MILLER DRUG CO.,

RICHMOND, VIRGINIA, BOX 217.

There isn't anywhere a dog lover or owner who wouldn't like to have our 48 page Treatise on Dogs. We will send it and a Pedigree Blank to any address for 3 cents in stamps, which go to pay the postage.



Small, illegible text at the bottom of the illustration, possibly a printer's mark or copyright notice.

ONLY A DOLLAR.

SPECIAL TRIAL OFFER.

We are willing to lose money on your first order, simply to get you to try HAYNER WHISKEY, for we know you will be pleased if you only once try it. This is our offer: We will send you in a plain sealed box, no marks to show what's inside, ONE FULL QUART BOTTLE of HAYNER'S SEVEN-YEAR-OLD RYE for \$1.00, and we will pay the express charges. Try it and if you don't find it all right and as good as you ever used or can buy from anybody else at any price, then send it back at our expense and your dollar will be returned to you at once. That's fair, isn't it? We stand all the expense, if you are not satisfied. You risk nothing. We ship one quart on your first or trial order only. All subsequent orders must be for at least 4 quarts at 80 cents a quart, express prepaid. The packing and express charges are almost as much for one quart as for four, and even at \$1.00 for one quart, express prepaid, we lose money, but we want you to try it.

Trial orders for Ariz., Cal., Col., Idaho, Mont., Nev., N. Mex., Ore., Utah, Wash., or Wyo., must be 1 QUART for \$1.25 by EXPRESS PREPAID. Subsequent orders on the basis of 4 QUARTS for \$4.00 by EXPRESS PREPAID or 20 QUARTS for \$16.00 by FREIGHT PREPAID.

HAYNER WHISKEY

1 FULL QUART \$1.00
EXPRESS CHARGES PAID BY US.

It takes 5 of the ordinary "quart" bottles to make a gallon, but a HAYNER QUART is a full quart, an honest quart of 32 ounces, 4 to the gallon. Now you pay your dealer at least \$1.50 a bottle or \$7.50 a gallon for whiskey that cannot be any better than HAYNER, if as good. We sell you 25 per cent more whiskey for \$1.00 than you get from your dealer for \$1.50, for our bottles are one-fourth larger, or at the rate of 80 cents for as much whiskey as you have been getting for \$1.50. Why, then, pay your dealer two prices? And you save much more when you buy 4 quarts for \$3.20. You save \$4.30. Try HAYNER WHISKEY. It goes direct from our own distillery to you, carries a UNITED STATES REGISTERED DISTILLER'S GUARANTEE OF PURITY and AGE and saves you the dealers' enormous profits. We have nearly half a million satisfied customers and want a million more. That's why we make YOU this special trial offer of 1 quart for \$1.00, express prepaid. Your money back if you're not satisfied. Write our nearest office NOW.



ESTABLISHED
1866.

THE HAYNER DISTILLING COMPANY,

DISTILLERY,
TROY, OHIO.

DAYTON, OHIO.

ST. LOUIS, MO.

ST. PAUL, MINN.

ATLANTA, GA.

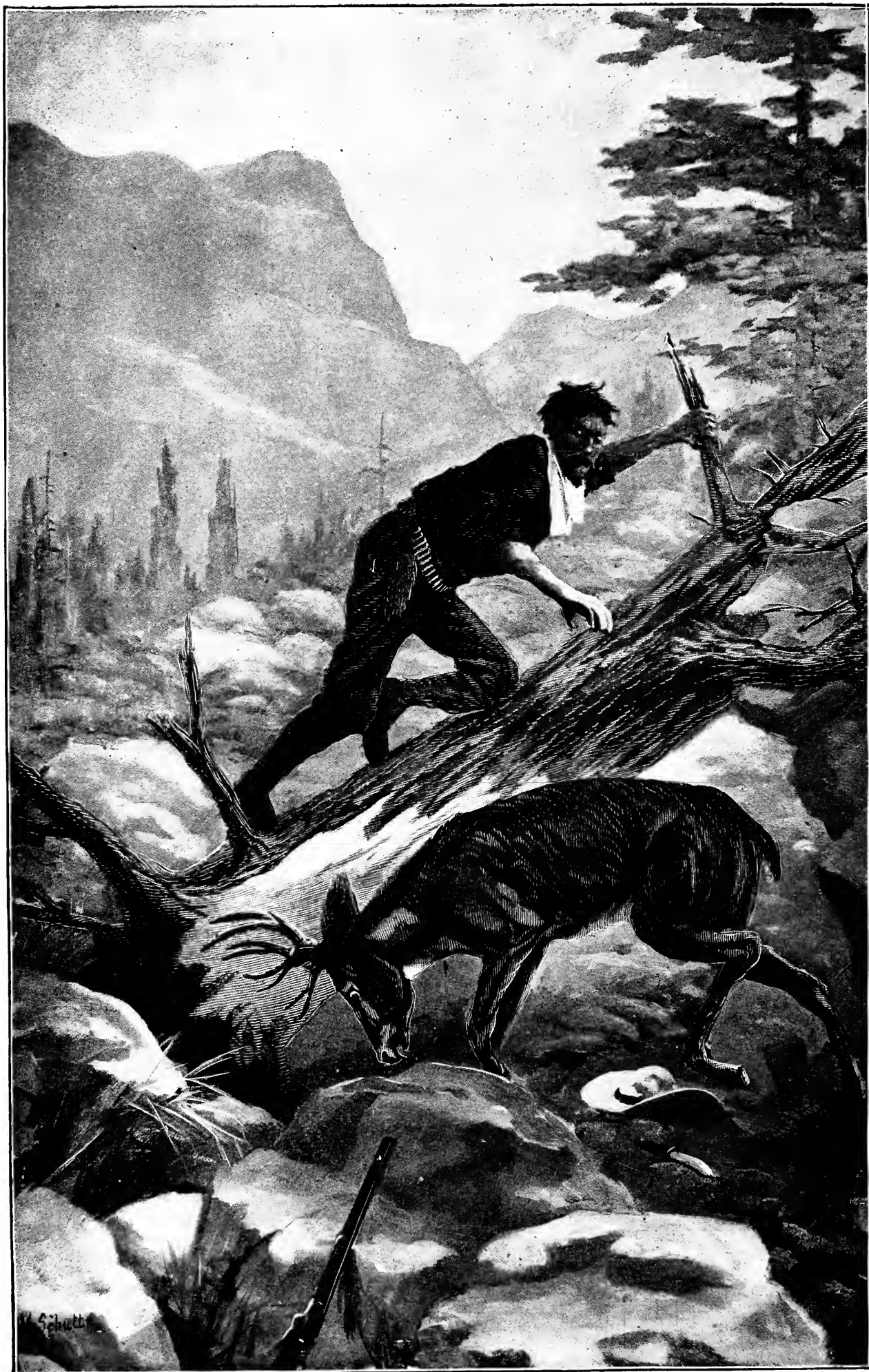

THE WOUNDED BUCK WAS A ROARING, MURDEROUS FORCE.

RECREATION

Volume XVIII.

APRIL, 1903.

Number 4.

G. O. SHIELDS (COQUINA,) Editor and Manager

A TALE OF A TRAIL.

VICTOR SCHOOLMAN.

RECREATION is a veritable storehouse of veritable tales. Some of the stories of prowess, luck and skill are enough to drive us of less experience, or poorer imaginations, to seek some spot in the remote recesses of darkest limbo where we could sit down in eternal silence and seclusion. While we of this brotherhood can not boast of the skill that enables the modern miracle-maker to kill grouse, sheep, deer, elk and the roaring grizzly with his terrible .22, nor of the kind fate that brought the Indian and the white man safely out of the jaws of the white wolf of the North, yet the jovial goddess of the rocks and wilds has sometimes mounted her moon-car for the delectation of some of us; and that we might not go down to our last level wholly without experience has brought confusion to the wisest of the killers, that we in turn might smile.

Back in the 80's the possession of a little cash had put me as far away from Chicago as Trinidad, Colo., and the subsequent absence of that same useful source of many evils bade fair to keep me thereabout. After a week or 2 of ups and a month or so of downs, I finally fell in with Joe. Driven from his Kentucky home in '61 because of his Southern sympathies, under suspicion by his Southern companions because he was the son of an abolitionist family, he was naturally forced into companionships of his own forming. A guerilla during the war, an outcast after it, he drifted into the Rockies and became a hunter. He lived not in the cities, neither loved he their ways. In fact, he had but little

taste for aught in civilization but its whiskey. For that, and certain other necessaries, as shells, tobacco, bacon, etc., he emerged from his haunts in the mountains of Northern New Mexico, as the meagerness of his supplies or the largeness of his thirst demanded. It is needless to say this thirst was seldom quenched.

It was toward the close of his month's spree that I found him. He had just shot a brakeman and was preparing to wipe out a ranchman, when Jim Harris, the marshal, hove in sight. Joe promptly hoisted the flag of truce when he saw Harris. He knew Harris always meant business. Harris also knew that Joe was old business himself when occasion demanded; so the only further matter transacted at that time was to call me to place Joe in the tender care of Dr. Smith. After a week's work the doctor got the snakes chased out of Joe's system sufficiently to start him home in my company as official druggist. In that capacity I administered to him the proper powders and doled out the fixed quantities of fluid said by Smith to be essential to Joe's well-being. About 9 o'clock in the morning of the third day out, shortly after we had left a mining camp along the Chicorica, a little, noisy stream that tumbled about and sassed the trout that essayed to keep it company, a rabbit crossed the trail ahead and broke for the rocks. I quickly unslung a .44 Winchester from the saddle, and remarking that a little rabbit broth would be a good thing for a certain stomach I knew of, I banged away at Mr. Rabbit and

killed him. Full 90 yards and shot plump through the head. That was not chance; it was luck. As I had the sense not to show surprise at the shot, but simply to bring in the rabbit, Joe, in his still uncertain state of repair, somehow came to believe I really could shoot. Straightway I had a rousing invitation to go home with him, and stay as long as I cared. The invitation was not overlooked. I went; I stayed 5 months.

Joe's cabin was a 3-room affair; supply room, sleeping room, living room. It was built in a modest valley that had little to do but attend to its natural growth and listen to the tales of the mountains that the noisy Chicorica was continually humming. To the North rose the immense peaks of the Rockies; to the South the hills died away until lost in the semi-flats, miles below. About 14 miles to the Northeast was the divide, a favorite range for deer and bear, a playground for bobcats, and occasionally the transient home of some roving mountain lion.

The dogs were Shep and Nigger. Shep was called Shep principally because he was not a shepherd. Nig had a streak of bloodhound in him, somewhere removed in a remote generation. Shep was a still hunter out of decency, for Nig would have kept the average right for a dozen barkless dogs. To these dogs I always took off my hat. I could not help it. Their great fund of knowledge charmed me; their good nature won me; their dog dignity demanded my respect. To enumerate all the things these dogs did would require a volume. It is not, though, my purpose to tell what the dogs did, but to tell one or 2 things we did, as when we killed the bear. In these affairs Joe was the principal actor and I figured rather as a supernumerary.

We always reloaded our shells; a matter of economy and necessity. We enjoyed many an hour at target practice, and always at moving or flying objects. Sometimes we loaded shot

into the shells. Joe had no fears of leading. Shooting out the rifles, and the hundred and one other fears of the rifle crank, were unknown to him. With these improvised shot shells we at times did great damage to the jays and the magpies that made a business of getting too intimate with the strips of venison we were sun-curing. The birds had not been invited, anyway. Early one morning, following an evening's business with Mr. Jay, we started after deer. Joe went up the trail to the right of the ridge. I took the trail to the left. The dogs were left in the cabin. We intended to meet at a given place on the divide, make camp and come home by way of the East the next day.

About 10 o'clock I had an extraordinary feeling that I ought to cross over and take the trail with Joe. I could not throw it off. It was what the boys call a "hunch." Taking advantage of the first break in the range that afforded signs of a crossing, I obeyed the hunch. After 3 hours or more of climbing, falling, and tearing through brush, I emerged on the right side of the ridge, but considerably above the trail. While sitting on a rocky ledge trying to figure how to strike the trail below without tumbling on my head, and not reaching any satisfactory conclusion, I noticed, about 200 yards below, a great pine tree uprooted. It had fallen in such a manner that the mass of roots had blocked the trail almost completely. The trunk formed a sort of dry-weather foot-log. Along that trunk, and up and down the rough ladder of the roots, I shortly saw enacted the greatest serio-comic, semi-tragic, high and lofty tumbling act of my whole life.

Joe had been following the trail according to program. No hunch had come to bother him. No startling thing had happened either to disturb his thoughts or to break the silence of the mountains. It so happened that a big buck was enjoying the same delightful day, and, unscared by the

presence of man and lulled into gentleness by the silence, was strolling down the trail at the same time Joe was going up. Finding himself blocked in his journey down the mountain, and being in the neighborhood of good browsing, he did not worry much because of finding the way blocked. When I first saw him, shortly after my arrival at the ledge, he was busily engaged in foraging. He seemed so contented that I had not the heart to interrupt him. I, myself, was quite contented at the time. The rest the magnificent view, the rare opportunity of studying a wild animal at close range, all contributed. Besides, I had seen Joe coming down below the tree, and I was anxious to see what would happen if he and the buck should meet face to face. Joe shortly appeared on the up side, and, emitting a grunt, proceeded to acquaint himself with the surroundings. The deer and the intruder became surprisedly conscious of each other's presence at the same instant. As with a pendulum swinging to and fro there is always a time when there is no motion, so when we are suddenly surprised we are for a moment paralyzed into helplessness. This condition lasts till the nerves have adjusted themselves to the new conditions. Joe's recovery was quicker than the deer's. Before he could gather his strength for a spring, Joe fired, and the buck, struck fairly in the forehead, fell instantly.

Up to that point the affair was ordinary. From me it provoked little more than a sigh, and from Joe's direction I imagined I heard a faint grunt of satisfaction. I am not sure of that, but I do know he leaned his gun, a .45-70 Winchester, against the roots and in the coolest possible manner drew his knife to slit the gullet of the helpless quarry. No sooner had the keen knife-point entered the deer's skin than there was a shift in the scenes and something doing. The buck leaped into life. Snorting with pain and rage, with a dash of his

horns he hurled the knife far down the rocks. Joe himself was thrown against the root mass with a force so great as to cause him to scratch gravel for a higher perch faster than he had ever shinned into a tree.

By that time I had a growing interest in the proceedings. When I reached the scene I found Joe, hatless, perched among the topmost roots, the Winchester on the ground, the buck pawing at the rocks and tearing the earth viciously with his horns. All I had ever heard about the "mild and gentle gleam of the placid, tender eye," the pathos of the sandhill stag and other stags too numerous to mention, vanished right there; went up the stump with Joe, as it were. The wounded buck was a roaring, murderous force, threatening general destruction. If that was just a common mad of the ordinary buck, I beg to be excused from offering myself for any personal encounters with him.

I lay up there more than an hour, peering over the ledge at the semi-comedy, semi-tragedy being enacted below. The buck seemed to pine for Joe, and Joe appeared to be pining for his gun. Knife gone, no revolver, it looked like a clean case of Joey get your gun or it is all off.

The buck seemed to be insanely possessed with the desire to fight. He clambered on the trunk of the tree, went up to the roots and made vicious efforts to attack Joe, who climbed down on the other side, thinking to get his gun. As soon as his head disappeared over the top of the mass, the buck leaped down and rushed around the base, snorting and pawing. Once Joe barely reached the gun, but had no time to use it. In fact, he dropped it quicker than lightning, and began to kick dirt for his perch in the roots. He barely made it, even at the expense of a considerable slit running Nor' by Nor'east across his trousers. This game of "you chase me and I'll chase my gun" was getting to be serious business. Without the gun the old

man was helpless, and it was fast becoming evident that he could devise no means of reaching it without exposing himself to a sure and horrible death. He finally began to call for help. Why, I do not know, as I was supposed to be miles away and no one else was known to be in the mountains. He did not call long at a time, for the buck chased him off his perch as regularly as he put himself on it.

The whole thing was so funny, though so serious and dangerous, that I almost fell off my ledge during paroxysms of laughter. Why we are such heathen you must explain, as you and I both have many times laughed long and loud at the serious misfortunes of our friends. The old man's face was a study. He himself, in spite of his pains, in spite of his wearying limbs, sometimes laughed. Sometimes he cried, but oftener he swore; not the weak oaths of an effete civilization, but good, plain, old fashioned, next-to-nature oaths, trimmed with all the grandeur and massiveness of the surroundings; great round oaths that rolled out from the fullness of the heart; that, leaping from stone to stone, broke into a thousand echoes as they were lost in the canyon below; oaths that carried conviction. Verily such swearing was not the ejaculation from sudden impulse, but rather was the result of long training, the working of an exact science. I really think the buck understood him, and being equally determined, cussed back in his own way as best he could.

As a certain man wished to die at the supreme moment of happiness, so I wished to kill that buck at the supreme moment of Joe's dejection, that thereby I might behold the bridging of the distance between despair and joy as pictured on the human face. One shot from the Ballard; one leap straight into the air; one last glance of

hate, and the warrior of a thousand battles among his kind was conquered. Not in equal conflict, but in the unequal battle of stealth against honor; of bravery against myself, a coward, firing from a safe retreat. I had coldly committed murder. I felt like a villain then, and I do yet when I think of it. I do not think Joe was particularly worried about any murder just then, for with a half tumble, half climb, he came down from the perch and finished the scene by cutting the buck's throat.

The old man was completely fagged, but the ecstasies of safety kept him from succumbing. I told him how I had had a hunch so strong as to compel me to toil for hours to get to his trail. How I had saved him, he knew. As he was a confirmed spiritualist, he gave a reasonable explanation from his point of view. I called it chance, but maybe the old man was right. Who knows?

After a rest we proceeded to find out why the first shot had not killed. As I recalled the scene I remembered that the shot had sounded strangely. It was one of the jay-bird loads of the day before, which Joe had thoughtlessly left in the chamber, although he had properly filled the magazine with good cartridges. Being so close at the time of firing, the shot were still bunched sufficiently to stun, but not to kill.

I never told Joe how I had watched him during the greater part of an hour. He would have been grieved. I never told him of my heartless, heathenish laughter. I feared the grand orchestra of his profanity. I never told him how mean I felt about murdering the deer. He would have called me a tenderfoot. For 20 years he had lived his own life in his own way, so why attempt to change it by the introduction of modern squaw-heart notions?

Bilson—So you have a titled son-in-law?
I suppose you consider him a high honor?

Tribbler—Well, yes, he did come rather high; but Carrie seemed sort of set on buying him.—Boston Transcript.



WE ARE VERY HUNGRY.

One of the 5th Prize Winners in RECREATION'S 7th Annual Photo Competition.

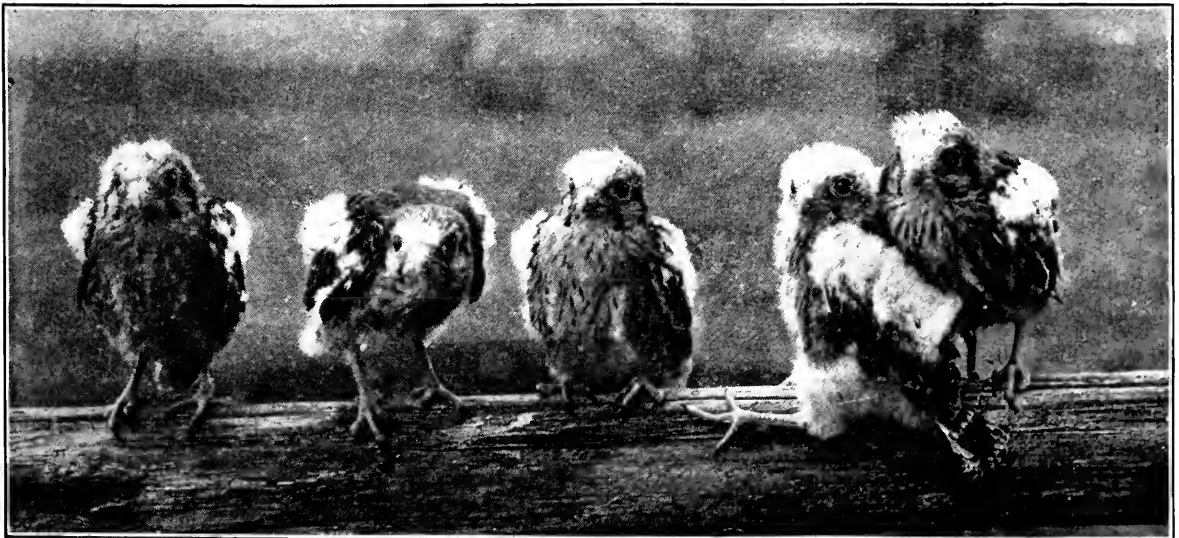

WATCHING THE OGRE EYE.

One of the 5th Prize Winners in RECREATION'S 7th Annual Photo Competition.

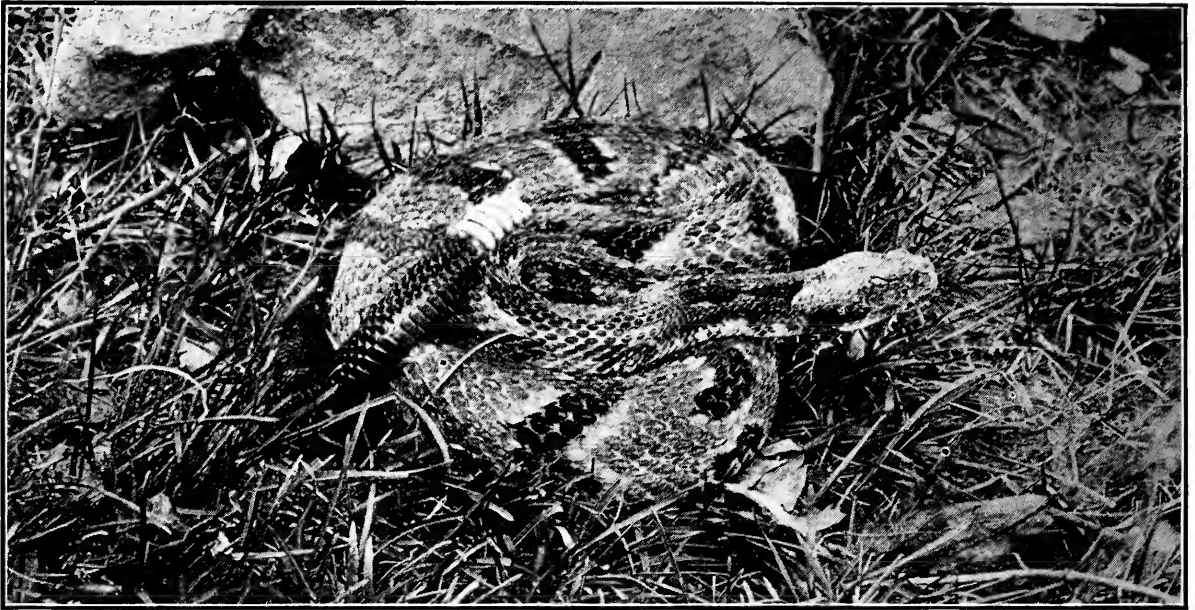

READY FOR BUSINESS.

One of the 5th Prize Winners in RECREATION'S 7th Annual Photo Competition.



DEFIANCE.

One of the 5th Prize Winners in RECREATION'S 7th Annual Photo Competition,



AT BAY.

One of the 5th Prize Winners in RECREATION'S 7th Annual Photo Competition.

A SONG OF THE HILLS.

R. S. STRINGFELLOW.

I know a place far back in the hills,
'Mid the waving trees and the winding rills,
Where the wild rose blooms and the violets
hide

In the soft, green grass of the mountain
side;

A spot where the wind, so fierce and wild,
Stays its gusty course, and blows soft and
mild;

Its shrill voice hushed in the evening's calm
With sighings low as an angel's psalm.

I know a place where the carols sweet
Of the song birds echo in their retreat;
Where the pine trees murmur a sylvan song,
And drowsily passes the day along.

And back in the hills is a maid I know,
With soft, red cheeks, like the flowers that
blow;

The violet's blue is in her eyes,
Which are bright and clear as the Western
skies.

Then off with the frowns of care and gloom,
And away to the hills, where the wild flower-
ers bloom;

For the joys of youth and health will be
ours

As long as we live 'mid the hills and flowers.

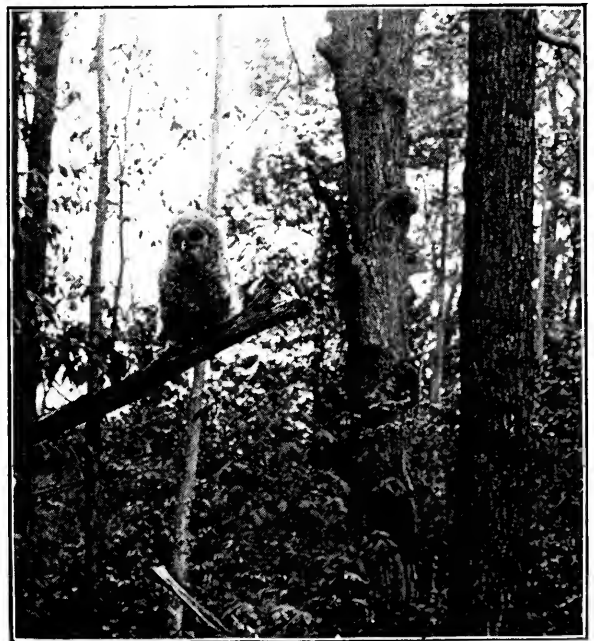

AMATEUR PHOTOS BY WM. H. FISHER.

BARELY ABLE TO FLY.

One of the 5th Prize Winners in RECREATION'S
7th Annual Prize Competition.

Made with a Century Camera, Collinear Lens.

A close friend is one who declines to
lend you money.—Yonkers Statesman.

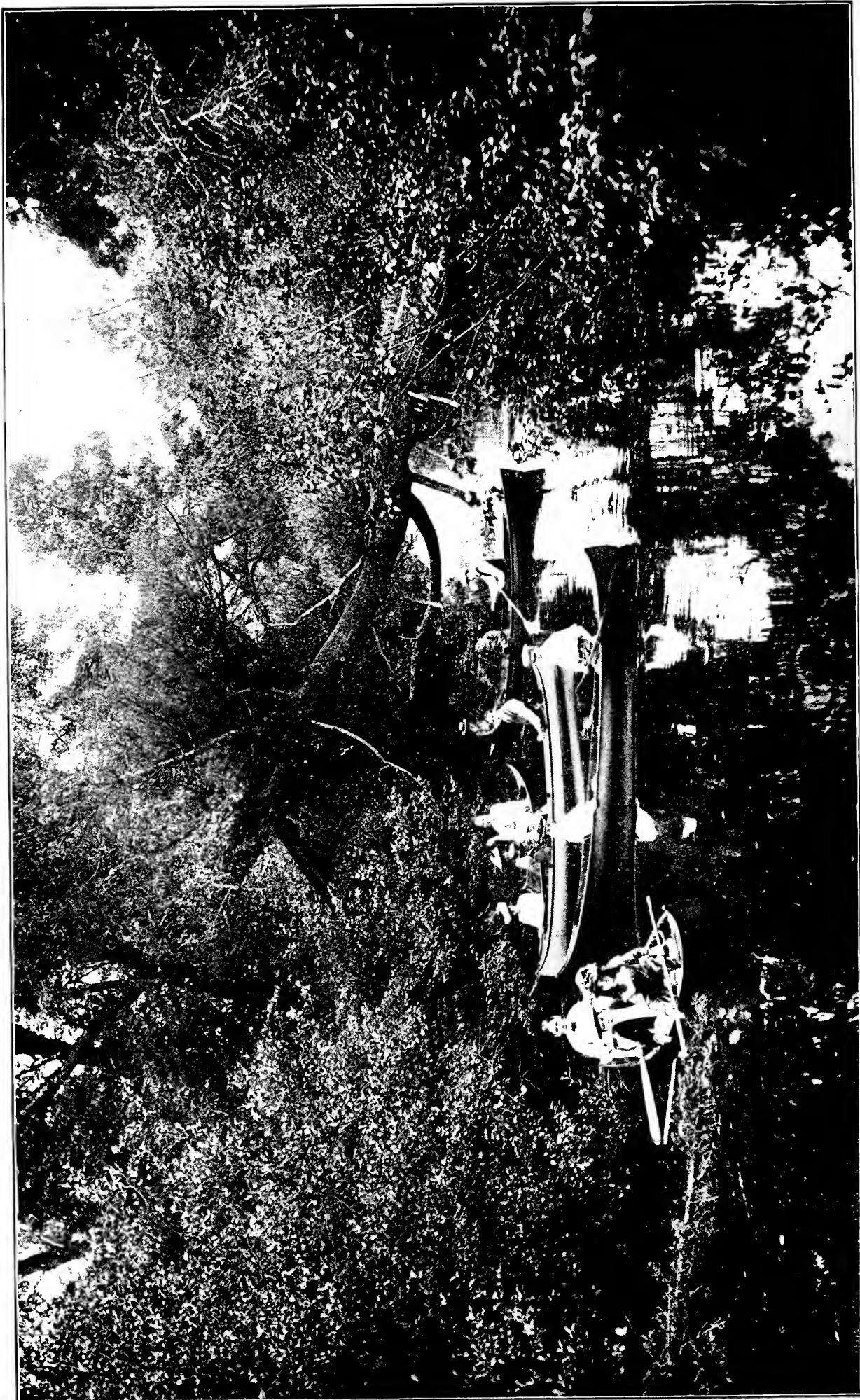

BY COURTESY OF THE GRAND TRUNK RAILWAY.

PROSPECT HOUSE, PORT SANDFIELD, GUESTS AT SHADOW RIVER, LAKE ROSSEAU, MUSKOKA.

ONTARIO'S GREAT PLAY GROUND.

FRANK YEIGH.

Nature has been truly prodigal in her good gifts to Canada. From the picturesque hills and vales of Cape Breton, a replica of Highland scenery; from the game haunted forests of New Brunswick and the untrodden wilds of Northern Quebec, to the snow-clad peaks of British Columbia, each of the Provinces of the Dominion is a land of scenic beauty. Ontario is especially rich in her heritage of natural scenery, from the island fringed shores of Lake Huron to the upper waters of the Ottawa. Within these limits lies a vast playground for the tired children of the earth. So extensive and intricate indeed is its network of waterways that probably no man has ever more than touched a corner or penetrated far beyond its borders. Even the roving Algonquin or Huron of former days perchance knew little of the wonder-

The front door of this wonderland of Northern Ontario admits to the Muskoka lakes. A hundred miles North from Toronto the railway will bring the traveler to Lake Muskoka itself and to a trim little steamer that is at its service. The transition from a hot train on a hot summer's day to the ozone-filled air of the North is as welcome as it is sudden, and the course of the vessel as it winds in and out of a maze of islands and channels, seems to involve a constant boxing of the compass. Then follow scenes of delight as the trio of lakes—Muskoka, Rosseau and Joseph, "the 3 Graces"—are explored. They alone constitute a steamer route of over 50 miles of surpassing beauty. Muskoka is connected with Rosseau by the dark and narrow Indian river; Rosseau and Joseph are dotted with the cosy cottages of other

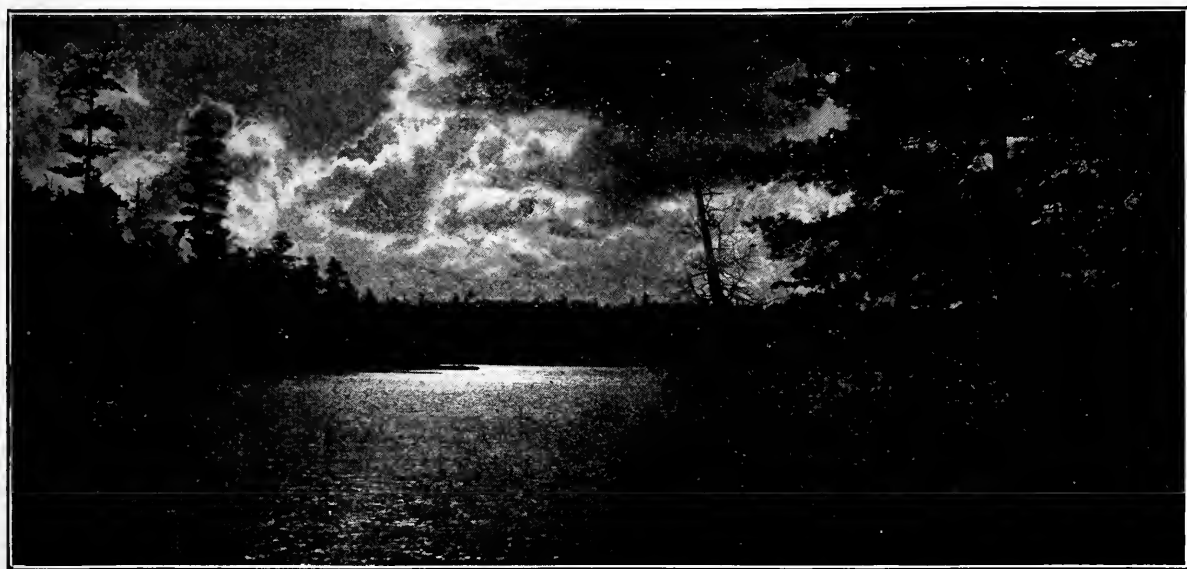

MOONLIGHT ON LAKE JOSEPH, MUSKOKA.

land all about him except along the few watery pathways over which his bark canoe glided like a spirit of silence. To-day, it is a land awaiting the invasion of the 20th century white man; awaiting him with health for his ills, with rest for his throbbing nerves, with youth for his premature age, and with a fresh addition of gray matter for his poor overworked brain. It is, in fact, a great Nature sanitarium, a paradise of lake and stream, of forest and island, where, far from the haunts of men,

"We stand in the heart of things,
The woods are round us heaped and dim,"

and Mother Earth lies ready to reveal her secrets.

happy summer idlers. Islands abound, from a tiny one-tree speck of earth or a bare cone of rock to a 1,000 acre isle stranded mid-lake in beautiful Rosseau. Each turn of the prow of steamer or canoe reveals a new vista, and no 2 views are alike, as the perspective changes with each passing hour. The lakes have a life of their own under a blue sky or a canopy of summer clouds; they wear another aspect when the glow of sunset diffuses itself over land and lake, mirroring each islet in the glassy waters. There is still another aspect created by a harvest moon, when an indescribable peace broods over the fair scene, contrasted later by the frown of a thunder cloud or the tempest of a squall. Thus the



THE SHADES OF NIGHT WERE FALLING FAST.

bonny lakes of Muskoka have a many sided life. Their secrets are best read apart from the feverish restlessness of a summer hotel. It is the camper-out who is nearest the heart of Nature, and who may, if he hath ears to hear and eyes to see, learn something of the message She has for him amid such sympathetic scenes.

The Muskoka lake district is not, however, confined to the 3 main bodies of water. The whole area of the "Highlands of Ontario" comprises no less than 800 waterways, including lakes, rivers and streams, formerly the happy hunting grounds of the ill fated Hurons, who once roamed through the cool, dark forests and over untilled lands. Hundreds of the islands retain their original wildness, and nature is undisturbed in many a corner of Muskokaland, where the red deer follows the trail, where a varied bird life exists and where the fish in the virgin waters have never seen the specter of a human angler. Many a tributary, too, sweeps along in its primeval solitude toward the larger waters and the broader sea, the sweet, brown, waters singing a song set to a key beyond human ken, but musical to human ears; or, as in Shadow river, resting so motionless on a summer day as to reflect every twig and leaf, every vein in every leaf, and every snow-white cloud in its pellucid depths.

The seeker for summer rest may enter this delectable land through the inner chan-

nel of Georgian bay, where the Creator with no niggardly hand scattered 30,000 islands on its clear, deep waters; some small, dainty and exquisitely clothed with balsam and pine, with cedar or white birch; some dignified in their broad dimensions and their forests of oaks mingled with the less stately tree growths. The steamer makes its way through apparently land-locked channels to Parry sound and Rose Point. This route will lead to the unique Maganetewan river, its iron-impregnated waters winding in such tortuous fashion that the little craft is equipped with both propeller and paddle wheels, both of which are at times in use when rounding a sharp bend. The giants of the forest overarch the narrower stretches where one may sail under a roof of greenery and between banks so clothed with vegetation as to resemble a Florida everglade. The Maganetewan drains a surface of 4,000 square miles, and using its course as a canoe route, the waters of Lake Huron may be reached after negotiating on the way a series of portages.

Journeying Eastward, lake succeeds lake in never ending succession. Fairy lake—does not its name tell all? The Lake of Bays, with islands and curving shores that only await the poet to immortalize them. The pastoral beauty of one part merges into a rugged, mountainous grandeur in another.

The great Algonquin National Park is

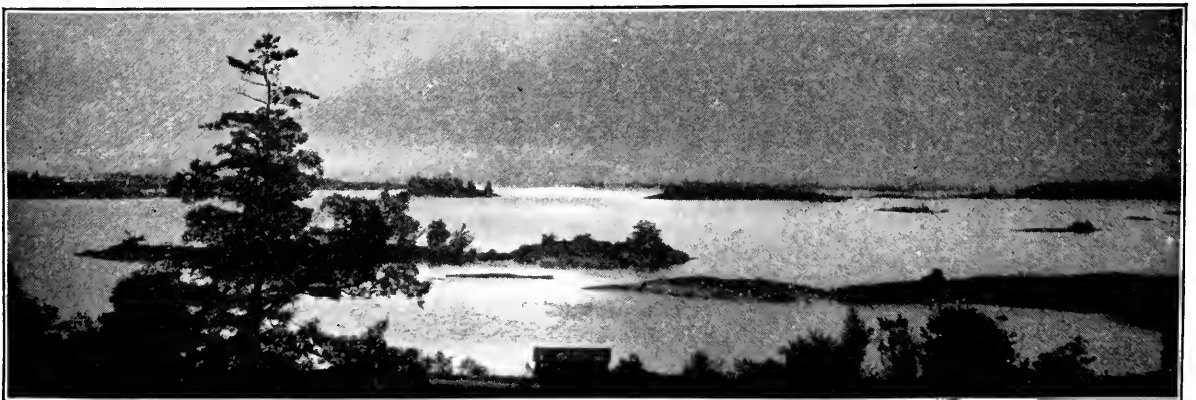

SUNRISE ON GEORGIAN BAY.

reached by canoe from the Lake of Bays, where over 1,000,000 acres of the Crown domain have been set apart in perpetuity as a forest, game and fish preserve. Already it has proved a sanctuary for wild life; and moose, deer, beaver and other game and fur-bearing animals are rapidly increasing. The park is one of the most remarkable regions of lake and stream, primeval forest and rock to be found in the Dominion. Over 1,000 beautiful lakes are

angler as well as the hunter are being conserved. From Muskoka Wharf to Lake Nipissing on the North; from the Georgian bay to Algonquin park on the East, it is the unfolding of a matchless panorama, now of massive rocks, now of mighty reservoirs holding the climatic, forest and animal life of a great territory in their depths, now of tree crowned hills lapped by the waves of an inland sea. He who has the hunter eye may catch a glimpse of a deer,



BRUCE LAKE.

within its boundaries, reminders of Lomond and Katrine, Windermere and Killarney, and even of Como in their setting of tree and rocks. The shores of the great Opeongo lake, the largest in the reservation, are the ancient burial place of the Algonquin Indians, who once held all the surrounding country in their own right. The park rangers are opening up a series of canoe routes and erecting shelters at different points. This extensive retreat, coupled with the admittedly excellent game laws of Ontario, is maintaining all the Northern areas as a perpetual realm for the sportsman. No less rich are the lakes in fish life, and thus the interests of the

unconscious of the nearness of man, as it emerges from a woodland depth and drinks of the sweet waters. On this journey through Natureland, precipitous cliffs send back the human voice with startling mockery, while they form a barrier that diverts yonder tributary to another channel. Indian portages tell the pathetic story of the red man's supremacy in the years that will never return. Thus a primeval wilderness of rarest natural charm, a lovely lake-land beyond the scope of men-made words to describe, a great family of rivers hurrying to their rendezvous, an asylum for animal and fish life, exist in the untrodden playground of Ontario's wide Northland.

Clara—What an easy going person that Mr. Littlebrayne is.

Agnes—Easy going? I never found him so. It's always the hardest kind of work for me to get him to go before midnight.—
Chicago Record-Herald.

HUNTING IN NEW MEXICO.

J. F. FOLEY.

I left Cerrillos October 27, with 2 companions, both of that place, Mr. John Kelly, who handled the reins over a fine mountain team, and Roy Green, a boy in years but well versed in woodcraft and with a splendid knowledge of the country we wished to explore.

The next day we reached Glorieta where we were joined by Hugh Hufford, a conductor of the Santa Fe Company. He had heard of our expedition and asked permission to join our party. We were more than glad to have him and Hugh and I speedily became friends. There, also, we laid in our supplies. These we packed in a wagon to which 2 stout mountain climbers were hitched and with the 4 of us we had a good load. We were able to proceed in this manner about 30 miles, to Cooper ranch, if I remember rightly. Then by walking, and exercising particular care, we were able to carry the outfit some 8 miles more. Finding it impossible to go farther, we concluded to make camp and try our luck. We found a comfortable cabin, containing shelves and a table. After getting our stuff safely in doors, the horses were hobbled and turned loose, wood was gathered and supper prepared and eaten.

My trout rod was handy and at my second cast on the limpid rapids of the Pecos I had a fine rainbow trout flapping on the grass. This was soon joined by another, and in 40 minutes I was the proud possessor of 4, weighing $\frac{1}{2}$ to $1\frac{3}{4}$ pounds. Eager to display the result of my skill, I hastened back to camp to find that Roy, who had gone out with a pole cut from the cottonwoods and an 8 foot section of No. 9 cuttyhunk, had caught 9 trout, using only grasshoppers for bait. After that I allowed him to do the fishing and he kept us plentifully supplied.

Next morning Hugh and I rose early and trailed out to size up the country and, if possible, locate a crossing or lick. Being successful, we hurried back to camp for breakfast. Returning to the crossing, armed with sharp hatchets, in 2 hours we had 2 snare blinds, on opposite sides of the trail at right angles. Next, we paid our respects to the lick, which we freshened, strengthened decoying scaffold and started back, well satisfied. We had covered about half the distance to camp, walking quietly, when Hugh with a "hist!" stepped quickly from the trail into the long grass and lay down and I swiftly followed. Scarcely were we hidden when a blacktail buck, doe and fawn broke cover 50 yards away. "Mark buck," said Hugh in a whisper.

Without raising from the ground I threw up my rifle and with quick aim pierced the buck with a 38 behind the shoulder. He disappeared in the forest. The doe dropped almost in her tracks, with a bullet from Hugh's 70 through her heart. The fawn fell an easy victim. I felt like sparing it. While Hugh attended to his 2, I went in search of my buck and found him dead about 300 yards away. This was luck with a vengeance, and we hastened to camp for horses to take in our venison.

Hugh and I were smoking the last pipe that night, when a loud halloo appraised us of the approach of visitors. We threw open the rude door and soon shook hands with as fine a fellow as I ever had the good fortune to meet. He introduced himself as Anthony Dockweiler, formerly of New York State, but now living in those mountains, with his small family, for his health. I don't know what his trouble had been, but the mountain air must have proved wonderfully potent. I never met a finer specimen of hardy manhood, or attempted to follow a tougher one on a trail. Tony had heard of our arrival, and came over to see if he could help us in any way. We made him acquainted with a silent member of the party not heretofore alluded to, known as "Jinny-John"; a friend with bowels of compassion for the weary hunter. Tony became valuable over his toddy and entertained us for some hours. He left about 11.30 p. m. and we turned in.

Next day, having plenty of venison, we did not go far from camp. Put in the time among the hills adjacent, looking for grouse. We found them in plenty, but there is not much sport in grouse shooting in that country; as when flushed they alight on trees. We used shot guns that day, but had no use for them thereafter; the rifles being found sufficient for all purposes. We killed some grouse every day, and lived like kings. Alternately, 2 of us watched the lick every night, but the deer were evidently doing their licking somewhere else and never a one came to our crossing. Hufford made some turkey calls of reed stems and went out 2 mornings, but not a feather did he bring home.

We had several visits from Tony. When we told him of our ill success with the deer, he said they could be found higher up. He offered his services and 2 pack horses for a trip 10 miles beyond the Hamilton mesa, where he and some neighbors had built a cabin the summer before. The trip was arranged for Tuesday, October

8. Tony joined us Monday night. Tuesday morning the start was made. One horse carried all necessary supplies. The other was available for saddle; Hufford and I riding alternately. Tony carried a Winchester, Hugh was armed with an old model, 45-70, while I pinned my faith to a 38-55 take down, fitted with Lyman sights. The fellows were inclined to look askance at my light rifle, but I had the pleasure of showing them a thing or 2 before we left the woods.

We reached Tony's cabin about noon, and immediately got to work. Parks occur frequently in that section of the Pecos, and there we tried our skill. For 2 weary days we tramped hither and thither, within a radius of 5 or 6 miles, and did not see a hair. Tony said, "still higher." So Friday morning we went together to the snow line, and killed 4 deer that day; 3 does and a young buck, all blacktails. Tony returned to camp for horses and blankets. We spent the night just below snow line, spreading our blankets on pine boughs, and, in spite of the cold, I never slept better in my life. In the morning Tony started back to camp with the deer and horses, and Hugh and I continued around the mountain. We walked about 15 miles that day before noon, but killed nothing and had nothing to eat. I was hungry as a wolf, and actually had to tighten my belt to ease the gnawing pain at my stomach.

About 5 miles from the cabin we found signs of turkeys and Hugh tried his pipe again with better success. In 5 minutes he got an answer. While he remained quietly calling I crept in the direction of the sound and was rewarded by seeing, after a close study of a clump of bushes, the wattles of a gobbler through the underbrush. I waited some time for him to come out, but he would not move; so I calculated for his breast and shot him low in the neck. Immediately 8 or 10 more got up all around him. Hugh came running and, although we got no more an-

swers to our calls, we hunted so assiduously as to get 2 more birds. These were the only turkeys we saw during our stay. We reached camp footsore, weary, and hungry, about 6 o'clock.

There we found Tony awaiting us with a bountiful supper of venison, onions and tortillas. He had spent the day getting our game in shape for packing, as he had to go home the next day. We accordingly started early Sunday morning and proceeded leisurely. Hufford and Tony shot some grouse and squirrels on the way down; but I was content to trudge behind the pack horses, feeling I had earned glory enough for one trip. We reached camp about 3 o'clock and found we had run away from sport almost at our door. The boys had killed 2 whitetail deer less than 200 yards from the cabin. Tony had supper with us and as I intended to go back the next morning, he concluded to remain all night with us.

I wished to see Santa Fe before returning East, and Hugh proposed we cross the divide to Santa Fe on foot. Accordingly we bade Tony farewell, left the outfit in charge of the boys and started to walk 41 miles. From Tony's description, we easily found the bridle path up Viles canyon. An easy walk for 7 miles, when a steady climb for 9 miles took us to the base of Santa Fé Baldy and plenty of snow. We had taken food with us and made an excellent meal up on that bleak mountain. At one o'clock we began the descent to Santa Fe, 25 miles away. Night overtook us long before we reached our goal. We arrived at Santa Fe at 8.45, 12½ hours after we left camp. Neither of us had walked much during the year and Hugh weighs 225 and I 215 pounds. The wonder is we ever got to Santa Fé at all.

I saw as much of Santa Fe as I could in one day, and took the evening train to Cerrillos. Our outfit arrived the next day in good shape. I bade Hugh, John and Roy good-by and thus ended my trip.

"Jack, dear," she sighed, "Jack, when you are gone I shall pine away."

"Don't," he answered, adding, with an uneasy laugh, "don't pine away; spruce up."—*Princeton Tiger*,

IN LONELY WAYS.

FRANK H. SWEET.

It is the unexpected that often gives one the keenest pleasure; a native orchid in an out of the way place in the woods, a clump of swamp cheese bushes in full blossom at a sudden bend of the road, a wild patch of gorgeous rhododendrons that the wood prowler has never heard of before. One does not have the anticipation of pleasure; but the sudden, joyous, unexpected thrill which flashes over him fully compensates for its absence.

For this reason I like to hide rare bulbs and plants in the most unlikely places; in the fence corners and in the midst of thickets, along unsuspecting brooks and among wild, shadowy ledges of rocks. In the summer their blossoms will lie in wait for me, and spring out at unexpected moments. Their odors will meet me on my rambles and their breath mingle with mine as I lie on the bank watching the clouds or listening to the splash of trout which find that the brook is not large enough to contain their joy.

If I were that rare combination, a millionaire and philanthropist, I should buy a carload of choice bulbs and plants and homestead them in the haunts of the ruffed grouse and the gray rabbit. The mossy rock, which has never seen aught except wild creatures and flickering shadows, should have a magnificent clump of auratum lilies planted close beside its base; the little brook, which sings lullabies from morning till night and from night till morning, should have its banks so starred with German and Japanese irises that its song would henceforth proclaim something of the joyousness that lies beyond its own shadows; the bare, rocky hillside should have its share of the treasures and the swamp and the wornout, bushy pasture should not be forgotten. As the years would pass the rare bulbs and plants would grow strong and increase and mingle their leaves with those of the natives. The solitary man who rambled through the woods, and the maiden who loved to

botanize and gather rare plants, and the child who loved to watch the birds and listen to the unknown language of the leaves, would all feel the joyous thrill of discovery.

I would have the bulbs and plants increase until each little shoot became a clump, and each clump a mass or thicket. I should make each swamp and dell and rocky pasture a custodian of one or more of the treasures; and each favored spot should guard its secret carefully until the bulbs and roots grew strong and sent forth pioneer buds in search of the sunshine. They should belong to everybody, and the blossoms should be a signal that everybody had come into the inheritance.

There would be no difficulty about the increase, for the selection would be carefully made. Hyacinths and other exclusive or unacclimated foreigners would not be accepted; but there should be the rarest of blue scillas along the bases of the ledges and in the cosy nooks where the March sun would be able to clear spaces for them in the snow. Neighboring with them should be the purest of white snowdrops, the richest of yellow crocuses, and the sweetest of pink daphnes. On the hill, in the valley, and in the far away, silent places where the loon builds her nest, should be fair lilies and gorgeous azaleas, stately crown imperials and modest, sweet scented lilies of the valley. Every year would spread and multiply them and every wayfarer who chanced on their unexpected loveliness would return home with another fair remembrance in his heart.

I have in mind a small lily bulb which I once planted in the shadow of a thicket and forgot. A few years later I was delighted to see an immense cluster of auratum lilies peeping from the bushes. There were 10 or 12 magnificent blossoms, on stalks 4 or 5 feet high; and investigation showed that the bulb had increased to nearly 20; surely a valiant response to my effort.

A man who only works other people can not be called a workingman.—Wine Review.

TOURING IN THE CANADIAN ROCKIES.

STANLEY WASHBURN.

Illustrated with Photos by the Author.

Twenty years ago the vast region North of Montana and Washington was known only to hardy trappers and a few venturesome spirits who were enterprising enough to push into the wilderness in search of game or for the pure love of the unknown. In the early 80's the Canadian Pacific Railroad put down the last rail that connected the Atlantic and the Pacific oceans. Since that day the wonderful scenery of Alberta and British Columbia has been gazed on by tens of thousands of tourists and travelers. This is better than

stroying hand of civilized man began to hew down the splendid forests; before the roaring torrents were marred by unsightly steel bridges and the mountains by still more unsightly snowsheds. This is the world as God made it. To see this world one must abandon the luxury of the palace sleeping car and content himself with the rougher life of the forest and the crude but healthy *régime* of the camp and the pack train. Short distances from the railroad may be made on foot, but to get into the true wilderness one must take pack

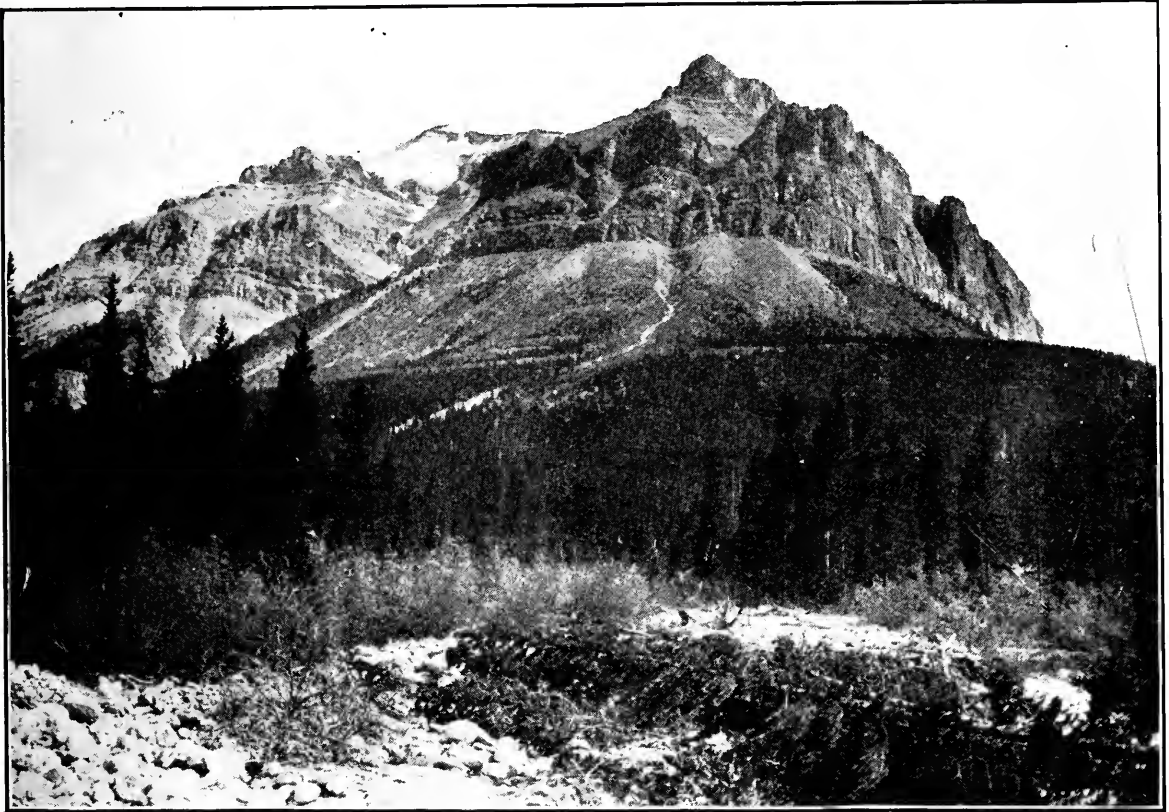

A TYPICAL PEAK IN THE ROCKIES.

nothing, but to the lover of nature in her untrammelled state it can not have the fascination of the region where the mountains raise their snow-capped peaks far from civilization. The passes and glaciers of the railroad are magnificent, but there are not the inspiration and consciousness of grandeur that one feels hundreds of miles North, where no shrill whistle or heavy rumble of freight trains startles the eagle from its nest among the crags; where one sees the snow and rocks and trees as they were a thousand years ago, before the de-

stroying hand of civilized man began to hew down the splendid forests; before the roaring torrents were marred by unsightly steel bridges and the mountains by still more unsightly snowsheds. This is the world as God made it. To see this world one must abandon the luxury of the palace sleeping car and content himself with the rougher life of the forest and the crude but healthy *régime* of the camp and the pack train. Short distances from the railroad may be made on foot, but to get into the true wilderness one must take pack

For extended trips North, Laggan is a good point to leave the railroad. Situated as it is between the first foothills and the main range of the rockies it gives the certainty of fine scenery and a good chance of game. The first necessity is a head man who shall be guide and general supervisor of the mere mechanism of the expedition.



THE HEAD WATERS OF THE SASKATCHEWAN.

He must go ahead to pick out the trail and the easiest route where there is no trail. He must find the best fords and engineer the outfit across; he must superintend the packing. For a large outfit there must be an assistant to pack and drive the horses and to keep camp. Last, there must be a head of the culinary department, who is by no means the least important. Suppose there are 3 hunters in the party. All must have horses. This will make 6 saddle horses alone. For such a party there should be at least 8 or 10 pack horses. On these must be carried the camp outfit, that is, tent, blankets, cooking utensils, etc., the personal baggage of the party and the grub. This consists usually of flour, oatmeal, rice, beans, dried fruit, tea, coffee, sugar, condensed milk or evaporated cream and bacon. The luxuriously inclined may add to these, canned goods or even bulkier provisions if he be willing to take along enough extra pack horses. The personal baggage should be as light as possible, but we usually find beginners loading themselves with dozens of articles they never use. I have even seen a horse packed with suit cases and one loaded with a steamer trunk. The man who knows his business takes only what he can not get along without, namely a change of clothes, a toothbrush and his hunting outfit, including rifle, rod, shot gun, revolver and camera.

In organizing the party each horse will have his special load. These loads must all be made up at the beginning according to the strength, peculiarities and qualities of the various horses. The flour, for instance, goes on old Pinto, who has a reputation for being a good horse in water and may be trusted to keep his pack dry. The camera supplies and breakables go on Little Billy, who is a most painstaking and careful animal. The blankets and sleeping bags go on the buckskin mare, who may be relied on to buck off anything that rattles; and so on through the list until each horse has been allotted a portion of the outfit.

Then commences the packing.

First the horses must be caught. This is easily done by felling a few trees to form a V, or wedge, into which the animals are driven. Even the wildest can be readily captured. Then, one by one, they are led up to have their loads put on. First the pack saddles are cinched in place and then, by means of swing ropes, the side packs are adjusted. This leaves a hollow between the packs, where odds and ends, such as fishing rods, tools, etc., are placed. Above these goes the top pack and over that the canvas pack cover. Then the whole is made tight and fast by a long rope arranged in a series of loops and slips known to the initiated as the diamond hitch. Two good men will pack a horse in 6 minutes,



CAMP DESOLATION.

provided the horse is willing. Otherwise it may take 6 men twice as long. There are sure to be one or 2 horses that are hard to catch and mean to pack.

When the last horse has been cinched and his pack adjusted we are ready to start. By that time the animals that have already been packed have strayed about and a few minutes are necessary to round them into a bunch. The head guide swings himself into his great Mexican saddle and his cayuse ambles off down the trail. The other ponies are driven in behind and the members of the party scatter themselves throughout the line to prod the delinquent beasts. When the trails are good and the animals old at the work the driving simply amounts to riding along in the procession and admiring the scenery. But this, alas! is seldom the case. We have not been on the road an hour before we begin to strike difficult trails. A trail in the West simply means that at some time in the past someone has been over the route. Often there is nothing to indicate the presence of a trail except a blaze on a tree every few hundred feet, or perhaps a root or an overhanging bough that has been hacked with an axe. On the hard ground there is often no sign for miles of any previous travel. All we can do then is to head in what seems the right direction. This is not so difficult in the mountains as it would seem, for a trail

must always follow the river valleys and we are sure of picking it up in the canyons or at the fords.

In many spots we find a well worn path perhaps 18 inches wide and several inches deep. These have often been made by the game and worn by the Indians. As long as the trail is well defined all goes smoothly, but when we get in a little, the difficulties begin. Of all these, fallen timber is the worst. There is no task so maddening or conducive to profanity as driving a pack outfit over a trail that runs through fallen timber. These strips occur in spots all through the mountains. In the first place, a fire has passed through the woods, burning every green leaf and shrub and leaving the trees standing naked and charred. The roots die and the first wind storm that comes along tips the trees over. If a bad blow has been through the mountains we find them piled up like jackstraws. The smaller ones, up to 3 feet, the horses can jump or step over, but the larger ones or those hanging directly across the trail, must be chopped through or gone around. Every time the leader halts all the rest of the train is delayed. It is easy to see that 15 horses will string out over a considerable distance. When the leader stops perhaps one of the horses 4 or 5 back does not stop. Indeed they often turn off at right angles and commence jumping over



A MOUNTAIN WATERFALL.
Taken from the Trail.

fallen logs and dead trees until they are hopelessly stranded. Then one man has to dismount and go off into the timber and back the beast out or perhaps chop a way out with an axe. When this happens once it is annoying, but when it happens a hundred times it is simply infuriating. Often the horse in the rear will crowd up and stampede 4 or 5 of his partners ahead. Then again even when the trail is good some perverse beast is sure to get off the trail and get his pack wedged between 2 trees or get caught in some fallen log. After the first day or 2 the horses get accustomed to their place in the line and then woe to the horse that tries to squeeze in ahead.

I well remember that Little Billy's ingenuity in keeping the lead was most amusing. He would always arrange it so there would be 3 or 4 horses between himself

and the nearest driver, so he could stop to pick grass without danger of interruption. This would, of course, delay those behind, who would try to crowd past him. They invariably got a good sound swot in the ribs from Mr. Billy's heels. I was out a few years ago with this same little horse and witnessed a most amusing incident. Billy was, as usual, in the lead. There was another extremely perverse horse which we called Cyclone on account of his evil disposition and wandering ways. He had been tailed to Little Billy; that is, his halter rope had been twisted in the latter's tail. These 2 unhappy beasts got into a wasps' nest and the wasps began to get in their work just as Billy passed. Cyclone stopped; Billy proceeded. A wasp stung Billy. Billy put on full speed ahead. A wasp stung Cyclone. Cyclone went astern. For a moment there was a dreadful tension. That poor tail pulled taut as a banjo string. Then alas! it gave, and Billy plunged forward, while Cyclone dashed off into the woods with a long gray tail dragging from his halter rope. I laughed immoderately, much to the disgust of the guide, who never cracked a smile, as it was a borrowed horse. He recovered the tail and packed it in the saddle bag with the provisions, in the hope that he might get it stuck on again. I do not think he succeeded.

We usually travel 4 or 5 hours at a stretch. Over good trails we make perhaps $2\frac{1}{2}$ miles an hour, seldom more and often much less. I recall an expedition in British Columbia when it took 18 days to go 40 miles. The start in the morning is usually made at 9 or 10 o'clock and at 2 or 3 o'clock we begin to look for a good camping place. There must be water, forage for the horses, fuel and preferably a soft spot on which to pitch our tent, but that is not essential. When a spot is decided on everyone has his hands full. The first thing is to unsaddle one's own horse and turn him to feed. The united efforts of the whole party are then necessary to catch the pack horses and tie them. They are then led up one by one, the various packs being placed together and the animals turned loose. In the meantime the cook has his fire started and some pots of water boiling over the fire. One is for coffee and one for soup. A few slices of fried bacon and a loaf or 2 of bannock, or baking powder bread, left from breakfast, constitute dinner. After dinner the tent is pitched and the beds are made. The remainder of the day slips away quickly till supper time.

In stormy weather it is different. When it rains in the mountains the rain is like ice-water! We are soaked to the skin; our benumbed fingers can scarcely untie the

pack ropes; the fuel is wet; the fire will not burn; the ground is damp; everyone is swearing mad. There is no more wretched or melancholy task on earth than making camp in the rain; but all the hardships and discomforts of wet weather are more than made up by joy at the return of the sun and warmth. What more delightful after a hard day's journey and a good meal than to stretch oneself out on the soft grass and allow the rays of the sun to permeate into one's very soul!

Leaving Laggan, we strike out on the trail. A few miles we follow along the railroad embankment and then turn sharply North up the valley of the glacier-fed Bow river, on which Laggan is situated. There we leave the railroad to twist its way Westward over the Great Divide and on through the wonderful Kicking Horse canyon. This pass ranks high among the engineering feats of the world. The railroad creeps through a rugged defile, little more than a cleft in the mountains, through which boils a roaring torrent. Just as farther progress seems cut off, the road turns sharply to the left, crosses the canyon on a trestle at a giddy height, and then for seven miles cuts its way down the side of the mountain, at a 6 or 7 per cent grade, to the floor of the canyon at Field; but that is off the line of our march.

The season has been late and the mountains are covered with snow. All around us tower the great peaks of the Rockies. Behind us Victoria and Temple stand with their ice-crowned peaks against the sky. On our left is Mt. Hector, with a tip not unlike the Matterhorn; while an endless chain of mountains and snowy peaks unfold before us. The trail for the first 15 miles leads through fallen timber and a kind of swampy land called "muskeg." The surface is a thick mat of roots and grass, over which a man may sometimes pass, but below are thick mud and water. Some of these muskegs are dangerous, apparently having no bottom; but for the most part they cause nothing more serious than the annoyance occasioned by the horses floundering about up to their bellies and bespattering themselves, and all their friends with mud. Every few miles a brook tumbling down the sides of the mountain joins the more sedate stream flowing along the valley. About 20 miles North of the railroad is Lower Bow lake and 10 miles above that is Upper Bow lake. These little sheets of water are marvels of beauty nestled in among the great mountains whose rugged sides rise abruptly from their shores. They remind one strongly of the fjords of Norway. The upper lake is about 2 miles long, apple green and cold as ice. On 3 sides are mountains rising thou-

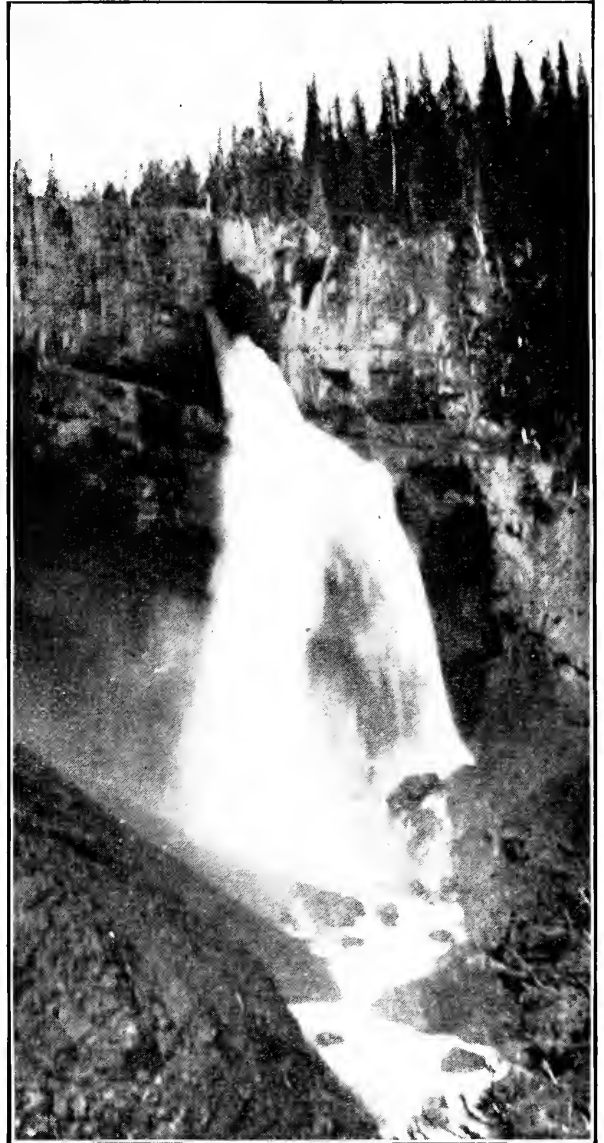

THE FALLS OF THE SASKATCHEWAN.

sands of feet and crowned with snow. The other side is timbered, with here and there a little park of green verdure. There, amid the pines, we pitch our camp, on a carpet of velvet moss. A few miles to the West a great glacier creeps down from among the mountains and spurns the valley with its frozen toe.

Leaving this lovely spot, we push on up the valley of the Bow. The stream grows smaller, and finally is a mere sluggish brook creeping through a plateau meadow, at the North end of which is a thickly wooded forest country. Except for the bracing air and the view of the surrounding peaks one would never dream that the altitude is over 6,000 feet. A short distance more and we are over the watershed and are descending into the Saskatchewan valley. The trail leads down a steep grade, winding in and out among the great pines and firs over a carpet of foot-deep moss. In the afternoon we camp in a forest of



CAMP ON BEAR CREEK AFTER A HEAVY RAIN.

trees which has been burned over and nothing remains but the tall, charred stumps lifting their mournful skeletons to the sky. It is a desolate spot, but the immediate surroundings are forgotten when one glances North and sees the tall peaks of the Saskatchewan valley, 50 miles away, and dim outlines of still others beyond them.

A few hundred yards from our camp we see traces of the great grizzly of the Saskatchewan valley. This old bear has become known to the trappers in the vicinity for her enormous size and her wonderful sagacity in eluding the hunter. He would be an ardent sportsman who would hunt very hard after gazing at the enormous tracks of the beast. Beside the trail we see the spot where the great creature has buried the carcass of a whole horse, abandoned by some pack train, as a dog would bury a bone. These bears run up to 1,600 pounds in weight and are proportionately strong. They are hard to kill, often running 100 yards after being shot through the heart. Ordinarily they keep to themselves and mind their own business; but woe to the unhappy being who encounters a mother with cubs or is unfortunate enough to slightly wound one of the race, male or female.

The weather being settled, we sleep without a tent, wrapped in our blankets or perhaps neatly hidden in the folds of our sleeping bag. It is truly sublime to sleep out under the stars, with the great mountains looming dimly against the sky, and to be awakened early in the morning by the roar of the snow falling from the glaciers miles to our left. Creeping out from our warm bed, we see the tips of the mountains in the West tinged by the first pink rays of the rising sun. Down in the valley

all is still and no sound reaches us save the distant roar of the stream and the soft sighing of the trees, swayed by the morning wind. Already the cook is sleepily preparing breakfast of oatmeal, coffee and bacon. A few minutes after breakfast to smoke our pipes and talk it over; then the day is fairly started. The cook cleans his dishes, while we catch and saddle our horses and pick up our various belongings. In an hour or 2 we are in the saddle, driving the pack horses over as hard a trail as there is in the mountains. One poor horse, known as "the white scut," is hopelessly stupid. Again and again she leaves the trail, gets wedged in among the trees and tears her pack. From the burned timber we get into a windfall of live timber, which is scarcely better. An idea of the difficulties of packing in that country may be gathered from the fact that it often is necessary for the animals to step over as many as 20 fallen trees in 5 minutes.

We are following down from its source, amid the glaciers, the South branch of the North fork of the Saskatchewan, better known as Bear creek. For nearly a week we move along its banks and watch it grow from a pretty brook into a truculent mountain torrent. At last the trail emerges from a dense growth of timber, so thick and overgrown with brush that we can not see 50 feet ahead. It comes out on a great, flat, sandy river bottom. There, within a radius of a mile or 2, 3 rivers come together, each from its separate valley. From the North comes the North fork of the Saskatchewan, from the West flows the main stream, heading 20 miles away in the Howse pass; and from the South Bear creek, which we have been following. The last few days have been warm, consequently the melting snow has flooded the streams,

so we can not attempt the main river except above where its tributaries come together. Even Bear creek causes us great anxiety, for the icy water is running 3 or 4 feet deep. A single misstep in the rocky ford and a horse is lost, and in a few moments is struggling in the main stream 100 yards below. A mile or 2 above this ford the river widens out until it is nearly half a mile across. There we cross the horses in safety, though the last few feet bring the water well up into our saddles.

The mountains in our immediate vicinity rise with gentle, grassy slopes to the timber line and then go up in great, rugged peaks. It is on such spots as these that the mountain goat, with his little, straight, sharp horns and long, white, silky coat, loves to graze. Below in the timber and along the river bottom the red deer pick their way daintily over fallen logs, while an occasional great cloven track on the river bank tells us there are moose in the vicinity. Of other game we see little save the Richardson grouse, or, as the mountaineers call them, the "fool hen." They are properly called, for a bird more devoid of common sense does not exist. I recall one occasion when we spied a foolish hen and 4 scions of her foolish race sitting on a limb all in a row, like the painted iron birds one sees in a shooting gallery. Unlimbering, we opened fire. Bang! Down came mother. Bang! Birdie No. 2 passed away. The other birds were interested in the proceedings, as they testified by cocking their heads on one side and looking down at us with their little beady eyes to see what was doing; but there was not the least anxiety. The last one, finding itself left alone, flew to another tree, where it was also shot. On another occasion we killed 4 with a stick. Notwithstanding their intense stupidity these grouse make a most delicious meal for the hungry hunter.

A few days of drenching rain and atrocious trails bring us to another great fork in the river. From the West comes in a stream which someone lacking in originality dubbed the West fork. Here is a great mountain wedge through the valleys on both sides of which flow rivers. Our course leads us up the main branch, the valley of which becomes narrower as we advance. The river passes through deep cuts, and it is necessary to ford it again and again. Each crossing is attended with more or less anxiety, as the streams are full of eddies, and already we have lost large quantities of our provisions by the horses' getting in over their depths and soaking their packs. The trails are dreadful. Often we have to drag the horses up the hill and over fallen logs. At other times the descents are so steep that the horses sit on

their haunches and slide down. It is truly said that "a pack horse can go wherever a man can stand and many places where he can not." We camp in a deep valley, almost a canyon. After the sun has set the moon comes up in its full grandeur and turns the stream that tumbles at our feet into a thousand silver ripples.

A little farther and we turn sharply to the right, leave the valley and strike up to a plateau between 2 mountains. The valley that we leave terminates a few miles beyond at the foot of the great glacier of the Saskatchewan. For several hours we are climbing a fearful grade, the trail zigzagging back and forth through the timber 100 times. At last we reach the plateau, which is over 6,000 feet above sea level and above which the flanking mountains rise another 5,000 feet. It is a beautiful spot, with every now and then thick patches of timber and little stretches of green sward and rolling green hills. A climb up one of the neighboring mountains reveals the most wonderful of views. To the South we look down the valley through which creeps the silver thread of the Saskatchewan. To the West is a great range of mountains, with 12,000 and 13,000-foot peaks, and covered with a mantle of snow and ice stretching as far as the eye can reach. To the North is a great, confused heap of ridges and towering peaks. As we linger on the snowy summit amid the rugged crags and stunted verdure, where no sound but the trickle of water from the glacier strikes the ear, the sun sets. Below us the green plateau is already sunk in twilight, while the mountain tops to the West are bathed in a flow of crimson light. An eagle soars majestically in the sky above us, and all is silent; silent and vast. This is the world as God made it.

Following up the valley, we come to yet another fork in the river, an unnamed, uncared for fork, which few have seen. Up the valley to the Westward 15 miles and we are on another plateau, 1,000 feet higher than the last. Here all is still and dreary. No trees or foliage are here save the little stunted growth one finds above the timber line. The grass lies matted and wet, while the snow still remains in small, slushy patches. To the left rises a razorback mountain, some thousands of feet above us. The edge of the razor is barely a foot wide. On the Western slope it falls away 8,000 or 10,000 feet into a great arena-like valley, at the head of which is an enormous glacier and part of the Columbia ice field, which spreads its cold grasp 70 miles over the mountains. Mt. Athabasca towers opposite and off to the North one can faintly see Brown and Hooker, the 2 peaks that stand guardian at the opening of Yellow

Head pass. Again we are at a great watershed. The stream that we see thousands of feet below us is the infant Athabasca, which, flowing hundreds of miles through the wilds of Canada, enters Great Slave lake, and flows thence through the Mackenzie into the Arctic ocean.

Following back on the Saskatchewan, we reach the unnamed fork and turn up the valley to the right. The rise is gentle, but steady. After a few miles we are above timber line, and the aspect is rugged and grand in the extreme. We follow up the little stream a few miles farther, to where it heads in a round, cool pool, like the imprint of a giant staff. Great boulders and jagged rocks lie about it in confused masses. Taking a few steps farther and a turn to the right around a projecting ledge of rock, we find ourselves on the edge of a precipice falling off several hundred feet. In front of us the great valley of the Brazeau stretches 50 miles. The river itself heads a few miles to our right in a desolate valley among the glaciers. All about us we see the prints of mountain sheep, *Ovis montana*, the king of mountain game. These are the places where they have dwelt for years, far from the haunts of man and undisturbed by the crack of the rifle or the noise of the advancing pack train. On one of the neighboring mountains we can count 41 of the agile creatures. A single one is not too difficult to shoot, as he may be caught off his guard; but when in bunches it is most difficult to get within range, for each creature has an eye like a telescope, and when a dozen are on watch it is a wary hunter indeed who can steel a march on this wily game.

At first sight it seems as if we can get no farther, but our guide knows an old sheep trail, over which we can get our pack horses. It is steep and rough, but the little pack animals are sure footed. In an hour or 2 we are over the pass between the Saskatchewan and the Brazeau and are traveling down the valley of the latter. Owing to the high water in all the streams we have passed, our horses have been taken out of their depths again and again since we started, and we are desperately short of provisions. Our sugar is gone, our bacon well nigh exhausted, salt running short, and we are on rations of flour. We have killed quite a bit of game, and are depending largely on smoked mutton for our daily food. We hold a counsel of war, and it is resolved that we push on down the valley of the Brazeau at full speed and strike the Edmonton branch of the C. P. R. some 200 miles East. Our guide knows the country the last 100 miles, but the country between is new to us all. In fact, no white man has ever followed this valley even as far as we

are; or, if he has, he has never mentioned it.

As we look Eastward, we see a great range of mountains crossing the mouth of our valley at right angles. This is the last range of the mountains. We push on fast. The country grows less wild and barren and much more picturesque. We are rapidly leaving the main range of snowcaps behind us. After so many days beneath the great, stern crags and roaring glaciers it is a relief to get into a peaceful valley full of green meadows and groves of young timber. There is a fairly well beaten game trail and one that the Indians have evidently frequented of late, for we see their tepee poles and old camp sites in many places; but as we advance the trail becomes more difficult, and at last leaves us high and dry in a dense strip of timber, through which a little stream bubbles. There we camp to *reconnoitre* and hold counsel.

In the afternoon all turn out to hunt for the lost trail and to explore the country. It is far into the evening when we gather about our roaring camp fire to compare notes. The country ahead of us, we have found, is one vast tangle of fallen timber. The river which we have been following falls into a great canyon a few miles below our camp. To go ahead means weeks of hard work, chopping a path, and it is a question then if we can fight our way out of the valley. Our provisions can last but a few weeks, even on meager rations. We have reached our high water mark and must turn back and strike for the railroad the way we came.

The remaining weeks we are in the saddle early and late, pushing back over our old trail as fast as our horses can travel. Much as we regret to leave the grand old mountains that have stood guard over our many camps all these weeks, it is not without a thrill of pleasure that we approach civilization once more. At last we see the gap where the C. P. R. goes into the Kicking Horse pass. In a few hours more we see the railroad track itself, and soon are riding along close to the right of way. A mile away we can see the tank and the railroad station, and a painted sign tells us it is to

```

* ..... *
:                               :
:                               :
:                               :
:                               :
:                               :
:                               :
* ..... *
  
```

Laggan
One Mile.

Our hearts beat faster as we think of seeing our fellows once more. At this moment we look back, and there, beating

up the grade, is No. 2, the East-bound Imperial Limited. We pull up our horses and watch the great 10-wheel compound straining up the hill, with its 8 or 10 mahogany-finished C. P. R. cars. They are only 50 feet away and we can see all the people in the observation car admiring the scenery and peering about with opera glasses. On the end of the train is the N. P. private car, and 2 girls, dressed in white, are sitting on the observation end, reading. What a sudden return it seems, to the life of the world.

In a few minutes we are at Laggan and

for the last time climb off our horses and take off their saddles.

It is all over. Those days and nights under the stars, far away from the busy world, where men, less kind than nature, strive against one another for their daily bread, are gone forever. We leave the wilderness, peaceful, serene and grand; we return to man, small, petty and selfish. It is but a glimpse of the great, untrodden wilderness that we have had, but it leaves us with a feeling of awe and reverence and a sense of the greatness of a God who has created all this majesty of vastness.



AMATEUR PHOTO BY WM. H. FISHER

FISH HAWK'S NEST.

One of the 5th Prize Winners in RECREATION'S 7th Annual Photo Competition.

SOME BEAR STORIES.

S. N. LEEK.

In the fall of 1890 Nick and I were camped on Pacific creek, hunting bears. I had killed many bears, but never a large grizzly; and it was the height of my ambition to meet one and try conclusions with him.

One morning, taking a saddle horse and a pack horse, I went up a small tributary of Pacific creek nearly to the divide, and camped in a small meadow. After picketing the horses and fixing up camp, I went out for a little hunt, and soon found and killed a small bull elk. I returned to camp, had supper, and was wrapped in my blankets, when I was brought to a sitting position by hearing the horses snorting and tugging on their ropes. Luckily the ropes held them, and they soon quieted down. I could hear some animal rustling in the bushes, but, although it was bright moonlight, I could see nothing, and was soon asleep. In the morning I saddled up and started for my elk. On going up the hill where I came down the night before I saw by the tracks that my visitor of the previous evening was a large grizzly. When dressing the elk I had purposely got blood on my boots, and the bear, striking my track, had followed it back. He had eaten some and pulled the carcass around, but had not attempted to bury it. Packing one horse with meat, I was soon at the home camp.

Next morning, with a pack horse to carry the trap, I went back to the bait. When within 300 yards of it, knowing something of the nature of bears, I tied the horses and proceeded cautiously on foot. From the top of a small hill, near the bait, I looked carefully for some time at every thing and place that might conceal a bear. My attention was directed to a dark spot in the shade of some fir trees, near a log, about 100 yards away. I studied it for some time, when suddenly it moved, and a bear's head looked over the log toward the bait. It was the bear I was looking for. I crept forward a few feet, rested my 40-82 Winchester on a log, took careful aim and fired. The shot was answered by a roar. The bear sprang over the log to the right, then straight toward me, then to the left, then straight away and out of my sight, I not daring to move, for fear he would spot me and come my way.

I heard another howl and all was still. After listening some time without hearing a sound, I started down cautiously. Soon I caught sight of the bear. Getting a lot of logs in front of me, I went to within 30

feet of him. He did not move, but I thought it wise to take a shot at the butt of his ear before going closer. Then I went up to him. I have killed 50 bears, and he was the largest I have ever seen, dead or alive. I took his hide off, filled a 2 bushel sack with fat, and returned to my little meadow.

Next morning I packed up and was soon at the home camp, feeling pretty good and anxious to tell Nick of my success. On asking him what luck he had had, he surprised me by taking off his hat and inquiring if his hair was gray. "No," I replied; "why do you ask?" "Oh, I got scared yesterday and didn't know but it had turned my hair gray." Then he told me what had happened.

When we first made camp a party of Indians had just left a camp $\frac{1}{2}$ mile up the creek. They left lots of bones and meat lying around, and the bears began going there. We set a trap and caught a grizzly, and trailed it over the creek until it reached the hill. There the bear dug a hole and got in, and there we found and shot him. Nick had taken the ax and gone over to get its teeth. When he was within 30 yards of the place where it lay, behind a big log, he was surprised to see a big grizzly rise up from behind the log and look at him; then another, and another, and another. After taking a good look the 4 ran off up the hill and Nick made tracks for camp for his rifle.

With a horse and the trap he went back, never dreaming of seeing the bears again. He had put his rifle against the log, within reach, and was busy setting the trap, when he noticed the horse looking toward the timber. Nick looked, too, and saw 2 grizzlies. Just then one gave a bawl and came for him on the run. He had just time to reach for his rifle, cock it and shoot. The bear dropped dead, so close to him he could touch it with his rifle. The other grizzly had been standing looking on. It gave a howl, ran the other way and escaped.

Nick shot the first grizzly square in the breast, the ball passing through its heart and half the length of its body. His rifle was a 40-82, single shot Winchester. Had this bear lived as long after being shot as did the one I killed, Nick would probably have lost his life. In nearly every case where a hunter is killed by a bear it is the fault of the gun. One single shot rifle, loaded, is worth 10 repeating guns with shells stuck fast in them.

THE KEILEY GLYCERINE PROCESS.

K. ROWA.

Glycerine has long been used as a restrainer in connection with the development of platinum prints. Till the introduction of Mr. Keiley's process it was used in the developing solution to eliminate delicate half tones by causing them to resist the action of the developer; thus giving clean, contrasting black and white prints through the absence of the intervening half tones. The glycerine acts as a restrainer. The developer oxidizes the image on the print. Wherever the image is strongly oxidized the picture is correspondingly dark or black. Where the image has not been oxidized it is soluble in the acid clearing bath and disappears when immersed therein, leaving only clear paper in such places. The glycerine process, as such, came into being with the experiments of Mr. Joseph T. Keiley, its inventor, and only took its place among the advanced photographic processes of modern photography with the publication of the results of his experiments which were given to the world in 1900. Later the full account of these experiments and the process was published in pamphlet form with explanations, and illustrations. Copies of this pamphlet can be secured from Tennant & Ward, 289 4th avenue, New York.

Working on the essential principle involved, Mr. Keiley elaborated a system and process whereby it is not only possible to eliminate half tones, but to correct or modify full tones, to force half tones, to introduce lights and shades, and even to make outline sketches. In a word, with the perfection of this process the development of the platinum print and its various parts was brought within the almost absolute control of the manipulator. This was made possible through the introduction of blotters and brushes.

An ounce or 2 of pure glycerine is placed in a small jar or saucer, a half and half solution of normal developer and glycerine in a second, and a full strength solution of normal developer in a third. Normal developer, for the purposes of this article, is the developer prepared according to the Willis & Clements formula and the prepared salts sold by them. The print, having been printed rather deeper than for ordinary development, or for the high lights, sky, etc., is placed on a large plate of sheet glass and brushed over with glycerine with a broad brush. The 1½ inch. or 2 inch rubber-set, plate-dusting camel's hair brushes are the best for the purpose. Use them solely for this work. Then the half and half solution is brushed

over such parts of the print as are to be developed, the other portions of the print being meantime kept covered with glycerine and free from developer. Where any developer runs over these parts it should at once be removed with blotting paper expressly prepared for photographic use. Also the entire print should be blotted off from time to time and recoated with glycerine, to prevent the uneven gathering of developer on its surface and consequent uneven development.

Where strong tones are required full strength developer is carefully brushed on such parts, which must be blotted off as soon as the required depth has been obtained. For fine work or outline sketches a finely pointed Japanese drawing brush is used. Outlining work is usually done with full strength developer, the brush being permitted to carry only enough developer to moisten the line, but not enough to flow over the print. In coating the print with glycerine care must be taken to coat simply and not to float the surface of the print. Otherwise the developer will work its way unevenly under the glycerine and developing unevenly will make unpleasant spots or stains.

When development is finished, the print is immersed in the regular platinum clearing acid bath, which is immediately brushed over the surface of the print with one of the rubber-set brushes used only for this purpose. This is done to ensure the clearing bath at once reaching the surface of the print, as the glycerine acts as a shield and the developer will often continue its action under the surface of the glycerine while actually in the acid bath, thus often spoiling a carefully developed print.

Should hair from the developing brushes get on the surface of the print during the course of development it should immediately be removed, as the developer will lie along any hairs that are permitted to stay any time and develop the lines thus made on the face of the print. The print is cleared, washed and dried in the ordinary way.

The illustration used with this article is a half tone reproduction from some prints made by Mr. Keiley from one of his landscape negatives and gives a fair idea of the range of the process. The top picture is from an unmanipulated or what is known as a straight print. The three following are brush developed glycerine prints. The print for the second illustration was somewhat over printed. The dark portion of the sky and tree line, and dark spots in fore-

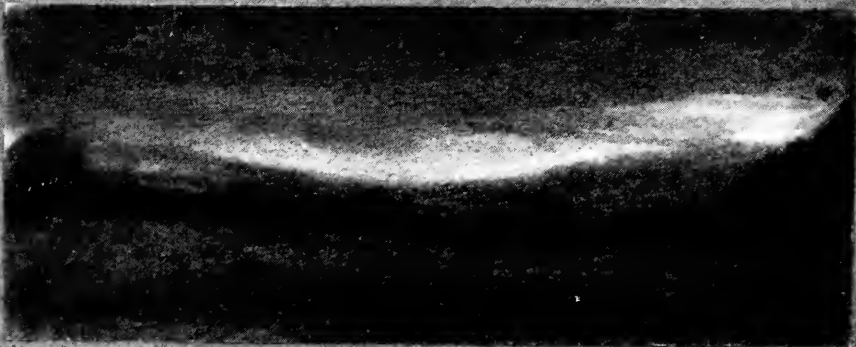

ground were developed with full strength developer, the foreground and hills, and the tinted portions of the sky, with the half and half solution, and the light touch in the sky just above the hill line was kept covered with glycerine and undeveloped. Except in the case of the lighter portions of the sky the third print was developed, as can be seen, with developer of almost full strength; while in the 4th print the light parts of the sky were undeveloped, the tree line fully developed and the dark portions of the sky and foreground developed with the half and half solution.

A study of these reproductions will show that not only have values and tones been altered but lines have been changed or eliminated. For instance, in the second print the tree mass to the right has disappeared and the hills have been so dimly developed as to give them almost the appearance and character of gray cloud masses. This will suggest to natural his-

tory photographers the possibilities of this process in connection with their own work. They are often compelled to photograph their subjects amid unpicturesque or distracting surroundings. By a judicious application of this process to their work not only can they modify or eliminate the settings or surroundings of their picture, but by underdeveloping here and over developing there they can bring out the strong points of the bird, animal, insect or fish which they are endeavoring correctly to portray. Like everything worth knowing or doing, this process requires practice and care; but those who undertake it seriously and understandingly will in the end be more than compensated for the awful daubs and failures they are bound to turn out in the beginning.

Readers of RECREATION who may want brushes, jars and blotters for this process can get them from the Anthony & Scoville Co., 591 Broadway, New York.

THE SPRING POETS.

A. L. VERMILYA.

The sad eyed poets prate
About the charms of spring;
They say the season's great,
And beats 'most anything.

To rise at early dawn,
They say, is quite a boon;
Then they just merely yawn,
And lie abed till noon.

They rave about the charms
Of quiet country nooks;
Though all they know of farms,
They glean from picture books.

They write about the cow,
And of her "fragrant breath";
But I will say right now,
That theme is worked to death.

About the forest dell
These lanky poets preach—
Not one of them could tell
A willow from a beech.

Now, I don't write at all,
I don't do anything;
I care not if it's fall,
I care not if it's spring.

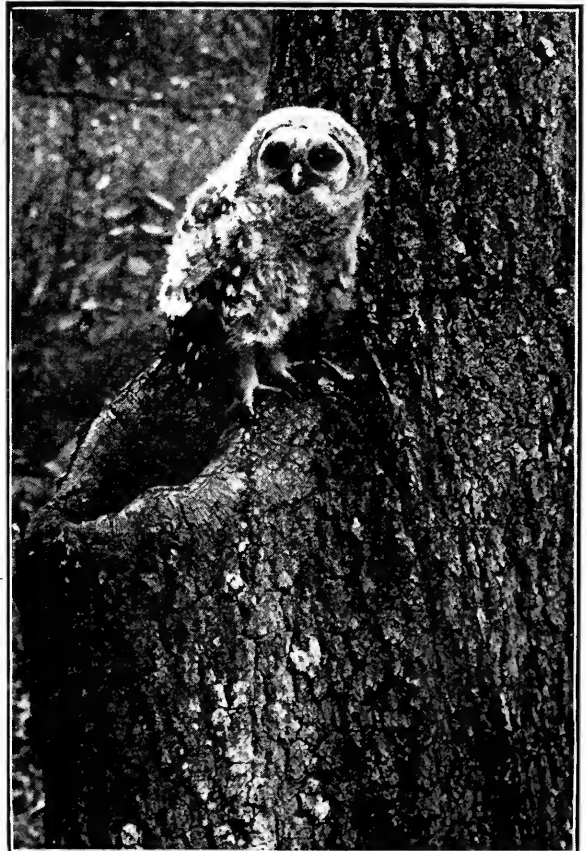

AMATEUR PHOTO BY WM. H. FISHER.

A WANDERER FAR FROM HOME.

One of the 5th Prize Winners in RECREATION'S
7th Annual Prize Competition.

Made with a Century Camera, Collinear Lens.

A MASHIPACONG TRAGEDY.

A. C. RUGGERI.



This is the editor man.

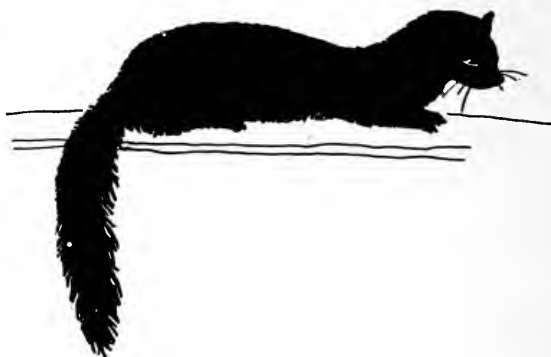

This is the weasel, sly and sleek,
Which between the house and the
cage did sneak,
And killed through the bars the chip-
munk bright,
Which lived in a cage in size just
right,
Which stood by the club house, spick
and span,
Which had for its host the editor man.



This is the club house, spick and span,
Which had for its host the editor man.

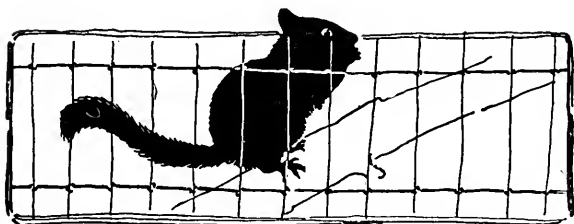

This is the chipmunk, lively and
bright,
Which lived in a cage in size just
right,
Which stood by the club house, spick
and span,
Which had for its host the editor
man.



This is the cook who heard the cry
Of the poor little chipmunk about to
die,
And who pushed the cage against the
wall,
Crushing the weasel, wicked, though
small,

Which had murdered the chipmunk,
lively and bright,
Which had lived in the cage in size
just right,
Which stood by the club house, spick
and span,
Which had for its host the editor man.

A MASSACHUSETTS FISH HOG AT LARGE.

I am an interested reader of RECREATION and greatly enjoy the manner in which you roast pork. It is the only system and would be more effective if some of our sympathizing friends would take hold and help baste a little more. I send you a clipping from the Milwaukee Sentinel of August 10. You will note that the names of the 5 are not given and it is a relief to me to read that the big hog is from another State than ours. We have fish and game hogs here, but nothing that I have ever met equals the depravity shown by this picture.

Fishing in the lakes and streams in our vicinity has been good this season. German carp are increasing rapidly and unless measures are taken to exterminate them they will overrun the waters.

H. B. L. Gorman, Madison, Wis.

The clipping to which Mr. Gorman refers shows the picture reproduced herewith, and the following text accompanies the illustration:

Epworth Heights, Wis., Aug. 9.—Just North of Epworth is a resort known as Piney Ridge. This resort is located on Hamlin lake, one of the best inland fishing grounds in Michigan. Some phenomenal catches have been made there the past week, and Epworth people have had their share of luck. The greatest catch of the season was made this week, when over 1,000 pounds of pickerel, bass and muskalonge were caught by a party of 5 in one day. The largest single catch was made by S. E. Hanson, of Worcester, Massachusetts. Two guides helped him lift the string of fish on his back and he was barely able to carry them from the boat to the hotel.

I wrote Hanson for confirmation of this report and he replied:

I caught in Hamlin lake, Mich., in about 5 hours, between 200 and 300 pounds of pickerel. This is a true statement to which I am willing to take my oath. I should be glad to send you a photo of myself with the load on my back but as I have only one print left I would not be without that for any price. If you will please write Mr. L. F. Swarthout, Livingston, Michigan, he will send you one.

S. E. Hanson, Worcester, Mass.

When Hanson got my letter asking for corroboration of the fish story, he hid himself to the office of the Worcester Telegram and unloaded an interview on the editor, from which I quote:

S. E. Hanson, 241 Main street, finds that his fishing luck and skill are bringing fame nearer than he ever expected. His reputation, after circling around East and West, has reached New York city, and Editor Shields, of RECREATION, has written to get information of his trip and photographs. Mr. Hanson was surprised when the

letter was brought into his office yesterday afternoon, and he found it was from the editor and manager of the monthly.

Mr. Shields wrote he was informed Mr. Hanson had caught 100 pounds of black bass and pickerel in one day on Hamlin lake, and said he should like to have it confirmed. He asked Mr. Hanson if he could furnish photographs, saying he was willing to buy them. He expressed his interest in the trip and said he should like to hear about it.

Mr. Hanson replied, expressing surprise that his fishing in Hamlin lake should have been noticed, and said he would give all the assistance possible for the proposed article. He said he couldn't supply photographs, as he had only one of each for his own use, and referred Mr. Shields



S. E. HANSON, WORCESTER, MASS.

to the photographer, who drove 16 miles through the woods to Hamlin lake to get pictures of big catches.

Mr. Hanson said the editor of RECREATION is misinformed regarding the number of fish caught. Instead of catching 100 pounds in one day's fishing, he caught between 250 and 300 pounds of pickerel. The time was not a day, but between 4 and 5 hours. To this Mr. Hanson is willing to take oath.

Early in July Mr. Hanson went West as the guest of Mr. Bohlander, of Chicago. The men made for Hamlin lake, Michigan. They fished till they were tired. The catches beat all records in that section. The Worcester man became famous. Local Chicago papers told of prowess with hook and line, and all wanted his photograph.

Mr. Hanson has shown a number of Worcester friends the photographs of the catches. One of them shows him with his day's catch on his back,

a mighty load of fish, weighing between 250 and 300 pounds. Others show the fish strung in lines..

A Worcester man who sends me the clipping says:

I enclose a slip which I consider should be put with Hanson's portrait in the part of RECREATION devoted to fish hogs. Mr. Hanson says that after catching between 250 and 300 pounds of pickerel he got tired. A true sportsman would have been tired at 50 pounds, and would have thrown back all small fish. I think I understand your request for Mr. Hanson's picture and hope you will lay it on thick. If he is a conscientious man it will do him good.

Here is more Worcestershire sauce, from another business man of that town, who saw the puff in the local paper:

Of course the whole thing is nuts to me and to every other supporter of RECREATION'S crusade against the army of thick skinned, thick headed rooters. I know Hanson well; and if "coming events cast their shadows before," he bids fair

to see himself as others see him and to learn a lesson which will do him good. I trust he may see, through the rents of his shattered pride, a glimpse of the new gospel of not trying to catch and kill all one possibly can for the sake of a record, in an age already marred by too many like him. Give him the straight tongue on moderation in sport and what it means to coming generations.

I got Hanson's photograph by putting up 50 cents and would have been willing to pay 10 times that price if I could not have got it for less. It is not necessary for me to add to what 2 of Mr. Hanson's neighbors have said of him as quoted above. I wish I could shear him of all his bristles and make a decent man of him, but that is probably impossible. I trust, however, that all young men and boys who look on this picture will be inspired with a wholesome contempt for a man who has thus disgraced himself, and that none of them will ever commit such an outrage against the laws of decency.—EDITOR.

WHY NOT?

W. H. NELSON.

Let the rod take the place of the pen,
Stop hustling and crowding awhile;
Get away from the strivings of men,
Replace your stock frown with a smile;
For a fair place is waiting for you,
A trout stream swift follows the aisle;
Through the vaulted cathedral of woods,
With transepts of trout pools each mile.

Let the rod take the place of the pen,
Take heed of the beckoning stream;
Watch the silvery flash of the fish,
See the jump, the splash, and the gleam.
Skim the fly o'er the treasure-filled depths,
Drift close to the shadow-cooled brink—
There's a strike, and a tug, and a flight!
It's worth coming to win—don't you think?

There the din of the world's busy marts
Becomes as the breath of the noon;
And the sacred stream sings as it goes
An anthem in Freedom's glad tune.
And there sits on the moss-cushioned bank,
In the shade where the green willows bend,
His old face with contentment alight
Isaac Walton, the fisherman's friend.



NAME OF PHOTOGRAPHER UNKNOWN.

A REMARKABLE HEAD.

"What is it that makes men great, papa?"
"Persistent advertising, my son."—
Cleveland Plain Dealer.

FROM THE GAME FIELDS.

The man who quits when he gets enough, with plenty of game still in sight, is a real sportsman.

THEY ROAST THE REVEREND BRISTLE-
BACK.

San Antonio, Texas.

Rev. Ransome Williams,
Greenville, S. C.

Dear Sir—I read in the January number of RECREATION statements which, if true, prove you to be an energetic and strenuous hunter of game. You are accused of being most persevering after grouse and the plump bodied quail. Now, perseverance is a virtue when confined to proper lines, such as steering sinners into the highway of righteousness; but when used in the search of birds on their nest, with gun and dog, it places the hunter in the center of the road of sinfulness and greed; a position that no Christian gentleman will occupy. Evidence that a man will shoot birds in violation of the law and at the time when they are nesting or caring for their helpless young would cause the average sinner to have doubts about such person having been called to preach, or that a man could be useful in that calling. Such conduct in an alleged man of God should be rebuked by his church people, and if the law could reach him he should be prosecuted. If you are guilty of the acts of which you are accused you lack the attributes of a Christian. You are a hypocrite and have neither charity, sympathy, kindness of heart nor the fear of God. You should repent or quit your job and make room for a better man, who would act in a manner consistent with his calling.

Capt. L. L. Goodrich.
Watertown, N. Y.

To the Rev. Ransome Williams,
Greenville, S. C.

Sir—It is reported among Northern sportsmen that you pursue quails to the extermination of every one you can find, without hesitation; that you have said you would shoot male birds out of season; that you take your gun and dogs on your circuit of preaching; that on all your hunting trips you sneak out your board and lodging; and that in every act connected with your hunting you do not show the qualities of a real sportsman, but rather those of a selfish game hog, of which a man of your cloth ought to be ashamed. The manners you are said to employ would not work in this State. In the Adirondacks you could not get a bunk in any camp, nor a guide that would paddle you to fish. You ought to have respect enough for the Almighty to treat the rest of His animals with fair consideration, for it is not fair for yourself, as an animal, to try to exterminate all

the others. Try to reform; but if you do not, I hope you may some day have some fines to pay, besides otherwise running against the brick wall.

S. E. Stanton.

Morgantown, West Va.

Rev. Ransome Williams,
Greenville, S. C.

Dear Sir—It has become known that you are zealous in the pursuit of quails, grouse, etc., hunting almost every day during the open season, and sometimes out of season; that you generally try to kill all the game you possibly can, even to killing every quail in a covey. It is a lamentable fact that there are yet a good many hunters so grossly selfish, so narrow and so thoughtless that they hunt and kill as long as they can find anything to shoot at; but it is doubly deplorable when a minister is found conspicuous in the ranks of these game hogs, who are held in contempt by every lover of fair play and every true sportsman in the land.

Do you not think it would be a good idea to be in the future more considerate and more modest in your demands on the game supply? There are thousands of others who think so.

Bennett White.

Philadelphia, Pa.

Rev. Ransome Williams,
Greenville, S. C.

I see by RECREATION that you are in the pen, and I hope that before Mr. Shields and his friends get through with you they will have put a ring in your nose, so you can not root out. I have heard of clergymen who have committed every crime from chicken stealing to murder, and their crimes have called forth some expressions of mercy from men; but you are the first clerical game hog that has been brought to my attention, and you deserve no sympathy whatever. In some communities you would be kicked out and a coat of tar added to your bristles. It is a reflection on your parishioners that they allow you to remain. You have missed your calling; your place is in a slaughter house.

A. W. Davis.

Greenville, S. C.

Mr. G. O. Shields,
New York, N. Y.

Dear Sir—I reprinted in the Greenville News the roast you gave the Reverend Ransome J. Williams. I heartily endorse every word of your editorial, and believe it will have the desired effect. I know Williams personally, and he is supposed to be a

"big Ike" among the country churches; but when this editorial of yours is circulated by means of our semi-weekly edition among his country constituents I believe he will call a halt on his dastardly work of killing game out of season. Yours truly,

J. R. Horton, City Editor.

WILD LIFE SWEEPED AWAY.

The last fox is gone. The Brown boys killed him yesterday. Six men, armed with the latest patterns of breech loading guns, combined with 4 hounds, managed to get the last fox of the litter. How my heart went out to him as he passed close by me, hobbling on his 3 remaining legs, the blood dripping from his poor stump. He had lost one foot by the cruel trap, and was closely pursued by the hounds. In a few moments I heard 2 reports of a shot gun and one of the boys exclaimed, "Lewis has got him."

Now his ghastly carcass, thrown carelessly in a small tree-top, grins at every passer, a grim reminder of what was once so beautiful, so full of life and grace. My thoughts turn back to last spring, when I discovered him and his 6 little brothers and sisters gamboling near their burrow on the hillside. Their old mother lay stretched out near them, with her eyes half closed, dozing in the warmth of an April sun, but keeping a sharp lookout for danger. The little fellows played like kittens around their mother, racing and chasing each other. It was the prettiest sight I ever saw. How proud the old mother looked! It made me think of my wife and me as we watch our 3 boys in their play, with such joy in our hearts. If they should be taken away from us what a void would be left in our hearts! And to think of those 7 little foxes, all dead and gone, their little lives snuffed out by that big 2-legged animal called civilized man, fills my heart with sympathy for their mother.

Dear old RECREATION! I have just renewed my subscription and have received the first copy of the new year. How eagerly we all look for your coming! How my little boys all look for the pictures! They know every wild animal by sight. They say, "There is a mama deer; there is a papa deer," etc. The eldest boy, 8 years old, can tell the tracks in the snow of almost every animal at large in these parts. He learns them as easily as I did in the years gone by. He can identify nearly all the different trees, something he could never hope to learn at school. I know a college graduate here who recently sold a piece of woodland, and the only trees he knew were the pine and a white birch. He did not know an oak from a basswood, nor

an elm from a sugar maple, nor their value. He consequently sold the land for a mere song.

I have just read Mr. Russell's article on moose snaring in Nova Scotia, and note the writer's remarks on the hard time the wild animals have in their struggle for life. I live on the banks of the Batten Kill river, one of the best trout streams in the State. On the first of May the fishing commences. Formerly it was easy enough to catch a nice mess of trout, but for the last 2 years it is difficult to get a mess. Visitors from far and near come here to fish. They hire guides, pay \$2 a day, and furnish all the whiskey the guides will drink. They get boats and float down the river. Nearly every day this last season one of their boats went down stream and most of the parties got good strings of trout. We think they get them by unfair means, for we who live here can scarcely get a rise.

As soon as the fishing ceases the hunting begins, and the grouse, woodcocks and squirrels have to take it. We have 2 or 3 men here who are expert wing shots. They clean up everything that runs or flies, then take them to town, sell them, and spend the money for whiskey.

The last 2 years there has been a brood of grouse raised near my house and they saw me so often they got quite tame. These men have both years killed every one of these birds. The same with the grays. On the hill, in a large hickory tree, we used to see last fall 2 beautiful gray squirrels nearly every day, as we went by to work. I would not shoot them, but liked to see them and have them near. One day we missed them, and on looking around under the tree 2 empty shells told the story.

So it goes with all our wild creatures. I might go on and tell how I saw the rabbit and the weasel track in the snow, how I followed on until I found where the weasel had caught poor bunny, and how he drank every drop of blood. Not even one stained the snow.

I could tell how the hunters kill the coons, skunks, and foxes, how the hounds relentlessly chase the deer, how they occasionally get one, and go on through the entire list. But I will close with the kind wish that your good work may go on until the coming generation shall learn to reason and to desist from their deadly work of wiping from the face of the earth all that swims, flies or walks.

C. H. Cufut, Arlington, Vt.

A BIG FLIGHT IN THE TULE.

DR. R. F. MILLAR.

One evening my cousin S. and I drove to Tule basin, 10 miles from our home, intending to spend the following day shooting ducks. It was at the time of year when

the Sacramento river usually overflows a territory 50 miles long by 6 or 8 wide. We reached our camp, a deserted house in the low land, at 10 p. m.

After putting up our horse, we went out to see if the water was low enough to permit us to get through the tules on foot. We found it would be impossible to do any shooting except from boats. Accordingly we searched the loft of the old house in the hope that somebody had been considerate enough to hide a boat there. We found 2, or, rather, we found one boat and something that had been a boat. Both were of the usual Californian pattern, 14 to 16 feet long, 18 inches wide on the bottom, and designed to carry but one person. They are built narrow, so they may be pushed into the tules without spreading the reeds enough to betray the position of the shooter to the sharp sighted water fowl.

We requisitioned the boats for our own service. It was agreed S. should use the good one. I worked until 1 p. m. driving rags and rope into the gaping seams of the wreck that fell to my share. I also appropriated a pot of white lead and bedaubed the cracks of my ancient craft. Having made it, as I supposed, water tight, I turned in on a bed of hay and slept until 4 o'clock. Then we arose, ate breakfast, and carried our boats 300 yards or so to the water's edge.

We heard a few familiar sounds, but not the deafening roar of thousands of birds that we were used to hearing at that place and season. Putting the boats in we started, S. ahead. Despite the overhauling I had given my boat, she leaked badly, and every little while I was forced to bail her. S. made fine headway in his craft, and was soon lost to view in the distance.

It was nearly 10 a. m. when I reached the place where I intended to shoot. Arriving and turning a point in the tules I saw thousands of ducks of all kinds. They would rise in clouds and settle again near by; but as they were feeding on bugs at the edge of the rising water there was no particular flight that could be located.

I saw my chance of getting any birds was decidedly poor. Had I had a decent boat, I should have paddled about in the hope of jumping on an occasional duck within range.

Noticing a likely bunch of tules 20 yards from a point of the main body, I determined to push into it, rest awhile and then return to camp. Hardly had I finished breaking the reed tops to hide myself and boat, when a strong North wind sprang up. As it increased in force the ducks began to move. In 15 minutes they had opened a steady flight, in bunches of 2 to 50 birds, directly over my hiding place.

At first I shot at everything that passed,

regardless of species. But as I could see nothing but ducks, ducks and still more ducks, I grew choice and determined to kill only mallards, with perhaps a few sprig between times. I never ceased shooting from 11 o'clock until 12.30, save when I was dipping my gun into the water to cool it. It was the chance of a lifetime, and I regret to say I took full advantage of my luck.

When I had expended the 100 shells I had with me, the flight was, if anything, denser than before. I picked up 63 ducks, and of them 40 were mallard drakes. An old white goose that got in line with a passing duck was killed by accident and did not count. When I started back I found the load was too much for the old boat. It leaked faster than I could bail. There was nothing for it but to step into 3 feet of water and tow the boat in the teeth of a howling wind. After a mile of this traveling I was totally exhausted and could not tow a foot farther. I wedged the wreck in the reeds and started across country for camp. I was too tired to carry even my gun, and left it in the sinking boat. Trudging wearily along, I finally reached the house, more dead than alive. S. was there, cleaning his game, of which he had fully as much as I. After resting we drove back for my gun and birds; leaving the old boat to the mercies of the wind and waves.

IN THE BLUE MOUNTAINS.

W. A. SHELTON.

We left home May 12 and hunted next day till noon, finding plenty of bear signs but no bear, and in the afternoon moved camp. Next day we killed one bear. After traveling 17 miles in snow 6 inches to 6 feet deep we struck the trail of an old one and her cub. The sign was 24 hours old. I directed my companion to follow one ridge while I took another. Each took a dog along. Half an hour afterward I heard the cub "halloing," and knew the mother had winded me and was putting her baby up a tree.

I turned Fan loose, and she quickly treed the cub and followed the old one, which ran straight away, as she bears will, to draw the pursuit after herself. Fan didn't get back to camp till midnight, and then she was completely exhausted. As my companion had never killed a bear I turned the cub over to him for execution and waited an hour for him to come. He selected a fine opening, took a dead rest, and missed. I then shot it; we skinned it and went to camp. Moved camp to a tributary of Salmon creek, in the worst snow storm I saw that winter.

On the 17th I came on the tracks of an old bear and 2 cubs. I took my measures leisurely, selected a good rest, fired, and missed. Then I turned the dog loose put-

ing the cubs up a tree. My companion, hearing me shoot and catching Fan's music came to me, for a share in the fun. He, being something of an expert as a climber, I sent him up for the cubs, which, after a good deal of trouble he handed down to me. Slings them across our guns, their legs lashed together, we headed for camp. When a mile had been traversed I saw a large cinnamon coming directly toward me. He stopped at 100 yards and I fired, hitting him in the throat. He fell, but immediately sprang up and rushed for me. Waiting till he was within 30 feet I planted a shot that settled him. My companion was sure it was the boss of the woods.

On the 19th we made a long tour of 2 canyons and the intervening ridges. The dogs finally treed another bear, which I shot just as my companion reached me. Skinned it and went to camp.

Till noon of the 20th I worked in camp on the skins already obtained, but in the afternoon went out and when 4 miles from camp came upon a large bear at 500 yards. Getting the wind I crept to within 150 yards and fired. As the bear did not fall I shot twice more as it ran, killing it. In dressing it I found that I had hit it hard the first shot. I discovered on approaching that it was a mother, so decided to leave it till morning, so as to catch the cubs which would be sure to visit it. However, as I went campward past the point where I first saw her, I discovered the cubs in a tree. It was late and I was far from camp so I took off my jumper, spread it on the ground at the foot of the tree, showed the cubs to Fan, and bade her watch them till morning, but doubted whether she would. At 10 o'clock next morning when we got to the tree we found everything just as I had left it. Again "Pard" climbed and handed down the cubs.

Next morning we pulled out for home well satisfied with our killing. We started out with 4 cubs strapped on the pack horses, but bumped 2 of them to death *en route* against trees. Bear cubs are not easy to carry on pack horses. The 2 we brought home are tame as kittens and eat like pigs.

I have killed 27 bears in the last 2 springs.

NOVA SCOTIA WARDEN EXPLAINS.

I read in RECREATION "Moose Snaring in Nova Scotia," by Mr. Russell, with much interest. I have been an agent of the Game Society many years, and I have secured as many as 5 convictions for snaring in one year, besides destroying hundreds of snares. In nearly every county of this Province where moose are plentiful there are one or 2 gangs of professional outlaws who indulge in this "pastime," much in the way

Mr. Russell describes; but I regret to say he is wrong about their having no rifles. There are thousands of Snider breech loaders on the market which can be bought for \$4 each, or even less, and ammunition is cheap in proportion. Every one of these gangs is well known to the authorities. Following are the names and addresses of a few of them: The Day gang, Jeddene, East Halifax county; The Woodworth gang, Lake George, Kings county; The Garden of Eden gang, Borders of Picton and Ganesboro counties; The French Town gang, Clare, Digby county; The McIntosh gang, Sherbrooke, Guysboro county.

The last year's report of the game society states that 2 gangs, operating in Western Annapolis and Queens counties, were severely handled by the agents of those districts; and we have every reason to believe the outlaws have since gone out of business.

You may ask why, when the identity of every member of these gangs is known to the authorities, we do not take steps to bring the criminals to justice? We do all we possibly can with the small funds at our disposal; but I regret to say that unless we have absolutely clear evidence it is useless to prosecute. In addition to an organized system of poaching, these parties have an equally well organized system of perjury. I have had this to contend with on several occasions. Most of my convictions have been gained through Satan having been divided against Satan, and one or more poachers turning King's evidence to spite the others or save their own hides. We 30 game wardens have, as you say, 20,000 square miles to look after. Most of us are business or professional men, with small means, and we receive no salary. Had Mr. Russell sought the nearest game warden and laid a complaint before him, as perhaps he did, and backed that complaint by a strong letter to the chief game commissioner at Halifax, he should certainly have had the satisfaction of hearing that one or 2 of the rope-setting fiends had been run down and heavily fined or jailed.

Every sportsman in the United States and Canada should be grateful to you for the stand you have taken against the poacher, the pot hunter and the game hog; and though I regret that such an indictment of my own Province should appear in RECREATION, I would far rather have it chronicled in your pages than have such abominable cruelties committed and no notice taken of them.

I tracked one gang of rope setters 4 years before I got them; and I know of at least 3 others who are at the present time under surveillance, with bounties on their snouts. May the bounties soon be paid! I will send you a copy of our next annual report, and

you will find that the game wardens were not idle during 1902.

Agent, Game Society of Nova Scotia.

A CONSTITUTIONAL QUESTION SETTLED.

I have noticed in RECREATION on different occasions letters from readers expressing their opinion on the gun license question, especially on that of boys under 18 handling guns. Such people seem to forget that they were boys once themselves. It is not the small boy with the Flobert rifle who kills so many of the birds. The per cent killed by boys is small when compared with the per cent killed by the big overgrown boobies who run loose over the country, call themselves wing shots and kill birds just for practice. I am not taking into consideration the large number of birds killed for the millinery trade. Why jump on the small boy?

As a sportsman I am not opposed to a small license on guns, but as a citizen of the United States I am bitterly opposed to it, and I do not think such a law would be constitutional. This is what the constitution says: "Amendments to the Constitution. Art 2. A well regulated militia being necessary to the security of a free State, the right of the people to keep and bear arms shall not be infringed." If a gun license is not infringing that right, please tell me what is?

If a gun license law were passed by the Legislatures of the different States, some would have a small fee, while others would have it as much as a gun is worth, as in the case of the non-resident license, and so bar out the poor man. The non-resident license is an outrage on our liberty. Of course I do not think non-residents should have the same hunting rights as residents, except on public lands, and there one man has as much right as another. If the States, and especially the big game States, would follow the example of Colorado it would be better for all concerned; that is, put a license on every head taken out of the State. I do not think any hunter would object to that.

E. R. Forrest, Washington, Pa.

I referred this letter to Hon. John S. Wise, one of the best lawyers in the United States, who answers thus:

The provision of the Constitution of the United States quoted by the writer has been held to be a restriction on the powers of the national government, and not on those of the several States. See *State v. Shebby*, 90th Missouri, 302; *Andrews v. State*, 3d Heisk (Tenn.), 168; 165 Amer. Rep., 8, and *Miller v. Texas*, 153, U. S. 535. The States, having complete control of the game and fish within their borders, can

regulate the same by police regulations, and can, if they see fit, forbid the use of fowling pieces to destroy game or can tax the privilege of using them.

A NEW CAMP STOVE.

718,412. Portable Knockdown or Folding Camp Stove. Frank Bach, Jr., and Eli Crotteau, Phillips, Wis. Filed Aug. 21, 1902. Serial No. 120,500. (No model.)

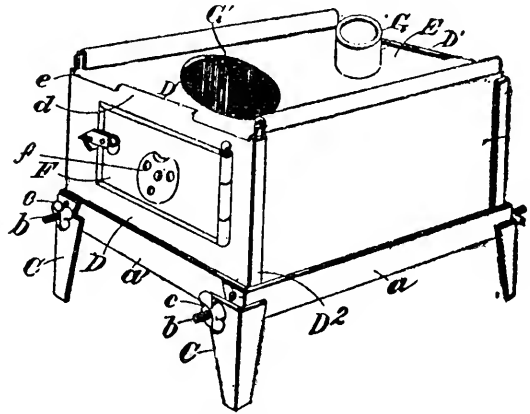

Claim—1. A portable stove comprising a base-plate provided with upstanding side and end flanges, side and end plates, and top plate, said top plate having inverted-U flanges on its sides adapted to engage the upper ends of side plates, all substantially as described.

2. The combination in a portable knockdown stove of a base-plate provided with side and end flanges, side plates hinged to the base-plate, a top plate having flanged sides adapted to engage the top edges of the side plates, and end plates attached to the ends of top plate and having flanges adapted to engage the ends of the side plates.

3. The herein-described portable knockdown stove, comprising a flanged base-plate, side plates hinged thereto, a top plate having inverted-U flanges on its sides adapted to engage the top edges of the side plates, and end plates hinged to the ends of the top plate and provided with flanges.

4. In a portable knockdown stove, the combination of base-plate, A, having upstanding side and end flanges, *a a'*, sides, B B, hinged to the base-plate, pivoted legs, C, so constructed that when in a vertical position they will brace themselves against the corners of the base; end plates D, D, and top plate E, said end plates and top plate being hinged together.

A SUMMER CAMP IN MICHIGAN.

June 3, 1901, George W. Marks and I left Ann Arbor for Manistique where we arrived the 5th. We hired a team, drove 25 miles North and camped on the Indian river in Schoolcraft county. We staid

there till November 30. There were 4 lakes within 5 miles of our camp. We built a log shanty 12 x 14 feet and covered it with birch bark. Someone set fire to it last spring and it is now a heap of ashes. Deer are becoming more numerous there every year. The men in the lumber camps are the ones who slaughter the deer. They kill them and sell them to the camps; but the lumber camps are fast disappearing. Where the timber once stood there are large cherry thickets which are a great protection for the deer. Almost every evening we rowed out on the lake to watch the deer as they came down to water. One family came every night, a buck, a doe and 2 fawns. The fawns played like little lambs. They jumped over each other and ran up and down the shore. The old ones were always on the lookout for danger, but they did not seem to notice us.

Ruffed grouse and spruce hens were plentiful, and there were any number of rabbits and red squirrels. There were also a few lynxes, bears and wolves. The lakes were full of pickerel, bass and perch; there were sturgeon and suckers in the river and trout in the creeks. There are large tracts of marsh where the deer find the best of feed, and there are many low bush huckleberries and large cranberries on the plains. Blackberries and red raspberries are also plentiful.

In the swamps the deer herd in winter. We killed 4 deer in November. We could have killed deer every day in summer, but we are not law breakers nor game hogs. I wish I had taken a camera with me. I could have obtained some fine pictures. I am going up again next summer. If anyone wishes a good time he should go there. Deer will always be numerous in Schoolcraft county. If anyone wishes information about the country I shall be glad to give it to him.

J. J. McCormick, 536 No. Main St.,
Ann Arbor, Mich.

GAME CONFISCATED IN OKLAHOMA.

Some grand work has been done by J. A. Gould, Territorial game warden of Oklahoma, and his deputies during the past year. Heretofore game shippers and game law breakers have practically bade defiance to all law; have done as they pleased; but they have recently had an experience that will most likely have a salutary effect. If other Territories and States had as active, conscientious wardens as Oklahoma has the way of the transgressor would indeed be hard, the illegal shipment of game would soon cease, and the market hunter disappear. December 18, 1902, Warden Gould captured 29 barrels of game being shipped through Enid on the C. R.

I. & P. R. R. There were 13 dozen prairie chickens, all the remainder being quails. The entire shipment weighed 6,500 pounds and was estimated to be worth over \$2,000. This game was shipped by a firm at O'Keene, in Blaine county, O. T., and was consigned to W. P. Kessler & Co., of St. Louis, Mo. Yesterday J. M. Wheeler, deputy warden for Garfield county, a good man for the place, located at Enid, captured 8 barrels of quails in transit through this city on the "Frisco"; also shipped from O'Keene, and for a blind, billed to Cripple Creek, Colorado, presumably by the same firm that shipped the 29 barrels first captured. Then again, to-day, Warden Gould captured 7 barrels of quails at Waukomis, in this county, consigned to J. H. White & Co., of Chicago. In view of these captures and confiscations, it is hardly likely these game dealers will realize any profit from their law breaking. There have been no arrests made as yet, but the officers know their men, and will finish the lesson later. Long live Warden Gould and his deputies! May the cause of game protection and its greatest champion, RECREATION, continue to prosper.

L. C. Elerick, Enid, Oklahoma.

Gould and Wheeler should both have good big pensions for life.—EDITOR.

COLORADO TOO EASY ON HOGS.

I have done my best to protect the game in this vicinity, yet it has been slaughtered shamefully in this part of the country. Deer and elk have been shot down and left to rot in the hills. I have seen such work year after year, and nothing has formerly been done about it; but I have put a stop to a good deal of it lately. The country is not properly protected and, despite the cry of the chief warden of this county, the slaughter will continue as long as the deputies sent in here are afraid to get out into the hills, where the slaughter is the worst. This is the home of the big game of North America, but unless the people take a different view of the matter from what they have at present it will not be long until there will be no deer or elk in the State. We not only have game hogs here, but we have fish hogs, men who are too lazy to do a day's work, but will take a pack train, go to the lakes, bring home a train load of fish and sell them. The citizens of Yampa protect such men. There are a number here for whom the name of game hog would be too good. Every sportsman in Colorado should try to put a stop to this work and pressure should be brought to bear on the Colorado officials to give better protection to this part of the State. I saw many carcasses lying in the hills last summer, shot merely for the fun of seeing the deer fall. Still

there are men who draw salaries from the State to protect the game. This is an excellent country for fish and game, and with a little protection there will be game here for years to come. There is a good road from Yampa direct to the best hunting grounds in the State; also a good trail from Yampa to Trappers' lake and Lost lake, where the fishing is unexcelled. Elk season is open from the 25th of October to the 5th of November. I shall enforce the law to the full extent of my ability.

M. J. Powers, Yampa, Colo.

THIS LODGE OF ELKS IS DIFFERENT.

The proposed hunt and game banquet for the local Elks is off. The proposition to have a game supper was first offered by Exalted Ruler Boyns, who thought the carrying out of the idea would insure for the participants in the hunt a good time and to the members generally a tempting feast. William Youngs and William B. Jarvis were named as captains of the rival teams. Each was authorized to select his team and they were to fix the dates.

When the captains considered the proposition, however, they realized that to carry out the idea meant to throw out 2 large squads of hunters not actuated by the ordinary rules of sport, but imbued with the desire to secure all the game they could, the side making the biggest killing winning. As both captains are members of the Consolidated Sportsmen's Association, they demurred.

The proposed game feast has, therefore, been declared off, and the local lodge of Elks has been placed on record emphatically as in favor of protecting the game of the State.

Unfortunately the subscriber who sent me this clipping failed to give me any data as to where it comes from. However, this lodge of Elks, wherever it may be located, has shown its superior judgment and has placed itself on record as being far in advance of certain other lodges of this and other orders, and even of some alleged sportsmen's clubs.

I wish all the men in the country who are confronted with any suggestion as to the holding of side hunts would table them as promptly as did this lodge of Elks.—EDITOR.

SHOULD HAVE BEEN SHOT.

RECREATION is the only magazine that has sand enough to roast game hogs and the still more despicable brutes who use ferrets. They deserve all they get. One day last fall, while in a piece of woods near my house, a rabbit came bounding past me with 4 hounds in close pursuit. The little fellow earthed near by and the hounds remained baying around the hole. In a few minutes 4 men came running up. One took a ferret from his pocket and put it down the burrow. When the fellow rose to his feet he was holding a rabbit. The men talked a while and then, loosing the dogs tossed the rabbit among them. The unfortunate little creature was torn to

pieces in an instant. A worse example of sheer brutality I never witnessed.

C. H. White, Haverhill, Mass.

If you had only had with you a Winchester repeating shot gun loaded with buck shot, and had been clothed with authority to use it, as it should have been used at that time, you could have made a fine record on these 2 legged brutes and their 4 legged servants. The whole outfit should have been laid out and sent to some soap-grease factory.—EDITOR.

TOO MANY SQUIRRELS.

Police Captain Frank Jones and Earl Soules returned last night from Hancock, where they had been hunting grey squirrels 2 days. They bagged 48 in spite of unfavorable weather, and it was the biggest string brought into the city this season.

Above clipping is from the North Adams Transcript. Jones and Soules make several trips like this each season. Jones also goes fishing every spring and his fishing is of the same grade as his hunting. Kindly give them a good roasting.

H. W. H., North Adams, Mass.

Captain Jones, in reply to my letter of inquiry admits the correctness of the Transcript's report.

This is indeed a beautiful story. In the first place no man should kill a grey squirrel at any time. In the second place, if Jones and his friends insist on hunting this harmless, beautiful creature, they should certainly be satisfied with 3 or 4 a day to each gun. I trust after thinking this matter over seriously they may decide never to kill another grey squirrel, under any circumstances, that they may advise their friends to adopt the squirrels as pets and to protect them at all times.—EDITOR.

GAME NOTES.

I enjoyed the article of H. N. Beecher, of Canon City, Colorado, entitled, "The Life Story of a Grizzly," as published in December last, in your valued magazine. I have hunted over much of the same territory and am acquainted with most of the parties he mentions. Only last October I killed a buck deer on one of the mountains he speaks of. Beecher's story was much appreciated here by the boys and while we have for years heard of the big bear we never knew his history. I was always under the impression that Whort killed him on Witcher mountain, about 20 miles West from this city.

I am much like you; I never kill anything unless I want the meat, except that I enjoy killing wild beasts. I killed an antelope, in Wyoming, in the early days out here, with a Colt's 45 caliber, from a horse on a fast run. I wounded the antelope, and had

to shoot it again to put it out of its misery, and after it looked into my eyes I felt like a sheep for doing such a deed. Ever since I have been careful to kill only what I can use.

V. H. M., Cripple Creek, Colo.

In reply to your letter will say I have not heard of any proposal to hold a side hunt here. I sincerely hope this town will never be disgraced by such an unsportsmanlike and inhuman slaughter of game. The Greenfield Sportsmen's club, of which I am vice-president, was organized to protect game. We have 150 members and have had one of our number appointed game warden. The indiscriminate destruction of game in the name of sport will soon, I hope, be a thing of the past. A side hunt was recently held at Conway, Mass., not far from here. I cannot express my contempt for the men who so disgrace themselves and their town.

L. A. Newton, Greenfield, Mass.

If all the side hunters could only be induced to read Dr. Newton's letter and to realize that it expresses the sentiment of all decent sportsmen in this land, it might possibly be the means of causing some of these antiquated butchers to discontinue their evil work.—EDITOR.

Mr. D. C. Nowlin, Chief Game Warden,
Big Piney, Wyo.

Governor Richards writes me that you have recently succeeded in convicting a man for killing elk for the teeth, and that the man was fined \$100. I congratulate you on this achievement. Will you kindly give me the name and address of the man?

G. O. Shields.

ANSWER.

The man you inquire about is William Binkley, of Grovont, Wyoming. He was fined \$100 and costs, total \$171, which he paid. It is but just to say that Binkley has quit hunting and gone to work, carrying the mails to Elk.

Shortly after Binkley was convicted Fred Korner, of the same place, was arrested and fined \$100 for hunting illegally. Public sentiment in Wyoming is changing and game protection is no longer a dream; though much remains to be done. Will try to get close season on antelope.

D. C. Nowlin, Cheyenne, Wyo.

I noticed at the annual meeting of the Brown's Track Guides' Association, held at old Forge, N. Y., a short time ago, that a resolution was adopted to give Mr. and Mrs. Bruin a chance to raise a family in peace from May 1st to October 1st. As the law now is, the bear is about the only

wild animal of the Adirondacks that is not protected by law during breeding season. I think this question should be taken up by the L. A. S., for there is no more genuine hunting than to follow a bear all day in November and at night sleep on the trail under Nature's roof, with snow for a pillow. Let us all see what we can do for the bears.

Geo. P. Langford, Vernon, N. Y.

I earnestly hope the bill may pass. The black bear should be protected for at least 10 years.—EDITOR.

The razorback from Pendleton, Ore., who signs J. W. Lane to his "Western Sentiments" assumes a great deal by saying "we" unless there are others of his breed in his sty. I travel continually and have hunted all over the West the last 5 years. Have hunted with sportsmen from Pendleton and want you to tell your readers there are no fairer or more honorable hunters anywhere than those in Pendleton, with the exception of Lane and "We." I notice RECREATION has friends all over this Western country, and everywhere among real thoroughbred sportsmen your excellent work in the defense of game preservation is highly appreciated.

Ed. J. Fisher, Seattle, Wash.

Long may you live to down the game hogs. The killing of small birds for decorative purposes is unpardonable and infinitely worse than game hoggishness. I tried hard to get the New Brunswick Legislature to put a stop to this barbarity. We have good game laws here, but they are laxly enforced. A great many deer are hunted with hounds on the borders of New Brunswick and Maine. The hunters can dodge over the line whenever they think danger is at hand. Our taxidermist at St. Stephens told me that all the deer sent to him from that region were shot in the head; that means usually that they were swimming when killed.

J. H. Mears, Bay Side, N. B.

Where can I obtain county or township maps of Northern Michigan, showing trails, streams, swamps, etc.?

G. D. Hill, Marshall, Mich.

RECREATION is the most popular magazine on the road, so the traveling men say.
Jas. W. Cheesewright, Boise, Idaho.

RECREATION is the best sportsman's magazine published.

F. O. Rood, Estherville, Iowa.

No lover of sport can get along without RECREATION. E. A. Porter, Lincoln, Neb.

FISH AND FISHING.

ALMANAC FOR SALT WATER FISHERMEN.

The following will be found accurate and valuable for the vicinity of New York City:

Kingfish—Barb, Sea-Mink, Whiting. June to September. Haunts: The surf and deep channels of strong tide streams. Baits: Blood worms, shedder crabs and beach crustaceans. Time and tide: Flood, early morning.

Plaice—Fluke, Turbot, Flounder. May 15 to November 30. Haunts: The surf, mouth of tidal streams. Baits: Shedder crabs, killi-fish, sand laut. Time and tide: Ebb, daytime exclusively.

Spanish mackerel—Haunts: The open sea, July to September. Baits: Menhaden, trolling—metal and cedar squids.

Striped Bass—Rock Fish, Green Head. April to November. Haunts: The surf, bays, estuaries and tidal streams. Baits: Blood worms, shedder crabs, Calico crabs, small eels, menhaden. Time and tide. Night, half flood to flood, to half ebb.

The Drums, Red and Black. June to November. Haunts: The surf and mouths of large bays. Bait: Skinner crab. Time and tide: Day, flood.

Blackfish—Tautog, April to November. Haunts: Surf, vicinity of piling and old wrecks in bays. Baits: Sand worm, blood worm, shedder crabs, clams. Time and tide: Daytime, flood.

Lafayette—Spot, Goody, Cape May Goody. August to October. Haunts: Channels of tidal streams. Baits: Shedder crabs, sand worms, clams. Time and Tide: Day and night flood.

Croker—July to October. Haunts: Deep channels of bays. Baits: Shedder crabs, mussels. Time and tide: Day, flood.

Snapper—Young of Blue Fish. August to November. Haunts: Rivers and all tide ways. Baits: Spearing and menhaden; trolling pearl squid. Time and tide: Day, all tides.

Sheepshead—June to October. Haunts: Surf and bays, vicinity of old wrecks. Baits: Clams, mussels, shedder crabs. Time and tide: Day, flood only.

New England Whiting—Winter Weak-fish, Frost-fish. November to May. Haunts: The surf. Baits: Sand laut, spearing. Time and tide: Night, flood.

Hake—Ling. October to June. Haunts: Open sea surf, large bays. Baits: Clams, mussels, fish. Time and tide: Day and night, flood.

Weak-fish—Squeteague, Squit. June to October. Haunts: Surf, all tideways. Baits: Shedder crabs, surf mullet, menhaden, ledge mussels, sand laut, shrimp. Time and tide: Day and night, flood preferred.

Blue Fish—Horse Hackerel. June to November 1st. Haunts: Surf, open sea and large bays. Baits: Menhaden, surf mullet and trolling squid. Time and tide: Daytime; not affected by tides.

Claim.—1. In a fish-grapple, a handle carrying reversely curved jaws, means for forcibly closing said jaws together, and a trigger disposed intermediately between the ends of said jaws and their points of attachment for supporting the said jaws distended, and releasable by pressure exerted inward from the inlet to the jaws, substantially as set forth.

2. In a fish-grapple, an operative handle, a curved stationary jaw carried by said handle, a reversely curved movable jaw carried by said handle, means for forcibly closing said movable jaw, and a trigger member disposed to support said movable jaw open, and adapted to be released by pressure exerted inwardly from the inlet to the jaws.

3. In a fish-grapple, a handle, a stationary curved jaw member carried by said handle, a reversely curved jaw member movably connected to said handle, a spring carried by said handle means connecting said spring and said movable jaw whereby said spring operates to maintain said movable jaw normally closed, and a trigger disposed to hold said movable jaw distended and releasable by pressure exerted inwardly from the inlet to said jaws.

4. In a fish-grapple, a handle having a stationary and a movable jaw member, a pulley upon each of said members, a cord attached to one of said jaw members and passing around said pulleys, a spring connecting said cord with a point of attachment and operating to hold the jaws normally closed, and a trigger disposed to support said jaw members open, and releasable by the pressure of the fish when the grapple is operated.

5. In a fish-grapple, an operative handle, jaws carried by said handle, a spring adapted to close said jaws, and a lever-arm between said spring and operative handle and adapted to distend said spring to increase its force.

718,416. Fishing Reel. Abner W. Bishop, Racine, Wis. Filed April 11, 1902. Serial No. 102,451. (No model.)

Claim.—1. The combination with one of

NEW PATENTS FOR ANGLERS.
718,079. Fish-Grapple. Charles A. Bindhammer, Chicago, Ill. Filed March 22, 1902. Serial No. 99,485. (No model.)

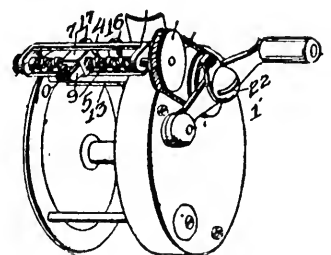
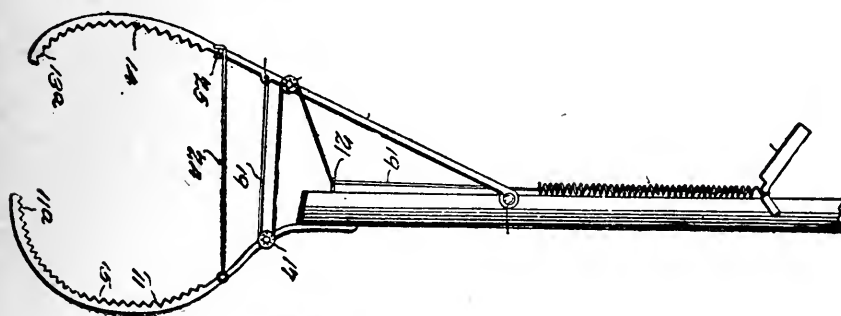

the frame-rods of a reel, of a line-guide having clamping means to engage the rod, an actuating-shaft, and means for operatively connecting the shaft with the reel crank-shaft.

2. The combination with one of the frame rods of a reel, of a line-guide having clamping means for engaging the rod, an actuating-shaft, means for operatively connecting the shaft with the reel crank-shaft, and a reversible line-carrier mounted by the actuating-shaft.

3. A reel having a crank-arbor provided with a pulley, a line-guide having clamping means for engaging one of the frame-rods of the reel, a line-carrier, an actuating-shaft therefor provided with a pulley, and motion-transmitting means connecting the pulleys.

4. The combination with a reel, of a line-guide comprising a fixed and a detachable clamping-plate, the latter plate being provided with means for engaging one of the connecting-bars of the reel, and means for holding the plates in fixed relation to the bar.

5. The combination with a reel, of a line-guide, the actuating-shaft of which is provided with a pulley, a pulley mounted on the crank-arbor and having an orificed arm adapted to be clamped against the crank-arbor to hold the latter pulley from turning independently of the arbor, and a belt connecting the 2 pulleys.

TRAPPERS' LAKE.

For ideal fishing, ideal country and ideal climate, no place can, to my mind, compare with Trapper's lake, in Garfield county, Colorado. Not only can trout be caught in any number desired, in this most beautiful lake, but by going 5 or 10 miles down the North fork of the White river as good deer and elk country can be found as anyone could wish, not to speak of grouse, squirrels and other small game to be had in fair number. The lake can not be reached by wagon, but several trails lead to it from various directions; one from Yampa, besides the one from the North fork of the White river, and one or 2 others.

The trail over the Flat Top mountains from Yampa is a trifle steep in places, but the angler is repaid a thousand times for any hardships he may have to endure to reach this lake. Of an irregular, elliptical slope, it is nearly surrounded by the Flat Top mountains, whose precipitous summits and densely clad slopes are beautifully reflected in its clear waters. The lake is about $\frac{3}{4}$ of a mile long and one-third of a mile wide. It has been sounded to a depth of 1,300 feet, and no bottom has yet been found. Numerous coves and indentations relieve the monotony of its wooded shores, and occasionally a rocky

point projects into the water. On these rocky points, where the water is deep, the best fish are caught, although excellent fish are also taken from over the deep water. The cove trout caught in shallow water are not of such fine quality as the deep water feeders. In length they seldom exceed 16 to 18 inches, averaging 11 to 14. There seems to be no limit to the number of fish in the lake, which bite anything moving on the water. As we sat cleaning a grouse on the shore of the lake one day, many of the feathers blew into the lake, but few got beyond 75 yards from the shore before being seized by the voracious fish. Another time we threw back into the lake a trout, which was in rather poor condition. While it lay momentarily on its side, before regaining its vitality, another trout seized it and shook it violently, repeating the shaking several times, while it raised quite a foam on the water by its violent efforts to make away with its prize. One sometimes hears the report that the Trapper's lake fish are thin and in poor shape. Some are, but it is not necessary to keep them. There are plenty in good condition, ready and anxious to take the fly, putting up an excellent fight when hooked. He who has, for several months, been anticipating a feast of trout, will eat a large number of them before tiring of the diet, for indeed a trout well cooked is fit for any king to eat!

It is almost with sorrow that one is compelled to leave such magnificent country and such excellent fishing to hurry back to the routine of city existence; carrying back, nevertheless, not only a renewed store of energy and health, but memories which will long remain fresh and keep alive anticipations of another visit to this favored country.

Geo. H. Scibird, Colorado Springs, Colo.

THE SCORE TOO LARGE.

A reader of RECREATION sent me the following clipping:

Bert Butterworth and a party of friends returned to the city last night after a day's fishing at Skykomich. According to Mr. Butterworth, his party of 3 in less than 6 hours caught 350 trout. He says the river is still a little high, but the fish are biting. According to the people of the mountain village that 350 catch was the largest of the season.—Seattle Times.

I wrote Mr. Butterworth for confirmation of this report and received the following reply:

Mr. L. Blackburn and I caught 225 trout in 5 hours and threw back all under 6 or 8 inches.

G. M. Butterworth, Seattle, Wash.

That was at the rate of 22 trout an hour or one every 3 minutes to each rod. No decent angler would consider that sport. It was merely yanking the trout out of the

water. There is no fun in hooking an under sized trout and throwing him out on the shore, even if you do put him back. If a trout is any considerable size he will give a man good sport for 10 or 15 minutes. If he be a fingerling then it is all right to take him off the hook and set him free in his native element as quickly as possible. You and your friends were evidently not fishing for sport, but for a record.

You say you threw back all under 6 or 8 inches. You do not say what proportion of the fish that included. It may mean that you threw back half a dozen. It may mean that you threw back 200, but judging from your statement that you and your friends each took a trout every 3 minutes, every decent man will infer that you are the kind of men who keep all the fish they get and that you took the majority of them home with you. If you wish to be classed as a true sportsman, you should have told just how many you threw back and just how many you killed, but the inference is you were ashamed to tell the truth. That is a good sign as far as it goes. It leads me to hope you may soon learn to enjoy an hour or 2 of decent fishing in a day and if you get enough in that time to quit, and not to keep on yanking fish out just to be able to tell that you caught more than someone else did. There are other ways in which gentlemen can enjoy themselves in the woods than by running up big scores.—
EDITOR.

AFTER BASS IN THE WABASH.

One bright morning in October father and I went to Bonewitt's eddy, about 11 miles from home, for bass. Father's tackle consisted of an 8-ounce bamboo rod, 100 feet of braided silk line, an automatic reel, a 6-foot minnow net and a minnow bucket which he had made himself. I had an 11-foot cane rod with 30 feet of common line. This outfit we put in the wagon, with our box of provisions and plenty of bedding, and about 2 o'clock in the afternoon we started. At Big eddy we struck camp, just at sundown. The next morning we ate an early breakfast and were at the river, ready for business, by daylight. Father put on a minnow, cast it out and laid his rod on some willows, while he should help me untangle my line. He had scarcely turned around when his reel went ziss—ziss—ziss! and his line ran out about 15 feet a second. He caught up his rod and the fish bent it nearly double. Father finally landed him, a 3-pound black bass. My first catch was a pound bass, which rose the instant the minnow struck the water. They bit well until about 9 o'clock.

After dinner we started down the long eddy, wading out to the middle of the river. We did not get a bite until about

3 o'clock, when we were just at the end of the eddy. I got a strike, but it happened to be a shad, the largest one I ever saw.

Then father waded out to the bank and said he would climb a tree to see if there were any bass below us. After he got up the tree he looked about 30 yards below me and said he saw 25 or more bass, all in a bunch. I waded down within 25 feet of them and father told me where to cast. My minnow had no more than hit the water when a big bass grabbed it and came near jerking the rod out of my hands. By that time father had fallen out of the tree and got hold of his rod. He cast right into the bunch and got a good run, but missed it. While he was reeling in his line another fish grabbed his minnow and he missed that one also. He kept on until he had missed 5. Then he got discouraged, emptied his minnows out and we quit, for we had 17 bass and one shad, which we called a good day's catch.

Ancil Cook, Warren, Ind.

HOW THE PIKE CAUGHT OLD JOE.

Old Joe was what might be called a river rat. He had worked as a boy at logging and rafting, and later as river pilot and as guide through the dense forest that bordered on the St. Lawrence river. He was, of course, an angler of much experience. He lived a sort of a hermit life in a shanty on the outskirts of the town and near our farm. It used to be the height of our youthful ambition to be near old Joe. He would entertain us for hours with tales of his experiences on the river. He passed the winters trapping, and the summers fishing and doing odd jobs. If one of us boys could go fishing with him we were on the summit of glory. Once father assigned me a number of rows of weeds to pull and told me when I had finished I might go fishing. I finished my work, dug my bait and went down to get Joe's permission to go with him the next day. After considering a while he said I might go if I would keep still in the boat. Being relieved of all anxiety, dad's overcoat would not have made a vest large enough for me. On the way home it seemed as if I was walking on air.

After dreaming of boats, big fish, lines, etc., all night we made an early start. Trolling up the river, catching occasionally a small bass or pike, we finally anchored at a bend in the river called Marble ledge and noted for its large pike. I was catching perch, rock bass, sunfish, etc., when suddenly Joe exclaimed,

"I've got a strike and he's a big one."

In his eagerness to land the fish he swung it clear of the water and in some way one of the hooks caught Joe in the

nose. The fish was squirming and flopping madly and hanging on Joe's nose. The fish jerked till finally he tore loose and left a slit in Joe's nose, from which the blood streamed.

Of course our day's sport was spoiled. Joe finally pulled up anchor and we started back down the river. Joe never said a word but occasionally he gave the fish a vicious kick, as an expression of his feelings.

Frank Corlis, Dansville, N. Y.

THEY SHOULD BE PROSECUTED.

Jack Minnick, Burt Berger and John Karterman returned Wednesday from a fishing trip to Oliver's lake with about 800 pound of fish. This is a true story, as they were all day dealing out fish to the multitude.

I send above clipping with sincere thanks for the rough shod way in which you jump on such swine. Moreover, I have a selfish motive; I like to fish myself.

Q. L. W., Ida Grove, Ia.

I wrote Karterman and Burger. They answered on the backs of my letters.

Kartman says, "The information is incorrect."

Burger says, "That sounds a little fishy to me."

The story not only sounds fishy, but fish hoggy, and no doubt the men who did the fishing would smell that way if you got within 50 yards of them. Evidently these men know RECREATION and have a suspicion of what is in store for them, but their attempt at evasion is not successful. I have positive information from 2 well known business men of Ida Grove that the report is correct. The fish were taken with a seine, in open violation of the State law, and were peddled out in the streets of Ida Grove. I trust the proper authorities will see that these men are prosecuted and fined for their slaughter.—EDITOR.

SELF-CONFESSED SWINE.

Residents of Alton bay are talking of the success of 2 fishermen there. In the past 5 weeks A. J. Mayhew and J. K. Rhodes have taken in 1919 fish of different kinds, and the other fishermen are beginning to look on them as specimens of the fish hog that RECREATION tells about.—Manchester Mirror.

I wrote Mayhew and Rhodes, asking about it, and they replied:

The statement is correct. We caught enough to swell that number to 2,450. They were mountain trout, except 60 bass and pickerel. The time was about 6 weeks.

A. J. Mayhew, Manchester, N. H.

That statement was made when we had been about 5 weeks on our vacation. We were gone 6 weeks and in all we caught

2,450 fish. They were pickerel, bass and mountain trout, or horned pouts. We used common line and hook, and baited with worms. I do not know why you wish to know.

J. K. Rhodes, Manchester, N. H.

This is why I wished to know: So that in case the report were true, I might brand you as low, dirty swine. And that is what you are, according to your own confession.
EDITOR.

NIBBLES.

I have read Charles O. Jackola's letter. Instead of your insulting him, he has insulted you. "Swine" is too good a name for him. A hog eats only to satisfy its appetite. I admit his appetite is large, but what he eats he turns into good flesh, fit to eat. Anyone catching 1,000 pounds of fish is 10 times a hog. People make those large catches for the publicity of the thing and they are referred to as wonderful fishermen. To me the most wonderful angler is one who has the opportunity of catching 1,000 pounds of fish but quits when he has enough to eat, and leaves the rest for some future time and some brother angler. One who does that, shows human intellect; but one who continues to fish as long as it is possible shows only animal instinct. Legally, Jackola may have a good case, but morally he ought to be so thoroughly ashamed that he ought to thank you for waking him up.

G. De P. Fox, Great Barrington, Mass.

Charles Kinzie, of Richland Center, and W. A. McNurlin, of Richland City, Wis., took a trip to the North last week. They were gone 4 days and say they caught nearly 60 trout. Better give them a dose of RECREATION's anti-fish hog medicine.

Sam S. Covey, Sextonville, Wis.

To my request for confirmation of this report I received the following reply:

Five hundred in 3 days is correct.

W. A. McNurlin, Richland Center, Wis.

So you and Kinzie join the herd of Wisconsin swine, and I trust the decent people in your town may all refuse to associate with you in future.—EDITOR.

Have just returned from a fishing trip to Two Medicine lakes. Had 2 companions and we had a delightful time.

R. S. Stringfellow, Havre, Mont.

Fishing on the Kankakee river, at Shelby, Ind., is the best now that I have seen for 10 years.

W. A. Daily, Indianapolis, Ind.

GUNS AND AMMUNITION.

Anybody can shoot all day, but a gentleman will quit when he gets enough.

THE 30-30 WINCHESTER.

About 6 years ago my old 44-40 was consigned to the scrap heap and I bought a 30-30 Winchester. It came equipped with Lyman sights, as all hunting rifles should, and its first 10 shots at 100 yards were put in a 2 inch circle. Six years' experience hunting and exploring in the most remote corners of North America have not shaken my faith in it. Some men shoot a rifle at a deer or 2, note the effect of the bullet and then rush into print for or against the arm. That is not a fair trial; and for this reason I have not told of the first buck killed in its tracks with a shot far back, at 100 yards, but have waited until the notches in my stock number well into the 30's. Of big game shot with this gun not an animal has escaped to die a lingering death. True, I have had one or 2 long trails to follow; but who, of those who have held sights on much big game, has not? A sportsman will frequently condemn a gun when a deer shot with it through the heart runs 100 yards or so before dropping. I have only seen or heard of 2 deer, in at least 500 known cases, which dropped to a heart shot when the shoulders were not broken. I well remember one wintry morning in November when I, turned the 30-30 loose on a big mule deer buck. It was in a little muskeag swamp on what is known as the Ground Hog range, near the headwaters of the Skeena river in British Columbia, that I jumped the buck. He ran up the side of a grassy knoll to the right, offering a splendid shot, but did not drop until the fourth shot. All those 4 shots could be covered by my hand, just back of the left shoulder. The heart was gone completely.

Earlier in the same season I accounted for 3 deer and a white goat with one shot each. The shot which killed the goat was especially remarkable. I saw him about 500 yards off and proceeded to stalk him. When I next caught sight of him he was on the side of a steep bluff, 74 yards above me. At the first shot Billy toppled over and landed within 2 feet of me, without a quiver. The bullet entered underneath the stomach and passed out at the back without striking a bone, yet had killed instantly. Many such experiences, from Maine to the Pacific, have convinced me that the rifle possesses sufficient accuracy and killing power for any American sportsman.

This rifle should be sighted point blank at 50 yards to enable one to cut off the heads of geese, etc. As sent from the fac-

tory with plain open sights they are usually sighted at a 200 yard target, and will shoot 5 inches high at 100 yards, with the rear sight down. When sighted for 50 yards no change will be necessary up to 125 yards. For 200 yards, raise the Lyman sight one degree above the 50 yard mark on the stem.

The only low power load I have been able to use with complete success is as follows: Kephart's Ideal bullet No. 308,-206, 125 grains, cast 1 to 10 and lubricated with Leopold's Ideal Banana lubricant; 20 grains Du Pont No. 1 or No. 2 smokeless rifle powder or 12 grains, black powder measure, Laflin & Rand Sporting Rifle smokeless; Winchester No. 2½ primer. Powder loaded loose in the shell. Bullet unsized. This bullet is too large to fit the expanded shell. The neck of the shell must be reamed out with a 5-16 inch reamer and the sharp corner left by the reamer chamfered off with an old pocket knife. The bullet is then seated to just cover the broad groove. The dirt escaping groove of the bullet should be filled with lubricant. This exposure of lubricant outside the shell will give the rifleman the impression that the shell is no good for hunting purposes on account of dirt, etc.; but I have carried cartridges thus loaded in a web cartridge belt 5 months in the mountains and they were as accurate when fired as those freshly loaded. Do not attempt to size the bullet to fit in the shell, for when sized to .305, which the manufacturers give as correct for this rifle, gas cutting will occur and the bullets will scatter all over the target.

Loaded as described this load will keep its shots under a silver dollar at 50 yards. It will not mangle grouse; does not wear the barrel; is inexpensive, and is a little stronger than the 32-20 cartridge. At 50 yards it requires an elevation of 3½ points above the 50 yard point blank elevation for the full power load.

If you fire high power cartridges through your barrel always clean before using low power. Otherwise the gun will lead badly.

Cleaning high power guns seems a stumbling block to most riflemen; hundreds of high power rifles have been ruined by ignorance in this matter. Old black powder methods will not do. High pressure nitro powders leave an intensely acid residue, which, if not removed soon after firing, and neutralized, will rust and pit the barrel badly. This residue is in the form of a thin, gummy coating which can

often hardly be seen and sticks obstinately. The only royal road to safety is a liberal use of brass wire, bristle brushes and soda water, followed by dry rags and oil. Be careful in cleaning the muzzle of the rifle. Do not allow your rod to touch this at all. It is the most vulnerable part of the arm. Any injury to, or dulling of the muzzle of a rifle will absolutely destroy all accuracy.

All in all, the little 30-30 has much to commend it. It balances perfectly and is not breech heavy as most modern guns are. It never jams or fails to work, and can be easily used as a single loader, holding the magazine in reserve, by not throwing the lever down to its fullest extent. Its front sight is not thin and high with a thick base, making one liable to overshoot when in a hurry by sighting on the thick base instead of the thin top of the sight. Its barrel is stiff enough to admit using different loads with the same lateral adjustment of the sights and as it uses copper jacketed bullets instead of the usual cupro nickel steel, the barrel does not wear out quickly. In fact, the life of the barrel is almost indefinite. As nearly as I can judge, my rifle has fired at least 3,000 jacketed bullets and about 2,000 lead bullets of all kinds. It has always been cleaned with a brass wire bristle brush.

Townsend Whelen,
2d Lieut. and Rangemaster,
First Regiment Infantry, N. G. P.,
Philadelphia.

THE GUNS OF OUR BOYHOOD.

W. J. FLEMING.

When I was 11 years old my father bought me a single muzzle loader, light, handy and the best of its kind. Father believed in No. 3 shot and with that size I did most of my shooting the first 3 or 4 years. Boylike, I began by shooting sparrows, then crows and rabbits sitting. Later I shot my first snipe and grouse on the wing with No. 3 shot.

When about 17 years of age I exchanged this gun for a double muzzle loader. I had become used to the other and for some time did poor shooting with the new weapon. It would not kill within 15 yards of as far as the single gun. About that time I saw a few wire cartridges and tried in vain to buy some in a neighboring town. Then I set my wits to work to make something as good.

I dressed a piece of wood perfectly round and of a size to fit the barrels when wound with a few turns of coarse muslin. I glued the muslin lightly, turned in the lower edge and glued a wad on. When dry I put in my load of shot, turned in the other edge and glued on another wad;

I then painted the outside of the little case with glue. I waited until they were perfectly dry and at the first opportunity had a trial. It chanced to be on a sitting rabbit at 30 yards. All I could find of bunny was his ears and hind feet. I tried another on a board at 60 yards, but the pattern was still too close. After that I made the cases of more open material and could kill easily with them up to 100 yards. People seeing the long shots, I made believed I had the best gun ever made.

On one occasion I winged a grouse with my muzzle loader and was reloading my gun, at the same time keeping an eye on my dog and bird. In some way I put the 2 charges of powder in the left barrel and the wads and shot in the right. A little later I saw a pigeon and let it have the left barrel. The recoil knocked me flat on my back. As I went over I caught sight of a horse in the line of fire and about 300 yards away. When I regained my feet the horse was running about and snorting in the wildest manner. I jumped to the conclusion that I had made a record-breaking shot and peppered the poor animal. I beat a hasty retreat, and was greatly relieved when investigating a subsequent misfire, I found the right barrel double shotted and wadded.

A second exploit was still worse. I was using a heavy copper powder flask and had just had it filled with the best powder. A friend and I were out after ducks. I had learned to smoke about that time, and by oversight put my lighted pipe in a pocket along with my handkerchief and the powder flask. Presently we smelled something burning and traced the fire to my pocket. I snatched out the flask and threw it on the ground. When I had extinguished the fire and went to pick up the flask, it was so hot I could not hold it in my hands. These 2 frights taught me a useful lesson concerning the special dangers of muzzle loading guns.

My first breechloader was a cheap cylinder bore and not good for much. I sold it and gave a good English maker an order for a gun with left barrel full choke. When it arrived I made up my mind to have a few days' good shooting. Everything was in my favor, but I came home without a bird. I was wild and wrote to the maker about the performance of the gun. He answered that the gun evidently did not fit me and told me to return it and tell him the length and bend of the gun that suited me best. I had to wait 2 months while he made me another gun. It was well worth waiting for, as I never saw its equal at any price.

Up to that time I thought all gun stocks were alike; but this little matter opened my eyes, and leaves me still of opinion

that a great deal of bad shooting is caused by the gun not suiting the user.

I sold this gun before coming to this country and now have a Remington, made to order, which is giving me entire satisfaction.

It is only us old fellows who can appreciate the great advance of the gunmaker's art in the last 30 years.

THE TRIGGERLESS GUN.

Everybody who makes any pretension to being a hunter has seen hammerless guns, but I am certain that a triggerless shot gun is something unusual; yet I have seen a man hunt with one and bring down his game, too.

In the latter part of December a friend with whom I usually hunt drove with me to the little village of Mequon, 12 miles North of Milwaukee. In my boyhood days I had camped for a week on a farmer's land in that vicinity, and I suggested that we leave our horse at his place. I hoped the old German farmer would recognize in the full grown man the freckle-faced boy of 14 who caught so many bullheads in the river 18 years ago.

On our hail, the farmer opened the door and came toward us. There was something peculiar about his walk. Although he faced us his feet seemed meditating a flank movement to the right. Ah, thought I, he is half a mind to set the dog on us. How greatly I wronged him! He stared at us a moment, and suddenly addressing my friend, he cried:

"Vy, Schorge, is dot you? How you do? Why for your friend eye my boots so? I paid you for dem, didn't I? Dey were both lefts and you sold dem to me for 50 cents, but dey fit fine, don't dey?"

It seems my friend "Schorge," who is in the shoe business, had accidentally found one of his customers, to whom he had given a special bargain, and we were therefore welcome for the boots' sake. The farmer looked at our spaniel, and when we said we had brought the dog along to hunt rabbits the old man did not seem surprised. But, in truth, the spaniel, although good at retrieving snipe and ducks, had never seen a rabbit. Yet as he was a terror to cats we argued that he would be equally anxious to nip the tail of a bunny.

We induced Farmer Kopman to come along and show us the best place for rabbits. He called his dog, a cross between a terrier and a spitz, with probably a little bulldog thrown in. Then he took his muzzle loading shot gun from the hook and loaded both barrels. His boy Charlev, a lad of about 12 years, followed us with a hatchet. I thought "Scharly," as the old man called him, carried the hatchet to dig out any rabbits we might drive into their

burrows; but it seems there was another use for it.

We tramped around the woods for an hour or so, and I began to think the cottontails had emigrated to the next county. Suddenly there came a yelp from the terrier-spitz-bulldog. The opening yelp was followed by about 350 more yelps, and Kopman announced gravely, "He got one." The yelping grew more distant every minute. Finally it swelled into a howl, in the intervals of which the voice of my spaniel could be heard. We followed the noise, and found the dogs before a huge wood-pile, beneath which the rabbit had taken refuge. The only way to get him out was by piling over the wood, which took us fully an hour. When we came near the bottom I reached between the logs and grabbed the rabbit's hind legs. I could not withdraw my hand until more wood was moved.

I carried the rabbit along and soon after the dogs drove another toward us. My friend was in another part of the woods at that moment, so it gave me a good chance for a shot. After missing the rabbit I turned to Kopman and saw him raise his gun, at the same time calling to his son, "Scharly, hit! Scharly, hit!" Scharly raised his hatchet and did a most wonderful thing. He struck the hammers of the shot gun. There was a loud explosion, and, behold! the rabbit turned a somersault and was dead. Amazed at this new style of shooting, I asked an explanation. Farmer Kopman said,

"Ya, dot is a funny gun. You see de triggers are both broked off und I always takes my Scharly along to hit on de hammers mit de hatchet. Most times I shoots 'em sitting, but dis one we fixed running."

We saw no more rabbits that day; but the episode of the triggerless gun was worth a whole day of rattling sport.

Emil Koehn, Milwaukee, Wis.

PREFERS THE 30-40.

I am pleased and sometimes amused at the different opinions expressed in your gun department. I have gained a lot of information therefrom. I began in the West with a 50-70 Sharp's, then a 45-90 Winchester, then a 40-65, then a 38-55, and now a 30-40 Winchester. They were all good, but I like my 30-40 best, although I made the best shot of my life with the 38-55. Still it's not in the same class as the 30-40.

I see Savage says the Government has condemned the 30-40 cartridge. If so it has condemned a good cartridge and one that beats the .303 Savage. Before I bought my 30-40 someone asked you which was the best rifle for big game, and you recommended a 30-40 or a .303 Savage. I don't know what the other fellow bought, but I

took the hint and bought a 30-40 special and it's a corker. I like the box better than the tube magazine. It is the best balanced rifle I ever put to my shoulder. Last fall I killed 2 bucks with 2 cartridges, and neither deer went over 100 yards. Both dead when we got to them. The 30-40 is a hard hitter.

I see the Winchester people have a new 32 special and a 33 for big game. They may be good ones, but I doubt if they have so great penetration or so flat a trajectory as the 30-40. I notice many comments on the small caliber killing men in adjoining counties. That is mostly nonsense. If anyone will look up the statistics he will find in 9 cases out of 10 that the victim was killed with a shot gun or by some all around fool mistaking him for an animal. Then, of course, the long range rifle did it!

I buy no sporting goods that are not advertised in RECREATION, and would not buy Marlin's goods no matter where advertised. Why do you keep after him? You should do as the Irishman did, who, when asked why he did not kill the skunk, said: "I'll lave the baste alone and he'll stink himself to death."

I saw Upthegrove's ad in RECREATION and bought a fine hunting coat of him. I had it made with a special large flap attached at the upper pockets and dropping low enough to cover the lower pockets. When it rains or I get tired carrying my rifle in hand, I simply wrap the lower edge of the flap around the rifle breech, grip it and throw the weight of the rifle on my shoulder. It keeps the action dry and makes a fine rest for carrying. All those who have seen the coat admire it and think the flap a great thing.

I like the fearless way in which you tackle the great and small game hogs. You are a good sticker and kill more game hogs with your pen than Armour's best man can kill with a knife. The way your magazine sells and the friends it makes show your way is best.

S. W. Peregrine, Portland, Me.

ANSWERS DR. KEENAN.

Dr. J. W. Keenan says in October RECREATION:

"I have not bought a Savage for above reasons." I take this as an admission that he has not used a Savage to any extent. Again he says that as the gun shoots several different kinds of cartridges, it will not shoot any one of them accurately, or words to that effect. In this he is decidedly wrong. I have tried the Savage with every kind of cartridge it is constructed to shoot, under all conditions and at different ranges, and for accuracy, reliability and penetration it is all that is claimed; and further, in style and balance it is perfect.

Take a Savage out and give it a fair trial with any of the standard makes, and be it miniature for short range, or the regular for long range, it will shoot with the best of them.

Dr. Keenan speaks of the Lee straight pull. I never have had any experience with this gun, though from all I can learn, it is a fine weapon. Still, outside of prairie or open country shooting, what particular object is there in having a rifle with a point blank range of 700 yards? In our part of the country, where the undergrowth is thick, a man wants a gun without protuberances of any kind, something that will not catch on brush.

Dr. Keenan says, "The Savage will not rate as a first class shooter until one gun is made and exclusively adapted for one cartridge." Of all the men I know who use this rifle not one finds fault with it. See what hunters have to say about the Savage; how many criticisms do you find? If a gun has a defect, however insignificant, we will hear of it in RECREATION. There may be guns with longer range and greater penetration, but for all around shooting, give me the Savage every day in the week.

Wm. H. Van Horn, Tacoma, Wash.

SAYS THE SAVAGE IS O. K.

I notice that several persons have in late issues of RECREATION raised objections to the Savage rifle as now made. I believe these writers are mistaken.

The main objection seems to be that the Savage will handle a miniature, or short range, load in addition to the one for which the gun is built. It is not true that the gun is a compromise between the 2 loads. It is built for the regular charge and this charge it will shoot as accurately as any .303-40 ever made. The smaller load it shoots indifferently well, just as the Krag and Winchester shoot their short range loads.

The Savage .303 has exactly the same pitch of rifling as the Krag .303-40, and the same, I presume, as the Winchester .30-40, though I never saw the latter tested.

In 1899 I hunted deer in the Adirondacks with a so-called 30-40 Winchester. In 1900 and 1901 I hunted deer, etc., in Texas with a Krag carbine. Late in 1901 I got a .303 Savage which I have used since.

The shooting qualities of the 3 guns do not differ materially, but the Savage wins out in that it is a better brush gun, having no projecting bolts or boxes. It is lighter, prettier and the ammunition is 30 cents a box less.

Why any sportsman should desire a Savage to shoot the army cartridge I cannot see. He would simply increase his ammunition bill without corresponding benefit.

I am now on the Lion Springs target range with part of the 4th U. S. Infantry. I have tested my Savage along with the Krag rifle and it holds its own, equipped as it came from the factory. Fit it out, were it possible, with the improved Buffington sight of the Krag, or with a Lyman outfit and I don't believe it could be beaten.

G. L. Cable, Surgeon U. S. A.,
Ft. Houston, Texas.

PUT 9 BULLETS IN AN ELK.

The .303 Savage is the nicest gun to handle that I ever saw and it can not be beaten for accuracy, but I had trouble when I used it on big game. I killed 2 elk with it. One dropped at the first shot with a broken back. The second was walking slowly up a hill, about 220 yards from me. I had 2 shots at him before he got into the timber. He was then going on 3 legs and bleeding a great deal. We tracked him by the blood until dark and then returned to camp. Next day we picked up the trail in a windfall and raised the bull about a mile farther on. I emptied the magazine at him at 75 yards, yet he did not drop. That was about 9 in the morning. We followed him until 1 p. m., getting shots every hour. When he finally went down we examined him.

My first shot went in the right shoulder and through the lungs. The second had broken the right fore leg and gone into the breast. There were 7 other bullets in him; one in the neck just ahead of the shoulder, one in the shoulder just above the joint, 2 in the right hip, one had cut the right fore leg almost in 2 at the knee, and one cut through the left hind quarter. The last and fatal bullet went through the heart.

The most astonishing part of it was that not one of those shots knocked him down but the last. My theory is that the bullets did not mushroom until they had reached nearly the end of their course through the flesh. The only bullets that went clear through were one through the left quarter and one through the knee. I do not condemn the Savage, but next fall I shall use my 40-72 Winchester.

Fred F. Wilson, Jersey Shore, Pa.

You should have fired your last shot first and saved the other 8.—EDITOR.

A NEW MAGAZINE GUN.

718,055. Magazine Gun. John Hylard, St. Kilda, Victoria, Australia, assignor of $\frac{5}{8}$ to Edmund George Henry Bingham, Broomwood, Seven Oaks, County of Kent, England. Filed Nov. 11, 1901. Serial No. 81,884. (No model.)

Claim.—1. The combination, with a breech body and a stationary top plate, 6; of a

hammer and a hammer mainspring supported by the said body, a safety block, 26, pivoted to the said spring and provided with a notch for engaging with the top plate, 6, and a slidable breech bolt provided with a

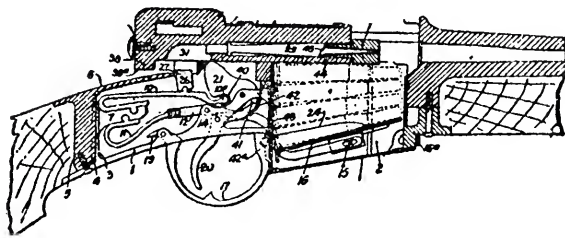

cam for actuating the block, 26, substantially as set forth.

2. The combination, with a breech body provided with a stationary catch, of a hammer and a hammer mainspring supported by the said body, a safety block pivoted to the said spring and engaging with the said catch when moved downward and rearward, and a slidable breech bolt provided with a cam, 38, for depressing the said block, and having a plate for moving the said block forward out of engagement with the said catch, said breech bolt and breech body having also inclined opposed surfaces, 160.

MERELY FACETIOUS.

In November RECREATION D. L. Bodge, of Middle Falls, N. Y., in giving his experience with the 22 short r. f. cartridge, recommends it for big game in preference to the 30-30 smokeless. In addition, he says, "The average penetration is 36 inches in seasoned oak. Some of the bullets pass through an iron plate $\frac{1}{2}$ inch thick, back of the last plank." He also states that he killed a moose with the 22 short at a quarter of a mile. I do not know whether to regard this as a huge joke, or to attribute it to some mistake in the printing. I have shot the 22 short cartridge for years in Winchester, Stevens and other rifles, and know it cannot do the work claimed for it by Mr. Bodge. A Mauser will only penetrate one half inch of iron. The penetration of a 30-30 Winchester at 15 feet is only 35 inches; yet he says a 22 short will do more than these 2 together. In shooting into white oak I have often had the 22 bullets rebound or flatten, and but few will bury themselves out of sight in it. I should like to have this explained in your columns if possible.

B. D. Davies, Wheeling, W. Va.

ANSWER.

Mr. Bodge did not expect his letter to be taken seriously. He was merely throwing bricks at the glass mansion of our friend Mr. Van Dyke.—EDITOR.

SMALL SHOT.

I buy and read RECREATION every month and like it better than any other journal I have ever read. It is interesting beyond measure. You certainly deserve great credit for your untiring and fearless efforts for the preservation of our game and fishes. Your work along these lines is of incalculable value.

I am greatly interested in the gun and ammunition department. I love a good gun and my preference is for the Stevens No. 44 Ideal, fitted with globe front and vernier peep sights. I have had several of these guns of different calibers and have found them all good and of uniform accuracy. For single shot rifles I think them unsurpassed. I do a great deal of target shooting, often firing as many as 200 shots in a day. For enjoyable sport along that line give me a 22-15-60 Stevens Ideal, center fire. It permits of loads varying from 3 grains of powder and a 32 grain bullet up to the full charge, making it an extremely desirable cartridge for use in a thickly populated place like this.

B. D. Davies, Wheeling, W. Va.

I notice a query from M. L. Meason in regard to the relative merits of Mauser and Colt pistols. I have used a Mauser pistol in Montana and have gone back to the old fashioned 45. I have also used the Luger automatic pistol and do not like it. Both have the same faults, though more pronounced in the Mauser. When used as a carbine with the stock on, the sights are so near your eye that either they or the object sighted at is out of focus and consequently blurred. When used as a pistol without the stock the trigger pull is so hard that it pulls the gun off the object sighted at, and as the weapon is automatic you do not dare to ease up the trigger pull as you can with a revolver, for fear of having the whole magazine of cartridges go through your gun. When after big game you only waste time by monkeying around with a pistol. The weapon is also dangerous.

Chas. F. Spaulding, Salt Lake, Utah.

Last winter I bought a .303 Savage, half octagon barrel, rifle butt plate, fitted with Lyman ivory bead front sight and Savage combination rear peep sight. I ordered it from the factory and they sent me a beauty. It is, in my estimation, one of the best rifles on the market. I find it extremely accurate as a target rifle, and a fine all around gun for either large or small game. I have killed a number of wild ducks with mine, and find the miniature lead bullet will do the work at 100 yards every time if held right. I reload the miniature lead

cartridges according to directions of the Savage people. The miniature metal jacketed bullet is accurate at 200 yards. I strongly advise any one thinking of buying a thoroughly reliable rifle to take the Savage. The Winchester pump gun is the best that ever happened for the price.

E. W. Stevenson, Westerly, R.

I have a 12 gauge hammerless, barrels 28 inches, full choked. It patterns too closely for quail shooting. Shall I have the barrels cut down an inch or 2, or have the choke taken out?

T. D. Renfrow, Earlington, Ky.

ANSWER.

Cutting off any portion of a choked gun barrel is an unwise and usually disastrous step. Some varieties of choke might stand it, but an inch or 2 taken off a true muzzle choke would convert it into an indifferent cylinder barrel. An expert can take out the choke entirely or modify it to any desired degree. Send the barrels to the maker and have the right barrel bored a true cylinder. Then you will have an open pattern for close range, using the right barrel, and a close pattern at long range for the second shot, using the left barrel.—EDITOR.

Will a 16 gauge kill ducks if held straight? Is it necessary to have a gun full choke bored for duck shooting, and could I use spreaders for other game?

Chas. E. Burns, Beverly, Mass.

ANSWER.

A great many men use 16 gauge guns for duck shooting, though if I were buying a gun, especially for that kind of shooting I should get a 12 gauge. It carries more powder and more lead, consequently it will kill farther, and the killing pattern of the shot will cover a larger circle at any given distance.

For duck shooting I advise you to have the right barrel modified and the left barrel full choked. In that case I should not use spreaders, even for woodcock or ruffed grouse shooting. You can, however, use spreaders if you wish.—EDITOR.

I have noticed in the Gun and Ammunition department inquiries about what a 32-40 will do. I shot a yearling buck at 50 yards with a 32-40 express bullet. The ball broke the leg at the shoulder, broke one rib, cut the big arteries just back of the heart and passed out between 2 ribs, taking a piece out of each. There were 2 small holes in the skin where the bullet went out. It must have split in its passage.

This bullet is all right for deer if put near the right place.

I see the Ideal Co. has brought out a machine to cut the crimp from cartridges to be reloaded. I use a piece of hard wood turned the size of the inside of the shells. With this in place, I roll the shell under the edge of a sharp knife, cutting off the crimp as cleanly as any machine could do.

W. R. Rief, Denison's Mills, Que.

In reply to a question about Harrington & Richardson revolvers: I have a 22 caliber with 3 inch barrel. It is exceedingly accurate and, after firing 1,000 shells, is good as ever. I like it as well as any pistol made for the price. I consider the 32 special Winchester a good gun for big game. It can be reloaded with black powder; the charge is the same as for the 32-40. If 32 or 30 grains of smokeless is too much for deer, use express bullets and a 30-40 powder charge. Will readers tell their experience with the 32 special and the 44 Winchester rifles and shells? Are the bullets the same for the 32-40 and the 32 special? Are Lyman sights good? Is the magnifying sight made at York, Nebraska, all right?

Alvaie Beckwith, Lincoln, Neb.

A friend prospecting in the mountains of Idaho last summer carried a 30-30 Winchester carbine, using smokeless cartridges. Being out of meat, he shot a buck deer that was running up the mountain side, 30 or 40 yards away. The bullet entered the left side of back bone in front of the loins. The deer, after running 200 yards, fell dead. In cutting the deer up the ball was found in the front of the heart. The bullet still had the metal jacket on. Some days later my friend shot a brown bear 3 times, once just behind the foreleg. He was near enough to see the blood spurt from the wound. He trailed the bear several miles, but did not get him. Will some of your readers tell me if the 30-30 carbine is sufficiently powerful for large game?

H. W. Frost, Hennessey, Okla.

I have a 25-20 rifle and in firing at a stick about 300 yards out on the river here a few days ago, some of the bullets glanced up from the water, went through the side of a veranda post, about 2½ inches thick, and then an inch into a door frame. If the bullet had not glanced from the water, but had gone straight across the river, would the bullet have gone through more wood than it did by glancing from the water. The bullet is small and the distance from where it started to where it struck

the house is about a half mile. I have been told first one thing and then the opposite by several persons, and I should like to know your views on the subject.

C. P. R., Woodstock, N. B.

Will some reader of RECREATION please answer?—EDITOR.

Will readers who have used the Ideal Broken Shell Extractor give their opinion regarding it. In case a shell is broken off close to the head so the extractor cannot be inserted far enough by closing the action to catch the end of a broken shell, can the tool be used in any other way?

Is it a good idea to anneal shells by heating to cherry red and cooling in water and then resizing each time they are reloaded?

The Gun and Ammunition department of RECREATION is a mine of wisdom to the shooter, mixed with just enough tales by Mr. Van Dyke and others to amuse the general reader and instruct the prevaricator.

W. C. M., Erie, Pa.

I advise G. W. McKay to file down the notch in the rear sight of his revolver to make it shoot lower.

Three drams powder and 1½ ounces shot give me better results in a 12 bore than Adirondack's 3½ drams.

To V. J. N. I would say that the 25-10 r. f. cartridge is extremely accurate and effective, but tears the game on account of the flat point and is rather high in price when much shooting is done.

I have tried the 22 short on steers and sheep and found that the little 30 grains of lead did its work instantly if placed on the forehead.

40-82, Guelph, Ont.

I own a 16 gauge, 26 inch Ithaca. The balance, finish, etc., was all right, but it seemed lacking in power. I wrote the Ithaca people stating my difficulty and received a courteous letter telling me to use 2¾ drams DuPont smokeless and 7⁄8 ounce of shot instead of 2½ drams of powder and 1 ounce shot. I did as directed and noticed at once a remarkable difference. If any owner of a 16 is experiencing the same trouble I wish he would try the Ithaca people's suggestion.

H. J. F., Providence, R. I.

I have a 32-40 Marlin, '93 model. While it is an accurate shooter and a well balanced gun, the action will clog. I have no use for the Colt repeater. It will drop shells between the magazine and the barrel. I have a 32 rim fire Winchester, single shot

rifle which I hope to try with the new inside lubricated cartridge in the near future. I think RECREATION is the best sportsman's magazine.

John H. Wright, Abbysville, Kan.

How many readers of RECREATION ever heard of a bell mouth, muzzle loading rifle? Such a weapon is owned in this place. The barrel is 24 inches long, with full length stock. Caliber 44; 16 grooves, with about one turn in 24. Diameter of bore at muzzle, $\frac{5}{8}$ inch; diameter of barrel at breech, $1\frac{1}{4}$ inches; at center $\frac{7}{8}$ inch; at muzzle, 1 inch. The gun has double triggers.

Chas. Phillips, Alexander, Ark.

Why do guns, seemingly alike in every particular, shoot differently? I once owned 2 guns of the same make, size and quality. They were machine made and apparently identical in every detail. One was the best gun I ever saw; the other was barely ordinary. Why the difference? Could it have been due to the temper of the barrels?

W. F. Tatman, Rossville, Kan.

Is the 25-35 Winchester sufficiently powerful for deer, bear and moose, or would a Savage 30-30 or .303 be preferable? Is the Savage .303 more accurate than the Winchester 30-30? Is the Stevens Ideal, No. 44, 22 caliber more accurate than a repeater of same bore?

Pard Roll, Brooklyn, N. Y.

What is the matter with the Stevens guns? The levers on some of their 22's hang an inch below where they should be. Is the 32-40 too large for grouse when used with short range ammunition? Winchester and Remington guns are my favorites.

E. W. Summers, Sumpter, Ore.

Will someone who has used U. M. C. 38-55 cartridges with mushroom bullets please tell me whether they are as effective on game as soft points of the same caliber? Are mushroom bullets more likely to lead or otherwise affect a rifle barrel?

H. J. P., Newport, R. I.

What is the trajectory, velocity and penetration of a 25-10 rim fire when fired from a Stevens Favorite? Does this cartridge give same results when used in an Ideal, No. 44? What should it cost to reload 25-20 shells?

G. G., Hutchinson, Minn.

The manufacturers of most smokeless powders sell 8 ounces of their product as

a pound. A pound of Velox smokeless contains 16 ounces and is, as I have learned from actual tests, as good as any on the market.

Henry E. Byrd, Accomac, Va.

Will some readers of RECREATION kindly give their experience with the 38-72 Winchester. Is it as good a big game gun as the 30-40? My favorite 22 is the Ideal, No. 44. In shot guns I prefer the 12 gauge Scott.

Roland Meresser, Brooklyn, N. Y.

I think the Ithaca cross bolted hammerless the best gun I have ever owned or seen. Would advise any reader of RECREATION who wants to get a good gun and his money's worth to purchase an Ithaca.

Lloyd Brinton, Falls Village, Conn.

I have recently bought a shot gun and should like to know what readers of RECREATION think of Robin Hood smokeless powder shells. How do they compare with Winchester and U. M. C.

A. W. Crampton, St. Albans, Vt.

I should like to learn the experience of fellow sportsmen in reloading. .303 shells with Du Pont or Laflin and Rand powders. Also what is the best reloading tool for the .303 shell.

Savage, Portland, Ore.

I like hunting and fishing, and use a 30-40 army rifle with telescope sight. It is O.K. I have used the National Projectile Works ammunition and find it all they claim.

Carl Koppe, Silver Cliff, Colo.

Can any reader of RECREATION tell me of a smokeless powder that has the same nature as black powder; one safe to use in a gun not adapted for nitro powder.

A. B. Turf, Pittsburg, Pa.

Will some reader of RECREATION tell what is the killing range of the 50-100-450 Winchester. Is the new 35 caliber as great a killer at short range?

William Marshall, New York city.

Will readers of RECREATION tell me about the accuracy and shooting qualities of the 30-30 or the 7 m m No. 5 Remington rifle?

Robert H. Snyder, Rolfe, Pa.

Will someone please inform me as to the range and penetration of the 25-20 Winchester smokeless?

C. W. Linberger, Uhrichsville, O.

NATURAL HISTORY.

When a bird or a wild animal is killed, that is the end of it. If photographed, it may still live and its educational and scientific value is multiplied indefinitely.

THE WOOD BISON.

J. A. ALLEN.

The American Museum of Natural History has recently obtained a skull and unmounted head skin of the wood bison, taken by Indians near Great Slave lake. The exact point is not known, but it is evidently a freshly killed specimen, and is in excellent condition. It is a young male, probably about 4 years old. Compared with specimens of the plains bison, of corresponding age, it is rather above the average size of the latter, with the base of the horn cores relatively thicker, and the head skin has the whole pelage darker, softer, and more silky.

The present specimen confirms, as far as it goes, the characters recently assigned to the wood bison by Mr. S. N. Rhoads, and quite warrants its recognition under the name. *Bison athabasca*, applied to it by him. Formerly it doubtless completely intergraded with the Southern form. Now that it is on the point of extinction, the following summary of its recent decadence may be of interest.

The American bison formerly ranged continuously from the Northern boundary of the United States Northward over the Saskatchewan plains to the region about Great Slave lake, in latitude 60 degrees North, and even to the vicinity of Great Marten lake, in latitude 63 or 64 degrees.

There is abundant historic evidence to show that the wood bison formerly ranged from the Liard river, in latitude 60 degrees Eastward to the Eastern end of Great Slave lake, and from the district just Northwest of Great Slave lake Southward to the Western end of Lake Athabasca, and Westward to the East base of the Rocky mountains.

According to Warburton Pike, in 1890 a few bands of buffalo were scattered over a considerable area of country between the Liard river and Great Slave lake, and thence South to Peace river. It is impossible to say anything about their numbers, as the country they inhabit is so large, and the Indians, who are few in number, usually keep to the same hunting ground. The site of his own successful hunt for these animals, in February, 1890, was on a tributary of Buffalo river, about 50 miles South of its entrance into Great Slave lake.

It was near this point that Frank Russell hunted them in 1894, with the same Indian guide, but without success. He says: "We

reached the Northern limit of the buffalo range, perhaps 50 miles South of the Great Slave lake." Owing to stormy weather, Mr. Russell failed to reach the herd, being compelled to turn back without seeing a single bison. Concerning their numbers, haunts, and prospects he writes as follows:

"The herd at present consists of a few hundred only. They are so wary that but one effective shot can be fired before they betake themselves to flight, and, as with the moose, pursuit is altogether futile. They can not be hunted in summer, as the country which they inhabit is an impenetrable, mosquito-infested, wooded swamp at that season. . . . They can only be killed by stalking in midwinter, when their pelage is at its best. . . ."

"The Indians along Peace and Slave rivers make occasional trips into the buffalo country with dog teams to establish lines of marten traps. When they discover a band of buffaloes they of course kill as many as they can, but they have not made systematic efforts to hunt them for their robes, as they have the musk-ox. Fortunately, the officers of the company have exerted their influence toward the preservation of the buffalo, not trading for the robes, until the recent advent of rival traders. During the winter of 1892-3 40 buffaloes were killed, the largest number that had been secured for several years. I saw most of these robes, which were very dark, the hair thick and curled, making a robe superior to that of either musk-ox or plains buffalo; they were so large that the Indians had cut many of them in halves for convenience in hauling on the sleds.

"From \$10 to \$50 are paid for the robes. The traders are trying to induce the Indians to preserve them as mountable skins.

"The Northern limit of the range of the buffalo, as given by Mackenzie, was the Horn mountains, North of Little lake. Père Ruóre, who has crossed the Rae-Providence traverse several times, assured me he had seen buffalo skulls on the prairies within 50 miles of Providence, Northwest of the Western end of Great Slave lake. I saw no remains of buffaloes when I crossed these prairies in December, owing to the snow, but the country is similar to that South of the lake, where they are still found.

"Black Head, an old Yellow Knife chief, living at the mouth of the Rivière au Jean, told me he had killed plenty of buffaloes

in the delta of the Slave river. About 15 years ago a few were killed near Liard, but they are seldom seen in that quarter. They formerly frequented the Salt Plains, 40 miles Northeast of Fort Smith. Franklin's party killed a buffalo in that vicinity at the time of their visit in 1820. Richardson states that in 1848 there was an abundance of deer and buffalo meat obtainable on the Salt Plains."

Later information is furnished in the report of Game Inspector Jarvis to the Canadian Government. His inspection of the region embracing the present range of the bison was made in 1897, and he says: "I have taken great pains in making as thorough inquiries as possible in connection with the buffalo, their habits, number, and range. The range of a scattered band of about 300 is from Peace point to Salt river, and from Salt river to within 20 miles of Fort Resolution, on Great Slave lake. I met a Mr. Handbury, an English sportsman, who is on a hunting expedition. He had just returned from an unsuccessful buffalo hunt, but he saw fresh tracks and beds of about 60 buffalo. Mr. Handbury returns this year, but the fear of a \$200 fine will hardly prevent his hunt. . . . If it be the intention of the Government to protect these nearly extinct animals, it can only be done by placing officials on the spot. I have in the case of buffalo and other game impressed on all hunters and interested persons the necessity of obeying the game act, and have left printed notices where practicable."

A letter from Mr. H. I. Moberly, of the Hudson Bay Company, dated Nov. 9, 1897, states: "They lived formerly from the beginning of the wooded country North of the Saskatchewan to Great Slave lake, and farther North along the East slope of the Rocky mountains. At present there are not more than 250 to 300 alive, and they are in 2 bands; one on the lower Peace river, North of it, and running from close to Great Slave lake at Peach point, 90 miles below Fort Vermillion. The other is on the upper Hay river and ranges between Peace river and Liard river, and runs down some 250 miles East of the Rocky mountains and up to the foot of the mountains."

This brings the history down to Mr. Stone's report, in which he says he does not think the present number exceeds 50, and that their complete extinction, in spite of the efforts of the Canadian Government to protect them, will be consummated within the next 3 years.

So it appears that the wood bison, during the last 6 years at least, have occupied a portion of country considerably to the North of the region where they were located by Mr. Hornaday in 1889, and by me in 1876. It is fairly safe now to assume, how-

ever, that they have been entirely exterminated from their former range South of the Peace river, and that a few years more will suffice for their complete extermination.

The extirpation of the plains bison has already been practically effected. An excellent authority on this subject states that in 1895 there were possibly 20 to 25 wild examples in different parts of Montana, Wyoming, and Colorado, and 100 to 125 in the Yellowstone National Park. Now (March, 1900) he says: "It is safe to say there are not a dozen live wild buffalo outside the Yellowstone Park in the United States, and if there is a single one I do not know where it is. Inside the park there may be 20 head or so."

The different domesticated herds he estimates may contain, all told, "between 300 and 500."

Thus the American bison is already practically exterminated in the wild state, and its perpetuation depends on the care and skill exercised to preserve the domesticated herds.

THE RUFFED GROUSE.

The ruffed grouse is a queer bird, a unique combination of intelligence and stupidity. One moment the embodiment of prudence, foresight and cunning, the next, perhaps, it acts as if suddenly bereft of sense. Of course the shrewder side is generally in evidence, but the other asserts itself often enough to be responsible for the death of 9 out of every 10 of these birds brought to bay.

For instance, that foolish habit of staying in a tree, just because a yapping cur is underneath, until the hunter finds and brings it down. I remember once coming through a patch of wood when my dog put up a grouse in a low hemlock. I had only a pistol and began blazing away at the bird, drawing nearer at each shot, until when all my cartridges, 10 or 12, were gone I stood within 15 feet of her. A man who has hunted grouse a great deal with the rifle tells me he has frequently had them wait for a second shot, even when wounded by the first, as was attested by 2 bullet holes in the body. Instead of acquiring wisdom with age, the old birds usually stick to a tree longer than those of first season. Then that telltale drum and putter, by which they so often betray their whereabouts, that silly way of sticking to the burr branches in budding time while their companions are sent fluttering one by one to the ground, until their own turn comes, and of running their heads through a wire noose rather than hop over a barrier a foot high. I even knew one to fly out into a tree near a schoolhouse and allow itself to be peppered to death with an air gun.

A successful grouse hunter with whom

I recently talked had noticed this queer streak. "My method," he said, "is to follow every bird I scare up. If I can only keep on its track it is pretty sure to do something foolish in the end." Of course, if the grouse was never shot except in a sportsmanlike manner, on the wing, these weaknesses would not count so heavily against it, but unfortunately it seems the rule to shoot them whenever and wherever seen. As a consequence the birds are diminishing at a rate that points to their speedy extinction.

Does the grouse possess the power of scent in sufficient degree to warn it of danger? It is not generally so considered; nevertheless, I believe it is the case. I have repeatedly had birds show every sign of suspecting my proximity, when it seems impossible that they could have seen or heard me. I should like to see this subject discussed in RECREATION.

John L. Woodbury, Cornish, Me.

WHAT HAWKS ARE THESE?

There are at least 2 kinds of hawks here that are exceedingly destructive to game and poultry. One is medium sized, with dark back and reddish brown breast. While out driving one afternoon in July I saw one chase a prairie chicken into a ravine and catch it. On driving the hawk away I found the chicken partly hidden under a tuft of grass and so frightened that it allowed me to pick it up. I found only a few claw marks in its back, so wrapping it in a blanket I put it in the buggy and drove on a mile or 2. Then I let it go, and it flew off, as well as ever.

On another occasion, while raking hay, I noticed one of these hawks high in air, flying over a part of the meadow that had not been cut. Suddenly it closed its wings and dropped to the ground like a stone. I lifted my rake and drove to the spot in time to save the life of a prairie chicken which he had caught. In less than 5 minutes he caught another, which I also saved. A few minutes later I saw him pounce on a third chicken, nearly $\frac{1}{2}$ mile distant. I went over, drove the hawk away, and found the chicken's skull torn off and part of the head and neck eaten.

The other kind of hawk I have mentioned is also medium sized, with round, long, firm body, rather pointed tail, sharp pointed wings, dark gray back and light colored breast, with small dark spots. I saw one resting on a fence post near a slough where I was shooting ducks one rainy day last fall. Soon a small bunch of coots rose and the hawk immediately followed them, caught one on the wing, held it a moment, then let go and it fell to the water dead.

He followed the bunch and caught and killed another before they settled in the rushes. Then he went back to the bank and waited again. This performance was repeated several times during the afternoon and 7 or 8 birds were killed by that one hawk while I was there. He did not eat any of them, but seemed to kill them out of pure cussedness. Perhaps it was for sport; if so, he was certainly a game hog.

Twice I have seen these hawks dive at full grown hens, and, striking them with their wings or breast, I could not tell which, knock them senseless, then pass on for some distance, but finally circle back, evidently with the intention of making a meal of the victim. On both occasions, however, I was there with my shot gun and killed the hawks. They are the quickest on the wing of any hawks we have.

C. J. Campbell, Engleok, N Dak.

These hawks must have been Cooper's hawk, *Accipiter cooperi*, and the sharp shinned hawk, *Accipiter velox*, both of them feathered game hogs and murderers, deserving of no mercy.—W. T. H.

WHAT KIND OF CAT WAS IT?

While walking with a young beagle through a wood in Munro county, Pa., last July, I saw an animal cross the road ahead of me. My dog was fairly well broken, but when I took him to the track he only growled and looked up at me in an undecided way. When I urged him on he gained courage and followed the track toward a valley filled with heavy timber. I heard him barking furiously for a few minutes, then he returned to me. He refused to leave me again, but led me to a small pine, and began to bark up the tree. He soon found, however, that the game had gone. Then, with renewed courage, he took the track toward the big timber. I cut across lots to a farm-house, borrowed a rifle and returned. I could see the dog making circles around a cluster of large oak trees, apparently at fault. Looking up, I saw an animal on a large limb about 60 feet from the ground. I took aim and fired. With the report a huge cat fell to the ground fatally wounded. Will some one tell me what kind of cat it was? Its skin was tawny yellow, with dark stripes on the head and forelegs and dark spots on the body. From nose to root of tail it measured just 4 feet, and the tail was 8 inches long. It weighed 36 pounds, and was very lean. Its tail and ears were tipped with small tufts of hair. Head large and fierce. It carried its body erect like a house cat; not crouching like the common wildcat.

R. J. Feltham, Olean, N. Y.

THE LEAGUE OF AMERICAN SPORTSMEN.

GENERAL OFFICERS

President, G. O. Shields, 23 W. 24th St., New York.

1st Vice-President, E. T. Seton, 80 West 40th St., New York.

2d Vice-President, W. T. Hornaday, 2969 Decatur Ave., Bedford Park, N. Y.

3d Vice-President, Dr. T. S. Palmer, Dept. of Agriculture, Washington, D. C.

4th Vice-President, A. A. Anderson, 80 West 40th St., New York.

5th Vice-President, Hon. W. A. Richards, General Land Office, Washington, D. C.

Secretary, A. F. Rice, 155 Pennington Ave., Passaic, N. J.

Treasurer, Austin Corbin, of the Corbin Banking Co., 192 Broadway, New York City.

OFFICIAL REPORT OF THE 5TH ANNUAL MEETING.

The 5th Annual Meeting of the League of American Sportsmen was held at the rooms of the Commercial Club, St. Paul, Minn., February 11, 1903.

In the absence of Secretary Rice, Mr. A. C. Thatcher, of Urbana, O., was elected Secretary pro tem.

The following delegates answered to the roll call:

W. R. Blocksom, Chief Warden, Arkansas; Hon. Geo. A. Lincoln, State Game Warden, Iowa;

Harry E. Lee, lay delegate, Illinois;

E. M. Marvin, lay delegate, Idaho;

Charles Payne, lay delegate, Kansas;

George C. Long, Chief Warden, Kentucky;

R. L. Brashear, Secretary-Treasurer, Kentucky;

Dr. H. E. Houston and

W. H. Meade, lay delegates, Montana;

F. E. Mockett, Chief Warden, Nebraska;

Hon. G. B. Simpkins, State Game Commissioner, Nebraska;

A. C. Thatcher, Vice-Warden, Ohio;

Hon. J. C. Porterfield, State Game Warden, Ohio;

Dr. F. S. Dewey, lay delegate, Oklahoma;

C. H. Pond and

B. A. Ovenshire, lay delegates, Pennsylvania;

C. F. Dill, Chief Warden, South Carolina;

Hon. L. M. McCoy, lay delegate, South Dakota;

Dr. A. M. Gropper, Secretary-Treasurer, Wisconsin;

D. Lange, Chief Warden, Minnesota;

Hon. H. A. Morgan, Vice-Warden, Minnesota;

A. R. Bixby, Secretary-Treasurer, Minnesota;

Hon. Samuel Fullerton, State Game Warden, Minnesota.

These gentlemen all made interesting reports of the progress of League work and of the cause of game protection in general in their respective States, which brought out a great deal of instructive and entertaining discussion on the part of other delegates.

The following telegram was received from President Roosevelt in answer to one sent him by Chief Warden Lange:

White House, Washington, D. C.

February 11.

D. Lange, Chief Warden, Commercial Club, St. Paul:

I am always glad to know of efforts for the proper protection of game, and am particularly glad to know of the increased interest of the League of American Sportsmen in this subject. I send cordial good wishes for the success of the meeting today and wish I could be with you.

THEODORE ROOSEVELT.

Mr. G. C. Hoyt, of the Minnesota Humane Society, presented the following official communication from that body:

To the League of American Sportsmen:

Anomalous as it may seem, humane workers look on the League of American Sportsmen as a friend and an ally. This is due to your splendid work throughout the country in enforcing game laws and in protecting song birds.

The hunter is inherently a lover of nature. This passion more than any other influence lures sportsmen to the woods and the field. Dreary, indeed, would be these hunting excursions if no note of nature's music ever broke on the ear, if no vision of woodgirt hill or valley ever greeted the eye. This love of nature indicates a breadth of sympathy which should extend to the wild things that dwell in these woodlands which men visit in quest of pleasure and strength.

The sportsman is pre-eminently a lover of fair play. We ask you, therefore, to cooperate with us in our efforts to suppress the shooting of live birds from traps. If a bird is instantly killed, of course the cruelty is reduced to the minimum; but if only wounded, and he escape, to flutter away to some lonely place to die, after long suffering, we hold that it is cruel, and feel that we may justly look to your organization for aid in the suppression of a practice which is clearly contrary to the ethics of a true huntsman.

We congratulate your organization on the stand you have taken in behalf of deer protection. Among the wooded haunts of these beautiful creatures the game hog is ever

present, and unless he is checked in his wanton slaughter the deer will soon have passed. On the cover of the current number of your official organ, RECREATION, there is a picture of a doe standing in the open. She has evidently heard the wicked whistle of a bullet in close proximity and turns to look toward her foe. No human tongue or pen can speak to you with half the eloquence which shines out from those almost human eyes. The incarnation of innocence and gentleness, defenceless and harmless, she stands there among the flowers, her head uplifted, her mournful eyes showing the sorrows of her race, the unspeakable pathos of the hunted. Study this picture intently, let the mute appeal which this creature makes for its kind enter your souls, and you will all be hunting with cameras next deer season.

The Humane Society of St. Paul extends cordial greeting to you, and stands ready to coöperate with you in the enforcement of law and in all things which tend to eliminate cruelty from sport.

THE HUMANE SOCIETY OF ST. PAUL.

By J. S. Fugate, Vice-President.

General C. C. Andrews, Minnesota State Forestry Commissioner, made an able and interesting address on the progress of the work of protecting the forests of Minnesota, and on the necessity of practical co-operation between the League and the Forestry Commissions of the various States, in their respective fields. He spoke fluently and forcibly of the close relationship between the 2 lines of work, and said that without forests it would be impossible to preserve the big game and the birds of this country.

The following resolution was offered by Mr. Charles Payne, of Kansas:

Be it resolved, by the League of American Sportsmen, in annual meeting assembled, this 11th day of February, 1903, as follows:

That the National Congress should set aside a tract of land in the Indian Territory as a national game preserve, where game, and especially game birds, may be preserved and propagated, naturally and artificially, for distribution throughout the United States.

That the President of the United States be and he is earnestly requested and urged to appoint a commission, consisting of not less than 3 competent men, to examine such lands as may be deemed suitable for said purpose, and to report to the President, at the earliest possible date, how large a tract of land would be necessary, and what suitable tract, adapted for said purpose, could be, with the least inconvenience and expense, appropriated therefor.

That the President of this League be,

and he is hereby, requested to call on the President of the United States and ask him to appoint the commission hereinbefore referred to, and to urge upon him the necessity of immediate action on this matter.

Hon. H. A. Morgan seconded this resolution and it was unanimously adopted.

The following resolution was offered by Dr. A. M. Gropper, of Wisconsin:

Whereas, an effort is being made by certain market hunters, pot hunters, game dealers and hotel men in Wisconsin to induce the Legislature of that State to repeal the law now on the statute books which prohibits spring shooting; and,

Whereas, it is of the utmost importance that the said law should remain in force; now, therefore,

Resolved, that the League of American Sportsmen, in annual meeting assembled, representing all the States and Territories, does hereby memorialize and request the Legislature of the said State of Wisconsin to vote down any bill which may be presented to that body, which may aim to again legalize spring shooting. *

The League would regard the repeal of said anti-spring shooting law as a calamity to the cause of game protection, not only in Wisconsin, but in all the States of the Union.

We hold that no game bird should be killed, in any State or in Canada, at any time after January 1 and before September 1 of each year; and we are putting forth our utmost endeavors to induce the law making powers of the States which now permit spring shooting to pass laws to abolish and prohibit the same. We, therefore, pray the State of Wisconsin to retain her present proud position at the head of the small list of States which now prohibit spring shooting, and thus to set a good example for her sister States.

Seconded by Dr. Houston, of Montana.

Unanimously adopted.

The following resolution was offered by Chief Warden Lange, of the Minnesota Division:

Whereas, a bill, No. S. 6,689, is now pending in the Congress of the United States, which aims to authorize the President to create game preserves in any of the forest reserves of the West; and,

Whereas another bill, No. H. R. 16,000, is now pending in Congress, which aims to clothe the forest rangers with police power in the discharge of their duties; therefore

Resolved, that the League of American Sportsmen in annual meeting assembled, representing all the States and Territories of the Union, does hereby heartily endorse and approve the provisions of these bills, and does urge all senators and representatives in Congress to pass these bills promptly and at its present session.

Seconded by Vice-Warden Thatcher, of Ohio.

Unanimously adopted.

The following resolution was offered by Senator Morgan, of Minnesota:

Resolved, that the President of this League be and he is hereby instructed to request the Governors of the States of Virginia, West Virginia, Ohio, Kentucky, Michigan, Illinois, Indiana, Missouri, Minnesota, Iowa, North Dakota, South Dakota and Wisconsin, to call into convention the Fish and Game Committees of their respective Legislatures, for the purpose of devising a homogeneous code of fish and game laws, and to present them to their respective bodies for passage.

Seconded by Chief Warden Long, of Kentucky.

Unanimously adopted.

The following resolution was offered by Mr. A. R. Bixby, Secretary-Treasurer of the Minnesota Division:

Whereas, the grey squirrel, in common with many other wild animals, is threatened with extermination in this country, and

Whereas, we recognize the grey squirrel as a beautiful, interesting, sociable creature, easily killed and yet readily yielding to the friendly advances and attentions of human beings; therefore,

Resolved, That the League of American Sportsmen, in annual meeting assembled, does hereby advise all sportsmen everywhere to cease hunting and killing grey squirrels; to hereafter regard and treat these animals as friends and pets; and we hereby recommend that laws be enacted in all States and territories where grey squirrels exist forbidding the killing of same at any time.

Seconded by Chief Warden Blocksom, of Arkansas.

Unanimously adopted.

The following resolution was offered by Dr. Gropper, of Wisconsin:

Whereas, the League of American Sportsmen is incorporated under the laws of the State of New York, and

Whereas, the laws of that State require that associations incorporated there shall annually elect a board of directors, who in turn shall elect general officers of such associations; and

Whereas, the incorporators of the said League of American Sportsmen did on January 12, 1903, reelect the same board of directors, who served during 1902; and

Whereas, the said directors did reelect the same general officers, who served during the said year 1902;

Now, therefore, be it resolved by the League of American Sportsmen, in annual meeting assembled, on this 11th day of February, 1903, that the said election of said

board of directors and said general officers is hereby approved.

Seconded by Mr. Pond, of Pennsylvania.

Unanimously adopted.

The following resolution was offered by Dr. Gropper, of Wisconsin:

Resolved, that the League of American Sportsmen hereby extends a vote of thanks to the Commercial Club of St. Paul for the use of its club room for holding its annual meeting and banquet; and to the St. Paul City Council for its generous treatment of League delegates.

Seconded by Mr. Thatcher.

Unanimously adopted.

There being no further business to transact, the meeting adjourned at 6 o'clock p. m.

The annual dinner of the League was given in the banquet hall of the Commercial Club, and was attended by nearly 100 men, prominent among whom were Governor S. R. Van Sant, Colonel Geo. C. Hallum, of his staff; Attorney General W. B. Douglas, Hon. Lewis Betz, City Comptroller of St. Paul, representing the Mayor; Dr. J. Ohage, President of the City Board of Health; Alderman Frank Arnold and several members of the State Legislature.

Governor Van Sant, in an eloquent and thrilling address, welcomed the League to the State of Minnesota, and congratulated its members on the great reformation this body has effected in public sentiment on behalf of the preservation of the wild animals, the birds, the forests, and the fishes of this country.

He was followed by City Comptroller Betz, who said that the Mayor, being unable to attend the banquet on account of illness, had delegated him to extend to the League the freedom and the hospitality of the city of St. Paul.

Interesting speeches were also made by several other guests and by a number of League members. All the latter expressed themselves as delighted with the hospitable treatment accorded them by the people of St. Paul and of the State of Minnesota.

On the morning of the 12th State Game Warden Fullerton ordered several sleighs and took the delegates to the State fish hatchery, where the processes of hatching and propagating trout were fully explained and illustrated. All League members who attended this meeting will ever regard it as one of the delightful experiences of their lives.

A. C. THATCHER, Secretary Pro tem.

FIFTH ANNUAL REPORT OF THE
PRESIDENT

The work of game protection has been pushed by this League during the past year as vigorously as heretofore, and while the results have not been all we could have wished, yet we have accomplished a great

deal. We should remember that all great reforms move slowly, and that we can not hope to change the fixed habits and the general opinions of a nation within a few years.

We have made marked progress during the year in securing needed amendments to the game laws in many States. It would take up too much of your time to give full details of this work, and I can only summarize.

We have induced the Legislatures of several States to amend their laws so as to prohibit the sale or export of game. At this writing, bills are pending in the Legislatures of a number of other States looking to this same reform. In Colorado, Wyoming, Idaho, Washington and Nebraska persistent efforts are being made to prohibit the killing of antelope for terms of 5 to 10 years. Wyoming and Montana sportsmen are endeavoring to have mountain sheep and moose included in their laws, and with every prospect of success.

A very important event in the year's work is the fact that the President of the United States has, at our request, extended the Yellowstone and Teton forest reserves, on the East and South of the Yellowstone Park, by adding thereto more than 8,000,000 acres of land, and he has appointed Mr. A. A. Anderson, one of the Vice-Presidents of this League, as Superintendent of this vast game range. Mr. Anderson has exercised great care in employing forest rangers, and is keeping in close touch with their work at all times. These rangers have prosecuted and convicted 14 men for killing game illegally within these forest reserves during the year.

A bill is now before Congress authorizing the President of the United States to set apart such portion of the various forest reserves in the West as he may deem necessary, as game preserves. Another bill is pending in Congress, the object of which is to clothe forest rangers with police power, in order that they may make arrests whenever and wherever necessary, without waiting to procure warrants.

A circular letter has been sent to all members of the League asking them to write their Congressman and Senators, urging favorable action on these bills. If they can be passed, and with a League member in the Presidential chair, we may safely assume that within the next 6 months we shall have a number of veritable and extensive game preserves in the Rocky mountains and the Cascades, where big game, birds and fishes will be rigidly and effectively protected. It is to be hoped that every League member will do his duty in this matter at once.

Another important event of the year is that the Governors of 22 States and Terri-

ories have, at the request of the President of the League, appointed our Chief Wardens, Vice-Wardens and Secretary-Treasurers as delegates to this, the 5th annual meeting. The States and Territories mentioned are:

Arizona,	New Mexico,
Arkansas,	North Dakota.
Colorado,	Ohio,
Florida,	Oregon,
Iowa,	South Dakota,
Kentucky,	South Carolina,
Maine,	Virginia,
Michigan,	Washington,
Minnesota,	West Virginia,
Montana,	Wisconsin,
Nebraska,	Wyoming,

Nothing that has ever transpired since the day the League was organized has exerted a greater influence for good than this action on the part of the Governors of these 22 States and Territories. It is in each instance an official recognition by the State Government that the League of American Sportsmen means something, that it is doing something and that it has earned such official recognition.

I believe the time is not far distant when the various States and the Congress of the United States will appropriate money to this League every year, to be used in enforcing the game and fish laws.

Another important epoch in our history has been marked by the sending out of a letter to a large number of wealthy men asking them to contribute money to the League, to be expended in its work of enforcing the game laws.

We have had responses to such letters, containing checks, as follows:

Contributors to the Game Protection Fund—

H. P. Whitney, 2 West 57th St., N. Y.	\$100
Geo. C. Clark, 51 Wall St., N. Y.....	50
A. F. Estabrook, Boston, Mass.....	50
H. von Rensselaer Kennedy, N. Y....	50
T. H. Bartlett, 148 Jackson St., Chicago, Ill.....	50
Henry B. Day, 321 Chestnut St., West Newton, Mass.....	50
C. E. Sanborn, 87 Broad St., Boston, Mass	50
Geo. D. Piatt, 33 Union Sq., N. Y....	25
Geo. Eastman, Rochester, N. Y.....	25
J. Walter Thompson, 41 Park Row, N. Y.....	25
W. P. Clyde, 19 State St., N. Y.....	25
Clinton Gilbert, 2 Wall St., N. Y....	25
J. H. Smith, N. Y.....	25
T. N. Seligman, N. Y.....	25
S. B. Warren, 220 Devonshire St., Boston, Mass.....	25
C. I. Hudson, 34 Wall St., N. Y.....	10
F. A. Dollett, 135 Front St., N. Y....	10
H. L. Clark, Philadelphia, Pa.....	10

J. F. Sherman, 64 Leonard St., N. Y.. 10
 Ernest W. Heath, Chicago, Ill..... 10
 D. N. Force, 224 Church St., N. Y... 10
 Seelye Benedict, 35 Nassau St., N. Y. 10
 D. C. Philbrick, 74 Broadway, N. Y.. 10
 Arthur Amory, 48 Franklin St., Boston, Mass..... 10
 S. A. Maxwell, 121 Crosby St., N. Y.. 10
 H. C. Van Post, 32 West 57th St., N. Y..... 10
 H. M. Garlick, Youngstown, Ohio..... 10
 M. B. Metcalf, 50 Worth St., N. Y... 10
 Augustus Belmont, N. Y..... 10
 W. R. Peters, 47 Cedar St., N. Y..... 10
 Jas. B. Dill, 27 Pine St., N. Y..... 10
 Chas. A. Dean, Dean Bldg., Boston, Mass..... 10
 B. Fischer, 1123 Broadway, N. Y.... 5
 Chas. E. Diefenthaler, 397 Greenwich St., N. Y..... 5
 S. C. Pirie, 115 Worth St., N. Y..... 5
 F. Coit Johnson, 110 Worth St., N. Y. 5
 E. S. Benjamin, 49 Lafayette Pl., N. Y. 5
 Pierre Mali, 8 5th Ave., N. Y..... 5
 Edw. Bement, 74 Broadway, N. Y.... 5
 J. C. G. Hupfel, 229 East 38th St., N.Y. 5
 J. H. Hammond, 32 Riverside Drive, N. Y..... 5-
 George F. Volkman, 2307 Broadway, San Francisco, Cal..... 5

these at work in different parts of the country.

A year ago we had 156 local wardens at work. Today we have 176, a gain of 13 per cent.

The League may reasonably and modestly claim the honor of having secured the passage of the Alaskan game bill in the 56th Congress. Your President drafted this bill, substantially as passed, and while we fully recognize the stalwart service rendered by our venerable friend, the Honorable John F. Lacey, in introducing and pushing this bill, and of many other Congressmen and Senators in working and voting for it, yet I must congratulate the members of the League on having made such a strong and such a general demand on their members for the passage of this measure, that a great majority of them promptly voted for it when it came up.

The skin hunters and their allies, the taxidermists, were rapidly cleaning out the big game of Alaska, and that State would have been as barren of wild life in a few years as the Southwestern desert is today, had not the L. A. S. called a halt on them.

The general office of the League is still carrying on its great missionary work through the mails. Thousands of complaints come to this office every year, of violations of the game laws in various States and in the Canadian Provinces. All these reports are acted on in one way or another, and in many cases with the desired effect. If they come from States where we have good live Division officers, the reports are referred to them. If from other States, then we deal with the cases direct, as seems best. We have received during the past year many supplementary reports on cases that had been thus brought to our attention and have been informed that the accused had been punished and had reformed.

League members have prosecuted 217 persons for infractions of fish or game laws, and have secured 205 convictions. We have paid rewards of \$10 in each of 23 of these cases.

These disbursements have been distributed throughout the various States, and it is easy to understand how a man receiving such a reward will tell his friends, and even his enemies, of the effective work being done by the League to save the game.

Under the direction and supervision of the Chief Warden of the Oklahoma Division, 2 important seizures of quails were made in that territory last winter. One of these consisted of 29 barrels of birds valued at \$2,000, and the other of 7 barrels valued at \$525. These birds were confiscated and given to the poor, and the shippers were well-nigh bankrupt.

E. F. Smith, Chief Warden of the West

This is an important recognition on the part of these capitalists, of the valuable service being rendered the country by this League. A year hence, we shall ask these same gentlemen to contribute again, and if we can show them that we have made reasonable progress in our work during the current year, we may safely expect that most of them will duplicate their checks. Others will no doubt send us larger ones. Furthermore, we may safely count on other philanthropic men coming to our aid, as we progress in years and in usefulness. The money already received is being carefully and effectively expended in our educational work.

The growth of the League during the past year has been entirely satisfactory. At the time of the last annual meeting, we had a membership of 7,784. Today we have 9,210. A year ago we had 42 State Divisions. We have organized 3 since then, one of which is in Alaska, the most important in the Union so far as game is concerned. There are now but 5 States in which we have not yet organized divisions. These are Delaware, Indian Territory, Mississippi, North Carolina and Louisiana.

We are working hard on the sportsmen in these States to get them in line, and I hope to have the pleasure of reporting at the next annual meeting that we have completed organizations in all of them.

We have organized, during the past year, 14 local chapters, and therefore have 54 of

Virginia Division of the League, seized 14 lots of game that had been delivered to an Express Co. for shipment out of the State, in violation of law. The shippers were prosecuted and were made to pay heavy fines.

C. A. Durell, a League member, of Reading, Pa., caught one H. B. Hintz in the act of killing a blackbird. He warned him that this was in violation of the law, but Hintz defied him and went on shooting. Durell swore out a warrant for Hintz, on which Hintz was convicted and fined \$40.

The El Paso, Texas, chapter did an important piece of work some months ago. The members became disgusted at the open violations of the game laws by certain men in and about that town, and served notice on the market men and express companies that thereafter all violations of the game laws would be punished. As a result, not a carcass of game was to be seen in the El Paso markets during the past season.

The building of the Sierra Madre Railway into Mexico opened up a great game country. Certain pot hunters went out on this line, established camps and went to killing game and shipping it to El Paso. The officers of the local chapter induced the railway company to make a rate on game 8 times greater than that on domestic meats. This promptly ended the shipment of game over that road.

The South Carolina Club, a wealthy social organization of Columbia, S. C., ordered 400 quails for its annual banquet, which was given in October last. There is a law in that State prohibiting the sale of quails at any time, and the birds could not be obtained without violating that law. Mr. C. F. Dill, Chief Warden of the South Carolina Division, wrote the president of the club, calling attention to this fact and asking that the order be rescinded. At first the club refused and assumed a defiant attitude. Mr. Dill then advised the president that if the birds were served the officers of the club would be prosecuted. After a long and spirited controversy the order for quails was countermanded, the members ate turkey instead, and the majesty of the law was upheld. Every sportsman in that State should join the League for this one reason, if for no other.

An important silent worker in the cause of game protection is our cloth poster. During the past year, we have distributed something over 5,000 of these, and it is gratifying to hear the reports that come from remote districts regarding these posters. For instance, a man writes me that he was crossing a range of mountains on a lonely trail in Oregon, and that he was confronted by League posters, nailed on trees, every few miles. He said he could readily understand how they might restrain any evil-minded man who might have been inclined to kill game illegally,

because of the risk of being confronted by a League member at the next turn in the trail. I hear of these posters staring people in the face in Vermont, in Mississippi, in Michigan, in Texas, in Minnesota, and in fact in nearly every State of the Union. Men write me nearly every day for supplies of these warning flambeaux, and after a week or perhaps a month they write again that they have put them up throughout their respective neighborhoods, that the poachers are talking about them and damning the League. In some cases we hear that evil-minded men have torn down the bills, but our friends promptly replace them with new ones. The influence of these public offers of rewards for lawbreakers is far-reaching, and will become more and more so as the League membership grows and as our posters are more generally distributed.

Altogether we may well feel proud of our record for the year, and I heartily congratulate the members on the great work done in 1902.

G. O. SHIELDS, President.

Last November E. F. Smith, Chief Warden of the West Virginia Division, came to Morgantown and organized the 30 L. A. S. members here into a local chapter. Much good has been accomplished. L. A. S. posters have been tacked up all over the county. The local newspapers have done a great deal to help along the good cause, and the general public is coming to know that a live interest is being taken in the matter of enforcing game laws and protecting game in every way. We are in hopes the present Legislature will make it unlawful to sell game during the closed season, no matter when or where it was killed or bought.

Bennett White, Morgantown, W. Va.

Nothing could tempt me to withdraw from the League of American Sportsmen. This organization has done any amount of good around here. The State makes the game laws, but it takes the L. A. S. to carry them out. It has stopped nearly all the "before sunrise" and "after sunset" duck shooting, and the game hogs and market hunters are leaving for pastures new.

C. B. Nordhoff, Redlands, Cal.

Mary had a little horse
Which was forty-nine years old,
She sent it to the butcher's
And for prime beef it was sold.

X. L. N. C.

RECREATION takes the lead of all other sporting papers.

Daniel Dale, Newburyport, Mass.

FORESTRY.

EDITED BY DR. B. E. FERNOW,

Director of the New York School of Forestry, Cornell University, assisted by Dr. John C. Gifford of the same institution.

It takes 30 years to grow a tree and 30 minutes to cut it down and destroy it.

FOREST AND STREAM FLOW.

One of the recent important investigations undertaken by the Bureau of Forestry, U. S. Department of Agriculture, is a study of the relationship of forests to stream-flow in the Rock river watershed of Illinois and Southeastern Wisconsin.

The study of the forest conditions of the Rock river basin is interesting because it constitutes one of the few cases in this country in which such an investigation has been made to apply directly to a given stream and locality.

For some years a marked decrease has been noticed in the flow of this river, especially during the more critical parts of the summer and autumn. The investigation which the Bureau of Forestry made of this watershed shows that the diminished flow of the river could be traced to several distinct causes. The most important of these are the changes that have taken place in the area and condition of the forests.

The present wooded areas of the Rock river watershed have been considerably reduced in their effectiveness as regulators and distributors of the water supply. This has been brought about by the improper treatment of the forest. The resulting changes in the composition of the woodlands and the unwise reduction of the wooded areas are in part accountable for the marked fluctuations in the river flow. The annual water supply has thus been unevenly distributed, both as to area and periods during succeeding years. The artificial drainage of swamps and other lands throughout a large part of this region has contributed to the same result. It is also shown that there was an actual decrease in the quantity of rainfall in the Rock river watershed during the last 16 years, and this has caused a slight diminution in the actual volume of the river flow, aside from its distribution.

On the other side it may be said, however, that the topographic features and geologic conditions of the Rock river watershed are exceptionally conducive to a sustained water supply, so that the agencies referred to as diminishing the flow did not produce as serious results during the season of drought as might otherwise have occurred.

The result of the investigation is noteworthy for the emphasis it places on the various effects of forests as protective covers for the soil, reducing evaporation, and improving the chemical and physical con-

ditions of the soil through the influence of leaf-litter and mold. The regulation and even distribution of the water supply is thereby greatly improved.

The investigation shows, however, that on account of the favorable topographic and geologic conditions of the region, there is but little cause for serious apprehension for the industrial and agricultural interests of the region, at least in seasons with a normal rainfall. Nevertheless, attention is called to the great value of a more conservative management of the forested areas in the Rock river watershed. The proper treatment of the wooded areas will be briefly and simply described in a report and will be exceedingly helpful to land owners in the region.—Exchange.

FORESTRY IN THE HAWAIIAN ISLANDS.

A press bulletin of the Bureau of Forestry says that the Hawaiian islands are in need of foresters, and eager to secure them. Governor Dole, who sees the immediate necessity of caring for the island forests, has applied to the Bureau of Forestry for expert men, to be sent as soon as they can be spared. The mountains are overrun by both wild and tame cattle, which graze and trample on young trees and destroy the ferns that protect the ground. When this ground cover is removed, the soil rapidly loses its moisture and the forest dies. Great areas of Hawaiian forest have been utterly destroyed in this way. The disappearance of so much forest on the island of Hawaii has caused remarkable changes in the flow of the streams. There are freshets and floods now, followed by long, dry seasons when the water does not run. Since much of the sugar crop depends entirely on irrigation, and since the irrigating ditches must draw their water from the mountain streams, the damage done the forest affects the prosperity of the whole island. Forestry in Hawaii has never been attempted by the Government, and the field will be an entirely new one. It will have the support and confidence of the people, who are eager for relief from the harm done them by the failure of their irrigating ditches to supply the sugar crops.

On the island of Molokai—the leper island—still more remarkable conditions prevail in the forest. There the timber is grazed and trampled to death not by wild cattle alone, but by herds of red deer, descended from a few that were imported

from England to stock parks. The deer imported propagated beyond the calculations of the inhabitants, escaped to the woods, and, since there are no animals to prey upon them, have increased to many thousands. The American forester who undertakes the care of the timber of Molokai will have a problem entirely novel to his experience—the protection of forests from wild animals.

E. M. Griffith, of the Bureau of Forestry, U. S. Department of Agriculture, who visited the Hawaiian islands on his way to the Philippines last winter, returned a report to Governor Dole in which he said the mountain forests of Hawaii must be fenced, on the lower slopes, to protect them from the tame cattle, on the upper slopes to keep out the wild ones. He also recommended the establishment of a forest force, consisting of a forest inspector, who should have charge of all Government forest lands and direct the work of the forest rangers; and 4 forest rangers, one for the island of Oahu, one for Hawaii, one for Kauai, and one for Maui and Molokai.—Science.

THE PEOPLE AND FOREST RESERVES.

Since the creation of the first forest reserves in this country, there has been a strong antagonism against the policy by misguided people, generally those whose personal interests are in some manner affected; but it is frequently encountered in those who should be the staunchest advocates of the policy; that is to say, the farmers and ranchmen in the Western States and territories. These people have had unrestricted use of the public domain and the native forests for so long a time that they have come to look on them as their own, and to regard any interference on the part of the federal government, by the establishment and administration of forest reserves, as a usurpation of their rights.

The successful administration of a forest reserve depends largely on the assistance and cooperation of the people living within and adjacent to it, and to secure this much desired condition is in many cases a problem not easily solved.

The first step in this direction is to educate the people in the vital importance of forest preservation by judicious distribution of the publications of the department.

The homestead act should be amended by making it a requirement that the homesteader should plant at least 2 acres of trees for each 40 acre tract covered by his entry, and that he have at least 100 trees, planted by him, in thriving condition on each acre at the time final proof is made. This could be done without adding any hardship and would be the means of materially enhancing the value of the land.

In order to encourage the propagation

of forest trees within forest reservations and at the same time acquire the cooperation of settlers and land owners within forest reserves, the free use of timber should only be extended to those who will agree to plant a certain area of their land to trees, the government to furnish the seedling trees. For the purpose of supplying the seedlings, the department should establish a nursery on each reserve, where possible. The advantages to all parties concerned would soon be apparent.—Forest and Irrigation.

SEEDLINGS.

At the 21st annual meeting of the American Forestry Association, held at Washington during the holidays, a resolution was passed in the interest of the proposed bill to establish the "National Appalachian Forest Reserve." The bill provides for the purchase of 4,000,000 acres of land at a cost not to exceed \$10,000,000.

A resolution was also passed favoring the management of the forest reserves by the Bureau of Forestry, thus doing away with the division of the Government forestry work between two separate departments.

The report of the Board of Directors showed that during the year 1902 new reserves and additions to those already declared amounted to 13,764,156 acres.

A commendable change has been made in the names of some of our reservations. They are mostly now called Forest Reserves. Formerly many were called Timber Land Reserves. There is need of greater uniformity and care in the use of the terms Park, Forest Preserve, Forest Reserve, Reservation, etc.

The Chippewa Forest Reserve of 200,000 acres has just been established in Northern Minnesota. It consists of virgin pine. 5 per cent. of this is to be left for seedage purposes. The rest is to be sold for the Indians who owned it.

The 2d number of the Forestry Quarterly, published at Cornell University, has made its appearance. It contains articles by Dr. B. E. Fernow, A. Knechtel and Dr. J. F. Clark. The magazine is meeting with considerable favor.

Over 100,000 plants will be set out by the Department of Agriculture during the coming year in an effort to determine what trees are best adapted to different localities.

"Mamma," queried little Edith on her return from Sunday school, "does God ever make a bluff?"

"Certainly not, my dear," was the reply.

"Well," continued the small inquisitor, "He makes hills and mountains, doesn't He?"—World's Guide.

PURE AND IMPURE FOODS.

"What a Man Eats He Is."

Edited by C. F. LANGWORTHY, PH.D.

Author of "On Citraconic, Itaconic and Mesaconic Acids," "Fish as Food," etc.

PEASANT COOKS AND COOKING.

In "A Girl in the Karpathians," an account of her wanderings in a region of Eastern Europe little known to most tourists, Mrs. Henry Norman describes the cooking of the family dinner by a Ruthenian peasant woman.

"Away up the hills and through the pine-tree glades we went, past little sunny bits of field, all full of flowers, and along the bed of a stream or 2, till we came to one of the quaint, comfortable wooden houses which are so unlike anything I have seen in our country. . . .

"Stooping at the wide spreading eave, which was a foot and more too low for me, I followed the painter (her companion) into the dusky keeping room, which is the hut, save for a sort of entrance part where provisions are stored. . . .

"After nods and good-days thrown variously to members of the family, we sit down on the wooden bench which runs around the wall, for stools and chairs there are none in a Ruthenian cottage. The bed and the stove usually share the opposite side of the room, the bed being a broader pine bench, with no mattress, but with several rough blankets on it; and the stove, a wonderful structure of wood and clay, which, with its surrounding waist-high shelf to place the pots on, is a good 6 feet square. The effect of this whitewashed stove is a pile of dressed stone blocks of differing sizes placed one on another; thus you have the base of all, then the protruding shelf, then the actual fire cavern, then the chimney and oven, the 2 last of decreased sizes. The fire hole is a foot and a half wide, a foot high, and 3 to 4 feet deep, running to the house wall at the back; the chimney root is in front of the fire, instead of, as in England, at the back or side. This excellent plan ensures the greatest heat and the best burning toward the front, and never have I seen a stove or an oven on which cooking becomes so artistic a pleasure as it does at these great Polish wood fires.

"On that upper ledge of the stove, where a graduated heat doubtless appeals agreeably to the extended body, a man lies, leaning on his elbow . . . another man is sitting somewhere near a little window, and a woman is thudding about the room with her fine bare feet.

"The woman, with instinct of politeness,

insists on the young pig and chickens dislodging themselves; and then, with surprising swiftness, she picks over and washes a heap of orange and white toadstools which no English or Scotch peasant would do more than kick over as they grew, let alone touch. Some of these she has by her in the wooden pot that holds the dandelion leaves; others she produces from within her single linen robe. They have lain there unsuspected by me, and quite uncrushed, in a row above the waist-line. I wonder when an English woman will be able to bring home mushrooms in her dress, above the waist-line?

"Let us pass from these idle fancies that ran in my head as I watched the squeezing out of these noxious agarici. They were soon rammed into a one-eared earthen pot, which was covered thriftily with close wire netting, in the way of a practical life assurance, as were all the jugs and pots I noticed, and set before the blazing pine wood fire. I have seldom seen a tub of potatoes less washed than was that woman's, but in an amazingly short time they were bubbling away beside the dandelions and the mushrooms. Without a pause she washes her hands, takes her rock and spindle and, sitting by the second window, one foot under her and the other upright on the toes supporting her weight, begins spinning."

As a rule, the peasants were not healthy and robust; but other reasons than poor food are believed by Mrs. Norman to be largely responsible.

"Poor food and a lack of personal cleanliness were probably not so much to blame as the facile English creed would have us believe; for it is a sophistry to call a diet poor because it includes no meat nor stimulant, and the monotony of maize meal and potatoes, with such things as mushrooms, dandelions, leeks, and eggs, is at any rate an extremely healthful monotony."

On another occasion Mrs. Norman watches a peasant girl at Zabie prepare some cakes, or bannocks, which seemed promising, at least to a hungry stranger.

"A fine wood fire was going and a pot of potatoes had been boiled. These she turned into a wooden trough, long, perfect in form, hollowed from a tree, where they were kneaded to a stiff plastic mass; a few handfuls of maize meal and young onions—leaf, root and all chopped up—being added. This she welded into 2 formidable cannon

balls of an almost alarming strength and cohesiveness. Then a long wooden stick, with a round flat piece of wood at its end, was produced, and on this she flattened each ball, turning with one hand, shaping with the other. Having cleared the lighted wood ash from 2 spots in the long white fire hole, she shook a bannock carefully from the spud-shaped spade to bake, and, using a small wood rake to gather it, drew the still glowing wood ash around their edges.

"My whole soul swelled with the poetry of this process, the manner of it, the girl's direct way, the ingredients, the tools, the delicate rose-grey flakes of the wood ash; all seemed epic to me, and as I sat watching the steam drying off those ideally real bannocks as the heat stole into them, I hardly dared to breathe.

"As they stood cooling, after they were cooked, browned, dry of skin, white dusty, or a trifle blackened where the ash had been too ardent, I looked at them and wondered that they made so little impression on the painter and the rest.

"Finally, when the bowl of milk was brought in, and the kolesha (maize porridge) was ready, they bade me break a bit off one of those elemental bannocks. . .

"Food so prepared from such material should have had a finer taste! If it had been cold, perhaps! Or it may have been the onions that were amiss; yet I like onions. It was perplexing. There was no handy solution of the fact, yet the bannock was not nice.

"My bitter sorrow! I tried a second bit; but no, I could not eat it."

ARTIFICIAL COLORING MATTER IN CANNED FRUITS.

Artificial colors are frequently added to foods to improve their appearance or conceal their inferiority. In the food and drug laboratory of the Massachusetts State Board of Health is a varied collection of strips of nun's veiling or albatross cloth, originally white, which have been dyed in a variety of fast colors by being boiled in solutions of various food products commonly found on the market. A similar collection has been prepared by the Bureau of Chemistry of the U. S. Department of Agriculture. These collections illustrate, in a striking manner, the extent to which jellies, jams, catsups, fruit syrups, and cordials, especially the cheaper varieties, are colored. Some of the samples were dyed various shades of red, pink and orange from preserved fruits and catsups. A deep yellow was obtained from lime juice, and a brilliant green from *crème de menthe*. The latter was completely decolorized by being boiled with the woolen cloth a few minutes. In most cases

these artificial dyes were aniline colors which may be identified by the action of various reagents on the dyed fiber. Tropæolin has been identified in lemon extract, Bismarck brown in canned apricots, pineapples, etc., azo-eosin in raspberry and strawberry preserve, and so on.

The method of determining the presence of coal-tar dye in jellies and similar products is given in a recent report of the Massachusetts State Board of Health. A good quality of worsted or white woolen cloth should be selected, taking care that the color is pure white and not the more common yellow-white. Nun's veiling has been found admirable. It should be freed from any trace of grease by being boiled first in a dilute soda solution and finally in water.

One authority recommends boiling the cleaned woolen goods in a dilute solution of the jelly, canned fruit or other material, to which potassium bi-sulphate has been added. After removing the cloth from the solution, boil it in water and dry it. The natural colors from fruit will make little impression on the wool under this treatment, the cloth being usually colored only a slight muddy or brownish hue. The azo-aniline colors, usually quite brilliant, are so firmly fixed on the wool that no amount of boiling or soaping will remove them. Tables of classified colors are given in various text books for the identification of the particular dyes by means of treatment of the dyed wool with various reagents, such as concentrated acids and alkalies.

VIRTUES OF THE PINEAPPLE.

According to the *Lancet*, "partaking of a slice of pineapple after a meal is quite in accordance with physiological indications, since, though it may not be generally known, fresh pineapple juice contains a remarkably active digestive principle similar to pepsin. This principle has been termed "bromelin," and so powerful is its action on proteids that it will digest as much as 1,000 times its weight within a few hours. Its digestive activity varies in accordance with the kind of proteid to which it is subjected. Fibrin disappears entirely after a time. With the coagulated albumen of eggs the digestive process is slow, while with the albumen of meat its action seems first to produce a pulpy gelatinous mass, which, however, completely dissolves after a short time. When a slice of fresh pineapple is placed on a raw beefsteak the surface of the steak becomes gradually gelatinous, owing to the digestive action of the enzyme of the juice.

"Of course, it is well known that digestive agents exist also in other fruits, but when it is considered that a pineapple of average size will yield nearly 2 pints of juice, it will be seen that the digestive ac-

tion of the whole fruit must be enormous. The activity of this peculiar digestive agent is destroyed in the cooked pineapple, but unless the pineapple is preserved by heat there is no reason why the tinned fruit should not retain the digestive power. The active digestive principle may be obtained from the juice by dissolving a large quantity of common salt in it, when a precipitate is obtained possessing the remarkable digestive power described.

"Unlike pepsin, the digestive principle of the pineapple will operate in an acid, neutral, or even alkaline medium, according to the kind of proteid to which it is presented. It may, therefore, be assumed that the pineapple enzyme would not only aid the work of digestion in the stomach, but would continue that action in the intestinal tract. Pineapple, it may be added, contains much indigestive matter of the nature of woody fiber, but it is quite possible that the decidedly digestive properties of the juice compensate for this fact."

PREHISTORIC COOKERY.

The remains of extensive buildings, just South of Tempe, in the Salt River valley, Arizona, have just been discovered, according to a recently published account, and are even larger than the famous Casa Grande. They are now but a mass of mounds, but it is said that the foundations of one which was recently traced measured 275 feet in length and 130 feet in width. Excavations have brought to light a number of *estufas*, or ovens, of such generous proportions that they might have sufficed to bake the bread for entire cities. Several were found measuring 16 feet in depth and 20 feet in width. Nearly all had been lined with a copper carbonate ore, which has fused in places, forming a metallic sheet. A study of the ovens shows that after the coals had burned down they were drawn out and the opening of the oven was practically closed. The ovens were filled with the beans, corn and mesquite root which were to be cooked, until the top of the pile was level with the surface of the ground. Over all a thick roofing of mud was spread, a quantity of water being added before the oven was entirely closed and made air-tight. Then the mass was probably allowed to cook a number of hours, something after the manner of the clams, chicken, and sweet corn at a Rhode Island clambake. It is further conjectured that after the corn was steam-cooked it was dried and became a staple article of food for winter. Such dried corn has been found in earthen jars.

In the same mounds a number of stone *metatis* and grinders were discovered, showing the primitive process of milling followed. Many pieces of pottery, some in

excellent preservation, were also found. In shape and decorations the *olas*, or water jars, closely resemble those made to-day by the Zuni, Pueblo, and Mancipa Indians. The glaze and texture, however, are superior to modern work.

A NEW SOUTHERN FOOD PRODUCT.

Dried sweet potatoes are a comparatively new food product, a sample recently examined being the result of experiments carried on at the South Carolina Agricultural Experiment Station. In the process of manufacture, the potatoes were boiled, peeled, sliced and evaporated. When dried they were packed in cardboard boxes.

These dried sections of potato are rather darker in color than the fresh material, and are about as hard as leather. They contain some 13 per cent or less of water, 3 per cent protein, and 18 per cent carbohydrates, of which a considerable part is sugar. The evaporated potatoes, it is claimed, will remain in perfect condition for years. They are prepared for the table by being soaked in warm water a quarter of an hour, and then may be cooked and seasoned in a variety of ways.

This process of drying may, it is believed, secure to the Southern farmer the preservation of the surplus of one of his most prolific and important crops, in a form fitted for safe and economical shipment to distant markets, and the manufacture of evaporated sweet potatoes should prove of great benefit to Southern farmers if the product is found to be as satisfactory on further trials as seems probable.

An acre of land will yield over 350 bushels of raw potatoes, under good conditions, which in turn will produce about 100 bushels of the dried product.

Landlord—I will give you just 3 days to pay your rent.

Artist—All right; suppose you make it Thanksgiving, Christmas and the Fourth of July.—Life.

Mary had a hot mince pie,
That she thought she'd like right well,
She took a bite, which burnt her mouth
And Mary said, "Oh, h——!!!"

RECREATION is the best sportsmen's journal I ever read.

Will H. DeGross, Fleming, N. Y.

Cannot possibly get along without RECREATION.

John. R. Taylor, Freeport, Pa.

BOOK NOTICES.

IMPORTANT TO FORESTERS.

"The Forests of Rhode Island" is the title of Bulletin 88, issued from Kingston by the Agricultural Experiment Station of the Rhode Island College of Agriculture and Mechanic Arts.

The forestry problem in general is first discussed, it being shown that the aim of forestry is judicious cutting, not the prevention of all cutting. The economic importance and the financial side of forests are treated briefly, the conclusion being that profit can be hoped for only on land of little agricultural importance. Serious enemies to the forest are fire and taxation; the former not so much on account of the damage which it causes to standing timber as from the fact that by it the young growth is destroyed and reproduction thereby prevented. Taxation is liable to be an enemy to the forest, because, on account of the long time that must elapse before the crop can be harvested, even seemingly low taxes may cause the final cost to be brought above the possible returns. The public benefits are so great that in a few States laws exist for the exemption of forest lands from taxation. The Rhode Island, Massachusetts and Connecticut laws are incomplete, since they refer only to artificial planting, which is the exception rather than the rule in forestry. The Pennsylvania law, however, provides for a rebate on natural timber lands of 80 per cent. of the taxes, county and local. The rebate may not exceed 45 cents per acre, nor be granted to any individual on more than 50 acres.

A fully illustrated account of the character and distribution of the forests of Rhode Island is given. It is estimated that 40 per cent. of the area of the State is woodland. In 1900, there were 33 saw-mills in the State, and 2 tie and lumber camps. The total lumber product of the State amounted in that year to 18,265,000 feet B.M., of which about 80 per cent. was white pine. The forestry question in Rhode Island is mainly one of dollars and cents, since the danger from floods is comparatively slight, there being no mountains and few high hills; and since close proximity to the ocean insures a humid atmosphere, thus doing away with the necessity of the forest as a wind-break.

The pamphlet concludes with a discussion of the value of a few of the more important species of trees, from the economic standpoint.

Indicative of the remarkable growth of interest in the forestry problem in the United States, is the fact that during the past year several books on the subject have made their appearance, addressed to all

classes of readers. The appearance of these books fills a definite want, for hitherto it has been impossible for one unacquainted with French or German to procure authoritative literature upon this subject, the great importance of which is now being recognized by the public.

DR. JOHN C. GIFFORD'S NEW BOOK.

In his "Practical Forestry," Prof. John Gifford has presented a practical treatise on the science and art of forestry. It is intended for the use of the general reader, giving a broad insight into the subject as a whole, and presenting much information of value to those who have tracts of woodland to be managed, as well as to those who are interested in the various industries connected with forests and forest products. The subject is treated in its relation to the kindred subjects of agriculture and horticulture, and is shorn of all unnecessary mathematics and technicalities.

Part I., Introductory, treats of the meaning of forests and forestry; woodlots on farms; forest estates and the relation of silviculture to the kindred arts; the forest canopy, forest floor, and wood mass; the forest as an agent in modifying the surface of the earth and in checking the destructive forces of nature; and the geographical distribution of forests. Part II. discusses the formation of forests, the use of improvement cuttings, and methods of protection against fire, atmospheric agencies, insects, parasites, weeds, etc. Part III. treats of the industrial importance of forests. Part IV., Supplementary, contains an account of the principal Federal and State reservations, together with a descriptive list of 50 American trees.

Mr. J. W. Lloyd, a contributor to RECREATION, has written a book. As its title, "The Natural Man," indicates, it is a plea for a return to simple living, in close touch with nature, and for the development of individuality. Many such pleas are in the air nowadays, as the pressure of man's achievement grows too strong to be borne with comfort. The dream of peace imagined by Mr. Lloyd is unique and daring. He disarms opposition, however, by his salutation, "It is not meant, O Reader, that you should live life as this man lived it, but only that you should fearlessly and gladly live your own life." On that basis it is interesting to follow Mr. Lloyd's idea, which certainly offers many artistic possibilities.

"The Natural Man" is published by Benedict Prieth, Newark, N. J.

PUBLISHER'S NOTES.

PLACE YOUR ORDERS NOW.

I called on H. J. Putman & Co., of Minneapolis, in February last, and was greatly interested in examining their plant of machinery for the making of hunting boots and shoes. They have an entire loft in a big brick block, the floor of which is well-nigh covered with machines of every possible style for such work, and all of these are of the latest and best patterns. It is a revelation to learn how great a business this house has built up in supplying footgear for sportsmen. Putman & Co. employ 75 to 150 people, according to the time of year. During the spring and summer months their orders come slowly, and this is, consequently, the best time for sportsmen to order boots or shoes. If you are going on a fishing trip next summer, or a hunting trip next fall or winter, you should order your boots or shoes now, instead of waiting until within 2 or 3 weeks of the time for starting. Putman & Co. will be snowed under with orders at that time, and it will be difficult for them to fill any of them promptly. On the contrary, if your order goes in now, they can give careful attention to every detail of it, can ship your goods promptly, and you can then have them seasoning through the summer. Best of all, you will have the satisfaction of placing your boots or shoes in the bottom of your war bag when you first begin to pack, instead of lying awake nights and suffering from indigestion for fear you will not get your footgear in time for your long anticipated trip.

WHY YOU SHOULD TRY IT.

Government statistics show that the Miami valley, in Ohio, produces better grain and has purer water than any other section of this country. In the heart of this favorite spot is the Hayner distillery, having at its door the 2 essentials for producing the finest whiskey in the world—the best grain and the purest water. Add to these one of the most completely equipped distilleries ever operated and an experience of 36 years in distilling whiskey, and you have a combination that is unequalled anywhere. That is why Hayner whiskey is superior for medicinal and other uses. That is why they have over a quarter of a million satisfied customers. That is why you should try it. It goes direct from their distillery to you, with all its original strength, richness and flavor, carries a United States Registered Distiller's Guarantee of purity and age and saves the dealers' enormous profits. Your money back if you are not satisfied. Read elsewhere in this issue the offer of the Hayner Distilling Company.

A MAP OF BRONX PARK.

Bronx park is an institution in which every American should feel an interest. It contains the largest botanical garden and the largest zoological park in the world, and is open to the public every day. No description of it can do it justice. It requires days of careful study to get an idea of the wealth contained in these 2 great gardens, one devoted to plants, shrubbery and trees, and the other to birds, beasts and reptiles. New Yorkers can now visit Bronx park and feel proud that they are citizens of this great city. No. 14 of the Four Track Series, just issued by the passenger department of the New York Central railroad, is devoted to Bronx park. It contains a map showing both the botanical garden and the zoological park, with their lakes and river, and a brief description of each. A copy will be sent free, post paid, on receipt of a 2-cent stamp, by George H. Daniels, general passenger agent, Grand Central station, New York.

BEAUTIFUL CALENDAR FREE.

The Equitable Life Insurance Co., 120 Broadway, has issued one of the most beautiful calendars of the year. It consists of a series of 6 drawings of beautiful girls waving or displaying, in various ways, the American flag. The first picture shows the complete national emblem of to-day; the second shows the older forms with 13 stars; the third, the old pine tree flag of 1776; the fourth the first Union flag, adopted January 2, 1776; the fifth, the blue flag of liberty, with the crescent in the upper left corner, adopted in September, 1775; and the sixth is the old yellow rattlesnake emblem, bearing the motto, "Don't tread on me."

These pictures impart a valuable lesson in history, and every family in the land should have a set of them. You can get the calendar free of charge, by writing the company as above, and mentioning RECREATION.

A PIANO AT A NOMINAL PRICE.

Chicago's largest music house, Lyon & Healy, announces a clearing sale of pianos. Several hundred splendid instruments are offered without reserve until all are sold. In square pianos there are fine toned instruments at \$25, \$40, \$60, and upward; in upright pianos, neat instruments at \$100, \$120, \$140, \$150, \$165, \$190, \$200 and upward; in baby grands some choice specimens at \$250 and upward. Lyon & Healy will send a list and full particulars on application. Any piano not proving entirely satisfactory may be returned at their expense. Address Lyon & Healy, 39 Adams street, Chicago.

Gall & Lembke, opticians, 21 Union Square, New York, celebrated the completion of their 61st year in business in this city by opening a branch store at 1 West 42d St., thus recognizing the uptown movement of business, and it is safe to say that all who know the careful, conscientious methods of this old reliable house will appreciate this new departure. The new store is near the Grand Central Station, and thus affords easy access not only to people who live in upper New York, but to those visiting the city on the N. Y. Central and the New Haven lines.

Spratts Patent penned and fed the Boston Poultry, Pigeon and Pet Stock Show, the New York Poultry and Pigeon Association Show, and the 27th Annual Show of the W. K. C. at Madison Square Garden, February 11 to 14. It takes a big plant and a large and experienced staff to do this kind of thing. Spratts Patent has made another contract with the Ziegler Polar Expedition for a large quantity of dog cakes. It will be remembered that the Baldwin-Ziegler Expedition took about 100 tons of Spratts Dog Cakes in hermetically sealed tins.

The cowboy outfits made by the Edward Smith Indian Post Trading Company are among the best in the market and are favorites with the leading rifle and pistol shots of the world. The belt and holster which this company is selling for \$1.75 is a remarkable bargain, and every man having use for any goods of this kind should write the Edward Smith Company for their descriptive catalogue. They also deal in Navajo blankets, Indian pottery, baskets and curios. In writing the company please say you saw their ad in RECREATION.

F. C. Reihl won first place at the Dupont shoot at St. Louis, New Year's day, 31 out of 32, with U. M. C. Arrow shells.

O. H. Ford, Central City, Ia., writes that he has won 16 high averages during the shooting season just passed, averaging over 91 per cent for the year. Mr. Ford has made 7 runs of over 50 straight. This is excellent shooting for an amateur. It was done with U. M. C. Arrow shells.

The Page Fence Co., Adrian, Mich., sold in its home county in 1902 over \$76,000 worth of Page fence. They tell me this is the largest sale they have ever made in that county, and that it is larger than they have ever made in other counties in their State. This is certainly gratifying evidence

as to the great value of the fence these people build.

Raton, New Mexico.
West End Furniture Co.,
Dears Sirs:—I received the gun cabinet in good condition and am well pleased with it. It is perfect in every respect and is just what I have been looking for. Every sportsman should have one.
Yours truly,
Alfred Peterson.

New York.
Messrs. Wing & Son:
Your pianos have given entire satisfaction and I cheerfully recommend them to anyone needing a fine piano.
Yours truly,
P. H. Roche,
Proprietor Rossmore Hotel.

The Northern Rubber Co., heretofore of Minneapolis, have removed to St. Paul, Minn., where they have better facilities than ever for handling their business. See their ad on page xl of this number.

The Century Camera Co., of Rochester, N. Y., are preparing a handsome catalogue, which will be ready for distribution about March 20th.

I have just received the Savage rifle you so kindly gave me for subscriptions to RECREATION. Am well pleased with it and think it excellent pay for so little work. Allow me to sincerely thank you for your prompt attention and generosity.
C. E. Stambaugh, Akron, O.

Please accept my thanks for the Korona camera which I received as a premium for subscribers to RECREATION. I am much pleased with it.

Mrs. Wm. N. Manchester,
Monson, Mass.

I received the Harrington & Richardson revolver in return for 5 subscriptions and am well pleased with it. It is certainly fine, and I thank you for it.

F. L. Lovett, Newtown, Pa.

The Bristol steel fishing rod sent me as premium received. Am more than pleased with it.
H. H. Usher, Palo, Ia.

No sportsman can do without RECREATION
Geo. B. Pettingill,
Newburyport, Mass.

EDITOR'S CORNER.

THE L. A. S. IS THE OFFICIAL GAME PROTECTION ASSOCIATION.

The most important meeting the League of American Sportsmen has ever held was that which convened in St. Paul, February 11th. The Governors of 22 States appointed delegates to that convention, thus giving the League the absolute sanction of the States and recognizing it as the Official Game Protection Association of this country. Although the Governors of the various States have from time to time appointed delegates to other conventions, having for their object some important measure of public interest, this is the first time any of them has sent representatives to any meeting in the interest of game protection.

Following is a list of the States whose Governors have thus given the League their definite sanction:

Arizona.	New Mexico.
Arkansas.	North Dakota.
Colorado.	Ohio.
Florida.	Oregon.
Iowa.	South Carolina.
Kentucky.	South Dakota.
Maine.	Virginia.
Michigan.	West Virginia.
Minnesota.	Wisconsin.
Montana.	Wyoming.
Nebraska.	Washington.

This is one of the most important achievements of this League, though

it has done many other great things. We may confidently expect that in future years the chief magistrates of the other 28 States will fall in line, and that at the next annual meeting we shall have delegates clothed with official authority from all the States.

January last Game Warden Hoyer, Sioux City, Ia., found in the possession of one B. C. Potter, a market man of that town, 200 prairie chickens. Hoyer swore out a warrant for Potter, and when the case came on for trial, State Warden Geo. A. Lincoln, of Cedar Rapids, went to Sioux City to look after the case. Potter demanded a jury trial and C. A. Moore, H. D. Osborne, George Pierce, J. C. Rennison, D. L. Pratt and Charles Lever were impaneled to try the case. The State proved by the local warden and 2 witnesses that the 200 birds were found in Potter's cellar and there rested the case. The defendant did not produce a witness. His attorney attacked the law and pleaded for a small fine. The jury returned a verdict to the effect that the State game law had been plainly violated, and found the defendant guilty of having one prairie chicken in his possession, saying nothing about the other 199 birds. Justice Brown, before whom the case was tried, assessed a maximum fine of \$20, which Potter paid and was discharged. These 6 jurors deliberately violated their oaths by allowing their sympathies to interfere with the course of justice, and should be prosecuted.

It will be good news for the friends of the gray squirrel to know that the L. A. S., at its annual meeting held in St. Paul Feb. 11, passed a resolution advising all sportsmen and others to refrain from killing this animal, and to adopt him as a pet. The resolution memorialized the Legislatures of the various States to enact laws prohibiting the killing of gray squirrels at any time. It is printed in full in the report of the meeting elsewhere in this issue.

The Korona camera you sent me as a premium has been received. I am much pleased with it. Thank you.

Chas. H. Hakes, Binghamton, N. Y.

I received the Shakespeare reel as premium and am delighted with it.

C. B. Wills, Cleveland, Ohio.

**Over a
Million
Barrels a
Year**

Schlitz

Those are sales of Schlitz Beer making it the leader of all Milwaukee beers, by far.

That's a result of maintaining absolute purity.

We doubled the necessary cost of our brewing to have Schlitz Beer right.

The Result Is

A Million Barrels a Year

We have used the best materials—the finest barley—paid as high as twice what we need pay for hops.

We bored six wells to rock to get pure water.

We kept our brewing as clean as your cooking.

The Result Is

A Million Barrels a Year

We filtered all the air that touched the beer.

We filtered the beer through white wood pulp.

We aged it until it could not cause biliousness.

We sterilized every bottle after it was sealed.

The Result Is

A Million Barrels a Year

Isn't Schlitz Beer—pure beer—worth asking for, when the cost is the same as of common beer?

Ask for the Brewery Bottling.

**THE BEER
THAT MADE
MILWAUKEE
FAMOUS**

A TAME CENTIPEDE.

F. STOCKDER.

Returning from the depot where I had been to see my wife off for Denver, and thinking how desolate home would seem until her return, I reached my house just as a neighbor, Miss Myra H., came hurriedly through the gate.

"Oh!" she cried, on seeing me, "I have just been to your house in the hope of finding my uncle. Have you seen him this morning?"

I confessed my ignorance of the gentleman's whereabouts.

"Oh, dear, what shall I do? Did you ever see a centipede, Mr. S.?"

"Lots of them," I replied. "The boys killed a number on my place last summer."

"What are they like?"

"The body is yellowish brown, about the thickness of a small pencil, and consists of numerous joints. Each joint has a liberal supply of legs attached to it, and both head and tail are so lavishly ornamented with horns and things that you can not tell one from the other."

"Yes," she said, "I was sure of it; there is one in my room now. Won't you come and kill it or drive it away?"

"And is that the only cause of your excitement?" I asked. "I feared some dreadful accident had occurred, or that you had seen a mouse."

"Aren't they awful dangerous?"

"Mice?"

"No!" with an indignant snap. "Centipedes. Folks say they will jump on you and stick all those legs into your flesh and poison you."

"Horrible! Why didn't you take a hat pin and stab the beast?"

"Oh, I wouldn't go near it for the world. It would surely bite me."

"How large is it?" I inquired.

For answer she held her hands about 7 inches apart.

"Phew!" I said. "It must be great-grandpa Centipede. Let's have a look at this monster."

At Miss Myra's boarding place we found the landlady, armed with a 6 foot length of scantling on guard at the front door. Assured that I was going to beard the terror, she begged me to be careful and offered me her "stick." I declined the formidable weapon and we entered the house. At either end of the hall were grouped women carrying brooms, pokers, and rolling pins, and casting apprehensive glances up the stairs. Miss Myra and I went up to her room, the door of which stood open. So far my companion had shown admirable courage. Standing in the doorway she pointed a slender finger toward a dark corner and said:

"There it is, behind the washstand; but don't go near it, please don't."

The stand had been moved back from the wall and behind it on top of the baseboard

I saw the cause of all the commotion. It was a little fluffy roll, about 2 inches in length, and was moving in a lifelike way but without making any progress. On closer examination I perceived that the thing was lifeless, its motion being caused by a draught from behind the baseboard. I laid it in the palm of my hand and walked to a window. It was a wad of hair removed from a comb.

When I came out of the room a general stampede followed, accompanied by violent shutting of doors. I called Miss Myra and she approached cautiously. Said I:

"This centipede is of the blonde shade which I particularly admire, and matches charmingly with your strawberry and vanilla complexion."

A flash of recognition came into her blue eyes. She blushed and said, "Oh!"

Then a door near where we stood was unbolted and Miss Myra's mother appeared. "Is it dead?" she asked.

"Entirely so," I replied.

Then I discreetly retired, leaving the daughter to make further explanations. It is a strange thing that when I have seen that young lady since, she has not seen me.

A HOOSIER IN DIXIE.

In February, '98, I visited Washington county, Florida, which is a beautiful tract of woodland extending from the Alabama line to the gulf. It is inhabited by deer, turkeys and quails, and many kinds of ducks and other water fowl, with an occasional bear and wildcat to be found in the swamps.

Several varieties of fish are found in the streams and lakes, which, with the oysters of the salt water, make it an ideal place for the sportsman.

It would soon be close season, and owing to the absence of a good rifle for large game I was compelled to hunt such game as would fall to my 12 gauge, namely ducks, quails and rabbits.

While there I met John W. Chapman, an enthusiastic sportsman from Warsaw, Ind., who, with his 30-30 Winchester, had come to get large game. The poor fellow was doomed to disappointment.

He saw some beautiful seashells in the shallow water and waded forth to get them. A few minutes' wading in the salt water under the tropical sun developed such an attack of sunburn as to confine him to the hotel for the rest of his sojourn in Dixie.

A Northern man, in company of friend C., was driving through the pine woods when 3 deer dashed from the bushes and at a short distance stopped to gaze at the intruders. As they took to their heels again, our tenderfoot exclaimed, "Gee whiz! what pretty Jersey calves!"

North Central Florida is an ideal place for sportsmen.

Charles W. Potter, East Enterprise, Ind.

\$10000

THE EQUITABLE

HENRY B. HYDE
FOUNDER

J.W.ALEXANDER
PRESIDENT



J.H.HYDE
VICE PRESIDENT

ABOUT \$1

a week paid on
an Endowment in the Equitable
will give \$1,000 — with profits —
to you at the end of 20 years
- if you live.
If you die your family receives
\$1,000 at once. Issued in amounts from
\$1,000 to \$200,000.

Vacancies in every State for men of energy and character to act as representatives.

Apply to GAGE E. TARBELL, 2nd Vice President.

SEND THIS COUPON FOR PARTICULARS, OR WRITE

THE EQUITABLE LIFE ASSURANCE SOCIETY OF THE UNITED STATES, 120 BROADWAY, NEW YORK Dept. No. 16.

Please send me information regarding an endowment for \$.....if issued at.....years of age.

Name.....

Address.....

\$1

AMATEUR PHOTOGRAPHY.

"For sport the lens is better than the gun."

I wish to make this department of the utmost use to amateurs. I shall, therefore, be glad to answer any questions and to print any items sent me by practical amateurs relating to their experience in photography.

A RAPID METHOD OF PRINTING DEVELOPING PAPERS.

Those who are accustomed to using Velox, Cyko and other papers which are printed by artificial light, and those who make blue prints, have doubtless often been annoyed by the necessity of testing each new negative with several strips of printing paper in order to determine the proper exposure. This means not only loss of time, but a loss of paper and developer, which in the long run amounts to considerable. By means of a simple device, and with the aid of a table or chart, I find I can now either operate several frames at once, or keep one frame constantly printing before the light and carry on development, trimming, washing, etc., at the same time.

The device shown in Figure 1 is merely a

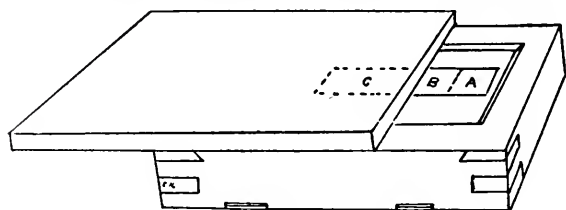

FIGURE 1.

printing frame laid flat on a table. Immediately covering it is a loose board, while above the entire device is suspended the ordinary incandescent electric light, at a distance approximating the diagonal of the

lowed to continue one minute longer. The part A has thus been exposed 3 minutes, B 2 minutes, and C one minute. By developing this strip the operator is able to judge the correct exposure at once. The above 3, 2 and one minute exposures are given merely as an illustration. They may be varied to suit the density of the negative or the actinic strength of the light used. The exposures may also be increased in number to 4, 5 or even more minutes, at the pleasure of the operator.

On the backs of 5 x 7 frames and larger is found a semi-circle of numbers from 1 to 12 inclusive, with a movable pointer, which can be placed at any one of these numbers. To smaller frames such a device is readily attached. To make use of the chart shown in Figure 2 place the pointer on the first frame to be used, at 1. Enter this number in the left column of the chart, and the proposed test in the next column. In the second column from the right jot down the number of prints desired from that particular negative. Make the test exposure, and when the correct time is determined, put it down in the column for that purpose. Put in a full sized sheet of paper and start the negative printing. While this one is printing, the second and third frames can be prepared ready to follow the first, putting down their numbers and exposures on the chart as at first. As each print is made, check it off in the right column. In this way one frame may be constantly left under the light and during exposures the operator has ample time to reload frames, change negatives, develop prints, etc. He has absolutely nothing to carry in his head except the exposure he is giving the negative under the light. He can pick up any frame out of a dozen, and a glance at the pointer on the back and at the chart will at once tell him the proper ex-

NEGATIVE No.	TEST	PROPER EXPOSURE	COPIES WANTED	COPIES MADE
1	3 2-1	2	4	
2	6-4-2	6	3	
3	5-4-3	4½	2	1
4	1½-1-½		6	

FIGURE 2.

printing frame. In the frame are placed the negative and the test-strip; and the cover-board is placed over the frame so as to expose the portion A of the test-strip. This portion is exposed one minute, when the board is withdrawn so as also to expose B. At the end of the second minute the board is removed and the exposure al-

posure, number of prints desired, and number of prints already made from that particular negative.

While this process may appear rather cumbersome, a trial will quickly demonstrate its efficiency in saving material and time.

Wilmon Newell, College Station, Texas.

STAINS.

One of the troubles of the photographic worker is the appearance of all manner of stains, on the hands and fingers, on the films, on the prints.

Stains on the fingers can generally be removed by the application of a little paste made of a-quarter of a pound each of Glauber's salts and chloride of lime in about 4 ounces of water. Applied with a bit of pumice stone or a nail brush.

To remove nitrate of silver stains from the hands, few things are so good as a little solution of chloride of iron.

A reducer such as ferricyanide and hypo may stain the prints, especially bromide. A better way is to use a reducer made of chloride of lime. An ounce of bleaching powder stirred up in water, and the solution filtered, gives a capital agent for the purpose, since it not only reduces the print and picks out the high lights, but clears it and takes away the yellow color so often present. In fact the solution gives clean whites, and altogether renders the print more vigorous and brilliant. After this process all that is wanted is a good washing.

The chloride of lime solution will also clear away the yellowing of platinotypes. Indeed, the bath may easily be made still more active in that direction by the addition of a dram of hydrochloric acid to each pint.

Many a good negative has been spoiled by haste in trying to print quickly from it, putting a piece of silver paper on the unfortunate negative before the latter was thoroughly dry. These silver stains are often difficult to remove, but a good plan is to use a solution of 3 grains of iodine in an ounce of methylated spirit. Wash the negative thoroughly and then lay it in the iodine solution until the silver stains lose color. A good washing in running water should follow, after which the process should be completed by a bath of hypo. If this process is found to reduce the negative considerably, intensification may have to be resorted to. Placing the stained negative in clean hypo solution is often sufficient to remove any markings of this class, though a prolonged soaking is sometimes necessary to thoroughly clear the plate.

For most chemical stains on the hands a dabbing with any weak or diluted acid proves sufficient. For pyro stains rub the fingers with a crystal of citric acid, giving the skin plenty of washing between the rubbings.—American Photographer.

THE ACID FIXING BATH.

The acid fixing bath is frequently recommended by writers and manufacturers alike, especially for use with plates and papers which have been developed with such so-

lutions as those containing metol, hydroquinone and soda, which have the undesirable effect of leaving a filmy white sediment behind that not infrequently leads to yellowness of the whites in the prints. Probably every one has at some time or other added a few drops of sulphuric or hydrochloric acid to the fixing bath, with the intention of rendering it acid, only to find a yellow precipitation of sulphur take place with the accompanying evolution of sulphuretted hydrogen. Fixing baths containing sulphite and sulphuric acid, unless scientifically mixed, must inevitably produce sulphuretted hydrogen, and thus be as dangerous as, or more so than, the much condemned though useful combined toning and fixing bath. It will be found, however, that the addition of sulphurous acid to ordinary 20 or 25 per cent. hypo solution, in the proportion of one to 2 drams a pint, renders it acid, and though on addition a faint trace of H²S is to be detected, no precipitation should take place. A good bath is thus made, of remarkable keeping qualities. The sulphurous acid may be prepared easily by putting sodium sulphite and sulphuric or hydrochloric acid, 50 per cent. with water, into a flask which is connected by a delivery tube with a bottle filled with distilled water, the tube going to the bottom of the bottle. It is safe also to substitute a bottle for the flask. The bubbles of gas are dissolved in the water until it is saturated, the chemicals in the flask being replenished from time to time as necessary.—Photography.

TROUBLES WITH CYCO PAPER.

In response to the complaints of J. C. C. and J. E. Bates in regard to the blistering of Cyco paper, I beg to say that the trouble probably lies with their method of handling it. Just the other day a dealer handed me a dozen 5 x 7 Cyco, with the remark that he wished me to try it. He went on to explain that it blistered as soon as it was transferred to the wash water. I told him that he was probably at fault, upon which he told me he would give me 2 bits if I got one print out of the dozen that was not blistered. I got my own formula for developer and in a few minutes we were at work. All came out beautifully, and there was not a blister in the lot of nearly 2 dozen. My method is as follows:

After printing remove from the frame, slide the print into the developer, and rock the tray vigorously, so as to cover the paper as quickly as possible. Do not wet the print before development. Use metol-hydro developer, and plenty of it, say $\frac{3}{4}$ inch deep, in a deep tray. If air bells appear on the print remove them and if the printing has proper time the spot caused by the bell will soon catch up and be of the same den-

sity as the rest of the print. After developing rinse well in a bath of water made somewhat acid with acetic acid, and fix in an acid fixing bath, containing alum; or fix in a bath of hypo with a little sulphite of soda and formaldehyde, using say one dram of formaline for every quart of solution. Be careful of this chemical and its fumes, as they are dangerous. Do not let a heavy stream run from a faucet in washing, as it might cause trouble, especially if it falls any distance.

B. L. Cunningham, Ashland, Ore.

SENSITIZING AND PRINTING ON LINEN.

First thoroughly wash the linen, then soak in the following:

Water 8 ounces.
Potassium bromide 45 grains.
Cadmium bromide 15 grains.
Potassium iodide 15 grains.

After drying, sensitize in the dark room in a solution of

Water 5 ounces.
Silver nitrate 15 grains.
Citric acid..... 15 grains.

Dry in the dark, and, when printed, develop with

Water 7 ounces.
Pyro-gallol 75 grains.
Citric acid..... 6 drams.

Follow with a good washing, when it may, if desired, be toned with a bath made as follows:

Water 1 pint.
Ammonium sulpho-cyanide.... 187.5 grains.
Gold chloride 7 grains.

Then fix and wash in the customary way.—Exchange.

SNAP SHOTS.

Can you tell me how to cement photographs on to glass and what to use to stick them so they will be smooth and have no air bubbles under them? I have some and it seems that the picture was pasted on the glass and then a piece of cardboard cemented on the back.

J. E. Brackett, Newport, Mass.

ANSWER.

To mount print on glass make a solution of Nelson's X opaque gelatine, 20 grains to each ounce of water, and while still warm immerse the print, face downward, in it. Place the glass in it and after a few seconds bring them in intimate contact. Withdraw from solution, squeegee thoroughly and allow to dry.—EDITOR.

In mounting prints on thick paper, such as royal bromide, difficulty is sometimes

experienced in making the print adhere to the mount at the edges. This difficulty may be overcome by applying to the back of the print a marginal line, about one-eighth of an inch, of Le Page's fish glue. The rest of the back of the print may be covered with starch, or any ordinary photo paste, which is quite strong enough to hold down the center of the print, and is applied more easily on a large surface than glue. By this plan a print may be firmly mounted without any danger of its leaving the mount.—Exchange.

I am in need of a putty, or cement, that will stand the chemicals used in developing solutions, especially metol and hydroquinone. Can you help me out through your photographic department?

Handy H. Bowen, Chicago.

ANSWER.

You do not state purpose to which you will put the putty or cement. If for wooden trays, melt paraffin in a cup and brush over the wood with a short, stiff brush; then pass a laundry iron over it, forcing it into the pores of the wood. Aspinwall's bath enamel is also excellent.

The League of Long Island Photographic Clubs held a meeting in the rooms of the Brooklyn Academy of Photography January 14, delegates from the various clubs being present. An interchange of lantern slide exhibits among the various clubs has been arranged. The first of these was held in the rooms of the Brooklyn Camera Club, the slides being the work of the members of the Department of Photography, Brooklyn Institute of Art and Science. The slides were excellent and the attendance was large. The League will arrange for an interchange of prints in the near future.

John J. Tresidder, Brooklyn, N. Y.

To make lusterless black varnish for optical instruments, rub fine lampblack with shellac varnish. If the surface of the varnish when dry shows any luster, it contains too much shellac, and should be diluted with alcohol. It is said that this is a safer varnish to use in photographic dark slides than any kind containing turpentine.—Exchange.

In dull and cold weather when it is found necessary to leave unfinished prints in the frame overnight, one spring should be loosened; this simple precaution will often prevent the negative from breaking.—Exchange.

Will readers of RECREATION please tell me which 4 x 5 camera they consider the best for an amateur?

Earl Dunn, Iowa Falls, Ia.



*You
press
the
button—*

*then
do
the
rest.*

KODAK

Developing Machines

do away absolutely with the dark-room and give better results than the old way. Anybody can make perfect pictures by the Kodak System. *Ask your dealer to show you.*

Kodaks, \$5.00 to \$75.00. Brownie Cameras, \$1.00 and \$2.00.
Kodak Developing Machines, " " " \$2.00 to \$10.00.

Kodak Literature at the dealers or by mail.
Catalogues, free.
Correspondence School Circulars, free.
Kodak Baby Book, free.
Kodak Portfolio, containing 40 prize winning pictures, ten cents.

EASTMAN KODAK CO.

Rochester, N. Y.

Great gain in utility; no loss in convenience.

Folding Weno Hawk-Eye

with Special Equipment

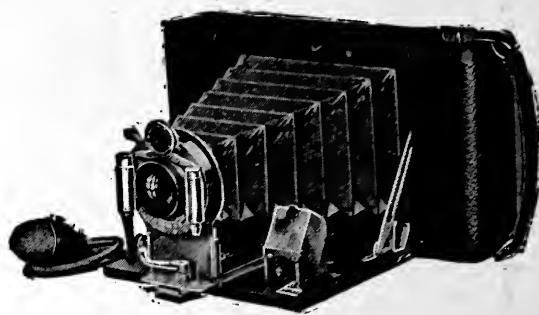

A superb camera for amateur or even professional use. Latest features include long focus double extra rapid rectilinear lens, extension bed, rising and falling front.

Folding Wenos are pocket cameras using either Perforated Daylight Loading or Cartridge Film. They have two tripod sockets and reversible brilliant finder. Can be fitted with glass plate attachment.

- | | |
|--|---------|
| No. 3 Special Folding Weno Hawk-Eye with Extension Bed, Rising and Falling Front, Extra R. R. Lens, and B. & L. Automatic Shutter (pictures, 3¼ x 4¼), | \$22.50 |
| No. 4 Folding Weno Hawk-Eye, with Extension Bed, Rising and Falling Front, Extra R. R. Lens and B. & L. Automatic Shutter (pictures 4 x 5), | 27.50 |

BLAIR CAMERA CO.

Rochester, N. Y.

*Write for
Hawk-Eye Booklet.*

Hawk-Eye film is prepared for Development in the Kodak Developing Machine.

IRISH FOXES.

R. C. STEVENS.

"Spakin' av foxes," said my friend Mc-Lanahan, "butune you an' me, there's no foxier fox than an Irish fox, for I'm afther seein' many av their thricks.

"There was wanst a man at Nenagh in Tipperary who was that poor that about all he had was a bit av a cabin, 4 geese an' a new pair of shoes. Well, sorr, a maraudin' divil av a fox sthole 2 av thim geese. 'Twas a cruel sthroke for the poor ould man who cud betther have lost an arrum. The nixt night the ould man tied the 2 remainin' geese in the cabin, tuk a pitchfork, opened the door woide and hid behind ut forninst the wall, hopin' the thafe would come back.

"An' by the same token, the scut came, though 'twas near the dawnin'. When ut sthruck the open door, ut made wan pounce for the geese. The ould man jumped betwixt him an' the door an' lifted the fork to spit the rascal.

"Faith, you'd think 'twas all up wid the poor baste, but ut knew betther. Ut tuk wan look around and saw the new shoes in a corner. Now in Ireland a man's lucky

if he gets new shoes wanst in 10 years. Mebbe the fox knew ut, for he tuk wan av thim shoes an' tossed ut on the open fire. The ould man dropped the fork to thry an' save his brogan, an' the fox wint out the door, shakin' wid laughter.

"'Twas a fox av Doneraile that played as cute a thrick. Ut found a goose pen wid a crack in ut just big enough to win through. In the divil wint, intindin' to dhrag a goose out in a jiffy. But the geese were big an' fat, an' not wan cud he pull through the hole. 'Sure,' thinks he, 'I can ate as well here as at home,' an' wid that he puts away all the goose meat his jackut would hould.

"Whin he came to thry the crack himself, the divil a bit cud he get his full belly through. Just then he heard the farmer comin'. The cunnin' rascal laid himself on the floor, sthiffened his legs an' shut his eyes.

"'Glory be,' sez the farmer; 'yez have sthuffed yer dhirty carciss wid me geese till yez died. I'll just toss yez out till I've time to skin yez.'

"Wid that he picks up the desavin' scut an' flings him out; an' loses hide an' brush for his thrustfulness."

**WHEN ANSWERING ADS ALWAYS
MENTION RECREATION.**

R. O. C.

The Rochester Dry Plate

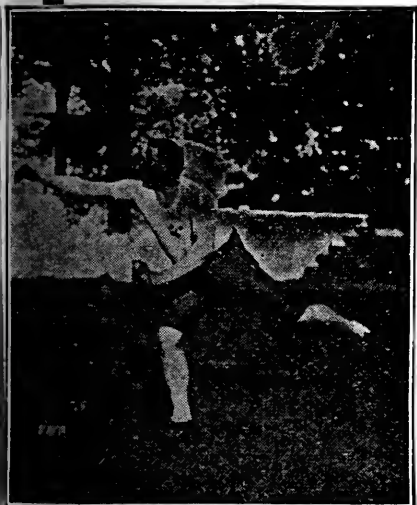

The speed of R. O. C. The Rochester Dry Plate is limited only by the speed of your lens.

It entirely upsets the old tradition that for good definition you must use a slow plate.

R. O. C. The Rochester Dry Plate, gets all there is to get, in the minimum of time.

Speed

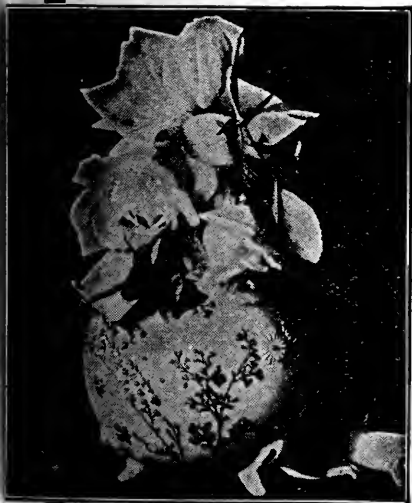

Combined with the speed of R. O. C. The Rochester Dry Plate, is an orthochromatic quality, unusual in a plate for general purposes. Indoors or out, there is no danger of meeting any condition of color or light for which R. O. C. The Rochester Dry Plate is not adapted.

Color

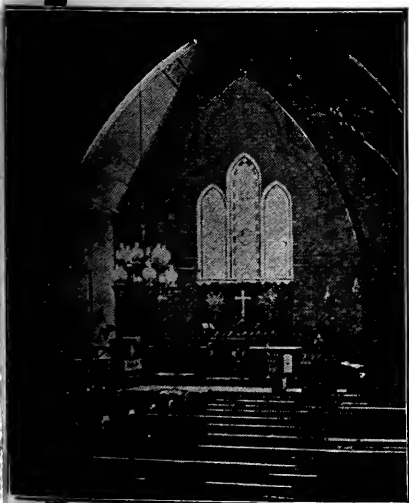

Halation is another problem reduced to the minimum by R. O. C. The Rochester Dry Plate. Here again is an advantage of having a plate of general utility. R. O. C. The Rochester Dry Plate, very closely approaches universal perfection. We have a free book that tells you about it.

Light



All in one picture, by the

take half-length views, or, with some models, stop the lens at five different places and thus make five different widths of pictures. This you can do in accordance with the view that you wish. No other camera possesses these advantages.

How often you find yourself on some high place with a view just in front of you, a part of which is not especially interesting, but the whole sweep of which view would make a delightful picture. You long for a camera that will record that whole view.

This is what the Al Vista will do!

We will send free on application our beautifully illustrated catalogue.

Multiscope & Film Co.

136 Jefferson St., Burlington, Wis.



Al-Vista Camera. or you can

Our cameras are the most simply constructed of any in the world, and the easiest to manage when they are understood. We send with each outfit a complete book of instructions. We will be glad to send copy of this free to anyone who will apply for it.

Our Co-operative Plan

We are sending out now a large number of cameras on this Co-operative Plan. A small first payment being made, we ship you the camera, and you can use it while you pay the remainder in monthly installments. This plan appeals to a great many people and certainly shows our confidence in the quality of our goods. Write us for full information about it.

Multiscope & Film Co.

136 Jefferson St., Burlington, Wis.

Are You an
Amateur
Photographer?



If so would you like a Camera
that will photograph

A whole range of mountains
A whole sweep of river
A whole army
A whole fleet of ships
A whole city

Or any other vast stretch of scenery or moving
objects? THE SWING LENS DOES IT

The Al Vista

Is the thing. It lists at \$30.

One of the greatest inventions of the age.
Given as a premium for 12 subscriptions.

For particulars Address

RECREATION

23 West 24th Street

NEW YORK CITY



Taken with a TURNER-REICH in $\frac{1}{1000}$ of a second.

1903 Koronas

will combine in ingenuity of design, completeness of equipment, and perfection of workmanship and materials, the heritage of nineteen years' optical and mechanical experience.

Send for our new Catalogue—just from the press—read about KORONA CONSTRUCTION, and be convinced that the claim which we make for the superiority of KORONAS is justified by facts.

Your Choice
of Two
Anastigmats

The **TURNER-REICH**

and

VERASTIGMAT
(*True Stigmat.*)

That new Catalogue tells what an Anastigmat ought to be, and contains many illustrations which prove that the TURNER-REICH and the VERASTIGMAT are all that we claim.

Gundlach-Manhattan Optical Co.

730 South Clinton Ave.,
ROCHESTER, N. Y.



THE KODAK WAY

is the simple, easy way in picture taking.
No dark-room, few chemicals. You "do the
rest" with a Kodak Developing Machine.

THE KODAK CORRESPONDENCE SCHOOL

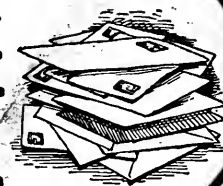

helps the amateur to the
making of technically perfect
and artistic photographs. Ex-
plains all the little difficulties
—there are no big ones. Tuition
free to all owners of Kodak and
Brownie Cameras upon payment
of one dollar for text books.

Kodaks,	- . . .	\$5.00 to \$75.00
Brownie Cameras,	-	\$1.00 and \$2.00
Kodak Developing Machines,		\$2.00 to \$10.00

EASTMAN KODAK CO.,

*Circular giving
details, at your
dealers, or by mail.*



Rochester,
N. Y.

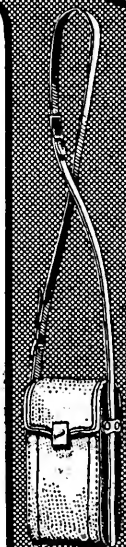
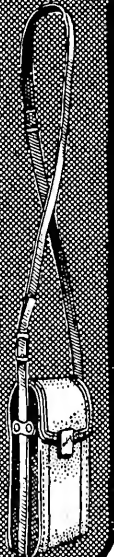

Your Best Pictures

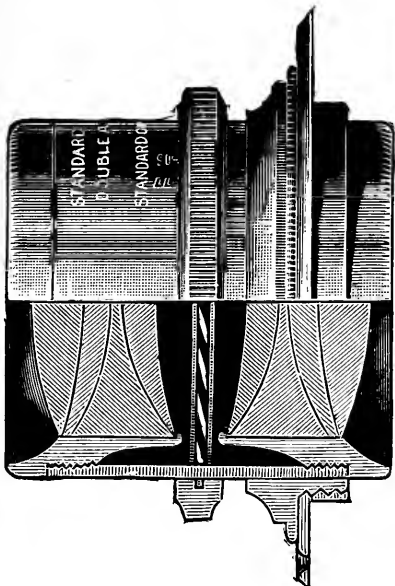

WILL
BE MADE
WITH

A Standard Double Anastigmat F-6.8

No. 1.	-	4 x 5	-	\$25.00
No. 2.	-	5 x 7	-	32.00

Other sizes to 11 x 14 in proportion.
Compare these prices with others.

We guarantee satisfaction with every lens and

INVITE COMPARISONS

Lenses sent on ten days' trial to responsible parties with privilege of return if not satisfactory.

A postal will bring you full information and list of all our goods. Write now.

STANDARD OPTICAL COMPANY,
327 Mulberry St., Newark, N. J.

Do You Want a Drinking Cup Free?

Send me \$1 for a new subscription to RECREATION and I will send you either a fine nickelplated folding drinking cup or a collapsible rubber cup. For 10 cents extra will send by registered mail. Thomas H. Walker, 295 Merrimac Street, Manchester, N. H.

OIL PORTRAITS ON APPROVAL.

If you will send me a photo of yourself or a friend and state color of hair, eyes and complexion I will paint and send you on approval a miniature oil portrait.

Canvas 6x8 or 8x10 inches, \$8.
Canvas 10x12 or 12x14 inches, \$12.

Z. EMMONS, 58 West 104th St., New York.

Reference: Mr. G. O. Shields.

LANTERN SLIDES COLORED IN AN ARTISTIC MANNER

Special attention given to the wants of Amateur Photographers. Correspondence promptly attended to. I refer by permission to the Editor of RECREATION.

MRS. BUTTLES SMITH,
606 W. 115th Street, New York City.

NEGA-TONE.

(Trade-mark)

Tone your Negatives. Bring out all Detail.
Bring out the depth. Bring out the Distance.
Have Natural Pictures. Stop losing Negatives.

TONE THEM. TONE THEM.

Trial Package by mail 25c.

A. B. LEGNARD (Sole Manufacturer),
Waukegan, Ill.

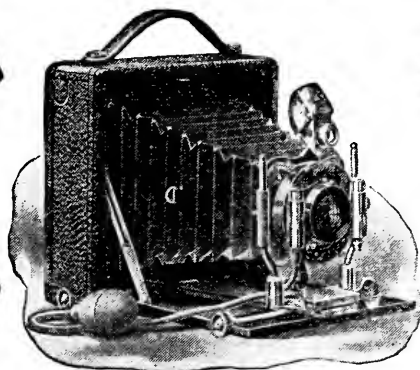

The Latest Star

In the camera world is the Star Premo. A new daylight loading Camera using either plates or films. An instrument making pictures $3\frac{1}{4} \times 4\frac{1}{4}$ inches, with every important adjustment and modern improvement known in camera making. The

STAR Premo

embodies in small size every requisite to the highest achievements in photography, including the perfect Auto Shutter and Planatograph Lens. The price of the Star Premo complete is \$25. It represents but one of many famous Premo Cameras, ranging in price from \$2.50 to \$250.00, shown in the new Premo book. Ask for it at dealers, or it will be mailed *free* on request.

Department F.
ROCHESTER OPTICAL CO.
Rochester, N. Y.



**Royals
Give
Results**

IN NAME—**ROYAL**—IN QUALITY
ARE

Royal Anastigmat Lenses

For success in Winter Photography, and especially for Indoor-Portraiture, a fast lens is a necessity, and in the **ROYAL** we offer one which will give results.

If you use a **ROYAL** you don't have to wait for the sunny days but can secure your subjects without the disappointing wait which is required when an ordinary lens is to be used. If you are not acquainted with the merits of these lenses, write and let us tell you some of the qualities, which we claim will interest you. New Catalogue now ready.

ROCHESTER LENS CO.
ROCHESTER, N. Y.

Something New!

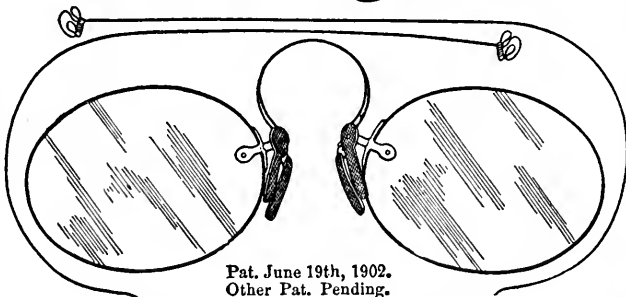

Pat. June 19th, 1902.
Other Pat. Pending.

PRESTO! CHANGE! Attachable Eyeglass Temples

Every wearer of eyeglasses wishes occasionally that they were spectacles. Spectacles stay on, however violent one's exercise, however warm or stormy the weather. This little device can be readily attached or detached without injury to the lenses, thus in a second giving you the choice of either spectacle or eyeglass: Just the thing for outdoor sports. The Temple Attachment will fit any of your eyeglasses and can be carried in the same case with them.

Send thickness of lens when ordering by mail.

Price in Nickel, 50 cents a pair
Price in Gilt, 75 cents a pair.

Send for Circular.

Our illustrated catalogue can be had for the asking

We carry everything in the Optical and Photographic line Eyeglasses, Spectacles, Cameras, Opera, Field or Marine Glasses, Thermometers, Barometers, Telescopes, Hygrometers, Sun-dials, etc.

GALL & LEMBKE, Department C.

1 W. 42d Street 21 Union Sq., New York
Established 1842.

To Amateur Photographers

Here is a Chance to Get a
FINE CAMERA EASILY

A 4x5 Tourist Hawk-eye film camera listing at \$8, for 5 yearly subscriptions to RECREATION. A No. 3 folding Weno Hawk-eye film camera, listed at \$15, for 10 yearly subscriptions to RECREATION.

These are both neat, compact, well made and handsomely finished cameras, capable of doing high-class work. Only a limited number can be supplied on this offer, and same may be withdrawn at any time without notice when the present stock is exhausted.

Sample copies for use in canvassing furnished on application.

Address **RECREATION,**
23 West 24th St., New York City



Yes—they
are ready
and better than
ever—1903

“Century” Cameras

Your dealer can show you the latest models and tell you all about them. Our new catalogue tells why “Centurys” are the best cameras made. Get a copy from your dealer — and don't overlook the Century guarantee. That tells the story in a nut shell.

CENTURY CAMERA CO.
ROCHESTER, N. Y.

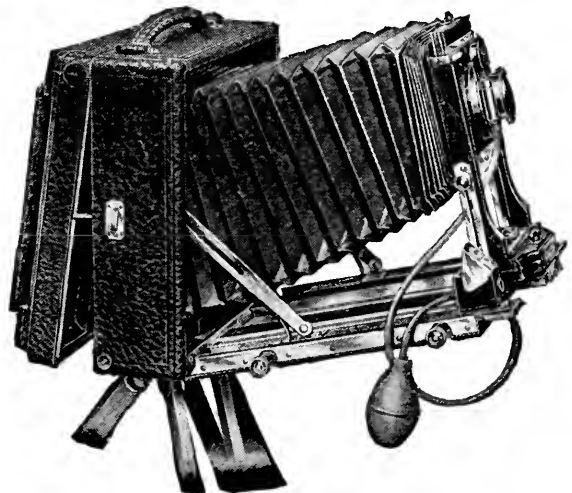

The 1903 Century Grand Sr., showing Double Swing Back and Swing Bed in use.

BIRDS OF THE GILA COUNTRY.

ALBERTA A. FIELD.

The game birds and animals of Arizona are fast learning to regard man with fear. Her song birds, however, have not yet been taught that lesson of civilization, and I know of no corner of the United States in which bird nature may be more closely and easily studied than in the wooded country between the Salt and Gila rivers and among the foothills of the Pinal and Mogollon mountains.

A peculiarity of Western birds is the faded or bleached appearance of their plumage as compared with that of representatives of the same species East of the Mississippi. This is true alike of robins, thrushes, mocking-birds, sparrows, wrens, jays, and many kinds of humming-birds. It finds its only exception in the cardinal grosbeak and some of the green hummers. The fiery plumage of the grosbeak seems even more brilliant than that of its Ohio brethren. I have never heard this peculiarity attributed to any special cause. It may be due to the alkaline properties of the air and soil, but why some of the emerald hummers and the grosbeak should be favored exceptions puzzles me.

The principal enemies of Arizona birds, particularly of the ground-nesting species, are snakes, with which the country is more than plentifully supplied. However, Nature, with an eye to the protection of her best loved children, has provided almost every shrub, bush, cactus or thicket growth with an abundance of sharp thorns, which catch the intruder at every turn. One of the most aggressive of these shrubs, but particularly fitted for nest hidings, is the cat-claw, which is of low growth, bristling with instruments of torture. The credulous are told that this little plant is able to reach out its claws and grasp intruders. That it can, with its hooked thorns, hold securely whatever comes in contact with it is a fact. Occasionally a bird attempts to build in a grape cactus, but this plant is so dangerous and difficult of access, being a mass of pricklers, that the attempt is usually abandoned. Notwithstanding cat-claws and cacti, now and then some snake undulates his way to a nest, carrying desolation to a mother heart.

A favorite resort for the larger and higher building birds is the great Sahara, or organ, cactus, which sometimes grows to the height of 40 or 50 feet, and is as a rock on which to build, proving effective protection from man and beast. In this cactus the American raven, *Corvus corax principalis*, abundant in the valleys of the Pinal range, frequently nests. I never saw more intelligence and common sense among birds than are displayed by these ravens, which seem pleased with offal-producing civilization, and gratefully accept their official position of public scavengers. They are a happy, gregarious lot, but given to stealing, and it is well to keep all bright

and portable articles under cover wherever they have access.

All Arizona birds love company and are never seen alone. In a mile of hillside can be counted, by thousands, woodpeckers, nuthatches, blue jays, indigo buntings, blackbirds, whippoorwills, thrushes, brown thrashers, finches, cross-bills, mocking-birds, grosbeaks, swallows, flycatchers, larks, sparrows, warblers, cat-birds and vireos. Of game birds it is almost distressing to speak, recalling as it does, the awful slaughter that is going on among them. The Arizona quail, which becomes the "California partridge" as one travels Westward, is most abundant. It is a beautiful and intelligent bird, but seems to have more than the ordinary wildness of its species, can not be domesticated, and has the grouse propensity for making itself unseen. One often comes upon a hen and 15 or 16 little ones, never dreaming of their presence until too close proximity sends them whirring through the air; but they soon alight and run to cover.

There are many wild turkeys in the Mogollon range, but they are shy of man. Perhaps this shyness is more traditional than instinctive. Many generations must have passed when man was unknown to them in this lonely mountain range, whose passes, if there are any, are unknown to even the Apaches.

One of the most unpleasant species of bird life in the territory, is the great, ugly, purple and red necked vulture, which may be useful but is certainly not ornamental. He lives almost entirely on carrion. I often saw a row of these silent, ominous looking creatures, sitting on a rock in the distance, waiting for the last breath to leave the body of some unfortunate animal. Often we came across the bones of a horse, and occasionally a human skeleton, bleaching on the hillside, and we shuddered as we thought of the claws and beaks that prepared them for this neglected sleep.

The shyness that I have mentioned as being so characteristic of game birds, is replaced in their unhunted fellows by an overpowering propensity of investigation, and a more curious and impertinent lot of feathered folk it would be hard to find. Since artesian wells have made irrigation possible in the little towns, the growing of fruits such as peaches, cherries, etc., has been undertaken; but it has been almost impossible for one to get a taste of one's own fruit, so mischievous have become mocking-birds, orioles and others. The trees have to be enveloped in mosquito netting, tent fashion; a rather expensive and difficult method of protection. This pilfering habit is going to work sad results among the gentle song birds, for already war is being waged on them in the towns, one man recently shooting 120 orioles in 2 hours, a wholesale slaughter that will soon depopulate the Western country as it has done the East.



OUT OF SORTS

Ever analyze "out of sorts" or "the blues"? Try it just for fun, and 10 cases out of 10 you'll trace all the trouble to the stomach.

Can't do much work on a blue stomach. Wireless telegraphy nor air-ships nor any of the great fortunes of the world were built up on a sour, abused stomach. Sick stomach is an unnatural condition, always due to improper feeding.

If your stomach is out of sorts and you are trying to right it with medicine you are on the wrong track.

There is a positive and sure way to permanently remedy ills of the stomach, and that is to leave off the improper foods and take on the proper food. In **Grape-Nuts** the entire health-giving grains are treated to a predigesting process that makes the food so dainty the weakest stomach in the world will accept it immediately. Out of hundreds of thousands of sick people who have tried **Grape-Nuts** (many of whom could not retain any other food whatever), there has never been one case where the stomach did not immediately relish and digest **Grape-Nuts**.

This process has been accomplished in **Grape-Nuts** without taking away any of the health and brain rebuilding elements of the grains. Nature's best food is all there in **Grape-Nuts** in delicious, fully cooked form. Served in a variety of ways (see recipe book in package).

There are many cases on the medical records where **Grape-Nuts** alone has sustained life for weeks and months at a time. This proves that **Grape-Nuts** is a complete food in practice as well as in theory. This is worth thought if health is anything to you.

You can be happy again when well, and there is a sure road.



Nothing
cheap about
Bicycle
Playing Cards
except the
price.

They wear well. 29 backs, including new Automobile designs. Back shown is "Pedal" design. Order by name. Sold by dealers.

The U. S. Playing Card Co.
Cincinnati, U. S. A.

We will send 128-page Condensed Hoyle for 10 cents in stamps, if addressed to Dept 23

FREE HAIR FOOD

FALLING HAIR AND BALDNESS ABSOLUTELY CURED

There is but one way to tell the reason of baldness and falling hair, and that is by a microscopic examination of the hair itself. The particular disease with which your scalp is afflicted must be known before it can be intelligently treated. The use of dandruff cures and hair tonics, without knowing the specific cause of your disease, is like taking medicine without knowing what you are trying to cure. Send three fullen hairs from your combings, to Prof. J. H. Austin, the celebrated Bacteriologist, who will send you absolutely free a diagnosis of your case, a booklet on care of the hair and scalp, and a sample box of the remedy which he will prepare specially for you. Enclose 2c postage and write to-day.

PROF. J. H. AUSTIN
633 McVicker's Bldg., Chicago, Ill.

FREE BOOK, WEAK MEN



My Illustrated nature book on losses varicocele, impotency, lame back, free sealed, by mail. Much valuable advice and describes the new DR. SANDEN HERCULEX ELECTRIC BELT. Worn nights. No drugs. Currents soothing. Used by women also for rheumatic pains, etc. 5,000 cures 1901 Established 30 years. Advice free.

DR. G. B. SANDEN,
1155 Broadway, N. Y.

Free Rupture Cure

If ruptured write to Dr. W. S. Rice, 1546 Main St., Adams, N. Y., and he will send free a trial of his wonderful method. Whether skeptical or not get this free method and try the remarkable invention that cures without pain, danger, operation or detention from work. Write to-day. Don't wait.

FREE FACE BLEACH FOR COMPLEXION

I will send FREE trial bottle of my Face Bleach to any lady sending name and address.

Mme. A. RUPPERT, 6 E. 14th St., New York City

A Hunting Knife Free. To any person sending me three yearly subscriptions to RECREATION and \$3, I will send a pocket hunting knife with handle 5½ inches long and blade 5 inches long. Fine steel, excellent workmanship. Your name and address and your L.A.S. number if desired inserted on a plate in the handle.

Geo. W. Mains, McKeesport, Pa,
I refer by permission to the editor of RECREATION.

A TOUGH SILVERTIP.

A friend and I took a trip last fall to Little Black Thunder basin, where deer, antelope, bear and small game are plentiful. We camped for the first night on Mule creek, and after a hasty meal, went to a small patch of timber near to try to get a grouse for breakfast. We jumped 4 mountain grouse and got them all with a 22 Stevens rifle. We had our 30's with us, that we might be ready for larger game if the chance came. While sitting talking at a spring 2 black tailed bucks came within range. I took steady aim and fired, thinking I could kill both of them with one shot, but I never touched either. Then my partner's gun spoke and one fell dead. On investigation I found my sight was at the 400 yard notch. We dressed our game and, leaving it hanging in a small sapling to cool, returned to camp.

We were up at 4 o'clock in the morning, and Will went after the deer while I got breakfast. I saw him go into the grove, and a minute later there was a racket like the charge of a band of Indians. The shooting had hardly stopped when Will's saddle horse came out of the woods at a mile a minute gait, snorting at every jump. I knew something was wrong, and, heading off the horse, I started back on him to see what the matter was. I found my partner standing with one foot on the largest silver-tip bear I ever saw. The bear had eaten half of our deer, and to get even we took 84½ pounds of oil out of him. When we skinned him we counted 9 bullet holes in his pelt.

The next day we went on and arrived at our hunting ground about noon. That afternoon we saw an antelope about 700 yards away. Will wanted to try my new gun, so I got the field glasses to see where the bullet struck. The buck gave one mighty bound and fell dead. We stepped the distance and found it was just 803 paces. We stayed 4 days and got 3 antelope, 3 deer, a bear and some small game.

W. H. Henderson, Newcastle, Wyo.

The International DENTIFRICE

Insures beautiful teeth, sweet mouth, agreeable breath. Preserves while it beautifies. No powder or liquid to spill or waste in use. Convenient, Economical.

25 Cents. At all druggists.
C. H. STRONG & CO., Chicago, U.S.A.

FRANK'S
TOOTH SOAP

Some
watchmakers harp
on Railroad
Watches.
More
than twenty

Elgin Watches

have been sold for every mile of railway trackage in the world. Sold by every jeweler in the land; guaranteed by the world's greatest watch works.

ELGIN NATIONAL WATCH CO.

ELGIN, ILLINOIS.

MENNEN'S BORATED TALCUM

TOILET POWDER



A Positive Relief
For
**PRICKLY HEAT,
CHAFING, and
SUNBURN,** AND ALL AFFLICTIONS
OF THE SKIN.

"A little higher in price, perhaps, than worthless substitutes, but a reason for it." Removes all odor of perspiration. Delightful after Shaving. Sold everywhere, or mailed on receipt of 25c. Get Mennen's (the original). Sample Free.

GERHARD MENNEN CO., Newark, N. J.

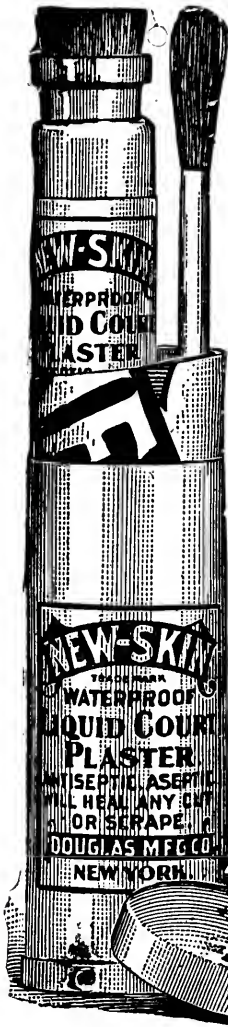

NEW-SKIN
 TRADE MARK
 REGISTERED
WATERPROOF
LIQUID COURT PLASTER

Heals Cuts, Abrasions, Hang-Nails, Chapped and Split Lips or Fingers, Burns, Blisters, etc. Instantly Relieves Chilblains, Frosted Ears, Stings of Insects, Chafed or Blistered Feet, Callosities Spots, etc., etc.

A coating on the sensitive parts will protect the feet from being chafed or blistered by new or heavy shoes.

Applied with a brush and immediately dries, forming a tough, transparent, colorless waterproof coating.

Mechanics, Sportsmen, Bicyclists, Golfers' Etc.

are all liable to bruise, scratch or scrape their skin. "NEW SKIN" will heal these injuries. WILL NOT WASH OFF, and after it is applied the injury is forgotten, as "NEW SKIN" makes a temporary new skin until the broken skin is healed under it.

Pocket Size (Size of Illustration) - - 10c.
 Family Size - - - - - 25c.
 2 oz. Botts. (for Surgeons and Hospitals) 50c.

At the Druggists, or we will mail a package anywhere in the United States on receipt of price.

DOUGLAS MFG. CO.
 Dept. W
 107 Fulton St. New York

Cap'n Titus

By CLAY EMERY

Boston Globe

"Rich and racy salt-briny stories, depicting New England country folk to the life."

Washington, D. C., Evening Star

"Mr. Emery has artistically caught the spirit of the folk-life of New England."

Rochester Democrat and Chronicle

"Uproariously entertaining."

New York Times

"He is another David Harum in storytelling and trading."

Price, 75 cents

Postage Paid

DOUBLEDAY, PAGE & COMPANY
 PUBLISHERS

34 Union Square

New York

Sent on Approval TO RESPONSIBLE PEOPLE Laughlin Fountain Pen

Guaranteed Finest
 Grade 14k.
SOLID GOLD PEN.

To test the merits of
RECREATION

as an advertising medium we make this grand special offer, your choice of

These
 Two Popular Styles
 For Only **\$1.00**
 Postpaid to any Address

(By Registered mail 8 cents extra)

Holder is made of finest quality hard rubber, in four simple parts, fitted with very highest grade, large size 14k, gold pen, any flexibility desired—in feeding device perfect.

Either Style—**RICHLY GOLD MOUNTED** for presentation purposes, \$1.00 extra.

Grand Special Offer

You may try the pen a week; if you do not find it as represented, fully as fine a value as you can secure for three times the price in any other makes, if not satisfactory in every respect, return it and we will promptly refund your money.

Illustration on left is full size of Ladies' style; on right, Gentlemen's style. Lay this **RECREATION Down and Write NOW.**

Safety Pocket Pen Holder sent free of charge with each Pen.



ADDRESS ;

Laughlin Mfg. Co.

424 Griswold St., DETROIT, MICH.

FREE Irish Linen Shirtwaist Sets, Bishop Collars, Tab Collars, Turnover Tab Collars, Cuffs, Tie-ends and Shirtwaist Front

ALL EXCLUSIVE 1903 NEW DESIGNS. We will send you **Absolutely Free** 2 complete Shirtwaist Sets, illustrated on both sides of this advertisement. The Shirtwaist Set on the right consists of **1 new linen turnover Collar with Cuffs and Tie-ends to match.** The one on the left consists of **1 new linen turnover Collar with Cuffs and Front to match.** We will also send you the 3 collars illustrated below. They are: **1 new bishop Collar, 1 new tab Collar and 1 new turnover tab Collar.** We will send you **Absolutely Free** the entire 12 pieces if you will send us only **THIRTY CENTS** for a three months' trial subscription to our most wonderful magazine, **THE MAGAZINE OF MYSTERIES.** Truly this is a marvelous offer, as the subscription price of our magazine alone is one dollar per year. Send to-day. Address **The Magazine of Mysteries, 22 North William St., New York City.**

"The MAGAZINE OF MYSTERIES fully lives up to its name. There is not a dull thing between its covers."—Oakland (Cal.) Tribune.

I am only a winter resident in Florida, but I have distributed the L. A. S. circulars sent me among my sportsmen acquaintances here. Though not a sportsman, I am much interested in good game laws and their enforcement, as well as in the protection of song, plumage and insectivorous birds. I notice a strong and growing sentiment here in favor of the saving of the few remaining song, plumage and water birds. Most of the bird shooting in this State is done by tourists of the just-to-see-if-I-can-hit-'em class, and I am glad to say they are not numerous in this place.

G. W. Chamberlain, Daytona, Fla.

IF YOU WOULD LIVE NEXT TO NATURE, READ RECREATION.

OIL--SMELTER--MINES! DOUGLAS, LACEY & CO.

(Members New York Consolidated Stock Exchange),
Bankers, Brokers, Fiscal Agents,
66 BROADWAY & 17 NEW ST., NEW YORK.
Suites 177 to 186, inclusive, Manhattan Life Bldg.
Dividend-Paying Mining, Oil and Smelter Stocks, Listed and Unlisted, our Specialty.

BOOKLETS giving our successful plan for realizing the large profits of legitimate Mining, Oil and Smelter Investments, subscription blanks, full particulars, etc., sent free to any interested on application.

BRANCHES:

Boston,	Washington,	Concord, N. H.	Minneapolis,
Philadelphia,	Pittsburg,	Newport, R. I.	Los Angeles, Cal.
Chicago,	Buffalo,	Newark, N. J.	Prescott, Ariz.
Cleveland,	Toronto, Can.	Brooklyn, N. Y.	Tucson, "
Cincinnati,	Montreal,	Detroit, Mich.	Mexico City,
St. Louis,	Hartford, Conn.	Grand Rapids,	Halifax, N. S.
Baltimore,	Worcester, Mass.	Davenport, Ia.	St. Johns, N. B.



Music Boxes

For the Home, it is company at all times, will cheer you when you are sad; a veritable need when you are lonely; an accompaniment to your song, and play **Dance** music in **perfect time.** A boon to all music lovers. Our variety is great; prices to suit all. Our No. 20 costs only \$2.50, while our No. 191 runs in the hundreds. Complete Catalogues **FREE.**

E. L. CUENDET, 7 Barclay St., New York

HYPNOTISM

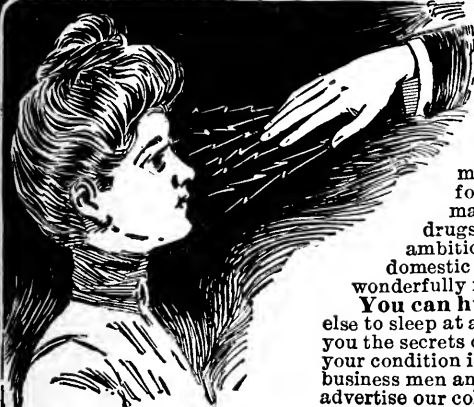

Would you possess that strange mysterious power which charms and fascinates men and women, influence their thoughts, controls their desires and makes you supreme master of every situation? Life is full of alluring possibilities for those who master the secrets of hypnotic influence; for those who develop their magnetic powers. You can learn at home, cure diseases and bad habits without drugs, win the friendship and love of others, **increase your income,** gratify your ambitions, drive worry and trouble from your mind, improve your memory, overcome domestic difficulties, give the most thrilling entertainment ever witnessed and develop a wonderfully magnetic will power that will enable you to overcome all obstacles to your success. **You can hypnotize people instantaneously,**—quick as a flash,—put yourself or anyone else to sleep at any hour of the day or night—banish pain and suffering. **Our free book** tells you the secrets of this wonderful science. It explains exactly how you can use this power to better your condition in life. It is enthusiastically endorsed by ministers of the gospel, lawyers, doctors, business men and society women. It benefits everybody. It costs nothing. We give it away to advise our college. Write for it to-day.

American College of Sciences, Dept. C N 7. 420 Walnut Street, Philadelphia, Penn.

How to Paint Your House Cheap

And Have it Guaranteed to Look Better, Wear Longer,
and Cost Less than the Best White Lead Paints.

**Never Fades, Cracks, Chalks,
Peels or Blisters and is Not
Affected by Gases.**

The cost of painting the house and barn, outbuildings and fences is a heavy burden. Cheap paints soon fade, peel or scrape off and white lead and oil costs so much and has to be replaced so often that it is a constant expense to keep the bright, clean appearance so desirable in the cozy cottage home or the elegant mansion. The following are a few of the large users of Carrara Paint:

Pennsylvania R. R. Co.; Pullman Palace Car Co.; Chicago Telephone Co.; Central Union Telephone Co.; Field Museum, Chicago; Kenwood Club, Chicago; Cincinnati Southern; C. & E. I. R. R. Co.; Denver & Rio Grande R. R.; Wellington Hotel, Chicago.

Carrara is used because it lasts longer, never fades, never cracks,



The Waldorf-Astoria, New York, one of the Most Magnificent Hotels in the World, Has Used Tons and Tons of the World Famous Carrara Paint.

Fifty Sample Colors and Illustrated Booklet Prepaid to Any Address Absolutely Free.

never blisters, never peels, covers more surface than the highest priced paints and costs less than the cheap mixed paints that injure instead of protect. There is but one Carrara. It is made by the Carrara Paint Agency, General Offices, 675 Carrara Bldg., Cincinnati, Ohio, and anyone having a house to paint should send for 50 free sample colors and our handsome booklet, showing many buildings reproduced in all the colors just as they are painted from this great paint that has stood the most rigid tests for 25 years, and, bear in mind, that it is the only paint ever manufactured that is backed by a positive guarantee in every case. Distributing depots in all principal cities. Write to-day and save half your paint bills in the future.

PAROID ROOFING

"IT LASTS"

Before you build your camp, barns, sheds, get a sample and the story of **Paroid Roofing**—the permanent ready roofing—each roll a complete roofing kit.

F. W. BIRD & SON

Mills and Main Office

East Walpole, Mass., U.S.A.

New York Chicago

For Sale:—S. S. Winchester, 32-40 cal. set triggers, 14 lbs. weight, 30 in. round bbl., extra finished stock. Nearly new and absolutely perfect outside and in. A very fine target gun. Price, \$15. Also 38-55 Marlin, octagon, Lyman 1-18 sights with loading tool. Express and solid moulds and 50 ctgs. Price, \$14.50. Also 30-30 Win. octagon, Lyman 1-3-6 sight, with mould and loading tool. \$18. All these guns are equal to new in condition. G. L. Dwinell, Marshfield, Vt.

Bargains: Thoroughly broken pointer, 2 years, in staunch and a tender retriever, \$15. Setter puppies eligible, (by Joe Skimpole 2049) \$5 each. Broken pointer for rifle with telescope sights. References. Piedmont Kennels, Worlds, Va.

For Exchange: Set of best, practically new golf clubs in bag. for pair of light, medium sized, field glasses. Will give difference in value if necessary. Wm. G. Serrine, Greenville, South Carolina.

For Sale or Exchange: 7 month old bird pup, with liver spots, and one 16 gauge 6-shot latest improved Winchester. Best cash offer or will exchange for 12-gauge double gun. Box 330, Wenona, Ill.

Wanted: 12-gauge repeating or hammerless shotgun in exchange for 10-gauge empty and loaded shells or hunting lanterns, etc. A. P. Weidner, Buffalo Grove, Ill.

Where Gold Is Thick

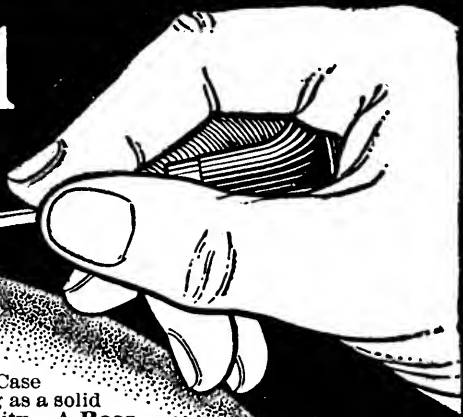

The gold is so thick on a Jas. Boss Stiffened Gold Watch Case that it takes the same depth of engraving as a solid gold case, without impairing its wearing quality. A Boss Case never wears thin.

JAS. BOSS Stiffened GOLD Watch Cases

are guaranteed for 25 years. For 50 years they have been recognized as the most serviceable of all cases. Don't accept any case said to be "just as good as the Boss." Write us for booklet.

By This Mark  You Know Them

THE KEYSTONE WATCH CASE COMPANY, Philadelphia.

AFIELD WITH A GOOD PUPPY.

For a week I had been coaxing father to hunt grouse with me. One damp, cloudy morning we set out at 4.30, taking with us my Rodfield puppy, Rub. After a drive of 14 miles we reached the house of a friend, where we put up our horse. For some time we hunted without seeing a thing. Then the governor made a clean miss, but marked down his bird.

That encouraged Rub. He presently made a stand and out came a cock grouse, to be stopped by father's second barrel. Here the puppy made a mistake; the bird was only winged and he jumped in on it, but afterward retrieved it nicely.

Then we looked for the first bird. The puppy did not get a chance to point, for it flushed wild. However, the governor was ready and promptly stopped its flight. A little farther on Rub froze again. I took a step forward and put up a single quail, which I killed. Then the covey rose and scattered. Father stopped 2 birds, and I one. Rub brought them in fine style. In doing so he jumped a rabbit, and we gathered bunny in.

At the edge of a wood I missed 2 single grouse. We followed. At a fallen tree top Rub refused to go farther. When we kicked the bush, out went the birds in safety. A little later 2 more dodged our shot. Then I got a single bird. On a small knoll covered with grape vines, we kicked up a pair of grouse. I dropped mine and father missed. When the governor had added 2 rabbits to his score he said he had all the game an old man could carry. Our total was 5 grouse, 3 rabbits and 4 quails. Rub is only 7 months old, yet I have shot 13 grouse and 21 quails over him.

W. H. G., Greensburg, Pa.

PURE MAPLE SUGAR 15 cts. a lb. in pails or bricks.
SYRUP \$1.25 a gal. in Gallon Cans.
 Freight prepaid on order for 100 lbs. or more, East of Rocky Mountains. We guarantee safe arrival and quality. Price list on large or small orders on application. Reference, Randolph National Bank.
VERMONT MAPLE SUGAR MAKERS' MARKET, RANDOLPH, VERMONT.



EVANS' VACUUM CAP

Will Make Hair Grow.

This appliance will massage the scalp and force a healthful circulation. It will stop the hair from falling out and restore a normal growth where live follicles exist. It is used about ten minutes each night before retiring. Price, \$35.00 which will be refunded in full if it does not give satisfaction within thirty days.

For full particulars address:
 EVANS' VACUUM CAP CO.,

Fullerton Building,

St. Louis



MIND-BRAIN

Mentality, in all its perfection and strength, is only possible when the brain as well as the other nerve-centers and vital organs is endowed with a vigorous circulation. Stagnation of blood, Varicocele, is responsible for more cases coming under the head of either weakened, obscured, or defective mentality, than all the other diseases that afflict and prematurely destroy mankind.

I have made an original and exhaustive study of mental diseases, nerve derangements and circulatory disturbances, and have limited my practice to the successful treatment of Varicocele and its associated or reflex diseases. I have found that the blood is practically the life of the mind as well as of the body.

I can not, in this short announcement, explain my theories—they have long since become demonstrated facts—but I will send to anyone afflicted with Varicocele my treatise on Special Diseases, which is both theoretical and practical. The sealed postage on this book is ten cents. If a description of symptoms is given I will write my professional opinion regarding the case, telling you whether it is necessary for you to come to my Home for treatment.

Men from all parts of the world are being treated at my sanitarium. I prefer giving personal attention to every patient, but if it is impossible for you to visit me at once, your letter will have my careful answer if addressed to



DELMER D. RICHARDSON, M. D.

Suite 104, 119 Michigan Avenue, Chicago.



H. J. TILLOTSON, M. D.
The Master Specialist of Chicago, who Cures Varicocele,
Hydrocele, and treats patients personally.
Established 1880.
(COPYRIGHTED)

manent. My consultation will cost you nothing, and my charges for a perfect cure will be reasonable and not more than you will be willing to pay for the benefits conferred.

Certainty of Cure is what you want. I give a legal guaranty to cure or refund your money. What I have done for others I can do for you. I can cure you at home

Correspondence Confidential. One personal visit at my office is preferred, but if it is impossible for you to call, write me your condition fully, and you will receive in plain envelope a scientific and honest opinion of your case, Free of charge. **My home treatment is successful.** My books and lectures mailed free upon application.

H. J. TILLOTSON, M. D., 140 Tillotson Bldg, 84 Dearborn St., CHICAGO

Varicocele Hydrocele

**Cured to Stay Cured in 5 Days.
No Cutting or Pain. Guaranteed
Cure or Money Refunded.**

VARICOCELE. Under my treatment this insidious disease rapidly disappears. Pain ceases almost instantly. The stagnant blood is driven from the dilated veins and all soreness and swelling subsides. Every indication of Varicocele vanishes and in its stead comes the pleasure of perfect health. Many ailments are reflex, originating from other diseases. For instance, innumerable blood and nervous diseases result from poisonous taints in the system. Varicocele and Hydrocele, if neglected will undermine physical strength, depress the mental faculties, derange the nervous system, and ultimately produce complicated results. In treating diseases of men I always cure the effect as well as the cause. I desire that every person afflicted with these or allied diseases write me so I can explain my method of cure, which is safe and per-

fect and permanent.

The Perfect Food

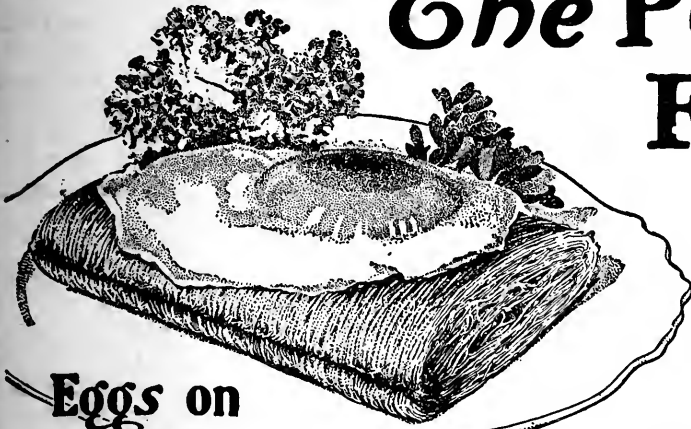
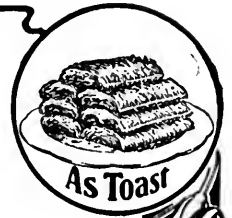

Eggs on SHREDDED WHOLE WHEAT BISCUIT

SOLD BY ALL GROCERS

Write today and we will send you FREE our cook book, illustrated in colors—"The Vital Question"—which gives over 250 recipes. Address

THE NATURAL FOOD CO.,
Niagara Falls, N. Y.

Shredded Whole Wheat Biscuit is thrice cooked and spun into fine shreds. Each shred contains many thousands of little pores which give great surface for the digestive fluids to act upon. It is crisp and compels thorough mastication which insures *perfect digestion.*

Poached or Scrambled Eggs on Shredded Wheat Biscuit

Moisten the Biscuit slightly with cold water. Place small bits of butter on top. Put in buttered pan in hot oven about three minutes. Remove with pancake turner to warm plate. Use as toast for scrambled or poached eggs.



The "Victor" is the real talking machine; its sound is natural. Band playing, monologues, comic or religious songs, all are reproduced as clear as if the artist was present. When ordering, get the latest styles—we charge no more than others who offer you old styles. Get our full catalogue FREE.

E. L. Cuendet, 7 Barclay St., New York.

Wanted: A 12-gauge Winchester lever action repeating shot gun. Mst be cheap for cash. George Burkhardt, 110 Baitz Ave., Buffalo, N. Y.

For Exchange: An L. C. Smith hammer gun in good condition for Kodak or Guitar. Ira I. Walker, R. P. C., South McAlester, Ind. Ter.

Magnetic Body Shields

(Not Electric.)

Physicians, as well as sufferers, mark the date when and the book where you first read this statement: *Magnetic vibration rightly applied to the blood capillaries will cure all disease not in the fatal stage of dissolution of tissues.*

DR. THACHER'S MAGNETIC SHIELDS

are the most perfect device for such application. We are spending thousands of dollars to say this. Will you not spend one cent for proof? Two books free that will astonish you. A book of testimonials, the most convincing ever gathered from grateful patrons, and Dr. Thacher's treatise, *Magnetic force, a Plain Road to Health.*

THACHER MAGNETIC SHIELD CO., Ltd., 118 State & Adams Sts., CHICAGO.

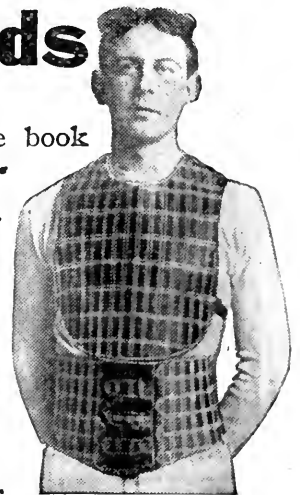
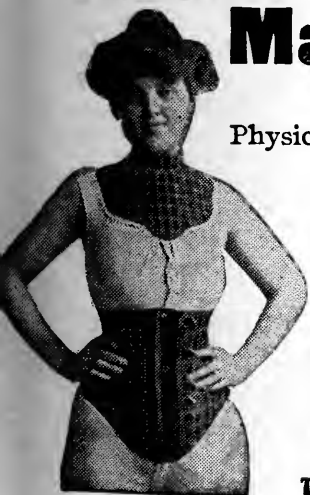

SOME RARE OPPORTUNITIES

These goods are all new, and will be shipped direct from factory. Prices named are those at which manufacturers and dealers usually sell. Here is a good chance to get

A Book, a Gun, a Camera
A Sleeping Bag, a Fishing Rod
A Reel, a Tent, } FREE OF COST

Subscriptions need not all be sent at once. They may be sent in installments as taken and credit will be given on account. When the required number is obtained the premium earned will be shipped.

These Offers are subject to change without notice.

TO ANY PERSON SENDING ME

TWO yearly subscriptions to RECREATION at \$1 each, I will send a copy of *Hunting in the Great West*, cloth; or a Zar Camera, listed at \$1; or an Ingersoll Watch or Cyclometer, listed at \$1; or a Recreation Waterproof Match Box, made by W. L. Marble and listed at \$1; or a Shakespeare Revolution Bait listed at 75 cents; or a Laughlin Fountain Pen; or a dozen Trout Flies, assorted, listed at \$1; or a pair of Attachable Eyeglass Temples, gold-plated, made by Gall & Lembke.

THREE subscriptions at \$1 each, a safety pocket ax, made by W. L. Marble and listed at \$2.50; or a dozen Bass Flies, assorted, listed at \$2; or 4 dozen Carbutt plates, 4x5 or 5x7; or a pair of chrome tanned horsehide hunting and driving gloves, listed at \$1.50, made by J. P. Luther Glove Co.

FOUR subscriptions at \$1 each, an Ideal Hunting Knife, made by W. L. Marble and listed at \$2.50; or a .32 caliber Automatic Forehand Revolver, made by the Hopkins & Allen Arms Co.; or a No. 822 Rifle made by the Hopkins & Allen Arms Co., listed at \$4.50.

FIVE subscriptions at \$1 each, a copy of *Cruisings in the Cascades*, cloth; or a set of Nehring's Convertible Ampliscopes, listed at \$5.00; or an Ideal Hunting Knife made by W. L. Marble, and listed at \$3; or a polished Buffalo Horn Gun Rack, made by E. W. Stiles; or a Forehand Gun, made by the Hopkins & Allen Arms Co., listed at \$6; or a pair of lock lever skates, made by Barney & Berry, listed at \$4.50; or a pair of gauntlets, for hunting and driving, ladies' size, listed at \$2.50, made by J. P. Luther Glove Co., or a J C Hand trap made by the Mitchell Mfg. Co., listed at \$4.

SIX subscriptions at \$1 each, a Hawkeye Refrigerating Basket made by the Burlington Basket Co., or one dozen Eureka golf balls listed at \$4; or a Century Camera, model 10, 4x5, listed at \$9; or a Forehand Gun made by the Hopkins & Allen Arms Co., listed at \$9.

SEVEN subscriptions at \$1 each, a copy of *The Big Game of North America*, or of *The American Book of the Dog*, cloth, or one set Lakewood golf clubs, 5 in number, listing at \$5; or a series 11B or 11D Korona Camera, made by the Gundlach Optical Co., listed at \$10.

EIGHT subscriptions at \$1 each, a 4 x 5 Weno Hawk-Eye Camera, made by the Blair Camera Co., and listed at \$8.

NINE subscriptions at \$1 each, an Acme single shot gun, made by the Davenport Arms Co., and listed at \$8.

TEN subscriptions at \$1 each, a Cut-Glass Salad Bowl, made by Higgins & Seiter, and listed at \$4.50; or a Yawman & Erbe Automatic Reel, listed at \$6 to \$9; or a Bristol Steel Fishing Rod, listed at \$6, or less; or a Waterproof Wall Tent 7x7, made by Abercrombie & Fitch, and listed at \$8; or a canvas hunting coat, made by H. J. Upthegrove & Son, listed at \$8; or a series 1, 4x5, Korona Camera, made by the Gundlach Optical Co., listed at \$12.

TWELVE subscriptions at \$1 each, a Peabody Carbine valued at \$12; or a No. 5 Side Telescope Rifle Sight, listed at \$18; or a Davenport Ejector Gun, listed at \$10; or a Century Camera, model 12, 4x5, listed at \$18.

FIFTEEN subscriptions at \$1 each, a Shakespeare Reel, Silver Plated, listed at \$15; or a set of rabbit plates made by Higgins & Seiter, and listed at \$8, or a pair of horsehide Hunting shoes, made by T. H. Guthrie, Newark, N. J., and listed at \$8, or a Field Glass made by Gall & Lembke; or a Kenwood Sleeping Bag, complete, with canvas cover, listed at \$16.

TWENTY subscriptions at \$1 each, a 14-karat Gold Hunting-case Watch, with Waltham Movement, listed at \$20; or a Repeating Rifle, listed at \$16 or less; or an Elita single shot gun, made by the Davenport Arms Co., and listed at \$18, or a pair of horsehide Hunting Boots, made by T. H. Guthrie, Newark, N. J., and listed at \$10; or an Acme Folding Canvas Boat, No. 1, Grade B, listed at \$20; or a Mullins Duck Boat, listed at \$20; or a Shattuck double hammerless shot gun listed at \$25.

TWENTY-FIVE subscriptions at \$1 each, an 11-foot King Folding Canvas Boat, listed at \$38; or a Repeating Rifle, listed at \$20 or less; or a 4x5 Planatic lens, made by the Rochester Lens Co., and listed at \$25; or a Century Grand Camera, 4x5, listed at \$35; or a Syracuse Grade OO, double hammerless Gun, made by the Syracuse Arms Co., and listed at \$30.

THIRTY subscriptions at \$1 each, a Repeating Rifle, listed at \$25 or less; or a Waterproof Tent, 14½ x 17, made by Abercrombie & Fitch, and listed at \$25; or a corduroy hunting suit, made by H. J. Upthegrove & Son, including coat, vest, trousers, and hat, listed at \$23.75; or an Ithaca, quality No. 1, plain, double barrel, hammerless breech loading shot gun, listed at \$40.

THIRTY-FIVE subscriptions at \$1 each, a 14-foot King Folding Canvas boat, listed at \$48.

FORTY subscriptions at \$1 each, a Savage .303 Repeating Rifle; or a No. 10 Gun Cabinet, made by the West End Furniture Co., and listed at \$32; or a Field Glass, made by C. P. Goerz.

FORTY-FIVE subscriptions at \$1 each, a Royal Anastigmat Lens, 4x5, series I, made by Rochester Lens Co., and listed at \$45.

FIFTY subscriptions at \$1 each, a No. 20 Gun Cabinet, made by the West End Furniture Co., and listed at \$38.

TWO HUNDRED subscriptions at \$1 each, a strictly first class upright piano, listed at \$750.

Address, **Recreation** 23 West 24th St. New York



THE BEST SCOTCH GAME
AND
THE BEST SCOTCH WHISKY

Every thoroughbred golfer unites the two by playing the last hole of the match for a wee nipie of

Dewar's Scotch

the Whisky which has been awarded 53 gold and prize medals, and is supplied by Royal Warrant to His Majesty King Edward VII.

A GOLF PRINT

entitled "The Last Hole for Dewar's" (copyright 1903 by Frederick Glassup), being an exact reproduction of the original design by James Preston, shown herewith, will be mailed to anyone on receipt of 10c in silver. It is printed in four colors on heavy Japan vellum 9x12 and is suitable for framing in club house or home. This is the first of a series of 12 original prints, suggesting Dewar's Scotch for all occasions. In May we will show a coaching scene by Edward Penfield. : : : For copies of this print

Address FREDERICK GLASSUP,
Sole U. S. Agent for John Dewar & Sons, Limited.
126 Bleecker Street, New York.

REMARKABLE OFFERS

To every person who will send RECREATION \$1 for 1 year's subscription to be placed to my credit I will give as a premium a choice of a Nickel Plated Match Safe, or a Gilt Metal Match Safe, or a Hard Rubber Water Proof Match Safe, each listed at 40 cents; or a Nickel Dog Whistle and pocket drinking cup, listed at 50 cents; or a Nail Clipper, with file and Nail Clipper attached, listed at 40 cents; or a 25 yard Single Action Reel, listed at 40 cents; or a 25 yard Water Proof Silk Line, listed at 50 cents.

For 2 subscriptions a Hunting Knife, Stag Handle, Blade 5½ inches long, listed at \$1.

For 3 subscriptions a Patent Double Minnow Bucket, listed at \$2; or a 60 yard Multiplying Reel, listed at \$2; or a 3-piece Bamboo Rod, 7 or 9 feet long, listed at \$2; or a Heavy Silk Watch Fob, listed at \$1.50.

For 5 subscriptions a fancy striped Hammock, listed at \$3; or a Hunting Knife, listed at \$3; or a Tackle Box, listed at \$3.

For 9 subscriptions a field glass listed at \$6.

Only a limited number of subscriptions can be accepted on these offers.

C. W. Jacobs, Coshocton, Ohio.

IF YOU WOULD LIVE NEXT TO NATURE, READ RECREATION.



Don't Be Too Fat

Don't ruin your stomach with a lot of useless drugs and patent medicines. Send to Prof. F. J. Kellogg, 278 Kellogg Bldg., Battle Creek, Michigan, for a free trial package of a treatment that will reduce your weight to normal without diet or drugs. The treatment is perfectly safe, natural and scientific. It takes off the big stomach, gives the heart freedom, enables the lungs to expand naturally, and you will feel a hundred times better the first day you try this wonderful home treatment.

"Pneumatics Free"

The Pneumatic Mattress & Cushion Co., who own every practical patented device for making Air Goods, is to be consolidated with a Rubber Factory and a Rubber Plantation. We shall raise our own Rubber (a yielding plantation having been secured); we shall make our own Rubber Cloth; and then we shall be in a position to control our own base of supply.

\$100,000 of the New Company's 7% Preferred Stock is offered in \$10 shares. In order to raise it quickly we make the following most

LIBERAL OFFER.

40% of the amount purchased will be placed to your credit, you to have the right to select Pneumatic Goods to that amount any time within four months. For example, if you buy \$100 worth of preferred stock, you shall be entitled to \$40 worth of *Pneumatics, FREE.*

These offers are limited to subscribers to the first 10,000 shares, and is an opportunity not to be overlooked. Address:

W. J. SHILLIDAY, Secy. **2 R. South Street,** **New York City.**

 The offer does not apply to dealers.

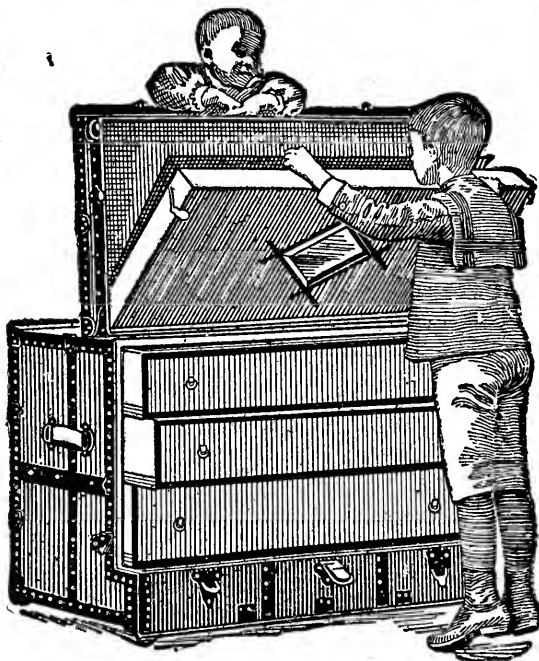

Stallman's Dresser Trunk Have you seen one? It is up-to-date. Think of it, everything within reach. No heavy trays, but light, smooth drawers. Holds as much and costs no more than a good box trunk. Hand riveted, almost indestructible. Once tried, always recommended. Sent C. O. D., privilege examination.

ac. stamp for catalogue. Mention RECREATION.
F. A. STALLMAN,
87 W. Spring St., Columbus, O.

Here is Another!

If you will send me

40 Yearly Subscriptions

to

RECREATION

I will send you

A No. 10 Goerz Trieder-Binocular Field Glass

Listed at \$38.00

Every well-informed man knows the great power of this modern prismatic field glass. It is indispensable to every hunter, and is one of the latest and best on the market.

I have but a few of these instruments on hand and the offer will be withdrawn as soon as the supply is exhausted. Therefore, if you want one

START IMMEDIATELY.

Sample copies of RECREATION for use in canvassing furnished on application.



Club Cocktails

Famous the world over for purity. They never vary. The secret of their perfect blend is that they are kept six months before being drawn off and bottled. Be sure you have them in your camp, on the yacht, and on your outing trips wherever you go. They are ready and require no mixing. Simply pour over cracked ice.

For Sale by all Fancy Grocers and Dealers

G. F. HEUBLEIN & BRO.
29 BROADWAY, N. Y. HARTFORD, CONN.

Some years ago in a city in Ontario a game protection society was organized and an attempt made to enforce the game laws of that Province. The society was carried on 6 or 7 years and did much good work before it died of inanition.

While it yet flourished one of its "watch dogs" heard whispers of an infraction of the game laws by a well known individual. It was a grand opportunity for the society to assert its principles and to make an example of an evil doer. Summons was issued and the case brought before the justice, the charge being that of shooting and having in possession a woodcock during the close season. The commission of the crime and its detection came in such rapid connection that the accused proposed to save time by producing the bird. To the discomfiture of the informer and the total collapse of the Court, the culprit, after carefully undoing a brown paper parcel, exhibited a wooden faucet, such as is used for drawing beer. He retired from court without a stain on his popularity and put up the cigars. C. O. D.

I am a regular reader of your magazine and would not be without it.
Ted. C. Kistenmacher, Avoca, Ia.

IF YOU WOULD LIVE NEXT TO
NATURE, READ RECREATION.

BROTHER CAMPER, YACHTMAN, EXCURSIONIST

Take the advice of "OLD SALTS" and experienced "WOODSMEN" and see that your Hamper or Larder is supplied with



PRUDENT HOUSEWIVES

agree that no seasoning for soups, gravies or salads can compare with
McILHENNY'S

Tabasco Sauce

is universally used for clams and oysters, destroying the dangerous typhoid germs said to be prevalent in these bivalves. It is far better than dry pepper, stimulating the stomach instead of irritating it, and helping digestion instead of hindering it.

McILHENNY'S *Tabasco Sauce* imparts a delightful flavor and gives a delicious relish to cold meats. Try at once and you will use no other.

AT ALL GROCERS

Free Booklet with receipts for new and unique uses of Tabasco sent on request.

McILHENNY'S TABASCO, New Iberia, La.

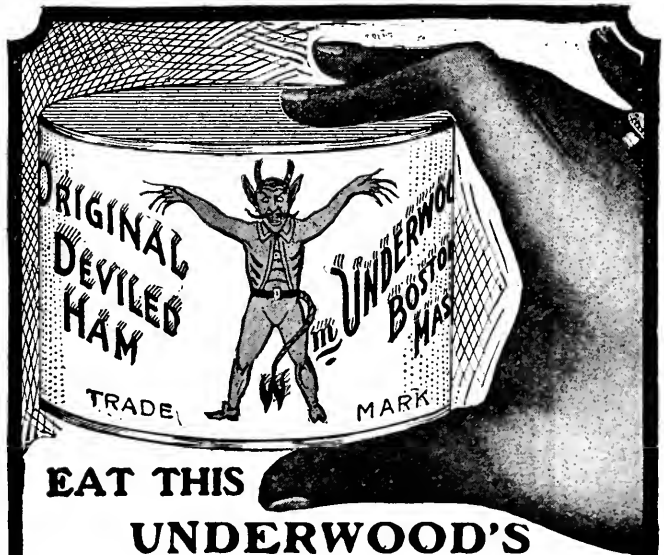

EAT THIS UNDERWOOD'S ORIGINAL DEVILED HAM

The pure and delicate Deviled Ham which has been on the market for years and years, and never found wanting. Sugar-cured ham and fine, pure spices is all that we use. It is delicious for sandwiches, at lunch, picnic, or tea, and in the chafing-dish. Our Book contains a lot of unique and practical receipts. We will send it FREE.

Underwood's Original Deviled Ham

may be bought at any good grocers, but be sure you see on the can THE LITTLE RED DEVIL.

Wm. Underwood Co., Boston, Mass., U.S.A.

THEY'RE MADE TO MEASURE

Putman Boots.

Go on like a glove *and* fit all over.

For a Quarter of a Century Putman Boots have been the Standard among Western Hunters, Prospectors, Ranchmen and Engineers (who demand the best) and we have learned through our personal contact with them **how** to make a perfect boot.

Putman Boots are in use in nearly every civilized country in the World. They are Genuine Hand Sewed, Water Proof, Made to measure, Delivery charges prepaid, and cost no more than others. Send for catalogue of over **30 Different Styles** of boots, and blank for self measurement. Also **Indian Tanned Moosehide Moccasins**.

Illustration shows No. 900, 14 inches high, Black or Brown Leather.

Made to measure and delivered in the U. S. Canada or Mex. for **\$7.50**

H. J. PUTMAN & CO.

36 Hennepin Ave.

MINNEAPOLIS, MINN.

SQUIRES' SIBERIAN MOOSE HUNTING BOOTS & SHOES

Made only by **HENRY C. SQUIRES & SON**
20 Cortlandt St., New York

The **leather** is waterproof, fine grained, tough and pliable. The **linings** are russet calfskin. The **soles** are best waterproof anhydrous oak leather, **stitching** of silk, English back stays, bulldog toes, extra heavy **eyelets**, **Pratt fasteners** and **hand made throughout**. Price **\$7.50** net. Short Boots **\$8.50**, Knee Boots **\$10**, Cavalry Style Boots **\$12**.

Special circular giving detailed information free for the asking.



Mention RECREATION.

The Celebrated

THOMPSON-QUIMBY

Hunting Boots, Shoes and Moccasins

I have on file measurements of all who bought Boots and Shoes of the W. Fred Quimby Co., of New York for the past 20 years, and I make the same grade of sportsmen's footwear as they made. I was superintendent of the shoe department of that firm and bought the right to make these boots and shoes. Get a pair now. They will last years and are the cheapest in the end. I refer by permission to the Editor of RECREATION. Measurement blanks and prices on application. Mention RECREATION.

T. H. GUTHRIE

88 William Street,

NEWARK, N. J.

All Work Guaranteed



THOMPSON



\$10 DRESSES ANY MAN

Complete from HEAD to TOE in latest Style
FREE SAMPLES
and Measurement Blanks.

TO INTRODUCE DIRECT TO THE WEARER OUR CUSTOM TAILORING we will make the first ten thousand suits absolutely to measures sent us for only \$10 and give the following

Complete Outfit FREE.

Actually \$28 value for only \$10 and nothing to pay till after you receive the suit and free outfit and find it just as represented. Send us your name and post office address and we will send you FREE SAMPLES OF CLOTH, 5-foot tape line and measurement blanks.

A GENUINE CHEVIOT SUIT

made to measure in the latest English Sack style, well made and durably trimmed,

- such a suit as some tailors charge..... \$20.00
- A Dunlap block Derby or Fedora Hat..... 2.50
- A pair of Stylish Lace Shoes, the new queen last.. 2.50
- A Percale Shirt, with Collar and Cuffs attached..... 1.25
- A Neat Silk Four-in-hand Necktie or Bow..... .50
- A pair of Fancy Web Elastic Suspenders..... .50
- A Japanese Silk Handkerchief..... .50
- A pair of Fancy Lisle Thread Socks..... .25

Thousands of Men pay daily for this **\$28.00**

DON'T DELAY—After having filled 10,000 orders our prices for these Suits alone will be \$20 and NO FREE ARTICLES.

GENT'S COMPLETE OUTFITTING CO.,
242 Market Street, Chicago, Ill.

Reference: First National Bank, Chicago, Capital \$12,000,000.

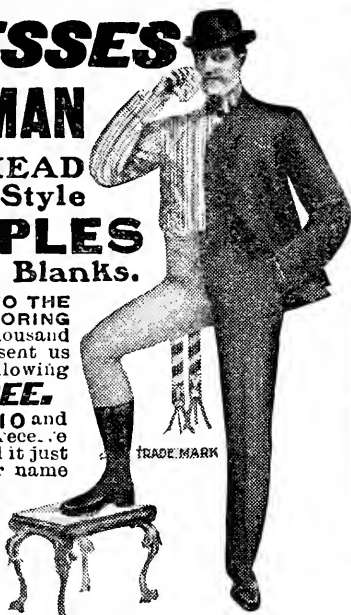

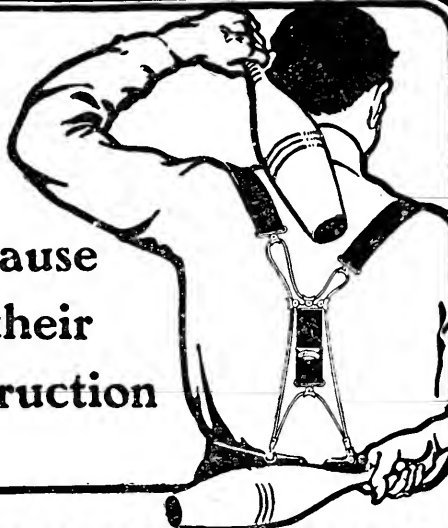

Because
of their
Construction

PRESIDENT SUSPENDERS

give most

Comfort & Service

Guaranteed "All breaks made good"
"President" on buckle means
"Cannot rust" 50c. and \$1.00
Any shop or by mail prepaid
The C. A. Edgerton Mfg. Co.
Box 219 K Shirley Mass
Send 6c. for Catalogue

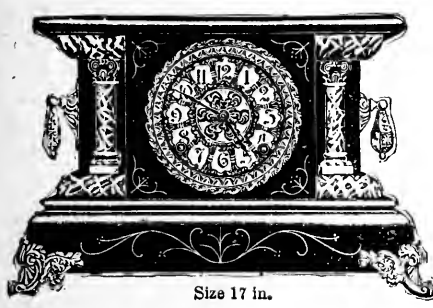

Size 17 in.

A skilled mechanic has invented lately a **Musical Clock** which, besides keeping perfect time, running 8 days with one winding, striking the hours and halves, will also **play favorite airs every half hour.** As the cost is very low, many prefer buying the clock with the musical attachment. Ask your jeweler for it or send to **E. L. CUENDET, Mfr., 7 Barclay Street, New York**

The Reason the **LUTHER HAND-MADE GLOVE** will not rip



Machine sewing cuts itself

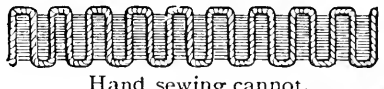

Hand sewing cannot.



A Practical Hunting and Driving Glove

Made for practical, comfortable, durability. No Oil. No Odor. No Animal Glue. Practically seamless. Cannot Rip. Unaffected by moisture of any kind. If soiled, may be washed with soap and hot water, without injury. The Luther Fastener is adjustable, fits any wrist and cannot get out of order. Illustrated booklet, samples and self measurement rule on application.

If you prefer to buy through your dealer send us his name **No. 308 Driving Glove** postpaid anywhere \$1.50, made to measure \$2.50, " " " " 3

J. P. LUTHER GLOVE CO., 536 Pearl St., Berlin, Wis.

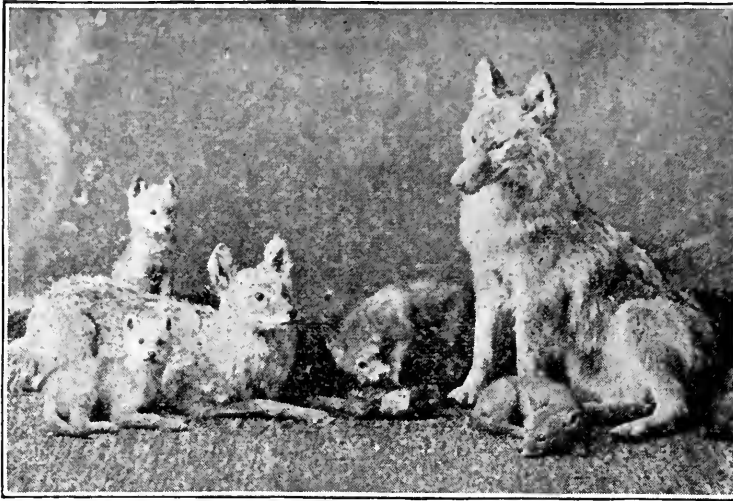

Drs. H. R. PHILLIPS & WREAN, of Penn Yan, N. Y., have on hand a fine lot of BREEDING DOES from the best Strains of BELGIAN HARES. We will breed to im-



ported Bucks of the best and sell for \$3.00 each, and fine Bucks for \$5.00, and they ARE FINE. Two fine Im-

ported Bucks and four Imported Does for sale. During the month of April we are obliged to close out the Hares. Now is the chance to secure some fine bargains.

DRS. PHILLIPS & WREAN.

Mention RECREATION.

Squab Book Free



Squabs are raised in 1 month, bring big prices. Eager market. Astonishing profits. Easy for women and invalids. Use your spare time profitably. Small space and capital. Here is something worth looking into. Facts given in our FREE BOOK, "How to make money with Squabs." PLYMOUTH ROCK SQUAB CO., 11 Friend St., Boston, Mass.

Make Money Breeding Pheasants, Quail and Squabs

We Start You. Send stamp for booklet telling you how to succeed. We buy all you raise.

For sale, all kinds of Pheasants, Poultry, Ducks, Geese, Wood and Mandarin Ducks, Gold Fish Globes, etc. We want agents to sell our Gold Fish, etc.

March Flyers—Imported Angora Cats, Male or Females, \$5.00 each. Good Ruff, Tail and Coat.

Hub Poultry and Supply Co.,

Station A No. 5. Boston, Mass.

English Ringneck Pheasants

Fine live birds for sale, and eggs in their season. Write for prices.

C. F. DEY, **Lawton, Mich.**

Pheasants' Eggs for Sale

English and Mongolian \$3 for 15;
golden, \$6 for 13.

L. M. Bachhuber, M.D. Mayville, Wis.

Cavies or Guinea Pigs.

Peruvian, Abyssinian or English Long or Short Haired. All colors. 400 to select from.

T. RACKHAM, East Orange, N. J.

CLOSING OUT

The best collection in Existence of the Mammals and Birds of Minnesota.

Consisting of Mounted Mammals, Heads, Antlers. Skins, Rugs, Mounted Birds, Skins, Eggs, Fresh Skins Relics, Curiosities, etc. *Send Stamp.*

ERNEST L. BROWN

The Minnesota Taxidermist,
WARREN, MINNESOTA.

Taxidermist's Materials

Glass Eyes for Stuffed Birds and Animals
Oöologist's and Entomologist's Supplies

Send 5c. in stamps for Catalogue

FRED. KAEMPFER

88 State Street, Chicago, Ill.

Taxidermy work done in all its branches

FLORIDA BIRDS.

I have on hand a fair assortment of our Native Bird Skins, suitable for schools, museums or private collections.

During the season of 1903 I will collect any birds or mammals to order.

Finest mounted work a specialty.

R. D. HOYT, Taxidermist,
SEVEN OAKS, FLA.

Game Heads and Fur Rugs

I have one of the largest collections of fine Heads and Rugs in the West. Natural animals' skulls, and all specimens for taxidermists. Send for photos of what you want.

A. E. HAMMOND, Taxidermist,
Missoula, Mont.

FINE MOUNTED GAME HEADS, BIRDS, ETC., for sale at unheard-of prices.

Send 10 cents for photos.

JOHN CLAYTON, Taxidermist, Lincoln, Maine

EXTRAORDINARY OFFER.

To any person sending me \$1 for a year's subscription to RECREATION, I will give free one of the following books: 6th and 7th Books of Moses. This is a great book. Every home should have one. Volumes I.-II., bound together in one volume; regular price is \$1. "The Almighty Dollar" is a new book just published, and is worth its weight in gold to any one. Can not be obtained for less than \$1 anywhere.

"Hunter's Guide and Trapper's Companion." This is a book every hunter and trapper should have. Descriptions of these books will be sent for a stamp. This is the greatest offer ever made, and you should not let this pass. Old subscribers may avail of this offer by sending 10 cents extra. Address Henry Nelson, Eckwoll, Minn.

The Rocky Mountain Goat

Is a shy, wary animal that ranges
8,000 to 15,000 feet
above sea level

and has rarely been photographed. Mr. A. M. Collins, one of RECREATION's prize winning photographers, has recently made 4 of the finest goat pictures ever produced. I HAVE had enlargements made from these, 13 x 15 inches, and will sell them

At \$5.00 a Set.

A rare and valuable group for sportsmen, amateur photographers and nature students. Address

RECREATION, 23 WEST 24th ST. NEW YORK CITY



NEW EDITION
Webster's
International
Dictionary

25,000
New Words, etc.

Edited by W. T. HARRIS, Ph.D., LL.D.,
United States Commissioner of Education.
New Plates Throughout. Rich Bindings.
2364 Pages. 5000 Illustrations.

The International was first issued in 1890, succeeding the "Unabridged." The New Edition of the International was issued in Oct., 1900. Get the latest and the best.

Also Webster's Collegiate Dictionary.
Send for specimen pages, etc.
G. & C. Merriam Co., Springfield, Mass.

SELL YOUR THOUGHTS

Not your time. Learn *Journalism and Story-Writing*, by mail, during spare hours. Send for our free booklet, "Writing for Profit." Tells how to succeed as story-writer, newspaper-correspondent, and magazine-contributor. Manuscripts sold on commission; also criticised and revised. Thornton West, Editor-in-Chief; founded 1895.

THE NATIONAL PRESS ASSOCIATION,
109 The Baldwin, Indianapolis, Ind.

NAVAJO INDIAN BLANKETS.

(NATIVE WOOL).

at strictly wholesale prices, \$1.25 a pound. These are first grade; gorgeous colored designed, closely woven. No two alike. For home or (en they are unexcelled. This offer extends to readers for 60 days only; soon these blankets will be a thing of the past. \$12.50 buys size 6 ft. x 4½ feet. \$21.00 buys size 5 ft. x 7 ft. very heavy and thick. Remittances should be addressed to

The Edward Smith Indian Post Trading Co.
CANYON DIABLO, ARIZONA
Send stamp for reply.



The most artistic and durable color effects on shingles are produced with Shingletint, which is a scientific combination of linseed oil, coloring matter, creosote and the necessary drying agents.

Among the many shingle stains offered Shingletint is conspicuous not only for its superiority but because it can be called for by its distinctive name, thus offering the consumer protection against inferior goods offered for the same purpose.

When buying Shingle Stains it will be worth while to ignore the "just as good" argument and insist upon Shingletint.

Stained woods and descriptive literature sent free upon request.

BERRY BROTHERS, Limited,

Varnish Manufacturers,

NEW YORK PHILADELPHIA CHICAGO ST. LOUIS
BOSTON BALTIMORE CINCINNATI SAN FRANCISCO

Factory and Main Office, DETROIT

STUDY 

PIANO TUNING

ANY INTELLIGENT PERSON
CAN MASTER THIS ART DURING
LEISURE HOURS AND ENTER INTO
A REMUNERATIVE PROFESSION

WRITE FOR PROSPECTUS

MUNROE CORRESPONDENCE SCHOOL
OF PIANO TUNING
FALL RIVER, MASS

PIANO Do You Want a Genuine Bargain

Hundreds of Upright Pianos returned from renting to be disposed of at once. They include Steinways, Knabes, Fischers, Sterlings and other well known makes. Many cannot be distinguished from new yet all are offered at a great discount. Uprights as low as \$100. Also beautiful New Uprights at \$125, \$135, \$150 and \$165. A fine instrument at \$290, fully equal to many \$400 pianos. Monthly payments accepted. Freight only about \$5. Write for list and particulars. You make a great saving. Pianos warranted as represented. Illustrated Piano Book Free.

LYON & HEALY

39 Adams St., CHICAGO.
World's largest music house; sells Everything known in Music

Marble's Automatic Gaff.



One of Marble's Automatic Gaffs will catch and hold any fish you can hook. You just reach out and touch the fish when near the boat and the gaff automatically seizes and holds him.

No. 1 Gaff, big enough for bass or any fish up to 15 lbs, in weight, **\$1.50**

No. 2 Gaff for all fish between 10 and 60 lbs., postpaid, **\$2.00**

Either finished in Nickel, 50 cents extra.

MARBLE'S HANDY FISH KNIVES are more satisfactory than others because hand-somer and better made. Postpaid, **85 cents** and **\$1.00**.

SEND FOR CATALOG A.

Sold by Dealers or Direct from

MARBLE SAFETY AXE CO., Gladstone, Mich., U. S. A.



"Banner"
(TRADE MARK)
Rubber
Coat

Pattern 28
Weight 4¾ lbs.

Absolutely Waterproof
A Gentleman's Rain Coat

"Can you furnish a GOOD Rubber Coat, not too heavy and yet strong and serviceable, which I can use in my practice as well as on fishing trips; and that will KEEP ME DRY?"
F. A. KNIGHTS, M.D., Minneapolis.

This order we filled with a "BANNER" RUBBER COAT, Pattern 28, and 6 months later the Doctor said: "It is just what I want and is the only coat I ever found that would REALLY SHED RAIN."

Sent express paid anywhere in United States on receipt of \$5.00. Sizes, 36 to 46 inches. Length, 54 inches. Give chest measure over ordinary coat.

Mackintoshes and Rain Coats made to order
All best quality Rubber Goods

Write for List No. 20

WE HAVE REMOVED to St. Paul, where our facilities for handling goods are greatly improved. Address
NORTHERN RUBBER CO.
Dept. P. - ST. PAUL, MINN.

Do you want a Good, Reliable, Substantial, Well Made

Single Barrel Shot Gun

If so, send me

10 YEARLY SUBSCRIPTIONS

and I will send you such a Gun as a premium

It is made by the *DAVENPORT ARMS CO.*, and this means it is made of good material and that only good workmanship is put on it.

This is one of the many remarkable opportunities *RECREATION* is offering to men and boys to fit themselves out completely for shooting and fishing.

Sample Copies for Use in Canvassing
Furnished on Application.

Address

RECREATION

23 W. 24th St., New York City

Do You Sleep Well?



"Yes," said Mrs. Strenuous, "a change of climate for one's insomnia is not only expensive, but often very inconvenient. I tried a change of *mattress* instead, substituting the Ostermoor Patent Elastic Felt Mattress for my hair mattress. Am delighted! although I was taught to believe a good *hair* mattress could not be excelled."

The Ostermoor Patent Elastic Felt Mattress \$15.

We would like to send you our book "The Test of Time." It has 72 pages of text and handsome illustrations, all describing the Ostermoor mattress and its ancient rival, the hair mattress. A postal card will bring it. Perhaps you do not want to buy a mattress. You spend *one third of your life* in bed and you *should* be interested in knowing what you sleep on. We can convince you that hundreds of *well-known* persons find that "The Ostermoor" fulfills every demand of economy, comfort and sanitary precaution.

Send for Free Book, "The Test of Time."

The Ostermoor Mattress is not for sale at any store—no one sells it but us. Our name and guarantee on every genuine mattress.

Thirty Nights' Free Trial.

Sleep on it 30 nights, and if it is not even all you have *hoped for*, if you don't believe it to be the equal in cleanliness, durability and comfort of any \$50 hair mattress ever made, you can get your money back by return mail—"no questions asked." There will be no unpleasantness about it at all.

2 feet 6 inches wide, 25 lbs.,	\$ 8.35
3 feet wide, 30 lbs.,	10.00
3 feet 6 inches wide, 35 lbs.,	11.70
4 feet wide, 40 lbs.,	13.35
4 feet 6 inches wide, 45 lbs.,	15.00

All 6 feet 3 inches long. In two parts 50c. extra. Special sizes at special prices.

Express Charges Prepaid to Any Point

OSTERMOOR & COMPANY, 114 Elizabeth St., New York

We have cushioned 25,000 churches.

Send for free book "Church Cushions."

CANADIAN ADDRESS: 301 St. James St., Montreal.





PRIZE AWARDS

For 1902 Contest Automatic Reel:

CLASS I. \$25.00

For heaviest Trout caught with "Y. & E." Automatic Reel during 1902. To A. B. BEAN, POCATELLO, IDAHO.

CLASS II. \$25.00

For heaviest fish of any other kind caught with "Y. & E." Automatic Reel during 1902. To WM. A. TEALL, EAU CLAIRE, WIS.

**For all-round fishing
the finest Reel
in existence.**

The 1902 Contest recorded some interesting battles—stiff fights with gamey fish, under all sorts of difficult conditions.

"Y. & E." 1903 Contest

FIVE MONEY PRIZES:

- Three for Grown-ups, - \$25.00 each
- Two for Young People not over 16, - 15.00 each

There are no "strings" to these prizes, no "entry" fees of any kind. They will be given for best catches made with "Y & E." Automatic Reels, and anybody, anywhere may compete. Write to-day for free contest blank R-300.

"Automatic, Combination," Style B., Diameter, 3 3/8 inches. Weight, 11 ounces. Carries 300ft. Winds 90 ft. automatically without re-winding. Price

\$8.00

"The little finger does it."



At your dealer's or mailed pre-paid anywhere in the U. S. and Canada. 4 other styles.

Yawman & Erbe Mfg. Co.,

Rochester, N. Y.

Write for Catalogue 299 R.



No. 1. HAS THREE COMPARTMENTS. FLOATS.

HALL'S TELESCOPIC BUCKETS

FROGS MINNOWS ICE

5 STYLES JAPANED FINISHED AND OXYGENATED COPPER NOT CONFLICTING WITH NATURAL LAWS IN DESIGN OR MAKE WE ARE THE ORIGINALS AND MAKERS OF THE ONLY BUCKETS MANUFACTURED TO LIVE IN CONFINEMENT. WE MAKE THE LEAST BEST LINED BUCKETS AND OUTFIT BUCKETS IN THE WORLD. ANY GOOD TALK CLEVER MAN WILL SHOW YOU HALL'S LINE. DO NOT WRITE US DIRECT.

\$10000 WILL BE PAID ANY PURCHASER OF THIS BUCKET WHO WILL SUGGEST AN EFFECTIVE IMPROVEMENT. WRITE DEPT. D.

HALL MFG. CO. CLEVELAND, O. 16-20 HIGH ST.

PAT. AUG. 5TH 1902. CANADA PENDING PATENTS.

PATENTS

Quickly secured. **OUR FEE DUE WHEN PATENT OBTAINED.** Send model, sketch or photo. with description for free report as to patentability. **48-PAGE HAND-BOOK FREE.** Contains references and full information. **WRITE FOR COPY OF OUR SPECIAL OFFER.** It is the most liberal proposition ever made by a patent attorney, and **EVERY INVENTOR SHOULD READ IT** before applying for patent. Address:

H. B. WILLSON & CO.

PATENT LAWYERS,
Le Droit Bldg., WASHINGTON, D. C.

No Other Reel Will Give

Satisfaction after you have seen the

"TALBOT"



A thing more perfect was never wrought in metal. In tournaments always a victor. Among fishermen's treasures, the chief.

Send for Booklet F:

W. H. TALBOT, Nevada, Mo.

A Severe Test

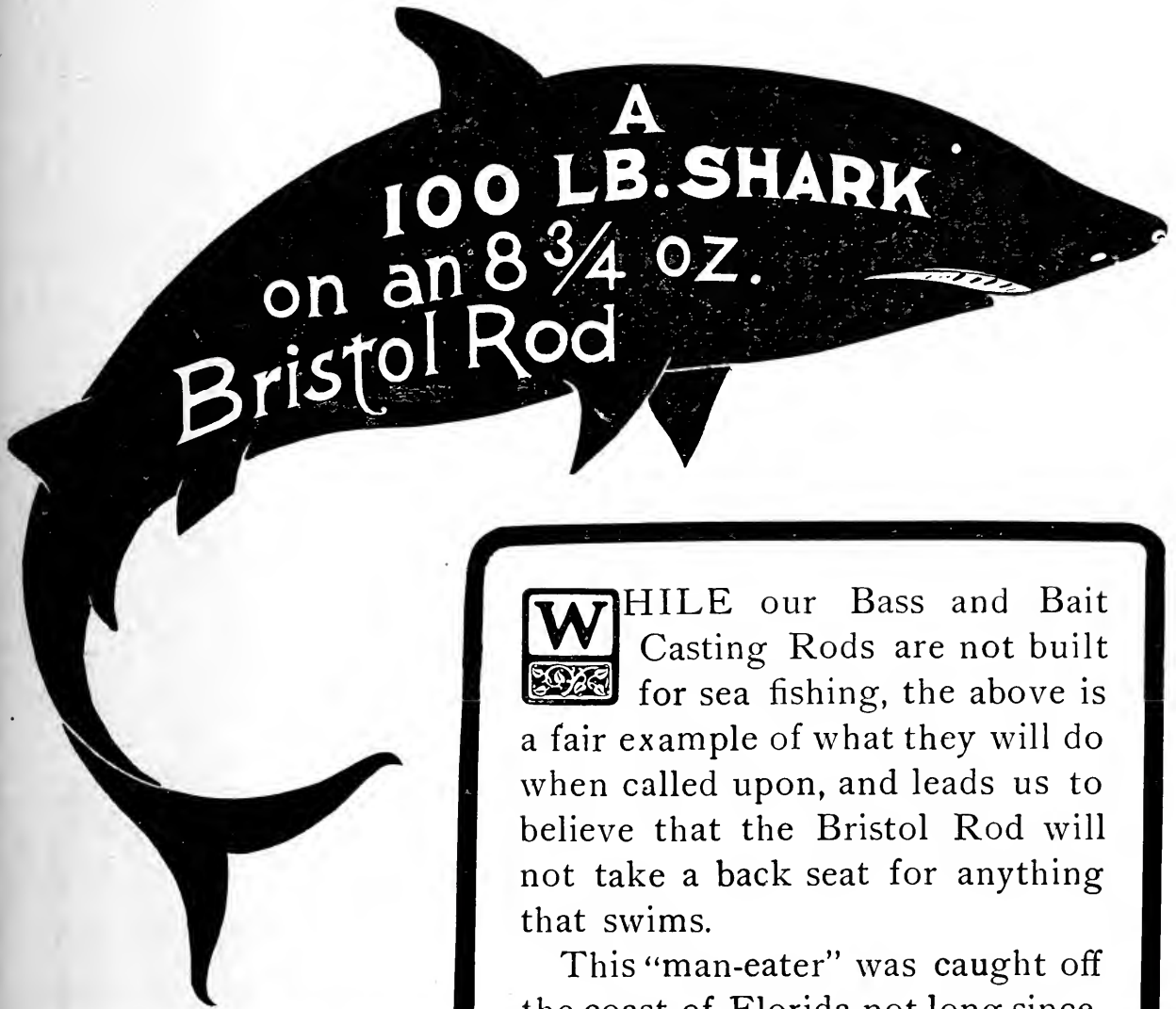

WHILE our Bass and Bait Casting Rods are not built for sea fishing, the above is a fair example of what they will do when called upon, and leads us to believe that the Bristol Rod will not take a back seat for anything that swims.

This "man-eater" was caught off the coast of Florida not long since, on a No. 17 Bristol Steel Fishing Rod. He was landed in less than 30 minutes, notwithstanding the fact that his first rush took off about 200 feet of line.

Tie your line to a Bristol—the Rod that is always equal to the emergency, the Rod that is more than equal to any wood or bamboo rod costing double the price.

**There's Nothing to Warp or Swell
Nothing to Split or Shrink**

Send for Catalog "R" describing 25 styles, prices from \$3.50 to \$17.00. Our Rods are sold by all dealers.

The Horton Mfg. Co.
Bristol, Conn., U. S. A.

IT NEVER FAILS

The S. & W. Artificial Bait

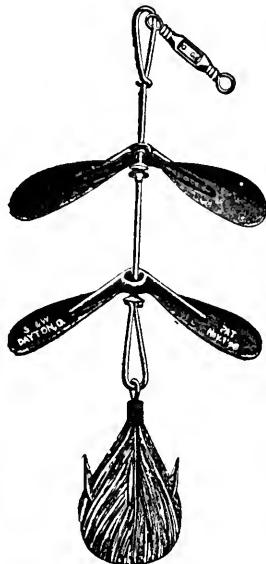

Is the most successful bait made. When in motion it resembles a minnow so closely that it never fails to delude the fish. Its construction makes it almost impossible for a fish to strike and not get caught.

A GREAT SELLER
Do you fish? Buy one. You will never be without one afterward. Why? It will catch fish. Can be used with rod or hand line.

Dealers send for illustrated booklet and get our prices.

If your dealer cannot supply you, send 50c. at once for one (post paid) to

STARK & WECKESSER
57 S. Main St. : : : DAYTON, OHIO, U. S. A.

Small Profits—Quick Sales

TROUT FLIES



for trial—send us

- 15c for an assorted sample doz. Regular price, 24 cents. **Quality A Flies**
- 30c for an assorted sample doz. Regular price, 60 cents. **Quality B Flies**
- 60c for an assorted sample doz. Regular price, 84 cents. **Quality C Flies**
- 60c for an assorted dozen Regular price 84 cents. **Bass Flies**

SPLIT BAMBOO RODS

Fly Rods 10 feet, 6 ounces **57 cents** Bait Rods 9 feet, 8 ounces
With cork grip and extra tip, in wood form

Try our new Braided Silk Enamelled Waterproof
METAL CENTER LINE
Size No. 5, 4½ cents per yard. Size No. 4, 5½ cents per yard.
Put up in 10-yard lengths connected.

THE H. H. KIFFE CO.
523 Broadway, New York City

Catalogs of any of above goods free on application.
Mention RECREATION.

COWBOY OUTFIT

A Genuine Cowboy Combined Cartridge and Money Belt of fine special prepared tanned russet leather; made in all sizes; 2¾ ins. wide; large, nickel buckel. Strong and durable. Just the thing for sportsmen. Postpaid anywhere for \$3.00.

Hand Carved Tanned Russet Leather Cowboy Holsters to match belt, and in all sizes. Postpaid anywhere for \$2.00 each. When writing enclose stamp for reply. Remittances should be addressed to the

Edward Smith Indian Post Trading Co.
General Eastern Office:

Buhl Block, DETROIT, MICH.



INDIAN CURIOS

WHOLESALE & RETAIL
CURIO DEALERS'
SUPPLY DEPOT.

Bead Work, Baskets, Elk Teeth, Mexican Goods, Fossils, Minerals, Arrow-Heads, Pottery, Alaska Ivories, Shells, Agates, Photos, Great stock, Big Cata. 5c., stamps. Mention RECREATION. If a dealer, say so.
L. W. STILWELL
DEADWOOD SO. DAKOTA



Patent Independent Level Winding Device

Patented Jan. 13, 1903.

Below we quote the following delivered price on guaranteed strictly high-grade quadruple casting reels, with even spooler attached. They are strong cut gear, light running, and as fine outside and in as a watch, and should last a lifetime.

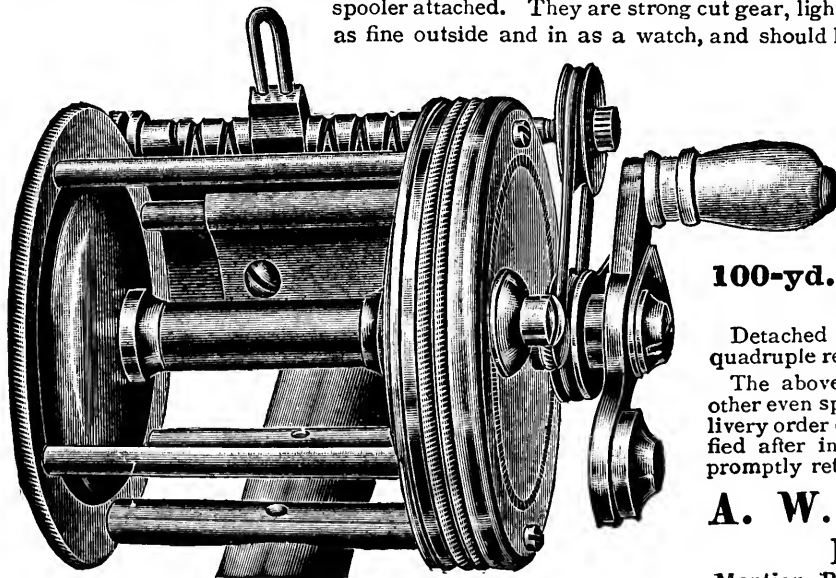

Jeweled Bearing:

- 100-yd., \$6.75
- 80-yd., 6.50
- 60-yd., 6.00

Stubs Steel Pivot Bearing:

- 100-yd., \$5.75. 80-yd., \$5.50
- 60-yd., \$5.00

Detached even spooler for such old or new quadruple reels as they will fit, . . . \$2.50

The above prices are less than half of any other even spooling reel. To insure prompt delivery order early. If you are not perfectly satisfied after inspection, return to us and we will promptly return your money. Catalogues free.

A. W. BISHOP & SON,
RACINE, WIS.

Mention RECREATION.

Standard Marine Engines

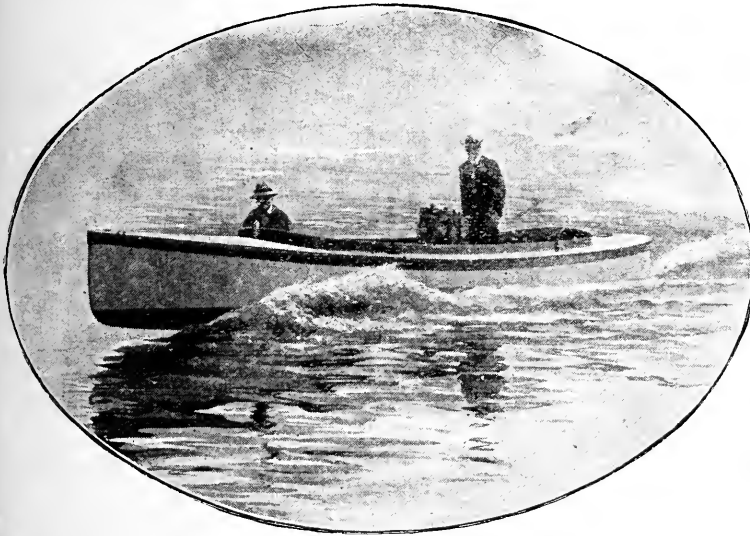

LAUNCH "RACER."

10 h. p. to 75 h. p., two, three and four cylinders. Cruising Yachts, Auxiliaries, Launches and Working Boats. The most effective engine made. Smooth Running, Safe, Positiveness in Action, Simple, Economical. Send for our illustrated book.

United States Long Distance Automobile Co.

307 WHITON STREET,

JERSEY CITY, N. J.

Do you want
A Folding Canvas Boat?

IF SO, SEND ME

35 yearly subscriptions
to RECREATION

AND I WILL SEND YOU

A 14 ft. folding canvas boat
listed at \$48

capable of carrying 2 men and an ordinary camp outfit. There are thousands of these boats in use, and nearly every man who is using one of them praises it on every occasion.

Sample copies of RECREATION for use in canvassing will be furnished on application.

Address 23 W. 24th St., N. Y.

Points on Angling

More complete than ever before.

The Habits and Haunts of
GAME FISH
and How to Catch Them

Mailed free on application

THE SPECIALTY MFG. COMPANY
Box 62a, Goshen, Indiana

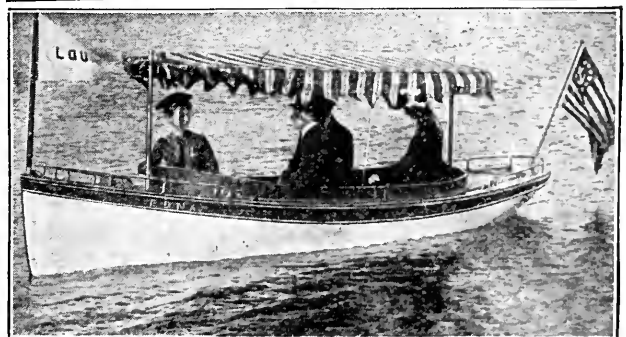

THE 16 FOOTER.

The biggest, safest, handsomest, completest of its size and a half to three fourths mile faster per hour. Send 5 stamps for catalog. Mention RECREATION.

TRUSCOTT BOAT MFG. CO., St. Joseph, Mich.
Agencies in all principal cities.

Fine Fishing Tackle Free.

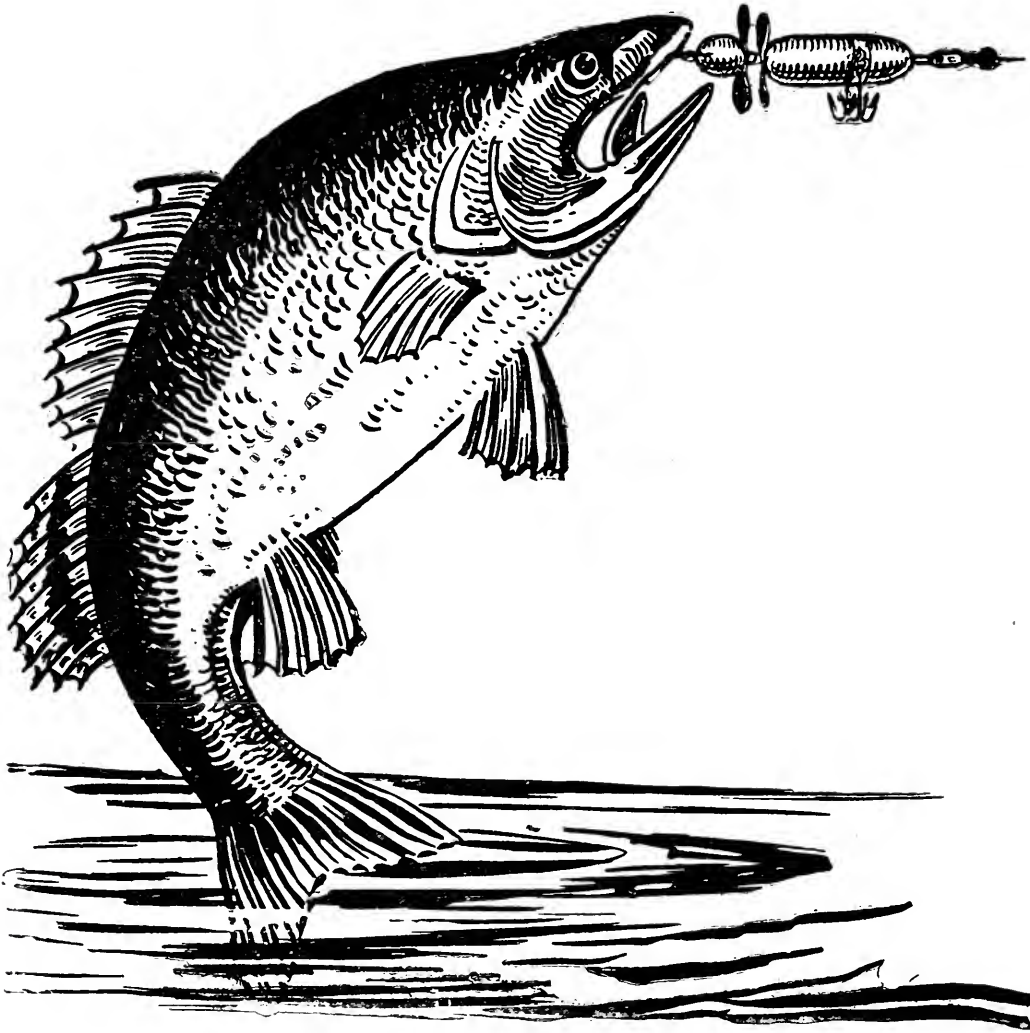

Who will
catch
the
\$100.00
Prize
Black Bass
this
year?

I want every enthusiastic fisherman, whether amateur, beginner or professional to have a personal knowledge of the fine points of the Shakespeare Reels and the marvelous catching qualities of the Shakespeare Baits—and to do this I propose to send to every man or woman who fishes for the real sport there is in it, one of my reels and baits for free trial on their next fishing trip. Write to-day. Send your name and address and the name and address of the leading sporting goods dealer of your city to Wm. Shakespeare Jr., 245 Shakespeare Bldg., Kalamazoo, Mich. The Shakespeare Reel is specially designed for accurate and long-distance casting, and is without doubt the best reel in the world, and you will say so when you see it. The metal used in the manufacture of the Shakespeare Reel is hard-drawn brass and the finest English Stubbs steel—the best obtainable. Painstaking care is used to secure perfect accuracy in every detail. In beauty of design, and simplicity of construction it is unequalled. Its easy, silent running suggests perpetual motion and it is fitted with the

most perfect drag and click ever invented. Words will not describe its beauty, its usefulness and its many advantages over all other reels. My reels and baits are for sale by all first-class dealers, but I want you to see them and try them for yourself and you shall have them, if you write me, for a free trial on your next fishing trip. The Shakespeare Baits are really marvelous. With them the fisherman is sure of a good catch, no matter where the fish are, in the lake or stream. If they are in deep water, Shakespeare makes the bait that attracts them. If they are in shallow water, Shakespeare makes the bait that catches them. If they are hidden in the lily pads or moss, Shakespeare makes the bait that makes them strike. And Shakespeare offers \$100 in prizes for the photograph and authentic dimensions of the biggest large or small mouth bass caught this year. Write to-day for particulars. His little booklets, "How to Catch Bass," "Fine Points About Tackle" and "The Art of Bait Casting" are free to every angler. Write to-day and send your name and address.



**BULLARD STEEL LAUNCHES,
ROW AND PLEASURE BOATS,
ARE EVERLASTING!**

Safer than wood; have greater carrying capacity; always dry; no bolts or nails to rust.

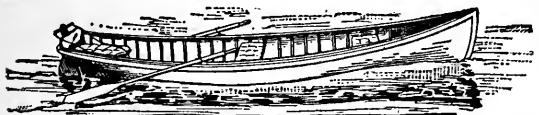

Boat Liveries equipped with the Bullard Steel Boats. Always have dry boats, that last a lifetime.

STEEL BOATS CHEAPER THAN WOOD.

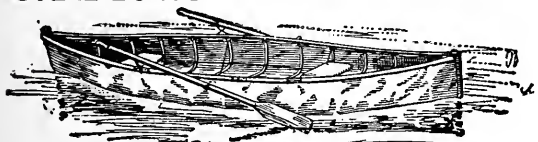

THE OSGOOD FOLDING CANVAS BOATS

Original Canvas Boat; made for 30 years. Sold all over the world; used by U. S. Government; best Fishing and Hunting is where there are no boats, take one with you in trunk or bag. Non-puncturable. Folded or extended in one minute.

Send for catalogue illustrating all improved popular designs of Steel, Wood, and Canvas Boats, and Marine Engines.

MICHIGAN CONSOLIDATED BOAT CO., LTD.
505 Main St., Battle Creek, Mich.

**RUSHTON
CANOES**

Are Tried and True

My canvas-covered cedar canoes of the "Indian" models are as well and thoroughly made for their class as my all-cedar styles, and these are the standard everywhere.

ORDER EARLY.

In 1902, the first year for these models, not half my orders could be filled, though I built twice the number intended.

"INDIAN GIRL" MODEL

15, 16, 17, 18 ft. **\$30 to \$43**
56 to 80 pounds

Send for my complete catalogue of pleasure boats, canoes and fittings.

J. H. RUSHTON,
817 Water Street, Canton, N. Y., U. S. A.



WANT A REEL?

You can get one for nothing.
Or at least for a few hours' work.

Send me

15 Yearly Subscriptions

to

RECREATION

and I will send you

A TALBOT REEL

Listed at \$20.00

Made by W. H. Talbot, Nevada, Mo.

This is one of the finest pieces of fishing tackle ever made. It is built like a gold watch. Equal to any Kentucky reel you ever saw.

**In Tournaments, Always a Victor
Among the Angler's Treasures, Always the Chief**

I have but a few of these reels in stock, and this offer will be withdrawn as soon as the present supply is exhausted.

Sample copies of RECREATION for use in canyassing furnished on application.

FAY & BOWEN

Motors & Launches

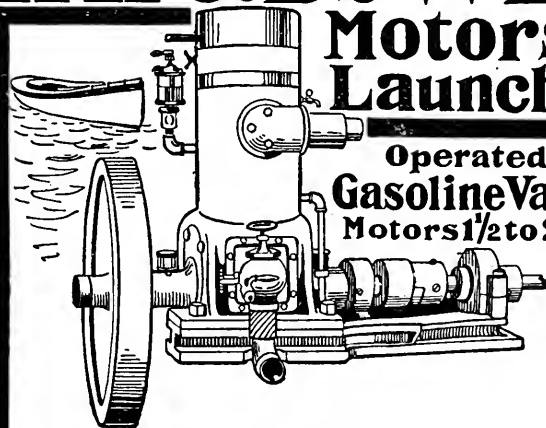

Operated by
**Gasoline Vapor
Motors 1/2 to 25HP.**

THE Fay & Bowen Marine Motor is a revelation to those who have used others. Reliable, safe, durable and easy to operate. Remarkable speed control. Best of all, it starts when you start it. No handle or crank is used. Our patented igniter is absolutely unique and always instant and positive in action. It is really the only perfect and satisfactory igniter.

Motors complete from 1/2 to 25 H. P. ready for installation. We also build handsome launches with motors installed and ready to run.

Send for Catalogue.

Fay & Bowen,

28 Mill Street

Auburn, N. Y.

Latest patent and Improved Canvas Folding Boat on the Market.



Puncture proof. Tempered steel frame. No bolts to remove. Folds most compact of any boat made.

THE
Latest, Safest,
AND
Best Canvas Boat

Is what we offer you. A Boat built on modern lines that will prove a pleasure to own and use. Selected materials used throughout, and it comes to you **guaranteed** the best. A handy and safe boat for fishing and shooting. Write for descriptive circular and catalog.

Mention RECREATION.

**LIFE SAVING
FOLDING CANVAS BOAT
COMPANY**
Kalamazoo, Michigan

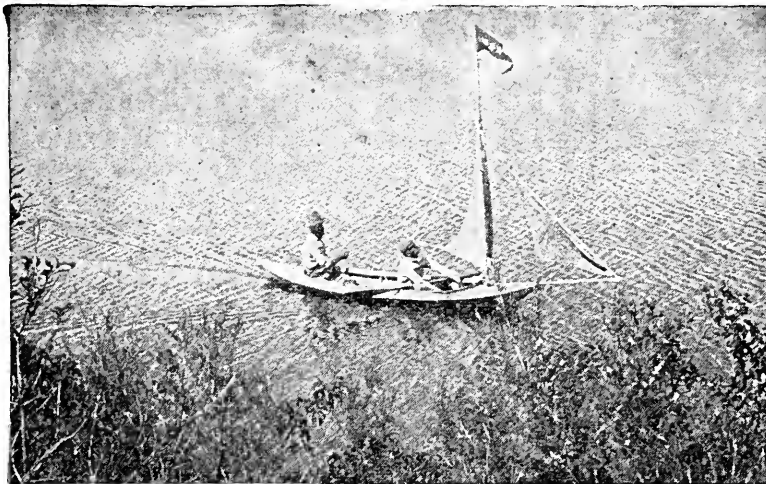

Recreation with the aid of a Mullins' Metal Boat or Canoe is as near perfect as you can get it.

Send for our handsome illustrated catalogue—FREE.

W. H. MULLINS
228 DEPOT STREET
SALEM, OHIO

WHITESTONE HOLLOW SPAR AND BOAT CO.

Successors to

The Spalding St. Lawrence Boat Co.,

Builders of

- The FAMOUS St. Lawrence River Skiffs
- Cedar Canoes
- Canvas Covered Cedar Canoes
- Speed Launches
- YACHTS' DAVIT BOATS

Makers of

Send for Spar Book-let No. 4.

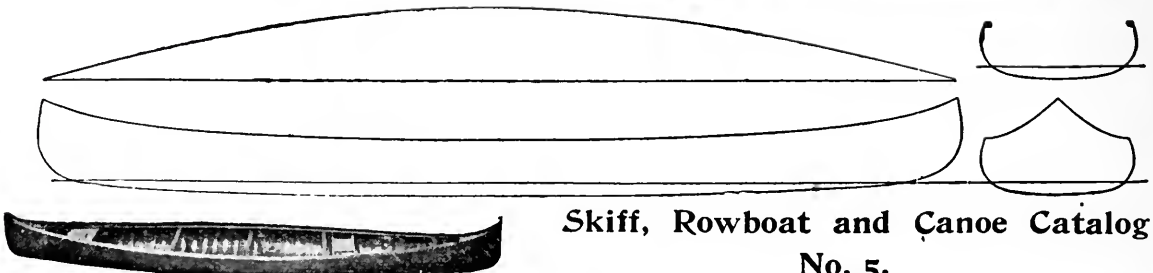

Skiff, Rowboat and Canoe Catalogue No. 5.

WHITESTONE HOLLOW SPAR AND BOAT CO.

J. C. FRASER, Manager
Whitestone Landing, Long Island, N. Y.

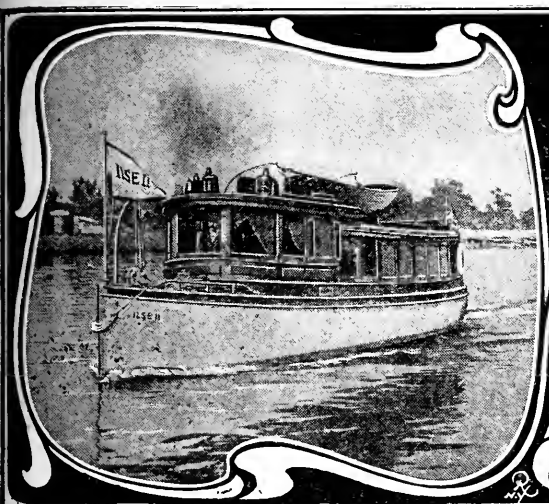

LOZIER GAS ENGINES AND LAUNCHES.

ENGINES, $1\frac{1}{2}$ to 36 H. P.

BOATS, 17 to 75 Feet

HIGH-SPEED LAUNCHES, 21, 25 and 36 feet

LOZIER MOTOR COMPANY, Plattsburg, N. Y.

Branches:
NEW YORK CITY, 1 Broadway
BOSTON, 20 Central Street
PHILADELPHIA, The Bourse

Sales Agencies:
WASHINGTON, D. C., 1111 14th St., N. W.
BALTIMORE, 651 W. Baltimore Street
CHICAGO, 1412 Michigan Avenue

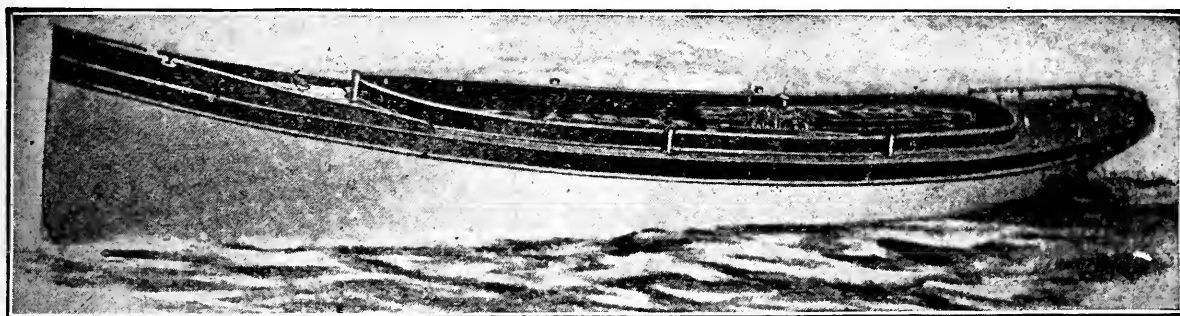

LEAMAN BOAT COMPANY

WINNECONNE, WIS.

Manufacturers of Gasoline Launches, Sail, Row, and Hunting Boats. Our prices are low, our work guaranteed. Launches, \$150 up. Row Boats, \$22 up. Hunting Skiffs, \$20 up. The oldest Boat Company in the State. Write for Wants. Mention RECREATION.

FOLDING CANVAS BOATS were not satisfactory until the

KING

was produced. It's a revelation in boat construction, nothing like it ever



11-foot Special

made. *Nonsinkable. Can't tip over. Puncture Proof*, wear longer than a wooden boat. No repairs. No cost for storage, always ready, folds into a small neat package, carry by hand, used by the U. S. Navy. They are simple, wonderful. A thoroughly patented article. Beware of imitations. Made only by ourselves. *A catalog of 70 engravings and 350 testimonials sent on receipt of 6 cents.*

Bottom Boards rest on the frame not on the canvas, ribbed, longitudinally and diagonally. They are *stiffer and safer* than

a Wooden Boat because the lines are fuller, and are much easier to row or paddle.

KING FOLDING CANVAS BOAT CO.

Mention RECREATION.

KALAMAZOO, MICH., U. S. A.

SAILING. CAMPING. PROSPECTING. FISHING. HUNTING.

Established 1840

GEO. B. CARPENTER & CO.
MAKERS OF HIGH GRADE
**TENTS, SAILS
CAMP FURNITURE**

Folding Cots
Tables and Chairs

Oars, Paddles
Marine Hardware

Copyright 1899
Geo. B. Carpenter & Co.

**The Largest and Most
Complete Stock in the U. S.**

Send 4c. in stamps for Tent and Camp Catalogue, or
6c. in stamps for Marine Hardware Catalogue.

200, 202, 204, 206, 208 S. Water St.
CHICAGO, ILL.

PALMER

Gasoline Engines and Launches

MARINE and STATIONARY ENGINES
of both two and four cycle type in stock.

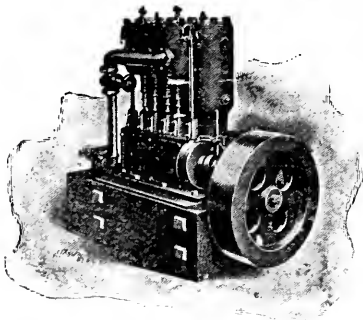

*Special discount on launches ordered during
winter months for Spring delivery*

PALMER BROS., - Cos Cob, Conn.

NEW YORK OFFICE: 136 Liberty Street

EXTENDED & FOLDED
ACME FOLDING BOAT CO., MIAMISBURG, O.

U. S. Government who prefer our boats. Received medal and award at Chicago World's Fair. If you investigate we will get your order. Mention RECREATION.

Acme Folding Boat Company, Miamisburg, O.

Send for catalogue of our full line of Folding Canvas Boats and Canoes, which have been adopted by Governments of United States, Canada and England. Just filled an order for

D.M. TUTTLE CO. 10 PINE STREET CANASTOTA, N.Y. **CATALOGUE FREE.**
BREAK SPARK. GASOLINE ENGINES & LAUNCHES. JUMP SPARK.



How
far
have you
walked?

THE AMERICAN PEDOMETER

Registers Every Step You Take.

\$1.00 Carried like a watch in the pocket; can be regulated to suit step of wearer. **\$1.00**

The average man has no idea of the number of miles he covers in a day. Everybody should carry a Pedometer.

If your dealer cannot supply you, send us **One Dollar** and we will mail you one in handsome nickel case. **Every One Fully Guaranteed.**

In addition to above we make a Pedometer with a 100 mile dial which we will mail to any address for \$1.50.

THE AMERICAN PEDOMETER CO.,
Factory: New Haven, Conn. 46 Maiden Lane, New York.

But for such doughty service as you and others are doing for the protection and conservation of wild life, there would soon be no living things in our woods or waters for thousands of us to enjoy, study and photograph. To some the reproofs that you give to the greedy sound harsh; yet in human history great reforms have only been secured through forceful words and deeds. We still need Luthers and Savonarolas, Clarksons and Garrisons, voices crying in the wilderness. Men called them "cranks," but they accomplished what milder spirits could not. When I visit bird rookeries where ruthless human butchers have been, I find myself not at all in the mood to trim words and phrases to avoid offense. I am sure that your incisive, fearless language is one of the strong factors in stirring the thoughtless, shaming the guilty, and in arousing righteous public opinion. Surely we who love the wild creatures will be the last to restrain or restrict the prophet in the delivery of his message in his own way, whether or not that way would be precisely ours. I wish you and RECREATION continued prosperity, with ever widening service and influence.

Herbert K. Job, Kent, Conn.

For Sale: Adirondack Guide Boat; 3 cane seats, with cane backs. Round bottom cedar. Would exchange for a fox or rabbit hound. Address

W. J. Pollock, Little Falls, N. Y.

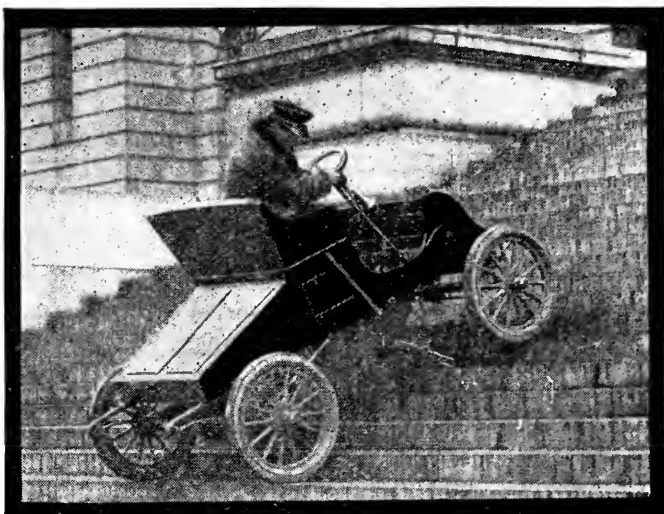

Power and Control

These essentials of the serviceable and safe automobile are developed in the Cadillac Automobile through new principles of engineering and perfect mechanical construction. The engine is very compact and very powerful; the transmission gear a triumph of mechanics; the steering wheel very sensitive—and absolute in its control; the brakes reliable under all conditions of grade and speed; running gear and body strong, but graceful. The

CADILLAC

is The
Automobile that
Solves the Problem

of safe and rapid transit on all roads, under all conditions. If you know of an auto fault you'll find it corrected in the Cadillac. Price \$750. Detachable tonneau at an extra cost of \$100 converts this graceful runabout for two into a delightful touring car for four.

Our FREE illustrated booklet K gives address of agency nearest you where the Cadillac may be seen.

CADILLAC
AUTOMOBILE COMPANY,
Detroit, Mich.

110 MILES OF STEEL TOWERS

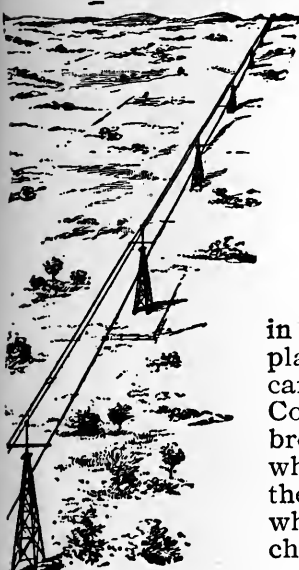

The largest order ever placed for steel towers has just been executed by the Aermotor Company, Chicago. The order was for 1200 steel towers to support large electric cables. These towers are to be erected in the interior of Mexico, to carry electricity from an immense water power plant up to the mines, over 100 miles distant. The order for these towers came to the Aermotor Company unsolicited. The reputation of the Aermotor Company for building the best steel towers, for windmill and other purposes, brought them this unusual order. When the engineering and mining experts, who were placing the contract, were making up their specifications for these towers, they found no place in the construction of the Aermotor tower where they could suggest improvement. The sizes of some of the parts were changed to meet their particular needs, but the design of the towers remained precisely the same as the Aermotor Company perfected it years ago.

It was of very great importance to the company buying these towers to secure the greatest possible strength with the least material. These towers were to be placed about 500 feet apart. The weight of the long span of cables would be a very heavy load, to say nothing of the enormous side strain which might come upon the towers. Then, too, the contingency of one or more of the cables breaking, and throwing unequal strain upon different parts of the towers, had to be considered. The Aermotor Company guaranteed these towers to stand until the 3-inch, extra strong wrought iron pipe in the top should bend over. They stood this very severe test without the least indication of buckling in any part of the tower.

The item of freight was another important consideration. These towers, as built by the Aermotor Company, made over 75 carloads. No other concern could have furnished towers of anything like the same strength with less than 100 cars of material.

The Aermotor Company has a very great advantage over all others in the manufacture of steel towers. It was the first in the field, and had all the most vital features fully covered by patents before competitors were through laughing at the idea of a steel tower. The Aermotor tower was designed by mechanical experts who knew what points were essential to secure the greatest strength with the least material.



Testing the Towers.

the strain directly upon the corner posts where it belongs. The braces and girts have nothing to do but hold the corners in line. Because other makers are not able to adopt this feature, they are compelled to use a large amount of extra material in their towers, and even then their towers are not so strong. Weight often indicates weakness rather than strength. All the weight not needed serves only to bring additional strain upon the parts which must bear it.

The best steel tower, like the best bicycle, is the one which secures the greatest strength with the least possible material. The Aermotor tower is strong, safe and durable. Every pound of steel which is put into it is used to the best advantage. A tower twice as heavy, but poorly constructed, would be weaker.

The tower is a very important consideration in buying a windmill outfit. If the tower goes down, the best windmill will be worthless.

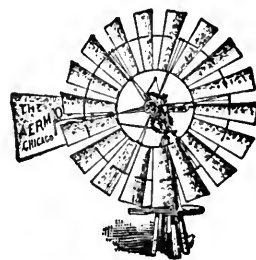

WRITE FOR OUR WINDMILL BOOK

We have a book that tells all about windmills. It begins with the Dutch windmills of 1400 and ends with the Aermotor of 1903. It contains 125 pictures to show you what windmills should do and what they should be. It tells all that invention has done for them. When you read this book you will know all that anyone knows about windmills. You will know the right kind from the wrong kind and know all the differences. To avoid a mistake don't buy without reading it. The book is free. Simply write for it.

AERMOTOR CO., 1310 TWELFTH ST., CHICAGO

THE "BROWNIE" RIFLE

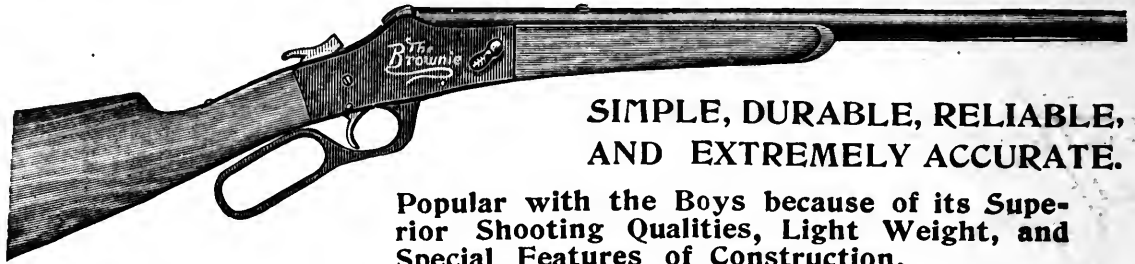

**SIMPLE, DURABLE, RELIABLE,
AND EXTREMELY ACCURATE.**

Popular with the Boys because of its Superior Shooting Qualities, Light Weight, and Special Features of Construction.

Furnished in .22 caliber only. Weight $4\frac{1}{4}$ to $4\frac{1}{2}$ pounds. It is supplied by RECREATION as a Premium. Write for Catalogue

The W. H. Davenport Fire Arms Co., Norwich, Conn.

Newhouse Traps

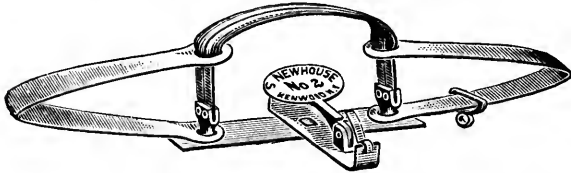

THE STANDARD FOR OVER FIFTY YEARS
Used by all professional hunters and trappers,
who find that

The Best Trap is the Cheapest
Complete illustrated catalogue on
application.

ONEIDA COMMUNITY, LTD., Kenwood, N. Y.

THE BRADLEY SHOT GUN SIGHT!

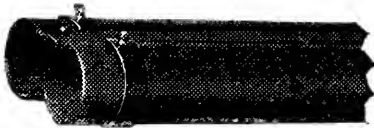

Wing Shooting is made easy and certain by using this gun sight. Scores at trap and in field

greatly increased by its use. Right and left birds are bagged as easily as straight-away birds.

Price 50 Cents, Postpaid.

C.L. BRADLEY, Inventor, CLARKSVILLE, TENN



"Collan-Oil"

preserves leather and renders shoes and harness positively

WATERPROOF

Used by the U. S the Army and Navy and National Guard.

Send 25c. for trial can.

AGENTS WANTED

Write for terms and circulars

J. R. BUCKELEW

Dept. A.

111 Chambers St., N. Y.

KOENIG'S SHELL EXTRACTOR.



Every shooter should have one—carry it in a vest pocket. Fits any gauge shell. Koenig's Gun Catalogue, Free.

10 Cts. Postpaid.

E.G. KOENIG, NEW JERSEY'S LARGEST GUN HOUSE

SOUTH BROAD ST., NEWARK, N. J.

THE "J. C." HAND TRAP

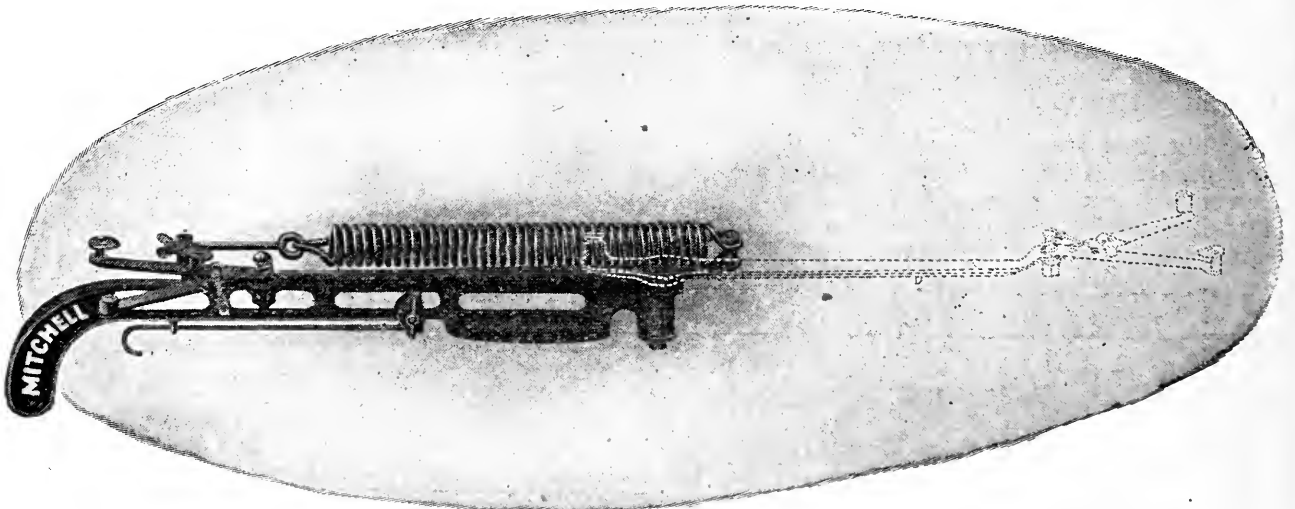

Dark lines show trap set, ready for the target. Dotted lines show trap sprung after target has been discharged. Start the season right by owning one of these traps. Gives the best kind of practice. Sent by prepaid express on receipt of price, \$4.00.

THE MITCHELL MFG. CO., London, Ohio.



PERFECTION AT LAST!

To the "OLD RELIABLE"

has fallen the honor of making the FIRST and ONLY PERFECT score which has ever been made in an all day tournament.

At Spirit Lake, Ia., Aug. 6th, 1902

Events 15 15 20 15 15 20 15 15 20 15 15 20—200

Score 15 15 20 15 15 20 15 15 20 15 15 20—200

The above score was made by

MR. FRED GILBERT WITH A PARKER GUN

Send for Catalogue

PARKER BROS., Meriden, Conn.

NEW YORK SALESROOM: No. 32 WARREN ST.

Mention RECREATION.



We make a specialty of Featherweights and Trap Guns with our new SINGLE TRIGGER

Guaranteed Perfect

Our New Perfect Gun Cleaner By Mail, 30 Cents

Send stamp for 1903 Catalogue Mention RECREATION

D. M. LEFEVER SONS & CO.,

Manufacturers of the "NEW LEFEVER"

Not connected with Lefever Arms Co.

SYRACUSE, N. Y.

Telescopic Sights

FOR HARD USE AND FINE WORK

ADDRESS FOR CIRCULAR

L. N. MOGG, Marcellus, N. Y.

Mention RECREATION

For Sale: New Yawman & Erbe Automatic Reel, style B. E. Wilson, Louisburg, O.

Practical Common Sense in 6 Sizes.

CAMP STOVE

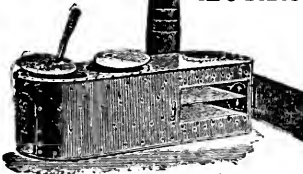

Either with or without oven. The lightest, strongest, most compact, practical stove made. Cast combination sheet steel top, smooth outside, heavy lining in fire

box and around oven, holds its shape, telescopic pipe carried inside the stove. Burns larger wood and keeps fire longer than any other. Used by over 9,000 campers and only one stove returned.

For catalogue giving full particulars, mention RECREATION and address,

D. W. CREE, Manufacturer, Griggsville, Ill.

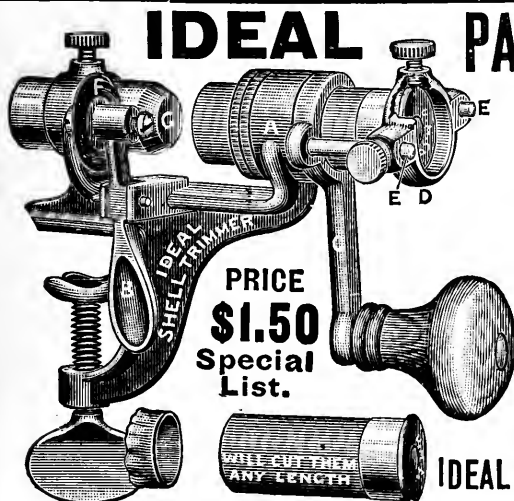

IDEAL PAPER SHOT SHELL TRIMMER SOMETHING NEW.

With it you can cut off the soft and frayed ends of shells that have been fired and they will be as good as new. Why throw good shells away? Send us 6 cents in stamps for latest IDEAL HAND BOOK, giving full information of all New Goods and much matter of interest to shooters. Address,

IDEAL MANUF'G CO., 12 U St., New Haven, Conn., U.S.A.

THE PHIL. B. BEKEART CO., of San Francisco, Cal., Agents for Pacific Coast,

When you write please mention Recreation.

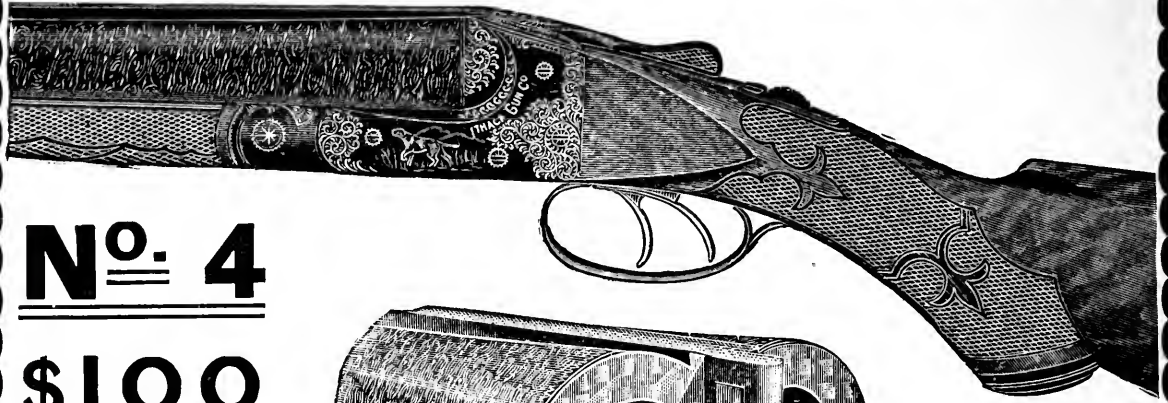

No. 4

\$100

LIST

ITHACA

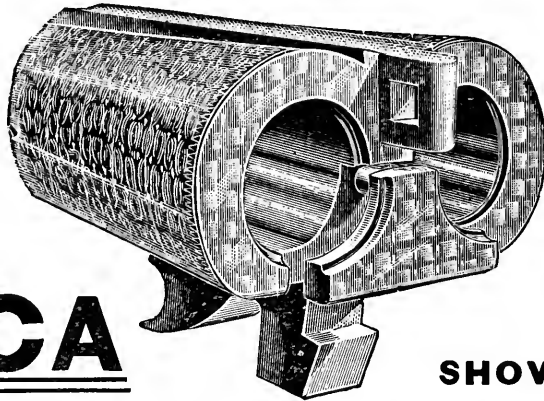

THE
**NITRO
BREECH**

SHOWING NEW
CROSS BOLT

GUARANTEED to be worth \$25.00
more than any other make
of Gun at Same Cost.

Send for Catalogue Describing Sixteen
Different Grades of Guns, Ranging in
Price from \$19.50 to \$300.

ITHACA GUN CO., Ithaca, N. Y.

Mention RECREATION.

H. & R. SINGLE SHOT GUN

Automatic and Non-Ejecting

The cheapest absolutely safe gun, with improve-
ments found heretofore only in the highest priced.

**PERFECT IN MODEL
AND CONSTRUCTION**

**SIMPLEST "TAKE
DOWN" GUN MADE**

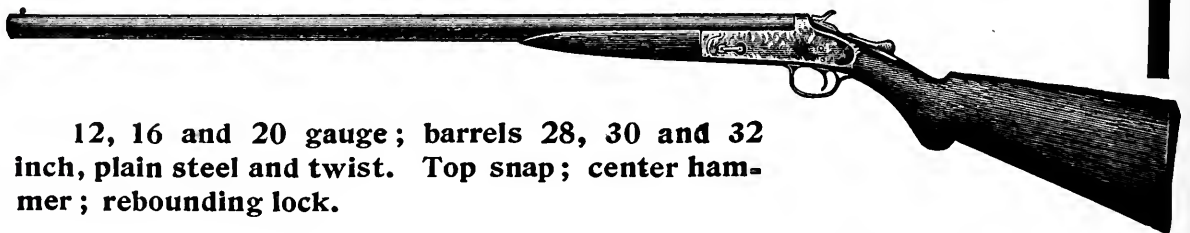

12, 16 and 20 gauge; barrels 28, 30 and 32
inch, plain steel and twist. Top snap; center ham-
mer; rebounding lock.

Your dealer can supply, or we will
sell to you direct. Write for Catalog.

HARRINGTON & RICHARDSON ARMS CO.

Dept. R, WORCESTER, MASS.

Makers of H. & R. Revolvers

DU PONT SMOKELESS

WINS MORE HIGH AVERAGES THAN ALL
OTHER POWDERS.

ITS UNIFORMITY, VELOCITY, AND CLOSE
PATTERN ARE DEMONSTRATED BY THOU-
SANDS OF TRAP SHOOTERS THROUGHOUT
THE COUNTRY.

E. I. DUPONT DENEMOURS & Co.

WILMINGTON, DELAWARE

POWDER MAKERS FOR A CENTURY

NEW CENTURY RIFLE



MAUSER SYSTEM.

SHOOTS 22 SHORT OR LONG CARTRIDGES,
FINE STEEL BARREL,
TAKE DOWN, SHOOTING GUARANTEED.

Price, \$3.00

ASK YOUR DEALER OR ORDER DIRECT.

SCHOVERLING, DALY & GALES,

**302 AND 304 BROADWAY,
NEW YORK CITY.**

OLD DOMINION LINE

SHORT SEA TRIPS

POPULAR LINE FROM

**New York to
Old Point Comfort,
Norfolk,
Virginia Beach,
Richmond, Va.,
and
Washington, D. C.**

STEAMERS SAIL DAILY, EXCEPT SUNDAY AT
3.00 P.M.

Old Dominion Steamship Co.

H. B. WALKER, T. M. J. J. BROWN, G. P. A.

81 and 85 Beach Street New York

**Do you enjoy big game hunting?
Or Trout Fishing?
Or Mountain Climbing?
If so, write us and we can accommodate you.**

We keep 65 head of horses. We employ a full corps of experienced guides, packers, and cooks.

We have a complete outfit of riding saddles, pack saddles, tents, stoves, cooking utensils, tableware, and everything necessary for touring and camping in the Mountains.

We live at Banff. The Eastern gateway of the Canadian Rockies.

And can send you anywhere you may wish to go from this point

North, East, South or West.

**Address: BREWSTER BROS.
Banff, Alberta, Canada.**

RELICS OF A DISAPPEARING RACE

Buffalo Skulls

WITH POLISHED OR
UNPOLISHED HORNS

Also polished or unpolished horns in pairs or single. Polished horns tipped with incandescent electric lights; polished hunting horns; mirrors hung in polished horns, etc. These are decided novelties and are in great demand for sportsmen's dens, offices, club-rooms, halls, etc. Send for illustrated catalog. Mention RECREATION.

E. W. STILES

141 Washington St. Hartford, Conn.

SOME GOOD GUIDES.

Following are names and addresses of guides who have been recommended to me, by men who have employed them; together with data as to the species of game and fish which these guides undertake to find for sportsmen.

If anyone who may employ one of these guides should find him incompetent or unsatisfactory, I will be grateful if he will report the fact to me.

ALASKA.

Edwin Edelmann, Kenai, Cook's Inlet, moose, bear, caribou, mountain sheep, ducks, grouse and trout.

FLORIDA.

Carson Bros., Frostproof, bear, deer, turkeys, quail, snipe.

C. H. Stokes, Mohawk, deer, alligators, turkey, quail, and snipe.

IDAHO.

John Ching, Kilgore, elk, bear, deer, antelope, mountain sheep, trout and grouse.

Chas. Petty's Kilgore, ditto.

MAINE.

H. R. Horton, Flagstaff, deer, bear, moose, caribou, fox, grouse and trout.

NEW YORK.

Le Roy Still, Bayport, Long Island, ducks, quails, rabbits and grouse.

WYOMING.

S. N. Leek, Jackson, elk, bear, deer, mountain sheep, antelope, grouse and trout.

James L. McLaughlin, Valley, elk, bear, deer, mountain sheep, antelope, grouse and trout.

CANADA.

Wm. S. Andrews, Lillooet, B. C., deer, bear, mountain sheep, goats, grouse and trout.

B. Norrad, Boiestown, N. B., moose, caribou, grouse and trout.

Carl Bersing, Newcastle, N. B., moose, caribou, deer, bear and grouse.

Pheasants: Amhersts, Reeves, Goldens, Silvers, English, etc.; also Woodducks and Mandarins in stock. Rarer breeds and Swans imported. Beautiful 18 x 24 Color-plate of Golden Cock 25 cents. Detroit Pheasantry, Stanton Ave., Detroit, Mich.

IN ANSWERING ADS PLEASE
MENTION RECREATION.

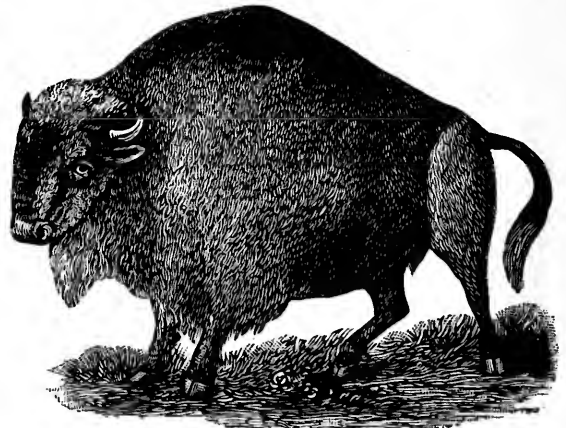

"HOPKINS & ALLEN" Single Barrel Shot Guns

(Made for any powder and good for any shot.)

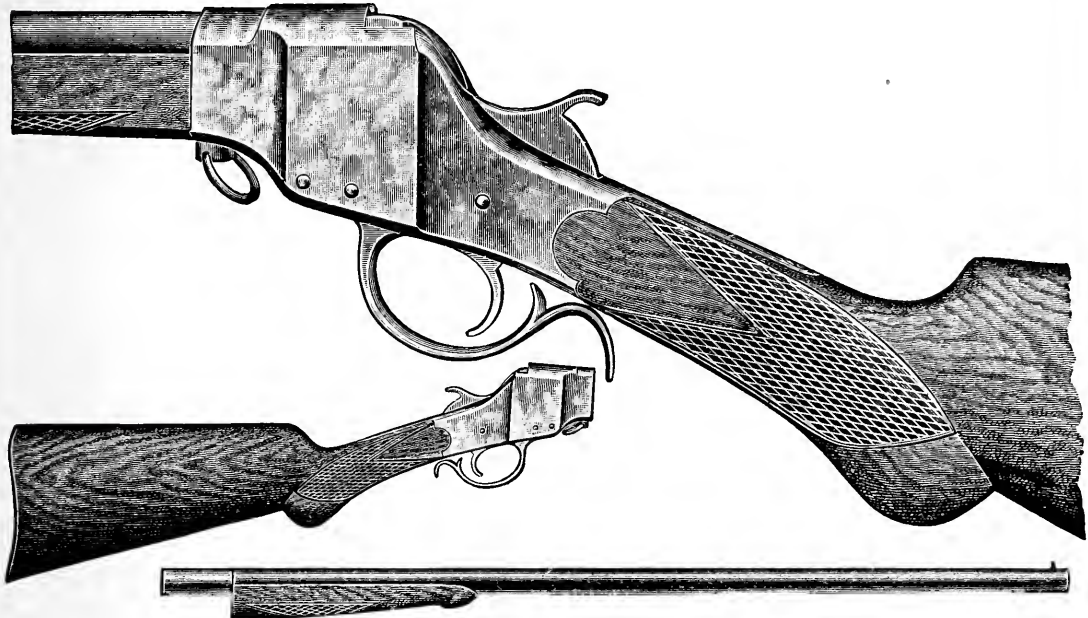

Our "Lever Action" has more friends than any single gun made, has stood the test of fifteen years' continued approval. Simple, durable and reliable, 12 and 16 gauge blued steel barrel..... **\$8.00**



Our new model top snap action, combining all up-to-date features of a modern gun, including patent compensating snap fore end. Automatic shell ejector, **Full Choke Bored.** 12, 16 and 20 gauge decarbonized steel barrel..... **\$9.00**
12 and 16 gauge Stubbs twist steel barrel..... **\$10.00**

We will ship, all charges prepaid, on receipt of remittance with order, to any express office in the U. S. A.

The Hopkins & Allen Arms Co.,
NORWICH, CONN., U. S. A.

STILL ANOTHER GREAT OFFER

Send me 25 yearly subscriptions to
RECREATION and I will send you

A Grade O Syracuse Gun

Listed at \$30.

I have contracted for 20 of these
guns at a price which enables me to
offer them as above, and they will
doubtless all be taken within the
next three months.

If you want one of the Guns get a move on you

Sample copies of RECREATION
for use in canvassing furnished on
application

RECREATION, 23 W. 24th Street, New York

Guaranteed Not to Shoot LooseOne of the 9**“SYRACUSE”****Built for Business**

DAMASCUS BARRELS

AUTOMATIC EJECTOR

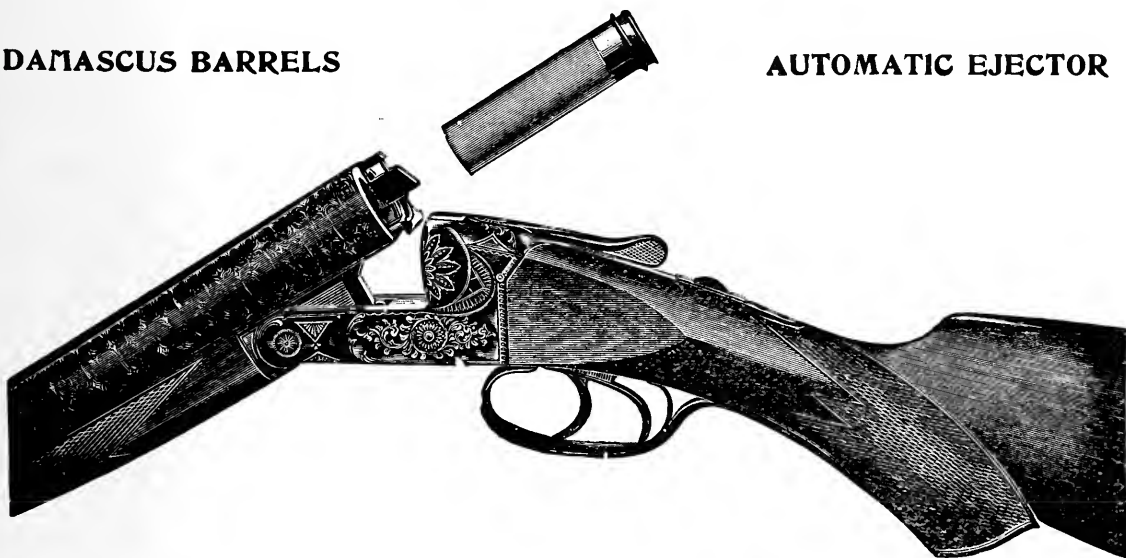
GRADE 3 EJECTOR**\$60 LIST**

In presenting this gun to your notice, we feel that it is the best value for the money that has ever been offered.

Excellent Damascus barrels, carefully selected, and bored by the particular method that has gained for the “Syracuse” the reputation of being the Hardest Hitting gun made. Stocked with Imported Walnut, Full Pistol Grip, handsomely checkered.

Engraving is hand cut, and gives that finishing touch that proclaims quality.

MADE IN 20, 16 OR 12 GAUGE

SYRACUSE ARMS CO. SYRACUSE, N.Y.



Thousands Get Well Without Risking a Penny

They write for my book—and I send it.
I supply them my help on trial.
They take it a month at my risk.

I'll do that for You

Simply send me this coupon, or write me a postal, stating the book you need.

Then I will mail you an order on your druggist for six bottles Dr. Shoop's Restorative. You may take it a month on trial. If it succeeds, the cost is \$5.50. If it fails, I will pay the druggist myself. And your mere word shall decide it.

That is the offer which hundreds of thousands have accepted, and 39 out of 40 have paid for the medicine gladly, because they were cured.

There is scarcely a neighborhood in America without its men and women whom my Restorative made well.

On Jan. 11, 1903, I published in all the Chicago papers the names and addresses of one thousand people in that city alone whom my Restorative had cured in just the past six months.

Do you believe that any other remedy ever cured one thousand chronic cases in one city in one-half year?

Won't you test the remedy which did that, when I promise to pay the whole cost if it fails?

This is How I do it:

I have spent a lifetime in learning how to strengthen *inside* nerves. I have learned how to bring back the only power that operates the vital organs.

I don't doctor the weak organ itself. I might as well doctor a weak engine to make it strong. I give the organ more power—more nerve power. I give it the strength to do its duty.

My Restorative does that always, and there is nothing more that medicine can do. Unless there is a cause like cancer my Restorative will cure. And conditions that it can't cure are beyond the reach of medicine.

When you are cured you will keep my Restorative in the house for little troubles, and to prevent these serious troubles hereafter.

Cut Out This Coupon

For we all resolve to send for something, but forget. Mark the book desired and mail this with your name and address to

Dr. Shoop, Box 214, Racine, Wis.

Book 1 on Dyspepsia.

Book 4 for Women.

Book 2 on the Heart.

Book 5 for Men (sealed).

Book 3 on the Kidneys.

Book 6 on Rheumatism.

Mild cases, not chronic, are often cured by one or two bottles. At all druggists.

U.M.C.

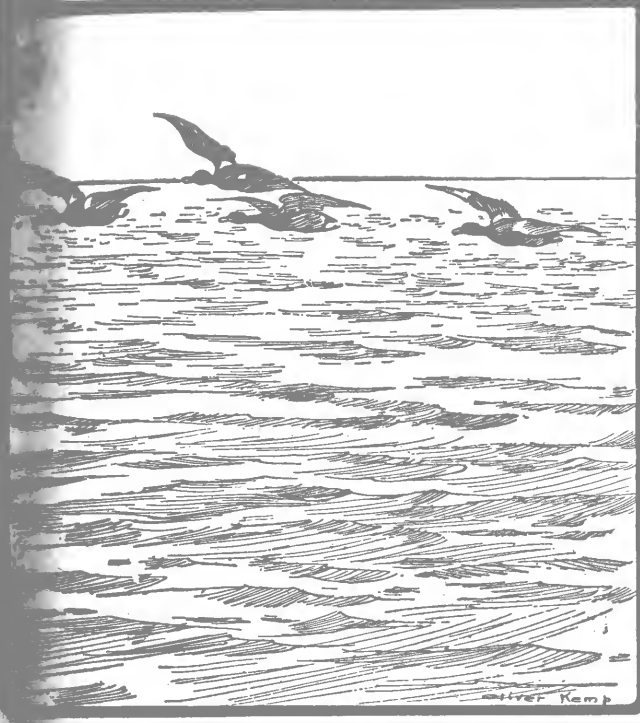

WITH U. M. C. SHOT SHELLS

there are no annoying mis-fires.
Holding right means "dead duck."

Specify New Club, Nitro Club and ARROW. These shot shells have the experience of 35 years behind them. They are the "satisfactory" kind.

The Union Metallic Cartridge Company,
BRIDGEPORT, CONN.
Agency 313 Broadway, New York City.

FINE GUNS

OUR SPECIALTY

All the Prominent
English and
American Makes.

SCOTT'S MONTE CARLO

Automatic Ejector Hammerless,

Established
1826

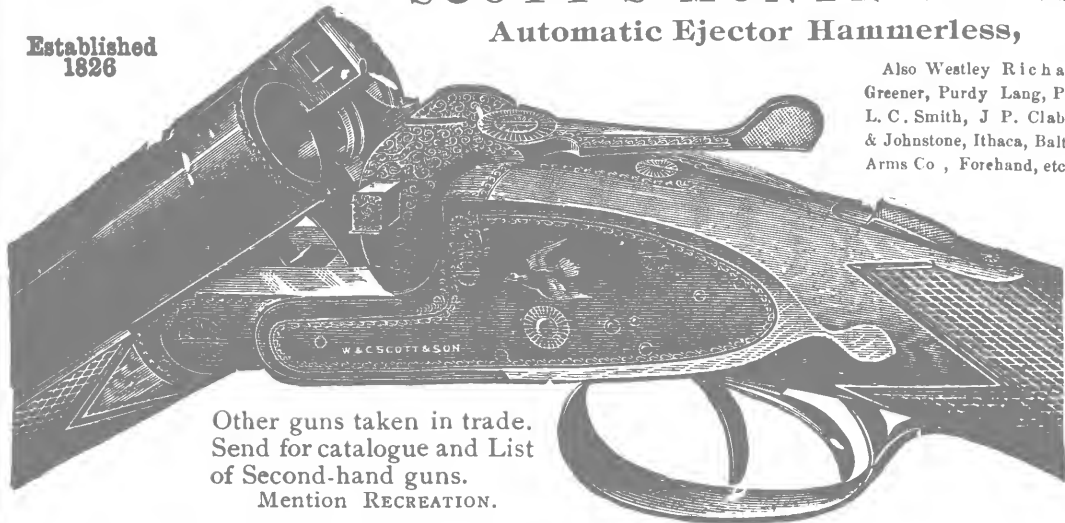

Also Westley Richards,
Greener, Purdy Lang, Parker,
L. C. Smith, J. P. Clabrough
& Johnstone, Ithaca, Baltimore
Arms Co., Forehand, etc

Other guns taken in trade.
Send for catalogue and List
of Second-hand guns.
Mention RECREATION.

SWEDISH LEATHER JACKETS

For Duck Shooting.

Soft as Kid.

Finest Quality, \$18.00

We take the entire product of the manufacturers of above Finest Jackets and this make cannot be obtained elsewhere in the United States

Gun Repairing

BY FIRST-CLASS GUN REPAIRERS
RESTOCKING, BROWNING, Etc., Etc.

Send for Catalogues

WM. READ & SONS,

107 Washington Street, BOSTON, MASS.

The Old Gun House. Established 1826

20th Century Limited
 20 HOUR TRAIN to Chicago.
 New York Central and Lake Shore.



SAVAGE RIFLES

FOR ALL KINDS OF SHOOTING

If you contemplate a hunt after big game during the coming season or seek pleasure on the shooting range, the fire-arm selected must contain certain features to insure success. Do not mar sport by the escape of wounded game or spoil your score by a poorly shooting barrel.

Savage Hammerless Repeaters are furnished from a 22 caliber to the most powerful hunting loads and stand for all that is best in a modern reliable fire-arm.

Ask the man who owns one.

Our new catalogue (G.) is of great interest to hunters and target shooters. Mailed on request.

SAVAGE ARMS COMPANY

UTICA, N. Y., U. S. A.

French Hypnotism

Dr. Berillon makes Patients leave off Coffee Entirely.

In Paris the clinique of Dr. Berillon, the famous French hypnotist of the Rue St. Andre-des-Arts, where hypnotism is employed in the cure of various diseases, is one of the interesting sights of the modern world of Science.

Some of the cures smack of the miraculous and the ordinary observer can comprehend nothing of the why and wherefore.

It is noticeable that Dr. Berillon instructs his patients to "leave off coffee entirely"—a most important step in the cure of any disease. Many people are steadily and surely forced into disease by coffee.

POSTUM FOOD COFFEE has made the way easy for those who would break away from coffee. When boiled full fifteen minutes it is delicious, heavy with food value, a powerful rebuilding agent. It knocks down the ill coffee has set up. If you would be well it is worth your thought.

There is a reason.



DENTIST
OF
EMMENT
DENTIST

I HAVE MADE A CAREFUL
CHEMICAL ANALYSIS OF

Serravallo's

for the Teeth

AND FIND NOTHING VENOMOUS
OR OBJECTIONABLE IN ITS COMPOSITION.

Justus G. White, M.D.
Analytical Chemist

FOR TWO SCORE YEARS AND TEN

gentle Americans have cared for
their teeth with Serravallo's
oil or other poisonous substances

BE THE USE OF

SERRAVALLO'S

Yose

PIANOS have been established over 50 YEARS. By our system of payments every family in moderate circumstances can own a YOSE piano. We take old instruments in exchange and deliver the new ones in your home free of expense. Write for catalogue and terms.

YOSE & SONS PIANO CO., 200 South St., Boston, Mass.

BASS FISHING IN THE NORTH POTOMAC; BY ALEXANDER HUNTER

RECREATION

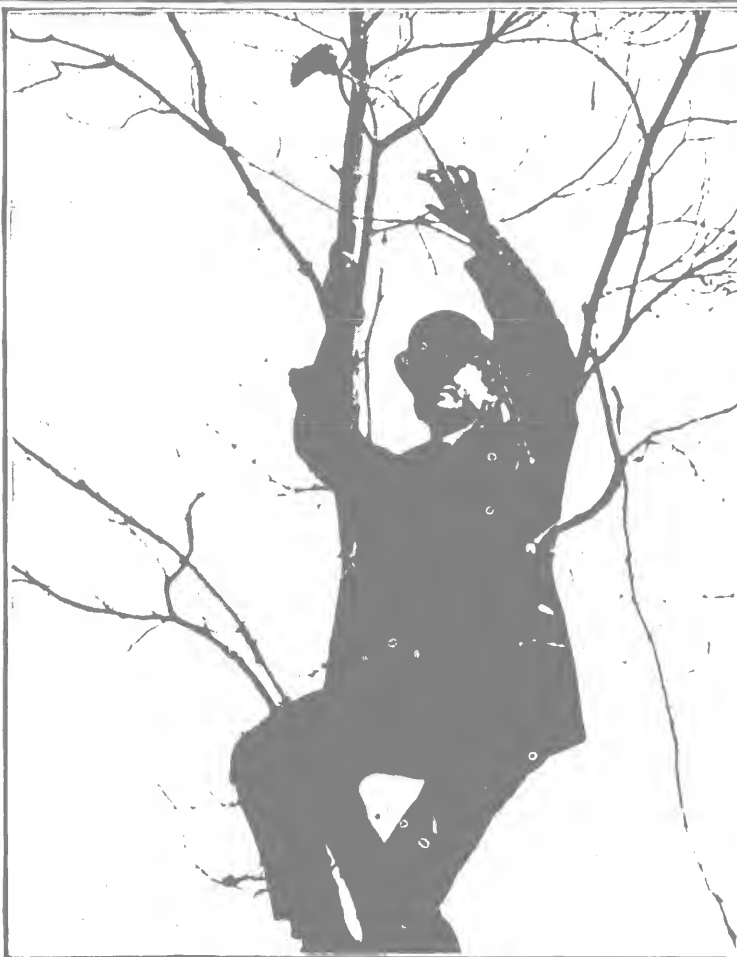
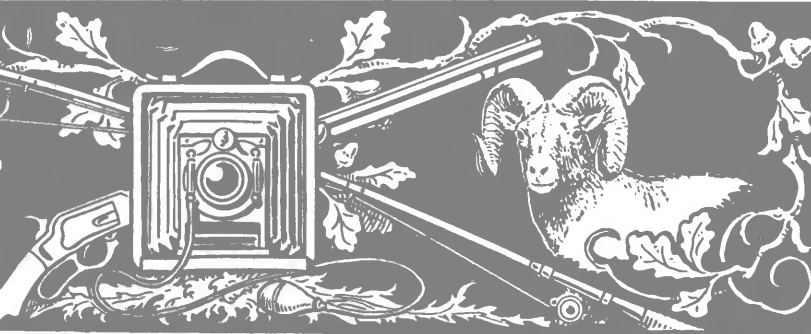

AMATEUR PHOTO BY R. H. DEEBE.

ALMOST IN REACH.

One of the 18th Prize Winners in RECREATION'S 7th Annual Photo Competition.

PUBLISHED BY G. O. SHIELDS (COQUINA)
23 WEST 24TH ST., NEW YORK

OFFICIAL ORGAN OF THE LEAGUE OF AMERICAN SPORTSMEN

How the Deacon Became a Horse Jockey

By L. B. ELLIOTT, Illustrated with photos by the author.

THE WISDOM OF SOLOMON

HAS NEVER BEEN DENIED. HE PROCLAIMED

“ Good Wine is Life to the Body ”

WE invite your confidence with the assurance that we will not attempt to deceive you. **We are Not Distillers**, though we do distribute the entire output of one distillery.

We are Importers of many of the good varieties of Wines, Spirits and Cordials, the product of England, Germany, France, Italy and Spain.

We are Rectifiers, Blenders or Compounders, as you please. Choose your own name for that department of our line of business that so many people foolishly jeer at, so also is your Apothecary, your Confectioner and your Cook. How often do you receive one cow's milk.

We are Wholesale Dealers. We confess to belonging to that class of middle men, who are supposed to make enormous profits. Searching for our share of those profits the commercial telescope comes always to our eye wrong end to.

We are Retailers. We claim fellowship with that patient, long suffering, much abused, overtaxed, unprotected class of retail dealers, who fill the gap between the unreasoning Consumer and the unreasonable Total Abstainer.

We are one of the few houses in our line that can supply a patron with a glass of beer or two thousand barrels of whiskey of one inspection of a single brand.

If as **Importers, Blenders, Wholesale and Retail Dealers** we make Four profits, we will give you Three of them on any purchase you make of us. We will retain only a reasonable reward for labor, and earnestly and honestly applied energy, and a fair return on capital invested.

If you accept our offer you will surely receive the Best and the Most for your money that ever came to you from any similar proposition.

REGISTERED AND SPECIAL BRANDS

	Per Gal.		Per Gal.
Holiday Pure Rye -	4.00	Old Gold Bourbon -	\$4.00
(Eleven Years Old)		(Eleven Years Old)	
Hermitage Rock & Rye	4.00	Jewel Port -	4.00
Superior		From Silva & Cosens, Oporto. A	
Five pounds of rock candy crystals		choice product of the grape.	
to each gallon of seven year old		Rainbow Brandy V.O.	4.00
Hermitage Rye whiskey, is used in		The product of one of the best Ameri-	
the preparation of our Celebrated		can Vineyards, with all the medici-	
Rock and Rye.		nal qualities of French Brandy.	
Bon Ton Cocktails -	4.00	Jupiter Gin -	4.00
Martini, Manhattan, Vermouth,		From the Swan Distillery, Schiedam,	
Whiskey, Tom Gin and Holland		Holland, where Good Gin comes	
Gin. Carefully prepared from the		from. Tastes differ. Many people	
choicest materials, perfectly blended.		appreciate Good Gin. Jupiter is the	
Ruthven Sherry -	4.00	best the world affords.	
From Duff, Gordon & Co. Warranted		Medford Old Rum -	4.00
twenty years in the wood before		From Daniel Lawrence & Sons, Med-	
bottling. Rich and fruity.		ford, Mass.	

On receipt of your order with \$6.00, we will ship 6 full quarts, assorted to suit, transportation charges prepaid, to any railroad point in the United States where the charges for transportation do not exceed \$2.00. You cannot afford to let this chance go by. You never before had as good an offer.

Remit cash in registered letter or by express company or P. O. money order.

References: Any bank in Boston. Any mercantile agency or any distiller of importance in the United States.

W. H. JONES & CO., Hanover & Blackstone Sts.,
BOSTON, MASS.

ESTABLISHED 1851

RECREATION

Copyright, December, 1902, by G. O. Shields

A Monthly Magazine Devoted to Everything the Name Implies

\$1.00 A YEAR.
10 CENTS A COPY.

G. O. SHIELDS (COQUINA),
Editor and Manager.

23 WEST 24TH STREET,
NEW YORK

CONTENTS OF THIS NUMBER

PAGE

The Streaked Demon Alighted Beside the Astonished Terrier.....	FRONTISPIECE
Chum. Illustrated	W. S. CROLLY 331
Bass Fishing in the North Potomac	ALEXANDER HUNTER 337
How the Deacon Became a Horse Jockey. Illustrated	L. B. ELLIOTT 341
Oh! My Heart Is Hungry for the Hills. Poem.....	ALFRED I. TOWNSEND 345
Spring Madness.....	TEN SLEEP 347
A Place Just West of Kansas. Poem	FRANK WHITE 348
Canoeing on the Temagaming.....	C. E. T. 350
Casualties Among Animals. Illustrated	J. A. LORING 351
A New Mexico Sand Storm	HARRY SUYDAM 356
The Judge and I.....	MENOQUET 357
On the Manistee River. Illustrated.....	A. ST. J. NEWBERRY 359
From the Game Fields.....	361
Fish and Fishing	371
Guns and Ammunition	375
Natural History.....	381
The League of American Sportsmen	385
Forestry.....	389
Pure and Impure Foods.....	392
Book Notices.....	395
Publisher's Notes.....	396
Editor's Corner	397
Amateur Photography.....	402

Entered as Second-Class Matter at New York Post-Office, Oct, 17, 1894.



WELL DRESSED MEN

appreciate the great utility and
comfort of

WASHBURNE'S PATENT SCARF HOLDER

Little but effective. It cannot come loose or
ride up. Instantly attached and detached.

Scarf Holder - - - 10 Cents } Sent
Cuff Holders - - - 20 " } Pre-
Key Ring and Chain - 25 " } paid.

They never come loose. A tiny lever with
a bulldog grip. Illustrated Catalogue Free.

AMERICAN RING CO., Dept. 44
Waterbury, Conn.

Sore Throat

Hoarseness, Quinsy, Tonsillitis
Laryngitis and other throat
troubles quickly relieved
and promptly cured
by the use of

Hydrozone

This scientific germicide is used and
endorsed by leading physicians every-
where. It is *absolutely harm-
less*, yet a most powerful healing
agent.

By killing the germs that cause
these diseases, without injury to the
tissue, Hydrozone cures the patient.
Sold by Leading Druggists. If not
at yours, will send bottle, prepaid,
on receipt of 25 cents.

Prof. Charles Marchand

(Dept. F-59) Prince Street, NEW YORK



CANOES
GUNS · FISHING TACKLE ·
CAMPERS' AND EXPLORERS' OUTFITS.
ABERCROMBIE & FITCH 314 ~ 316 BROADWAY NEW YORK

20TH CENTURY LAUNCHES



STEAM YACHTS

SAIL YACHTS

ROW BOATS

CANOEES

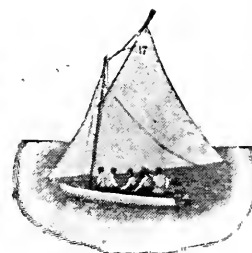
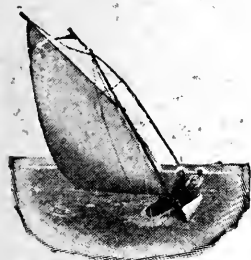

The Ideal Gentleman's Pleasure Craft used at the Pan-American Exposition because they were the best. Elegantly finished, simple, safe, reliable, and speedy. 15 ft. Fishing Launch, \$150. 16 ft. Family Launch, \$200. 35 ft. Cabin Launch, \$1,500. Send 10 cents for 80-page illustrated catalogue giving the truth in detail about the best boats built. Address

RACINE BOAT MFG. CO.

RIVERSIDE, RACINE, WIS.

“ Nothing so Rare as Resting on Air.”

The N. Y. Yacht Club

entire fleet of 25-footers, designed by

Mr. CHARLES F. HERRESHOFF

18 Broadway, New York City
and now under construction by

The Holmes Shipbuilding Company, West Mystic, Conn.

will be equipped throughout with

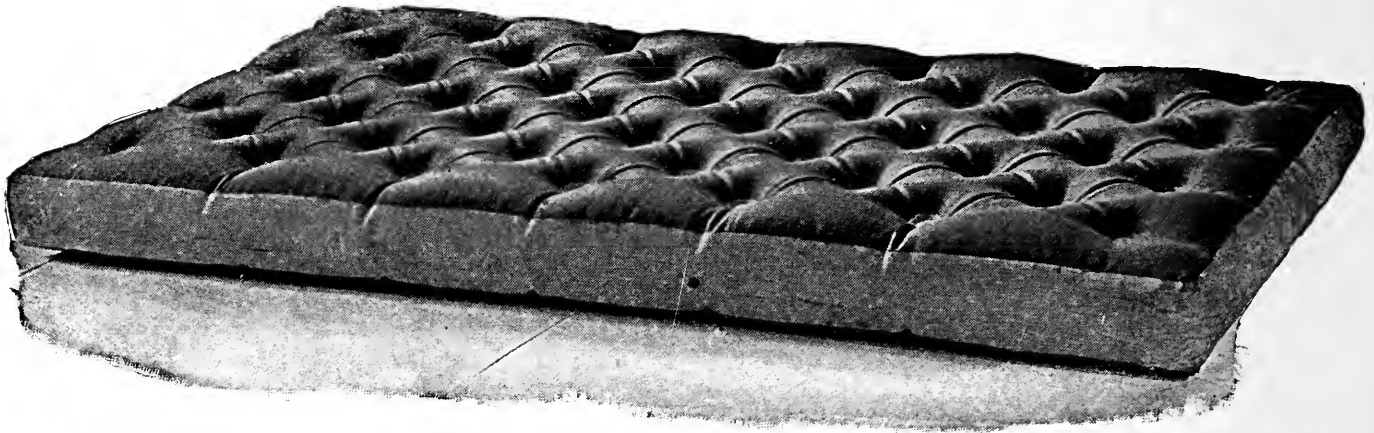

Pneumatic Cushions

Pneumatics have all the qualifications of every other kind of CUSHION or MATTRESS, with many additional recommendations of their own.

We own and control every practical patented device for "staying" Pneumatic Goods. Any other that is offered you is either an infringement on our "stay" or a crude iron makeshift.

Pneumatic Mattress and Cushion Co.

2 R. South Street, New York City

Mattress makers everywhere are paying the tribute of imitation to the

Ostermoor

mattress, but its qualities elude them—they can't make Ostermoor Patent Elastic Felt, because it is our patent and if we catch them selling their worthless "cotton pickings" or "cotton batting" as FELT, we commence legal proceedings against them at once. It's not FELT if it's not an OSTERMOOR. Our name is on every genuine mattress.

**Price \$15. Express Prepaid
30 Nights' Free Trial**

You can have an OSTERMOOR MATTRESS, sleep on it 30 nights, and if it is not better than any other mattress you have ever used—if it is not all you even HOPED for, return it at our expense and your money will be immediately refunded without question. What more can we do to convince you?

Please do not consider any longer the purchase of an out-of-date hair mattress. Nobody "who is anybody" buys hair nowadays. A hair mattress is a tick *stuffed* with *animal* hair often swarming with disease germs. It gets lumpy and needs constant renovation at great expense. Each Ostermoor mattress is built—not stuffed—Hand-laid sheets of snowy whiteness, each the full size, are carefully compressed into the tick. The Ostermoor Patent Elastic Felt is purity itself, germ-free and vermin-proof. Ostermoor mattresses *cannot* get lumpy; never need renewing; an occasional sun-bath is all they require. The tick can be taken off and washed whenever soiled.

Send for Our Handsome 96-Page Book Free (See Coupon)

whether you want a mattress or not. There is no other mattress as good as the "Ostermoor," and we want you to know why—we *challenge comparison*. Our book, "The Test of Time," gives testimonials from such men as Rev. Dr. MacArthur and George H. Daniels, whom you *must* believe—even if you think *we exaggerate*. It illustrates the various uses to which the Patent Elastic Felt is put—Pillows, Window Seat Cushions, Boat Cushions and Church Cushions, etc.

Cut along this line. Or, just write your name and address on a postal—we will understand.

Date.....

OSTERMOOR & Co.,
114 Elizabeth Street, New York:

Please send me your free book,
"The Test of Time," without obligation
in any way on my part.



Name

Address.....

State.....

MAIL THIS TO-DAY
To-morrow never comes

Decorate Your Den

With a set of the most beautiful
Hunting and Fishing Pictures
 ever made.

15 Plates. Size for Framing, 18 x 24 inches

SUBJECTS:

ELK HUNTING	SALMON FISHING	} HY. SANDHAM
MOOSE HUNTING	TROUT FISHING	

MALLARD SHOOTING — **BLACK BASS FISHING** — C. E. DENTON

TARPON FISHING — **BLUE FISHING** — FRED. S. COZZENS

ANTELOPE HUNTING — **GOOSE SHOOTING** — FRED REMINGTON

GROUSE SHOOTING — **WILD TURKEY HUNTING** — R. F. ZOGBAUM

MUSKALONGE FISHING — F. H. TAYLOR

DEER HUNTING — A. B. FROST

ROCKY MOUNTAIN SHEEP HUNTING — E. KNOBEL

These 15 plates are lithographed in the true colors of nature and altogether make one of the finest series of pictures of outdoor sports ever published.

ORIGINALLY ISSUED AT \$50 A SET

I have bought the last of them and can furnish a complete set for 15 yearly subscriptions to RECREATION,

Or will Sell at \$10 a Set

I also have enlargements of the following photographs:

ROCKY MOUNTAIN GOATS

Published on pages 90, 91, 92, and 93 of the February issue of RECREATION,
 \$5 a set.

WOOD DUCK SHOOTING

Published on page 95 of the February issue of RECREATION, \$1.50 each.

Address: RECREATION, 23 West 24th Street, New York City

May in the Laurentians.



Lake Superior (St. Faustin, P. Q.)

SHOULD you have fished Laurentian waters, you may skip this page for you know, already, they yield the best early trout fishing. But if the delights of a first visit are as yet in store, be assured that nowhere within easy reach of the big cities of the United States may better sport be found, a more exhilarating air breathed, or such gloriously wild, satisfying, scenery enjoyed.

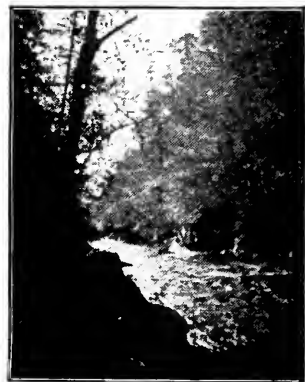

Gorge of the Devil's River.



Notch of Devil's River.

where the deer drink, the ducks rear their young unmolested, and in which lusty trout leap madly at the fly. ❀ ❀ ❀ ❀ ❀ ❀



Trembling Mountain.

For additional information apply to any agent of the

CANADIAN PACIFIC RAILWAY,

or to

ROBERT KERR, Passenger Traffic Manager. MONTREAL.



POCONO MOUNTAINS

**Lackawanna
Railroad**

A region of woodland and water, 2,000 feet above sea level in northeastern Pennsylvania; dry, cool and invigorating; splendid roads; modern hotels. A beautifully illustrated book describing this region and containing a fascinating love story entitled "For Reasons of State," sent on receipt of 5 cents in postage stamps. Address T. W. LEE, General Passenger Agent, Lackawanna Railroad, New York City.



FISHING on the Picturesque Erie

THE best fresh water fishing
in the vicinity of New York
is to be found along the lines of

THE ERIE RAILROAD

in Orange and Sullivan Counties, New York; and Pike
and Wayne Counties, Pennsylvania.

A FEW OF THE WATERS

GREENWOOD LAKE, 45 miles from New York, for **Black Bass** and
Pickerel. Fine sport throughout the season.

GLENMERE LAKE, 3 miles from Chester, N. Y., 56 miles from New
York, for fine **Pickerel** fishing in May and June; also good **Black
Bass** fishing in season.

LAKE MOMBASHA, Round Lake, and Long Lake, near Monroe,
N. Y., 50 miles from New York, **Black Bass** and **Pickerel**.

DELAWARE RIVER, Superb **Black Bass** fishing at **Pond Eddy,**
Shohola, Lackawaxen, Narrowsburg, Cochocton, Callicoon,
Long Eddy, Lordville, Hancock and Deposit. The **Black Bass**
of the Delaware are the gamest of all.

Trout Streams too numerous to mention.

“FISHING ON THE PICTURESQUE ERIE”

A beautifully illustrated guide book of 88 pages (with large map), containing interesting
articles on the fresh water game fish, and a complete directory of the lakes, rivers and
streams along the ERIE, easily reached from New York, may be obtained from any Erie
Ticket Agent in New York or Brooklyn, or by sending 3 cents in stamps for postage to

D. W. COOKE,

General Passenger Agent,
New York

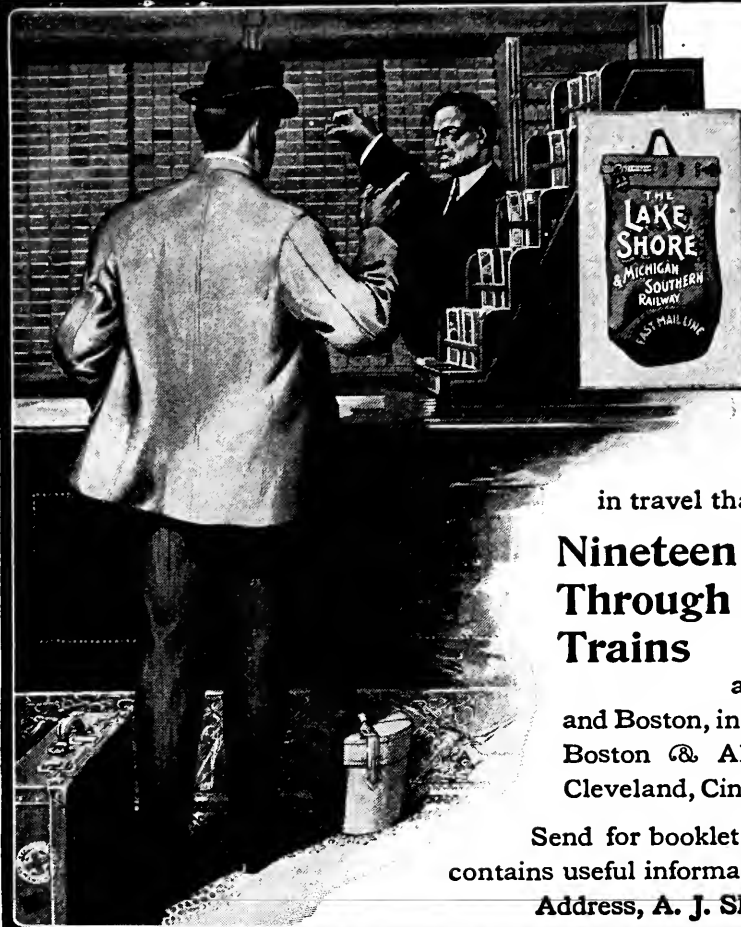

Don't Forget!

WHEN YOU BUY a ticket don't forget to tell the ticket agent plainly that you wish it over the Lake Shore & Michigan Southern Railway. You will secure the best

in travel that money can buy.

Nineteen Through Trains

In daily service over the Lake Shore & Michigan Southern Railway between the cities of Chicago and Toledo, Cleveland, Buffalo, St. Louis, Indianapolis, Cincinnati, Pittsburg, New York and Boston, in connection with the New York Central, Boston & Albany, Pittsburg & Lake Erie and Cleveland, Cincinnati, Chicago & St. Louis Railroads.

Send for booklet, "Privileges for Lake Shore Patrons," contains useful information; also "Book of Trains."

Address, A. J. SMITH, G. P. & T. A., Cleveland, Ohio

"GREATEST SUCCESS OF ITS AGE."

THE FOUR-TRACK NEWS

AN ILLUSTRATED MAGAZINE
OF TRAVEL AND EDUCATION

Published Monthly by
GEORGE H. DANIELS,
General Passenger Agent,

NEW YORK CENTRAL
& HUDSON RIVER R. R.

THE FOUR-TRACK NEWS will be sent free to any address in North America for 50 cts. a year; foreign countries \$1.00. Single copies 5 cents. Sold by all newsdealers. Address George H. Daniels, General Passenger Agent, Grand Central Station, New York.

"Big Four"

The
World's Fair Route

From the

Leading Cities of
Ohio, Indiana
and Illinois

To

St. Louis

Write for Folders.

Warren J. Lynch; W. P. Deppe,
Gen'l Pass. Agt. Ass't Gen'l P. A.
CINCINNATI, OHIO.

 Santa Fe

Cheap Trips California

\$50 round trip Chicago to Los Angeles
and San Francisco.

May 3, also May 12 to 18.

Good on THE CALIFORNIA LIMITED and other trains.
Special service account Presbyterian General Assembly.

\$33 one way Chicago to California, for
colonists. Until June 15.

In tourist sleepers and chair cars. Low rates from
East generally. See Grand Canyon of Arizona en
route. Ask for particulars.

General Passenger Office, A. T. & S. F. R'y, Chicago.

Santa Fe All the Way

 WABASH

WABASH

The Luxury of Travel

Traveling by Daylight
on the

WABASH LINE

Affords all the comforts to be
had in the most luxurious
homes or in the best of hotels.

The Parlor and Observation-
Cafe Library Car features on
the Wabash trains, together
with the Free Reclining Chair
Cars and Dining Cars, have
become widely known and very
popular. Uniformed attend-
ants are in charge.

THROUGH CARS are
run between St. Louis and Chi-
cago, Kansas City, Omaha,
New York, Boston, Los An-
geles, San Francisco, Denver,
Portland, Ore., Minneapolis
and St. Paul; between Chicago
and Buffalo, New York, Boston
and Montreal; between Kansas
City and Buffalo.

For information as to rates,
routes, etc., address

C. S. CRANE,

Gen'l Pass'r and Ticket Ag't.,
St. Louis, Mo.



1000 Island House

In the midst of the "Thousand Islands," the so-called "Venice of America," and really the most charming and delightful Summer Resort on the Continent.

Send me two 2-cent stamps and I will send you a beautifully illustrated guide book. Mention RECREATION.

O. G. STAPLES, *Owner and Proprietor*

Alexandria Bay, N. Y.



HOTEL CHAMPLAIN

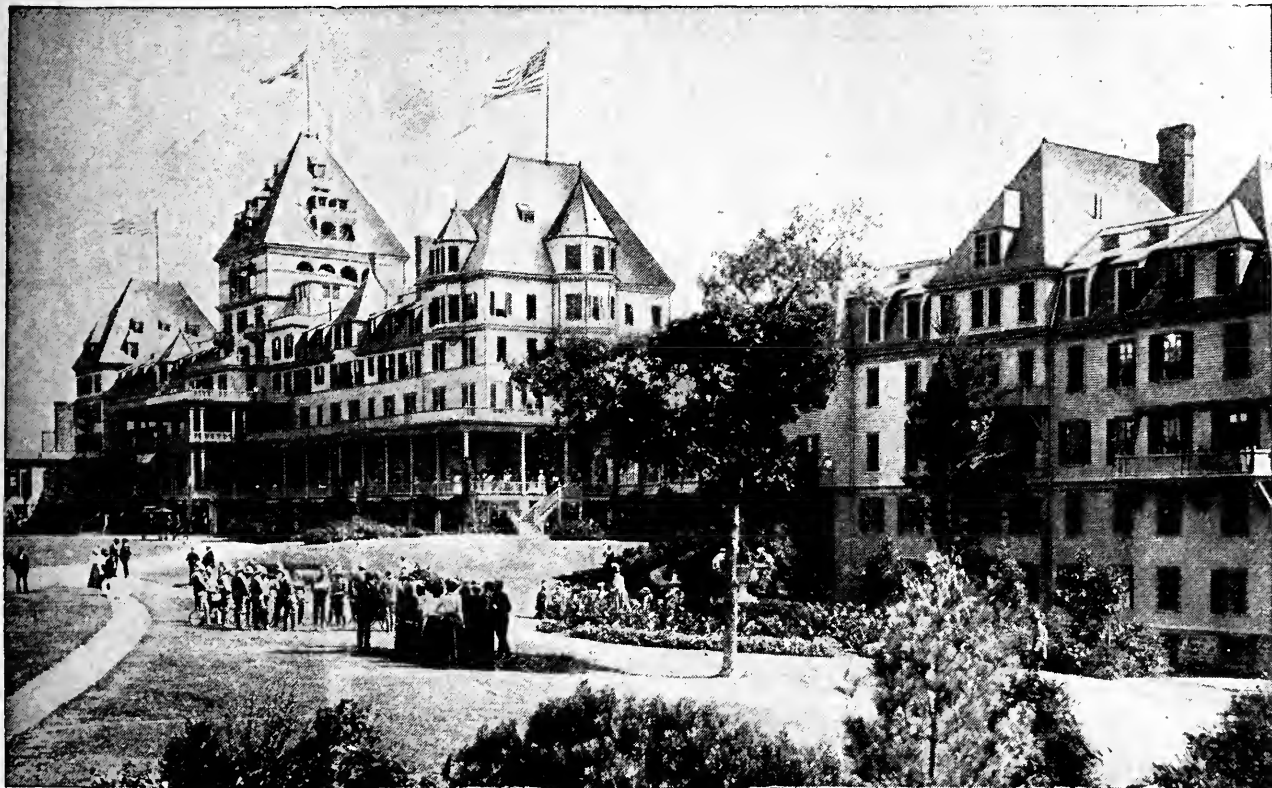

Bluff Point near Plattsburg, N. Y.



THE PEERLESS LAKE AND MOUNTAIN RESORT OF THE ADIRONDACKS



Known everywhere as one of the most magnificent summer hotels in America.

Located on a bold eminence on the shore of Lake Champlain in the center of a forest park of 450 acres.

Superb views of the Lake and Green Mountains of Vermont to the East and the highest peaks and ranges of the Adirondacks to the West.

GOLF on full-length 18-hole course, kept in pink of condition. Attractive clubhouse with all conveniences.

HOTEL CHAMPLAIN is three miles from Plattsburg, N. Y., on main line Delaware & Hudson R. R., and is reached in through Pullmans.

BOATING, FISHING, and ideal fresh water bathing, complete facilities. Splendid roads for automobiling.

A beautiful booklet of illustrations sent upon request.

E. L. BROWN, Mgr., Until July 1st care Lincoln Safe Deposit Co., 42d St., New York

"FOR 34 YEARS A STANDARD PIANO."

THE WING PIANO

YOU NEED THIS BOOK IF YOU INTEND TO BUY A PIANO. A book —not a catalogue—that gives you all the information possessed by experts. It makes the selection of a piano easy. If read carefully, it will make you a judge of tone, action, workmanship, and finish; will tell you how to know good from bad. It describes the materials used; gives pictures of all the different parts, and tells how they should be made and put together. It is the only book of its kind ever published. It contains 116 large pages, and is named "The Book of Complete Information About Pianos." We send it free to anyone wishing to buy a piano. Write for it.

SAVE FROM \$100 TO \$200 We make the WING PIANO and sell it ourselves. It goes direct from our factory to your home. We do not employ any agents or salesmen. When you buy the WING PIANO you pay the actual cost of construction and our small wholesale profit. This profit is small because we sell thousands of pianos yearly. Most retail stores sell no more than twelve to twenty pianos yearly, and must charge from \$100 to \$200 profit on each. They can't help it.

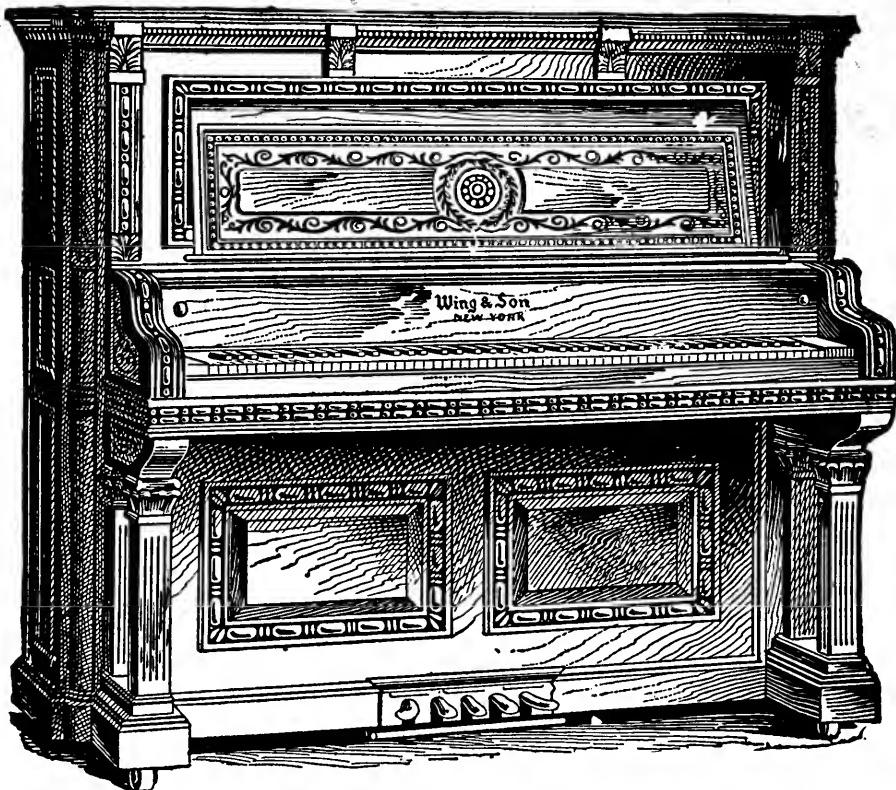

A Wing style—45 other styles to select from.

SENT ON TRIAL WE PAY FREIGHT. NO MONEY IN ADVANCE. We will send any WING PIANO to any part of the United States on trial. We pay freight in advance and do not ask for any advance payment or deposit. If the piano is not satisfactory *after twenty days' trial in your home, we take it back entirely at our expense.* You pay us nothing unless you keep the piano. There is absolutely no risk or expense to you.

Old instruments taken in exchange.

EASY MONTHLY PAYMENTS.

INSTRUMENTAL ATTACHMENT A special feature of the Wing Piano; it imitates perfectly the tones of the mandolin, guitar, harp, zither and banjo.

IN 34 YEARS 33,000 PIANOS We refer to over 33,000 satisfied purchasers in every part of the United States. WING PIANOS are guaranteed for twelve years against any defect in tone, action, workmanship, or material.

WING ORGANS Are just as carefully made as Wing Pianos. They have a sweet, powerful, lasting tone, easy action, very handsome appearance, need no tuning. Wing Organs are sold direct from the factory, sent on trial; are sold on easy monthly payments. For catalogue and prices write to

WING & SON, 226 and 228 East 12th St.,
NEW YORK.

1868—35th Year—1903.

A SUMMER PARADISE

**GRAND
TRUNK
RAILWAY
SYSTEM**

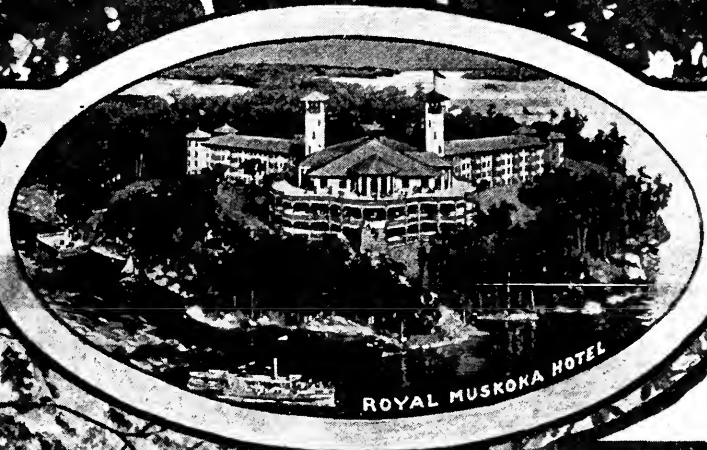

ROYAL MUSKOKA HOTEL



HIGHLANDS OF ONTARIO

1000 FEET ABOVE SEA LEVEL.

**MOST CHARMING SUMMER
RESORTS IN AMERICA**

INCLUDING

MUSKOKA LAKES.

LAKE OF BAYS

MAGNETAWAN RIVER

**30,000 ISLANDS OF GEORGIAN
BAY**

KAWARTHA LAKES

LAKES SIMCOE

AND COUCHICHING

LAKE NIPISSING

AND FRENCH RIVER

EASY OF ACCESS. PERFECT IMMUNITY FROM MALARIA.
GOOD HOTEL ACCOMMODATIONS.
RATES TO SUIT ALL POCKETS.

THE "ROYAL MUSKOKA"
FINEST SUMMER HOTEL IN CANADA.

FREE ILLUSTRATED PUBLICATIONS

CAN BE HAD FROM GRAND TRUNK RAILWAY
SYSTEM. ADDRESS NEAREST OFFICE.

Boston, Mass.	T. Wynn	236 Washington Street
Buffalo, N. Y.	Chas. L. Cook	250 Main St. (Bell's Express Bldg.)
Chicago, Ill.	J. H. Burgess	97 Mar. Agents Bldg. 111 Front Building
Detroit, Mich.	Geo. W. Watson	240 Clark St. cor. Jackson
Los Angeles, Cal.	W. H. Bullen	124 Woodward Avenue
Montreal, Que.	J. Guilford	1005 Victoria Station
New York, N. Y.	F. P. Dwyer	127 St. James Street
SAN FRANCISCO, CAL.	W. O. Johnson	127 Broadway
St. Paul, Minn.	David Brown, Jr.	111 Exchange Arcade
TORONTO, ONT.	J. B. McDonald	Union Station
	J. W. Ryder	N. W. cor. King and Yonge streets

OR TO G. T. BELL,
GENERAL PASSENGER AND TICKET AGENT.
MONTREAL, CANADA.

MENTION THIS MAGAZINE.

TAKE YOUR CHOICE

1 QUART \$1.00

4 QUARTS \$3.20

WE PAY EXPRESS CHARGES IN EITHER CASE.

Most people have either seen our announcements in the leading publications or else heard of **HAYNER WHISKEY** in some other way. Just ask a friend **WHO** is it that sells "**FOUR FULL QUARTS FOR \$3.20**" and he will say "**HAYNER.**" For years we have been telling you about the goodness of **HAYNER WHISKEY**, now we want you to **TRY** it. We are willing to lose money to get you to do so, for we know if you only try it, you will always buy it, just as our half a million satisfied customers are now doing.

HAYNER WHISKEY

TRIAL OFFER Send us \$1.00 and we will ship you in a plain sealed package, with no marks to even suggest contents, **ONE FULL QUART** of **HAYNER SEVEN-YEAR-OLD RYE**, and we will pay the express charges. When the whiskey reaches your home, try it, sample it thoroughly. Then, if you don't find it all right, perfectly satisfactory in every way and better than you ever had before or can buy from anybody else for even double the money, ship it back to us at our expense and your \$1.00 will be promptly refunded. Isn't that fair? We stand all the expense if you don't wish to keep the whiskey. **YOU** risk nothing. We ship one quart on your first or trial order only. All subsequent orders must be for at least 4 quarts at 80 cents a quart. The packing and express charges are almost as much on one quart as on four and even at \$1.00 for one quart we lose money, but we want you to try it. We would prefer to have you order 4 quarts for \$3.20 for then we would make a little profit and you would also save 80 cents. But take your choice. \$1.00 for 1 quart or \$3.20 for 4 quarts, express prepaid. Your money back if you're not satisfied. Write our nearest office **TO-DAY**.

Trial orders for Ariz., Cal., Col., Idaho, Mont., Nev., N. Mex., Ore., Utah, Wash., or Wyo., must be 1 Quart for \$1.25 by **EXPRESS PREPAID**. Subsequent orders on the basis of 4 **QUARTS** for \$4.00 by **EXPRESS PREPAID** or 20 Quarts for \$16.00 by **FREIGHT PREPAID**.

ESTABLISHED
1866.

THE HAYNER DISTILLING COMPANY,

**DISTILLERY
TROY, OHIO.**

DAYTON, OHIO.

ST. LOUIS, MO.,

ST. PAUL, MINN.,

ATLANTA, GA.,





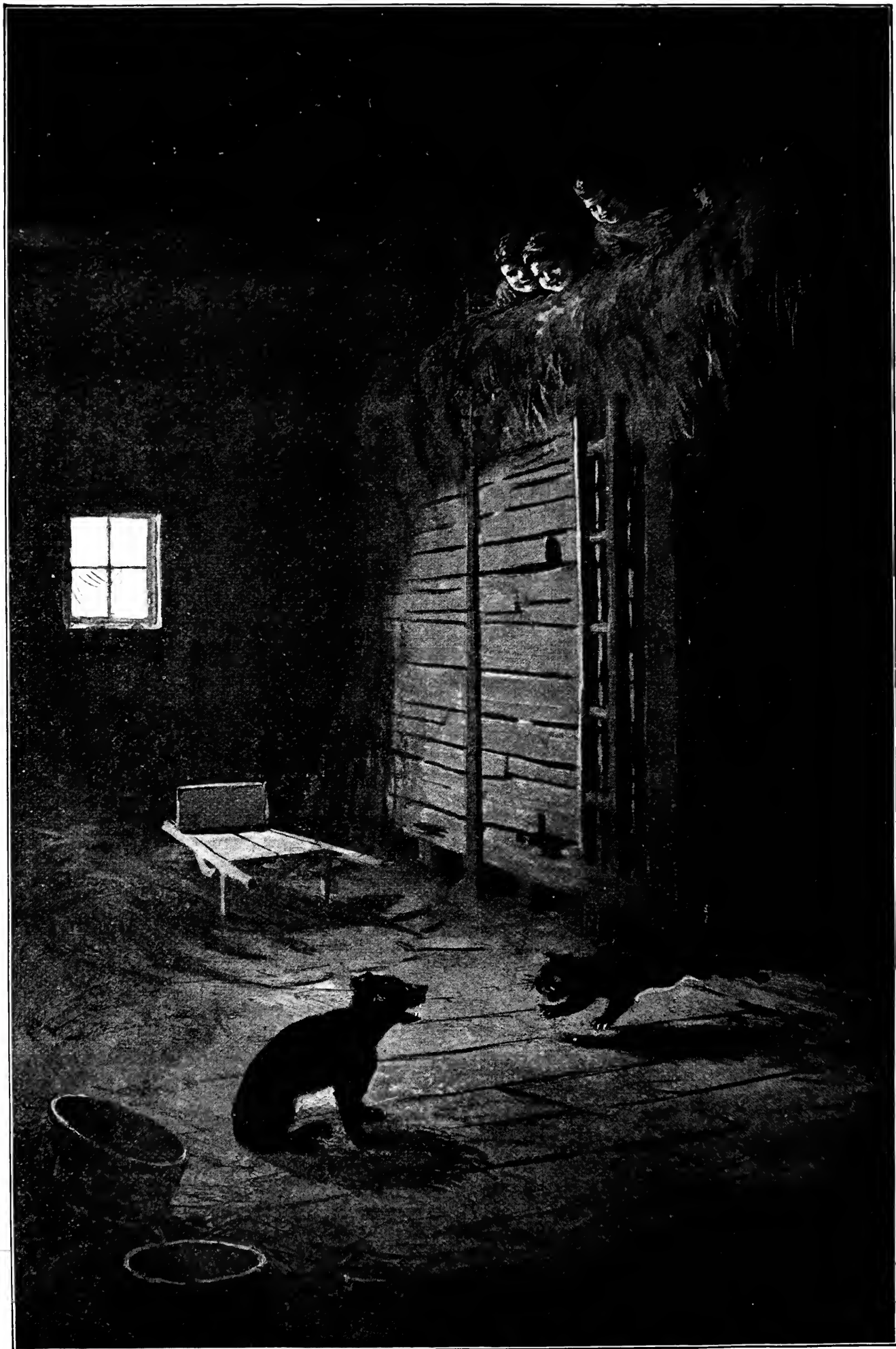

THE STREAKED DEMON ALIGHTED BESIDE THE ASTONISHED TERRIER.

RECREATION

Volume XVIII.

MAY, 1903.

Number 5.

G. O. SHIELDS (COQUINA,) Editor and Manager

CHUM.

W. S. CROLLY.

Every one in the little village detested him earnestly. He belonged to the barber, and the barber was unpopular. Chum had an abnormal appetite for kittens, the younger the better. Disdaining to argue with their more worldly wise progenitors, either meek Maria or yowling Thomas, this wholly contemptible Scotch terrier recreated himself by unhinging the spines of weak, confiding kittens. Right and left he slaughtered them: a savage rush, a protesting meow, a click, and the furry little feline lay contorting on the ground. Then Chum would scamper off, barking egotistically. Little girls developed sore eyes holding wakes over their pets; but no one ventured to interfere, or even expostulate, for the barber was a powerful lever in the village political machinery. So the carnage went on. But eventually Chum overdid the matter. In a particularly jocund mood he massacred Tillie Smith's tri-colored tiger phenomenon on her own doorstep.

While investigating the garbage tub in the rear of Mrs. Smith's yard, one morning, Chum became suddenly aware through the medium of his sixth sense that he was being observed. He looked up.

The kitten, singing like a kettle, sat on the porch watching him with innocent curiosity. Hastily bolting a strip of ham rind, he sprang at her. She fled terrified, but he caught her on the threshold. Holding the tiny feline amidships, he shook her like a dice box; but he failed to disconnect her keel. She squealed lustily for succor. Mrs. Smith burst on the scene armed

with a broom, which she swung with great strength of arm. "Oh!" she screamed, and chopped at the dog with fine precision. The straw-headed ax descended heavily and flattened Chum to the resemblance of a skin rug. The breath left his body with an expressive woof! Dropping his victim, he pattered swiftly away. Mrs. Smith, screaming at a high soprano pitch, sent after him an endless variety of feminine threats. Then she turned her attention to the kitten, noting at a glance that its case was hopeless. The terrier had killed unscientifically that time, crushing in its ribs as little boys with steel teeth crush hickory nuts. A spasm of the limbs, a tiny trickling hemorrhage; pussy was dead, dead.

Tillie, returning from school at noon, wept distractedly. Later she mopped her face and went back to school. As she left the house her teeth were set in a most resolute way. Evidently her quick brain was preparing plans for revenge. That very evening the female members of the M. E. Church Infant Class assembled in convention at Mrs. Smith's residence to discuss the tragedy and pass judgment on Chum. With entire unanimity they cast their votes: Chum must die! How to secure this result they did not exactly know. Long they wrestled with the problem, but could think of no scheme. Finally, one little maid, with a larger faith in masculine wit than the others, suggested consulting "The Kid" for advice. The company, weary of argument, approved; and a committee started to hunt him.

He was discovered in front of the grocery store, perched on a pile of boxes, recklessly eating a large, colicky looking green apple. The Kid, glorying in the spectacle of helpless righteousness bowing before potent wickedness, received them with much the same condescension shown by a successful politician to an impecunious office seeker. Indeed, despite his tender years, the Kid was a tough proposition. For several months he had been ostracized from the Sunday school, and the Board of Trustees were inclined to eject him from the district school also. His wicked pranks horrified the sober villagers. Only a week previous Farmer Grigsby surprised him in the act of dehorning a fine cow with the aid of a pocket saw. He excused himself to the angry Grigsby, pleading that he wanted a shot pouch for his air rifle! The farmer was so staggered at his frankness as to let him go, scot free. Obeying the admonitions of their parents, a select few shunned him carefully. Many others, while admiring him in secret, avoided him in public in deference to popular opinion. But a leechlike body of some half dozen kindred spirits followed him and shared his alternate triumphs and defeats. He ruled them with the genius of a born leader.

Attended by his regiment of juvenile brigands, he passed from one eclipse to another. Caned into obscurity with periodical regularity, he emerged only to shine the more brilliantly.

With an unmoved countenance the Kid listened to the girls' story of Chum's misdeeds and appeal for assistance. He waxed inwardly wrathful. So they wished help of him, did they? They were strangling their pride at last! A day ago they avoided him; now they were on their knees. A fine indignant glow warmed his blood. Would he help them? They should see! So he went on, mentally questioning himself and chewing the

dangerous green apple. Finishing his meal and meditations at the same time, he threw the core at a passing dog and slid from the soap-box throne. Patronizingly he told them to run home and leave the matter in his hands. He grinned sardonically as they left, filled with glad assurance and faith in his ability to avenge their wrongs. Little he cared for the kitchen. Dimly outlined, a vision of rich sport floated before him. It rapidly assumed form. He ran up the street searching for his companions. To attract them, he uttered, from time to time, weird, flute-note calls.

Shortly after dusk the redoubtable Kid, surrounded by his followers, was observed passing the post office. People waiting for the evening mail watched them go by and shook their heads dubiously, wondering what new devilment was afoot.

Slowly and silently, with an air of mystery hanging over their movements, they filed down the track in the direction of H—, a mile distant neighboring village. Abandoning the railroad a short distance from H—, they made a detour and entered town from the side, right angling the main street. The Kid guided them through the deepening gloom with marvelous accuracy. He intuitively anticipated ditches, barbed wire fences and other impediments to travel. At intervals he halted to get his bearings and to impress on the company the necessity of silence. As they stamped ankle deep through a narrow patch of swamp a sound of revelry was borne to their ears on the heavy, dew-laden night air. They stopped; the Kid listened critically.

"That's it!" he said in a dramatic whisper; "Foley's hotel."

Pressing on they soon located the house. Yellow light streamed from the windows; the sound of carousal grew more distinct. Then the light vanished, and, after walking a few yards more, they found themselves under the lee of Foley's rear fence.

Again they halted, while the Kid lighted a match. The puny flame revealed a small, ill fitting door in the wooden wall. They pushed it, but in vain. Usually open, it was fastened that night; but the far seeing leader had prepared for just such a setback. Groping in his pocket he dragged forth a coiled piece of heavy wire, which he straightened and inserted in the edge of the door. Working it carefully, he managed to lift the fastening. The gate opened, swinging toward him, and he passed through, followed by his first and second lieutenants. On the other side the trio stopped to listen. Someone was dancing, with a sound of rubbing sandpaper. A banjo, played with great velocity and strength of finger, accompanied the shuffling.

Cautiously they crossed the dimly lighted yard, tiptoeing like dancers. Passing under the heavy shadow of an apple tree, the Kid dived headlong over the prostrate form of a reeking wretch whose head was pillowed against its butt. Scrambling to his feet, he made ready to fly; but the man, who was almost in a state of coma, merely groaned. Suppressing a desire to snicker, they stole up to the kitchen porch, where the Kid, walking on the points of his shoes with extreme delicacy, ascended the steps and peered in the window. He saw something. He capered back, and down the stairs, grimacing horribly.

"He's there!" he hissed, exultantly. "Oh, Lordy; what a picnic! Get the bag ready, Jim."

One of the pair lugged from under his coat a feed bag of immense proportions. He looked at the Kid expectantly, whereupon the suave ring-leader again crept noiselessly up the stairs. This time he turned the knob gently and pushed the door in a few inches. As he rejoined his companions a gigantic brindled cat appeared on the threshold with the suddenness of an apparition. He gazed at the 3 conspirators sus-

piciously. Taking some small pieces of cold roastbeef from his coat pocket, the Kid threw them at the animal. "Pussy, puss, poor puss," he cajoled seductively. The miniature tiger swallowed the bait greedily. Then, his distrust fading, he walked toward them, purring hoarsely, as if he had a cold. Confidingly he rubbed his gaunt side against the Kid's arm; but oh! the perfidy of man! With a skill resulting from long practice, the wily Kid dexterously seized him by his stump of a tail and swung him clear of the porch, bent on inserting him in the yawning feed bag. But his skill was taxed to the utmost. Never before in all his experience had he tackled such a gigantic beast. Hissing and spluttering like a Katharine wheel, the cat clawed. Spread out to the resemblance of a tanned skin, he seemed yards too big for the sack. At great expense to their skins they tried to make him fold his forelegs, which were gyrating like the planer of an airship; but he refused, and dug his inch-long hooks deep into their hands. The Kid's arms were rapidly growing weary. Finally the 2 aides managed to secure a grip on the cat's muscular legs, and the battle was won. One terrific, long drawn, protesting yowl and he slid into the bag. Carrying the imprisoned victim, yelling dismally, they left Foley's with all speed.

Retracing their steps across the fields, the abductors regained the railroad track and hurried homeward. The 2 sack bearers walked ahead for much the same reason that a brass band marches in the van of a village parade. Piercing yowls intermittently stabbed through the heavy tarpaulin. The procession paid little heed to the expostulating prize; they were too much occupied in a jabbering discussion of the adventure. Near home they forsook the track, with its guiding slats of grey steel, and marched cross country with the same strategy and caution that characterized their movements when entering H—.

Proceeding to an unused barn, on Grigsby's land, 300 yards from the main street, they climbed in through a window and deposited their victim, bag and all, in an empty feed bin. Leaving the miserable cat to extricate himself from the suffocating tarpaulin net, they went home: some to receive enlivening thrashings; all, to be soundly berated.

"Don't forget," said the Kid, as he left them standing under one of a row of great maples which arbores the narrow road, "one of you must file the lock early. We can't get him through the window."

He trotted down the tree-roofed corridor, and from a distance, his voice came faintly, "Don't for-get." It was 10 o'clock. With a roar of breaking seas the East bound express passed over the crossing under a pursuing storm of red hail.

Chum was lazily extended on the sidewalk, before the barber shop. A little boy came up and addressed him. "Cats!" he cried, which meant kittens to the terrier. The dog jumped up as if kicked. With equal ease the twain ran across the street, surmounted a rickety stone wall, knocking off the top layer in doing so, and tore down the long grade toward Grigsby's old barn. The boy swung his arms as if traversing a life line; his lean, stick-like legs shoveled dirt at his back. Chum raced alongside, yelping. Reaching the goal, the boy, with breath to spare, yelled a peremptory summons. With a rusty squeak the heavy doors gaped narrowly to admit him. He squeezed through, the dog wedged between his legs in a frantic endeavor to be first. The doors, closing in the automatic manner of a mouse trap, collided sharply. His comrades pressed around him, uttering extravagant praises and congratulatory whoops. Chum ran about, with his nose to the floor, and sniffed expectantly. Suddenly stopping before the feed bin, he raised his head and jerked out a string of barks. Then he clawed at the bin frenziedly, howling

to sustain his enthusiasm. A blood-curdling hiss, from the interior of the box, answered his challenge. Still, he did not suspect, but went on scraping with the energy of a beaver. Fastening a long piece of light rope to the lid, the Kid freighted the other end with a heavy spike and tossed it up into the empty hay loft. He followed, ascending the loft ladder. The others went after him, fighting for right of way and laughing hysterically. Seating themselves on the edge of the loft, they mauled each other to vent their joy. Dallying with the lanyard, the master of ceremonies scanned the amphitheater closely to see if all means of egress were closed to the combatants. His sharp scrutiny failed to reveal a single leak. Everything was tight as a collision bulkhead. The fragile, many paned window was too high for Chum; and he was certain the cat would make no effort to escape.

Meanwhile, the dog was industriously digging away, encouraged by the spiteful hissing. Slowly, very slowly, the lid was drawn up. With consummate ease the streaked demon cleared the rim of the box and alighted beside the astonished terrier. Chum made an erratic, crablike jump; then, assuming a posture of defense, faced his opponent with an air of weak determination. Up in the loft an expectant audience yelled untiringly, exhorting the beasts to begin. "Kut-at-a-row! Kut-at-a-row!" they crooned in exquisite mimicry. The betting was light; the odds were 4 cents to 1 on the cat. And if form counted for anything, he deserved strong backing. He was, indeed, a magnificent fighting machine. Lacking the weight of the blond, frowsy terrier by a few pounds, he more than evened the balance by the quality of his rubber muscles and the efficiency of his offensive armament. Menacingly he stared at Chum, hissing like a bundle of snakes. The hiss passed into a crooning war chant; he beat time with his half length tail. Suddenly, with a terrifying scream,

he bounded upward as if shot from a mortar. Descending, he spread himself over the dog like a striped blanket, and, fastening to his starboard ear, chewed and clawed with convincing earnestness. Howling in anguish and insane with fear, the tortured dog contorted miraculously and threw off his vindictive persecutor. As he did, he snapped with desperate energy, and, for a wonder, managed to secure a grip on the cat's lean neck. It was then the dog's "evening to howl." The spectators were in a state edging on lunacy. They raved admonitions at the seemingly defeated cat. For purely discordant effects their howling easily surpassed the best efforts of an amateur country choral society.

But Foley's pet needed no help nor sympathy! Chum had not secured a firm hold. Snarling horribly, the cat disengaged his twisted neck, losing a considerable sheaf of hairs in the effort. Then, seething with rage, the aggressive parcel of rubber and piano wire attacked the kitten slayer scientifically. Dabbing at him like a boxer, he drove the bewildered cur slowly back.

Things looked black for Chum; he was in a fair way of being torn into strips. Frantically, and with an energy born of despair and a guilty conscience, he snapped at the relentless avenger, but in vain. Only once did he pass the slashing barrier, and then it was but to secure a bit of ear. Inexorable as fate, the brindle champion forced him into the corner. Another attack of mob mania convulsed the gallery. Against a cross wind, they were heard in the village;

and a posse, with the fat barber laboring heavily in the van, started for the barn to inquire into the excitement. Penning the protesting yellow wretch in the angle, the agile cat made an odd, squirming leap and again seated himself on Chum's back. This time the grapples held.

Writhing like a pinned serpent, the crazed dog made futile contortions to throw off his merciless assailant. Failing, he circled the pit like the performing dog in a circus. The vindictive cat hooked him with the abandon of a mahout trying to stop a runaway elephant. Around he went, ever accelerating his speed, the audience cheering itself into exhaustion. Suddenly, above the tumult, there came a sound of terrific hammering on the rope-fastened doors. Moved by a common impulse, the gang slipped through a wide crevice in the rear of the loft and plumped to the ground with a series of thuds. As the last one jumped, the badgered cur, still carrying his goading rider, made a great bound at the high window. He fell short, but he shook off the cat in the endeavor. Then, freed for an instant of his load, he made another desperate attempt. That time he was successful, and crashed through, carrying with him a portion of the frame and smashing a goodly number of panes. With half the effort, the striped fiend, pursuing him, shot accurately through the fringing circle of jagged glass. When the posse entered, the barn was deserted. The barber cursed profusely, with infinite variety of expression. A faint mocking yell floated up from the distant swamp.

Mrs. Flanagan—I want a pair of shoes for my boy.

Salesman—French kid, ma'am?

"No, sir; Irish kid."—Schoolmaster.

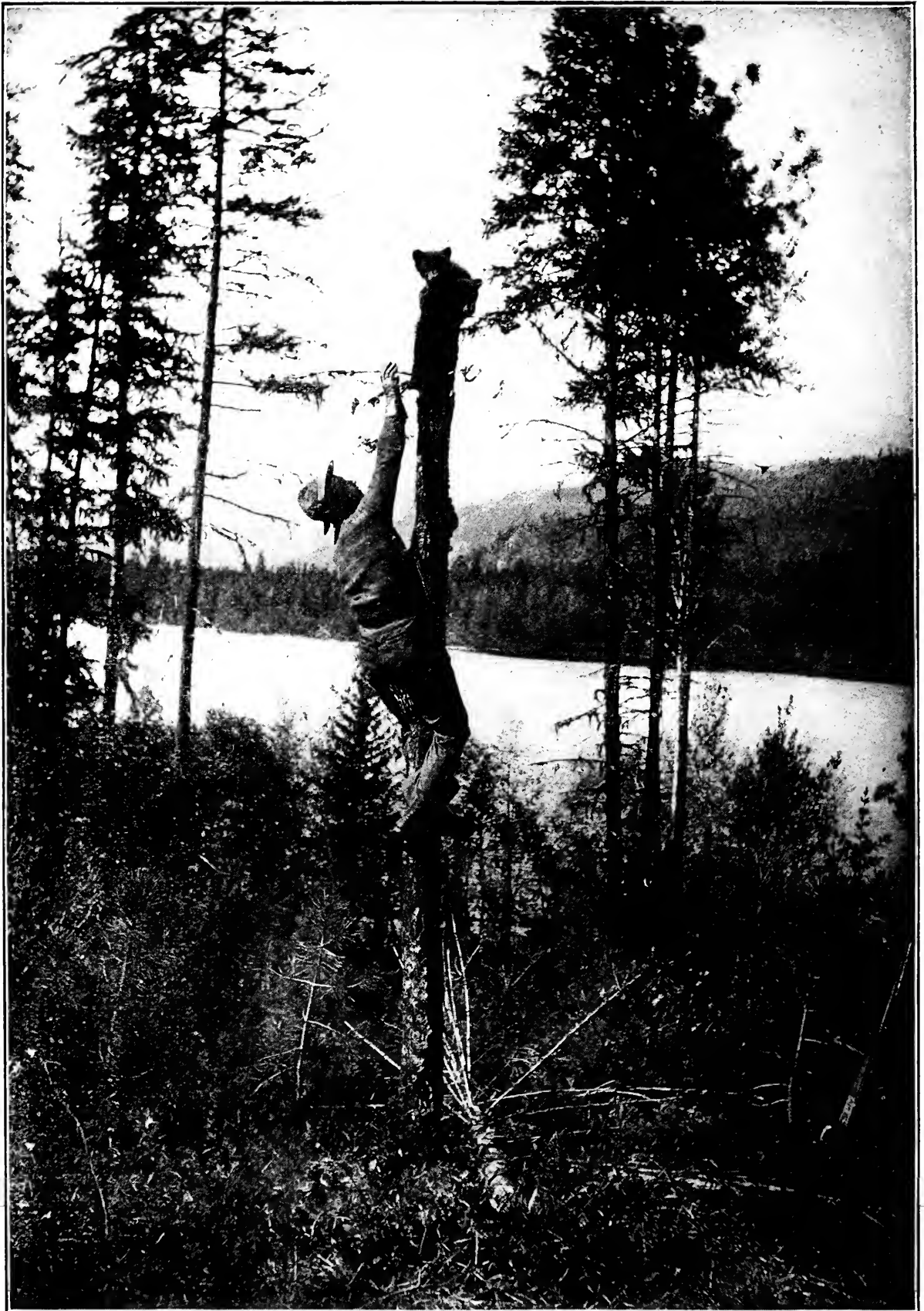

AMATEUR PHOTO BY G. E. SIROARRIDGE.

WE WANT OUR MUDDER.

Winner of 10th Prize in RECREATION'S 7th Annual Photo Competition.

BASS FISHING IN THE NORTH POTOMAC.

ALEXANDER HUNTER.

It is said that the late Professor Coues, of the Smithsonian Institution, often expressed his surprise that the black bass, with its marvelous fecundity, should be found in comparatively small numbers in the streams of West Virginia and upper Maryland. This game fish can take care of itself and only bites freely at certain seasons; and its secluded haunts, amid the gorges and rocks of the narrow streams, make seines, nets and traps an impossibility.

I had an experience a few summers ago which enlightened me, and proved into whose pot the fish go; also demonstrated how much more than a match the unsophisticated native is for the shy, wary and suspicious bass.

I made preparations for a 2 weeks' fishing trip for bass only. I did not care how far I went or what hardships I had to undergo, so I might fill my basket. I knew of one ardent sportsman living in Staunton, Virginia, who was as fond of his rod as he was of his gun, and I felt assured that if Captain William Fowle would take a trip with me, I could know the delight of eating my own fish, caught by my own line; for every angler will agree that even a perch or a sunfish is superior in sweetness and flavor, when it is acquired by his own skill and patience, to the finest of the species secured by a silver hook.

Captain Fowle wrote me to come to Staunton and we would take a Jersey wagon and strike for the South branch of the Potomac river. Loading our wagon with provisions and traps, we started across the mountains, and I enjoyed the 3 days as only a man can who has been cooped up in the city during the dog days. It was September, and it was a never ending delight to travel in those mountains, with their changing scenery and the gorgeous foliage of every imaginable hue. The pale gold of the sugar maple, the vivid green of the mountain larch, the intense crimson of the dogwood, the rusty brown of the chestnut, the sea-green of the pine, the dull red of the beech, and the purplish shadows of the elm all combined to make a picture of indescribable beauty.

Fair as nature appears by sunlight, its beauty is intensified beyond expression under the radiance of the moon, and later, as we drove along the brink of a deep gorge, we could see below, 1,000 feet at least, the stream at the bottom, sparkling like silver in the pure moonlight. The memory of that ride brings enjoyment now; and at the time I leaned back, with my pipe in my mouth, and drank in the wondrous glory of

the night. Every sense of weariness and discord was banished and I seemed wrapped in a lotos eater's dream.

We stopped at a lone farm house, about 12 miles below the little village of Franklin, West Virginia. Early in the morning we started for the White Horse rock, a famous bass haunt on the South branch. After reaching the stream, which was about 100 yards wide at that point, we scrambled along the bank, over the boulders of rock and granite, which were piled up as if the whole region had once been the scene of a battle royal between the Titans. It was hard work getting over those rough crags. At last we reached the summit and, lying flat on our faces, peered over the cliff, which was as smooth as a wall and about 30 feet high. At its base the water was deep, as clear as crystal, and as alive with fish as if it were a stocked aquarium.

"Well," said I, "this is not the way I ever fished for bass. A rod is of no use here."

"No," said the farmer, "I brung you here so you ken ketch enough to eat. Then I'll carry you furdur down, where you kin use your poles."

The captain had a plentiful supply of flies, grasshoppers, minnows and helgramites, and choosing the latter we ran out our lines and dropped them over. The baits had not touched the water before they were seized. In half an hour there were a dozen bass lying beside us.

"That's enough," said the farmer. "Now we will go down."

We fished all the morning and again in the evening. It was a glorious day and one never to be forgotten. We found the helgramites the thing and had no occasion to use any other bait.

That night there was a slight shower, not enough to muddy the water, but for some reason the fish would not bite. In vain we tempted them with every variety of fly. We could see them swim lazily to the bait, smell capriciously at it, and then contemptuously turn, give their tails a flirt and disappear. It was provoking and we sat there watching those sprightly, lusty fellows, idling away their time, instead of furnishing us diversion. We climbed up to the top of White Horse rock and let our lines drop below, not for sport, for it was about as much fun catching fish from that elevation as it would be to drop a line down the shaft of an elevator in a warehouse and get the porter below to slip a herring or a salted mackerel on the hook. No, we were so mad that we wanted to get even with

the bass; but the fish around that section evidently belonged to the United Fish Association, and the leaders had passed word down the line to bite at no bait, touch no fly and to beware of all mock, sham, counterfeit, fraudulent, fictitious, tricky objects whatsoever. Captain Fowle averred that the bass, after smelling around his most taking helgramite, would swim to the surface, wink one eye, open its mouth to show how utterly weary the transparent efforts for capture made him, and then would sink down languidly out of sight.

At that juncture a new actor appeared on the scene in the shape of a long, slab-sided, freckle-faced boy. He bore in one hand a trimmed sapling.

"Hello, Bub!" said Captain Fowle, "going a-fishing?"

The boy grinned and answered that Dad had sent him "to ketch some fish for supper."

"Well, Dad will have to go without his fish to-night," answered the captain. "We have been at it all day and haven't had a bite."

"I dunno," responded the boy; "I reckon I kin yank some out."

He took from his pocket a small roll of flexible copper wire, made a slip-knot of it, and tied it to the end of the pole. Then he seized a handful of worms, threw them beside the rock, and as the bass swam leisurely up he slipped the wire loop, which was invisible to the fish by reason of its being so nearly the color of the water, into the stream, and gave the pole a jerk. The noose caught the fish in the middle and in a second a big bass lay flopping on the bank. Again and again he repeated the maneuver. We tried our hands at it, but somehow could not acquire the trick.

Having "yanked out" enough for himself and a string for us, for which we paid him a quarter, the boy, with as much nonchalance as if he had been shucking corn, untied his wire, shouldered his pole and "reckoned it war 'bout time he war home."

"Say, Sonny," called the captain, "Do you folks always fish that way? Don't you ever fish with a rod and line?"

"The gals do sometimes, but we fellers ain't got no time to fool with 'em that way."

As he disappeared over the rocks the captain drew a long breath.

"Live and learn," he exclaimed. "Now I know why the bass are so scarce."

"Yes," I added, "that Johnny Raw can catch more fish in 2 hours with his hickory pole and wire than we with our split bamboos, fly rods, automatic reels, silk water-proof lines and full assortment of flies, together with our fish knowledge, can in a week."

I asked a native who lived near if he was

not aware that it was against the law and against the best instincts of sportsmanship to drag the bass out of a hole as he would mud turtles.

His reply was characteristic, and exemplified the feelings of the farmers on the question of game protection generally.

"Agin the law! I ain't mindin' no derved law that interferes with me haulin' in fish when my old woman wants 'em."

"But you will exhaust the supply," we suggested.

"That's thar lookout, not mine. That ar river runs through my farm and I'm goin' to ketch fish any way I want and whenever I durn please."

We had nothing more to say.

During the next 2 days we caught only about half a dozen bass between us, but we enjoyed those golden autumn days just as much as we could have had the river been full of fish and ravenously hungry for the bait.

One cool, cloudy morning, just the kind of a day to make an angler exert himself, my comrade and I found a pool which had escaped the scrutiny of even the wire fiends. It was full of bass, but they were as capricious as a society belle. We tried every fly in our collection.

"Well," said I, "those fish are not hungry, so we might as well stop."

"That's not it," replied my companion, "I have not been bass fishing these 20 years not to have learned something. They wish a certain food and will not touch any other."

"All right," I retorted, "I hope they may get it, but it is not I who will ransack creation to find what they want. When they are ready for what I have to offer then they can speak," and I proceeded to unjoint my rod, fill my briarwood, light it, lie down in the shadow of a rock, take a paper novel from my pocket, and when I was not reading I listlessly watched my friend.

He, in the meantime, found some angle worms; but no, the bass family were tired of that diet. Did they want a grub? Not much! They were evidently surfeited with grubs. A grasshopper? No temptation whatever.

Then, after a great deal of trouble, the captain secured a live minnow.

"I've got them now," he said.

His line, when he allowed it to sink, was jerked smartly. He pulled it up and lo! a miserable, slimy, twisting eel.

As the captain, with unmistakable rage, stamped the life out of the wriggling reptile, I just rolled over and over in a convulsion of laughter.

"Billy," I said, wiping the tears from my eyes, "don't try any more. There's no telling what you'll bring up next. You're not fishing for snakes."

The captain stalked away, leaving his

crushed victim on the rocks. He was gone some time. I saw him, on his return, put something black on his hook and make a cast. No sooner had it skimmed the water than, with a noise like the crack of a whip, a big bass gulped it down and after a pretty fight was drawn in. There were no words spoken as the captain wiped his face; but he turned and looked at me. He was laughing, but there was no answering grin on my face.

Again he threw, and it seemed that the one longed-for delicacy on the bass bill of fare had been provided; and my comrade had his revenge on me, too, if that was what he wanted. He turned a deaf ear to my request to be enlightened as to the wonderful bait he was using, and he drew out 6 successive bass, not one less than 11 inches in length.

At last he relented, and conducted me to an old field, half a mile distant, where a pine tree lay prostrate and half decayed. In this retreat he had found the field crickets, a species of grasshopper, rusty black in hue, with short legs and wings and fat body.

We secured about 20 of them, and, shades of Walton! what sport we had! Such dartings hither and yon; such ripples on the surface and such commotion below! We shouted aloud in our exultation. The noise must have attracted other fish, for the numbers seemed undiminished in spite of our gains. At last we knocked off, tired out. As we lay resting, I remarked,

"It is clear that nature did not intend me for an angler. Every one of those bass would have been in the water now but for you."

My friend's face softened in a gratified smile.

"You are right. An angler is born, not made. Those bass were hankering for some certain food, not far distant. I would have spent the whole day trying to find out what it was."

"Suppose you had not hit on the right thing? What then?" I urged.

"I would have gone home, given away my rod, and would never have gone near a stream again. A man," concluded the captain, "who can not find out the ways of trout or bass, is not fit to cast a fly."

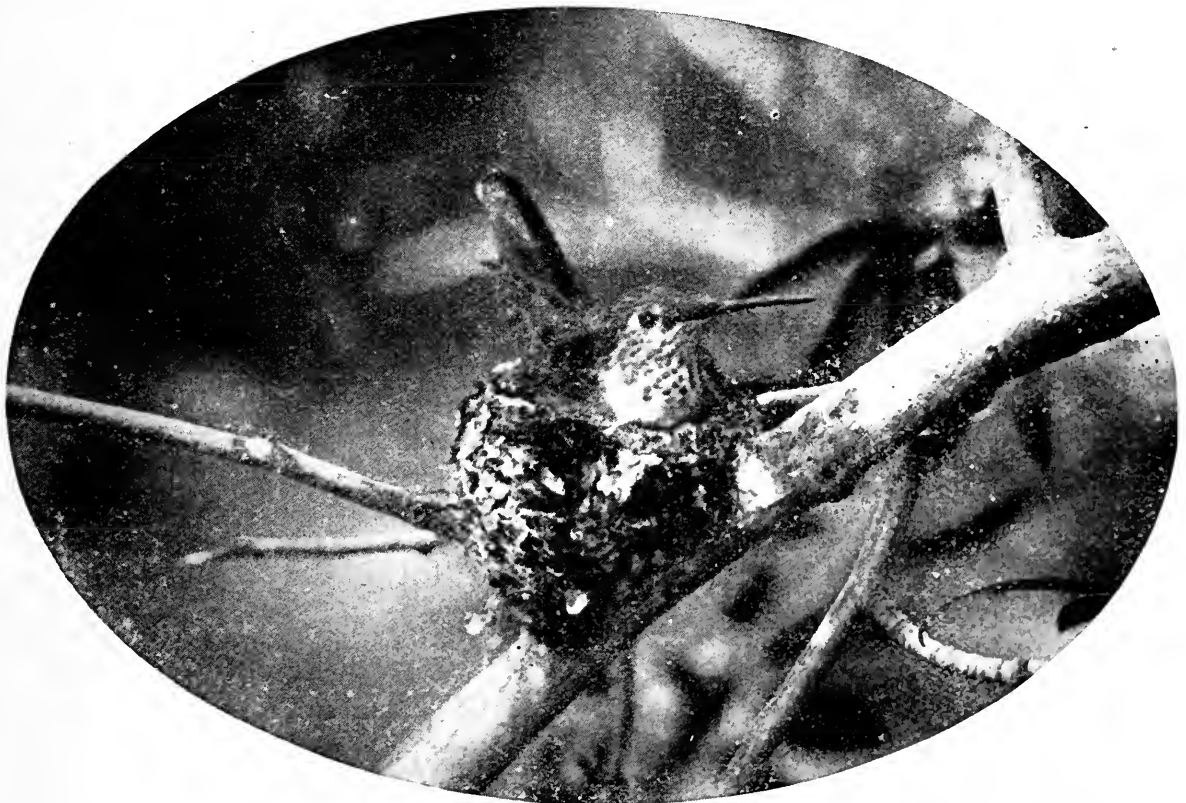

THE HUMMING BIRD.

AMATEUR PHOTO BY M. JAMSON

Winner of 9th Prize in RECREATION'S 7th Annual Photo Competition.



AMATEUR PHOTO BY W. T. ADDERLEY.

STILL LIFE.

Winner of 12th Prize in RECREATION'S 7th Annual Photo Competition.

HOW THE DEACON BECAME A HORSE JOCKEY.

L. B. ELLIOTT.

Photos by the Author.



THE DEACON.

My acquaintance with the Deacon began one sultry afternoon when I was called to photograph him, driving the gray stallion, Ashwind, at full speed, on a small race track in Western New York. Of course Ashwind doesn't need a driver. He was born with more intelligence than some men acquire, and has won so many fast races in the grand circuit that he knows the rules of the game even better than his venerable owner and trainer, Tom Lark; but he likes to have Deacon drive him and Deacon enjoys the sport. Deacon has been Ashwind's playmate ever since he was a wee puppy. Where he came from, no one knows. His ancestry is shrouded in mystery, but a glance at his face shows a combination of bulldog courage and terrier sagacity. The first 4 years of his life were spent just as any dog's time might be spent, running wild on the old farm 9 months of the year, chasing chucks and cotton-tails, bringing up the cows and amusing his bosom friend, Ashwind. Deacon never seemed content unless he could be within speaking distance of Ashwind, and he reached the acme of earthly bliss when he could lie on his back just in front of Ashwind's fore feet and be nipped and rolled and nosed about by the fleet pacer.

As soon as the racing season began, Deacon, Ashwind and Tom Lark would be found where the pace was the hottest and the stakes the biggest. Thus it came about that Ashwind at 6 years, togged in hop-

ples, was leading the 20 class, an easy winner in all events. Tom knew the powers of his mighty gray and each day as he turned the stallion's nose into the stretch, held a tight rein and slowed him down to a lead of a neck, clearing the wire with a final rush that made the bookies and the bettors jeer and earned many a caution and sharp reprimand from the judges for poor Tom.

Ashwind soon learned the trick and like a reasonable being carried out the intention of his master to the best of his ability.

His racing instincts would invariably get the better of him at the start of a heat, and, no matter how much he was jockeyed in the scoring, his white nose was always first under the wire with the field soon stringing along in the rear, in spite of all the old man could do to hold him. Then he would gradually come to his senses and begin to slow down, keeping well in the lead, however, up to the home stretch, when he would quit completely, and, utterly oblivious of Tom's frantic urging, would finish a winner as limp as a rag, coming to a dead stop a



ASHWIND.



THE DEACON'S RIVAL.

few yards beyond the wire. In spite of this bad behavior, Tom never struck the horse; he would as soon have struck his best friend. This state of affairs could not last long, however, and Ashwind was soon

given a mark of 2.12 in which class he was as much at home as in the 20's and acted as badly.

Tom's 65 years were beginning to tell and, while he loved the track and the race, he hadn't the heart to face another season of reprimands. He decided to let Ashwind drive himself and race against time to his heart's content, as he seemed bound to do on all occasions. A few experiments demonstrated that when harnessed to a sulky with short guide lines attached to either side of the girth, he would do his mile without a driver just the same as he did when Tom was on the seat, scoring as fiercely as though in the ruck of a big field, and finishing his mile in 16 or better. The sight of a driverless horse was, however, distasteful to Tom, and he sought to provide a 4-footed jockey who would enter into the sport with zest. One would think his first thought would have been of Deacon on account of his fondness for Ashwind. Not so with Tom. The Deacon was not cultured, neither was he known to be a sport. He was just an ordinary bulidog cur and a bulldog is not supposed to have any brains to speak of, at least not in Tom's estimation; so he set about finding a trick dog. At last a bright and delicate little collie was engaged and duly installed as Ashwind's companion.

Deacon's feelings can better be imagined



DEACON EXERCISING ASHWIND.

than described when this intruder was given his own place in Ashwind's stall, and he was forced to look for shelter wherever he could find it. He was jealous; wildly, insanely jealous. Many were the tales of his relentless ferocity toward the dogs of the neighborhood and he could have made an end of the collie in a short time; but he was too much of a gentleman to attack a guest under his master's roof. He could not, however, conceal his feelings; his crestfallen bearing on every occasion when Collie was placed on the driver's seat spoke volumes of protest against his undeserved separation from his friend, and the usurpation of his privileges, so dearly prized, by another.

Poor Collie was a sorry driver. Per-

severance and lack of another trick dog led him to try again and again to educate poor Collie to sit up and look and act as if he enjoyed the sport.

"Look a here," said Tom one morning to Jim, the groom who rode Ashwind's running mate. 'What are we goin' to do with this fool Collie? He ain't no good for this business, it's late in the season and I'm tired foolin' with him."

"Give him another trial," said Jim, "an' if he won't work, throw him over the fence an' let the old horse go it alone."

"Reckon we can't do no better. Put on them hopples and we'll hook up, but be sure and ketch that Collie first or you'll never see him to-day."

Jim snapped a chain in Collie's collar,

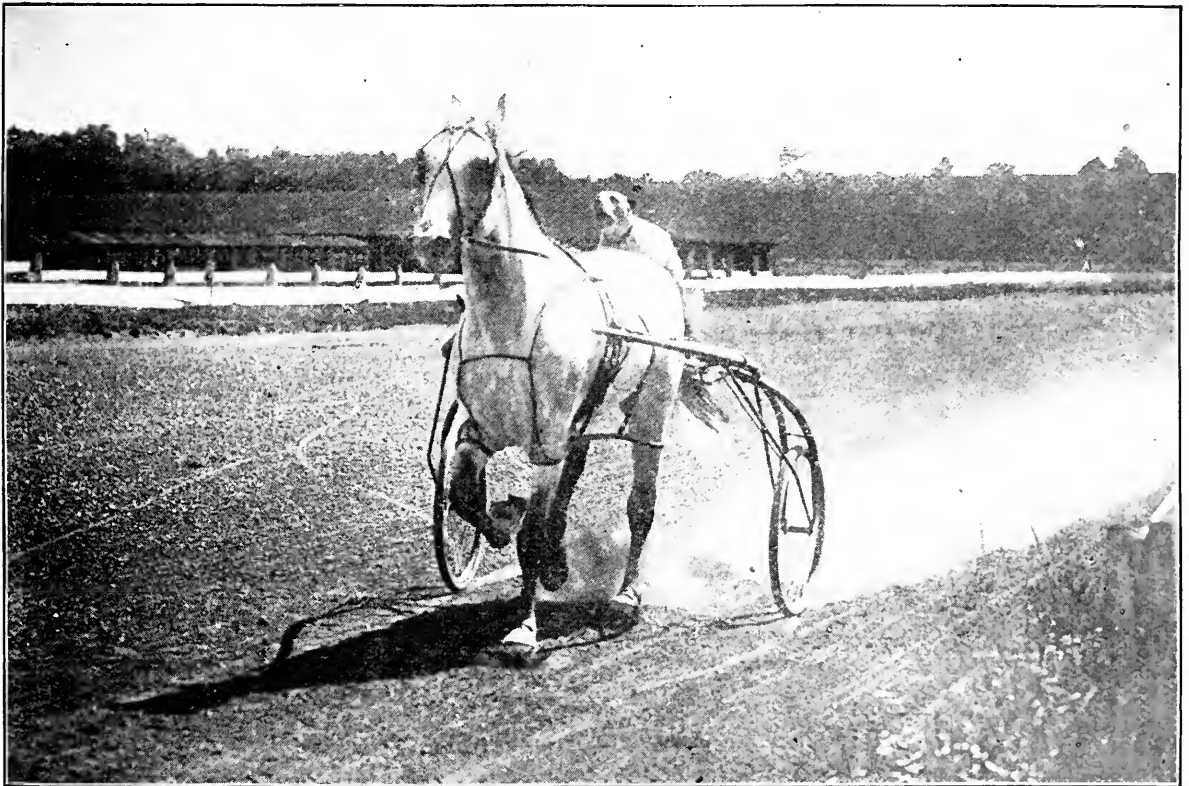

DEACON DRIVING ASHWIND.

fectly at home among the sheep and lambs, kind, obedient, and attentive to the work in which he took delight, the wild excitement of the race course completely cowed him. He had to be fairly dragged into the driver's seat, and lost no time in seeking a more stable footing whenever the opportunity presented itself. Thus some weeks wore on, the most miserable weeks in Deacon's life; weeks of longing to be revenged on his unworthy rival; of hoping Collie's unfitness might suggest a change in his own favor.

To tell the truth, Tom was tired of his bargain from the first day, but his habitual

and after adjusting Ashwind's hopples, the 4 proceeded around the corner to where the sulky stood in the shade of a tree.

What a sight met their eyes! There on the seat of the vehicle sat Deacon, his mouth stretched from ear to ear, his one eye fairly scintillating with delight and his head bobbing up and down, as much as to say,

"Yes! I know your troubles; why don't you give me a show? I won't lie down and skulk. I can drive a heat to a finish."

In his frantic endeavors to make himself understood he toppled off his seat, only to scramble up again and renew the demonstration. Tom looked at Deacon a full

minute, in doubt as to whether he had gone mad or had turned human.

"Wonder if that bulldog would know enough to drive. Give him a trial," said Jim.

"Can you drive?" said Tom. Yelps, bobbings and a general stampede around the sulky seat told the story, and then it was that Deacon's application for the position of driver for Ashwind was accepted and he became a horse jockey.

When the last buckles were fastened and Ashwind, with a satisfied whinny, started

for the track, the look of mingled triumph and contempt the Deacon cast back at the wondering Collie would have done credit to a Booth or a Jefferson.

At the fall meets and the country fairs you may still see this oddly matched pair performing their strange feat; and when Tom takes his place before the grand stand and tells of Ashwind's many victories, and how Deacon became a horse jockey, the old bulldog looks almost as proud as he did the day Collie became a memory, and his own future a fact.

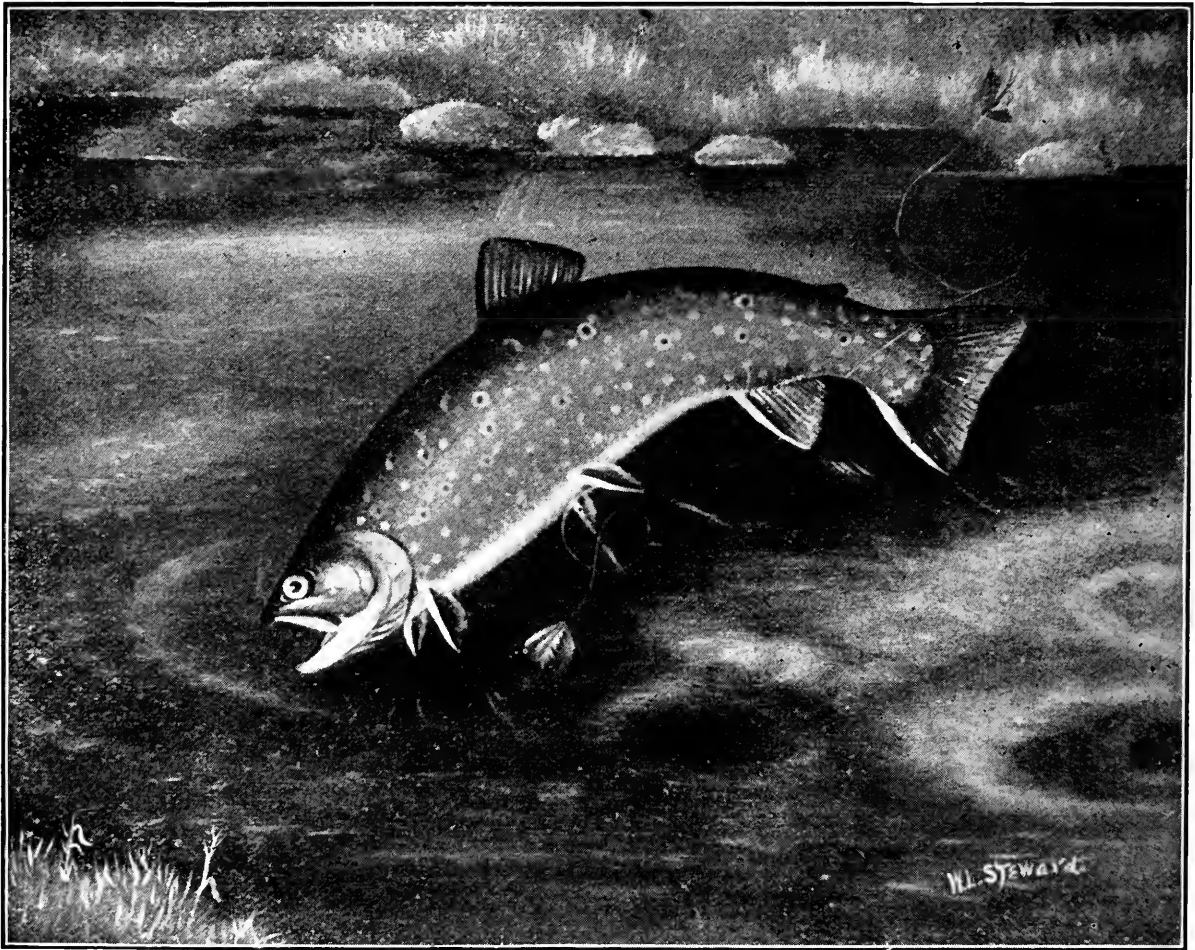

MISSED.

FROM A PAINTING BY W. L. STEWARD

Clerk—There is a woman outside who says you have robbed her of all she had.

Trust President—I wonder which one it is.—Life.

OH! MY HEART IS A-HUNGRY FOR THE HILLS

ALFRED I. TOWNSEND.

Oh! my heart is a-hungry for the hills,
where the pine and the hemlock
grow,
Where the life of spring now throbs and
thrills and the pussy-willows blow;
Where the shimmering trout like a phantom
shade through the dashing water flies,
And ridge on ridge the hills are laid till
they touch the very skies.
Where the lizard basks in the blazing sun
and the honeysuckle lends
Its burning flame 'till the day is done and
the shadowy night descends.
Where the quails are whistling low amid
the depths of the thorny maze,
And the far-off peaks are faintly hid by a
delicate veil of haze.
Where the drooping boughs of the sugar
pine their resinous censers sway,
And fling their odors before the shrine of
the burning god of day;
Where the eagle sails in the azure deep, and
the manzanita burns;

Where the river sings the world to sleep,
and the joy of youth returns.
Where the ferns are trembling 'neath the
tread of the elfs that bring the
breeze,
And the stag is sleeping within his bed in
the shady of the mighty trees.
Where the squirrel high on his leafy throne
is voicing his shrill commands;
Where the vulture sits on the crags, alone,
a monarch of barren lands;
Where the tent is pitched in the shady nook
and night from the canyons creeps;
Where the sun is taking his last fond look
as the mountains fall asleep.
Where a glowing spot in the canyon marks
the place where the hunter camps,
And high in the sky like floating sparks
the angels swing their lamps.
Oh, my heart is a-hungry for the hills where
my feet have often trod,
Where the pulse of life now throbs and
thrills 'neath the loving hand of God.



AMATEUR PHOTO BY W. H. THURSTON.

GREAT BLUE HERON AT HOME.

One of the 13th Prize Winners in RECREATION'S 7th Annual Photo Competition.

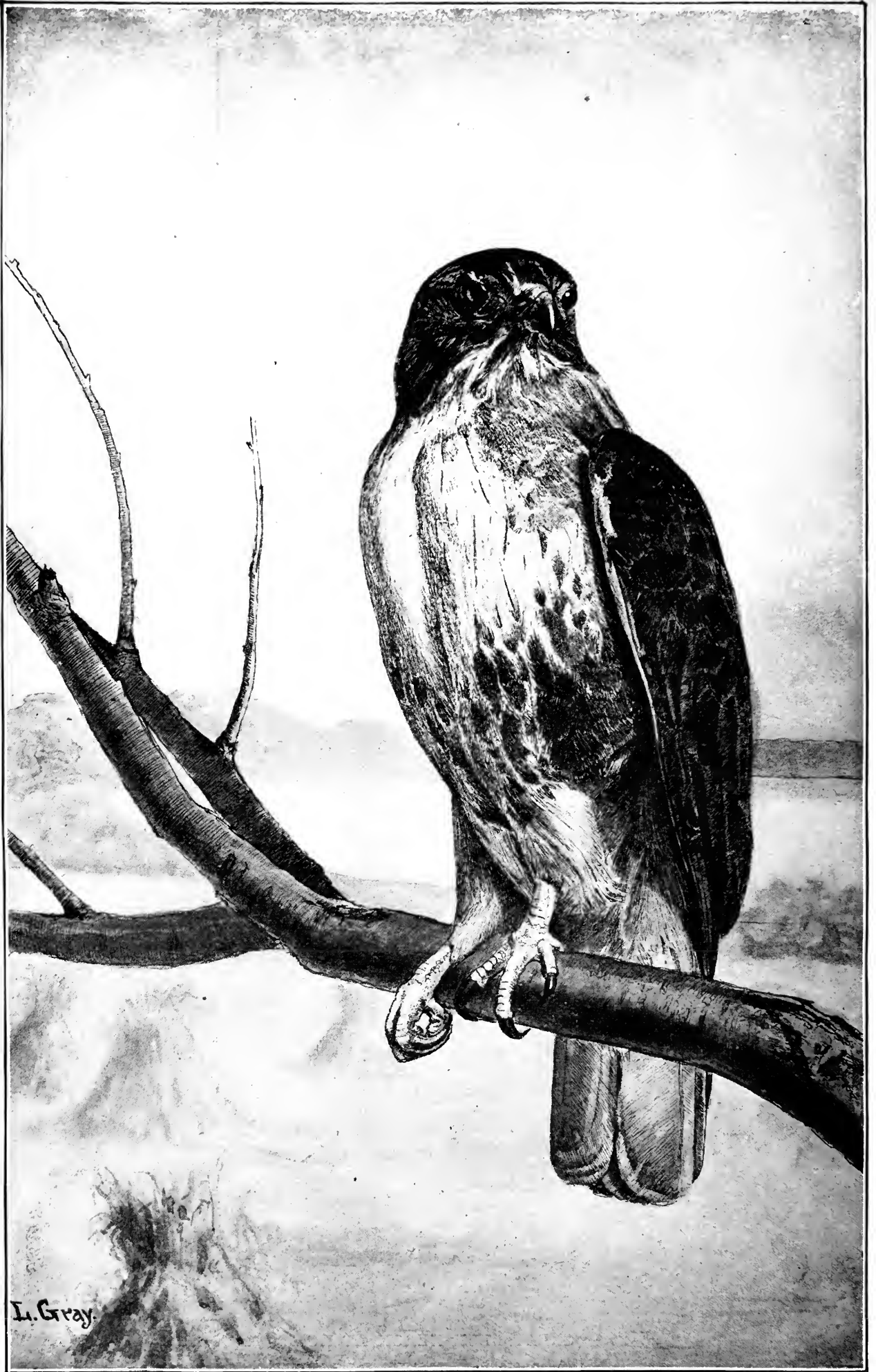

REDDTAILED HAWK, *BUTEO BOREALIS*.

SPRING MADNESS.

TEN SLEEP.

Sauntering down the street on a business errand one warm spring day, my attention was arrested by a crowd of men gazing intently at a window display. I, too, turned to look. There they were in fascinating opulence: reels and rods, gaudy flies and lures, landing nets and bait pails, wading boots and canvas duds, drinking cups and pocket flasks, and all things dear to the heart of fisher folk. In the twinkling of an eye the mischief was done and the old ferment was working in my blood—the fret for the woods and the free open life under canvas, for brawling streams, the mountains and God's out-of-doors.

I had thought "that's all shoved behind me, long ago and fur away," but as surely as the shad-bush blooms after the snow, so surely does the old yearning return like a giant refreshed. Let a man once hit the trail and follow it until he brings down a buck; let him do battle with a trout or salmon; let him thrill at the startling whirr of a rising grouse; let him once scent the odors of camp and sleep with the starlight on his face, and old Mother Nature claims him forever.

That is something the gentler sex can not understand, or will not. Woman readily comprehends how each recurring Easter brings an intense longing for new head-gear and silken gowns; it is part of her being. She wants pretty things, and she gets them. But when the strengthening sun begins to dissipate the lingering snow, when a snowdrop pushes its rash little head above ground, and the call of robins is heard throughout the land, there is just a wee touch of scorn and intolerance in her bearing toward frail mankind. Why? Well, you see, he is puttering in his den again, and the house is redolent of varnish, for rods have to be overhauled and varnished, or maybe fitted with new ferrules. The good wife can not abide her helpmate's silly chuckling over the splicing of a broken joint, but then she had not the good fortune to witness the battle royal which resulted in the fracture. She resents his devotion to time tables; and the everlasting correspondence with some mysterious "Jim" or "Jack" up country irritates her. The unearthing of, to her, dirty old canvas coats and corduroys is a disgusting spectacle. But, after all, there is more of jealousy and envy than anger or spite in her attitude at this time when the spring madness seizes her liege lord. If some one could explain (and she would listen) that it is exactly like house-clean-

ing, which every normal, healthy woman revels in next to a wedding, there would be a better domestic understanding. Man would complacently accept the volcanic upheavals of house-cleaning under the new conditions, and, as a reward, he would be allowed to fish in peace.

It is asserted that the process of waste and repair in the human economy makes man over into a new being every 7 years. This is an error; man is remade annually, every spring. When the world is greening and bursting into flower, some subtle alchemy is transforming winter-stagnated man into a new being. There are those who scoff at the miracle as a relic of barbarism, as savagery handed down from remote ancestors given to preying on all living things. By way of refutation, hand the scoffer gentle Izaak Walton's "Complete Angler," which breathes such a tender love of out-of-doors, such appreciation of the goodness of a quiet life spent in the contemplation of the glories of the Creation, and so quaintly champions the pastime of fishing that it holds a place in literature rivaled by no other book. The simple faith of the author sets to shame the imputation of barbarism. Izaak Walton a savage!

No; there is something better and higher than barbarism in the lover of honest woodcraft. As a rule, those who subscribe to sentiments hostile to true sport and sportsmen are persons reared under hot-house conditions, living artificial lives; the orchids and parasites of social degeneracy. The man who takes to rod and gun and loves the smell of smoldering camp fires has more good red blood coursing his arteries, and is more human and humane than his decriers.

Many men go into the mountains without the desire to kill in their hearts. A friend has evolved the theory that it is an excellent thing to go camping every year, because the soil absorbs the impurities of the body while sleeping in close contact with it. This, however, seems fanciful; the same effect would not be gained by sleeping in a back yard. Rather is the benefit derived from a complete change of air and scene; by the escape from the artificialities of society. The shrewd physician prescribes a return to elemental living for his world-worn patients, and he can always be sure of good results from these journeys to Nature. The balsamic ozone of primeval forests is a tonic without equal; the natural exhaustion due to following a brook,

rod in hand, is a panacea to the man played out in the struggle "on the street;" nervous dyspepsia disappears before the simple fare prepared over glowing coals in Nature's grill room. The soft musical lullaby of tinkling brooks, the drowsy nocturne of winds sighing in the pines, the patter of rain on a canvas roof, bring blessed relief to the city dweller accursed with nerves and insomnia. If this be savagery, would to God more men would forsake the walks of civilization.

But we have met a forked trail, and must back track. Too long have we tarried outside that magnetic window with its little knot of men, filching a few minutes from business to dream dreams and see visions. I doubt not every chap there was rehearsing in his mind some episode dear to his heart; felt his blood tingle at the strike and run riot as the reel sang and hummed with the rush of some monarch of the waters. A bright eyed, clean limbed young chap knocked my particular dream into a cocked hat by touching me on the arm and inquiring, "When are you going?"

When was I going? I swear the idea of going had not crossed my mind, but quick as a flash I said, "To-night;" and I went. What a joyous scramble it was to get

ready. Business affairs were whipped into a proper state in a jiffy. I wired my "Jim" that I was coming up country. I drove my family into a state of fever with my preparations. The duffle was thrown into my war-bag without preamble, and much fine gold passed out of my hands into the till of the store with the magnetic window. When I dropped into my seat on the night express, I was as tickled as a pup with your wife's best hat to chew.

All the world seemed to be going a-fishing. A whole bunch of royal good fellows foregathered in the smoking compartment and talked it over until it was almost foolish to think of going to bed. Jim met me at the station with a grin and the old sway-backed buckboard. More than that, he was genuinely glad to see me. Go to Europe and stay 5 years, and when your city acquaintances greet you on the return they give you a flabby handflap and murmur some rot about being glad to see you back. When one of your old guides welcomes you back, it's vastly different. Jim gave my hand a grip like a No. 4 trap, and fairly howled, "By George, here we are again!" That was all, but it was worth the price of admission. The rest would come in the evenings by the blazing fire.

A PLACE JUST WEST OF KANSAS.

FRANK WHITE.

There's a place just West of Kansas that is
wondrous bright and fair,
With its rugged, lofty mountains and abundance
of pure air;
All the atmosphere's been laundered, and
ironed out so smooth and fine,
There not only do they wash things, but
they also add the shine..

If you're sick of all those people, so you
don't know what to do,
And don't think that you'll be lonesome
when you cross the old Mizzoo,
Just come out here, West of Kansas, where
the space is wide and free;
For it's out here in the mountains that I
know you'd love to be.

Do you hear the train a-coming? Quick,
then; jump right on behind;
And while you are going Westward you'll
through scenic beauties wind.
You'll pass out o'er plain and prairies, leav-
ing all the dust and sand;
And when you can see the mountains, you'll
be in that golden land.

Come out here to Colorado, where the crystal
streamlets flow,
Where the sun is always shining, and the
Western breezes blow.
Come out here and see the mountains, with
their white tops in the skies;
Come and gaze on nature's wonders till you
scarce believe your eyes.

True it is, at times in winter, all the hills
are bleak and cold;
You must see them in the autumn, when
they're living green and gold.
Never brush can paint their picture, never
pen their glories tell,
For though simply woods and mountains,
Nature built them passing well.

And when your day's work is over, and you
close your weary eyes,
We will lay you in the foothills, 'neath our
pleasant Western skies.
Then in sunny Colorado, where the great
plains onward sweep,
In the shadow of the Rockies you will soft-
ly, sweetly sleep.



BELTED KINGFISHER, *CERYLE ALCYON*.

CANOEING ON THE TEMAGAMING.

C. E. T.

There are so many good canoe routes in Eastern Canada that it is difficult to choose between them. From Lake Temiskaming charming trips may be made in all directions. Among them the Temagaming route seems the choice of those most familiar with the country. They who once camp on it return year after year.

The Temiskaming can be reached by a branch line from Mattawa on the Canadian Pacific. From the terminus the steamer "Meteor" runs up the lake, lying over night at the little village of Ville Marie, and arriving at Haileyburg, 80 miles from the foot of the lake, early next morning. There provisions may be obtained at the general store of Paul Cobbold. He will also furnish guides, tents, canvases, blankets and every requisite for a trip.

The first portage, from Haileyburg to Sharp lake, is 7 miles, and a wagon can be hired to haul an outfit across it. The remaining portages average hardly half a mile, and are easily made.

At Sharp lake we had our first dinner in the woods. The principal dishes were fried bacon and baked potatoes, but never was a meal eaten with greater relish.

Dinner over, we arranged our baggage in the canoes and started on our 2 weeks' trip. It was but a short paddle through Sharp lake. Then we portaged to Mud lake and from there to the Montreal river, where we camped for the night on a high bluff with the river flowing swiftly and silently below us. Early next morning we started up river, and on being told there were fine bass in the stream, we quickly got out our rods. The bass, which weighed 2 to 3 pounds, were savage biters and we secured enough for dinner in altogether too short a time. After traveling 2 days up the Montreal, in which time we passed through Bay lake, where there is still standing an abandoned Hudson Bay Co.'s post, we reached Mattanapika falls. There we left the river to continue our journey to Lady Evelyn and Temagaming by way of Mattawapika lake.

The fishing continued good, and we saw many ducks, but they were wild and would go off at great speed as soon as we were perceived.

It was just before entering Lady Evelyn lake that we saw the only moose of the trip. We camped for the night at the mouth of the Ka-Mistik-Muskega river. About sunrise next morning we were awakened by our guides who told us there were 7 moose in the bay, a short distance from camp. You can bet that tent didn't hold us long. The moose had come out to feed on the tender lily pods in the river, but they soon noticed our white tents and took to the bush.

That day we passed through Lady Evelyn, a lake that must be seen to be appreciated. We passed through Diamond lake and over Sharp Rock portage into the king of lakes, Temagaming, which is worth traveling 1,000 miles to see. Words can not do it justice. Having camped for the night on Sharp Rock portage, the next day we paddled slowly up Temagaming and ate our dinner at the foot of Devil's mountain.

After visiting the several places of interest around there, about which queer Indian legends are told, we proceeded to Bear island, where the Hudson Bay Co.'s post is situated. There we camped 2 nights, the days being spent in fishing. The water of Temagaming is so clear that bass can be seen 10 to 15 feet below the surface. What is more, they can be caught, and few weigh less than 4 pounds.

As our time was fast drawing to a close, we bought enough provisions at the post to last until we should reach Temiskaming. Our route back was by way of White Bear lake, Rabbit lake and the Matabitchouan river, which runs like a mill race, with a few rapids to make it more interesting.

We found splendid camp sites and good fishing all the way out, especially in the little Bass lakes. Our last camp was pitched on the shore of the lake, and early next morning we boarded the steamer and were carried back to civilization.

Those who have the luck to go through Temagaming during the open season should not fail to take guns, for many grouse are seen on the portages. At the little lakes off the regular route, moose can be found at any time.

A woman on the death of her husband telegraphed to a distant friend:

"Dear Joseph is dead. Loss fully covered by insurance."—Tit-Bits.

CASUALTIES AMONG ANIMALS.

J. A. LORING.

Photos by the Author.

Few persons realize the different agencies by which animals are either captured or injured or meet unusual deaths. Most of us have read newspaper accounts of the destruction of birds migrating in the night, as they came in contact with the statue of Liberty, Washington monument, lighthouses and other such structures. Telegraph, telephone and electric wires are equally pernicious to bird life. In the West, where prairie chickens, sharptail grouse, ducks and mourning doves abound, it is not unusual to find their bodies lying under the telegraph wires, or beside railroad tracks, where they have fallen after dashing against the wires or cars, when frightened by approaching trains. Instances are recorded where birds, when suddenly surprised by trains rounding sharp curves, have flown into or against the open or closed windows of the cab or coaches.

About May 1st, 1902, I found the mangled remains of a whippoorwill, lying by a railroad track. It is possible the bird might have been killed by other means, and run over afterward, but owing to the nocturnal habits of this species and its fondness for perching lengthwise on rails, or fence boards, it is natural to suppose that it alighted on the track at night, and, dazed by the glare from the approaching engine, remained on the rail too long and was run over, as the nature of the wound seemed to indicate.

Such birds as cormorants and mergansers, fish eating birds, having the reputation of being gormandizers, not infrequently try to eat fish too large to swallow. Recently a case of that character came under my notice. A red breasted merganser attempted to swallow a large rock bass, tail first; a course of procedure that is strictly against the etiquette of any well bred fish eating bird or animal. The fins of the fish pierced the bird's throat and it choked to death before surgical aid could be procured.

Two similar cases of bird casualties were noted by a well known writer and artist. He found a yellow shafted flicker hanging from the trunk of a tree, its head fast in a crack at the junction of 2 large limbs. The woodpecker, while searching for insects, must have thrust its head into the seam opened by the swaying branches, and been caught when they came together. The same gentleman found a chimney swift impaled on a lightning rod which was attached to the side of a chimney where a number of swifts were nesting. The swifts would fly about the chimney, then dart into

it. This bird in descending miscalculated, and struck the sharp point of the rod with a force that pierced it completely through. The body remained there until disposed of by the heat and wind.

During the nesting season, such birds as the oriole, robin, chipping sparrow, and others that use horse hair, string and similar fibrous substances in building the cradles for their young, often become tangled in them and are either hung or strangled. I found a purple grackle, or common crow blackbird, thus suspended from the top of



PURPLE GRACKLE.

a maple tree. While gathering material and carrying it to its nesting site, the crow had selected a piece of common wrapping twine, which became entangled about one of its feet and then in the branches of the tree. Unable to free itself, the bird struggled until exhausted. By this statement I do not mean to intimate that these birds carry nesting material in their feet.

In the collection of birds belonging to

the Byron Sutton estate of Newark Valley, N. Y., is a chipping sparrow mounted in the position in which it met its death. The bird had built a nest in a lilac bush near a building, and had laid 2 eggs. While on the nest one end of a long horse hair became tangled about her head, and the other end was woven into the nest. Flitting off she tugged against the hair but only tightened the noose, which hastened strangulation and she died her own executioner. An examination showed that the



HOUSE WREN HUNG.

loop was formed by a sort of half knot, and a slight hook at the end of the hair prevented it from unfastening.

A most peculiar accident of the kind, and one which under the circumstances appears to have been vengeance, happened to a common house wren. A pair of chipping sparrows began building a nest in an apple tree that was preempted by a pair of wrens. The chippies and wrens frequently battled with one another and when the former finally finished their work, the wrens began to demolish the nest. An eye witness says the birds fought all one morning and started an afternoon session, when the skirmish was suddenly brought to a tragic end. The pugnacious little wrens vanquished the usually peace loving chippies; then with its bill one of the wrens continued to tear the nest apart. While struggling with a piece of twine, the wren tangled it around one of its feet, then about a limb and soon died. I mounted the wren without disentangling it from the fastenings.

I found an eave swallow dead by the side of a barn. It had caught one of its claws under its eyelid while scratching its head and was unable to free itself.

From the journal of the late Byron Sutton I copy the following: "The well known landscape painter, David Johnson, N. A., while at Lake George on a sketching tour, was rowing along the shore of Harbor island one August morning, when his attention was attracted by the flopping motion of some large object seen through an opening in the trees. On landing he was surprised to find a large golden eagle in a natural trap. In alighting on a forked sapling one of its feet had slipped into a crotch, and in struggling to free itself, the bird had lost its balance and when found was hanging head down. Its efforts had only served to fix it the firmer. The eagle was captured and subsequently presented to a zoological park.

A neighbor recently released a ruby throated humming bird from a large, tough spider's web. It is not generally known that when obtainable humming birds live extensively on young spiders. The bird, in searching for the insects, became tangled in the web and before it was freed, sharp scissors were necessary to release its tiny feet and wings from the bonds which securely held it.

A farmer owning a brood of young chickens, tilted the coop and placed a stick under one edge, that the old hen might have shelter at night. A great horned owl, while attempting to capture the hen, flew under the coop, knocked out the support, and the tiller of the soil was dumbfounded the next morning to find that he was the owner of an owl, instead of a coop of chickens.

Every museum of note contains one or more sets of deer or elk antlers that were found with the skeletons of the animals which had died after fiercely battling for the leadership of a band of does. In such conflicts, their antlers sometimes become locked, and being unable to pull them apart, the noble bucks suffer a death of exhaustion and starvation. Prof. L. L. Dyche, of the Kansas University, once shot a bull elk which had the tine of a combatant's antler broken off in its skull. The same gentleman, after several hours of difficult climbing, successfully stalked an Alaska white sheep and after shooting it discovered that one of its feet was crushed. It had probably caught its foot between a moving and a stationary boulder.

During my experience as field naturalist to the United States Biological Survey, I frequently captured small mammals with missing tails or legs.

While hunting in the Wyoming mountains, I noticed a pine squirrel acting ex-

ceedingly quiet and uncomfortable for an animal of its species. A close investigation revealed a number of porcupine quills fastened in its neck and shoulders. Several times I nearly captured it, but when almost within my grasp, a companion squirrel sounded a note of alarm, and it awoke from its stupor. It would be interesting to know the circumstances of the accident, for accident it surely must have been, as a pine squirrel has no business meddling with a porcupine. We can only conclude, therefore, that it ran against or jumped on the sleeping "quill pig" by mistake.

While once following the fresh track of

a common cottontail rabbit, I found where the little animal had run against a sharp stick while going at full speed. Marks in the snow showed that the concussion had bowled it over. A few steps farther, blood stained the snow and I soon came upon its body, frozen stiff under a bush. The branch had penetrated its vitals between its chest and right shoulder.

Mr. William T. Hornaday, director of the New York Zoological park, killed a crocodile that had lost a portion of its snout and upper jaw in a conflict. The reptile was starving, although it had lived long enough for the wound to heal perfectly.



AMATEUR PHOTO BY R. H. BEEBE.

ALMOST IN REACH.

One of the 18th Prize Winners in RECREATION'S 7th Annual Photo Competition.



CAROLINA RAIL, *PORZANA CAROLINA*.

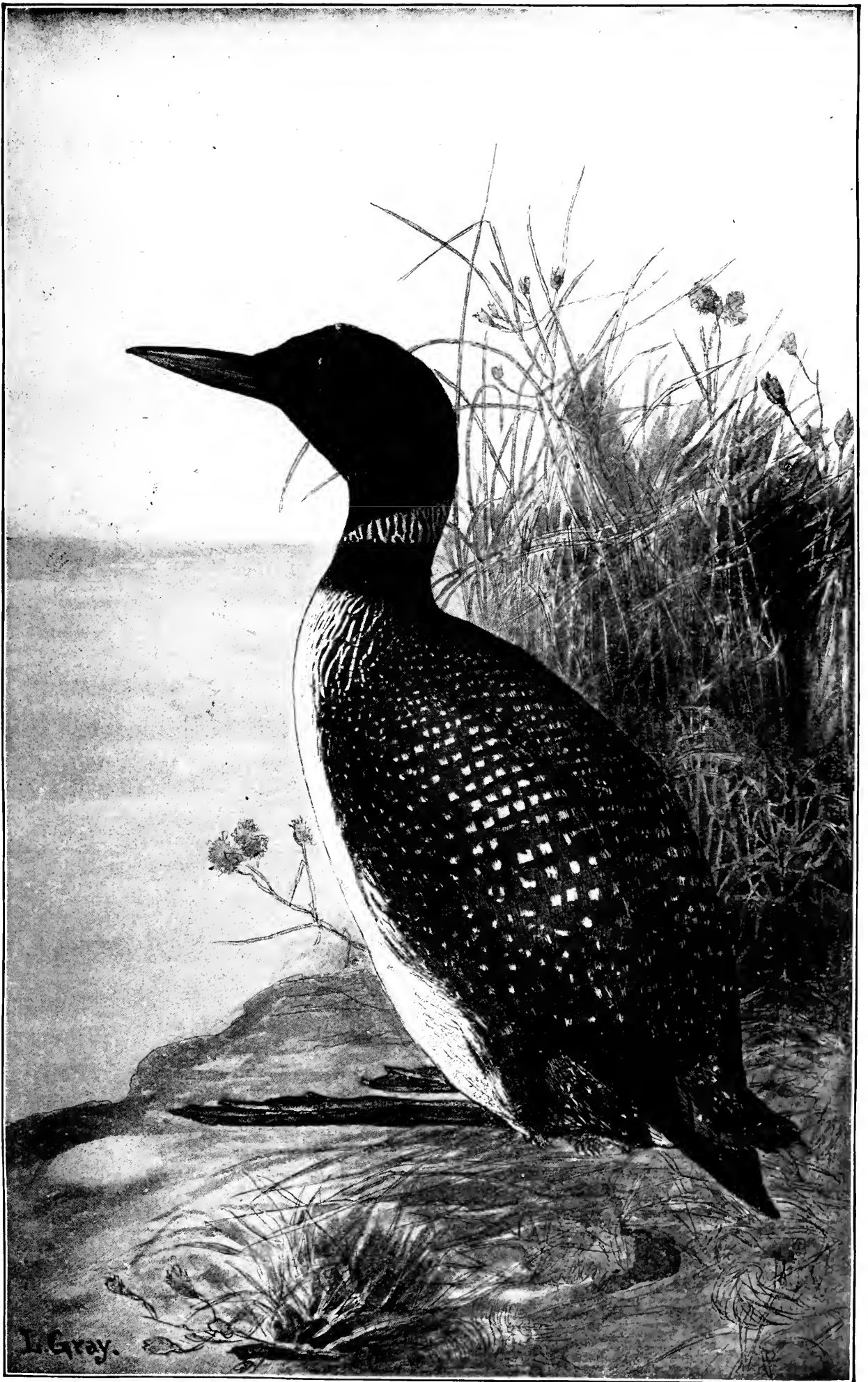

LOON (GREAT NORTHERN DIVER), *COLYMBUS TORQUATUS*.

A NEW MEXICO SAND STORM.

HARRY SUYDAM.

"We're going to have a storm," said the foreman of the Jingle Bob outfit, as we rode across the Pecos valley, in New Mexico. Looking in the direction the old cowman indicated I could barely see in the distance a dark gray disk, such as I had never before seen on the plains. I had been in the arid lands only 2 months, and there had been not a drop of rain during that time, though lightning was frequently seen in the evening, which told of showers in the mountains, 80 miles away.

Joe Nash, the foreman, and I had started out that evening with a team of horses and a buckboard to find a horse camp somewhere across the Pecos river and about a 3 days' drive from the Chisholm ranch. Little vegetation was visible in the valley, and the river was fast becoming only a creek, while the Rio Hondo, shown on the map with the same bold outlines as the Hudson, was at that time a dry arroyo.

We were standing near a chuck wagon that belonged to the Jingle Job outfit when Nash called my attention to the approaching shower. Before I could realize that there was need to prepare for trouble, the cook, who happened to be the only man with the wagon, hurriedly threw down a small tent, while Nash rapidly unharnessed the horses from the buckboard and hobbled them. I was a tenderfoot in the fullest sense of the term, but did not like to admit it, so instead of asking any questions, I took hold of the tent with the cook and hustled as did my companions. By that time the grey disk had developed into an angry, dark cloud, and was spreading over the calm, blue sky. Before we got the tent secured a delightfully cool breeze was fanning us. After the tarpaulins were firmly lashed over buckboard and chuck wagon, I stopped to enjoy the breeze and watch the storm speeding toward us.

I had been in storms on the Atlantic and on the Pacific that had caused sailors no little alarm, but when the threatened dangers had passed they left hardly any impression on my mind; but I shall never forget the fury of this my first desert storm. As far as the eye could reach not an object of man's handiwork could be seen. Only the excited chattering of the prairie dogs broke the ominous stillness. Occasionally a jack rabbit jumped from the sparse shade of a stunted mesquite bush and leaped to another. The scattered bands of cow ponies were stampeding to the few draws in the almost level plains, while our hobbled buckboard horses were struggling to reach some imaginary shelter.

Before the grey cloud had fairly reached us a heavy black one followed, and from it came peal after peal of deafening thunder. For 15 minutes there was such a fierce gale that it was only with the greatest difficulty we succeeded in keeping our tent from being blown across the Staked Plains into Kansas. We were almost buried with alkali sand, and I realized this was one of those fearful sand storms that occur in the desert, of which I had heard so much.

Then came the rain, and then inky darkness. Joe and I hugged each other on our bedding, which was barely covered by our little tent. The rain and wind continued throughout half the night, but shortly after midnight the clouds parted and drifted away; the moon came out and shone as the sun shines elsewhere. Then we looked out and saw that the lowlands all about us were under water. We thanked our stars we had happened to be on a ridge when the storm caught us. If we had not been we should have been swept into the Pecos, which was by that time a torrent of muddy water.

I had seen a New Mexico sand storm and a cloudburst all in one evening.

Manager—I want you to appear in just one piece holding a stick of dynamite.

Actor—And how many pieces would I appear in if the dynamite should explode?

—Life.

THE JUDGE AND I.

MENOQUET.

There are myriads of small lakes and innumerable small streams in the Northern and Eastern part of Indiana, which are as yet comparatively unknown to sportsmen. These lakes and their connecting waterways, bordered and shaded by tall trees and tangled thickets, and covering an immense tract of country, form a paradise for the angler which would have delighted the soul of Izaak Walton.

Here he could have wandered to his heart's content; here he could have revelled in pursuit, not of roach, dace and chubb, but of a far nobler and more wary warrior of the troubled waters, the black bass. One familiar with the locality can readily imagine with what pleasure Izaak would have threaded his way, rod in hand, beneath the glorious canopy of leaves, noting the long sun arrows lighting the crystal depths, the sunken log or overhanging alder. What tales he would recount in his quaint, sweet way, to some boon companion, of battles won by skill and patience.

The upper Tippecanoe, the principal stream of this region, is little frequented by sportsmen, other than he of the bent pin and bare feet, yet here can be had a day's bass fishing that will satisfy any reasonable man. Even the farmer who waters his cattle at its brink seems only to know it from the bend above to the one below.

The Tippecanoe is a crooked stream, spring fed and cool and perfectly clear. It flows through some of the richest farming lands of the State.

In its tangled thickets can be had fine woodcock shooting in season. Many wild ducks breed each year among the bayous and lakes of the upper river. Its waters are alive with many varieties of food fishes, and to the skillful angler the reward is certain.

At 3.30 on a fine morning, late in last September, I arose, donned my corduroys, took my rod, tackle and lunch bag, and slipped quietly out of the house and over to the Judge's across the way. The weather promised to be all we could desire, cloudless and with a suspicion of frost in the air. It was one of those mornings when there is a little ice on the edges of the river; just cool enough to make the blood tingle and to make one feel in every fiber that life is a glorious privilege in this old world of ours.

The Judge is a gentleman and a thorough sportsman who, as he expresses it, "practices law when he can't go fishing." Though he confesses to 70 years, his firm,

erect carriage is ample testimony that 60 years of fishing and hunting is good for the health. He has taken fish and game in the most favored localities of the United States, but still has a warm place in his heart for the Tippecanoe.

We found the driver awaiting us at the appointed place, with the boat ready loaded, and climbed in for our 3 miles' journey to the river. We were after black bass, that picaroon of the fresh water, well known as a fighter of the first order. When he takes the fly he is dead earnest, and, if of good size, one many confidently expect a battle that will fully test both skill and tackle.

After dismissing the driver and launching our boat, we ate breakfast with appetites born of the keen air and anticipations of the sport to come. The meal over, hamper repacked and rods set up, we started up stream. Just after we passed under the wagon bridge, the Judge made 2 casts and each time landed a bass of a pound weight. Feeling that our day was well begun, we rowed up stream a quarter of a mile or more, casting into every likely place, but with no results. Then through a tangle of lily pads, fallen logs and stumps of trees killed by the back water from the dam below. It was a nasty bit in which to navigate even so small a craft, but we finally arrived at the clear water, 100 yards above, with the railroad bridge just in sight around the bend. Here the Judge discovered that his rod was missing. He had put it down to assist in forcing the boat through the lily pads, and it had quietly gone overboard. Our strongest adjectives failed to bring it back to us, so we went and got it.

Just below the bridge is a great heap of sunken logs with plenty of deep water underneath, shaded by the interlacing branches of elms above. It is a famous place for bass and many a one has fought his last fight there. While I held fast to a pier, the Judge made a beautiful cast and dropped his fly just where he wanted it, as the result proved. There was the quick flap of a broad tail, a gleam of gold, a sudden bending of the little rod and a wild leap into the air, followed by a great splash and a sullen and deep plunge to the bottom. After sulking for a time, the fish suddenly broached again and fought fiercely, trying to get under the logs. Balked in the attempt, he rushed back and forth across the stream, the taut line cutting concentric designs on the water. Again

and again the captive broached, sending up showers of water, but his gallant fight was of no avail; his sudden rushes up stream to gain a little relief from the distressing strain were useless. Then he would float sullenly down with the current, but at the first attempt to land him he would dash off with apparently undiminished vigor. But each rush was shorter than the last; each effort weaker, and we finally lifted him aboard. He weighed $3\frac{3}{4}$ pounds, and every ounce was game.

After resting and getting a drink at a spring above the bridge, we proceeded leisurely up stream, taking turns at casting but with indifferent success; the fish rising less frequently as mid-day approached.

When it was time for dinner we tied up at a mossy bank. The Judge started a fire and filled the coffee pot at a spring while I prepared several of the smaller fish for the pan. One who has never eaten fish freshly caught, and cooked by one of experience in such matters, and amid such surroundings as ours, has missed much. We were hungry, and the way fried fish, baked potatoes and coffee disappeared wasn't at all in accordance with the rules of polite society.

Dinner over and pipes lighted, we lay down on the bank and the Judge told tales of other fishing and hunting days until we were lulled to sleep by the murmur of the stream at our feet.

About 2 o'clock we started down stream. The rowing for the day was done, as the current was sufficiently strong to move our little craft with rather more speed than

was desirable. Fish rose well and furnished fine sport; and all weighing under one pound were returned to the stream. Thus, homeward at the close of a beautiful day, the Judge and I have drifted many times, ever feeling that we have found the true fountain of youth, here on the Tippecanoe.

I am convinced that small mouth bass weighing 4 pounds are rare in this latitude and particularly so in the upper Tippecanoe, but smaller ones are plentiful and in the autumn always in the best of condition. They are lusty fighters and breed here, almost undisturbed, in great numbers.

We have used with great success a fly that is undoubtedly a killer and one which I wish all bass fishermen would try. The "Monoquet" is the joint product of a friend and myself and named after the old Indian town on the banks of the stream we both love so well. The shoulders are of red ibis feathers, the wings are made entirely of buck hair, colored a bright lemon yellow, legs of soft black hair, body rather full, of dark green silk floss, all tied on a No. 5 old fashioned Limerick hook. It is a striking color combination and the bass go into ecstasies over it. We use the thick shanked hook as it does not cut out so easily and rides without wobbling from side to side. Attach this fly to a No. 1 or 2 spoon with enough small steel swivels to make the weight $\frac{1}{4}$ to $\frac{1}{2}$ ounce, and you will have one bait that will prove worthy of a velvet lined compartment in your tackle-box.

A NEW YORK BEAR.

A short time ago while out hunting, a few miles from here, Mr. Charles Ferris, a guide of this place had the good fortune to run across a large black bear and kill him.



AMATEUR PHOTO BY G. H. ORVIS.

The bear measured 7 feet from tip to tip, and weighed, dressed, 262 pounds. After Bruin was brought to town several photos of him were taken by the amateur photographers of the place, who felt it a privilege to take even a snap shot of a dead bear, though they could have no hand in slaying him. One of these photos I enclose.

Bears have been more numerous here the past year than during any year previous for some time. Mr. Ferris has killed 14 bears about here the past few years.

The number of deer in this vicinity does not vary much from former years. Mr. Ferris has an excellent hunting lodge a few miles from here in a favorable deer locality, and has proven himself an efficient as well as companionable guide.

G. H. Orvis, Fine, N. Y.

ON THE MANISTEE RIVER.

A. ST. J. NEWBERRY.

Two hundred miles Northwest of Detroit, about half way between Lakes Huron and Michigan, and almost exactly on the watershed between them, the town of Grayling stands, on light, sandy soil, of no value for agriculture, and surrounded by miles of stumps, all that the axe and saw have left of once splendid forests of white pine. Through the town itself flow the head waters of the Ausable, "the river of the sands," on their way to Lake Huron; and a few miles to the West and North the Manistee begins its course to Lake Michigan. At one point the rivers are scarcely

coarse, fighting with fury when hooked but almost worthless when on the table, they take the place and the food of their betters, to the disgust of all right minded anglers. They are a little better than pickerel, but not much. This is hearsay evidence, but I have no doubt it is true.

The Westward stream, more fortunate, contains no rainbows, and a good many grayling, though the speckled trout predominate. Visiting it in August, 1901, we took trout and grayling in about equal numbers and size, and often alternately from the same pool or riffle. Going there in



AMATEUR PHOTO BY A. ST. J. NEWBERRY.

OUR CAMP ON THE MANISTEE.

more than a mile apart, being separated only by a low, sandy ridge. Those streams, like nearly all in that vicinity, are the original home of the Michigan grayling, and a few survivors of that beautiful species still linger there, though logs have torn through their spawning beds, and intruding *fontinalis*, having worked its own way in from other waters, and *irideus*, unwisely introduced by man into the Ausable, have harried and persecuted their more timid and delicate predecessors. My guides say that today the Eastward river contains few grayling, many speckled trout, and great numbers of rainbows, which monopolize the best water to the exclusion of their more delicate and attractive associates. Big,

June, 1902, and fishing the upper waters only, 4 of us took in 4 days 150 good sized trout, and not a single grayling. I fancy that the spawning beds are lower down the river, and that *thymallus* had not yet ascended, after their spring nuptials, to the part of the stream where we were camped.

The Manistee has a steady and moderately rapid current, flowing over clean white sand; no rapids, but an alternation of pools and shallows. The best trouting this spring was on its course through a large tract of cedar swamp, where the trees had all been killed by fire or flood, and lined the water's edges with a mass of fallen trunks and tops. Among these the flies must be deftly placed, using a rather long line; and a hooked fish

must be hauled away from danger, if possible, before he finds out what the trouble was, and begins to run. When he would not come, as was not infrequently the case, things happened, and happened fast. More than once I stopped a pound fish, in his first mad rush toward a submerged cedar top, by sheer strength of rod, line and leader, and more than once I did not; but the 6-ounce rod, and the little No. 10 fluttering flies did good work all through, and not a fish was lost by failure of tackle.

One must camp to fish either river to

good advantage, and excellent guides and camp outfits can be had in Grayling, though arrangements should be made well in advance.

On these rivers the fish, when boated, are put into a box under the angler's seat, which communicates freely with the river. Those not needed for immediate use are kept alive in a fish crate of slats, so that they are in perfect condition to take home; that is, if one be a resident of Michigan. The law prohibits the taking of fish or game out of the State.



AMATEUR PHOTO BY W. H. S. VERY.

YOUNG SCREECH OWLS.

Winner of 11th Prize in RECREATION'S 7th Annual Photo Competition.

FROM THE GAME FIELDS.

The man who quits when he gets enough, with plenty of game still in sight, is a real sportsman.

THE WOLF IS IN THE PARK.

RECREATION has received \$45 for the wolf fund. Checks for that amount have been sent Miss Murray and she has shipped the wolf to the Washington Zoological Park. The following letter explains:

"National Zoological Park,
Washington, D. C., Feb. 10, 1903.

"My dear Sir: The wolf from Miss Murray reached the Park this morning in excellent condition. It is a well grown animal, in fine pelage, and is a valuable accession to our collection.

"The Zoological Park is under great obligation to RECREATION for its kind efforts, which have resulted in securing this fine animal.

Truly yours,
(Signed) "Frank Baker,
"Superintendent."

Here is Miss Murray's acknowledgment of the check:

Peosta, Iowa.

I received your check of \$45, for which I am thankful in no small degree.

(Signed) Irene Murray.

Here is the list of contributors to the fund:

Samuel Rudy	\$.50
H. H. Todd.....	.50
J. S. Emans.....	.50
Henry Blank.....	.50
A. V. Huyler.....	.50
Geo. Dillingham.....	.50
J. B. Lozier.....	.50
M. D. Mason.....	.50
N. H. White.....	.50
W. L. Ward.....	.50
I. S. Phippeny.....	.50
Thos. F. Crawford.....	.50
H. M. Pentecost.....	.50
W. F. Copithorn.....	.50
Jas. Gibson.....	.25
John Dennison.....	.25
S. S. Ellis.....	.50
Wm. T. Hornaday.....	1.00
S. S. Haynes.....	.50
W. H. Jones.....	.50
F. W. Jones.....	.50
J. F. Kepler.....	1.00
A. Lindeman.....	1.00
C. L. Hart.....	.50
Harry Miles.....	.50
C. W. Potter.....	.50
Henry Munsy.....	.50
W. M. Borrowdale.....	.50
Wm. I. Mitchell.....	1.00
E. B. Gosse.....	.50
Chas. B. McLaughlin.....	.50
W. F. Ulrich.....	.50
S. R. Treat.....	.50
Henry Loeb.....	.50
H. E. Mills.....	.50
H. J. Peckham.....	.50
E. S. A.....	.50
A. M. Loomis.....	.50
W. C. Reaves.....	.50
H. V. Radford.....	.50

J. L. Leist.....	.50
Ernest Russell.....	.50
C. H. Sloane.....	.50
G. E. Dimock, Jr.....	1.00
M. Sauser.....	.50
Edward Wilde.....	.50
E. T. Seton.....	1.00
S. A. Stover.....	.50
L. C. Ivory.....	1.00
W. E. Coffin.....	.50
A. A. Anderson.....	1.00
Dr. T. K. Tuthill.....	.50
John Tredwag.....	1.00
Anonymous.....	.50
I. Northey.....	.50
J. E. Kelley.....	.50
H. H. Rogers.....	.50
Dr. Ida L. B. Goss.....	.50
James Eckels.....	.50
Capt. E. B. Rogers.....	.50
E. H. Fitch.....	1.00
Dr. R. T. Morris.....	.50
L. M. Thompson.....	.50
Jas. M. White.....	.50
Geo. W. Healey.....	.50
E. M. Healey.....	.50
Thos. B. Moore.....	.25
Phil. Montz.....	.50
R. A. Buttke.....	.10
John H. Wright.....	.24
Dr. C. C. Curtis.....	.50
O. F. Bruner.....	.20
M. S. Parker.....	.50
L. A. Dougherty.....	.50
W. W. Cook.....	.25
John Henderson.....	.25
J. O. Johnson.....	.25
Dr. J. Hoover.....	.50
O. F. Harlow.....	.50
Wm. M. Williams.....	.50
C. M. Reed.....	.25
J. H. Houdley.....	.25
W. J. Salisbury.....	.25
George Sims.....	.50
A. T. Elias.....	1.00

Total\$45.00

Should any further contribution come in, the amount will be promptly remitted to Miss Murray, and readers of RECREATION may rest assured she will make good use of the money.

STOP SPRING SHOOTING.

An effort is being made to repeal the prohibition of spring shooting in Wisconsin. This would be a most unfortunate retrograde step for the State of Wisconsin in the matter of game protection. Wisconsin now has laws that protect the game and that will enable true sportsmen to enjoy health and recreation for generations to come; but if the efforts made for the repeal of this law should succeed, that State will have lost its proud position among the foremost game protecting States in the Union.

When ducks return from the South they are mated and ready to breed in the first favorable place where they can remain undisturbed. If spring shooting is allowed

nearly all the birds are driven to the non-inhabited regions of the Northern United States and Canada. In that country the summer is so short that many birds which would breed twice, farther South, can breed only once. If their nests should be destroyed the summer would be too short for them to raise a second brood; and thus the number of young birds raised would be materially decreased.

A few years ago, when Minnesota's prohibition of spring shooting went into effect, I had exceptionally good opportunity to observe the effect of this law in Southern Minneapolis. On one lake I found, in the later part of August, by a careful estimate, 800 young redheads, raised on that lake. There were also large numbers of blue-wing teal, mallard, canvasback and pintail ducks that had been on the lake; but as these kept more in hiding, it was not possible to make a definite estimate of their number. The observing sportsmen of the region were unanimous in the opinion that if spring shooting had been permitted not one-fourth the number of ducks would have been raised in that region.

In spring the birds are lean and unfit to eat. Most of them are already mated and the females are full of partially developed eggs. To shoot birds in that condition is as unsportsmanlike and as barbarous as to shoot a doe that is with a fawn.

Our game should remain as abundant as agriculture will permit. If spring shooting is prohibited the sportsman will be able to secure a reasonable bag of birds, even if he can not go after them more than a day or 2. If spring shooting is allowed game will become so scarce that only the wealthy can afford to get any by going after it a great distance. The prohibition of spring shooting is a truly democratic measure, because the majority of people can not afford to go hunting hundreds of miles and to drop their daily work for weeks at a time. Only market hunters and those allied with them can possibly have any interest in the repeal of the prohibition of spring shooting in Wisconsin. It would be of only temporary benefit even to them, because this very law they desire repealed would soon annihilate their own trade.

The strongest efforts should be made and are being made by all true sportsmen and true game protecting societies to prohibit spring shooting everywhere. In the Legislature of Minnesota the repeal of the prohibition of spring shooting would not receive a moment of serious consideration. Wisconsin, Minnesota, Montana prohibit all spring shooting, and Utah, Wyoming and Colorado will pass laws to that effect this session. While nearly all the States are moving in the right direction, Wisconsin should certainly not take such a fatal step

in the wrong direction. Spring shooting must be prohibited everywhere!

D. Lange,
Supervisor of Nature Study, St. Paul Public Schools. Chief Warden, Minnesota Division L. A. S.

THE GOLD RUSH AND THE GAME.

I spent all summer in the mountains of Idaho, Wyoming and Colorado, and traveled 1,300 miles with pack horses in the Thunder mountain mining district. It was pitiful to see the slaughter of does and fawns. About 5,000 men went into that rush and every one carried a gun. The district being 175 miles from railroads, it was necessary to kill game for food, but there were bucks enough for all. Does were shot in June, and many tiny fawns were left to starve.

A doe accompanied by 2 fawns often came to a spring near our camp on Monumental creek. She had one front leg broken off at the knee, the lower part swinging, but she was faithfully looking after her family. One evening, in camp in heavy timber, I was playing the flute while the boys sat before the fire, when out of the darkness stepped a large doe. She came within 15 feet of the fire. We drove her back into the timber several times, but at the first sound of the flute she would return.

In Yellowstone park bears tore down our tent and scattered our provisions, including a sack of flour, all over the woods. We chased one rascal up a tree; then climbed an adjoining tree and got a good snap at him. The soldiers had previously killed a large grizzly that persisted in tearing down their mess tent. They fired a volley of 30-40's, killing him instantly. Bear are so plentiful in the park that there is talk of killing the older ones.

In Jackson's Hole the game wardens arrested a fellow with 52 pairs of elk teeth in his possession; all from elk killed out of season, for the teeth only.

We carried 25-35 Winchester carbines on account of their light weight, and succeeded in killing all the game we needed; yet as hunting arms, they are too small. The lead used in the soft points is so soft that it goes to pieces on impact. In every case, the ball tore a large hole where it entered, but lacked penetration. I shot a buck in the rump; the external wound was the size of a teacup; the ball penetrated 6 inches of flesh and stopped against the hip joint, without injuring it. Only once have I seen a 25-35 go through a deer. The 30-30 is no better. The .303 and 30.40 are good game guns, but the new 35 comes nearer being what is wanted. Any old gun will

kill when a vital spot is hit, but the small bore smokeless wound more than kill.

I have used a telescope on my gun several seasons, and would not be without one.
Sam Stevens, Cripple Creek, Colo.

KILLED TOO MANY TURKEYS.

I have been a reader and an ardent admirer of RECREATION for some time, and am particularly pleased with the way you go after the game and fish hogs of the elm-peeling, razorback variety. I was much interested in an article in your February number contributed by John F. Bailey, entitled "In the Arkansas Mountains." The writer describes that evidently interesting and beautiful bit of country with much skill and in a way that makes us, of this Northern climate, at the closing of winter, long for warm, sunshiny days, our guns and fishing rods, with the open fields, woods, streams and lakes before us; but in reading the article I wonder if it impresses others as it does me that Mr. Bailey almost, if not quite, convicts himself and his friend of the crime of razorbackness, the most heinous known to true sportsmen. I may pass without comment the first day out wherein 15 quails were killed within 20 minutes and 18 quails and 9 squirrels were the result of one day's travel, when the writer and his friend were not really hunting; but certainly a real sportsman will stop to consider the justice of 2 hunters killing 5 wild turkeys in one day, not to mention the turkey killed by the guide. At a time not yet beyond the memory of many of your readers this largest and noblest of American game birds was common over a large area of the Central Western, Western and Southwestern States; but his peculiar habits, enormous size, and awkwardness on wing and foot, made him an easy prey to the white and red biped variety of hogs, until he is now rarely to be found. The fate of the buffalo is his; and if the government does not soon do something to protect his species, he will be classed with the dodo and other extinct species of forgotten ages. So scarce has he already become that he is seldom found outside the fastness of unfrequented mountains and forests of the Southwest; and when these remote retreats are located and invaded by the ruthless hunter, the turkey's days are numbered. As clearly shown by Mr. Bailey's article, when once located a bunch of wild turkeys is at the mercy of the experienced hunter, and will respond to call as long as one of the number remains alive. Knowing this fact, the method resorted to by Mr. Bailey and his friend was questionable, to say the least; and in this manner to bag 5 of these enormous birds in one day was certainly swinish in the extreme.

Warren W. Borders, Winamac, Ind.

A SPRING TRAMP.

Nature had thrown off its cloak of snow and silence and suddenly transformed the fields and roadsides into a vast stage, on which song sparrows vied with robins and bluebirds in producing joyful music to welcome the awakening of spring. Purple grackles flew overhead in huge flocks, bluebirds carolled from telegraph wires, and a huge red tailed hawk swooped down on an unsuspecting chipmunk which had just emerged from its winter nest.

C. and I started early for a long tramp to the mountains, where we hoped to secure some owls' nests. We followed the electric car tracks a short distance, now and then producing our note books to record the appearance of a new arrival in the bird world or to note the appearance of an early hibernating insect; looking particularly for large migratory birds, and for *Venessa antiopia*, the first out of the hibernating butterflies. We reached the mountain about noon and proceeded to scour the surrounding thick woods. Starting in different directions to make a detour, we agreed to meet at a certain landmark 2 miles distant. Each was to call if he found anything.

Before long I came to a slender stump about 8 feet high, in which some chickadees, or hairy woodpeckers, had evidently nested the previous year. As I passed I gave it a slight push and it fell over. It had no sooner touched the ground than 3 little flying squirrels crawled out of the hole and scampered away, 2 up a tree and one into a hole in the ground. I gave a yell that would make an Indian turn green with envy and started after them. My large collie, Bruce, prevented the squirrels in the tree from leaving it. When C. came up we soon decided that the only way to secure the little animals was for one of us to climb the tree and shake them off. While C. shinned up I tried to calculate how far they could fly, but did not guess right. One sailed 20 feet over my head and the other went in the opposite direction. Both landed in trees, and, running to the topmost branches, they launched forth again. They could sail about 150 feet and looked like white, square pieces of cardboard. They finally reached trees from which it was impossible to dislodge them and we turned our steps homeward.

Bob O. Link, Glens Falls, N. Y.

SLAUGHTER OF BIG-HORNS.

Judge J. R. Harper's recent hunting expedition to the mountains in the vicinity of Van Horn was successful far beyond that eminent jurist's expectations.

He was accompanied by J. H. Beech, who is familiar with the country frequented by the few sheep still alive in Texas.

Five splendid mountain sheep were killed; 4 tremendous bucks and one doe; and several of these were brought to El Paso as trophies of the chase. Three of the bucks occupied places of honor all day yesterday at Nation's market, where they attracted unlimited attention.

Mountain sheep are fast becoming extinct in West Texas. Like the buffalo, they have disappeared before the energetic assaults made by the American hunter.—El Paso Daily Times.

I make it a rule never to accuse a man of game slaughter without giving him a chance to deny or extenuate the charge. To my request for their version of the foregoing story, Judge Harper and Mr. Beech replied as follows:

A friend and I killed 4 bucks out of a bunch of 11.

Do you want the story or are we game hogs?
J. R. Harper, El Paso, Tex.

On the hunt to which you refer, my friend and I killed a deer in the early morning and 5 sheep later in the day. We had, however, been out 4 days before that, the day on which we killed them being the fifth of the hunt. About August 20, Mr. Vernon Bailey, of the Biological Survey of Washington, D. C., was here, and we were out but about 5 hours till we killed a fine specimen for the National Museum. I suppose that by this time it is on exhibition there.

J. H. Beech, Van Horn, Tex.

I am surprised and grieved that any man should have killed a mountain sheep in Texas at this late day when there are so few left there. Any man who has the interests of that State at heart, as Judge Harper should have, should consider these few remaining big-horns as wards of the State and should not only have refrained from shooting at them, but should have exerted his great influence in restraining others from doing so. The Texas Legislature should pass a law at the earliest possible day to prohibit the killing of mountain sheep in that State at any time. Such laws should not be needed for progressive, thinking men, but the ignorant and thoughtless game hogs must be restrained.—EDITOR.

THIS SOLDIER IS A HOT AIR HUNTER.

Hon. Thos. Ryan,
Acting Secretary of the Interior,
Washington, D. C.

I have before me what purports to be a copy of a letter written by one of the soldiers stationed in the Yellowstone park, stating that he recently killed 25 ducks and that there is good hunting in the park because no one is allowed to hunt there but the soldiers. As I understand the regulations, even the soldiers are not allowed to kill game there. Will you kindly enlighten me on this point?

Yours truly, G. O. Shields.

ANSWER.

The Acting Superintendent of the Yellowstone park, to whom your letter was referred, reports that the soldier in question has never caught a fish or killed a bird or an animal of any kind since he has been stationed in the park; that he has never been out of the post of Fort Yellowstone, except on the regular road, as far as the Golden Gate to the South and to the town of Gardiner to the North, neither of which points is more than 5 miles distant. He states that the story is absurd, and that if the letter in question was written at all it was a boyish piece of nonsense, which the writer has had cause to regret on many occasions. He would no more think of killing the ducks or other birds of the park than he would of killing the deer which can be seen any day grazing on the parade grounds and on the lawns between the quarters, sometimes coming up to the doorsteps.

The officer also states that the ducks and geese understand quite as well as the deer that they are absolutely safe in the park, and this is shown by the fact that at any place in the park one can walk within 20 feet of them without their getting up.

The Acting Superintendent wishes me to assure you there is nothing in the park in which the authorities are more interested than in the game, and that not a shot can be fired within its limits by anyone save by the scouts when in pursuit of mountain lions or coyotes.

Thos. Ryan,

Acting Secretary of the Interior.

THE MEASLY SWINE OF MONSON.

Monson's mighty hunters took the field last night at 6 o'clock, and until 9.30 this evening game of all kinds in this vicinity will lead a life of abject terror. The annual hunt is on and terrific slaughter is expected. J. P. McCarthy and George O. Wyatt are the captains, and each has 25 merry men at his back. The men must all be at the Century house at 9.30 this evening with their game, which will be counted by men selected for that purpose. A game supper will be served at the hotel Thursday evening, to be paid for by the losing side. In making up the score coons will count 300 points, foxes 200, ducks 175, grouse 150, woodcock 125, quails 100, gray squirrels 90, rabbits 75 and red squirrels 50.

The men will work under the directions of their captains to a certain extent, but the only general orders are to bring in all the game that can be found, and to find more than the other side. Hunters who have a particular leaning toward any particular kind of hunting or game will be allowed a free hand. The game to be presented for the count must, according to the rules, be shot during the hours of the hunt. There have been some years when part of the game has been thrown out. The counters have held that when game was so badly decomposed that it was impossible to tell just what the animal or bird might be, it ought not to be counted. Connecticut game is not barred, and as the State line is only 5 miles from the village, some of the men are likely to cross it. Assistance will be rendered such as are unable to bring in their game without it.—Springfield (Mass.) Republican.

The decent sportsmen in Monson, if

there are any, should have organized a counter side hunt to be conducted on the same day. The only game to be killed should have been game hogs, and every one of those participating on either side of the original side hunt should have been made legitimate targets for the rifles of the regular sportsmen. The bristlebacks should have been scheduled to count 100 to 500 points each, according to age, size and length of bristles, and the undertaker should have been paid for his services in planting the swine. Lynch law is not popular in the Northern States, more is the pity, but will become so in time unless some other means can be adopted preventing such disgusting swine as these from slaughtering game. The Springfield Republican gives portraits of the "captains" of the butchering match. Judging from the looks of the men, if I had to live in that town I should keep my house and barn securely locked, day and night.—EDITOR.

HARD, YET NECESSARY.

I am a reader of RECREATION and a believer in its doctrines, and yet I am in a queer box.

You insist I shall not shoot ducks in spring. When, then, shall I shoot them? They are here at no other time.

It is many years since they quit coming in the fall. The country is too thickly settled and too well drained to give them a chance to stop in the fall.

We have a good many rabbits, and a few quails, but they should be left alone for several years to give them opportunity to increase.

I should like to go to some place where game is plentiful, for I am fond of hunting and fishing. If I want a duck I must shoot him in the spring.

A. Reach, Peotone, Ill.

Your position is certainly a most serious one. It does not seem fair that a man should give up all wild fowl shooting for the benefit of his fellow men; yet some men are always willing to deprive themselves of certain pleasures, or to perform arduous labors for the benefit of the public or their friends. On these lines you could well afford to forego the pleasure of killing ducks and geese. I regard it as almost a crime to kill birds of any kind in spring, especially a female bird when on its way to its nesting quarters. The satisfaction of killing a goose or a duck is but momentary and the satisfaction in eating such a bird is a matter of an hour at most. In fact, there is little enjoyment in eating water fowl killed in spring when on their way North. Personally, I will never kill another water fowl except in the fall, and if one man can afford to adhere to such

a resolution, certainly another can. You should, of course, be able to make a trip in the fall to the Mississippi or Missouri rivers, or somewhere else in the West or Northwest, where you could get plenty of water fowl shooting. If you can not do this, you are, as I said, in hard luck, but all the same you should not shoot in the spring.—EDITOR.

TROUBLE FOR POT HUNTERS.

J. D. Burford, the new game and fish warden of Missouri, has on his war paint, according to the stories told by late arrivals in the city from Southeast Missouri. In that section of the State alone he has lately obtained over 200 convictions for violations of the game laws, and he announces that as soon as he is through with this class of lawbreakers he will give a matinee, for the benefit of the school fund, with those who have violated the fish law for actors. All fines collected from prosecutions for violations of the game and fish laws go to the school fund.

Mr. Burford, even this early in his career as a State official, has caused a regular stampede among the pot hunters and the men who kill fish with dynamite, and his friends promise that he has not yet fairly warmed up to his work. He seems to be able to convict every person against whom he files information, and he possesses remarkable facilities for finding out who the lawbreakers are.

When the next General Assembly convenes an effort will be made to provide the Game and Fish Warden with a suitable salary and place some funds at his command for the employment of deputies in localities and at seasons of the year when they are needed. Now he receives nothing but fees, and at best his labor is poorly paid. One objection heretofore made to giving the Game and Fish Warden a stated salary was that the law would not be enforced any way, and so there was no use in throwing money away. It appears that Mr. Burford has met this objection by proving that he will enforce the laws, even when poorly paid for so doing.

The game and fish laws have been more openly and persistently violated in Southeast Missouri than in all other parts of the State combined. Heretofore it has been the practice of pot hunters to kill game in that section of the State, in season and out of season, and ship the same to the market without the least regard for the requirements of law. Mr. Burford has planted his heavy artillery in that section, and with 138 deputies is making life a burden to the pot hunters and to the game dealers who undertake to ship game killed out of season. Now, it is said, this class of offenders are beginning to realize that the Legislature did not enact the game and fish law to be laughed at, and they are looking for more congenial quarters.—St. Louis Globe-Democrat.

Thank God, here is one officer who is a good hunter. His example is strongly commended to a certain officer at Albany, and to many in other States, who seem to exist merely for the purpose of drawing their salaries, and who fear to prosecute lawbreakers lest they may lose votes at some future election.—EDITOR.

LION, BEAR AND GROUSE.

Dr. Oschner of this town recently had a peculiar experience. While hunting deer near here, with R. A. Carroll, he came suddenly on a forest tragedy. A large mountain lion had a buck down on the ground. When he saw the hunters he

made off, was pursued by the dog, treed and killed. The hunters then returned to the buck, which was found dying. His ribs were broken and his head pounded to a jelly; but there was not a mark of tooth or claw on him. The skin was unbroken. He was simply pounded to death. Carroll, who is an old hunter, declares that to be the lion's favorite manner of killing deer. He says he has known of several such cases. It is a new one on me.

A bear recently came down into the town of Telluride, at night. He was seen, and many shots were fired at him, but he escaped.

One afternoon the owner of a ranch on Bilk creek was standing by his cabin. He heard a rock roll down the canyon wall, and looking up saw a medium sized black bear going into a hole, under the rim rock. The ranchman climbed the hill, smoked the bear out and killed him with one shot through the head. The skin was a beautiful one, and I bought it. The same bear had recently been trapped in the neighborhood, and had escaped, leaving his foot in the trap. Hearing of this, and knowing who had the foot, I procured that also, and will have it sewed on the leg, when the skin is made into a rug.

Just before the close of the grouse season I had a delightful afternoon with the birds, at timber line, on Mt. Wilson. They were feeding in the spruce trees. As they always fly down the mountain side, when alarmed, I had a friend go about 200 yards above me. We then moved along the side of the mountain on parallel lines, the birds that he flushed flying over me. I killed 8, the soft snow saving them from being dashed to pieces on the rocks below.

C. M. Coleman, Telluride, Colo.

DEFENDS WESTERN GUIDES.

W. S. W., Pittsfield, Mass., criticizes, in November RECREATION, statements made by one Finn in the New York Times, concerning residents and guides of Jackson's Hole, Wyo.

About September 15, 1901, 2 Massachusetts men came to my camp on a small tributary of Fall river, late in the evening, having been attracted by the light of my fire. I believe W. S. W. to have been of the party, which was guided by Clark Caswell and a man named Peterson. These men were certainly not game slaughterers or violators of the game laws, though they had their quota of trophies, except ante-

lope. For 10 years past I have been visiting Jackson's Hole and neighboring points in Wyoming, Montana and Idaho for rest and recreation, and incidentally for game.

I have learned that most of the adult male residents of Jackson's Hole are moun-

tain guides; that every guide is a regularly appointed and duly sworn game warden or deputy warden; that they are sticklers for the honest observance of the game laws, not only by the tourists whom they guide, but by their neighbors; and that they themselves obey the law.

These guides are, as a rule, honest, intelligent and courteous. The statement that these men are afraid of tourists, poachers, ranchmen or anybody else has no foundation in fact. Only men of courage and determination would or could follow their calling. Should Mr. Finn doubt this let him go to Jackson, choose his man and try to "do him."

The people of Jackson and of the Rocky mountain region in general are not appreciated by Easterners. They are not given credit for their thrift, industry, intelligence or honesty. To be able to judge them justly one must live among them.

Van S. Bennett, Rockton, Wis.

DUSKING.

It was a beautiful night, and will live long in the memories of 2 young hunters. An edge of the moon just peering above the horizon made the dark objects on the marsh, the edges of which were covered with snow, beautiful but uncanny. Such was the place in which our 2 friends hurriedly constructed a blind of the tall reeds. The dog, an Irish spaniel, did his best to keep warm, but, to his mind, it was unsatisfactory.

By the time the blind was finished, the moonlight was rather dim, though brighter than usual on account of the snow.

The blind being complete, nothing remained but to wait really a very short time, but it seemed to the boys an eternity.

Presently a low, whistling rumble was heard, and a pair of black ducks, looking for a place to sleep, flew swiftly overhead. Alas! 2 pairs of sharp eyes had caught the sights, and at the twin reports the hapless pair fell dead on the water. Evidently a poor place for pot hunters, with their clumsy, murderous 8 bores, in this dim and uncertain light.

After the first pair, with short intervals of time, came the ducks, in singles and pairs; always to be met with a charge of 5's. The boys enjoyed the sport till each had 10 ducks. Then came a 4 mile walk, a cup of hot coffee and a warm bed. Do you wonder that the recollection of that night still lives in the minds of 2 sportsmen?

W. F. Irish, Lowell, Mass.

Not at all sportsmanlike. Ducks should be allowed to rest from dark till daylight, and I trust no reader of RECREATION will ever again disturb any game bird at night.
—EDITOR.

TWELVE HEAD OF SMALL GAME THE
LIMIT.

I greatly admire your fearless methods, and it gives me pleasure when you rebuke men for their wanton killing of game. Have been afield when opportunity offered, more than 30 years, and consider one dozen head of small game the limit a day for any true sportsman. My largest bag was 14 quails, made in '78, and not since then have I bagged as many as 12 birds in any one day.

If every boy fond of the gun would read *RECREATION* there would be more real sportsmen at the end of 5 years than this country can now hope for.

If more men would but be thankful for the privilege of roaming the woods and fields, and not think it is all of hunting to kill game, they would be the better and game would increase. If they would study the habits of our wild birds and animals it would greatly lessen the desire to kill. The growing love for the camera, in place of the gun for hunting, is a sign that may well give us hope for the future.

During a visit to my old home in New Jersey, in July last, I took a walk to my favorite meadow. In 2 hours 27 species of birds were seen, among them being a pair of woodcock. Quails were piping all about the village, and I have recently learned they are plentiful now.

The market hunter is a scourge in any community, and the only remedy is to stop the sale of game everywhere and repeal the laws allowing spring shooting. By removing these 2 evils, game would soon be plentiful. Keep up your good work of flaying the bristlebacks.

E. H. Goodnough, N. Y. City.

FOR A LATER SEASON.

December *RECREATION* contains an article by W. H. Tallett, of Watertown, N. Y., advocating a close season of 2 years on black and gray squirrels, grouse and woodcock. He closes by saying, "the average representative at Albany is satisfied with his job. He wants to go back. If 200 or 300 sportsmen write him, that is different. He may need those votes next fall. The sportsmen of each county could control their representatives; but they never will as long as there are so many 2-cent sportsmen." Conceding this to be true, would that mend the matter? Last winter our representatives from Chautauqua county got a bill through to prohibit the shipment of ruffed grouse out of the county. The bill was vetoed by the Governor, thus leaving our grouse swine free to continue the slaughter.

I can substantiate the statements of C. B. W., of Utica, N. Y., relating to the kill-

ing of deer in the Adirondacks during close season. From observation I am of opinion that fully as many deer are killed during close season in the Adirondacks as during the open season. The President of the Fenton Preserve says there were more deer killed after the close season in 1901 in Herkimer county than were killed lawfully. I doubt not that such will prove the case in 1903, for the reason that there was little snow during the open season. Therefore many will have waited to bag their deer on snow, when it can be done in less time and the venison kept till they can consume it. I consider our present game laws, in trying to force all the killing in warm weather, the main incentive for much violation of law.

T. J. F., Jamestown, N. Y.

FROM OVER THE BORDER.

You ought to be proud of your magazine, as it seems to have roused those who are fond of shooting and fishing, as well as those who take an interest in our birds and fishes, to take up seriously the question of their protection. As forests are cleared and land cultivation increases, many birds lose their protective covers and offer a greater and easier temptation to greedy shooters.

In the United States the game laws are different in each State, and are more difficult to enforce than if there were one general law for the whole country. In Canada our game laws are slightly different in each Province, but are better observed apparently than in the States. In Ontario our game is well protected and violations are few. We have no publication such as yours to encourage us to keep up to the mark or to air our views. We are a law abiding people; there are not many game hogs, though there are a few sneaks. Their depredations are confined to remote and limited localities and do not greatly disturb the general increase of game.

As for fishing, except with nets, there are no large catches to be had in the bass haunts; and the unpreserved trout streams are far away from home, which renders it a difficult matter to bring fish home from a fishing trip. I congratulate you on your manly undertaking to promote the preservation and to decry the wanton destruction of game of all kinds in your part of America. You are making your influence felt from Florida to Maine; and that you will ultimately succeed I do not doubt.

C. O. D., London, Ont.

DOES GATES BELONG IN THE PEN?

Enclosed I hand you clipping from the Los Angeles Record of February 10, which speaks for itself.

John W. Gates, the millionaire barb-wire fence

agent, is in San Diego shooting ducks and quails and having all kinds of a good time at the Coronado hotel and elsewhere.

Gates went on a quail hunt a day or 2 ago and he, with 3 others, bagged no less than 525 quails, and when he reached town again he had to telegraph the good news of the big slaughter to some of his friends.

He talked about it in San Diego also, and it is said the party exceeded the legal limit and is in danger of arrest if an official can be found with the temerity to serve a warrant on the erstwhile barb-wire agent.

No one knows in San Diego how long the Gates party will be there, but the members of the party are satisfied with the good time they are having.

Evidently there must have been a great element of luck in John W. Gates' acquirement of vast wealth; as a man with the brains necessary would never call this slaughter of game sport. I am led to believe that the number stated in the clipping is a conservative estimate. These men ought to be classed with Babcock and those other hogs who wallow in San Diego and Coronado whom you have heretofore roasted.

The position of game warden in California is such a soft cinch that the warden apparently likes his upholstered office chair better than the exercise to be gained from getting after these violators of the game law. Such flagrant slaughter, especially those reported on the front page of newspapers, must meet the attention of the warden. I hope you will find space for this, as San Diego county seems to be over-run with game hogs.

G. R. D., Los Angeles, Cal

LAW SHOULD NOT BE CHANGED.

Our season for duck shooting now opens October 1. A number of local sportsmen are working to have the law changed so the opening may be August 1, claiming that ducks come in at that season and soon leave, whereby the sportsman loses his opportunity at the birds. Another reason given is that when the ducks stay here they acquire a fishy taste which renders them unpalatable. When the ducks arrive in August the old birds are moulting and so fall an easy prey to the hunter. The young birds, accustomed to staying with the old ones at that season, are also readily bagged. The fishy taste acquired by the ducks that stay here is easily accounted for. The country at present affords little fresh water, with the exception of a few reservoirs where the birds are hunted so closely that they are driven to the sea. It seems to me far wiser that the law remain unchanged. What think you? The limit for one hunter in a day during the duck season is 50, but it seems hard for some people to count accurately.

George A. Norton, Bonita, Cal.

ANSWER.

I heartily agree with you that it would

be unwise and imprudent to change the law so as to open the season for duck shooting any earlier than it now opens. On the contrary your sportsmen should all favor the shortening of the season; and the legal limit per day to each man should be reduced to 20 or not more than 25 at the outside. The better chance we can give the birds for their lives the longer they will last.—EDITOR.

NEW DECOY DUCK.

717,790. Decoy Duck. Frederick H. Yorke, Fooseland, Ill. Filed March 29, 1902. Serial No. 100,603. (No model.)

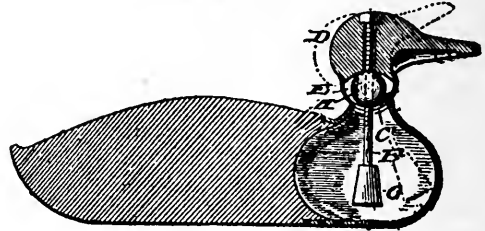

Claim.—1. A decoy duck having a vertically movable head connected thereto, and a weighted rod attached to the head and extending into the body of the decoy, said head being hollowed out at one side for the purpose of catching the wind.

2. A decoy comprising a body, the forward end of which is hollow, the head having a depending rod carrying a weight at its lower end, said weight being located in the hollow portion of the body, and the friction device arranged upon the rod for the purpose of regulating the motion of the head, as specified.

3. A decoy comprising a body, the forward portion of which is hollow and terminating in a neck portion, the upper end of which is concaved and slotted longitudinally, a head having a throat portion attached thereto, a ball contained within the said throat portion, and an adjustable threaded rod passing into the head through the ball and having a weight at its lower end, substantially as described.

BRISTLY SONS OF SOLOMON.

Monday last the Masonic Lodge of Ludington had a competitive hunt. H. Y. Huston and H. M. Hallett, leaders of the respective sides, both worked hard to win, and the result was a signal victory for Huston's side. The official score of the hunt was: Hallett, 180 points; Huston, 213 points. Huston himself brought in 56 points, which was the best showing made by any single hunter. Other successful contestants were: John Stram, 38 points; Robert Towns, 35; John Davies, 29 points; Ed Smith, 24 points.

The total kill was as follows: 74 quails, 60 grouse, 20 ducks, 36 black, fox and gray squirrels, and 2 bushels of red squirrels and chipmunks. The sight of such an immense showing of plunder piled on the floor of the Masonic reception room Tuesday evening was one that few people have ever seen. The spoils of the hunt may well be considered a signal achievement for these gallant sons of Solomon. Great credit is due the commit-

tee, consisting of A. F. Keseberg, E. D. Weimer and H. F. Kimball, who arranged the event and conducted it so successfully all the way through.—Ludington Record-Appeal.

This is simply shameful. Two bushels of red squirrels and chipmunks! What can a party of grown men who go into the woods and slaughter little innocent animals like these at such a rate think of themselves? Hanging would be too good for them.—EDITOR.

AN EXAMPLE TO FOLLOW.

As Conductor Frank Beckwith's train on the Valley road was nearing Arnold station, Friday morning, a deer was noticed running alongside the track. The engine was slowed down, and the deer took to the track, running ahead of the train. Finally it jumped down an embankment and became caught by both horns and one foot in the wire fence that separates the railroad property from the pasture land along the track. Conductor Beckwith stopped the train and with the assistance of several passengers managed to break enough of the wire netting to free the animal. When released it started off into the woods. Conductor Beckwith says the deer was about 2 years old, and weighed between 100 and 150 pounds.—Exchange.

Here is an example that it would be well for everyone to remember. The average man if in this conductor's place would have murdered the deer, thrown it on his train, called on the editor of the local paper at the end of his run, given him a piece of the venison and would probably have received in return a free puff. Conductor Beckwith and the passengers who assisted him in releasing this deer are entitled to the gratitude of every lover of nature.—EDITOR.

PROTECTION OF BIG-HORNS.

Something should be done by the government toward protecting mountain sheep in this district. Under the game act it is a punishable offense to kill the ewe or lamb of these much prized animals, yet every year a number are slaughtered in the Ashnola district, presumably by prospectors, who claim the right to kill them on the strength of holding a miner's license. The game protection act states that every non-resident shall pay a fee of \$50 to the government for the privilege of hunting big-horns. This law is easily evaded by the hunter's taking out a miner's license and claiming the right to kill game because he is a prospector. He thus saves \$45 and claims the right to shoot everything in sight. Mountain sheep are getting scarcer in the Province and stringent measures should be adopted toward protecting the bands on the Ashnola mountains. No prospector need kill eyes for meat, as there are plenty of deer in the country, which are much easier to kill than a mountain sheep. The last hunting party on the Ashnola reports numerous carcasses of ewes which had been shot and left to rot on the trail. A limit should be set to the game a prospector is allowed to kill and a heavy penalty inflicted on anyone found transgressing. The game act has never been properly enforced in the Province, consequently big game is becoming scarcer every year, and it is high time for the government to take the necessary steps for its protection.—Samilkameen, B. C., Liar.

GAME NOTES.

Enclosed please find a newspaper clipping showing a picture of L. W. Slack, the game

hog of our town. I do not think he killed the birds, but he probably bought them. He wears knee pads so he can crawl up on a covey of quails and shoot them sitting. He hides around grape vines and shoots the birds when they come in to feed. He is also a spring duck shooter and he sells all his game.

S. W. M., Williamsport, Pa.

The clipping referred to is a reproduction of a photograph showing a coarse, gawky looking chap standing up behind a big string of ruffed grouse and rabbits. It is just such a looking creature as one might expect to find sneaking into the back door of a butcher shop to sell birds he had shot on the ground or had bought from other pot hunters.—EDITOR.

Till recently I have always been an ardent sportsman, and should, therefore, feel lenient toward those in whom the same passion sometimes proves too strong.

However, facing the facts that large game and game birds are doomed, and that men pursue the remnant with fiercer avidity, with the greedy motto on their tongues: they are bound to go, I'll get my share before they're gone; I am convinced that nothing but stopping for a time can save them.

One thing you should make clear. Many comfort themselves with the idea that game is really increasing, a fallacy which deceives no one.

If in one section deer seem to have multiplied it is because they have been chased from 100 other places.

A. H. Thayer, Oswego, N. Y.

I am much interested in the work being done by the League of American Sportsmen. It is high time every true sportsman took a decided interest in the preservation of what game and game fishes are left. I believe a general law for the United States would be a wise thing, which, of course, might be modified according to locality. I also believe in the prohibiting of the sale and the transportation by common carriers of any game or game fishes whatsoever in the United States.

Geo. P. Langford, Vernon, N. Y.

Congress has no power to enact game laws, strictly speaking. It can only aid the States in enforcing their laws, and that is the purpose of the Lacey Act.—Ed.

I saw in RECREATION a statement regarding the pheasants put out in this State. Mr. Reutinger gave me 2 pairs of them. They are to be the game birds of the future. The weather, 20 degrees below zero, did not hurt them at all.

I believe in a tax on hunters. Tax every

one of them so much per annum and devote the proceeds to keeping up the game. The State does not now get 1 per cent. on its game investment from its taxes. Let it levy \$1 on each hunter. The sum thus obtained would keep up the hatcheries and pay game wardens good salaries, besides stopping the boys, who now wander everywhere with guns which they do not know how to use safely.

G. Greenough, Waterville, Ohio.

I noticed some time ago in RECREATION an article about former game laws. Since then I have learned that among the Chippewa and Winnebago Indians there was a law or rule never to kill the female of any game. What a splendid amendment that would be to the game laws of the several States in which deer, elk, moose and caribou are found. It would mean a marked decrease in the number killed, for to-day there are 20 per cent. more does killed than bucks. The law of Minnesota regarding moose and caribou, prohibits the killing of any but antlered animals; yet a number are killed that never have antlers until the head gets into the hands of the taxidermist.

F. C. B., Evileth, Minn.

This town has more than its share of game and fish hogs. I know 12 or 15 men who make their living shooting ducks and geese, on the marsh 40 miles South of Jennings. They have a steamboat to bring in their game, and at present are shipping about 6,000 birds a week. If you will send some L. A. S. literature, I will distribute it among my friends. Two years ago we had high water in the marshes, and the deer were driven to the knolls. A lot of hogs went out and slaughtered every one they could find, though the deer were so thin they could hardly throw a shadow. If I had my way, every man who hunted them then would serve a term in jail.

G. M. DeRoss, Jennings, La.

I was much pleased by your reply to the man in Ohio who wanted you to advertise his ferrets. By the way, how many other sportsman's magazines would have refused that ad? I would never use a ferret, nor would I associate with any man mean enough to use one. Will not the L. A. S. make a special effort to prevent the sale of game? As scarce as game is in this vicinity, there are men who are in the woods every day of the open season shooting for market. Prohibit its sale, and the greatest step toward the protection of our fast diminishing game will have been accomplished.

Top Snap, Brockton, Mass.

I have been buying RECREATION about 4 years and to-day would not do without it

for twice what it costs. In regard to game here, there are many squirrels, quails and rabbits. There are also a few deer and a great many black bears in the Black mountains, about 25 miles from here. Deer are well protected. I was in camp in October, 1901, at the foot of Mitchel's peak. There were 4 of us and we killed one 4-prong buck. The largest number of quails killed here, by one man, last year, was about 150. The average kill would not be 75 birds to each man.

J. F. Harris, Marion, N. C.

My boy, Max, is a devotee of RECREATION. Last summer, with the gun he received from you for subscriptions, he knocked down 32 snipe in one shot. During the upland season he did wonderful work among Chinese pheasants.

R. W. Mitchell, Portland, Ore.

I am sorry to hear it and sorry Max ever sent me that club of subscriptions. He should be heartily ashamed of his butchery and I trust that on further reflection, he may reform and observe the rules of common decency when in the field.—EDITOR.

Coyotes are plentiful here and I hope to get a dozen before spring. Have caught 3 coyotes, 1 swift and 1 gray wolf so far. Am going to take the hides into town to have them made into rugs, but should like to tan a few small skins myself. Please tell me how to do it. I usually set my traps at night and visit them early the following morning. Have found it a good plan to tie my bait to a rope and drag it across the prairie; any animal crossing the trail will usually follow it.

C. B. Wilson, Huerfano, Colo.

Last December my brother Herbert and I went rabbit hunting in the swamp. Herbert carried a single barrel and I a Winchester 22 rifle. It was snowing, the rabbits were running and easily trailed.

We killed plenty of game and were soon home, much delighted with our little trip, proud of our trophies and of our weapons.

C. W. Lane, Dexter, Me.

I should like to know the opinions of readers of RECREATION regarding hunting boots, hip and thigh top rubber boots, also the mackintosh and water proof canvas boots. I have used many so-called snag proof and crack proof boots and have failed to find a boot that will wear 2 seasons without leaking.

D. Smythe, Newark, Mo.

I consider RECREATION the best of all sportsmen's papers or magazines.

A. G. Mooney, Lynn, Mass.

FISH AND FISHING.

ALMANAC FOR SALT WATER FISHERMEN.

The following will be found accurate and valuable for the vicinity of New York City:

Kingfish—Barb, Sea-Mink, Whiting. June to September. Haunts: The surf and deep channels of strong tide streams. Baits: Blood worms, shedder crabs and beach crustaceans. Time and tide: Flood, early morning.

Plaice—Fluke, Turbot, Flounder. May 15 to November 30. Haunts: The surf, mouth of tidal streams. Baits: Shedder crabs, killi-fish, sand laut. Time and tide: Ebb, daytime exclusively.

Spanish mackerel—Haunts: The open sea, July to September. Baits: Menhaden, trolling—metal and cedar squids.

Striped Bass—Rock Fish, Green Head. April to November. Haunts: The surf, bays, estuaries and tidal streams. Baits: Blood worms, shedder crabs, Calico crabs, small eels, menhaden. Time and tide: Night, half flood to flood, to half ebb.

The Drums, Red and Black. June to November. Haunts: The surf and mouths of large bays. Bait: Skinner crab. Time and tide: Day, flood.

Blackfish—Tautog, April to November. Haunts: Surf, vicinity of piling and old wrecks in bays. Baits: Sand worm, blood worm, shedder crabs, clams. Time and tide: Daytime, flood.

Lafayette—Spot, Goody, Cape May Goody. August to October. Haunts: Channels of tidal streams. Baits: Shedder crabs, sand worms, clams. Time and Tide: Day and night flood.

Croker—July to October. Haunts: Deep channels of bays. Baits: Shedder crabs, mussels. Time and tide: Day, flood.

Snapper—Young of Blue Fish. August to November. Haunts: Rivers and all tide ways. Baits: Spearing and menhaden; trolling pearl squid. Time and tide: Day, all tides.

Sheepshead—June to October. Haunts: Surf and bays, vicinity of old wrecks. Baits: Clams, mussels, shedder crabs. Time and tide: Day, flood only.

New England Whiting—Winter Weak-fish, Frost-fish. November to May. Haunts: The surf. Baits: Sand laut, spearing. Time and tide: Night, flood.

Hake—Ling. October to June. Haunts: Open sea surf, large bays. Baits: Clams, mussels, fish. Time and tide: Day and night, flood.

Weak-fish—Squeteague, Squit. June to October. Haunts: Surf, all tideways. Baits: Shedder crabs, surf mullet, menhaden, ledge mussels, sand laut, shrimp. Time and tide: Day and night, flood preferred.

Blue Fish—Horse Hackerel. June to November 1st. Haunts: Surf, open sea and large bays. Baits: Menhaden, surf mullet and trolling squid. Time and tide: Daytime; not affected by tides.

DUCK-LOVING PICKEREL.

While stopping at a farm house on the shores of a lake famous for its large bass and pickerel, I remarked to my intelligent and educated host on the absence of ducks and ducklings among his barnyard fowls. The laconic answer was, "Pickerel bait; too expensive; gave up trying." When the chores connected with the horses, cows, pigs and chickens were off his mind, he became less brief and opened up in about this way:

"Confound the pickerel, they have cost me many a duckling. I have seen brood after brood of fine, plump, young ducklings float gayly out on the lake, the

proud mother gently cackling to her downy brood, and I have seen the mother many a time return with but one corporal's guard. One spring a mother duck lost her whole family before she could get them into shallow water and up on the beach. The pickerel were lean and hungry and the way those poor, little downy balls of feathers, legs and heads disappeared was alarming. When you reflect that pickerel weighing 25 to 35 pounds have been taken from this lake, and realize what a stretch of jaw is granted a 34 pound pickerel, you can well accept the statement as truth. A hungry pickerel is no fool when it comes to a question of ducklings or bass. Ducklings come first every time.

"Why should not a young duck make good pickerel bait? The best in the world! I've seen pickerel attack the mother duck more than once, and in one case they succeeded in drowning the plucky bird, whose dead body floated ashore shortly after the fight commenced, the legs of the duck looking as if they had run foul of a buzz saw. I have seen pickerel attack an old gander, unsuccessfully of course; but the gander enjoyed what the French would call a 'bad quarter hour.' Once the old bird was fairly ducked, but only for a second. The wide sweep of his powerful wings and the free webbed foot made it nip and tuck with the heavy fish. The fight did not last long, but while the trouble was on the cry of the gander and the churning of the water made by the fish in his struggles, coupled with the thrashing of the wings on the water made the battle exciting. The fish held on pluckily, and I imagine one let go because of sundry clawings administered in the vicinity of his eyes by the infuriated gander. It was many days before that gander had the full use of his wounded leg. That is why I do not keep ducks, although living on the lake shore."

Some months later, while seated on the bank of a small mill pond in Connecticut, enjoying the gambols of some young ducks on the water, I noticed that one of them was acting queerly and making a plaintive outcry. The others swam away, leaving the duck alone to fight her battle as best she could. Very human in its action that flock of ducks! Something was wrong, for the duck spasmodically dipped her body deep in the water. Jumping into a boat, I rowed out on the pond and, taking the duck by the body, I lifted her, only to find a dead weight fastened to one of her legs. As I lifted harder a snapping turtle's jaws appeared. I kept lifting until I had the turtle, weighing 15 to 20 pounds, clear of

the water yet holding fast to the leg of the duck. When the hard shell quadruped realized that he was being lifted toward the boat he had turtle sense enough to let go his hold just in time, and with a splash he fell back into the water to swim away and try for ducks another day. The leg of the poor fowl was so badly torn by the jaws of the turtle that the duck was mercifully killed. From this our farmer friend might have truly added "turtles" to his laconic reason for not raising anything in the fowl line but chickens.

While bass fishing on Lake Ida, Minnesota, we repeatedly noticed a flock of full grown wild ducks about the water during the day. We had fished the upper arm of the lake and quit at dusk. Before we had reached a sandy point extending out into the lake it was dark. Our boatman had frequently told us of the 50 and 60 pound muskalonge taken in this lake late in the fall, when the water is cold from top to bottom. He had told us of their basking in the sun on the water's surface, looking all the world like a section of a fence rail.

Out of the stillness came, from the direction of the sandy point, a frightened chorus of duck quackings, followed by a hurried beating of wings on the water, accompanied instantly by a swish, as if a large body were passing through the surface; then a dripping of water, a great splash like unto a big dog jumping from a dock into the water, a sound of falling water as the splashed liquid returned to the lake's surface, and all was quiet once more. The dull, heavy blow made by the body striking the water resounded against the side of our boat as the sound waves traveled over the surface of the water.

"What's that?" we asked of our guide.

"One of them big fishes I've been a-telling ye of, that's all. He's got his wild duck for supper, 'cause them fellers when they strike they never miss."

Perhaps he was right. From the sound and commotion made in the water I should not have questioned his statement had the ducks been geese.

Chas. Cristadoro, St. Paul, Minn.

BASS IN IOWA RIVERS.

Our last fishing season in Iowa was replete with pleasure to every true angler. The streams, especially the rivers of Northern Iowa, abound with black bass of the great and small mouth varieties, and exceedingly gamy. They are not large, but are strong, quick, snappy fighters, that make the selection of tackle an important item. Our river anglers carry some of the best tackle made. I was extremely successful last season, and my success has been known among many anglers, if I may

judge from the number of letters I have received since the close of the season seeking advice concerning the tackle and baits best adapted to taking bass from Iowa rivers. I take this opportunity of answering all such letters through RECREATION, which every true angler, in the United States at least, should read.

I did not take great numbers of bass last season, nor land any remarkably large one; but landed bass when and where others failed, and always saved myself the humiliation of returning fishless after a day's trial.

Taking bass from Iowa rivers is not easy. Fish food is abundant in our streams from May to November, and the law allows the angler to use but one hook at a time, thereby preventing the deadly gang hooks, etc. For all of this I am truly thankful. I find it much more delightful to angle for bass under such restrictions than to be able to lift them out in large numbers. I use a No. 17 Favorite Bristol rod, with agate tip, agate first guide, and double grip cork handle. I also use a William Shakespeare professional reel, No. 3m., which holds 80 yards of No. 5 braided silk line. I have a small leather-covered tackle case, rubber hip boots and a 10 quart minnow pail. For bait I use black and brown hackles, bass flies largely, tied on No. 1 sproat hooks, with P. & S. No. 0 ball bearing spinners. This has proved an excellent killer.

When using flies I wade down stream slowly and quietly, casting to each side and in front, about 40 to 60 feet. This is the most sportsmanlike way I know of taking bass. I have taken 3-pound bass in this way with a No. 1 sproat hook. I also use minnows at times. I use double gut leaders. I fasten a small wire to the leader above the hook, run the wire into the minnow's mouth and out through its gill, and wrap the loose end of wire around the hook near the bend. This does not hurt the minnow, but keeps it and the hook where they belong. I then use this bait as I would a fly, casting it to each side and in front as I move down the stream. Our river here, the Volga, is filled with large rocks. When using live bait I cast where I can cause the minnow to strike the water above a rock or cover and float down toward it, or swim around at its own will. I also use grasshoppers, ground worms and crawfish in much the same way, except that I hook them.

It requires some practice to cast a fly or any light bait any distance and place it where you wish, but after you have acquired the ability to do this you will feel a thousand times paid for the necessary effort. I have cast a small minnow 80 feet and landed it within a few inches of the

desired point, and have had a bass hooked before the reel was still. This is a sportsmanlike method, and only true sportsmen know the indescribable thrill it can give. I angle for pleasure, not for pounds of meat. Success, to me, is not measured by the quantity of meat I take, but the manner of taking it. There are days when bass will strike any kind of bait, and anybody with any kind of tackle may land large numbers of bass; but there are other times when it requires skill and art to take them. To me this is the time to angle, and one 2-pound bass taken at such times gives me more enjoyment than a bushel of them would at my ease.

Trolling for bass is quite deadly, but contains little sport for me; hence I have ceased to troll save in deep pools, where large bass stay. In bait casting one can be alone on the stream with the birds and flowers, the squirrels and rabbits that are so abundant and interesting along our rivers. To troll one needs a boat and someone to handle it; so I prefer to loiter along the carpeted banks of the stream, casting my line into all the likely places; and if I am forced to cast 100 feet to reach a cover I like it all the more.

Brother, what do you use and what are the methods that have added most to the pleasure of angling for bass from rivers? Tell us about it through RECREATION.

W. S. Hoke, Wadena, Ia.

TWO BIG PICKEREL.

Of course bigger pickerel are often caught, but the fact that it was taken within a stone's throw of the village, in a stream constantly patrolled by anglers, including the inevitable small boy, makes it a remarkable catch.

I was in ill health that summer, and, in company with a younger brother, was spending most of my time in outdoor amusements. A little spaniel completed a trio which was no crowd, or, if so, just the sort of crowd to get the greatest amount of sport out of a day afield. Naturally the river near by came in for a generous share of our attention, and one day we had the luck to hook a 2 pound pickerel, a whopper for that stream, which, however, escaped when nearly landed. The next day we set out for the express purpose of capturing this big fellow, carelessly providing ourselves with a trout hook and line and a light bamboo rod without any reel.

After the usual order, Ned was doing the fishing, while Tex and I lounged on the bank on the lookout for such side attractions as a woodchuck or rabbit. Suddenly there came a great splash, and an excited "Oh, oh!" from Ned. Tex and I rushed down the bank just as Ned drew a monster pickerel, more than double the

size of the one we were looking for, to the top of the water. It quickly disappeared, the light bamboo bending almost double.

I had never seen such a pickerel in that river before and promptly got rattled. Instead of instructing Ned, who was only a boy, to go easy, I yelled, "Yank him out!" Ned pulled desperately, but could get the big fellow no farther than the top of the water. One moment he would bring him to the surface; the next, under and away the fish would go, the bamboo quivering and the small line tight as a bowstring. At length, in one of his rushes, the line caught in bushes growing out into the water. Tex was then the first to grasp the situation. Plunging into the stream, he began snapping away at the fish as it now and then came to the surface. Ned and I followed. It was 3 to one, but for a time it seemed as if the fish must prove the winner, for we were all so excited that we interfered with one another. At last Ned got the fish round the body with both hands. Then I ran my thumb in his gills, and we had him. He was 28 inches long and weighed 5¾ pounds. Considering all the circumstances, it seemed little short of a miracle.

As if luck had not already favored us enough, we caught, later in the day, the same pickerel, we firmly believe, we had lost the previous trip, and more big bass than we had ever taken in a day before. More, also, than we should now care to take in a day, since becoming readers of RECREATION.

J. L. Woodbury, Cornish, Me.

It was a hot, sultry day in the latter part of July. Slowly working my way around the pond I had fished more than 2 hours and had only caught one small bass. Just as I was beginning to think of leaving I felt a slight pull on the line. Allowing time for the nibbler to get a good hold I started to pull in. As I did so, there was a quick jerk, a rush and the fight was on. When I checked him there was not more than 2 yards of line on the reel. After a few turns on the reel he started again in a different direction, but again I checked him. He then tried to go under the canoe, but by rapidly reeling in the line I parried that move. That seemed to anger him so he made a series of zigzag rushes, until we were both tired. Then he lay still, while I reeled in more than half of the line. Suddenly he began another series of rushes, but that time he was weaker and soon allowed himself to be quietly led up to the side of the boat. Slipping my fingers into his gills I lifted him into the boat, where a merciful blow on the head killed him. The fight, according to a gentleman who had watched it from shore, lasted almost 25 minutes.

J. F. F., Dover, N. J.

A ST. LAWRENCE SALMON.

I have taken RECREATION a number of years and have frequently read therein stories of salmon fishing which convey the impression that it is comparatively easy to land a salmon. Of course, with a good angler, the chances are 2 to one in favor of the fish being landed; but with a tyro, this is not always the case.

In July, 1902, I spent 2 weeks at Matane, a small lumbering village at the mouth of a river of the same name, on the Gulf of St. Lawrence. The Matane is a tidal river and during the spring tides the sea water covers a considerable rapid of about 12 feet in height. The river is noted not so much for the number as for the size of the fish caught in it. The largest taken last season weighed 31 pounds. The river is divided into pools, of which a table is made up, so that each angler has a certain time during the day at each pool.

The morning after I arrived the rapids were allotted to me from 7 a. m to 8. Although I had often fished for lake and sea trout, I had never before fished for salmon. After fishing about half an hour, I raised a salmon, but did not hook him at first. In about half a minute he returned, made a beautiful rush at the fly, and was hooked. He was not a big fish, weighing, as far as I could judge, about 12 pounds. Instead of rowing to the shore and gaffing him there, I tried to land him from the boat, with the result that after playing him about 5 minutes he got alongside the boat and began rushing from side to side. The strain on the rod was too great, as it was bent almost perpendicularly, and suddenly it snapped, the line became straight, and the fish was off.

I rowed back to the club house, spliced my rod, and returned. I fished some time before I got another rise; but just as I was thinking of returning, I hooked another salmon and was able to land him. He weighed 14 pounds, not a big fish, but the biggest I had ever caught at that time.

After half an hour's rest I went on to the next pool, where the water was quieter, and I soon had a large fish hooked. He was fresh from the sea, and rushed and jumped about in a truly marvelous way. I had hard work to keep my rod up, and, alas! after I had played him about 3 minutes, he gave a huge jump in the air and fell on the line. In the excitement, I forgot to lower my rod, so as to give the line slack, and in consequence the weight of the fish broke the taut line and he got away.

I had no more rises that morning, but during the afternoon I caught 2 more beautiful fish, one weighing 18 pounds and the other 16.

During my stay at Matane, I caught al-

together 28 fish, averaging about 11 pounds apiece.

R. H. Irwin, Ottawa, Ont.

NIBBLES.

Mr. Fred. Funder, Republic, Wash.

I am informed you recently caught 140 trout in one day. Will you kindly advise me if the information is correct; also the length of the smallest fish?

G. O. Shields.

Republic, Wash.

Those are facts. The smallest fish was 7 inches long. There is great fishing here; no trouble to get 100 fish.

Fred. Funder.

No decent man would ever take 100 fish in a day. It is only degraded, infamous fish hogs who do that sort of work.—EDITOR.

In November RECREATION I saw an inquiry from D. Smythe for an artificial bait to take channel catfish. Although not an artificial bait, I will suggest one that never fails with me. Take a minnow, pinch off its head and run it on a hook, like a worm. Start hook about $\frac{1}{2}$ inch from tail, run it straight through; turn the minnow over and start back through the large part of the bait.

Chas. Scoggan, Buechel, Ky.

I have just returned from a trip to Flatwillow. We traveled over 35 miles of rough roads and trails to get to good fishing. Once at Flatwillow, fishing and hunting are of the best. There are trout that weigh 5 or 6 pounds. The largest we got was $1\frac{1}{2}$ pounds.

A. J. Scheibelhut, Newyear, Mont.

Will Carleton gives some good advice to anglers, in a recent poem:

But he started me a-thinkin': When you
fish, as fish you will,
Be a sportsman, not a butcher; try to catch
an' not to kill;
Keep enough to serve your eatin', let the
surplus fellers go;
Send the small ones to their mothers—
give 'em time to fat an' grow;
An' when pullin' in the fishes don't be slow
to recollect
To secure 'em in a manner not to forfeit
their respect.

She—Doctor, is Denver a good place to go for rheumatism?

Doctor—Sure. That's where I got mine.
—Detroit Free Press.

GUNS AND AMMUNITION.

Anybody can shoot all day, but a gentleman will quit when he gets enough.

ANSWERS TO BRITISHER.

According to the February number of *RECREATION*, Britisher wants points on American guns, and he asks so many questions that it might be a good plan for us Yankees to club together and lay out the work of answering, distributing the job among those best qualified to decide. Many men are of many minds. Especially is it true on the subject of guns; and the great United States is a nation of sportsmen. At least, we agree in liking a gun.

I prefer the Winchester repeating shot gun. A 12 bore cartridge loaded with ball will work through the action all right, if it has a round instead of a square crimp, and the ball is not wrapped in a patch so tight that it bulges the shell; but no such gun, though it be a cylinder, will shoot a ball accurately.

I began to experiment with a smooth bore and ball when a boy and from the time I first fired that old army musket up to the present, though I have tried again and again, I have never found a smooth bore that would shoot a ball well. I notice what the *Ideal Hand Book* says about "round ball for shot guns" and, like others, I believe that anything printed must, of course, be true; but I do not believe in anything on the subject which is not put down in plain type.

My last experimenting was with a cylinder bore pump gun, carefully measured charges of powder, balls patched and lubricated, and the same old result.

In my locality a gun for large game ought to shoot accurately a distance of at least 100 yards; it must shoot straight 75 yards. I can not do this with a shot gun and a ball. Far better is it, on animals the size of deer, to use buck shot. With a good gun, choke bored and properly loaded with buck shot, deer may usually be killed at a distance of 75 yards if the gun is correctly pointed; while, at 25 yards to 50 yards, the scattering of the buck shot is a great advantage on moving game. At a distance of less than 25 yards there is nothing more fatal to deer. The first 4 deer I ever saw shot were piled together almost in a heap with buck shot at short range.

L. I. Flower, in February *RECREATION*, says his Greener will make a closer pattern with No. 7 shot than his friend's Ithaca, but shoots BBs irregularly. That is simply an indication that his gun has a closer or more abrupt choke than the other. Large shot will jam at the muzzle of a full choked gun in the same way, though not to the

same extent, that buck shot do, if factory loaded shells are used. Of course this spoils the pattern and is dangerous to everything but the game. For goose shooting the shells should be loaded by hand as carefully and in the same way as if loading buck shot. Let Mr. Flower try it, and tell us if he is not then satisfied with his Greener. For using large shot, I prefer the big gauge guns.

If Britisher wishes a gun with which he can shoot both large and small game, why does he not get a 3 barrel gun. For mixed shooting, they are unsurpassed, and he can still carry some shot gun ball cartridges if he wishes.

I have a Daly 3-barrel, bored for a 38-55 cartridge and chambered to take the 38-90 Express cartridge. With Du Pont No. 1 smokeless and a 240 grain hollow point bullet of 1 to 10, it will do good work. Last fall it killed 4 deer and 7 foxes. Two of the deer were shot through the heart, and one through the head, at distances of 90 to 126 yards, paced. One deer was killed on the spot with buck shot at about 40 paces. Every shot which struck him went through. To head off a letter of inquiry from the editor of *RECREATION*, I hasten to say I did only a part of the shooting. If one prefers factory loaded ammunition for his 3-barrel, either the 30-30 or the 45-70 is a reliable and fairly effective cartridge.

For deer, however, I like better a repeating rifle. I pass a few of Britisher's questions as being debatable. We can, however, get in the United States a better American than an English gun for the same money.

The 50-100-450 and the 50-110-300 may be shot from the same rifle with the same sights, but not with the same sighting. The rear sight requires more elevation for the 50-100-450 and a larger increase in the elevation for the first 200 yards; but it has a much longer range. I use a modification of the 450 grain bullet, being a hollow pointed ounce bullet. I find it destructive on deer, nor should I have any fear that it would fail to kill anything on this continent. Of course, if long range and low trajectory are needed, this is not equal to the high pressure small bore cartridges; but it is a powerful, easily reloaded, safe and fairly accurate cartridge. I have some of the high power, low pressure Winchester 50-110 cartridges, but have not tried them enough to speak definitely of them. Still, for the present, I hold this gun in higher esteem since these cartridges were put on the market. The 50-450 bullet is a little more ac-

curate than the 50-300. As to which is more deadly, the answer to that question must depend on the size of the animal shot, the location and direction of the wound.

The shells may be reloaded many times. I use a Winchester tool and Du Pont No. 1 smokeless powder. For shooting both cartridges from the same gun I should buy the gun with the 54 inch twist. Either cartridge is a better killer than the 30-30.

Of 30-30 repeaters I prefer the Winchester. The Savage, however, has many friends. The 40-72-330 Winchester is all right, too, but if one is going to buy a box magazine gun, why not get a high pressure? I have not used a 32 special Winchester, but I have a 32-40 of practically the same charge. This shoots well, though it certainly does require care in cleaning when changing from one powder to the other. It is an advantage to be able to use the ordinary 32-40 shell in the same gun, and if you do not hit with the old 32-40 you will know it is not the fault of the gun or the cartridges. There can not be much difference in the effect of this and the 30-30 on game; but the 32-40 is more easily cleaned and I never could see the need of so quick a twist as 12 inch in a gun to be used on game within 200 yards. I presume many others remember the same thing, since we have been so industriously reminded of it by the manufacturers. I should think the 35-250 Winchester would be a good gun for use in India. Who next?

Fred B. Lang, Woodsville, N. H.

A GUN THAT SHOT BOTH WAYS.

C. H. D.

When a boy, I used to spend my vacations and holidays with my uncle, who had and still has, a large place on the Eastern shore of Maryland. He was largely interested in dredgers and tug-boats, and was often absent several days at a time, always leaving me in charge of my aunt, a worthy old lady, but an unusually cautious one.

There is no place in this country for ducking, like the Eastern "sho," as the darkies call it, and no better location along the whole Chesapeake bay than at my uncle's home. Often had I watched hundreds of wild fowl feeding among the numerous celery beds, and longed for a shot at them; but my uncle, a stern old Dutchman, would hold up his hands in horror when I begged him to let me try his gun on them. I, being from the city, was not supposed to know how to use firearms. I think too, my mother's weekly letters had something to do with this. Anhow, when my uncle went away, he always laid strict injunctions on my aunt not to let me have the guns, and as a further guard, he used to put them under lock and key,

One day when rummaging in the attic, I came across a curious old bell mouth gun, that must have belonged to my great-grandfather, so ancient was it in appearance. It had originally been a flintlock, but some ancestor had had it made into a trigger-fire. I hugged this old musket to my breast in a wild ecstasy of delight, and smuggled it into my bedroom. I harnessed a horse, and went to the village for ammunition.

All that night I lay awake thinking of the glorious to-morrow, and at dawn I stole noislessly out of doors. Stopping at the blacksmith shop, I secured an iron rod which was to serve me as a ramrod; then whistling for my dog, I quickly made my way in the direction of the river. After getting a suitable distance from the house, I started in to load my musket, putting in about 6 fingers of buck shot, and ramming it well home. Then silently I crept to the edge of the water.

Such a sight! The day was just breaking, and the bay seemed lined with ducks. Fearing I might not be able to get a second shot, and wishing to slaughter as many as possible, I hurriedly poured all the loose shot from my right hand pocket into the old gun. Then, putting a wad of paper on the top, I put on a cap, and took deliberate aim. I hardly know what happened, but when my uncle returned home that morning, he found me, about 8 o'clock, lying unconscious on the shore, and by my side lay 12 ducks, which the dog had brought from the bay. How many floated away, would be hard to say, but the river looked as if a feather-bed had been emptied in.

I had to be carried to the house and for several days I was unable to see on account of a huge lump between my eyes. From the way my body ached that old cannon must have beat a tattoo all over me. When I recovered sufficiently, my uncle told me that to his knowledge that old gun contained 2 loads, which had been in it many years, and perhaps more. I think it did. He had been afraid to shoot it, so had secreted it in the garret.

This all happened 10 years ago, and since then I have hunted ducks in many places, but never have I equalled the record made on my first expedition. I shoot with a more modern gun than I used that time, and while the returns may not be so large, the effects are less discouraging.

SAVAGE COMPANY DEFENDS ITS RIFLE.

As usual, I read RECREATION, and came across the article "Jammed a Savage." I like to follow up everything that comes in the way of criticism, especially through your medium.

We find the case of W. A. Cone peculiar.

There is no question in our minds but that Mr. Cone had the trouble he states, as no man would go out of his way to describe something that did not happen. The rifle was received and examined here, and we could not find anything the matter with it. There might have been some foreign substance in the mechanism, or possibly the shell was too large, being above gauge. The trouble would come under one of those 2 heads.

We sent Mr. Cone new ammunition; also a brand new rifle, all at our expense, although he did not buy the rifle from us, but from a dealer. Mr. Cone refused to accept the new rifle, as we understand, and would not even look at it. He also made threats in his letters to publish an account of the injury, which he has succeeded in doing. We are only sorry it was delayed so long, so that we could give still further details, which might help to clear up the mystery as to what gave the trouble with that particular rifle. If Mr. Cone had had some mechanical ability he could have taken the objectionable cartridge out of the gun by using a rod, wood or otherwise, from the muzzle, at the same time bearing on the lever. Then he could have tried the other cartridges that he had, to see if they went in easily, and his gun would have been in use again. We have had one or 2 cases where persons have tried to put a cartridge of different caliber into a gun and they have come to grief. We do not claim, however, that it was done in this particular case.

If Mr. Cone had said he had too large a cartridge to go into the barrel, it would not have been so bad, but he gives no reason for the jam. Of course every sportsman knows that any rifle can be jammed. A man can put a cartridge wrong end first in the magazine, or he can put a handful of gravel in the magazine, or a hundred and one things; which should not be anything against the individual arm.

The only criticism we make in this complaint is that Mr. Cone was not inclined to receive overtures made in good faith by ourselves, but wanted his money back. We never sold him the rifle, but we did send a new rifle to the dealer from whom he purchased his other arm, paying all express charges, besides sending new cartridges. This, we believe, is more than other companies do under similar circumstances.

We thank you very much for your good article on the new sight. We get large number of inquiries from anything you publish an account of, and can truthfully say that RECREATION is the best medium we use for advertising our goods.

Arthur Savage,
Managing Director,
Savage Arms Co.

GUN LORE GALORE.

L. E. Hinman asks in October RECREATION if the Winchester people make a single shot rifle for the 32 Ideal cartridge. Their catalogue pictures the 32 Ideal, which it says is adapted to Winchester single shot and Stevens rifles. It is loaded with 25 grains powder and 150 grain ball, and is said to be highly accurate at 300 yards.

In November RECREATION M. Cushman asks about false muzzles. The only one I ever used was fitted to a Remington No. 3 match rifle, 38-55. There were 2 little holes in muzzle of gun, one above and the other below the bore. The false muzzle had pegs fitting the holes in barrel, bringing the bore of the false muzzle exactly over the bore of the gun. It was larger at outer end, making a perfect swage for the bullet. Across its face, up and down and crosswise, were 2 grooves as deep as the thickness of a sheet of paper and $\frac{1}{4}$ inch wide, centering as they crossed the center of the bore. In these grooves a cross patch was put, and the ball was placed over it and rammed; it being finally seated against the shell with a long ramrod. This false muzzle gave the best of results.

Buck, in September RECREATION, wants the best squirrel and rabbit load. Get the 25-25 by all means. It is good at 300 yards. Stevens, Winchesters and Remingtons of that caliber guns are all good.

In October M. L. Meason asks about the comparative merits of Mauser repeating pistol and Colt revolver. Both are expensive enough to be good. If my life depended on a small arm against man or beast, give me the Mauser. After first shot it cocks automatically and can be fired twice as fast as a double action revolver. It is 10 shot, and is sighted for 1,000 yards.

Readers of RECREATION have been clamoring for the best all around gun. It is the Winchester 32 special. It shoots bottle necked cartridges, and with factory load of high pressure smokeless and a 165 grain soft point ball has a muzzle velocity of 2,057 foot seconds, giving muzzle energy of 1,550 foot pounds. With full metal patched ball, at 15 feet from muzzle it has a penetration of 37 pine boards. The factory ammunition is loaded with smokeless powder. Primed shells can be had, or others reloaded, with 40 grains black powder, which develops a velocity of 1,385 foot seconds, the same as the 32-40 straight shell. Reloading tool, model '94, is made for this cartridge. With smokeless powder it is stronger than the 303 Savage and next to the 30-40. Being 32 caliber, it is larger and will draw more blood, making it a better big game gun. F. B. Salisbury, Rochester, N. Y.

MILITARY RIFLES.

In December RECREATION I noticed an article by Dr. Elliott on an all around rifle. He speaks of designing a rifle of 38 caliber, 70 grains powder and 350 grain bullet. I wonder if he has tried the Winchester, '95 model, 38-72-275 or the 40-72-330. The latter gun seems so near the one he would design that there could be no material difference. The Winchester Company makes such a large assortment of excellent rifles that a person need look no farther for the best.

Dr. Elliott appears to have a poor opinion of the ability of the board that selected the arm for the army. He claims that the Remington single shot is superior to the Springfield. I wish he would inform us in what respect it is so. There is no difference between the shooting powers or the manipulation of these excellent arms. The reason for adopting the Springfield was because, after the Civil War, the Government wanted an action permitting the alteration of the muzzle loading Springfield into breech loaders, using the same side lock and other parts, for the manufacture of which they had machinery. The result is the Springfield breech loader. They also experimented at length on all propositions of powder and bullet, twist, etc., and finally decided on 70 grains of powder and 405 grains of lead as giving the best results. Afterward the weight of bullet was increased to 500 grains. The rifle has 3 broad grooves, the twist is one turn in 22 inches, and the weapon has for years remained unexcelled for accuracy and simplicity.

The doctor also shows his lack of knowledge of firearms when he says the Krag is inferior to the Mauser or Lee. The Board of Ordnance, U. S. Army, a few years ago, tested 60 different makes of arms and adopted the Krag after rejecting the Lee, Mauser and 57 other guns. The Navy Department adopted the Lee at first, but after finding it inferior to the Krag, is now supplying all the new ships with Krags. No more Lees will be issued. I have handled and fired the Krag, Mauser, Lee, Springfield and many other military and sporting rifles, and will say that, for simplicity, ease of manipulation, certainty of action, etc., the Krag-Jorgensen repeating action is the best I have ever used. As a single shot the Springfield is as good as any.

C. R. MacCarrick, 5th Infantry, M. V. M.,
Malden, Mass.

READJUST YOUR SIGHTS.

I have a 38 caliber Bisley model Colt revolver, 7½ inch barrels, weight about 43

ounces. At what distance should a beginner practice with the full charge? - I find I shoot low and to the left. This, I fancy, is the fault of the pistol, as I had the same trouble when using another weapon of the same make. If not, can you suggest a remedy?

G. S. Whipple, Burlington, Ia.

ANSWER.

The Colt Bisley model revolver is an accurate arm, and, if properly sighted, you should have no difficulty in getting good results. The rear sight is movable. If you are shooting to the left, move the rear sight a trifle to the right until you find that you are shooting in a vertical line through the center of the target. If you are then shooting too low, you will probably be obliged to get a lower front sight. In the Bisley model the sight is generally fastened with a pin, so it will be easy to replace it with one a trifle lower. Possibly you can file the sight down to the proper height to give correct elevation. That, of course, can not be done with a bead sight.

The usual distance at which revolver shooters practice is 50 yards, at the Standard American target, with an 8 inch bull's eye. If a beginner, start with this target at 25 yards and gradually increase the distance, as you gain proficiency, until you reach 50 yards.—EDITOR.

TO RELOAD 30 CALIBER SHELLS.

I have noticed in RECREATION many inquiries as to reloading shells, cleaning rifles of the 30 caliber, etc.

Use Winchester loading tools, Model 94, 30-30, No. 5 primers, DuPont 130 caliber smokeless powder, 30 grains, and bullets to suit your purpose, metal patched or soft nosed.

These shells cost to reload as follows:

Primers for 233.....	\$ 37
Powder, 1 pound loads 233.....	1 50
Bullets, per M. \$5, for 233.....	1 16½

For 233 ctgs.....\$3 03½

The shells can be reloaded several times. Out of 600 fired but 2 were broken and that by carelessness. They should be resized every time they are reloaded. This can be done cheaply by tacking down a piece of half inch iron ¾ x 1 inch. Through this bore a hole 5-16 inch in diameter, the size of a new shell. Drive the shell into this up to the neck, then carefully open mouth of shell on tool by tapping lightly. Be careful with powder. Have less than 30 grains rather than any more.

Persons who live in the East may do better than I can, but with the prices of ma-

terials here that is the best I can do. Powder costs me \$1.50 a can, one pound.

Chas. E. Fulstone, Carson City, Neb.

WISHES INFORMATION.

I have an Ideal Stevens rifle, 25-25, 26 inch barrel, rifled with a 12 inch twist and chambered for the 96 grain bullet. I also use the 77 grain bullet with 13 grains powder for light hunting. I cast the 96 grain bullet 1 to 40 and the 77 grain bullet 1 to 50, but have not had opportunity to do all the experimenting I wish and am not sure that my bullets are properly tempered. If any of your readers have had experience with the 25 caliber and 12 inch twist, I would appreciate it if they will write me fully or have their experience published in your valuable journal. I use semi-smokeless mostly; fg grain for full charge and ffg for reduced charges. Has any one tried fffg or ffffg for reduced charge in this caliber and twist? I notice the Winchester Co. in their 32-40 Marlin & Ballard cartridge temper the bullet 1 to 40 for full charge of 40 grains powder, but in the short range load they temper the bullet 1 to 20 and only use 13 grains powder. The Stevens Arms Co. recommend for their 22-15-60, with 12 inch twist, bullets tempered 1 to 75, and 1 to 60 for full charge, and a pure lead bullet for reduced charge. Let some philosopher or gun crank explain all this and help us would be cranks out of the fog.

T. J. Wilbourn, Gail, Tex.

NOT VAN DYKES.

Last winter a 3 year old cow stampeded from our slaughter yard and for 3 days we tried without success to get her back again. After failing to head her on horseback, I became angry and dismounted to take a shot, just for revenge. I had with me a 22 caliber Winchester, 1900 model. The cow stood with side toward me. I aimed for the middle of her ear and fired. She went down and stayed down, though the butcher, who came up immediately, would not cut her throat until he had put a larger bullet through her head.

A friend bent the barrel of a 22 Marlin by hitting his horse across the rump with it. He then took the action out and struck the barrel the other way across a bank 2 or 3 times. When put together again the rifle shot as well as ever.

These stories are not an infringement of the Van Dyke copyright, because they are true.

I recently bought a 22 Winchester, single shot, center fire, for hunting coyotes on the snow. Will some one tell me its

velocity, and whether the shells, loaded with smokeless, are as good as black powder loads?

M. G. Burns, Scofield, Utah.

SMALL SHOT.

In October RECREATION G. L. Watkyns mentions the 30-40 Winchester, '95 model, as "an all purpose gun." I protest against that dictum. In the first place, the killing of large game, except at the long range required for goats and sheep, is best accomplished by the bullet having the greatest force of impact. The old 45-90 and the 40-82 are the best guns for this country. I have tried the 30-40 at different times during the past 4 years, and shall not use it again. It is not a reliable gun. Its light barrel and tremendous initial velocity give the ball a lateral swerve. The inland Indians, among whom I have just made a trip of over 600 miles, use the old 44-40 Winchester almost exclusively. They find it does all the work they require. That it does so, the bear, moose, lynx, deer and wolf pelts I saw abundantly testify. The ideal gun is still a dream, but stick to the black powder rifle unless extremely long range is desired.

Douglas Brown, M. D., Mattawa, Ont.

Which is the best for target shooting and all around use, a Colt's new Police revolver, chambered for the 32 Colt new Police cartridge, with 6-inch barrel, or a Smith & Wesson hand ejector revolver, chambered for the 32 S. & W. long, with 6-inch barrel? Also which has the strongest and best action?

W. D., Stamford, Conn.

ANSWER.

The 2 revolvers you refer to are nearly identical in action, accuracy and power. The principal difference in the models is in the shape of the handle. With 6-inch barrels, both these arms are capable of shooting groups of 10 shots so as to touch a 3-inch circle at 50 yards with the regulation full charge ammunition. Any individual preference for one or the other of the arms would be based on the slight difference in the shape of the handle.—
EDITOR.

I should like to hear from those using the 22-7-45, '90 model, Winchester. I bought one a few weeks ago, fitted with Lyman sights. It is a powerful little gun. I soon found that U. M. C. cartridges would not work in it. The points were too sharp and flattened in the magazine, making the cartridges too short. This was especially the case with cartridges that had been worked through action more than

once. Winchester ammunition works perfectly, the bullets having broad, flat points. I have been thinking of buying a shot gun, and through reading RECREATION have decided that the '97 model Winchester is the best. Which would be best for close, long range shooting, a 30 or a 32 inch barrel?

E. W. V., Watertown, N. Y.

I have used nearly all makes of American rifles, and consider the Maynard and the Stevens the most accurate. I am using a Stevens Ideal 25-21-86, which I load with 20 grains of King's semi-smokeless and an 86 grain bullet. For target shooting at 30 to 200 yards, the Stevens Ideal 25-21 will equal some of the larger calibers. Always load with King's semi-smokeless F. F. G. powder. The penetration and killing power of the 25-21 is as great as that of the best 32-20 rifles, and it is a much more pleasant gun to shoot. For woodchucks and all small game it is just the thing. What small game hunters need is accuracy in a gun, not smashing power.

J. R. Waterman, Bliss, N. Y.

I notice in October RECREATION the inquiry of E. E. Vance, of St. Joseph, Mo., as to whether or not a 32 caliber revolver would be the right thing to use in a hand to hand engagement with a grizzly bear. A 32 is plenty big enough for the purpose if properly used. This is the proper way: Thrust the revolver down the bear's mouth into his stomach and rapidly empty the cylinder. Meanwhile hold the animal's nose tightly with the left hand to prevent the escape of gas. If the brute does not drop dead, he will be so flabbergasted that it will be an easy matter to kick him to death.

H. Coleman, Council Bluffs, Ia.

Would it be safe to use nitro powder in a 12 gauge shot gun made 10 or 12 years ago? The gun has laminated steel barrels, unusually heavy at the breech, and the stock is heavy and firm. It is stamped "New York Machine made," and, if I remember rightly, was listed at \$60. I have always used black powder in it with excellent results.

The right barrel shoots fairly close, the left very close

B. L. Dingley, Meadville, Pa.

Will some of RECREATION'S readers please answer?

I read in December RECREATION what Mr. Burns says of V. M. C. shells in the '90 model Winchester 22. I have a rifle of that caliber and have had no trouble with its action with Winchester shells. Once

I bought a box of V. M. C. shells, and 3 or 4 stuck in the carrier. At first I thought it was the gun's fault, but when I tried Winchester shells it worked all right. I did not compare the shells, but several times since I have had V. M. C. cartridges stick in my gun.

Paul Hilsdale, Sauk Centre, Minn.

I note that many readers of RECREATION favor high power rifles for such game as deer. I like the .303 Savage, but think it too powerful for deer, especially with soft point bullet. I saw a deer last fall that was shot with a Savage .303 soft point bullet; it mushroomed and tore the meat badly. I consider the 32-40 a good all-around gun for deer and smaller animals. Should like to hear, through RECREATION, the experience of others with the new 35 Winchester.

32-40, Tilton, N. H.

Please tell me how many No. 7 or No. 8 shot, out of 1 $\frac{1}{8}$ ounces, a gun should place in a 30 inch circle at 40 yards in order to be a good trap gun?

Wm. L. Zeller, Spring Bay, Ill.

ANSWER.

For inanimate targets the gun should pattern 64 to 68 per cent of the charge. For live birds the right barrel should pattern 60 per cent, the left 70 to 75.—EDITOR.

I have a single barrel, 20 bore, Remington. Though I have owned it 11 years and given it hard use, it is still as good as new. It has 28 inch, full choke barrel and flying lock action. I hunted woodchucks with it 5 or 6 summers. The man who paid me the bounty on them said I brought in more scalps than any other man in the State.

Richard Gill, Fall River, Mass.

Utica, N. Y.

I should like to hear from Canadian readers their experience with the Enfield rifle, .577 caliber. I have one and like it.

Chas. Raynes, Fairville, N. B.

The proprietor of a New York hotel says that one night one of his guests came into the hotel much excited. When asked what was the matter, he said: "As I was coming along the street a fellow jumped in front of me, pointed a pistol at me, and said:

"Give me your money or I'll blow your brains out!"

"What did you do?"

"I told him to blow away; that I would rather be in New York without brains than without money."—Hotel Reporter.

NATURAL HISTORY.

When a bird or a wild animal is killed, that is the end of it. If photographed, it may still live and its educational and scientific value is multiplied indefinitely.

PHEASANTS AS GAME BIRDS.

H. R. FOSTER.

There are many kinds of pheasants, but few of them are adapted for game birds for this country. Only 2 species have been tried to any extent, the English ring-neck and the Chinese, in the Eastern part of the United States, and the Chinese in the Western part. The English pheasant, *Phasianus colchicus*, was the first distinct species of pheasant known in Europe. They were brought from the banks of the River Colchis, in Asia Minor, and so were called *colchicus*. These birds were dark, the whole coloring inclined to dark, rich red. The *torquatus*, from China, was next introduced into England, and W. B. Tegetmeier, in his book on pheasants, says, "Such swamping effects of interbreeding have practically stamped out in the British Islands the 2 different looking races of pheasants which were introduced into them, *Phasianus colchicus*, from Asia Minor, and *Phasianus torquatus*, from China. The pheasant of the British Islands is, with rare exceptions, only a mongrel between these 2 races;" and this is what is called the English ringneck. Being mongrels, the ringnecks are variable in plumage, hardly any 2 being alike. The white in the neck varies from one feather just tipped with a speck of white to nearly a complete circle. The rest of the plumage is darker and duller colored than that of the Chinese pheasant. In disposition the ringnecks are comparatively loggy and tamable, and they fall an easy prey to their enemies as well as to the sportsman. There have been several attempts to introduce the English ringneck into the New England States. They stand the winters fairly well, but fail to increase and finally disappear.

The Chinese pheasant, *Phasianus torquatus*, is found in vast numbers everywhere in the North of China. The specific name, *torquatus*, is derived from *torquis*, a chain, or collar, around the bird's neck. This collar of the male bird is conspicuous, of shining white feathers, being broad at the sides and narrower before and behind. Over each eye is a conspicuous streak of buffy white. The cock is truly a bird of many colors. The shades of green of the head, with the white collar, the white lines over the eyes, the deep scarlet of the papillated skin round the eyes, the green and lavender tints on the back, the blue and orange of the saddle, are particularly

pleasing. Then the long olive tail, barred with black passing into reddish brown on the sides, and the rich breast that shades to deep copper color in the sun, make him a beautiful bird indeed.

In 1881 the Chinese pheasant was introduced direct from China to Oregon and liberated for a game bird by Hon. O. N. Denny, of Portland, while he was Consul General to China. These birds by some have been called Mongolian pheasants, but that is a misnomer. In the Mongolian the wing coverts are white. Mr. Tegetmeier, in his book, printed in 1897, says: "None of these birds are known in a living state in Europe;" and one breeder says the Mongolian pheasant has never been seen in this country. The pure Chinese is an active, quick, untamable and wary bird, constantly on the alert; a bird of bold flight, rising through the covert with great quickness and then pursuing a swift, straight course. Chinese pheasants like the open fields, pastures and brush lands better than deep woods. They will thrive wherever quails will. They do not drive away other birds. The hens have been known to lay in the same nest with partridges.

The food of Chinese pheasants consists of insects of every description, worms, seeds of all kinds, fruit, berries, grain, green, tender herbs, grass and roots of many kinds, varying with the time of year. These birds are great insect eaters. Tegetmeier tells what has been found in crops of some after being shot. In one there were upward of 1,200 wire worms; in another 726 wire worms, one acorn, one snail, 9 berries and 3 grains of wheat; in another 440 grubs of the crane fly, which is exceeding destructive to the roots of grass. Pheasants are fond of the spangles of the oaks and many of the roots of weeds. Being natives of a cold part of China they are the hardiest of all birds, capable of going a long time without food. Birds have been found all right after being snowed under a week, in time of a blizzard.

Chinese pheasants lay early and produce an abundant supply of eggs. In Oregon they raise 2 broods and sometimes 3 a year. The hens lay 15 to 20 eggs each time and hatch them all. The eggs vary in color from greenish brown to greyish green and are a little larger than a common pigeon's egg. These pheasants are said to pair and bring up the young together. The cocks have been seen sitting

on the nest. The old birds have great nerve and will fight a hawk or anything that comes near them. In Ohio, where some Chinese pheasants were liberated, residents report, "Birds came through the winter all right, though they had no food or shelter given them. They will stand any degree of cold. There is no doubt of their increasing rapidly in their wild state." A man who liberated some in Connecticut says, "They stood the winter well without food or shelter being given them. In fact, I do not think they feel the cold so much as our native game birds do."

In 1896 the State game protector of Oregon said, "These pheasants have increased and done well and have become the favorite market bird in Portland, over 10,000 having been sold during one month, October 15 to November 15, the open season." One who has hunted pheasants in Oregon says, "The meat is white, of a game flavor, and I consider them the choicest eating of any game bird."

The Massachusetts game commission first put out in 1895 a few Chinese pheasants. Individuals and gun clubs later put out others and from localities where liberated these birds have done well. The Fitchburg gun club liberated 500 in the Northern part of the State and last year broods were seen while there were yet patches of snow on the ground. No birds could be better adapted for our coverts than are Chinese pheasants. Where tried they are regarded as the future game bird of this country, as they can stand not only the severe heat of summer, but the cold and blizzard of the winter.

Ashby, Mass.

EARLY SPRING ON THE SUSQUEHANNA.

J. A. LORING.

About the middle of April, 1902, in company with a friend, I shipped my canoe to Binghamton, N. Y., and came down the beautiful Susquehanna river to Owego, a distance of about 25 miles. The river was high, and the muskrats, whose winter houses of reeds, leaves, sticks and clods of dirt had been washed away, were also flooded out of their burrows in the banks of the stream, and had taken shelter in the floating refuse and clumps of willows along the water's edge. As the canoe darted past they plunged into the water and dived, then came to the surface farther down stream, swam back to the thicket and hid, with only the tips of their noses exposed.

On a small rise of ground, almost submerged, was a woodchuck that had been driven from his burrow by the rising water several weeks in advance of nature's schedule. He appeared truly miserable, cuddled at the entrance of his hole, but

seemed none the worse after his long winter's fast, and had fat enough to last him several more months should occasion demand. We condoled with him over his hard luck, then passed on.

Noticeable by their absence were the grebes. We saw but one of these duck-like birds on the trip, where 5 years ago large flocks were found. Several species of grebes inhabit that region; the most common being the horned grebe, next Holboell's grebe, then the piedbill and eared grebes. Time was when these interesting birds were amply able to take care of themselves, but since the invention of smokeless powder and the demand by milliners for the breasts of grebes the birds are fast being exterminated. They are remarkable swimmers and divers, and when fired at with a shot gun loaded with black powder they dive at the sight of the flash and are out of harm's way before the shot reaches the spot. In Canada and the Northwestern United States thousands of grebes are killed by plume hunters. During the breeding season the plume hunters secrete themselves near the grebes' floating nests of reeds, and by using smokeless powder slaughter the parent birds when they return to their eggs or young.

All along the route we were greeted by the spring songs of the chickadee and the nuthatch, and from a cluster of maples came the familiar rapping of a hairy woodpecker. Had I been ashore I could have called him closer by tapping on a dead tree with the back of my knife, as I have many times done.

A flock of redwing blackbirds passed over and rested a few minutes in the top of a large maple tree, before continuing North. During the spring migrations the males precede the females by several days, and these were the advance guard of old males. Among the babble of voices I recognized the notes of the rustic and purple grackles. They were evidently enjoying the sociability of the redwings while on the long journey to their breeding grounds. They will then separate, and after the nestlings have been reared their families will unite and spend the harvest days about the country meadows and grain fields, where the damage they do to crops is more than compensated for by the large number of insects and larvæ destroyed early in the season.

All the birds seen were species that wintered not far South; the robin, song sparrow, meadow lark, blue bird and belted kingfisher. They are birds which hurry North with the first warm days, only to be driven back several times by cold waves before summer really begins. Such birds as the Baltimore oriole, chimney swift, ruby throated humming bird, and many of the

warblers and vireos, are more cautious in their migratory movements. They make their appearance only when the season is so well advanced that there is scarcely any danger of being obliged to return.

On nearing the village of Owego, my attention was drawn by a number of crows to a pair of red shouldered hawks circling far above a clump of heavy timber. Crows never miss an opportunity to make a hawk's life miserable, although the latter seldom attacks them. Crows have a distinct note of alarm, which they always give on seeing a hawk or an owl. To a naturalist it is never mistaken. They call out the words, clear and distinct, "hawk! hawk! hawk!" Soon answering calls are heard and other crows join in the chase. They fly above the hawk and swoop down at him one at a time, until you would think they were surely going to strike, but when within a few feet of him they gracefully spread their wings and quickly ascend. Frequently the hawk deems it advisable to take shelter in a tree, where he is better able to protect himself. I do not remember ever seeing a crow actually strike a hawk.

The red shouldered hawk is a particularly noisy species, and during migration invariably travels in pairs or families. Unlike many birds, they do not mate every spring, but choose their companions for a lifetime. I made the acquaintance of a pair of these birds that nested 10 successive years in a small forest bordering a swamp, their favorite locality, on the premises of ex-Secretary Benjamin F. Tracy. To my knowledge they occupied the same nest several seasons, then built a new one near. Considerable timber has been cut since they first began to nest there, and from time to time several of the old birds and their young have been shot; but the remaining parent has secured another mate, and they return every spring to their dear old homestead in or near the mammoth oak where the first nest was built, there to raise their family.

Owing to the noisy habits of the red shouldered hawk these birds are easily discovered, and as they are not so shy as other species of hawks, they are wantonly destroyed by hunters and farmers, who suppose them to be injurious to poultry yards. If they knew that in reality the hawks' food consists principally of mice and insects, they would be as anxious to protect as they now are to destroy them.

HOW TO TRAP POCKET GOPHERS.

From Mr. F. A. Olds's description in February RECREATION of the work done in his garden by a depredator, I believe he is correct in identifying the animal as a pocket gopher. If Mr. Olds wishes to catch the

gopher, he should level one of the fresh mounds of earth, and after finding the burrow through which the dirt was thrown out, open it with a trowel or a case knife. After a few minutes' work he will break into the main passage, running right and left. Remove the loose earth and set a No. O Blake-Lamb steel trap, placing it in such a position that when sprung the jaws will be parallel with the burrow. To do this it may be necessary to enlarge the runway, in order to permit the free working of the trap. Be sure that the trap is set in the main runway, and not in the short spur through which the dirt was removed. Do not attempt to bait, or to conceal the trap in any way, and it is of vital importance that the hole should be left open.

On visiting his trap in the morning a novice will often find it buried in earth and a fresh mound of dirt in the place of the one he had leveled; but after a little experience in gopher trapping this will not occur so often.

Pocket gophers tunnel about a foot under the surface of the ground, disposing of the earth by digging to the top occasionally and pushing it out, as Mr. Olds describes. They work during the evening, at night and early in the morning; also on cloudy days. They dislike light, and as soon as possible will block any holes that cattle or horses make by stepping into their runways. I have frequently set a trap at each end of the row of mounds, and within 20 minutes have caught the gopher.

While one of the old style steel traps with the clumsy spring will do, I advise the use of a No. O Blake-Lamb trap, as suggested. There is as much difference between one of them and the old style trap as there is between a black powder gun and a modern Savage rifle.

J. A. Loring, Owego, N. Y.

NOT SNAKE BUT LARVA.

I have read with interest Mrs. Marriott's article in February RECREATION regarding what she at first supposed to be a small snake which was causing a commotion among her chickens. I readily recognize it, from her description, to be the larva of our tiger swallowtail butterfly, *Papilio turnus*. During the most of its caterpillar life its color is green, but when through feeding and about to change into the chrysalis state, it changes to a reddish brown color and wanders from its food plant in search of a sheltered place to suspend itself for the winter. When disturbed it has the power of raising its anterior end and swelling same to such an extent that it strongly resembles the head of a small snake. The 2 eyelike spots help out this simulation, especially when it sways

its head from side to side and shoots out its 2 bright, orange colored fangs, which are nothing more nor less than scent horns given it by nature for its protection. If Mrs. Marriott had placed her head a little closer when its horns were projecting she would undoubtedly have noticed a strong, pungent odor, unless that had previously been exhausted on her chickens; the odor being especially disagreeable to birds and insects that prey on caterpillars.

Your Natural History department is a splendid feature of a most interesting magazine and can not help but serve as a stimulus to all readers who are in any way interested in the subject.

Oliver B. Coe, Jr., Newton Centre, Mass.

SHOT WITH A FEATHER.

Something like half a century ago, when a lad residing near Owego, N. Y., I made a shot which was so strange that I am prompted to tell of it.

A young companion, the son of a Dr. Barney, was shooting catbirds for robbing a cherry tree in his front yard. I begged for a shot and he handed me the gun. I was about 8 feet from the tree when a catbird alighted on a limb extending away from the tree on the farther side. I fired quickly.

On picking up the bird a wing feather was found with the quill sticking half through its head, and so tightly that the bird could be held by it. We showed it to the Doctor, who expressed great astonishment and asked his son if he had loaded the gun with feathers.

Further examination revealed the fact that 2 birds had flown into the tree, one of them alighting in a clump of leaves about 2 feet from the muzzle of the gun. His body was blown to atoms and the head and tail hung down on either side of the limb he was resting on when shot. It was one of his feathers that was blown through his mate's head; but whether it went into a shot hole or made its own hole we could not determine.

I may add that the value of catbirds to the farmer was not appreciated at that time.

H. A. Dobson, M.D., Washington, D. C.

The other day I was in the marsh near here, and much to my amazement and joy I saw a large flock of black mallards. Last spring they staid about the marsh until late in March, numbering at that time about 45. Now they have returned and their numbers reach near 300. I identified the flock by 2 of its members, each having a white head. As the ice is well formed on the Branch and is too thin to hold anybody, yet too thick for a boat to get through, these ducks will have a rest from

the persecutions of the numerous sportsmen around here.

Henry B. Floyd, Washington, D. C.

I had been absent from home several months, and when I returned, our dog, a small black cur, would not recognize me. He walked around me in a circle, growling and snarling. After acting in this way a while, he ventured near enough to smell of my shoes, which were the same I wore when leaving home. Instantly he sprang upon my lap and licked my face, wagging his tale joyfully.

William Gies, Pasadena, Cal.

A friend in the country, writing me October 15, said he knew of a quail with a brood of young, then only 2 weeks old, also another flock about half grown. Can you tell me the cause of this late hatching, or is it a common occurrence?

RECREATION is surely a hummer and your roasting of game hogs can not be beaten. We have a few hogs in this part of the country.

W. H. Groth, St. Paris, O.

A LAY OF ANCIENT ROME.

Oh, the Roman was a rogue,
He erat, was, you bettum;
He ran his automobilis
And smoked his cigarettum;
He wore a diamond studibus
And elegant cravattum,
A maxima cum laude shirt,
And such a stylish hattum.

He loved the luscious hic-hæc-hock,
And bet on games and equi;
At times he won; at others, though,
He got it on the nequi;
He winked (quo usque tandem?)
At puellas on the Forum,
And sometimes even made
Those goo-goo oculorum.

He frequently was seen
At combats gladiatorial,
And ate enough to feed
Ten boarders at Memorial;
He often went on sprees,
And said, on starting homus,
"Hic labor—opus est,
Oh, here's my hic—hic—domus!"

Although he lived in Rome—
Of all the arts the middle—
He was (excuse the phrase)
A horrid individ'l.
Ah, what a different thing
Was the homo (dative, hominy)
Of far-away B. C.
From us of Anno Domini!

—Shanghai Times.

THE LEAGUE OF AMERICAN SPORTSMEN.

GENERAL OFFICERS

President, G. O. Shield, 23 W. 24th St., New York.

1st Vice-President, E. T. Seton, 80 West 40th St., New York.

2d Vice-President, W. T. Hornaday, 2969 Decatur Ave., Bedford Park, N. Y.

3d Vice-President, Dr. T. S. Palmer, Dept. of Agriculture, Washington, D. C.

4th Vice-President, A. A. Anderson, 80 West 40th St., New York.

5th Vice-President, Hon. W. A. Richards, General Land Office, Washington, D. C.

Secretary, A. F. Rice, 155 Pennington Ave., Passaic, N. J.

Treasurer, Austin Corbin, of the Corbin Banking Co., 192 Broadway, New York City.

ARIZONA DIVISION.

M. J. Foley, Chief Warden, Jerome.

ARKANSAS DIVISION

W. R. Blockson, Chief Warden, Eureka Springs.

CALIFORNIA DIVISION.

Dr. David Starr Jordan, Chief Warden, Leland Stanford University. C. Barlow, Sec.-Treas., Santa Clara.

COLORADO DIVISION.

A. Whitehead, Chief Warden, 303 Tabor Building, Denver.

CONNECTICUT DIVISION.

Hon. F. P. Sherwood, Chief Warden, Southport; Dr. H. L. Ross, Vice-Warden, Canaan; H. C. Went, Sec.-Treas., Bridgeport.

DISTRICT OF COLUMBIA DIVISION.

C. H. Townsend, Chief Warden, U. S. Fish Commission.

FLORIDA DIVISION.

W. W. K. Decker, Chief Warden, Tarpon Springs

GEORGIA DIVISION.

J. J. Doughty, Chief Warden, Augusta.

IDAHO DIVISION.

L. A. Kerr, Chief Warden, Kendrick

ILLINOIS DIVISION.

M. D. Ewell, M. D., Chief Warden, 59 Clark St., Chicago; F. M. Taber, Vice Warden, 144 Kinzie St., Chicago; G. C. Davis, Sec.-Treas., 123 S. Central Ave., Austin.

INDIANA DIVISION.

Frank L. Littleton, Chief Warden, 30½ East Washington St., Indianapolis; J. J. Hildebrandt, Vice Warden, Logansport; T. J. Carter, Sec.-Treas., State House, Indianapolis.

IOWA DIVISION.

Carl Quimby, Chief Warden, Des Moines; C. C. Proper, Sec.-Treas., Des Moines.

KANSAS DIVISION.

O. B. Stocker, Chief Warden, Wichita; A. J. Applegate, Sec.-Treas., 113 E. 1st St., Wichita

KENTUCKY DIVISION.

Geo. C. Long, Chief Warden, Hopkinsville.

R. L. Brashear, Sec.-Treas., Bowling Green.

MAINE DIVISION.

Col. E. C. Farrington, Chief Warden, Augusta.

MARYLAND DIVISION

J. E. Tylor, Chief Warden, Baltimore.

MASSACHUSETTS DIVISION.

Heman S. Fay, Chief Warden, Hazleton Block, Marlboro; J. E. Tweedy, Vice-Warden, North Attleboro; A. C. Lamson, Sec.-Treas., 194 Main St., Marlboro.

MICHIGAN DIVISION.

J. Elmer Pratt, Chief Warden, Grand Rapids; R. S. Woodliffe, Vice-Warden, Jackson; A. B. Richmond, Sec.-Treas., Grand Rapids.

MINNESOTA DIVISION.

Dietrich Lange, Chief Warden, 2294 Commonwealth Ave., St. Paul.

H. A. Morgan, Vice-Warden, Albert Lea; Prof. O. T. Denny, Sec.-Treas., St. Paul.

MISSOURI DIVISION.

Bryan Snyder, Chief Warden, 726 Central Bldg., St. Louis.

MONTANA DIVISION.

Professor M. J. Elrod, Chief Warden, Missoula; Sidney M. Logan, Vice-Warden, Kalispell; R. A. Waagner, Sec.-Treas., Bozeman.

NEBRASKA DIVISION.

Fred. E. Mockett, Chief Warden, Lincoln; P. O'Mahony, Sec.-Treas., Lincoln.

NEVADA DIVISION.

Dr. W. H. Cavell, Chief Warden, Carson.

Geo. W. Cowing, Sec.-Treas., Carson.

NEW HAMPSHIRE DIVISION.

Dr. A. F. Barrett, Sentinel Bldg., Keene,

Sidney Conant, Sec.-Treas., Keene.

NEW JERSEY DIVISION.

Percy Johnson, Chief Warden, Bloomfield; Dr. W. S. Colfax, Vice-Warden, Pompton Lakes; I. V. Dorland, Sec.-Treas., Arlington.

NEW MEXICO DIVISION.

W. M. Borrowdale, Chief Warden Magdalena.

NEW YORK DIVISION.

John R. Fanning, Chief Warden, Powers' Bldg., Rochester; Col. R. E. Moss, Vice-Warden, Wallack's Theatre, New York City; Dr. C. C. Curtis, Sec.-Treas., Columbia College, New York City.

NORTH DAKOTA DIVISION.

Dr. W. D. Jones, Chief Warden, Devil's Lake.

OHIO DIVISION.

W. E. Gleason, Chief Warden, Mitchell Bldg., Cincinnati; A. C. Thatcher, Vice-Warden, Urbana.

OKLAHOMA DIVISION.

W. M. Grant, Chief Warden, Oklahoma City.

ONTARIO DIVISION.

C. A. Hammond, Chief Warden, Box 701, St. Thomas; D. L. Mells, Sec.-Treas., St. Thomas.

OREGON DIVISION.

Robert F. Kelly, Chief Warden, Box 188, The Dalles; C. B. Cushing, Sec.-Treas., The Dalles.

PENNSYLVANIA DIVISION.

C. F. Emerson, Chief Warden, 189 N. Perry St., Titusville; Hon. C. B. Penrose, Vice-Warden, 1720 Spruce St., Philadelphia; E. Wager-Smith, Sec.-Treas., 1026 Ridge Ave., Philadelphia.

RHODE ISLAND DIVISION.

Zenas W. Bliss, Chief Warden, 49 Westminster St., Providence.

SOUTH CAROLINA DIVISION.

C. F. Dill, Chief Warden, Greenville.

SOUTH DAKOTA DIVISION.

D. C. Booth, Chief Warden, Spearfish; John C. Barber, Sec.-Treas., Lead.

TENNESSEE DIVISION.

Hon. G. C. Martin, Chief Warden, Clarksville; Hon. Austin Peay, Jr., Sec.-Treas., Clarksville.

TEXAS DIVISION.

Prof. S. W. Stanfield, Chief Warden, Weatherford; W. E. Heald, Sec.-Treas., San Angelo.

UTAH DIVISION.

Hon. John Sharp, Chief Warden, Salt Lake City.

VERMONT DIVISION.

W. E. Mack, Chief Warden, Woodstock; S. C. White, Sec.-Treas., Woodstock.

VIRGINIA DIVISION.

Franklin Stearns, Chief Warden, 13 N. 11th St., C. O. Saville, Vice Warden, Richmond; M. D. Hart, Sec.-Treas., 1217 East Main St., Richmond.

WASHINGTON DIVISION.

F. S. Merrill, Chief Warden, Spokane; F. A. Pontius, Sec.-Treas., Seattle; Munro Wyckoff, Vice-Warden, Pt. Townsend.

WEST VIRGINIA DIVISION.

E. F. Smith, Chief Warden, Hinton,
WISCONSIN DIVISION.

Frank Kaufman, Chief Warden, Two Rivers; Dr.
A. Gropper, Sec.-Treas., Milwaukee.

WYOMING DIVISION.

H. E. Wadsworth, Chief Warden, Lander; Frank
Bond, Sec.-Treas., Cheyenne.
*Applications for membership and orders for badges
should be addressed to Arthur F. Rice, Secretary, 23 W.
24th St., New York.*

LOCAL WARDENS IN NEW YORK.

County.	Name of Warden.	Address.
New York,	Conrad L. Meyer,	46 W. Broadway.
Livingston	M. De La Vergne,	Lakeville.
"	K. S. Chamberlain,	Mt. Morris.
"	Henry Skinner,	Springwater.
Albany,	C. D. Johnson,	Newtonville.
"	Henry T. Newman,	"
"	Kenneth E. Bender,	Albany.
Broome,	John Sullivan,	Sanitavia Springs
"	R. R. Mathewson,	Binghamton.
Cayuga,	H. M. Haskell,	Weedsport.
Chemung,	Fred. Uhle,	Hendy Creek,
"	M. A. Baker,	Elmira.
Cortland,	James Edwards,	Cortland.
Erie,	E. P. Dorr,	103 D. S. Morgan Building, Buffalo.
"	Marvin H. Butler,	Morilla.
Essex,	W. H. Broughton,	Moriah.
Franklin,	Jas. Eccles,	St. Regis Falls.
Montgomery,	Charles W Scharf,	Canajoharie.
Oneida,	J. M. Scoville,	Clinton.
Orange,	Wilson Crans,	Middletown.
"	J. Hampton Kidd,	Newburgh.
"	Thomas Harris,	Port Jervis.
Richmond,	Lewis Morris,	Port Richmond.
St. Lawrence,	Dr. B. W. Severance,	Gouverneur.
"	A. N. Clark,	Sevey.
Schenectady,	J. W. Furnside,	Schenectady.
Suffolk,	F. J. Fellows,	Central Islip, L. I.
"	P. F. Tabor,	Orient, L. I.
Tioga,	Geo. Wood,	Owego.
Washington,	C. L. Allen,	Sandy Hill.
"	A. S. Temple,	Whitehall.
"	J. E. Barber,	Dresden.
Westchester,	George Poth,	Pleasantville.
"	Chas. Seacor,	57 Pelham Road, New Rochelle.
"	M. W. Smith,	Croton Falls.
"	Ralph Gorham,	Mt. Kisco
Dutchess,	} A. B. Miller,	Jackson's Corners'
Columbia,		
Onondaga,	James Lush,	Memphis.
Yates,	B. L. Wren,	Penn Yan.
"	Symour Poineer,	Branch Port.
Dutchess,	Chas. H. DeLong,	Pawling.
"	Jacob Tompkins,	Billings.
Queens,	Gerard Van Nostrand,	Flushing, L. I.
"	W. S. Mygrant,	46 Elton Street, Brooklyn.
"	P. A. Geepel,	473 Grand Ave., Astoria, L. I.
"	L. B. Drowne,	119 Somers Street, Brooklyn.
Ulster,	M. A. DeVal,	The Corners.
"	Wm. S. Mead,	Woodstock.
Jefferson,	C. J. Smith,	Watertown.
Herkimer,	D. F. Sperry,	Old Forge.
Oswego,	J. E. Manning,	154 West Utica St.
Putnam,	H. L. Brady,	Mahopac Falls.
Schuyler,	G. C. Fordham,	Watkins.
Allegany,	G. A. Thomas,	Belvidere.
Schoharie,	O. E. Eigen,	Sharon Springs.
Warren,	Geo. McEchron,	Glen Falls.
Orleans,	J. H. Fearby,	E. Shelby.
Greene,	W. J. Soper,	Windham.
Hamilton,	David Aird, Jr.,	Lake Pleasant.

LOCAL WARDENS IN OHIO.

Stark,	A. Dangeleisen,	Massillon.
Franklin,	Brook L. Terry,	208 Woodward Av., Columbus.
Cuyahoga,	A. W. Hitch,	161 Osborn St., Cleveland.
Clark,	Fred C. Ross,	169 W. Main St., Springfield.
Erie,	David Sutton,	418 Jackson St., Sandusky.
Fulton,	L. C. Berry,	Swanton.
Hamilton,	W. C. Rippey,	4465 Eastern Ave., Cincinnati.

County.	Name of Warden.	Address.
Allen,	S. W. Knisely,	Lima.
Knox,	Grant Phillips,	Mt. Vernon.
Lorain,	T. J. Bates,	Elyria.
Ottawa,	Frank B. Shirley,	Lakeside.
Muskingum,	Frank D. Abell,	Zanesville.
Scioto,	J. F. Kelley,	Portsmouth.

LOCAL WARDENS IN CONNECTICUT.

Fairfield,	George B. Bliss.	2 Park Row, Stam- ford, Ct.
"	Harvey C. Went,	11 Park St., Bridge- port, Ct.
Fairfield,	Samuel Waklee,	Box 373, Stratford.
Litchfield,	Dr. H. L. Ross,	P. O. Box 100, Can- naan, Ct.
Middlesex,	Sandford Brainerd,	Ivoryton.
New Haven,	Wilbur E. Beach,	318 Chapel Street, New Haven, Ct.
"	D. J. Ryan,	188 Elizabeth St., Derby.

LOCAL WARDENS IN MASSACHUSETTS.

Norfolk,	Orlando McKenzie,	Norfolk.
"	J. J. Blick,	Wrentham.
"	S. W. Fuller,	East Milton.
Suffolk,	Capt. W. J. Stone,	4 Tremont Row, Boston.
Worcester,	B. H. Mosher,	Athol.

LOCAL WARDENS IN NEW JERSEY.

Mercer,	Jos. Ashmore,	124 Taylor St., Trenton.
Mercer.	Edw. Vanderbilt,	Dentzville, Trenton.
"	Roland Mitchell,	739 Centre St., Trenton
Morris,	Joseph Pellet,	Pompton Plains.
"	Chas. W. Blake,	Dover.
"	Francis E. Cook,	Butler.
"	Calone Orr,	Hibernia.
Somerset,	G. E. Morris,	Somerville.
Sussex,	Isaac D. Williams,	Branchville.
Union,	A. H. Miller,	Cranford.
"	C. M. Hawkins,	Roselle.
Warren,	{ Jacob Young,	} Phillipsburg.
"	{ Reuben Warner,	
Monmouth.	Dory-Hunt,	Wanaque.
Hudson,	A. W. Letts,	51 Newark St., Hoboken

LOCAL WARDENS IN PENNSYLVANIA.

Jefferson,	John Noll,	Sykesville.
Perry,	Samuel Sundy,	Lebo.
Warren.	F. P. Sweet,	Goodwill Hill.
"	Nelson Holmes,	Cornplanter.
Juniata,	Clifford Singer,	Oakland Mills.
"	Ezra Phillips,	McAlesterville.
Venango,	G. D. Benedict,	Pleasantville.
Potter,	Ira Murphy,	Coudersport.
"	Wiley Barrows,	Austin.
"	Chas. Barrows,	Austin.
Crawford,	Jasper Tillotson,	Tillotson.
"	Geo. T. Meyers,	Titusville.
"	J. B. Lamb,	Buel.
Cambria,	W. H. Lambert,	720 Coleman Ave., Johnstown.
Butler,	F. J. Forquer,	Murrinsville.
Allegheny,	S. H. Allen,	Natrona.
Beaver,	N. H. Covert,	Beaver Falls.
"	W. R. Keefer,	"
McKean,	C. A. Duke,	Duke Center.
"	L. P. Fessenden,	Granere.
"	Wm. Holsinger,	Stickney.
Lackawanna,	Wm. Weir,	Moosic.
"	Wm. Major.	"
Carbon,	Asa D. Hontz,	East Mauch Chunk.
Cumberland,	J. C. Gill,	Mechanicsburg.
Wyoming,	Cyrus Walter,	Tunkhannock.
Tioga,	E. B. Beaumont, Jr.,	Lawrenceville.
"	G. H. Simmons,	Westfield.
Lycoming,	Jas. J. Brennan,	Oval.
"	B. D. Kurtz,	Cammal.
Delaware,	Walter Luson,	Ardmore.
Montgomery,	L. C. Parsons,	Academy.
Bradford,	Geo. B. Loop,	Sayre.
Clarion,	Isaac Keener,	New Bethlehem.
Cameron,	Harry Hemphill,	Emporium.
Clinton,	M. C. Kepler,	Renovo.
"	Geo. L. Kepler,	Renovo.
Northumber-land,	{ G. W. Roher,	} 505 Anthracite St., Shamokin
Elk,	{ D. R. Lobaugh,	

LOCAL WARDENS IN MICHIGAN.

County.	Name of Warden.	Address.
Ottawa,	W. H. Dunham,	Drenthe.
Kalamazoo,	C. E. Miller,	Augusta.
Berrien,	W. A. Palmer,	Buchanan.
Cass,	Thomas Dewey,	Dowagiac.
Hillsdale,	C. A. Stone,	Hillsdale.
Lake,	John Trieber,	Peacock.

LOCAL WARDENS IN VIRGINIA.

Mecklenburg,	J. H. Ogburn,	South Hill.
King William,	N. H. Montague,	Palls.
Smythe,	J. M. Hughes,	Chatham Hill.
King & Queen,	R. D. Bates,	Newtown.
Louisa,	J. P. Harris,	Applegate.
Henrico,	W. J. Lynham,	412 W. Marshall.
Richmond.		
East Rockingham,	E. J. Carickhoff,	Harrisonburg.

LOCAL WARDENS IN WYOMING.

Fremont,	Nelson Yarnall,	Dubois.
Uinta,	{ S. N. Leek,	} Jackson.
	{ F. L. Peterson,	
Carbon,	Kirk Dyer,	Medicine Bow.
Laramie,	Martin Breither,	Cheyenne.

LOCAL WARDENS IN TENNESSEE.

Sumner,	W. G. Harris,	Gallatin.
Stewart,	John H. Lory,	Bear Spring.
Robertson,	C. C. Bell,	Springfield.
Montgomery,	P. W. Humphrey,	Clarksville.
Madison,	H. T. Rushing,	Jackson.

LOCAL WARDENS IN NEBRASKA.

Hall,	E. C. Statler,	Grand Island
-------	----------------	--------------

LOCAL WARDENS IN NEW HAMPSHIRE.

Cheshire,	S. C. Ellis,	Keene.
Sullivan,	G. A. Blake,	Lempster.
"	J. W. Davidson,	Charlestown.

LOCAL WARDENS IN VERMONT.

Rutland,	Wm. J. Liddle,	Box 281, Fair Haven
Windsor,	F. A. Farbell,	West Bridgewater.
Orleans,	E. G. Moulton,	Derby Line.
Essex,	H. S. Lund,	Granby.

LOCAL WARDENS IN ILLINOIS.

Rock Island,	D. M. Slottard,	12th Ave and 17th
		St., Moline.
Iroquois,	J. L. Peacock,	Sheldon.

LOCAL WARDENS IN OKLAHOMA.

Kiowa and Comanche Nation,	A. C. Cooper,	Ft. Sill.
----------------------------	---------------	-----------

LOCAL WARDENS IN IOWA.

Clinton,	D. L. Pascal,	Grand Mound.
Pottawattamie,	Dr. C. Engel,	Crescent.

LOCAL WARDENS IN WASHINGTON.

Okanogan,	James West,	Methow.
Stevens Co.,	Jacob Martin,	Newport.

LOCAL WARDENS IN UTAH.

Washington,	S. C. Goddard,	New Harmony.
"	J. A. Thornton,	Pinto.

LOCAL WARDENS IN KANSAS.

Ness,	Frank Lake,	Ransom.
-------	-------------	---------

LOCAL CHAPTERS.

Albert Lea, Minn.,	H. A. Morgan,	Rear Warden.
Angelica, N. Y.,	C. A. Lathrop,	"
Augusta, Mont.,	H. Sherman,	"
Austin, Minn.,	G. F. Baird,	"
Austin, Pa.,	W. S. Warner,	"
Boston, Mass.,	Capt. W. I. Stone,	"
Buffalo, N. Y.,	H. C. Gardiner,	"
Cammal, Pa.,	B. A. Ovenshire,	"
Champaign Co., O.	Hy. F. MacCracken	"
	Urbana,	"
Charlestown, N. H.,	W. M. Buswell,	"
Cheyenne, Wyo.,	J. Hennessy,	"
Choteau, Mont.,	G. A. Gorham,	"
Cincinnati, Ohio,	B. W. Morris,	"
Coudersport, Pa.,	I. L. Murphy,	"
Cresco, Iowa,	J. L. Platt,	"
Davis, W. Va.,	J. Heltzen,	"
Dowagiac, Mich.,	W. F. Hoyt,	"
East Mauch Chunk, Pa.,	E. F. Fry,	"
Evansville, Ind.,	F. M. Gilbert,	"
Fontanet, Ind.,	W. H. Perry,	"
Ft. Wayne, Ind.,	W. L. Waltmarth	"
Great Falls, Mont.,	J. M. Gaunt,	"
Heron Lake, Minn.,	K. C. Buckeye,	"
Holidays'g, Pa.,	H. D. Hewit,	"
Hookinsville, Ky.,	Hunter Wood,	"
Indianapolis, Ind.,	Joseph E. Bell,	"
Jerome, Ariz.,	Dr. L. A. Hawkins,	"
Johnsonburg, Pa.,	W. J. Stebbins,	"
Kalispell, Mont.,	John Eakright,	"
Keene, N. H.,	F. P. Beedle,	"

Kingfisher, Okla.,	A. C. Ambrose,	Rear Warden.
Lake Co., Ind.,	Dr. R. C. Mackey,	"
Lawton, O. T.,	Marion Miller,	"
Logansport, Ind.,	E. B. McConnell,	"
Ludington, Mich.,	G. R. Cartier,	"
Mechanicsburg, Pa.,	Dr. J. H. Swartz,	"
Minturn, Colo.,	A. B. Walter,	"
New Albany, Ind.,	Dr. J. F. Weathers,	"
New Bethlehem, Pa.,	Isaac Keener,	"
Oklahoma City O. T.,	N. F. Gates,	"
Penn Yan, N. Y.,	Dr. H. R. Phillips,	"
Phillips, Wis.,	F. K. Randall,	"
Princeton, Ind.,	H. A. Yeager,	"
Reynoldsville, Pa.,	C. F. Hoffman,	"
Ridgway, Pa.,	T. J. Maxwell,	"
Rochester, N. Y.,	C. H. McChesney	"
St Paul, Minn.,	O. T. Denby,	"
St. Thomas, Ont.,	L. J. Hall,	"
Schenectady, N. Y.,	J. W. Furnside,	"
Seattle, Wash.,	M. Kelly,	"
Syracuse, N. Y.,	C. C. Truesdell,	"
Terre Haute, Ind.,	C. F. Thiede,	"
The Dalles, Ore.,	C. B. Cushing,	"
Walden, N. Y.,	J. W. Reid,	"
Wichita, Kas.,	Gerald Volk,	"
Winona, Minn.,	C. M. Morse,	"

DISCOUNTS TO LEAGUE MEMBERS.

The following firms have agreed to give members of the L. A. S. a discount of 2 per cent. to 10 per cent. on all goods bought of them. In ordering please give L. A. S. number:

Syracuse Arms Co.,	Syracuse, N. Y.	Guns.
Davenport Fire Arms Co.,	Norwich, Conn.	Shot guns, rifles.
Gundlach Optical Co.,	Rochester, N. Y.	Photographic goods.
Blair Camera Co.,	Rochester, N. Y.	Photographic goods.
The Bostwick Gun and Sporting Goods Co.,	1528 Arapahoe St., Denver, Col.	
James Acheson,	Talbot St., St. Thomas, Ontario,	Sporting goods.
Jespersen & Hines,	10 Park Place, New York City	

LIFE MEMBERS OF THE LEAGUE.

W. D. Ellis,	136 W. 72d street, New York City.
A. F. Rice,	155 Pennington avenue, Passaic, N. J.
Dr. W. A. Valentine,	5 W. 35th street, New York City.
A. A. Anderson,	6 E. 38th street, New York City.
A. V. Fraser,	478 Greenwich street, New York City.
E. S. Towne,	care National Blank Book Co., Holyoke, Mass.
F. G. Miller,	108 Clinton street, Defiance, Ohio.
Gen. J. F. Pierson,	20 W. 52d street, New York City.
E. T. Seton,	80 W. 40th street, New York City.
J. H. Seymour,	35 Wall street, New York City.
A. G. Nesbitt,	Maple street, Kingston, Pa.
D. C. Beard,	204 Amity street, Flushing, L. I.
C. H. Ferry,	1720 Old Colony Bldg., Chicago, Ill.
Hon. Levi P. Morton,	681 5th avenue, New York City.
H. Williams,	P. O. Box 156, Butte, Mont.
D. B. Fearing,	Newport, R. I.
E. H. Dickinson,	Moosehead Lake, Me.
Lorenzo Blackstone,	Norwich, Conn.
A. L. Prescott,	90 W. Broadway, New York City.
G. S. Edgell,	192 Broadway, New York City.
W. B. Mershon,	Saginaw, Mich.
Hon. H. W. Carey,	East Lake, Mich.
George Carnegie,	Fernandina, Fla.
Andrew Carnegie,	2nd, Fernandina, Fla.
Morris Carnegie,	Fernandina, Fla.
W. L. Underwood,	52 Fulton street, Boston, Mass.
C. E. Butler,	Jerome, Ariz.
Mansfield Ferry,	183 Lincoln Park, Boulevard, Chicago, Ill.
Austin Corbin,	192 Broadway, New York City.
J. Stanford Brown,	487 Fifth Ave., New York City.
W. H. Smith,	Bryn Mawr, Pa.
E. B. Smith,	Bourse Bldg. Philadelphia, Pa.
A. J. McClure,	1-8 State street, Albany, N. Y.
F. Walter Thompson,	Times Bldg. New York City.
Clinton Gilbert,	2 Wall St., New York City.

There are thousands of men in the United States who should be life members. Why don't they join? Will someone please take a club and wake them up?

SHOULD RENEW WITHOUT NOTICE,

Many League members complain that they do not get notices of expiration of membership. In any such case, members may rest assured that no fault attaches to this office. A renewal notice is mailed to each member 30 days before his membership would expire. If at the expiration of that time he shall not have renewed, another renewal notice is sent him, marked "Second Notice." If he does not respond, then a personal letter is mailed him in a 2 cent envelope. On an average we send out 500 renewal notices each month, and this requires an outlay of \$5 for one cent stamps. Not more than half of these 500 men renew promptly in any one month; so that there is another outlay of \$2.50 for memory joggers. Perhaps this second serving of notice brings 50 renewal fees. Then at the end of the 90 days from the date of mailing the first renewal notice, we are required to expend over \$4 for 2 cent envelopes in order to send out these 200 personal letters.

Thus it will be seen that at least \$6 is wasted each month for postage where not one cent should be expended; because all members should renew promptly when the first notice is sent.

One trouble is that many men ignore all so called circulars which come in their mail. Some things are different from other things, and it would save the League a large amount of money each year if each member would take the trouble to open and examine the first renewal notice sent him from this office.

The League needs all the money it gets, and \$100,000 a year more, to carry on its legitimate work of game protection; yet it is required to expend several hundred dollars a year in dunning delinquent members that might just as well be saved for more important work if the members would only do their part.

One good way to save all annoyance, both to the employees of the League and to the members, would be for all who can afford to do so to become life members.

LEAGUE NOTES.

The Tacoma, Wash., Ledger, in a recent issue, says, "A game bill has passed both houses of the Legislature that is believed to be as nearly perfect as it is possible to make a game bill. It was prepared by the League of American Sportsmen; and F. A. Pontius, of Seattle, Secretary-Treasurer of the Washington Division of that body, has been at the Capital during the entire session working for the passage of this bill. Chief Warden F. S. Merrill, of Spokane, has also taken active part in securing this legislation for sports-

men. H. Reif, of Seattle, also a League member, has been working for the measure, and has afforded valuable assistance in securing the passage of it."

I have not room here to give a synopsis of the new law, but it is thoroughly up to date in all its provisions. The sportsmen of the State of Washington owe Mr. Pontius a lasting debt of gratitude for his splendid work in their behalf, and they should all join the L. A. S. as a token of their appreciation of his services.

The Nebraska and Texas Legislatures have passed bills, introduced at the request of the League, prohibiting the killing of antelope at any time.

The Hon. David Hanna, of Nebraska, is entitled to the credit of having introduced our bill in the Nebraska Legislature, and the Hon. D. E. Decker, of Quanah, Texas, was our faithful advocate and ally in the Texas Assembly.

Great is the League!

The Hon. James B. Sanford, Speaker of the Colorado House of Representatives, has lately joined the League. This will be unpleasant news for one Bostwick, of Denver, who has lately been busy denouncing this League and advising all Colorado sportsmen to stay out of it.

Inclosed please find \$1, a year's subscription for RECREATION. I am greatly interested in the noble work you are doing for the protection of game in this country. If it were not for you and those associated with you in this good work, there would not be, in 5 years from now, a single wild animal or bird left in this part of the country.

A. J. McClure, Albany, N. Y.

Oh! the game hog he must go,
To those regions down below,
For of slaughtered game he's boasted,
And you bet he'll get well roasted
When he reaches those regions down below.

Charles Raynes.

All copies of your valuable magazine coming into this town are quickly sold. A few of our people still wear bristles, but RECREATION is gradually singeing them.

Herman Vaupel, Marseilles, Ill.

"Mother will be down in a minute."
"Why, the maid said your mother wasn't at home."
"Then won't you please go? It will save me a good licking."—Exchange.

FORESTRY.

EDITED BY DR. B. E. FERNOW,

Director of the New York School of Forestry, Cornell University, assisted by Dr. John C. Gifford of the same institution.

It takes 30 years to grow a tree and 30 minutes to cut it down and destroy it.

In a well established growth of white pine, the seedlings, some 50,000 to 100,000 on an acre, with their symmetrical crowns, sooner or later form a dense canopy, excluding all light from the soil. After a few years the leaves of the lower branches, no longer able to function under the shade of the superior part of the crown and of their neighbors, fail to develop and the branchlets die and break off. This natural cleaning, which secures the desirable clear boles, takes place during the period of rapid height growth, which occurs from the 10th to the 30th year. At the age of 30 years the trees are slender poles, having a diameter of 3 to 5 inches, and a height of 20 to 25 feet, with a few taller ones, the boles bearing a dense conical crown and beset for the greater part of their length with small limbs, the lower ones dead or dying. Not a few trees are seen to fall short of reaching the general upper crown level. The crowns of these laggards are shorter, more open, with fewer leaves on each twig. Others again will be found dead or scarcely vegetating, with crowns poorly developed. In other words, we can recognize different vigor in development according to constitution and accidental opportunity, and can make a differentiation into development classes: the predominant, with their crowns 5 to 10 feet above the general level, which must finally make up the mature stand; the sub-dominant, still alive and, should accident remove some of the superior class, ready to occupy their air space; and the dominated or inferior ones, hopelessly out of the race.

Of the tens of thousands which started only 2,000 or 3,000 are surviving, and as each tree tries to expand its crown, and secure for itself as much air space and space as it can, the result is a continued diminution of the number of trees occupying the acre.

This decimation is in exact mathematical relation, except for accidents, with the development of the dominant, especially in height growth. At the age of 80, of the several thousand trees which started in the race, not more than 400 to 500 are left. Then the diminution proceeds at a slower rate, until finally only 200 to 300 occupy the ground, or as many as can conveniently fill the air space in the upper story, the number varying according to soil and climatic conditions and species.

The time has arrived when the height growth is practically finished. The branches can not lengthen any more to occupy the air space. After this a numerical change can take place only as a result of casualties, caused by fungi, insects, fires, or wind-storms. These, of course, may, from the start, interfere with the regular progress of adjustment which takes place under the effect of physiological laws.

In reality the conditions of soil, climate, and species in combination are so various that this process of evolution does not appear so simple; but the seemingly lawless, yet actually law directed, appearance of a forest growth explains itself by these few observations of the results of action and reaction of its surroundings and of the single components.

The factor of light is not only the most important one in bringing about the evolution of the natural forest, but practically almost the only one under control of man. With the knowledge of the light requirements and with the judicious use of the axe, the forester is enabled to stimulate or suppress one species or another, to direct in quantitative and qualitative development the progress of his crop, and finally to secure the regeneration of the entire forest growths with species that to him are most useful.—Economies of Forestry.

OPPOSED TO FOREST RESERVES.

The supervisors of Trinity county, Col., have appointed an agent to go to Washington and work to procure the vacation of the forest reserve made in that county, on the ground that it is inimical to the interests of the people, and have appropriated a large sum of money to cover the cost of his mission. The Shasta reservation is also meeting with the most bitter opposition. Judge Spencer has written a long and lively indictment of the Shasta reserve, which evidently is supported by the mountain people, and utters their irreconcilable opposition to the policy which it attacks.

Spencer attributes the disastrous floods which sweep down the Sacramento river and other streams in the Sacramento valley to this same forest reserve; and the people, he says, especially the mountain residents, desire to clear out the forests. He goes into a great and lengthy argument to prove that the forests cause the floods.

Taking Judge Spencer's argument as a

whole, it is an excellent discourse to encourage the vigilance of Southern California people in preserving the timber and brush on their own mountains.

Forests hold back the rainfall; they hold a soil and keep it porous, so that the water soaks in, and its passage to the streams is thereby impeded and restrained, so that its delivery to the drainage channel is slow and steady, maintaining the flow of the stream.

When the land is stripped of trees this process ceases in whole or in part. The water rushes rapidly to the channel, carrying with it the soil that is no longer held by the roots of trees. The rapid delivery into the streams turns them into torrents, destroys their meander, which aided the deliberate flow of the water; and when the torrent is past, there being but little water in the soil for slow delivery, the stream declines and its flow in some cases ceases entirely. This is the result of too much interference with the natural equilibrium. Stripping vast watersheds of timber is the prime cause of the floods in the Ohio and the Mississippi; and the Federal Government has to spend millions annually in levees and other artificial works to prevent destruction of vast tracts of farming lands in the valleys of those streams.

So far the Interior Department has rigidly prevented access to and transit across these forest reserves by electric roadbed, which would use for power the water of mountain streams without in the least depleting it, and which would not expose the forest to fire or other means of injury.

Instead of sending public agents to Washington to demand vacation of the reservations, the counties concerned should send them there to advise a change in the method of administering the reserves, by which the damaging and unnecessary isolation of towns and private property would cease. Every reserve should finally be penetrated by electric roads, which would increase the safety of the forests, and by furnishing quick communication cheapen the cost of their administration. A little common sense would remove all this opposition and preserve the forests of California to perform their natural function as the conservators of moisture and fertilizers of soil.—Wood and Iron.

SUGGESTIONS FOR MICHIGAN FORESTS.

Seven suggestions regarding forest botany for the new forests of Michigan were recently given by Charles A. Davis, instructor in forestry in the University of Michigan. He pointed out that much of the land now available for forests is dry, and poor in plant food; that much of it has been devastated by fires, by cattle, and by excessive lumbering. In consideration of

these facts, his suggestions were as follows:

That all vegetation which will grow be protected, in order that the soil may be prevented from further deterioration by wind, by washing, and by leaching.

That tree species, especially such as grow on lands of the classes available, be carefully protected from fire, and cattle.

That the most valuable timber tree of the State, the white pine, will grow on all except the poorest lands. There is no truth in the current popular belief that white pine will not grow on lands from which white pine forests have been recently cut.

Oaks, poplars, red maple, and Norway and jack pines grow naturally all over the available areas, and may be made to serve as nurse trees for more important species, to improve the soil conditions, and as a source of revenue. They may be used for firewood, for posts, railroad ties, pulpwood, cooperage stock, and other small lumber.

The number of those species of trees which grow naturally on the poorest and dryest soils is about a dozen, rather more than 20 per cent of all the species found in the State, but it includes some of the important timber trees.

Foreign species, and those not growing naturally under the conditions which they will be required to endure, should not be planted in large numbers until their adaptability has been thoroughly tested.

There should be a thorough study of the possibilities of the needs of future markets and the selection of those available trees which promise soonest to meet the most general demand.

Twenty-three students have taken up work in the Department of Forestry at the University of Michigan. The course is technical in character and open only to graduate students. Materials for the practical study of the scientific and commercial sides of forestry is being gathered, and will be grown in the university's new botanical gardens. The H. M. Loud Sons Co. has extended the privileges of its lumber camps about Oscoda, Mich., and permanent arrangements for field work are being made. Charles A. Davis, instructor in forestry, spent last summer working in and about the State, studying especially the local conditions. As a result, an oak tree, new to Michigan, and not previously listed, has been discovered. Two courses of instruction are being given this year. One is a synoptical review of the science and the other is a course treating of the laws controlling the development of trees and forests and their application in methods of improving, treating and reproducing forest crops. Other courses that have been

planned are a study of trees and shrubs, their identification, structure, development, relationship, distribution and uses; and forest mensuration. The appointment of Prof. Filibert Roth as head of the department will add great strength to the instructing force. Professor Roth has had much experience in forestry work, having been successively employed in the United States Bureau of Forestry, as assistant professor in the New York State College of Forestry, and as chief of the Department of Forest Reserves in the General Land Office at Washington.

FORESTS IN NEBRASKA'S SAND HILLS.

The task of growing valuable forests on the barren sand hills of Nebraska will begin this spring, when the Bureau of Forestry will seed about 100 acres of the Dismal River Forest Reserve near Halsey with red cedar and jack pine. If the seeding succeeds and is done with economy, the Bureau will seed and plant the following year probably 1,000 acres in cedar and pines and will ultimately extend the forest by gradual plantings over a large part of the 208,000 acres in the Dismal River and Niobrara reserves.

A nursery has been established at Halsey, in the valley of the Middle Loup river, with a half-acre seed bed protected by laths. A tool house and office building have been built. Nearly 600 pounds of seed, principally Western yellow pine, red cedar and jack pine, have been collected for planting in the spring.

The sand hills are unfit for agriculture. If large forests can be grown on them the timber will be of great value to a country now without trees, where lumber brings high prices. The attempt of the Bureau has every chance of success.—Exchange.

The first experiment to demonstrate the possibility of utilizing these sand hills for forest growth was instituted by the Division of Forestry under the direction of Professor Fernow; the result of a plantation made in 1891, proving the adaptation, especially of the jack pine, which is not native to that part of the world.—EDITOR.

TORONTO UNIVERSITY AND FORESTRY.

Toronto University, the State university of the Province of Ontario, is realizing the importance of the subject of forestry. President Loudon has pointed out that the crown forests of Canada exceed those of the United States and Russia put together. The senate of the university has provided a curriculum for a course in forestry, and at its last meeting the Alumni Association, believing that the scientific study of the subject was of the utmost importance to the prosperity of the province, passed a resolution which was sent to the Premier and the Minister of Education, and which urged that the Government give effect to the State provision authorizing a School of Forestry at the earliest possible date.—Exchange.

Before Toronto University ever thought of the existence of such a subject as forestry its rival in Kingston, Ontario, Queen's University, had agitated the need of forestry instruction, and as long as a year ago

secured a promise from the Government for the establishment of such a school; so that probably 2 forestry schools will be established simultaneously in Canada.—EDITOR.

FORESTRY AT WELLESLEY.

Wellesley is the first woman's college in the country to introduce a course in forestry. The course is not designed to prepare women for the profession of forestry, but to acquaint them with the nature of forest problems in the United States. The benefit of the course is proved by the fact that the alumnae who took this course in college are now in every case doing something to awaken interest in forestry and to bring about a clearer knowledge of its practical character. Dr. Grace E. Cooley, who has charge of the work, has already an established reputation as a botanist. She has recently made a special study of forestry with particular reference to such phases as may be useful to women.—Exchange.

THE WHITE MOUNTAIN FORESTS.

New Hampshire is making vigorous efforts to preserve what is left of the beautiful forest covering of the White mountains, that once clothed them with a verdure which gave to their beauty a world-wide fame. This is not only commendable but is in harmony with a spirit of forest preserving and growing that is, fortunately, becoming widespread. New Hampshire has a fine opportunity to enlarge her forest domain in a region where the land will carry trees or nothing, and she seems to be taking advantage of it.—Exchange.

An Episcopal clergyman of Cincinnati was being shaved by a barber who was addicted to occasional sprees. The razor manipulator cut the parson's face quite considerably.

"You see, Jackson, that comes from taking too much drink," said the man of God.

"Yes, sah," replied Jackson; "it makes de skin very tendah, sah. It do for a fact."—Saxby's Magazine.

I read your great magazine from cover to cover every month and greatly enjoy it. You are doing a great and good work, and make 10 friends where you make one enemy. Keep at them; we will stand by you.

Fred F. Bradley, Toledo, O.

Your magazine is the best I have ever read.

F. H. Best, Milwaukee, Wis.

PURE AND IMPURE FOODS.

"What a Man Eats He Is."

Edited by C. F. LANGWORTHY, PH.D.

Author of "On Citraconic, Itaconic and Meseaconic Acids," "Fish as Food," etc.

SUGAR IN THE DIET.

From reliable statistics it appears that well-to-do families in this country consume about 2 pounds of sugar per person per week. It would seem that this amount, or about one-fourth of a pound daily, taken as it is in connection with other foods, is not too much. Regarding larger quantities there is some question. The use of sugar would seem to be limited in 2 ways: By the fact that sugar may be absorbed more rapidly than it can be assimilated, and may thus overload the system, bringing on indigestion, or overtaxing the excretory organs; and by the ill effects on the system of concentrated solutions of sugar.

Sugar, like starch, is fattening; that is, when taken in excess it may be transformed into fat and stored as reserve material. On this account physicians advise that sugar be sparingly used by the corpulent. It is frequently claimed, and apparently with good reason, that sugar is of great value as a food for the production of muscular work, and therefore should form an important part of the diet of soldiers on the march and others engaged in severe work. This may justify the high regard in which sugar and syrup are held in cowboy camps, and indeed by all who rough it in the open air for business, pleasure or sport. No camp dish is more popular than flapjacks and syrup. According to present knowledge, the value of sugar as a food for muscular work may be summarized as follows:

When the organism is adapted to the digestion of starch, and there is sufficient time for its utilization, sugar has no advantage over starch as a food for muscular work except as a preventive of fatigue. In small quantities and in not too concentrated form, sugar will take the place, practically speaking, weight for weight, of starch as a food for muscular work, barring the difference in energy and in time required to digest them, sugar having here the advantage. It furnishes the needed carbohydrate material to organisms that have as yet little or no power to digest starch. Thus, milk sugar is part of the natural food of the infant. In times of great exertion or exhausting labor, the rapidity with which sugar is assimilated gives it certain advantages over starch. This latter quality, which renders it more rapidly available for muscle force, may, perhaps, account for the fact that sugar is

so relished by people who are doing muscular work and by those of active habits, as children.

In general, the wholesomeness of sweetened foods and their utilization by the system is largely a question of quantity and concentration. For instance, a simple pudding flavored with sugar rather than heavily sweetened is considered easy of digestion, but when more sugar is used, with the addition of eggs and fat, we have, as the result, highly concentrated forms of food which can be utilized by the system only in moderate quantities and which should always be forbidden to children and invalids.

It is true that the harvester, the lumberman, the hunter and others who do hard work in the open air, consume, apparently with impunity, great quantities of food containing much sugar, such as pie, doughnuts, hot cakes with sirup, etc.; but it is equally true that people living an indoor life find that undue quantities of pie, cake, or pudding, with highly sweetened preserved fruit, and much sugar on cooked cereals, bring indigestion sooner or later.

Sugar is a useful and valuable food. It must, however, be remembered that it is a concentrated food and therefore should be eaten in moderate quantities. Further, like other concentrated foods, sugar seems best fitted for assimilation by the body when supplied with other materials which dilute it or give it the necessary bulk.

Persons of active habit and good digestion will add sugar to their food almost at pleasure without inconvenience; while those of sedentary life, of delicate digestion, or of a tendency to corpulency would do better to use sugar moderately. It is generally assumed that 4 or 5 ounces of sugar a day is as much as it is well for the average adult to eat under ordinary conditions.

Most of the bad effects ascribed to sugar are due to its use in larger quantities than the 3 or 4 ounces a day, which seem to be digested by the healthy adult without difficulty, if it is not presented in indigestible forms. There is no proof that sugar is harmful to the teeth, although doubtless sweet food, allowed to cling to the teeth after eating, rapidly ferments, and acids will be formed that may attack the teeth. This is equally true of starchy foods. It is said, however, that the negroes of the West Indies, who consume enormous quan-

titles of sugar, have the finest teeth in the world.

It is also unproved that sugar produces gout. Sugar seems ill-adapted to the sick, except when used in small quantities as a flavor. It is believed that in sickness the stomach is inactive, and has less than its normal absorptive power, and that sugar on this account is less well borne than in health. The action of sugar in stimulating a flow of the digestive juices may in such a case be only irritating in its effect.

HOME COOKED VERSUS PURCHASED FOOD.

A number of experiments were carried on under the auspices of the Boston branch of the Association of Collegiate Alumnae, to determine whether palatable meals could be bought and sent home, ready cooked, and to compare the cost of such a diet with the same articles cooked at home. The menu was varied, as it was found possible to buy from restaurants, shops, the New England Kitchen, etc., cooked meats, soups, pastry, salads, etc., in addition to the bread and other goods commonly sold by bakers. These foods, with the addition of fruit, furnished a palatable diet.

In the first test, made with a family of 10 persons, the food cooked outside the home cost 25.6 cents per person per meal, including cost of fuel and labor. Prepared at home, the same diet cost 16.5 cents per person per meal. In the second test, in which the family averaged 15 students, the food, bought ready cooked, cost 19.5 cents per person per meal; that prepared at home 15 cents. In other words, the food prepared at home was much the cheaper. On the other hand, the saving in time by the purchase of cooked food was great, $4\frac{1}{2}$ hours, in the first experiment, being required to prepare the cooked food for the table, as compared with $32\frac{1}{2}$ hours required to cook the same food in the house. In the second experiment the valuations were 11 hours and $41\frac{1}{2}$ hours respectively.

In a report of these investigations it was stated that it was a decided surprise to the family to find that the food cooked outside of the house was so good. The meats in particular were well cooked. Although they had to be reheated they were not dried or toughened. The soups, too, were extremely good. Tea and coffee and a few other things were much better when made at home; but while admitting that the articles from outside were good, the majority of the family preferred the home cooking.

The experiments proved that a varied menu of good quality can be provided for a large family from food prepared outside the house; that the expense is greater when the food is bought outside; and that

there is a great saving in time and labor by the purchase of food outside.

"In general, may we not conclude," the investigators say, "that it might be possible to do away with all cooking in the house when the increase in expense is counterbalanced by the saving of time and labor? In small families especially, where the cost of the food is greater in proportion than in large families, the meals might be entirely cooked outside, making it possible in a small house or in an apartment to dispense with a maid. Again, to buy a food cooked might give the mistress time to do more profitable work. In a small family the exact amount required could be bought. This would save much of the waste, both in buying and serving, which seems unavoidable when the small quantities needed are cooked at home.

"The choice of foods ready cooked must necessarily be limited. Since in the present development of the industry the food must be cooked a considerable time before it is served, and must usually be reheated if it is to be served hot, all the dishes which spoil by standing or which depend on immediate serving for their peculiar delicacy are debarred. Thus such things as cheese dishes, soufflés, cooked eggs, and certain other dishes would only be good freshly made at home. These might all be made with a simple cooking equipment, such as a small oil or gas stove, or even a chafing dish. If a maid is kept it would require no expense for labor to have her do such simple cooking as the preparation of these few dishes; or the housekeeper herself could do it, with little outlay in time and energy."

HOMEMADE CHEESES WITH FOREIGN NAMES.

Many who pride themselves on their gastronomic taste speak scornfully of American cheeses, but in perhaps 9 cases out of 10 they eat and praise as an excellent example of the foreign product a cheese that never crossed the Atlantic. Camembert and Brie, according to a recent writer, are the only soft cheeses which are imported in any considerable quantity, and even they are sometimes manufactured in the United States. It is conceded that American-made Camembert and Brie are not so good as the foreign article, but the cheesemakers of New York and New Jersey have come at length to produce admirable Roquefort and good imitations, if they may be so called, of many other famous foreign cheeses. At the Wisconsin Experiment Station much attention has always been paid to cheesemaking, and the various problems connected with the industry. The station has studied the manufacture of Edam cheese and can produce a

cheese little if at all inferior to that of Dutch manufacture. French cheesemakers, with the conservatism characteristic of rural Europeans, have neglected to adapt their products to the American market, and the Brie cheese from abroad, for example, comes in a large disk, which makes it inconvenient for use and expensive for all except those who consume it in large quantities, whereas the American Brie is made in small cakes, of a size convenient for family use. The sale of Gorgonzola cheese, which is still imported, is much less than it would be if this cheese were made in smaller sizes.

Only 2 or 3 English cheeses are now imported in large quantities, and the so-called English dairy cheese is a native American product. Meanwhile, enormous quantities of American cheese are exported to Great Britain. Some English cheesemakers, following the lead of Americans, perhaps, put up their products in jars. The sale of cheese in small jars and small packages has grown to be a great industry in the United States, for the cheese thus prepared is convenient and extremely palatable.

According to the writer referred to, German and Swiss cheeses, Limberger, for instance, are imitated here, though less successfully than some others. The American made Neufchâtel is a satisfactory product, and is eaten in large quantities. As to Italian cheeses, they are made without any pretense of concealment wherever there is a considerable Italian quarter, though the imitations are not liked by the Italians themselves, and cheap Italian cheeses are imported in great quantities. Parmesan is a great favorite with the Italians, since it is cheap and useful in various ways.

According to local tradition, the earliest maker of alleged foreign cream cheeses in the region about New York was a Frenchman, whose first customers were a few fashionable restaurateurs. He produced, in small quantities, almost perfect imitations of French cheeses, and delivered them to his customers himself. The manufacture of these cheeses has now so extended that many grocers make no effort to keep a stock of foreign cheeses, and probably the larger portion of the cheese consumed, even in the French restaurants serving table d'hôte, which perhaps more than any other one factor established the fashion of cheese eating, is of native manufacture. As yet, however, the conservatism of the commercial world seems to make it necessary to stick to old names and foreign labels.

NOT A PREVENTIVE OF TYPHOID.

Much has been written lately regarding lemon juice as an agent for destroying the

bacilli which cause typhoid fever, the discussion having grown out of the results of experiments carried on by a prominent London physician. Later experiments made in this country seemed to substantiate the London physician's claim that lemon juice in the proportion of one teaspoonful in about 4 ounces of water infested with typhoid, is sufficient to destroy the vitality of the germs, and thus to prevent typhoid fever. Later experiments made at the Department of Health of New York City, however, are not so satisfactory. In these tests microscopic examinations were made of cultures of typhoid bacilli which had been subjected to the action of lemon juice and it was found that although the acid would kill the microorganisms, it required too much acid and too long a time for the chemical action to take place to render lemon juice a practical agent for their destruction. This negative opinion in regard to the efficiency "of the acid as a typhoid prophylactic was corroborated; for after the bacilli had been acted on by a 5 per cent. solution of the acid for 30 minutes it was found that all of them had not been destroyed. The culture that had been subjected to a 1 per cent. solution showed in 30 minutes one-fifth as many colonies as the untreated culture, while in the case of the one-tenth of 1 per cent. solution there were half as many colonies at the end of half an hour as there had been in the original untreated mixture. Motile bacilli in small numbers were still visible in a drop of the 5 per cent. solution, after 30 minutes' treatment. It is far safer to boil the water or filter it properly than to trust to lemon juice to destroy any typhoid bacilli that may be in it. Of course, the statement that the acid would destroy any typhoid germs that might be contained in oysters, by sprinkling it on the outside, is ridiculous."

Many believe that the addition of some whisky or other spirits to drinking water will kill typhoid bacilli, but it is doubtful if such a method is of much real value. The matter of pure drinking water is worth the attention of all who go to the country for the summer. Water may be of good appearance, odor and taste, and yet be dangerous to health. Therefore, only that should be used which is above suspicion. If there is any doubt, the water should be boiled, a proceeding which removes the danger.

"Lapland is a strange and remarkable country," said the eminent explorer. "The customs of the people are extremely odd, especially during courtship."

"How is that?" we ask.

"At that time every girl sits on her own Lapp.—Exchange.

BOOK NOTICES

ANOTHER NEW FORESTRY BOOK.

"A First Book of Forestry," by Filibert Roth, Chief of the Division of Forestry, U. S. Department of the Interior, is, as its title would indicate, elementary, being intended primarily for study in public schools and country homes. It does not pretend to be a text-book or manual, its aim being "to present in simple, non-technical language some of the principles underlying the science, and to state the methods which are employed and the objects to be attained in the practice of forestry."

The reader is taken, in imagination, into the forest itself, and the relation thereto of light and shade, soils and moisture, heat and cold, are explained. In the second part, the author discusses the different methods of raising or keeping up the forest, of protecting it from its various enemies, and the utilization of forest products. A short discussion is given of what may be accomplished in the administration of farmers' wood-lots, of waste and prairie lands, and in the reclamation of sand dunes. Under "Related Topics," the forest as a protective cover is described, the character and distribution of American forests are outlined, wood is discussed as to its structural, physical and chemical properties, and a serviceable key for the distinction of our common trees is given. The appendix contains the Doyle-Scribner log scale, a table of circles, and a descriptive list of the more important woods and trees of the United States.

There are many old men and women who when asked for the name of the capital of some State will stop and sing, to themselves, the old geography song they learned in their school days, which ran, "State of Maine, Augusta is on the Kennebec river," etc.; and it is difficult for almost any of us to tell straight off the reel what the capital of any State is without calling to our aid this old song.

This method of memorizing rhymes, or idioms, or proverbs, has been practiced by educators for hundreds of years, and probably always will be used to a greater or less extent.

In harmony with this old custom, Capt. H. C. DuVal has written a series of rhymes embodying the rules governing bridge whist, which may be memorized by any person in a single evening. This will enable any bridge whist player to carry the rules of the game on his finger-tips, so to speak.

The book is published by the Pafraets Book Co., Troy, N. Y., and sells at 25 cents a copy. It may be obtained through any large bookseller in the country.

"Horses Nine" is the name under which a collection of Mr. Sewell Ford's stories appears in book form. These stories have previously been published in Scribner's and other magazines, and readers who have already become acquainted with Skipper, Calico, Chieftan, Pasha and other equine heroes will be delighted to have their life histories in permanent form. The stories are somewhat unequal in value, but Mr. Ford has great power of making life felt from the horse's point of view, and of creating sympathy and affection for the dear, dumb creatures, which know no why nor wherefore, but simply obey and trust, often to their own undoing.

"Horses Nine" should rank as a gift book for boys and girls, and as a power for good, with "Black Beauty," which of course it far exceeds in literary quality. It is published by Charles Scribner's Sons, New York, and the price is \$1.50.

"A Virginia Girl in the Civil War" is a charming book, more fascinating and far more valuable than any of the hundred and one hysterical novels and alleged romances, founded on that period, with which the book market has lately been flooded. It is a record of the actual experiences of the wife of a confederate officer, yet it contains no word of blame or bitterness for the North. The delightful life in the old South before the war, and the suffering endured by Southern women during the great struggle are depicted from the standpoint of a gentle, sweet girl who lived both lives yet who can tell the story without rancour.

The book is edited by Myrta L. Avary, who says in her introduction that the history was told her over the teacups, during the evenings of a winter spent in the South. The publishers are D. Appleton & Co., New York.

"Gaston Griffith, a Country Banker," by G. W. Ames, is apparently a life history, on the diary plan. It is published by the Gazette Publishing Co., Port Jervis, N. Y., and is in 2 volumes, the second one illustrated from photographs. The work is unique and must be seen to be appreciated; yet I could live comfortably many years without seeing another such book.

Can not keep house without RECREATION.
L. F. Chapman, Gould City, Mich.

RECREATION is all right. Go for the swine. C. O. Jones, Mt. Union, Iowa.

PUBLISHER'S NOTES.

GOOD FISHING ON THE ERIE.

"Only an idle little stream,
Whose amber waters softly gleam,
Where I may wade, through woodland shade,
And cast the fly, and loaf, and dream:

"Only a trout or two, to dart
From foaming pools, and try my art:
No more I'm wishing—old fashioned fishing,
And just a day on Nature's heart."
—*Van Dyke.*

These charming verses appear on the opening page of the Erie Railway Company's new fishing book. Then follow 100 pages of delightful essays on the gentle art, beautiful pictures of the Delaware, the Susquehanna, the Shinglekill, the Ten-Mile, the Ramapo, the Navesink, the Wallkill, and of Chautauqua, Kenoza, Greenwood, Morris, Glenmere and other picturesque lakes reached by the Erie.

The book also contains as usual a list of the various stations on the Erie system near which good fishing may be had, together with detailed information as to round trip fares, guides' wages, livery rates, and other things that a sportsman always wants to know. In the back part of the book may be found a synopsis of the fish laws of New York, Pennsylvania and New Jersey. Altogether the new Erie fishing book is one of the handsomest and best that has yet been issued by any railway line. Every angler in the East, and every one in the West who intends to come East, should have a copy of this book. In writing for it please mention RECREATION.

PARKER BROS.' NEW EJECTOR.

Parker Brothers, Meriden, Conn., makers of the world renowned Parker gun, known as the "Old Reliable," have been working on an automatic ejector, and have finally perfected and patented one that they believe will be a worthy attachment for the Old Reliable. This company has been slow in adopting this feature, but the fact that they have brought out a device which they think has enough merit to be applied to the Old Reliable is good evidence that the user will get value received.

Parker Bros. are applying the automatic ejector to their high grade guns only, \$150, \$200, \$300 and \$400 models, at \$25 list extra. On account of the demand for Parker guns without ejectors these people can not furnish the lower grades of guns with ejectors at present.

It is said by experts that the Parker automatic ejector works easily and perfectly and that no one would know, from the working of the gun, that it contains any

additional working parts. It performs its duty to perfection.

BEN, THE LIFE STORY OF A CUB.

One of the most delightful and interesting bear stories ever written will be printed in July RECREATION. It narrates the experiences, trials, tribulations, cunning tricks and traits of a cub that was captured when 2 weeks old; that traveled with a hunting party in the mountains all summer, and that was then taken to the home of his new master, in a Western town, where he grew up as a member of the family.

The story has been elaborately and strikingly illustrated by R. F. Outcalt, author and illustrator of the "Little Mose" stories, which have delighted thousands of people during the last 2 or 3 years.

Tell your friends about this story of Ben and advise them not to miss it, for it will prove really the greatest treat that has ever appeared in RECREATION, or in any other magazine.

N. W. Ayer & Sons, 308 Chestnut street, Philadelphia, have sent out their newspaper directory for 1903, and it is indeed a great work. It contains a carefully prepared list of newspapers and periodicals published in the United States, Territories, and Dominion of Canada, with valuable information regarding their circulation, issue, date of establishment, political or other distinctive features, names of editors and publishers and street addresses in cities of 50,000 inhabitants and upward, together with the population of the counties and places in which the papers are published, and a great fund of other information of value to all business men and students. The book sells at \$5 a copy, and is well worth the price. In ordering please mention RECREATION.

The Savage Arms Co., Utica, N. Y., has issued its 1903 catalogue, which is fully up to the high standard of the Savage people in the matter of text and illustrations. The Savage rifle is pictured in all its various models, and the working parts are also shown, life size, on a separate page. There are 3 pages devoted to rifle sights, 3 to cartridges, one to re-loading tools, and several to general information.

The new 22 caliber rifle is illustrated and described, and this announcement alone will create a great demand for this catalogue. When you write for the book, please mention RECREATION.

EDITOR'S CORNER.

MONEY WASTED ON BILLBOARDS.

Millions of dollars are being absolutely wasted every year by American advertisers in disfiguring the country along railway lines with hideous announcements of their wares. I always note the effect of these glaring, staring, bill boards on passengers whenever I travel, and rarely hear any one speak of them except in terms of contempt. I have heard many a man, and many a woman, say they would never buy any article the name of which was flaunted in their faces in so repulsive a manner, and when they were trying to enjoy the scenery along the way.

Another channel through which millions of dollars are being squandered is in street car advertising. For 10 years past I have been watching the effect of such advertisements on the people who ride up and down the streets of New York, and I can count on my fingers the number of people I have ever seen reading or looking at any of the show cards, strung so persistently above the car windows. The people seem to have learned long ago that a determined effort is being made here to force them to read about soap, food, patent medicines, tooth powders, or something else equally tiresome. The men and women of New York are too bright and too busy to allow advertisers to rub stuff into them in any such way; so they read their papers, or look out of the windows, or look at the people across the aisle; and the advertisers are wasting their money.

On the other hand, watch every man and woman you see on a car with a newspaper, or a magazine, in his or her hand. In 9 cases out of 10 you will find the women reading the advertisements, and in a goodly percentage of cases the men scan them carefully, too.

Yes, of course, I am interested in stating these facts. I have advertising space to sell, and space that is worth the price charged for it. I have been in the publishing business 30 years, and have always made a careful study of the various methods of advertising resorted to by the commercial world. I have watched its effect on the advertisers. I know what kinds of advertising pay and what kinds fail. I hate to see good money wasted, even though it belongs to some other fellow, and the sooner the Sozodont people, the Castoria people, the Cresoline people, and a hundred others, tear down their insulting bill boards along the railways, and take in their signs from the street cars, the sooner will they gain the good will of the people, whose good will they are now driving away.

OREGON SETS GAME LAW PACE.

The Legislature of Oregon has passed a most remarkable game law. It provides among other things that all the sheriffs, deputy sheriffs and constables in that State shall be ex-officio game, fish and forest wardens, and shall have power to search persons suspected of having game taken in violation of law. It is made the duty of such officers to prosecute all suspected persons when notice of such suspicion is filed with the officer by a citizen, giving the name and address of the offender and the names and addresses of witnesses. Such officers are empowered to make arrests without warrants and on Sundays. They may also, without warrant, search any boat, vehicle, fish box, fish bag, game bag or game coat in cases where the officer believes game may be concealed; and such officer may seize any game which he believes to have been taken in violation of law. Such officers are exempt by law from action for damages on account of any such search or seizure. The law further provides that each such officer shall have concurrent jurisdiction throughout his own county; that each such officer shall, during the first week of each term of the circuit court of his county, make special returns to said court, under oath, of all violations of the fish or game laws occurring in his county or district or which may be brought to his notice; and that it shall be the duty of the Judge of said court to see that such returns are faithfully made. Any sheriff, deputy sheriff, constable, or game warden neglecting or refusing to make such report or to prosecute any violation of the game, fish or forestry law of which he shall have had personal knowledge, or of which he shall have had notice in writing as provided for, shall be deemed guilty of a misdemeanor, and on conviction shall be fined \$50 or imprisoned in the county jail 2 months, either or both, at the discretion of the court. One-third of the fine collected in each case shall go to the officer securing the conviction.

This is one of the most drastic and at the same time practical and useful laws ever enacted by any State. Pennsylvania has a similar provision in her game, fish and forestry laws, but it is not so sweeping nor so comprehensive as this Oregon law is. It will be well for all other States in the Union to follow the pace set by Oregon in this direction.

SHUT OUT THE TRAPPERS.

The Wyoming Legislature has before it an excellent game bill, and among its pro-

visions is one prohibiting the trapping of bears or other animals, except in the open season for hunting elk and other big game. It would be well for all the Western States to incorporate this feature in their game laws. The average trapper is a scourge and a curse to any game country. He goes into the mountains whenever he feels like it, stays as long as he likes, and while there kills anything and everything that comes in sight. He can use almost any bird or mammal, from a chipmunk to a moose, for food, for bait, or in his skin traffic.

Most men who call themselves bear trappers, trap all kinds of fur-bearing animals, large and small, that can be induced to go into their traps. For the purpose of baiting their smaller traps they kill small mammals and birds. For their bear traps they kill elk, deer, and moose, if they can find them, and without regard to numbers or to seasons. I know 2 notorious old trappers in Montana, who have boasted of having killed 30 elk out of one band, and have said that all the carcasses lay on 5 acres of ground. These bear trappers usually kill their big bait in midwinter when the snow is deep, and when the moose, elk, and deer huddle into the canyons. It is then a simple matter to kill every such animal, without stalking.

I talked with a trapper in British Columbia, in May last, and he told me of having caught a female beaver a few days before, from which he had taken 4 unborn kittens. He said he used these in baiting his marten traps. He was killing every porcupine, red squirrel, grouse, or other living thing he could find; and that was in the breeding season.

All States should enact laws prohibiting the carrying of traps or guns into the woods or the mountains in close season, and should attach heavy prison penalties for violations thereof.

FULLERTON MAKES ANOTHER GREAT RAID.

While the annual meeting of the L. A. S. was in session in St. Paul, February 11, Hon. Samuel Fullerton, the Minnesota State Game and Fish Warden, was called to the telephone and informed that C. J. Ertz, a commission man in that city, had 900 ruffed grouse and 15 saddles of venison stored in his dwelling house. Of course Fullerton called 2 or 3 of his associates and promptly raided the house. He found the game there as stated, took possession of it, placed it in cold storage, and locked the dealer in the county jail to cool. The penalty to which the commission man is subject in this case is a fine of \$90,000, and if he be unable to pay it he is liable to be sent to jail for 90 years. The Minnesota courts are in the habit of giving game law

violators what they deserve, and we may confidently expect that this man will get a good big dose of justice.

Smith Eastman, a farmer of Spartansburg, Pa., has been killing game and smuggling it out of the State for a year or 2 past. A game warden finally captured a barrel which Eastman had delivered at the freight office for shipment to some other State, and which was alleged to contain apples. On opening the barrel it was found to contain 210 ruffed grouse. A warrant was issued for Eastman's arrest, but he skipped before the officer found him and is supposed to have gone West. He will probably be at his old tricks somewhere in Wisconsin, Michigan or some other Western State in the near future. If any reader of RECREATION locates him, I should like to know of it, in order that we may arrange to have him watched.

Another competitive slaughtering match was conducted in Butler, Pa., in November last. The 2 herds of game hogs were led respectively by Sam Morris and Ed. Seaton. One side scored 1,625 points and the other 1,640 points. From this we may safely assume that large numbers of innocent birds and animals were butchered and no doubt many of these were not game. The disreputable brutes who participate in these side hunts usually kill and count such birds as flickers, woodpeckers, blue jays, meadow larks, and such animals as chipmunks and red squirrels. It is strange that the decent people of these Eastern States will allow the forests to be depopulated by such infamous processes as the side hunt.

Charles and James Lucket, 448 State street, Brooklyn, Antonio and Frank Musolino, 48 Mott street and James Williams and C. Heathner, New York, have been shooting song birds in New Jersey in violation of the State law. Two New Jersey game wardens laid for these butchers at the depot at Jersey City and captured them. They were taken before Justice Frank O'Keefe, of Jersey City, and were fined \$40 each. Justice O'Keefe is all right and I hope that if any other bird slaughterers are taken before him he may make it hot for them.

State Game and Fish Commissioner Thomas, of Vermont, has collected and compiled statistics from the various counties in that State as to the number of deer killed during the open season. He reports the total number as 370.

RECREATION is the only pebble on the beach known as sportsmen's literature.

John J. Tateum, St. Louis, Mo.

Schlitz



THE BEER
THAT MADE
MILWAUKEE
FAMOUS

More and More People are Demanding Pure Beer

During 1902 the sales of Schlitz Beer exceeded the year before by 132,916 barrels. That's the largest increase shown by any brewery in the world.

This Year We Want You

We will give you a beer made from the best materials grown.

We will brew it in absolute cleanliness.

We will get our water from six wells, bored to rock.

We will filter all the air that touches it.

We will age it for months so it cannot cause biliousness.

We will sterilize every bottle after it is sealed.

We will double, in these ways, the necessary cost of our brewing. Yet Schlitz Beer shall cost you just what the common beer costs. Will you try it?

Ask for the Brewery Bottling.

A DEER HUNT AND A CAPTURED DEER.

ELLWOOD.

My bachelor companion and I were sitting in our little country shanty, discussing the actions of the weather and the progress of our summer's work. A cold wind from the Northwest, with occasional scuds of rain, had caused us to come in from the field earlier than usual. We had then tinkered around at odd jobs about the house and stable.

Will had given the horses their evening feed and bedding. I, being cook and shanty keeper, had cleared the table and we sat before the fire, for the chill was very noticeable after a warm day.

Listening to the rushing wind and the rain against the window and on the roof we felt a sense of security, though a tornado might at any moment demolish our rude dwelling.

"What a fine evening for duck shooting," suddenly remarked Will, looking out toward the pond.

"Yes," said I, "but what good is it going to do us without the ducks? The only game in this vicinity are one or 2 small flocks of snipe, which neither of us would shoot."

"None," responded Will, "but it reminds me of a similar evening years ago, when the ducks and geese were first becoming scarce. Though we lived in a section of country where there was good shooting, we were not satisfied with such game as prairie chickens and rabbits, so as the deer season drew near we planned to go to the woods for a few days and try deer hunting.

"We were to go across country, with an outfit suitable for a party twice the size of ours.

"The first day all went well, but on the second we had a breakdown, so we covered only 12 or 15 miles.

"Camping time found us on a narrow ridge between a lake and a grassy slough.

"During the early part of the night the sound of whistling wings passing near us so aroused us that we could hardly stay in bed.

"When about to hitch up in the morning we were surprised and disappointed to find one of our horses acting much like a boy who has eaten dried apples that have not digested. As it became apparent that something serious affected our horse, we decided to postpone our start and return him to the farmer's stable.

"We were in haste to reach the deer country, but did not mourn long, for we were camped at a good duck pass.

"We all wanted to hunt during our lay-over, but some one must doctor the sick horse. Finally we drew cuts, which gave this position to my chum, Eugene.

"The others tramped around all day, returning to the pass for the evening flight.

"About supper time a brisk wind came up from the Northwest, with occasional spits

of cold rain, but we thought only of the ducks, for the flight was fine. There were teals, pintails, canvasbacks and redheads.

"There were not shot guns enough to go around, so some of us would watch for incoming ducks and laugh at the amusing misses of the others, then in turn try our skill. We got more real fun out of that evening's shooting than if each had a gun. We had secured enough ducks for ourselves and the farmer.

"We were up early next morning to see our horse, and were disappointed to find him showing the same symptoms as before.

"We were compelled to repeat the program of the day before or else do nothing. When the question who should remain with the horse came up we were surprised to have Eugene offer to take the place again, remarking perhaps it would be best to have the same individual act as horse doctor throughout the case. We were puzzled over his display of willingness, but soon left him for another day of hunting, with the understanding that if the brute should recover Eugene was to signal us with shots from a rifle. There were no signal shots fired, however. During the evening we got more pass shooting, but had not such a flight as before.

"The continued illness of the beast forced us to remain there so long that we felt compelled to give up our trip into the woods, 150 miles distant.

"Eugene, however, expressed no regret. This indifference brought forth some pointed remarks about the attractive farmer's daughter, a handsome miss of 18 or 20.

"On the last evening, after supper, as we were gathering around our camp fire, Eugene strolled off toward the farmer's. The evening passed quickly and some time after we had gone to bed we heard Eugene returning down the path, singing gaily.

"Next day we started for home, going by the way of a goose-feeding ground of which we had learned. We got a few of these great birds and some fine sport.

"Thus ended our deer hunt, without having reached the deer country. Eugene, however, has since declared it the best deer hunt he ever had, for within a few months the farmer's daughter became Mrs. Eugene

The Davenport ejector gun for 12 subscribers to RECREATION arrived promptly. From all standpoints it is a fine piece of workmanship. I thank you heartily for your prompt response, and wish you continued success.

Frank R. Evans, Kansas City, Mo.

"Yes," concluded the medical raconteur, "she became insane through excessive dancing."

"One might say she was hopping mad, I suppose," gurgled the Cheerful Idiot.—
Baltimore American.

THE EQUITABLE

HENRY B. HYDE
FOUNDER

J. W. ALEXANDER
PRESIDENT



J. H. HYDE
VICE PRESIDENT

SITUATION WANTED—By elderly man who has held responsible position. Will do any honest work which will enable him to support himself. Address Box 99, this office.

IF
IN THE
SPRINGTIME

of life, men would provide for its winter time, such advertisements as the above would never appear. An adequate Endowment policy in the Equitable will provide for a man's own mature years—and meanwhile protect his family.

Vacancies in every State for men of energy and character to act as representatives.
Apply to GAGE E. TARBELL, 2ND Vice President

SEND COUPON BELOW OR WRITE FOR PARTICULARS.

THE EQUITABLE LIFE ASSURANCE SOCIETY OF THE UNITED STATES

120 BROADWAY, NEW YORK.

Dept. No. 16.

Please send me information regarding an Endowment for

\$..... issued to a man or woman years of age.

Name

Address.....



AMATEUR PHOTOGRAPHY.

"For sport the lens is better than the gun."

I wish to make this department of the utmost use to amateurs. I shall, therefore, be glad to answer any questions and to print any items sent me by practical amateurs relating to their experience in photography.

8th ANNUAL COMPETITION.

RECREATION has conducted 7 amateur photographic competitions, all of which have been eminently successful. The 8th opened April 1st, 1903, and will close November 30th, 1903.

Following is a list of prizes to be awarded:

First prize: A Long Focus Korona Camera, 5 x 7, made by the Gundlach Optical Co., Rochester, N. Y., fitted with a Turner-Reich Anastigmat Lens, and listed at \$85.

Second prize: A No. 3 Folding Pocket Kodak, made by the Eastman Kodak Co., Rochester, N. Y., fitted with a Bausch & Lomb Lens, Plastigmat Unicum Shutter, and listed at \$61.50.

Third prize: An Al-Vista-Panoramic Camera, made by the Multiscope and Film Co., Burlington, Wis., and listed at \$40.

Fourth prize: A Royal Anastigmat Lens, 4 x 5, made by the Rochester Lens Co., Rochester, N. Y.; listed at \$36.

Fifth prize: A Waterproof Wall Tent, 12 x 16, made by Abercrombie & Fitch, New York, and listed at \$32.

Sixth prize: A No. 3 Focusing Weno Hawkeye Camera, made by the Blair Camera Co., Rochester, N. Y., and listed at \$27.50.

Seventh prize: A high grade Fishing Reel, made by W. H. Talbot, Nevada, Mo., and listed at \$20.

Eighth prize: A Tourist Hawkeye Camera, 4 x 5, and made by the Blair Camera Co., Rochester, N. Y., and listed at \$15.

Ninth prize: A Bristol Steel Fishing Rod, made by the Horton Mfg. Co., Bristol, Conn., and listed at \$8.

Tenth prize: A pair of High Grade Skates, made by Barney and Berry, Springfield, Mass., and listed at \$6.

The 10 next best pictures will each be awarded one dozen 8 x 10 Carbutt Plates, made by the Carbutt Dry Plate Co., Wayne Junction, Philadelphia, Pa.

The 10 next best pictures will each be awarded one dozen 5 x 7 Carbutt Plates.

The 10 next best pictures will each be awarded one dozen 4 x 5 Carbutt Plates.

A special prize: A Goerz Binocular Field Glass, listed at \$74.25, will be given for the best picture of a live wild animal.

Subjects are limited to wild animals, birds, fishes, camp scenes, and to figures or groups of persons, or animals, representing in a truthful manner shooting, fishing, amateur photography, bicycling, sailing or other form of outdoor or indoor sport or recreation. Awards to be made by 3 judges, none of whom shall be competitors.

Conditions: Contestants must submit 2 mounted prints, either silver, bromide, platinum or carbon, of each subject, which, as well as the negative, shall become the property of RECREATION. Negatives not to be sent unless called for.

In submitting pictures, please write simply your full name and address on the back

of each, and number such prints as you may send, 1, 2, 3, etc. Then in a letter addressed Photographic Editor, RECREATION, say, for instance:

No. 1 is entitled — — —.

Made with a — — — camera.

— — — lens.

On a — — — plate.

Printed on — — — paper.

Length of exposure, — — —.

Then add any further information you may deem of interest to the judges, or to other amateur photographers. Same as to Nos. 2, 3, etc.

This is necessary in order to save postage. In all cases where more than the name and address of the sender and serial number of picture are written on the back of prints I am required to pay letter postage here. I have paid as high as \$2.50 on a single package of a dozen pictures, in addition to that prepaid by the sender, on account of too much writing on the prints.

Any number of subjects may be submitted.

Pictures that may have been published elsewhere, or that may have been entered in any other competition, not available. No entry fee charged.

Don't let people who pose for you look at the camera. Occupy them in some other way. Many otherwise fine pictures have failed to win in the former competitions because the makers did not heed this warning.

PRIZE WINNERS IN THIS ISSUE.

I took the photograph "We Want Our Mudder" on a showery day, between clouds, with the sun shining, at about 2.30 p. m., May 17, 1902, on Christina lake, British Columbia, 35 miles North of Republic, Washington, my friend Elmer Ness climbing the stump. The photograph was made with a Premo Senior camera, Bausch & Lomb lens, and printed on platinum paper. Length of exposure, 1-5 of a second.

At the time Mother Bear was shot we did not dream of her having young, otherwise we would have refrained from shooting and allowed the mother to go on in completion of her office of mothering her little cubs. I could not help shedding tears when we found the little innocent cubs, alas now motherless, perched on the topmost part of the decayed tree, crying like babies for their mother. The killing of the old mother we can not boast of as sportsmanlike, but it may be classed by certain of our Western hunters as clean hunting. Murder can never be considered by true sportsmen one of the fine arts, and we apologize to Coquina for the unintentional, unwarranted act in this instance, lest he give us the usual roast, through RECREA-

TION, that he administers to game and fish hogs generally.

The mother bear was shot and killed by Elmer Ness, of Cascade, B. C., on the lake shore a few rods above where the little cubs were perched when the photograph was taken. To have presented the mother, dead, lying at the base of the old tree, might have shed truthful light on the legitimacy of the picture-subject; yet had I placed her there my reputation as a ruthless killer might have been considerably heightened in the estimation of your numerous readers of RECREATION, and for that reason I am thankful the old mother is not shown.

G. E. Strobridge, Republic, Washington.
This photo is reproduced on page 336.—Ed.

The fact that the blue heron of which I send you photo had been wounded just sufficiently to make him sick enabled me to secure the picture. He was so sick that he did not have any interest in things mundane, or care whether the stream ran thick with sticklebacks or juicy trout minnows. His thoughts were with his forefathers, and centered on the last long flight which he was about to take to join the crane majority on the other shore of the vast sea which even cranes must cross. He was not so sick, however, but that he could stand in a natural position and look contented and happy while his "pictur was took." In all my experience, which is considerable, I never before saw a heron wounded just to such an exact point. The bird was left standing on the log seen in the picture, and was afterward captured by a farmer, who kept it some time. I am unable to say whether it recovered from the wound. No taxidermist ever saw the bird, and he was certainly alive and able to walk when the picture was taken, but he could not fly. The left wing was damaged.

I remain, yours sincerely,
W. H. Thurston, Flesherton, Ont.
This photo is reproduced on page 345.—Ed.

Herewith I mail you 2 prints of a wild hummingbird, to enter in your 7th yearly photographic competition. While in the Stonewall country trout fishing, I discovered the bird on its nest, and the next day I took my camera to the place. The nest was in a cottonwood tree, which leaned over the stream, so I had to remove a number of leaves and small twigs to get a clear view. I did that without frightening the bird from the nest.

I found it necessary to use a telephoto lens in order to get the image large enough, which of course lengthened the exposure. Then the bird being in a rather shady place, and moving all the time, made it necessary for me to take my chances on the exposure;

also to wait about 1/2 hour. When finally I reflected sunlight on to the bird it dazzled him long enough to make the exposure. I consider myself lucky to possess a negative of a hummingbird.

The negative was made with a Century Grand camera, back combination lens. Exposure about 27/8 seconds.

Morey Jamison, Trinidad, Colo.
This photo is reproduced on page 339.—Ed.

The photo entitled "Still Life" was made with an Eastman No. 4 cartridge kodak, Bausch & Lomb rapid rectilinear lens, and printed on special rough Velox paper. The exposure was 30 seconds, 128 stop.

W. T. Adderley, Spokane, Wash.
This photo is reproduced on page 340.—Ed.

The photograph of the young screech owls was made with a Goerz lens fitted to a Premo camera, and printed on Velox paper.

Walter W. Savery, Brooklyn, N. Y.
Reproduced on page 360.—Ed.

The photograph entitled "Almost in Reach" was made with a Wizard camera, rapid rectilinear lens.

R. H. Beebe, Arcade, N. Y.
Reproduced on page 353.—Ed.

SNAP SHOTS.

Will you inform me through RECREATION whether or not pyro developer gives good results after it has colored? The formula I use is:

Pyro 1 ounce
Sodium sulphite 1 ounce
Sulphuric acid 5 drops
Water 16 ounces

It becomes a wine color and from that to a black. Will the light affect it? I keep it in a large, clear bottle.

O. Denny, Martinsburg, Ind.

ANSWER.

All developers are greedy for oxygen, and care must be taken to keep them from light, heat and air. Pyro developer if not fresh will stain plates. If it will develop it is all right. This must be tried.

In making up pyro use oxalic acid instead of sulphuric, 15 grains to each ounce of pyro. Dissolve oxalic first, then add the pyro and the solution will remain clear for months. Use boiled water. The process of boiling expels air from water, and the oxalic acid, being greedy for oxygen, removes the rest, leaving none to deoxydize the pyro.—EDITOR.

Kindly inform me through your valuable magazine how to remedy the following difficulties:

Having made exposure with glass side

of plate to lens, I get, as you are aware, a picture backward. How can I make a reversed negative from it? Would I have to make a positive plate and then make negative from that?

How can I keep the thin film from peeling off the surface of metalotype paper? It gets soft in washing.

Y. J. Belfoy, Ottawa, Ont.

ANSWER.

Yes, to get a reversed negative from your first one, make a positive and then make a negative from that, as you suggest.

To prevent films from peeling paper use cold washing water, or a weak bath of alum after fixing, or place in weak solution of formalin.—EDITOR.

The question of how long a dry plate will remain good between exposure and development, which is answered in a recent issue of RECREATION, calls to mind a conversation on that subject which I had about 3 years ago with a man who was one of the pioneer dry plate makers and sold to some of New York's best known photographers the first dry plates they ever used. He claimed he had made a test of the staying quality of his plate by making an exposure on his daughter and allowing the plate to remain undeveloped 12 years, at the end of which time he developed it and obtained a good picture. This statement is perfectly safe in my hands, for I shall never have the patience either to verify or disprove it.

G. B. Cardwell, Brooklyn, N. Y.

I have tried several times, carefully, the formula published in RECREATION to make blue print paper. It looks right before printing, but when put to wash all disappears. The time exposed seems to make no difference. What is the trouble?

O. O. Colby, Big Fork, Mont.

ANSWER.

The 2 solutions should be kept in separate, dark colored bottles, secure from light and air. Mix a few minutes before use and apply with brush or otherwise. Allow to dry. This paper will not keep long, according to weather; sometimes only 3 or 4 days. You probably use a poor quality of paper. Try a good drawing paper like Helios.—EDITOR.

When one has a negative in which there is a good cloudy sky, which requires more exposure than the trees, etc., it is a good plan to proceed in the following manner, says an exchange: Expose on velox or other paper in the ordinary manner. For

development, start by applying the solution to the part containing the clouds, and as soon as they show signs of appearing, immerse the whole print in the solution. Such procedure does not give a line of demarcation between the sky and the landscape, because during the first part of the operation the paper will absorb the solution in such a manner as to graduate the limit.

Can you give me a formula for retouching varnish that contains ether?

E. O. Dean, Cortland, N. Y.

ANSWER.

Shellac0.035 ounce.
Sandarac0.21 ounce.
Mastic0.21 ounce.
Ether2.7 fluid drams.

Add 2.7 fluid drams of pure benzole to the mixture after the resins have dissolved in the ether.—EDITOR.

A clearing solution to remove yellow stain caused by developer is made as follows:

Sulphate of iron..... 3 ounces.
Sulphuric acid..... 1 ounce.
Alum 1 ounce.
Water 20 ounces.

Wash well to remove all hypo from negative, then immerse in the solution until the stain is removed; again wash well and dry.—Exchange.

I have been a regular reader of RECREATION 2 years. It is great. I take much interest in your photographic department and especially in the prize winners you publish. I am an amateur and have a collection of views taken with a Poco C. 4 x 5. I should like to exchange views with any one who has anything of interest.

Clayton Lyttle, Harrisburg, Pa.

The suggestion by L. Goodrich is good, and I should be delighted to join a RECREATION camera club. We could, if necessary, have several clubs, so there could be meetings and excursions in different States. There are not many amateurs here, but I think there soon will be. I, for one, will help all I can.

Charles Metz, Sheridan, Wyo.

I notice in looking through your department of amateur photography that Mr. C. Steckman, of Minerva, Ohio, has trouble with rust spots on his negatives. Let him try a weak solution of perchloride of iron and soak his negatives until the spots disappear.

O. Denny, Martinsburg, Ind.

IF IT ISN'T AN EASTMAN, IT ISN'T A KODAK.

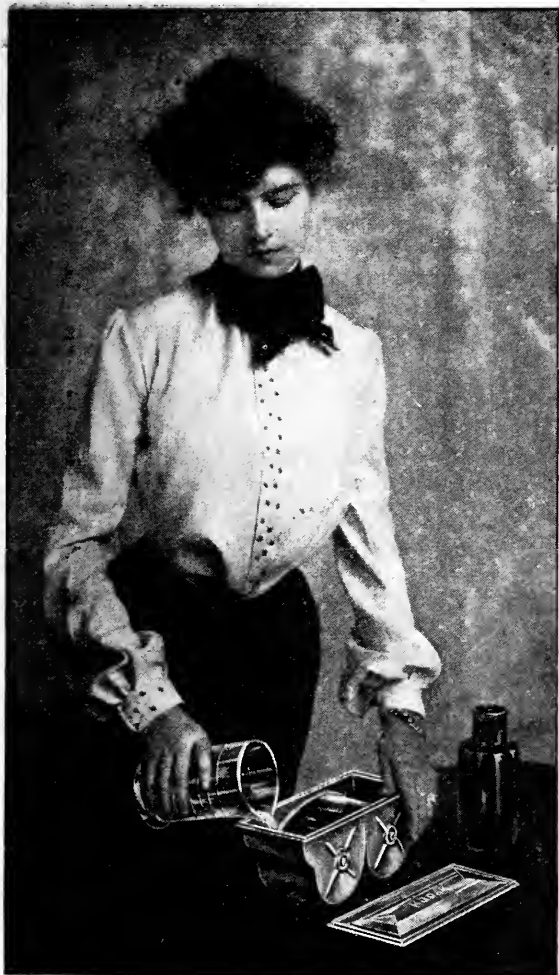

There are no stained fingers in the Kodak way of picture making.

The Kodak
Correspondence
School
helps the amateur

make technically perfect and artistic photographs. Explains all the little difficulties—there are no big ones. Individual criticism is given to the work of each pupil. Tuition, free to all owners of Kodak and Brownie Cameras upon payment of one dollar for text books.

Circular free at any dealer's, or by mail.

Kodak Catalogues,
Kodak Baby Book,
Kodak Portfolio, } *Free at the dealer's, or by mail.*
containing 40 prize winning pictures,
ten cents, at the dealer's, or by mail.

KODAK Simplicity

is not confined to the camera. Every step in daylight, and as plain as daylight, by the Kodak System.

Anyone can do the developing, now that the

Kodak Developing Machine

has abolished the dark-room. Better results than the old way, too.

Kodaks, \$5.00, \$75.00

**Brownie Cameras,
\$1.00, \$2.00**

**Kodak Developing Machines,
\$2.00 to \$10.00**

EASTMAN KODAK Co.

ROCHESTER, N. Y.

Great gain in utility; no loss in convenience.

Folding Weno Hawk-Eye with Special Equipment

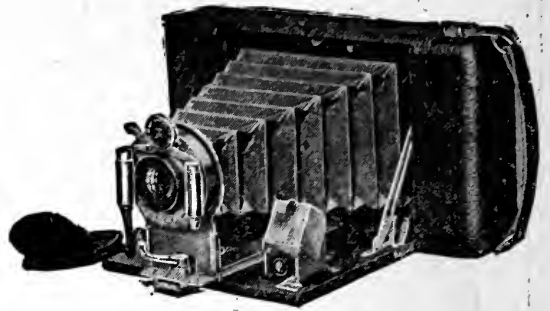

A superb camera for amateur or even professional use. Latest features include long focus double extra rapid rectilinear lens, extension bed, rising and falling front.

Folding Wenos are pocket cameras using either Perforated Daylight Loading or Cartridge Film. They have two tripod sockets and reversible brilliant finder. Can be fitted with glass plate attachment.

- | | |
|--|---------|
| No. 3 Special Folding Weno Hawk-Eye with Extension Bed, Rising and Falling Front, Extra R. R. Lens, and B. & L. Automatic Shutter (pictures, 3¼ x 4¼), | \$22.50 |
| No. 4 Folding Weno Hawk-Eye, with Extension Bed, Rising and Falling Front, Extra R. R. Lens and B. & L. Automatic Shutter (pictures 4 x 5), | 27.50 |

BLAIR CAMERA CO.

Rochester, N. Y.

Write for
Hawk-Eye Booklet.

Hawk-Eye film is prepared for Development in the Kodak Developing Machine.

OIL PORTRAITS ON APPROVAL.

If you will send me a photo of yourself or a friend and state color of hair, eyes and complexion I will paint and send you on approval a miniature oil or pastel portrait.

- | | |
|-------------------------------|---------|
| Canvas 6x8 or 8x10 inches, | \$10.00 |
| Canvas 10x12 or 12x14 inches, | \$15.00 |

Z. EMMONS, 58 West 104th St., New York.

Reference: Mr. G. O. Shields.

LANTERN SLIDES COLORED IN AN ARTISTIC MANNER

Special attention given to the wants of Amateur Photographers. Correspondence promptly attended to. I refer by permission to the Editor of RECREATION.

MRS. BUTTLES SMITH,
606 W. 115th Street, New York City.

NEGA-TONE.

(Trade-mark)

Tone your Negatives.	Bring out all Detail.
Bring out the depth.	Bring out the Distance.
Have Natural Pictures.	Stop losing Negatives.

TONE THEM. TONE THEM.

Trial Package by mail 25c.

A. B. LEGNARD (Sole Manufacturer),
Waukegan, Ill.

During my 30 years of rifle experience I have used many makes of magazine rifles, and found none so accurate, at either short or long range, as the single shot Ballard, Winchester and Stevens. I do not believe there is a magazine gun made that will not prove faulty at times. The Savage is the nearest perfect. I owned a Marlin 22, '97 model, for some time. It shot well, but always clogged in the action at the most inopportune moment. When I pumped the lever, 2 cartridges would appear in the receiver. Then I had to disassemble the arm to clear the carrier. All this was unpleasant, and the game got away. I sold that Marlin rifle for much less than I gave for it. I have a Marlin shot gun that occasionally jams in the action. Recently I wrote the makers about the defect and inquired how to remedy it. They have not seen fit to answer. Had I written them for a new gun I would have received an answer in 4 days. I have nothing against this firm, but think, in justice to their patrons, they ought to treat them with some degree of courtesy. They should at least be willing to remedy a defect in the mechanism of their arms. Their obstinacy does not make them friends, but in the end will be their loss. Former patrons will go elsewhere to supply their needs and to that extent the Marlin business will decrease.

Wm. Henry, Jr., Shelbyville, Ill.

The Greatest Photographic Year Book Free

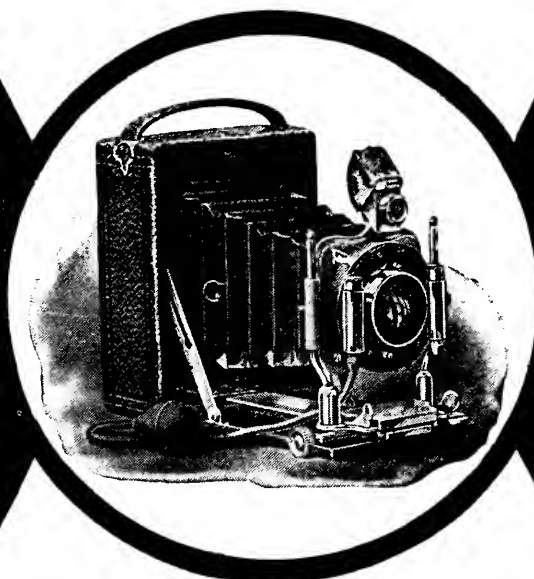

As the Premo is recognized as the best of all cameras, so is the Premo Book recognized as the authority on the best things photographic. It practically describes and accurately illustrates all the requisites to successful photography including The

PREMO

a name that covers a series of cameras, so wide in their range; so complete in their individual equipment, as to practically solve every problem of the photographer's art. Made in all styles and sizes. Ranging in price from \$2.50 to \$350. Ask your dealer for the Premo Book, or send your name and secure it **free** by mail

DEPARTMENT 974 ROCHESTER OPTICAL CO., Rochester, N. Y.

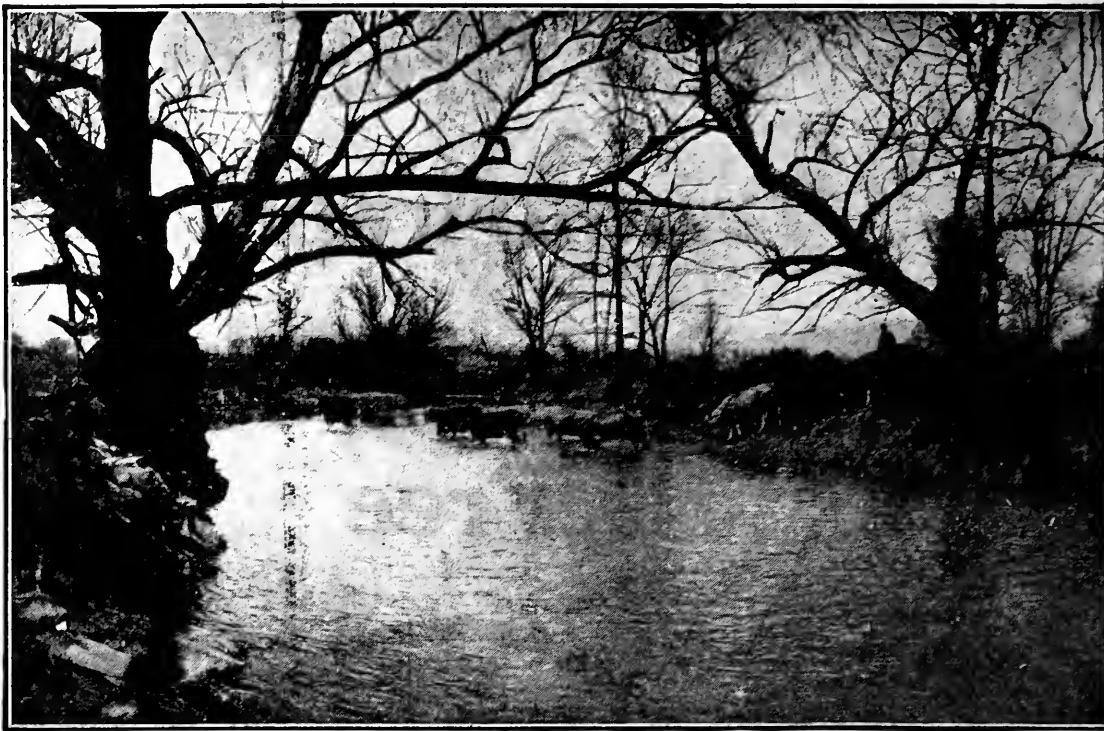

All in one picture, by the

take photos 4 x 5 or almost any size you wish. Some of our models combine the use of both films and plates. You can take a film picture 4 x 12 or a plate photograph 4 x 5, or 5 x 7, as you wish. With no other camera can you do this.

In every city in the country there are amateurs and professionals who are enthusiastic about these

Al-Vista Cameras.

If you will write us we will give you the names of persons who are using the Al-Vista, and who like it.

Of course it is impossible to tell you much about our Camera in this announcement. We want you to write us, and we will mail full information.

Multiscope & Film Co.

136 Jefferson St., Burlington, Wis.



Al-Vista Camera, or you can

A most valuable feature of the Al Vista is the simplicity of operation. There is nothing complicated about the Camera—nothing likely to get out of order. The lens used is of extra quality, the best we can secure. It is universal focus, so that no time is required in focussing.

Our Co-operative Plan

We are sending out now a large number of cameras on this Co-operative Plan. A small first payment being made, we ship you the camera, and you can use it while you pay the remainder in monthly installments. This plan appeals to a great many people and certainly shows our confidence in the quality of our goods. Write us for full information about it.

Multiscope & Film Co.

136 Jefferson St., Burlington, Wis.

Are You an
Amateur
Photographer?



If so would you like a Camera
that will photograph

A whole range of mountains
A whole sweep of river
A whole army
A whole fleet of ships
A whole city

Or any other vast stretch of scenery or moving
objects? THE SWING LENS DOES IT

The **Al Vista**

Is the thing. It lists at \$30.

One of the greatest inventions of the age.
Given as a premium for 12 subscriptions,

For particulars Address

RECREATION

23 West 24th Street

NEW YORK CITY

OPENING SALE AT NEHRING'S

16 East 42d Street, New York

Having just added an extensive Mail Order Department to my present business, I desire to call your attention to a few bargains and offers contained in my catalogue.

CAMERAS I will exchange your old camera for a new 1903 model. You can have a Kodak, Century, Premo, Korona or any other make. Send your camera to me at once. State purchase price and if in reasonable condition I will most certainly allow you more than you anticipate. I handle all makes of Kodaks and Cameras at lowest prices.

LENSES I will exchange your Rectilinear Lens and Shutter for a high grade F. 6.8 Double Anastigmat in Volute Shutter. I will allow \$20.00 for a 4x5 Rectilinear Lens and Shutter, \$25.00 for a 5x7. \$30.00 for a 6½ x 8½, and \$40.00 for an 8 x 10. This gives you the goods at about one half of regular catalogue prices.

FOCAL PLANE SHUTTERS I have imported a lot of Focal Plane Shutters, leading make. Just as an opening offer, 4 x 5 regular price \$22.00 for \$7.00, 5 x 7 size regular price \$27.00 for \$10.00.

4x5 and 5x7 Extreme Wide Angle Anastigmats to fit your shutter, regular price \$20.00 for \$6.00.

4x5 and 5x7 High Power Tele-Photo Lenses with rack and pinion for fine focusing, magnification from 2 to 8 times, regular price \$9.00 for \$4.00.

4x5 and 5x7 Portrait Anastigmats to fit cells of your Camera Shutter, regular price \$20.00 for \$7.00.

DOUBLE PLATE HOLDERS 4x5 size regular price \$1.00 for 35 cents.
5x7 size regular price \$1.25 for 45 cents.

DARK ROOM LAMPS 35 cents value candle lamp for 5 cents.
\$1.00 value oil lamp for 49 cents.

\$6.00 Imitation Carbutt Lamp for \$1.48.

TRIPODS \$10.00 value Twistlock, metal Telescopic, small light for \$3.75.

\$1.00 style, sliding wooden for 49 cents.

\$2.50 style, sliding and folding for 99c. \$3.50 style, sliding and folding heavy for \$2.00.

CARD MOUNTS Latest styles and designs, all sizes up to 6½x8½ for 50 cents per hundred.

ZINC WASH AND HYPO BOXES 4x5 and 5x7 Ideal Zinc Wash Boxes \$1.25 value for 49 cents.

6½x8½ Ideal Zinc Wash Boxes \$1.75 value for 79 cents. 8x10 Ideal Zinc Wash Boxes \$2.50 value for \$1.35. 4x5 and 5x7 Hypo Boxes \$1.00 value for 39 cents.

BACK GROUNDS 5x6 feet, latest designs \$1.25 value for 50 cents.

SUNDRIES \$2.00 Hand Burnisher for 50 cents. 6 inch Print Roller, 35c. value for 9 cents. 4x5 Printing Frames for 9 cents, 5x7 size for 12 cents.

4x5 Albums 8 cents, 5x7 for 9 cents, 6½x8½ for 12 cents, 8x10 for 16 cents. 15 cents value M. Q. Tubes for 5 cents. 4x5 St. Louis Dry Plates for 32 cents, 5x7 size for 55 cents, 6½x8½ for 85 cents. Rubber Bulb and Tube for 15 cents. 4x5 Electrose Trays 8 cents, 5x7 13 cents, 6½x8½ 28 cents, 8x10 32 cents. Negative Racks 8 cents.

No larger and more complete Stock anywhere. Send for Catalogue.

SPECIAL NOTICE *All of our customers receive monthly bulletins, quoting latest prices and bargains. Bargain lists will always be sent to customers one week before general distribution.*

It will pay you to be one of our customers.

U. NEHRING

16 East 42d Street,

NEW YORK

ANOTHER GREAT OFFER TO AMATEUR PHOTOGRAPHERS

A 4 X 5 SERIES 1 KORONA CAMERA
LISTED AT \$12, FOR 8 YEARLY SUBSCRIPTIONS TO *RECREATION*;

A 5 X 7 SERIES 1 KORONA CAMERA
LISTED AT \$16, FOR 12 YEARLY SUBSCRIPTIONS;

A 4 X 5 SERIES 2 KORONA CAMERA
LISTED AT \$18, FOR 14 YEARLY SUBSCRIPTIONS;

A 4 X 5 SERIES 3 KORONA CAMERA
LISTED AT \$22, FOR 18 YEARLY SUBSCRIPTIONS;

A 4 X 5 SERIES 4 KORONA CAMERA
LISTED AT \$25, FOR 20 YEARLY SUBSCRIPTIONS;

A 4 X 5 SERIES 5 KORONA CAMERA
LISTED AT \$35, FOR 30 YEARLY SUBSCRIPTIONS.

*SAMPLE COPIES, FOR USE IN CANVASSING,
FURNISHED FREE.*

A D D R E S S

R E C R E A T I O N

23 WEST 24TH STREET, NEW YORK CITY

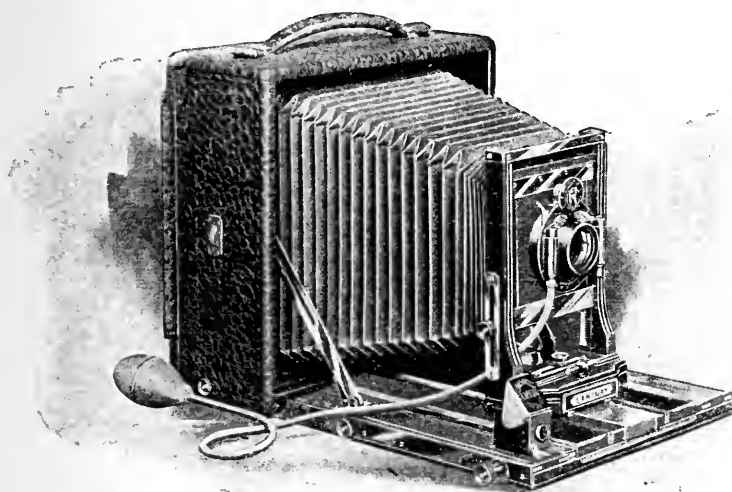

"If I had at command any other words that stood for more than these — *absolute perfection* — I would use them to convey my opinion of the Century Camera received to-day."

"Century" Cameras

Are the recognized standard cameras of America. Our 1903 Catalogue tells all about them — how they differ from others, and why "Centurys" are so superior in quality. Get a copy from your dealer or write us, and don't overlook the "Century Guarantee." That tells our story in a nut shell.

CENTURY CAMERA CO.,

MAKERS OF THE FINEST CAMERAS
IN THE WORLD.

ROCHESTER, N. Y.

EASTMAN'S Kodoid Plates

ORTHOCHROMATIC
NON-HALATION

THE PERFECT SUBSTITUTE FOR GLASS

USED IN ORDINARY PLATE HOLDERS WITHOUT
KITS OR ADAPTERS.

KODOID PLATES consist of non-curling cut film, mounted by means of metal clips on a black cardboard. Before development they are handled precisely like glass plates. To develop, they are removed from cardboard by pulling off the clips, and are then developed in the usual manner.

Superb in Speed, Latitude and Chemical Quality.

Light—Convenient—Non-breakable.

KODOID PLATE PRICE LIST.

3¼ x 4¼, per dozen, . . . \$.45	4¾ x 6½, per dozen, . . . \$1.00
4 x 5, per dozen,65	5 x 7, per dozen, 1.10

SOLD BY ALL KODAK DEALERS.

EASTMAN KODAK CO.

ROCHESTER, N. Y.

Bausch & Lomb

Photographic

LENSES AND SHUTTERS

Sold 'Round the World

are made by the oldest and best equipped lens making establishment in America

Bausch & Lomb-Zeiss Anastigmats and Plastigmats with Volute Shutters

Are Regularly Furnished on All High Grade Cameras

When buying your camera this year see that it is equipped with one of our superb lenses, making it possible to do every kind of photography, and the best photography with one outfit. If your camera has a BAUSCH & LOMB lens or shutter you can compete for the

\$3,000.00 for Photographs

which is offered absolutely without reserve to users of our lenses and shutters. *Send for Booklet.* Catalog of Prism Field Glasses, Microscopes, Projection Lanterns on request.

Bausch & Lomb Optical Co., Rochester, N. Y.

NEW YORK
25th St. and Broadway

BOSTON
120 Boylston St.

CHICAGO
Wabash and Monroe Sts.

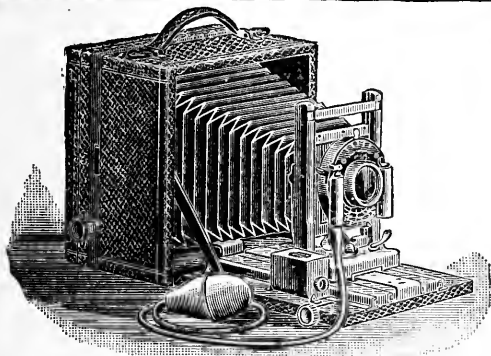
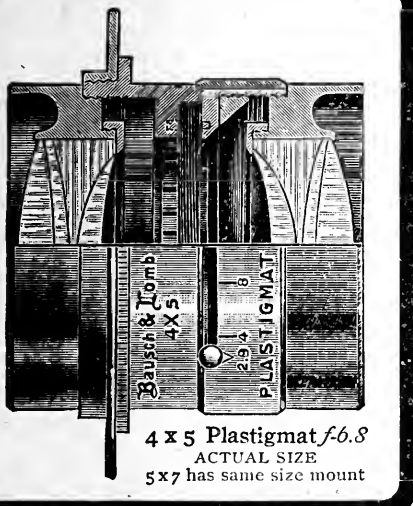

DO YOU KNOW THAT WE SAVE YOU MONEY on CAMERAS, LENSES and PHOTO SUPPLIES.

Pyrographic Materials and Outfits, Hammocks and Outing Goods Generally.

TO GIVE YOU an idea of our prices we quote while they last

100 4x5 CYCLE WIZARD A
double R. R. lens, carrying case, bulb, plate holder, shoulder strap, all complete for **\$5.75**

This is the best \$12.00 outfit ever offered by anyone.

Write To-day for our bargain list of Specialties.

NATIONAL SPECIALTY CO.

13 West 27th Street, New York City.

Something New!

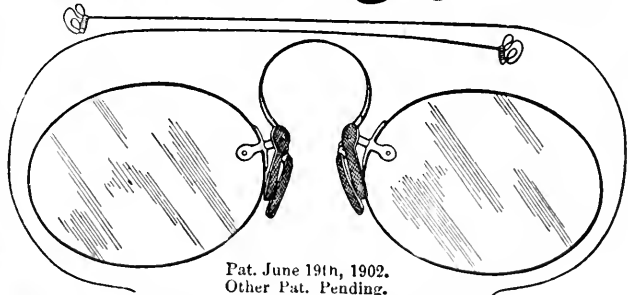

PRESTO! CHANGE!
Attachable Eyeglass Temples

Every wearer of eyeglasses wishes occasionally that they were spectacles. Spectacles stay on, however violent one's exercise, however warm or stormy the weather. This little device can be readily attached or detached without injury to the lenses, thus in a second giving you the choice of either spectacle or eyeglass. Just the thing for outdoor sports. The Temple Attachment will fit any of your eyeglasses and can be carried in the same case with them.

Send thickness of lens when ordering by mail.

Price in Nickel, 50 cents a pair

Price in Gilt, 75 cents a pair.

Send for Circular.

Our illustrated catalogue can be had for the asking

We carry everything in the Optical and Photographic line Eyeglasses, Spectacles, Cameras, Opera, Field or Marine Glasses, Thermometers, Barometers, Telescopes, Hygrometers, Sun-dials, etc.

GALL & LEMBKE, Department C.

1 W. 42d Street

21 Union Sq., New York

Established 1842.

Every
Lens Sold
Is a
Profitable
Ad
For Us

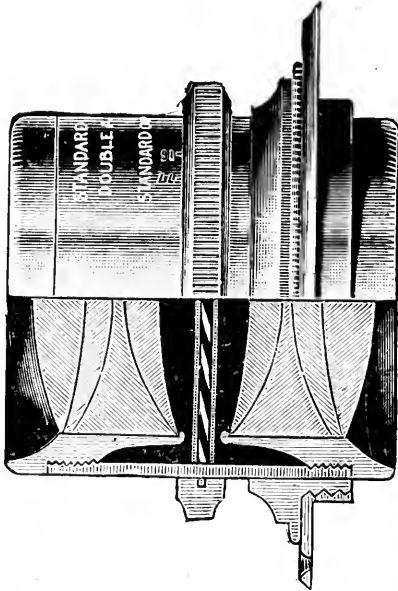

Increasing sales compelled us to enlarge our factory three times last year.

WHY?

If our lenses were no better than the imported ones selling at double the price you would save the 45% customs duty by buying from us.

But we sell you a better lens at half the price. That's why.

Send at once for a lens on ten days' trial and prove it for yourself.

THE STANDARD OPTICAL COMPANY
227-231 Mulberry St., Newark, N. J.

To Amateur Photographers

Here is a Chance to Get a
FINE CAMERA EASILY

A 4x5 Tourist Hawk-eye film camera listing at \$8, for 5 yearly subscriptions to RECREATION. A No. 3 folding Weno Hawk-eye film camera, listed at \$15, for 10 yearly subscriptions to RECREATION.

These are both neat, compact, well made and handsomely finished cameras, capable of doing high-class work. Only a limited number can be supplied on this offer, and same may be withdrawn at any time without notice when the present stock is exhausted.

Sample copies for use in canvassing furnished on application.

Address **RECREATION,**
23 West 24th St., New York City



My Brother on the opposite page makes all my negatives for me on **ANSCO**, the new **DAYLIGHT** loading film

You Ought to Try Them

They have Better Keeping Qualities and Greater Latitude than others.

If your dealer can not supply you, send to **THE GENERAL AGENTS.**

The Anthony and Scovill Co.

122-124 Fifth Ave.
New York

Atlas Block
Chicago



My Brother over there says there is nothing like **CYKO** when you want beautiful prints.

You can print it **ANYTIME** by **ANY LIGHT** and **ANY WHERE.**

Six Different Grades Adapted to All Sorts of Negatives.

Send twenty cents and get a dozen 4x5 with Developer and Manual.

The Anthony and Scovill Co.

122-124 Fifth Ave. Atlas Block
New York Chicago

Collinear Lens

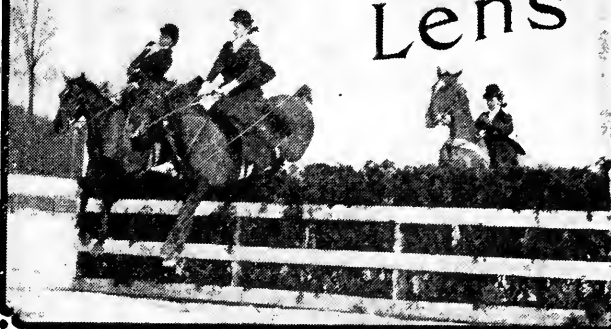

As Quick as the Eye

The **Collinear Lens** catches the passing picture as quick as the human eye, and with marvelous fidelity passes it on to the sensitive plate. Pictures that were impossible before the advent of the

Collinear Lens

are now considered the simple things of Photography. For speed, depth of focus, brilliancy, definition and latitude the **Collinear** is recognized as the premier lens. Have one fitted to your **Premo, Poco, Kodak, Century Weno, Corona, Graphic, Seneca** or **Reflex**.
Instructive Booklet Free.

Voigtlaender & Son Optical Co.

Dept. E 137 West 23rd Street
New York City

Your manner of calling to account people who slaughter fish and game is refreshing to any one who takes interest in game protection. I think you can not be too severe, and although you doubtless make enemies I am sure that many a man who has been censured severely by you has been made a convert to the right. Of course, there are lots of tough hided bristlebacks whose better feelings, if they have any, can not be touched.

In the Okanagan valley matters are improving, but in the past the slaughter was carried on remorselessly. Spring shooting is no longer permitted, and game will have a chance to increase. Deer are still plentiful back in the hills.

I sent to Charles Payne, of Wichita, Kansas, last spring and procured 5 dozen Bob White quails. For a long time after we turned them out we could not locate them, but we now often come across them in pairs. The English pheasants are doing splendidly, although the past season was not the best for hatching, being rather wet. We have hopes of a good showing in pheasants, quails and prairie chickens. The latter are the best game birds in the lot. A neighbor is raising golden pheasants with fair success. Okanagan soon will be teeming with choice game birds. The sportsmen around here are mostly men with no hog in their composition.

M. P. Empey, Keloma, B. C.



Oh Spring!
We Hail
To Thee

IN NAME—**ROYAL**—IN QUALITY

ARE

Royal Anastigmat Lenses

Once more Mother Earth has thrown off her mantle of snow and ice, and the lover of nature will take his camera and hie himself to the green fields, the babbling brooks and the budding forests, for views which are a delight to every photographic enthusiast.

If you are among this class, let us equip you with a **ROYAL** so that your work will prove true to nature, and your negatives have the depth and crispness of definition, which will make them worth the efforts expended.

A postal will bring you our catalogue.

Mention **RECREATION**.

ROCHESTER LENS CO.

ROCHESTER, N. Y.

Amateur Photographers!

Watch this space
next month

We Have It!

YOU GET IT

A new photographic paper

Special and attractive
offer to first enquirer
from any city or town.

ADDRESS AT ONCE

Matte Albumen Co.

156 Fifth Avenue
N. Y.

DO YOU WANT A LENS?

If so, why not get a good one?
And why not get it free of charge?
This is easy.

Any old box will answer the purpose if it does not leak light; but you must have a fine lens to make a fine picture.

You can get

**A Royal Anastigmat
Lens, 4 x 5, Series No. 1**

Made by the Rochester Lens Co., Rochester
New York,

**And listed at \$45,
For 40 yearly subscrip-
tions to RECREATION**

You can get any other lens made by this
Company on the basis of one subscription
to each dollar of the list price of the lens.

Sample copies of **RECREATION** for use in
soliciting furnished on application.



Taken with a TURNER-REICH in $\frac{1}{1000}$ of a second.

1903 Koronas

will combine in ingenuity of design, completeness of equipment, and perfection of workmanship and materials, the heritage of nineteen years' optical and mechanical experience.

Send for our new Catalogue—just from the press—read about KORONA CONSTRUCTION, and be convinced that the claim which we make for the superiority of KORONAS is justified by facts.

Your Choice
of Two
Anastigmats

The **TURNER-REICH**

and

VERASTIGMAT
(*True Stigmat.*)

That new Catalogue tells what an Anastigmat ought to be, and contains many illustrations which prove that the TURNER-REICH and the VERASTIGMAT are all that we claim



Gundlach-Manhattan Optical Co.

730 South Clinton Ave.,
ROCHESTER, N. Y.

THE DEER THAT KEPT ME GUESSING.

A. B. CLAYTON.

I wonder if any other of the readers of RECREATION have shot a deer or moose mortally and had him stand as if it never touched him. This was my experience last November in the North woods. Heretofore, during an experience of over 18 hunting seasons in the woods, whenever I have shot a deer through the lungs, broken his shoulder, perhaps, he would get away 100 yards or more before falling; if a moose the distance would be greater.

The only occasion on which I have stopped a deer short and had him drop where he stood, or in his tracks, was when the shot broke his neck. The experience I refer to at first mixed me up considerably; and when it was repeated the next day left me in a completely bewildered condition of mind, which still exists.

This is how it happened: The day was perfect for still hunting. The first snow fall of the season had commenced the night before and 2 inches of snow lay on the ground, with more falling. We had a late breakfast in camp, feeling sure of the favorable conditions continuing, and about a mile out picked up a fresh buck track and slowly worked it down. The ground was soft under the snow, and our moccasins broke no twigs as we walked.

Charlie, the guide, traveled behind. I was watching for deer, careless of direction. His work was to begin after we had killed, and were ready to find our way home. The big buck led us along the lake, then skirted the swamp and took away on to the ridges. He was running and jumping, enjoying the cold air. At last he settled down to a walk; we worked along more slowly, and as we broke into a clearing there stood the old fellow, on the other side, feeding. The wind was from him, so I knew I had time, and I quietly threw my 45-90 Winchester to my shoulder, loading as I did so. The click of the lever was just loud enough for him to hear, but not to locate. It brought his head up, his body broadside to me. I fired and he never budged. A grunt from Charlie, and I fired again. Four times I repeated this performance without any movement on the buck's part. He was like a statue. At the fifth shot he gave one bound and was out of sight in the woods. I looked at the sights on my rifle; they were all right. No explanation was offered by me or was requested by the guide; only speechless disgust prevailed. We started across to look for blood, or pick up the track, and there just inside the line of woods lay the big fellow; every one of the 5 shots had hit him, and any one of them would have killed him. I had simply wasted ammunition and allowed my faith in the old tried gun to vanish for the moment.

That evening we talked it over without enlightenment. That night it cleared, the temperature dropped nearly to zero, everything froze up tight. In the morning the sun rose brilliantly. It was a magnificent day to live in, but no day for still hunting. We started early, but soon found that, in spite of the 3 or 4 inches of snow, it was noisy under foot. There was no breeze, no dripping or falling of snow from the branches. We gave up the woods and took to the abandoned lumber roads and skidways. Twice deer jumped across the road, but I did not fire. At last, looking ahead, I saw a fair sized buck, a 3 year old, as he proved, feeding, standing just at a turn in the road 200 yards ahead. He stood quartering. My first shot apparently did no harm; my second was a repetition of the first, so far as appeared. "Let me kill that deer, he'll get away sure," whispered Charlie. "Go ahead!" said I, stepping aside. Charlie had an old 38; he fired and the deer dropped. Self congratulation on his part followed. I was evidently "it" and went sadly along with him to pick up the game. But the laugh was changed when we found my 2 shots had gone clean through the deer, penetrating both lungs; while Charlie's shot, easily identified by the small size of the bullet, had struck the hind leg just below the hock joint and between the bone and muscle. Charlie's shot would hardly have tickled the deer had he not been dead. But was he dead? Why did he not jump or fall down before? Who can explain it? All Charlie said was "Wouldn't it bump ye?"

I am using a black powder rifle, a 32-40 Winchester. Judging from letters in RECREATION, some hunters think that success in deer hunting depends entirely on the rifle, caliber, etc. When a deer is suddenly jumped at close range and goes bounding over the top of the hazel brush, your chance of getting him depends less on whether your rifle is a 30-30, a 45-70, or any other size, than on your aim. The reason so many misses are made is largely due to the fact that the hunter forgets to look at his sights, and watches the deer only.

I have used Peters' shells for both rifle and shot gun and have gone back to U. M. C. and Winchester. Peters' shells do not shoot strong enough for me. Am glad RECREATION does not advertise so poor an article. I have also used the Marlin rifle. Some Marlins shoot as well as any other gun, but when it comes to jamming, the Marlin beats them all.

I use a 12 gauge Winchester pump gun, and have one fault to find with it. Its recoil seems to jar the shell in the front end of the magazine enough to slightly mushroom the crimping and cause difficulty in forcing it into the chamber when shooting rapidly.

Erastus, Fosston, Minn.

Bracers

For

Topers



A Coffee Toper needs a bracer in the morning, a cup of coffee to steady him or her. Why?

Coffee is not so strong a stimulant as liquor, but is still an alkaloid stimulant, and so long as it is used, the nerves will go shaky and the bracers be needed, and disease of some sort will surely set in. The older one is, the harder it is to break away from coffee.

It is easy to quit the coffee habit by shifting to Postum—easy and wonderfully healthful.

Neither Brain nor Body can work properly when the nerves are shaky and the body sick.

The coffee lover can have his or her coffee and be well, happy and strong if that coffee is Postum.

There is a reason.

POSTUM

CEREAL FOOD COFFEE

The Densmore

Adopted as Official Typewriter

OF THE

World's Fair St. Louis



Our free booklet illustrates the Ball Bearings, Back Spacer, Paper Regulator, etc.

Densmore Typewriter Co. 309 Broadway
New York

Do you want a Good, Reliable,
Substantial, Well Made

Single Barrel Shot Gun

If so, send me

10 YEARLY SUBSCRIPTIONS

and I will send you such a
Gun as a premium

It is made by the *DAVENPORT ARMS CO.*, and this means it is made of good material and that only good workmanship is put on it.

This is one of the many remarkable opportunities *RECREATION* is offering to men and boys to fit themselves out completely for shooting and fishing.

Sample Copies for Use in Canvassing
Furnished on Application.

Address

RECREATION

23 W. 24th St., New York City

Sent on Approval

TO RESPONSIBLE PEOPLE

Laughlin

Fountain Pen

Guaranteed Finest

Grade 14k.

SOLID GOLD PEN.

To test the merits of

RECREATION

as an advertising medium we make this grand special offer, your choice of

These
Two
Popular
Styles
For Only **\$1.00**
Postpaid
to any
Address

(By Registered mail 8 cents extra)

Holder is made of finest quality hard rubber, in four simple parts, fitted with very highest grade, large size 14k, gold pen, any flexibility desired—in feeding device perfect.

Either Style—**RICHLY GOLD MOUNTED** for presentation purposes, \$1.00 extra.

Grand Special Offer

You may try the pen a week; if you do not find it as represented, fully as fine a value as you can secure for three times the price in any other makes, if not satisfactory in every respect, return it and we will promptly refund your money.

Illustration on left is full size of Ladies' style; on right, Gentlemen's style. Lay this **RECREATION** Down and Write **NOW**.

Safety Pocket Pen Holder sent free of charge with each Pen.

ADDRESS:

Laughlin Mfg. Co.

424 Griswold St., DETROIT, MICH.



Since Lincoln's Time,

more than 7,000,000 Jas. Boss Stiffened Gold Watch Cases have been sold. Many of the first ones are still giving satisfactory service, proving that the Jas. Boss Case will outwear the guarantee of 25 years. These cases are recognized as the standard by all jewelers, because they know from personal observation that they will perform as guaranteed and are the most serviceable of all watch cases.

JAS. BOSS

Stiffened GOLD Watch Cases

are made of two layers of solid gold with a layer of stiffening metal between, all welded together into one solid sheet. The gold permits of beautiful ornamentation. The stiffening metal gives strength. United they form the best watch case it is possible to make. Insist on having a Jas. Boss Case. You will know it by the Keystone trade-mark. Send for booklet.



THE KEYSTONE WATCH CASE COMPANY, Philadelphia.

Quails are scarce in this vicinity, and bags at no time exceed a dozen. In some sections, and especially on the Colorado river, they are numerous, but owing to the bushy nature of the country and the wildness of the birds, few good bags have been made. On the Colorado river pheasants are being propagated and many young have been seen this year. The country is ideal for this class of game birds, and it will be but a few years until they can be taken. We are protecting them as well as possible, but the Indians have been caught killing the old birds and peddling them in the towns of California. We have sent officers after them and they must either let the birds alone or be arrested for violating the game law.

Anson Smith, Kingman, Ariz.

IF YOU WOULD LIVE NEXT TO NATURE, READ RECREATION.

F. H., Carson City, Nev., says, "Ducks receive most attention and doves afford practice in the close season."

To this I wish to add: the Carson City Gun club, and many others who profess to be law abiding citizens, devote their attention to the grouse, old and young, and to quails.

At Marlette lake last fall the watchman, name Close, had quail and grouse feathers around his house and grouse cooking on his stove when called on; while in Ash Canyon, North and Swift's Canyons, Little Valley, Jacks Valley, etc., the game murderers' work could be heard going on from August 15 till the coming of the snow.

There are great numbers of doves. They come about April 15, leaving September 15. They are protected neither by law nor humanity. The hogs shoot the old birds when they come, while hatching and when they bring their young down from the hills.

Roast the game hogs!

F. B., Carson City, Nev.

A New Pattern to Delight Hunters and Whittlers.

Please study it.

It is an ideal knife to use and carry; no picture shows the finish. Price post-paid, \$1.00. Return at once if not fully pleased.

The lower cut is a Gentleman's Pen Knife, but will also cut a tent-pole or skin a rabbit.

It is our prize medal "Masterpiece," 3 blades; finest quality; price with ebony handle, \$1.25; Ivory, \$1.50; choicest Pearl, \$2.00.

Send for 80 page illustrated Free List and "How to Use a Razor."

MAHER & GROSH CO.

74 A Street Toledo, Ohio.

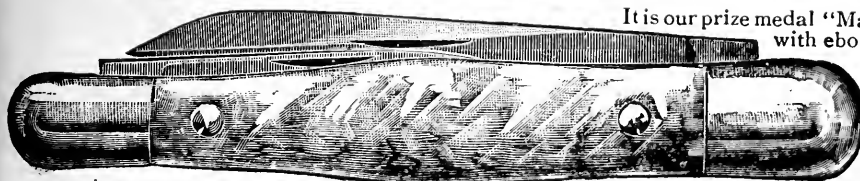
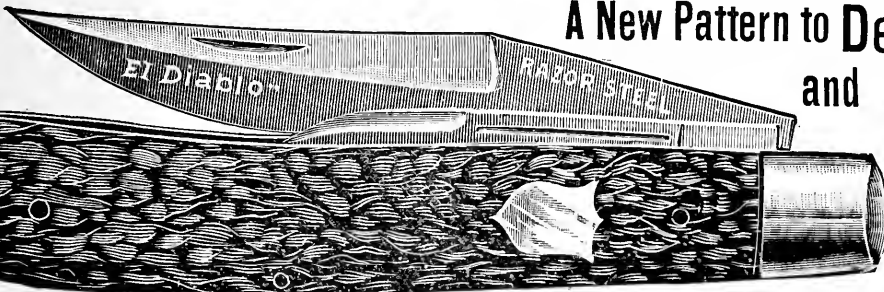



H. J. TILLOTSON, M. D.
The Master Specialist of Chicago, who Cures Varicocele,
Hydrocele, and treats patients personally.
Established 1880.
(COPYRIGHTED)

manent. My consultation will cost you nothing, and my charges for a perfect cure will be reasonable and not more than you will be willing to pay for the benefits conferred.

Certainty of Cure is what you want. I give a legal guaranty to cure or refund your money. What I have done for others I can do for you. I can cure you at home.

Correspondence Confidential. One personal visit at my office is preferred, but if it is impossible for you to call, write me your condition fully, and you will receive in plain envelope a scientific and honest opinion of your case, free of charge. **My home treatment is successful.** My books and lectures mailed free upon application.

H. J. TILLOTSON, M. D., 140 Tillotson Bldg, 84 Dearborn St., CHICAGO

Varicocele Hydrocele

**Cured to Stay Cured in 5 Days.
No Cutting or Pain. Guaranteed
Cure or Money Refunded.**

VARICOCELE. Under my treatment this insidious disease rapidly disappears. Pain ceases almost instantly. The stagnant blood is driven from the dilated veins and all soreness and swelling subsides. Every indication of Varicocele vanishes and in its stead comes the pleasure of perfect health. Many ailments are reflex, originating from other diseases. For instance, innumerable blood and nervous diseases result from poisonous taints in the system. Varicocele and Hydrocele, if neglected will undermine physical strength, depress the mental faculties, derange the nervous system, and ultimately produce complicated results. In treating diseases of men I always cure the effect as well as the cause. I desire that every person afflicted with these or allied diseases write me so I can explain my method of cure, which is safe and per-

LOOK AT THIS!!! If you send your subscription to RECREATION through me or direct to the office to be placed to my credit, I will send you free of charge any one of the articles mentioned below:

Shot gun bench crimper, sells for 75c., in 10-12-16-20 gauge.

Shot gun cleaning rod, 3 attachments, sells for 50c., in 10-12-16 gauge.

Micrometer powder and shot measure, adjustable, and for both black and smokeless powder; sells for 65c.

U. S. Government rifle cleaner, any caliber, with attachments, sells for 60c., packed in neat canvas bag.

A duck, or snipe, or turkey call, sells for 75c. each, best made.

Address Henry B. Floyd, 1365 Emerson St., N. E., Washington, D. C.

Do You Keep a Gun?

If so, would you not like a rack for it?

**Do you keep more
than one gun?**

If so, would you not like racks for all of them?

**For 5 yearly subscriptions to
RECREATION**

I will send you

a pair of buffalo horns

beautifully polished and mounted on nickel bases, which may be screwed on the wall.

A pair of these horns make a unique and convenient gun rack, and a valuable trophy of the grandest game animal America ever had.

These horns are easily worth
five dollars

a pair and sell readily at that price. I have been fortunate in securing a considerable number of them at a price that enables me to make this remarkable offer.

Send in your Club at once.

MENNEN'S BORATED TALCUM TOILET POWDER

TRADE MARK

A Positive Relief For PRICKLY HEAT, CHAFING, and SUNBURN, AND ALL AFFLICTIONS OF THE SKIN.

"A little higher in price, perhaps, than worthless substitutes, but a reason for it." Removes all odor of perspiration. Delightful after Shaving. Sold everywhere, or mailed on receipt of 25c. Get Mennen's (the original). Sample Free.

GERHARD MENNEN CO., Newark, N. J.

THE PELVIC NERVES

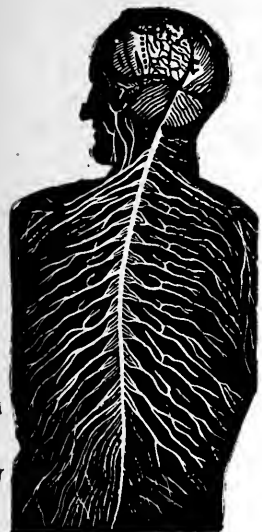

While nature has been particularly careful to protect most of the vital organs, the Heart, Lungs, Stomach and Liver, by bony cavities and hold them in place by strong muscles and tendons, the Pelvic Organs and the delicate nerves controlling them have comparatively little protection and support. To this anatomical weakness is due the susceptibility to derangement of the Pelvic Nerves.

The congested condition of the veins occasioned by Varicocele gives rise to the most serious disorders of the Pelvic Nerves and so interferes with the sympathetic nervous system that the vital functions of the Pelvic Organs are deranged. While in itself this functional disturbance is of sufficiently grave importance, the organic weakness presaged by its first insidious impairment of the faculties is a warning too grave to be ignored. Locomotor Ataxia, Paralysis and Nervous Prostration emanate from this same fatal and fertile source.

I have made the study of this branch of therapeutics my life's work and am limiting my practice to the cure of such cases. Through the advantages afforded by a large practice, I have originated a method of treatment which is practically without pain or serious inconvenience. The cure is positive and permanent. For the ordinary uncomplicated case five days is sufficient time to effect a cure when patients come to my Home or Sanitarium in Chicago, which is fitted with every appliance for successful treatment.

I cannot here enter into an academic discussion of this subject, but I will send to any man who feels that he is handicapped by conditions which may be traced to Varicocele, my treatise on the subject if he will write me truthfully regarding his condition. And whether he writes me or comes to me for consultation I will give without charge the benefit of my professional opinion and advice.



DELMER D. RICHARDSON, M. D., Suite 105, 119 Michigan Ave., Chicago

To RECREATION Readers: I am organizing a club of subscribers for RECREATION, with a view to securing a premium, and I submit this offer; to each person sending me \$1 for yearly subscription to RECREATION, I will send a 25c. Dominion of Canada bank note. There are but a few of these in circulation and I have succeeded in collecting a number of them. These are interesting souvenirs and are especially valuable to persons who are making collections of coins or other curios. Walter Legare, 518 John St., Quebec, Can.

Free: For 1 year's subscription of RECREATION, through me, will give 1 Bromide enlargement, any size up to 11 x 14 inches, inclusive, from any negative not larger than 4 x 5; or from photographs. Negatives and Photos are to be returned to the owner. Here is a rare chance to get a large Photo from your pet Negative, also RECREATION for \$1. A. F. Evarts, Meriden, Conn.

The Best Offer Yet.—To any person who will subscribe to RECREATION for one year through me I will send free a small water color landscape, hand painted, suitable for framing; or a hand painted silk bookmark. For two subscriptions I will send a fine Mexican opal scarf pin worth ordinarily from \$1 to \$1.50.

Don M. Harris, 308 Crawford Road,
Cleveland, Ohio.



Discoverer of This Magic Compound That
Grows Hair in a Single Night.

Trial Package Free

to convince people it actually grows hair, stops hair falling out, removes dandruff and quickly restores luxuriant growth to shining scalps, eyebrows and eyelashes and restores the hair to its natural color. Send your name and address to the Altenheim Medical Dispensary, 8707 Foso Building, Cincinnati, Ohio, for a free trial package, enclosing a 2-cent stamp to cover postage. Write to-day.

FREE **HAIR FOOD**



FALLING HAIR AND BALDNESS ABSOLUTELY CURED

There is but one way to tell the reason of baldness and falling hair, and that is by a microscopic examination of the hair itself. The particular disease with which your scalp is afflicted must be known before it can be intelligently treated. The use of dandruff cures and hair tonics, without knowing the specific cause of your disease, is like taking medicine without knowing what you are trying to cure. Send three fallen hairs from your combings, to Prof. J. H. Austin, the celebrated Bacteriologist, who will send you absolutely free a diagnosis of your case, a booklet on care of the hair and scalp, and a sample box of the remedy which he will prepare specially for you. Enclose 2c postage and write to-day.

PROF. J. H. AUSTIN
633 McVicker's Bldg., Chicago, Ill.

Pimples and Blackheads

A Home Remedy That Cures Pimples, Blackheads and Acne Quickly and Permanently, Has Been Perfected by a Distinguished Chemist.

Full Information Together With the Method is Mailed Free to All Who Write.

For years skin specialists and doctors have tried to produce a face lotion or wash, or skin food or some sort of a cosmetic or face lotion that would cover up or cure the pimples, but all failed. The Cincinnati chemist who has at last solved the problem states positively that after many years of experience in the special study and treatment of thousands of patients suffering severely from pimples, blackheads and acne he has found a scientific combination treatment that removes the pimples and eruptions, restores the skin soft and smooth and clean.



And he announces through the public press of the country that he will gladly give his method free to all sufferers who write. The readers of this paper may address the Dermal Institute, 165 Wex Building, Cincinnati, Ohio, with a certainty that their request will receive prompt attention as he is the head of that well-known institution and can be relied upon. The method, while based on the soundest medical principles, is so simple that any person can use it and cure themselves in their own home.

TALES OF ADVENTURE.

Rare Hunting and Fishing Stories.

I have a few sets of Volume 3 of RECREATION, July to December, inclusive, 1895. These are handsomely bound in cloth, with leather backs and corners.

Here are the titles of a few of the choice stories in the book.

- Woodcock on the Islands.**
Illustrated, F. W. G. Johnson
- The Gordon Setter.**
Illustrated, Dr. J. Whitaker
- Salmon Fishing in Labrador.**
Illustrated, Col. Charles E. Fuller
- Coursing with the Greyhound**
Illustrated, L. F. Bartels
- A Bald-Faced Grizzly in Camp.**
Illustrated, M. W. Miner
- Where Leaps the Ouananiche.**
(Poem.) Dr. E. L. Tiffany
- Fly Fishing** Dr. M. G. Ellzey
- A Half Hour With the Quail.**
Dr. E. P. Kremer (Juvenis)
- A Deer Drive with Spokane Indians.**
Illustrated, Lieut. W. R. Abercrombie
- An Indian Horse Race.**
Maj. F. M. Bernard
- The Old Kentucky Rifle.** (Poem.)
Illustrated, Capt. J. W. Crawford
- A Mystery of the Tetons.**
Illustrated, Ed. H. Trafton
- Pheasant Shooting.**
Illustrated, Thomas G. Farrell
- Sitting Bull's Last Medicine.**
Illustrated, Margaret Gray Brooks
- Crossing the Plains 30 Years Ago.**
Illustrated, Gen. John Gibbon, U. S. A.
- A Mountain Lion Hunt by Night.**
Illustrated, Robert Meade Smith, M.D.
- Trouting on Clark's Fork.**
Illustrated, Gen. F. W. Benteen, U. S. A.
- Ducking off Machipongo.**
Illustrated, W. J. Bogert
- A Youthful Guide and a Prize Bighorn.**
Illustrated, Hon. I. N. Hibbs
- A Wild Goose Chase.**
Illustrated, A. E. McKenzie
- A Tempestuous Cruise.**
Illustrated, Commodore Chas. Pryer
- Hans the Wolf Hunter.**
(Poem.) Illustrated, S. N. McAdoo
- How Some Women Went Shooting.**
Illustrated, Julia C. Welles

These books will be sold at \$2.00 each, and when the present supply is exhausted there will never be any more. If you want a copy remit at once. Address,

RECREATION, 23 W. 24th St., New York City.

THE Keeley Cure

**Alcohol,
Opium,
Tobacco
Using**

Produce each a disease having definite pathology. The disease yields easily to the Treatment as administered at the following Keeley Institutes:

ALWAYS ADDRESS THE INSTITUTE NEAREST TO YOU.

- | | | | |
|----------------------|----------------------|---------------------|-----------------------|
| Birmingham, Ala. | Des Moines, Ia. | Omaha, Neb. | Pittsburgh, Pa., |
| Hot Springs, Ark. | Crab Orchard, Ky. | Cor. Leavenworth | 4246 Fifth Ave. |
| Los Angeles, Cal. | New Orleans, La., | and 19th Streets | Columbia, S. C. |
| San Francisco, Cal., | 1628-38 Felicity St. | North Conway, N. H. | Sioux Falls, S. D. |
| 1170 Market St. | Portland, Me. | Buffalo, N. Y. | Dallas, Tex., |
| West Haven, Conn. | Lexington, Mass. | White Plains, N. Y. | Bellevue Place. |
| Washington, D. C., | Grand Rapids, Mich. | Columbus, O. | Salt Lake City, Utah. |
| 211 N. Capitol St. | Kansas City, Mo. | Portland, Ore. | Richmond, Va. |
| Atlanta, Ga. | St. Louis, Mo. | Harrisburg, Pa. | Seattle, Wash. |
| Dwight, Ill. | Boulder Hot Springs, | Philadelphia, Pa., | Waukesha, Wis. |
| Charlestown, Ind. | Boulder, Mont. | 812 N. Broad St. | Toronto, Ont. |
| Marion, Ind. | Fargo, N. D. | Providence, R. I. | Winnipeg, Man. |

'Non-Heredity, of Inebriety' by Dr. Leslie E. Keeley, mailed on application.



LESLIE E. KEELEY, M.D., LL.D.

WHAT THE
RT. REV. JOHN SHANLEY
BISHOP OF NORTH DAKOTA, Says:

It is because I know it does save them, because I know it is God's truth that I take the deepest interest in the Keeley Cure, and so long as I live I shall raise my voice in advocating its efficacy.

Rt. Rev. JOHN SHANLEY,
Bishop of North Dakota.

Details of treatment and proofs of its success sent free on application to any of the institutes named.

Here is Another!

If you will send me

30 Yearly Subscriptions

to

RECREATION

I will send you

A No. 10 Goerz Trieder-Binocular Field Glass

Listed at \$38.00

Every well-informed man knows the great power of this modern prismatic field glass. It is indispensable to every hunter, and is one of the latest and best on the market.

I have but a few of these instruments on hand and the offer will be withdrawn as soon as the supply is exhausted. Therefore, if you want one

START IMMEDIATELY.

Sample copies of RECREATION for use in canvassing furnished on application.

For Sale. A comfortable 7 room cottage on the shore of Lake Windermere, B. C. Grand View of the Selkirk Mountains to the West and Rockies to the East. Altitude 2,200 feet. Black and grizzly bears, moose, elk, mountain sheep, goats, deer, ducks, geese, prairie chickens, blue grouse and ptarmigan within easy reach. Would also sell horses, buck-board, riding and pack saddles, canoe and row boat. Excellent chance for securing a delightful summer home. Address, R. S. Gallop, Athalmer, Northeast Kootenay, B. C.

For Sale :--One Chesapeake Bay Dog, eligible to be registered, 9 months old. Maurice Schindler, Sisseton, S. D.



ARNICA Tooth Soap

the International Dentifrice



Beautifies the teeth, hardens the gums, sweetens the breath. Preserves as well as beautifies the teeth. Comes in neat, handy metal boxes. No powder to scatter, no liquid to spill or to stain garments.

25 Cents
At all Druggists.

C. H. STRONG & CO., Proprietors,
Chicago, U. S. A.



Grand Canyon of Arizona

Pictures of it: For 25 cents will send the season's novelty—a Grand Canyon photochrome view, uniquely mounted for desk use; accurately reproduces the Canyon tints. Or, for same price, a set of four black-and-white prints, ready for framing.

Books about it: For 50 cents will send a Grand Canyon book, 128 pages, 93 illustrations, map and cover in colors; contains articles by noted authors, travelers and scientists. Worthy a place in any library. Or will mail free pamphlet, "Titan of Chasms."

Visit it: Take the Santa Fe for California. Stop off at Williams, Ariz., and go by rail only 64 miles to Grand Canyon. Stay there one, two or more days. You have seen Earth's greatest wonder, the titan of chasms, a mile deep, many miles wide.

General Passenger Office
Atchison, Topeka & Santa Fe Railway
1324 Great Northern B'ld'g, Chicago

Santa Fe



The "Victor" is the real talking machine; its sound is natural. Band playing, monologues, comic or religious songs, all are reproduced as clear as if the artist was present. When ordering, **get the latest styles**—we charge no more than others who offer you old styles. Get our full catalogue FREE.

E. L. Cuendet, 7 Barclay St., New York.

The Reason the LUTHER HAND-MADE GLOVE will not rip



Machine sewing cuts itself



Hand sewing cannot.

A Practical Hunting and Driving Glove

Made for practical, comfortable, durability. No Oil. No Odor. No Animal Glue. Practically seamless. Cannot Rip. Unaffected by moisture of any kind. If soiled, may be washed with soap and hot water, without injury. The Luther Fastener is adjustable, fits any wrist and cannot get out of order. Illustrated booklet, samples and self measurement rule on application.

If you prefer to buy through your dealer send us his name

No. 308 Driving Glove	postpaid anywhere	\$1.50,	made to measure	\$2
No. 320 Gauntlet,		2.50,	"	3

J. P. LUTHER GLOVE CO., 536 Pearl St., Berlin, Wis.

Jaeger
 PURE WOOL UNDERWEAR

Protects
 Against
 Temperature Changes.

The Standard Sanitary
 Underwear for Men, Women
 and Children.

ALL WEIGHTS FOR ALL WANTS

Endorsed by Leading Physicians.

Also various JAEGER Novelties and
 Specialties.

ILLUSTRATED CATALOGUE FREE.

DR. JAEGER S. W. S. CO.'S OWN STORES.

NEW YORK : 306 Fifth Ave., 157 Broadway.

BROOKLYN : 504 Fulton Street.

BOSTON : 230-232 Boylston Street.

PHILADELPHIA : 1510 Chestnut Street.

CHICAGO : 82 State Street.

AGENTS IN ALL PRINCIPAL CITIES.

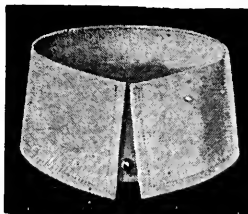

5 PLY $\frac{1}{4}$ SIZE
COLLARS--15c

Absolutely perfect collars. Sure
 cure for the 25c collar habit.

All our collars are made in $\frac{1}{4}$ -inch sizes, 14, 14 $\frac{1}{4}$, 14 $\frac{1}{2}$, 14 $\frac{3}{4}$,
 15, etc., to 18. Our anti-swear collar buttoner free.

*If you don't know
 "Tom Murray"
 you ought to.
 "He makes shirts."*

We show 200 exclusive patterns of our own make of shirts—
 \$1.50 to \$2.50. Shirts different from your neighbors'. 4 cuffs
 to each shirt without extra charge. 200 samples for 6 cents
 postage.

Our handsome booklet "Cor-
 rect Wear for Men" free.
 Everything in men's furnishings
 is reproduced in actual colors.
 We cater to the well-dressed gen-
 tlemen "out of town." Goods
 sent on approval to responsible
 parties. Credit accounts opene
 where desired.



TOM MURRAY,
250-256 Clark St. CHICAGO

We help men keep up-to-date.

Do you want
 A Folding Canvas Boat?

IF SO, SEND ME

35 yearly subscriptions
 to RECREATION

AND I WILL SEND YOU

A 14 ft. folding canvas boat
 listed at \$48

capable of carrying 2 men
 and an ordinary camp outfit.
 There are thousands of these
 boats in use, and nearly ev-
 ery man who is using one of
 them praises it on every oc-
 casion.

Sample copies of RECREA-
 TION for use in canvassing
 will be furnished on applica-
 tion.

Address 23 W. 24th St., N. Y.

The Celebrated

**THOMPSON-
 QUIMBY**

Hunting
 Boots,
 Shoes and
 Mocca-
 sins

I
 have
 on file
 mea-
 surements
 of all who
 bought
 Boots and
 Shoes of the
 W. Fred Quimby
 Co., of New York
 for the past 20
 years, and I make
 the same grade of
 sportsmen's foot-
 wear as they made.
 I was superin-
 tendent of the
 shoe department



of that firm and bought the
 right to make these boots and
 shoes. Get a pair now. They
 will last years and are the cheap-
 est in the end. I refer by permis-
 sion to the Editor of RECREATION.

Measurement blanks and prices on
 application. Mention RECREATION.

T. H. GUTHRIE

33 William Street,

NEWARK, N. J.

All Work
 Guaranteed

THOMPSON

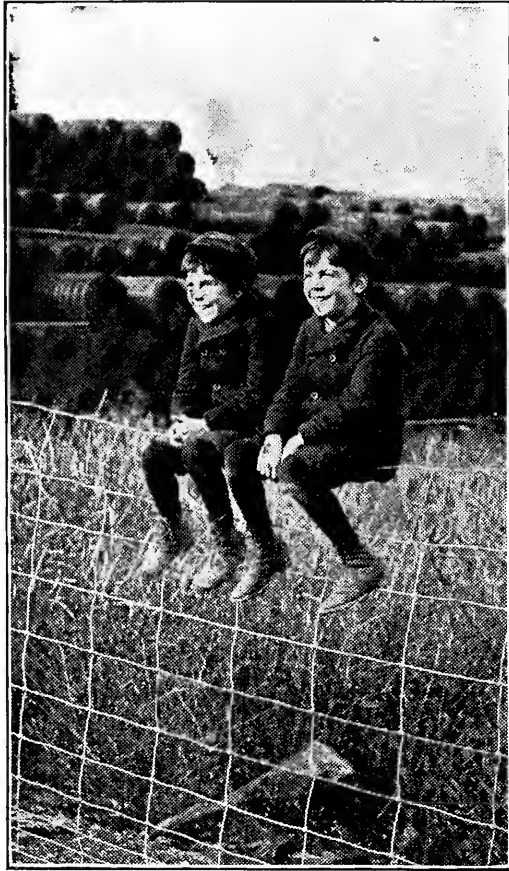

These are Close Figures on PAGE FENCE

Even though we could use common wire—such wire as is used in the fences we have to compete with—even then our mode of construction would make Page Fence worth more.

Notice how the boys slide the two top wires down, without bending a cross bar.

That's our "Loop Top," and no other fence has it.

Page Woven Wire Fence Co.

Box 39

ADRIAN, MICH.



Music Boxes

For the Home, it is company at all times, will cheer you when you are sad; a veritable need when you are lonely; an accompaniment to your song, and play **Dance** music in **perfect time**. A boon to all music lovers. Our variety is great; prices to suit all. Our No. 20 costs only \$2.50, while our No. 191 runs in the hundreds. Complete Catalogues FREE.

E. L. CUENDET, 7 Barclay St., New York



The Hawkeye REFRIGERATOR BASKET

Keeps Contents Ice Cold.

Makes an outdoor luncheon a genuine luxury because a small quantity of ice keeps everything as fresh and palatable as when prepared. Well made in different sizes, durable and nicely finished. Ask your dealer for it. Descriptive booklet giving valuable lunch recipes.

SENT FREE

Burlington Basket Co. 17 Main St. Burlington, Ia.

This, from an old time hog, may help you put to shame some thoroughbred of my class.

A few years ago Humboldt county was blessed with abundance of fish and all sorts of small game, and ducks and geese in season. These latter did not nest with us.

In those days it was a strife among us young swine to see who could get the biggest bag of game, and no one was considered a hunter who could not show up at least 2 dozen of any of the common birds or fishes.

I was in the front rank, receiving many compliments, and got the swelled head bad. However, the inflation has gone down, and I now feel that 2 geese or brant, 2 messes of ducks, chickens, or quails, and a mess of fish once or twice a week should satisfy any gentleman.

I would gladly have gunning entirely prohibited for 2 or 3 years, so that game might increase.

Down with the swine!

C. V. M., Humboldt, Iowa.

Perfect Food means Perfect Health

Perfect health means bright, sparkling eyes, a clear complexion, a sweet breath, sound white teeth, an active brain and a symmetrical body.

SHREDDED WHEAT BISCUIT

is a perfect food because it is complete in itself for the perfect nourishment of the whole body. (Read that statement again.) *Shredded Whole Wheat Biscuit is made in the most hygienic Food Laboratory in the world.*

The wheat is thoroughly cooked, and spun out into porous shreds and is, therefore, naturally light and short without the use of yeast, baking powders, fats or chemicals of any kind. It is crisp and compels the teeth to perform their natural exercise. This means perfect digestion, perfect health and relief from constipation.

Sold by all Grocers. Send for "The Vital Question" (Cook Book illustrated in colors) **FREE**. Address

**THE NATURAL FOOD CO.,
NIAGARA FALLS, N. Y.**

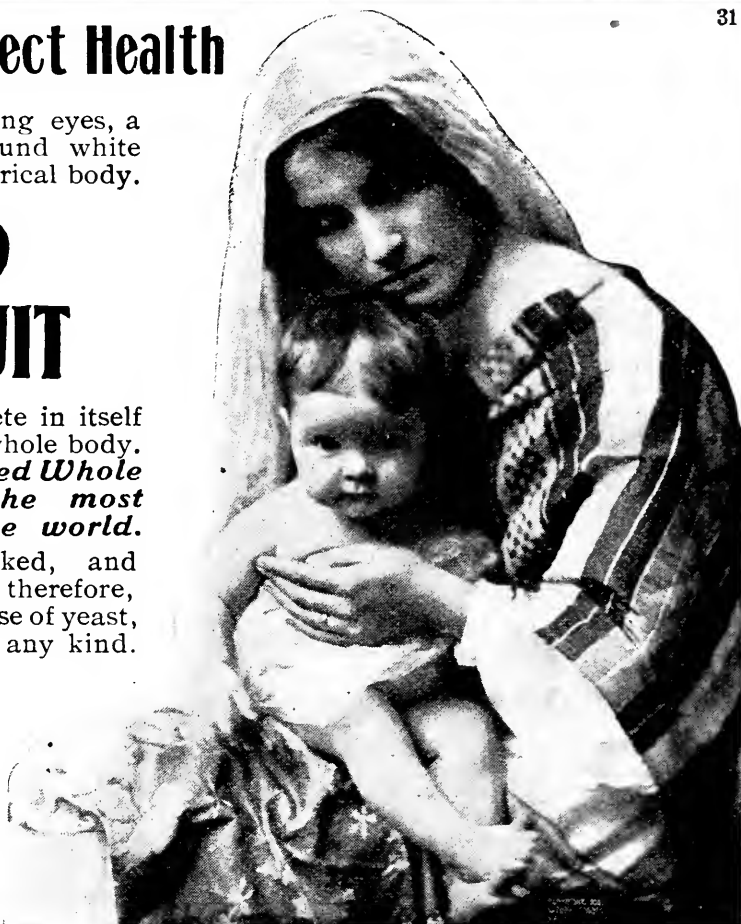

Club Cocktails



Famous the world over for purity. They never vary. The secret of their perfect blend is that they are kept six months before being drawn off and bottled. Be sure you have them in your camp, on the yacht, and on your outing trips wherever you

go. They are ready and require no mixing. Simply pour over cracked ice.

For Sale by all Fancy Grocers and Dealers

G. F. HEUBLEIN & BRO.
29 BROADWAY, N. Y. HARTFORD, CONN.

YOUR SOUP

Fish, Oysters, Lobsters, etc., will be vastly improved if seasoned with McILHENNY'S

Tabasco Sauce

It gives a keen appetite and stimulates the digestion.

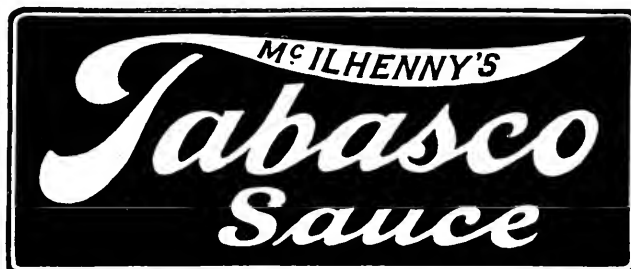

Imparts a delicious flavor that delights the epicure. It is purer and better than any ground pepper. Once used, McILHENNY'S

Tabasco Sauce

becomes indispensable on the table and in the kitchen. For Soups, Sauces, Salad Dressings, Gravies, etc.

Ask your dealer for McILHENNY'S TABASCO, the original and best.

FREE. We shall be pleased to send, on request, our interesting booklet containing new and unique recipes.

Address McILHENNY'S TABASCO, New Iberia, La



\$5.00 IS ALL YOU PAY FOR

Banner
(TRADE MARK)

Rubber

Coat

Weight 4¾ lbs.

Patent.

Absolutely Waterproof
A Gentleman's Rain Coat

STRONG AND SERVICEABLE.

Endorsed by many "RECREATION" readers.

"It is just what I want and is the only coat I ever found that would REALLY SHED RAIN."

Sent express paid anywhere in United States on receipt of \$5.00. Sizes, 36 to 46 inches.

Money returned if Coat does not suit.

Give chest measure over ordinary coat.

Mackintoshes and Rain Coats made to order
All best quality Rubber Goods

NORTHERN RUBBER CO.

Dept. P. ST. PAUL, MINN.

The Kittatinny Delaware Water Gap

PENNSYLVANIA.

Beautifully located in the Blue Ridge Mountains, about ninety miles from both New York and Philadelphia. Thoroughly modern Hotel; electric lights, steam elevator; unexcelled Mountain walks and Drives. Good Spring Fishing, Rowing and Golf.

LEEDS & LIPPINCOTT,

Proprietors.

Haddon Hall, Atlantic City, N. J.

LEWIS T. BRYANT, Manager.

ADIRONDACKS

CAMP MOHAWK and
COTTAGES

Fourth Lake, Fulton Chain.

Write for
booklet Mrs. H. H. Longstaff, Old Forge,
N. Y.

RECREATION SEEKERS

I would like to correspond with a few Sportsmen and Sportswomen relative to unexplored regions. Beautiful undisturbed Nature, pure air, pure water, big game, big fish, trout and muskalonge. One day's paddle from railroad. E. C. TRIPP,
Atikokan, Ontario, Canada. Seine River Dist.

IN THE ADIRONDACKS

Indian Lake House

Mountain View, N. Y.

C.C. Morgan, Prop.

ALL THE YEAR

All passenger trains on A. & St. L. R. R. will be met by boat and bus. Passengers conveyed directly to the house.

Rates. \$2 per Day.

Special Rates to Parties

Best DEER HUNTING and TROUT FISHING to be found.
In the Adirondacks

White Mountain Views Free

To any person sending me a subscription to RECREATION accompanied by \$1. I will send two mounted photos, on velox paper taken among the White Mountains, size 6x8; one shows Mt. Washington snow capped. To any one sending 2 subscriptions with \$2 I will send a souvenir of the White Mountains, size 4½ x 5½ containing seven photos. Send P. O. Money Order.

M. E. TUTTLE, Box 337 Dover, N. H.

**A WELL-BRED, WELL-TRAINED
SETTER FOR \$9.99**—doesn't tempt the
wise man.

I have for sale a registered blue belton, Llewellyn six year old, trained thoroughly on quail in Carolina, on grouse in New England, on woodcock in Nova Scotia. She is no field trial race-horse, no bench-show beauty but an all-day worker, a great bird finder, absolutely staunch, retrieves from land or water, is tractable and affectionate. Will gladly show her at work and give references. Price is \$125 and she is worth it. I have one of her sons, 6 months old, by Montell A. K. C., No. 31129, handsome, sturdy and full of promise. Price, \$30.

Ernest Russell, 13 Foster Street,

Worcester, Mass.

A Hunting Knife Free. To any person sending me three yearly subscriptions to RECREATION and \$3, I will send a pocket hunting knife with handle 5½ inches long and blade 5 inches long. Fine steel, excellent workmanship. Your name and address and your L. A. S. number if desired inserted on a plate in the handle.

Geo. W. Mains, McKeesport, Pa.

Mexican Opals Free: To any one subscribing to RECREATION through me, I will send a beautiful genuine Mexican Opal, large as a cean.

A. Thompson, Box 332, Sad Antonio, Tex.

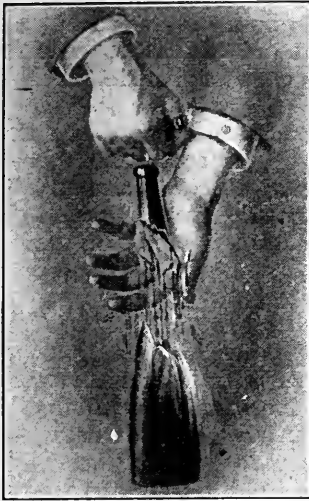

Don't wait until your wife or servants Cut Their Hands

BUY A

Yankee Cork Puller

An up and down motion of the handle draws the tightest cork and automatically discharges it. No effort. No trouble. No broken bits of cork left in the bottle. Never slips. Lasts a lifetime. Fastens to sideboard, door-jamb or other upright surface. Cannot get lost.

Ask the hardware dealer, or sent direct, express prepaid, on receipt of price.

BOOKLET FOR **Nickel Plated** - \$1.25
THE ASKING. **Silver** - 3.50

After 30 days' trial money cheerfully refunded if not pleased

THE GILCHRIST CO.

125 Lafayette St.

Newark, N. J.

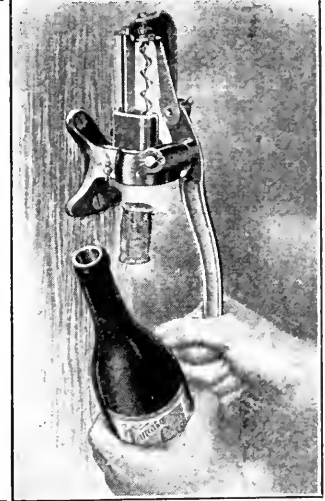

Free: To anyone sending, through me, \$1 for yearly subscription to RECREATION, I will send free a No. 1 Sportsman's Medicine Case; for 2 subscriptions a Physician's Pocket Medicine Case; for 10 subscriptions 1,000 12-gauge primed paper shot shells. This offer is not open to old subscribers who formerly have sent in their subscriptions to the office of RECREATION, but to all others.

Walter Luson, Ardmore, Pa.

Huron Indian Work: To any one subscribing to RECREATION through me I will give a Bracelet and Ring worked in horse-hair, with any small inscription you like, your name, etc., woven in it with caribou hair; quite a curiosity, send along your \$1. Walter Legare, 518½ John Street, Quebec, Canada.

For Sale: A lot of excellent photos of live wild elk, taken last winter. Some of these pictures were made during the time of the heavy snow, when the elk were suffering for food; others when there was but 2 or 3 inches of snow. Some pictures show single animals at close range, while others show 50 to 100 each, at a distance of 100 feet or more from the camera. Prices: 5x7, \$1.50 a dozen; 6½x8½, \$2.50 a dozen. I refer, by permission, to the Editor of RECREATION, who has a set of these pictures. S. N. Leek, Jackson, Wyo.

Do You Want a Drinking Cup Free?

Send me \$1 for a new subscription to RECREATION and I will send you a fine nickel-plated folding drinking cup. For 10 cents extra will send by registered mail. Mrs. Thomas H. Walker, 205 Merrimac Street, Manchester, N. H.

Another Good Offer: To the first person sending me five subscriptions to Recreation and five dollars, before April 1st, I will give a 2 by 3½ printing press, and type to go with it. To any person sending me subscriptions and two dollars. I will give a silver plated napkin ring. To any person sending 1 subscription, I will give a sterling silver ring. All persons sending me one subscription, please send finger measurement.

A. J. Brodhead, 42 Sayre St.,
Elizabeth, N. J.

Sent Free: Ten varieties of Mexican postage and revenue stamps for one annual subscription to RECREATION sent in through me. Stamp collectors should not miss this chance to increase their collection of Mexican stamps. Albert M. Penn, Laredo, Tex.

FREE To each person sending me \$1. (P.O. Money order) for one year's subscription to RECREATION, I will send his choice of the following.

A **Genuine Briar Pipe** with **Genuine Amber Bit**, or a **Braided Leather Dog Whip** with snap on end, or a **Polished Steel Dog Chain** with swivels, snaps, etc., or a **MacMillan Shell Extractor** for any size of shell from 8 gauge to 22 caliber, or a **Pocket Compass**, 1 in. dial open face, watch shape, with ring handle, bevel crystal.

EDWARD S. ADAMS, Box 536, Manchester, N. H.

Wanted.—A lady and daughter, in a country village, are desirous of furnishing a home for the summer for 4 or 5 girls between the ages of 8 and 14. Close care and attention will be given them. The locality is healthful, and particularly adapted for mountain walks, wheeling, and delightful drives. A fine opportunity is offered for the study of nature.

The best references given and required. Inquire of Editor.



Size 17 in.

A skilled mechanic has invented lately a **Musical Clock** which, besides keeping perfect time, running 8 days with one winding, striking the hours and halves, will also **play favorite airs every half hour**. As the cost is very low, many prefer buying the clock with the musical attachment. Ask your jeweler for it or send to **E. L. CUENDET, Mfr., 7 Barclay Street, New York**

SOME RARE OPPORTUNITIES

These goods are all new, and will be shipped direct from factory. Prices named are those at which manufacturers and dealers usually sell. Here is a good chance to get

A Book, a Gun, a Camera
A Sleeping Bag, a Fishing Rod
A Reel, a Tent, } FREE OF COST

Subscriptions need not all be sent at once. They may be sent in installments as taken and credit will be given on account. When the required number is obtained the premium earned will be shipped.

These Offers are subject to change without notice.

TO ANY PERSON SENDING ME

TWO yearly subscriptions to RECREATION at \$1 each, I will send a copy of *Hunting in the Great West*, cloth; or a Zar Camera, listed at \$1; or an Ingersoll Watch or Cyclometer, listed at \$1; or a Recreation Waterproof Match Box, made by W. L. Marble and listed at \$1; or a Shakespeare Revolution Bait listed at 75 cents; or a Laughlin Fountain Pen; or a dozen Trout Flies, assorted, listed at \$1; or a pair of Attachable Eyeglass Temples, gold-plated, made by Gall & Lembke; or one Rifle Wick Plug, made by Hemm & Woodward, Sidney, Ohio, 30 caliber to 50 caliber, or Shotgun Wick Plug, 20 gauge up to 10 gauge.

THREE subscriptions at \$1 each, a safety pocket ax, made by W. L. Marble and listed at \$2.50; or a dozen Bass Flies, assorted, listed at \$2; or 4 dozen Carbutt plates, 4 x 5 or 5 x 7; or a pair of chrome tanned horsehide hunting and driving gloves, listed at \$1.50, made by J. P. Luther Glove Co.; or a pair of Shotgun Wick Plugs made by Hemm & Woodward, Sidney, Ohio, 20 gauge to 10 gauge.

FOUR subscriptions at \$1 each, an Ideal Hunting Knife, made by W. L. Marble and listed at \$2.50; or a .32 caliber Automatic Forehand Revolver, made by the Hopkins & Allen Arms Co.; or a No. 822 Rifle made by the Hopkins & Allen Arms Co., listed at \$4.50.

FIVE subscriptions at \$1 each, a copy of *Cruisings in the Cascades*, cloth; or a set of Nehring's Convertible Ampliscopes, listed at \$5.00; or an Ideal Hunting Knife made by W. L. Marble, and listed at \$3; or a polished Buffalo Horn Gun Rack, made by E. W. Stiles; or a Forehand Gun, made by the Hopkins & Allen Arms Co., listed at \$6; or a pair of lock lever skates, made by Barney & Berry, listed at \$4.50; or a pair of gauntlets, for hunting and driving, ladies' size, listed at \$2.50, made by J. P. Luther Glove Co., or a J C Hand trap made by the Mitchell Mfg. Co., listed at \$4.

SIX subscriptions at \$1 each, a Hawkeye Refrigerating Basket made by the Burlington Basket Co., or one dozen Eureka golf balls listed at \$4; or a Forehand Gun made by the Hopkins & Allen Arms Co., listed at \$9.; or a Pocket Poco B 3/4 x 4 1/4, made by the Rochester Optical & Camera Co. listed at \$9.

SEVEN subscriptions at \$1 each, a copy of *The Big Game of North America*, or of *The American Book of the Dog*, cloth, or one set Lakewood golf clubs, 5 in number, listing at \$5;

or a series 11B or 11D Korona Camera, made by the Gundlach Optical Co., listed at \$10. EIGHT subscriptions at \$1 each, a 4 x 5 Weno Hawk-Eye Camera, made by the Blair Camera Co., and listed at \$8.; or a series 1, 4x5, Korona Camera, made by the Gundlach Optical Co., listed at \$12.; or a pair of horsehide Hunting shoes, made by T. H. Guthrie, Newark, N. J., and listed at \$8. NINE subscriptions at \$1 each, an Acme single shot gun, made by the Davenport Arms Co., and listed at \$8.

TEN subscriptions at \$1 each, a Cut-Glass Salad Bowl, made by Higgins & Seiter, and listed at \$4.50; or a Yawman & Erbe Automatic Reel, listed at \$6 to \$9; or a Bristol Steel Fishing Rod, listed at \$6, or less; or a Waterproof Wall Tent 7 x 7, made by Abercrombie & Fitch, and listed at \$8.; or a pair of horsehide Hunting Boots, made by T. H. Guthrie, Newark, N. J., and listed at \$10.

TWELVE subscriptions at \$1 each, a Peabody Carbine valued at \$12; or a No. 5 Side Telescope Rifle Sight, listed at \$18; or a Davenport Ejector Gun, listed at \$10., or a Cycle Poco No. 3, 4x5, made by the Rochester Optical and Camera Co., listed at \$15.

FIFTEEN subscriptions at \$1 each, a Shakespeare Reel, Silver Plated, listed at \$15; or a set of rabbit plates made by Higgins & Seiter, and listed at \$8, or a Field Glass made by Gall & Lembke; or a Kenwood Sleeping Bag, complete, with canvas cover, listed at \$16.

TWENTY subscriptions at \$1 each, a 14-karat Gold Hunting-case Watch, with Waltham Movement, listed at \$20; or a Repeating Rifle, listed at \$16 or less; or an Elita single shot gun, made by the Davenport Arms Co., and listed at \$18., or an Acme Folding Canvas Boat, No. 1, Grade B, listed at \$20; or a Mullins Duck Boat, listed at \$20; or a Shattuck double hammerless shot gun listed at \$25.

TWENTY-FIVE subscriptions at \$1 each, an 11-foot King Folding Canvas Boat, listed at \$38; or a Repeating Rifle, listed at \$20 or less; or a 4 x 5 Planatic lens, made by the Rochester Lens Co., and listed at \$25; or a Syracuse Grade OO, double hammerless Gun, made by the Syracuse Arms Co., and listed at \$30.

THIRTY subscriptions at \$1 each, a Repeating Rifle, listed at \$25 or less; or a Waterproof Tent, 14 1/2 x 17, made by Abercrombie & Fitch, and listed at \$25; or an Ithaca, quality No. 1, plain, double barrel, hammerless breech loading shot gun, listed at \$40.; or a Field Glass, made by C. P. Goerz.

THIRTY-FIVE subscriptions at \$1 each, a 14-foot King Folding Canvas boat, listed at \$48.

FORTY subscriptions at \$1 each, a Savage .303 Repeating Rifle; or a No. 10 Gun Cabinet, made by the West End Furniture Co., and listed at \$32.

FORTY-FIVE subscriptions at \$1 each, a Royal Anastigmat Lens, 4 x 5, series I, made by Rochester Lens Co., and listed at \$45.

FIFTY subscriptions at \$1 each, a No. 20 Gun Cabinet, made by the West End Furniture Co., and listed at \$38.

TWO HUNDRED subscriptions at \$1 each, a strictly first class upright piano, listed at \$750.

Address, **Recreation 23 West 24th St. New York**

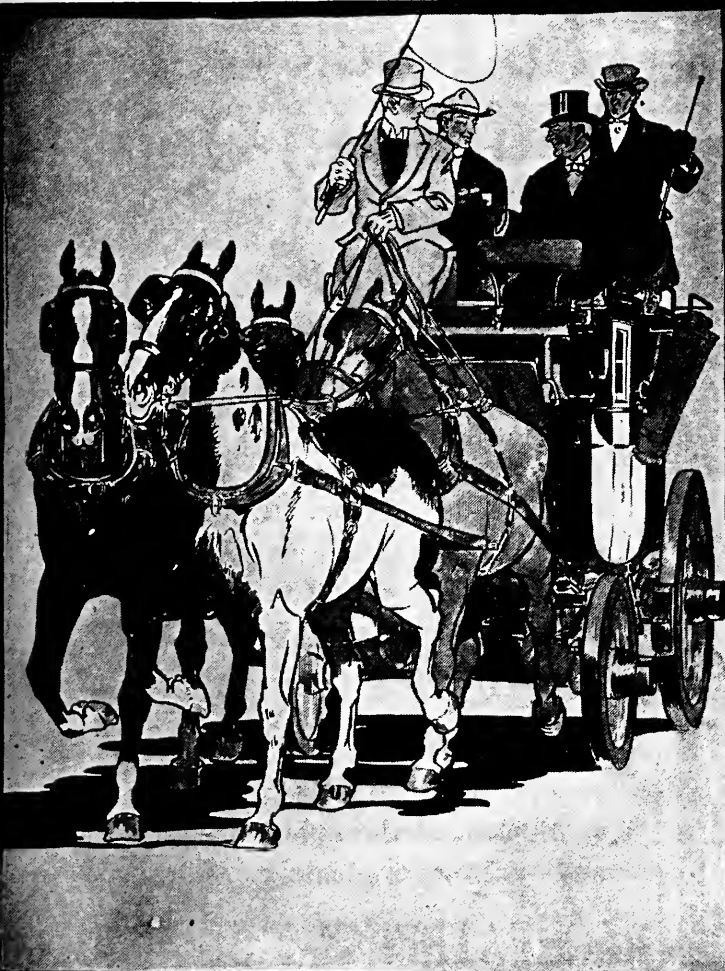

“IT'S ALWAYS FAIR WEATHER WHEN GOOD FELLOWS GET TOGETHER.”

The best pledge of good fellowship in fair weather or foul is

Dewar's Scotch

the King of Whiskies and the Whiskey of Kings. Awarded 53 gold and prize medals, and supplied by Royal Warrant to His Majesty King Edward VII.

A COACHING PRINT

“To the Health of the Whip” (copyright, 1903, by Frederick Glassup), being a reproduction in four colors of the original design by Edward Penfield, shown herewith, will be sent to any address on receipt of 10 cents in silver. Printed on fine plate paper, size 9 x 12, without advertisement of any kind, and suitable for framing in club house or home. Next month, “Fisher-man's Luck,” by E. N. Blue. Address

FREDERICK GLASSUP

Sole Agent for John Dewar & Sons, Ltd.

126 Bleecker Street, New York

REMARKABLE OFFERS

To every person who will send RECREATION \$1 for 1 year's subscription to be placed to my credit I will give as a premium a choice of a Nickel Plated Match Safe, or a Gilt Metal Match Safe, or a Hard Rubber Water Proof Match Safe, each listed at 40 cents; or a Nickel Dog Whistle and pocket drinking cup, listed at 50 cents; cents; or a Nail Clipper, with file and Nail Clipper attached, listed at 40 cents; or a 25 yard Single Action Reel, listed at 40 cents; or a 25 yard Water Proof Silk Line, listed at 50 cents.

For 2 subscriptions a Hunting Knife, Stag Handle, Blade 5½ inches long, listed at \$1.

For 3 subscriptions a Patent Double Minnow Bucket, listed at \$2; or a 60 yard Multiplying Reel, listed at \$2; or a 3-piece Bamboo Rod, 7 or 9 feet long, listed at \$2; or a Heavy Silk Watch Fob, listed at \$1.50.

For 5 subscriptions a fancy striped Hammock, listed at \$3; or a Hunting Knife, listed at \$3; or a Tackle Box, listed at \$3.

For 9 subscriptions a field glass listed at \$6.

Only a limited number of subscriptions can be accepted on these offers.

C. W. Jacobs, Coshocton, Ohio.

IF YOU WOULD LIVE NEXT TO NATURE, READ RECREATION.



UNDERWOOD'S ORIGINAL DEVILED HAM

The pure and delicate Deviled Ham which has been on the market for years. Sugar-cured ham and fine, pure spices is all that we use. It is delicious for sandwiches, at lunch, picnic, or tea, and in the chafing-dish. It may be bought at any good grocers, but be sure you see on the can THE LITTLE RED DEVIL. There is only ONE Deviled Ham — Underwood's Red Devil Brand. All others are imitations, but imitations in name only, as the goods commonly labeled and sold as potted or deviled ham, made as they are from the odds and ends of the packing house, are no more like Underwood's Original Ham than chalk is like cheese. Our Book contains a lot of unique and practical receipts. We will send it FREE. WM. UNDERWOOD CO., Boston, Mass., U. S. A.

EVERYONE LOVES The EDISON PHONOGRAPH

NONE GENUINE WITHOUT THIS TRADE MARK
Thomas A Edison
 MARK



The **Phonograph** is distinguished from other talking machines by its absolute freedom from scratching and pure, natural tones of music or voice.

The **Phonograph** is infinitely superior.

The **Phonograph** is sold in 5,000 stores. Call at the nearest dealer's and hear the modern **Phonograph** with the new *Edison Moulded Records* and the *New Reproducer*.

Phonographs from \$10.00 to \$100.00.
 Records, 50c.; \$5.00 per dozen.

NATIONAL PHONOGRAPH CO., Orange, N. J.

NEW YORK, 83 Chambers St. CHICAGO, 304 Wabash Ave. SAN FRANCISCO, 933 Market St. EUROPE, 32 Rempart, Saint Georges, ANTWERP, BELGIUM.

The Rocky Mountain Goat

Is a shy, wary animal that ranges
8,000 to 15,000 feet
above sea level

and has rarely been photographed. Mr. A. M. Collins, one of RECREATION's prize winning photographers, has recently made 4 of the finest goat pictures ever produced. I HAVE had enlargements made from these, 13 x 15 inches, and will sell them

At \$5.00 a Set.

A rare and valuable group for sportsmen, amateur photographers and nature students. Address

RECREATION, 23 WEST 24th ST. NEW YORK CITY

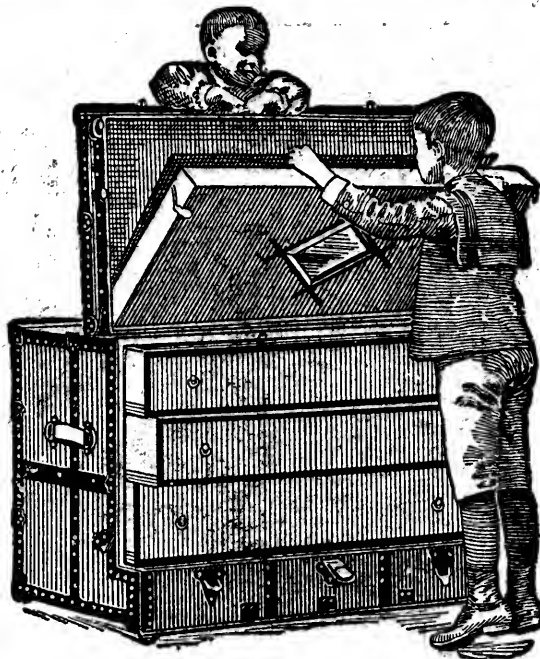

Stallman's Dresser Trunk

Have you seen one? It is up-to-date. Think of it, everything within reach. No heavy trays, but light, smooth drawers. Holds as much and costs no more than a good box trunk. Hand riveted, almost indestructible. Once tried, always recommended. Sent C. O. D., privilege examination. 2c. stamp for catalogue. Mention RECREATION.

F. A. STALLMAN,
 87 W. Spring St., Columbus, O.

EXTRAORDINARY OFFER.

To any person sending me \$1 for a year's subscription to RECREATION, I will give free one of the following books: 6th and 7th Books of Moses. This is a great book. Every home should have one. Volumes I-II., bound together in one volume; regular price is \$1. "The Almighty Dollar" is a new book just published, and is worth its weight in gold to any one. Can not be obtained for less than \$1 anywhere.

"Hunter's Guide and Trapper's Companion." This is a book every hunter and trapper should have. Descriptions of these books will be sent for a stamp. This is the greatest offer ever made, and you should not let this pass. Old subscribers may avail of this offer by sending 10 cents extra. Address Henry Nelson, Eckwoll, Minn.

FREE. To anyone subscribing to RECREATION through me I will give a cloth copy of one of Cooper's, Dickens', Dumas', Thackeray's or Conan Doyle's books. Address, J. M. RUGEN, 210 West Lake St., Chicago, Ill.

BE A WRITER



Learn *Journalism* and *Story-Writing*, by mail. Send for our free booklet, "**Writing for Profit**," tells how to succeed as story-writer, newspaper correspondent, and magazine contributor. *Mss. sold on commission*; also criticised and revised.



Thornton West, Editor-in-Chief; founded 1895.

THE NATIONAL PRESS ASSOCIATION,
 No. 109 The Baldwin, Indianapolis, Ind.

AD INFINITUM.

(Dr. Dempwolff, of Berlin, announces that he has found an aquatic insect which preys on the anopheles mosquito. He is cultivating the creature artificially, with the expectation of destroying the mosquito and the host of germs which inhabit its body.)

They've found the bug
That eats the bug
That fights the bug
That bites us;
They've traced the germ
That kills the germ
That chews the germ
That smites us.

They know the bug
That knifes the bug
That stabs the bug
That jabs us;
They've seen the germ
That hates the germ
That biffs the germ
That nabs us.

They've chained the bug
That bolts the bug
That jolts the bug
That bings us;
They've got the germ
That gulps the germ
That nips the germ
That stings us.

They hold the bug
That scolds the bug
That told the bug
To pinch us;
They chase the germ
That helps the germ
That cheers the germ
To clinch us.

They've struck the bug
That slays the bug
That flays the bug
That sticks us;
They've jailed the germ
That guides the germ
That taught the germ
To fix us.

But still these bugs—
Microbic thugs—
In spite of drugs
Combat us;
And still these germs—
Described in terms
Inspiring squirms—
Get at us!

—W. D. Nesbit, in Life.

FREE BOOK, WEAK MEN



My illustrated nature book on losses varicose, impotency, lame back, free sealed, by mail. Much valuable advice and describes the new DR. SANDEN HERCULEX ELECTRIC BELT. Worn nights. No drugs. Currents soothing. Used by women also for rheumatic pains, etc. 5,000 cures 1902. Established 30 years. Advice free.

DR. G. B. SANDEN,
1155 Broadway, N. Y.

The MAN
and the HOUR
meet by the
time of an

Elgin Watch

Punctuality's watch
word is *Elgin*. Worn
everywhere; sold
everywhere; guaran-
teed by the world's
greatest watch factory.
Booklet mailed free.

ELGIN NATIONAL WATCH CO.
ELGIN, ILLINOIS.

Lovely Complexion FREE.



A Trial Package Mailed FREE which will give any lady a beautiful complexion. It is not a face powder, cream, cosmetic or bleach, but is absolutely pure and you can use it privately at home. It permanently removes moth patches, redness, crow's feet, pimples,

blackheads, fleshworms, sallowness, freckles, tan, sunburn, and all complexion disfigurements. Address,

MADAME M. RIBAUT, 4946 Elsa Bldg., Cincinnati, O.

IN ANSWERING ADS PLEASE
MENTION RECREATION.



THE
WORLD'S
STANDARD

THEY'RE MADE TO MEASURE

Putman Boots.

Go on like a glove *and* fit all over.

For a **Quarter of a Century** Putman Boots have been the Standard among Western Hunters, Prospectors, Ranchmen and Engineers (who demand the best) and we have learned through our personal contact with them **how** to make a perfect boot.

Putman Boots are in use in nearly every civilized country in the World. They are Genuine Hand Sewed, Water proof, Made to measure, Delivery charges prepaid, and cost no more than others. Send for Catalogue of over **30 different styles** of boots. Also **Indian Tanned Moosehide Moccasins**. We send with catalogue Order Blanks showing how to measure your foot.

We have in our files thousands of letters similar to the following.

GENTLEMEN:—Please send me another catalogue. We are all wearing Putman Boots and find them far superior to any other boot. I have ordered about 20 pairs for friends here during the past three years, and every pair has given perfect satisfaction, and I feel that I have done a man a favor when I have recommended your goods to him.

Respectfully,
W. H. FLUKER, Gen. Mgr,
(Columbia Mining Co.)
Tatham, Ga.

GENTLEMEN:—I have just returned from a duck hunt in Colleton Co. this state, and though I tramped through the marshes for six days and a part of the nights, sinking in mud and water nearly to the tops of the shoes I got from you, my feet kept dry throughout the trip and the shoes were as soft at the wind-up as at the beginning. I can cheerfully recommend your shoes to all sportsmen. Yours respectfully,

C. F. DILL,
Greenville, S. C.

GENTLEMEN:—Was fishing through the ice on the Flathead River this week standing for hours in wet snow and slush and tramping through the mountains, and I found the boots you built for me in December to be thoroughly water and snow proof, and quite warm. Yours truly,

L. R. FOGLE, Great falls, Mont.

Illustration shows
No. 900, 14 inch
Boot, made to measure
and delivered
in U. S. for

\$7.50.

H. J. PUTMAN & CO.,

86 HENNEPIN
AVE.

Minneapolis, Minn.

Because of their construction

PRESIDENT SUSPENDERS

give most

Comfort & Service

Guaranteed "All breaks made good"

"President" on buckle means

"Cannot rust" 50c. and \$1.00

Any shop or by mail prepaid

The C. A. Edgerton Mfg. Co.

Box 219-L

Shirley Mass



Send 6c.
for Catalogue

Mr. H. U. Mudge, general manager of the A., T. & S. F. Ry., was due for an inspection tour of his system West and South of Topeka, and favored me with an invitation to join him. It was impossible for me to get away to make the entire trip through Western Kansas, Colorado, New Mexico, Arizona and Texas, but by arrangement I met him at Amarillo, Texas, on his return and accompanied him through the Panhandle of Texas, Oklahoma and Southern Kansas to Topeka. We side-tracked at several switches and succeeded in killing 38 chickens and 15 blue wing teal. We had no dogs, but had no trouble in finding all the game needed to supply Mr. Mudge's special. There were 3 guns in the party, all fairly good wing shots, and none in sympathy with the wholesale slaughter of game or other hog proclivities. It was an exceedingly pleasant trip, and one which I enjoyed to the fullest extent. Mr. Mudge is a delightful companion, a good shot, and the best fly fisherman I ever had the pleasure of meeting on a trout stream.

Geo. A. Clark, Topeka, Kans.

SQUIRES' SIBERIAN MOOSE HUNTING BOOTS & SHOES

Made only by **HENRY C. SQUIRES & SON**
20 Cortlandt St., New York

The **leather** is waterproof, fine grained, tough and pliable. The **linings** are russet calfskin. The **soles** are best waterproof anhydrous oak leather, **stitching** of silk, English back stays, bulldog toes, extra heavy **eyelets**, **Pratt fasteners** and **hand made throughout**. Price **\$7.50** net. Short Boots **\$8.50**, Knee Boots **\$10**, Cavalry Style Boots **\$12**. Special circular giving detailed information free for the asking.



Mention RECREATION.

INDIAN CURIOS

WHOLESALE & RETAIL
CURIO DEALERS'
SUPPLY DEPOT.

Bead Work, Baskets, Elk Teeth, Mexican Goods, Fossils, Minerals, Arrow-Heads, Pottery, Alaska Ivories, Shells, Agates, Photos, Great stock, Big Cata. 5c., stamps. Mention RECREATION. If a dealer, say so.

L. W. STILWELL

DEADWOOD SO. DAKOTA



PHEASANTS

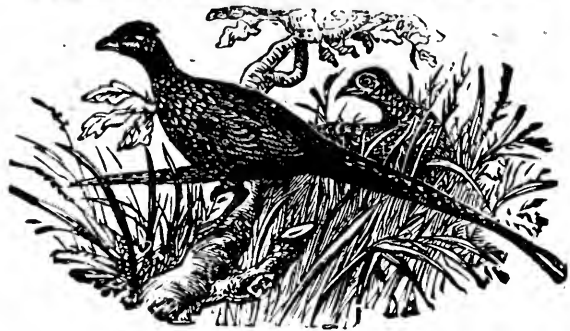

WATCH RESULTS.

Have your "poult" died at an early age? If so, use in future Spratts Patent Pheasant Meal and watch results.

Have they grown strong and healthy? If not, feed Spratts Patent Pheasant Meal and watch results.

Are the old birds strong and vigorous? If not, try Spratts Patent Pheasant Meal and watch results?

If eggs are scarce or infertile, feed Spratts Patent Pheasant Meal and watch results.

Catalogue and Book on Pheasant Rearing Free by Mail. We also manufacture specially prepared food for dogs, puppies, rabbits, cats, poultry, game, pigeons, fish, birds, etc.

SPRATTS PATENT (AMERICA) LIMITED

450 Market St., Newark, N. J.

BRANCHES. 1324 Valencia St., San Francisco, Cal.
714 S. 4th Street, St. Louis, Mo.

Squab Book Free



Squabs are raised in 1 month, bring big prices. Eager market. Astonishing profits. Easy for women and invalids. Use your spare time profitably. Small space and capital. Here is something worth looking into. Facts given in our FREE BOOK, "How to make money with Squabs." PLYMOUTH ROCK SQUAB CO., 11 Friend St., Boston, Mass.

Make Money Breeding Pheasants, Quail and Squabs

We Start You. Send stamp for booklet telling you how to succeed. We buy all you raise.

For sale, all kinds of Pheasants, Poultry, Ducks, Geese, Wood and Mandarin Ducks, Gold Fish Globes, etc. We want agents to sell our Gold Fish, etc.

May Flyers — Imported Angora Cats, Male or Females, \$5.00 each. Good Ruff, Tail and Coat.

Hub Poultry and Supply Co.,

Station A No. 5. Boston, Mass.

Cavies or Guinea Pigs

Peruvian, Abyssinian or English Long or Short Haire. All colors. 400 to select from.

T. RACKHAM,

East Orange, New Jersey.



Pheasants' Eggs for Sale

English and Mongolian \$3 for 15 golden, \$6 for 13.

L. M. Bachhuber, M.D. Mayville, Wis.

FINE MOUNTED GAME HEADS, BIRDS, ETC., for sale at unheard-of prices. Send 10 cents for photos.

JOHN CLAYTON, Taxidermist, Lincoln, Maine

MOUNT YOUR OWN SPECIMENS.

Read this, Sportsmen! Why not mount your own rare and beautiful birds and animals? This is your first opportunity to learn the art of Taxidermy from thoroughly reliable taxidermists and at a low price. It is a delight to do the work, and you already know the value of well mounted specimens in your home. Decorate your den. Good money by mounting for others, or in selling your specimens. Full and complete course at half the regular price, for a short time only. Write for particulars to-day. After taking our course you are a practical Taxidermist.

ELLWOOD'S SCHOOL OF TAXIDERMY,
HOLSTEIN, IOWA.

Taxidermist's Materials

Glass Eyes for Stuffed Birds and Animals
Oölogist's and Entomologist's Supplies
Send 5c. in stamps for Catalogue

FRED. KAEMPFER

88 State Street, Chicago, Ill.

Taxidermy work done in all its branches

FLORIDA BIRDS.

I have on hand a fair assortment of our Native Bird Skins, suitable for schools, museums or private collections.

During the season of 1903 I will collect any birds or mammals to order.

Finest mounted work a specialty.

R. D. HOYT, Taxidermist,
SEVEN OAKS, FLA.

SPORTSMEN!!

I carry a large stock from which to select, and can quote you prices that are right on anything in Taxidermy, Indian Curios, Buffalo Horns, etc. Send stamps for photos of what you want.

A. E. HAMMOND, Taxidermist,
Missoula, Mont.

To Close Out.

My collection of the Mammals, Birds, Heads, Antlers, Skulls, Birds' Eggs, Relics, etc., at Bargain. Send stamp to ERNEST L. BROWN, The Minnesota Taxidermist, Warren, Minn.

Do you enjoy big game hunting?

Or Trout Fishing?

Or Mountain Climbing?

If so, write us and we can accommodate you.

We keep 65 head of horses. We employ a full corps of experienced guides, packers, and cooks.

We have a complete outfit of riding saddles, pack saddles, tents, stoves, cooking utensils, tableware, and everything necessary for touring and camping in the Mountains.

We live at Banff. The Eastern gateway of the Canadian Rockies.

And can send you anywhere you may wish to go from this point

North, East, South or West.

Address: BREWSTER BROS.
Banff, Alberta, Canada.

IF
you want

TO GET VIM

and elasticity in a pup
troubled with worms, **get rid
of the worms.** If you want lus-
trous eyes and jolly companionship
in a dog who has worms, **kill the worms.**

There is in every business some standard of
excellence that all strive to gain all claim they
have it yet still keep striving. We believe we have
in "**SURE SHOT**" the standard vermifuge because it is
compounded by a scientific, practical and experienced man
who has owned and studied the well dog and the sick dog in home
and in field pretty much all his life. At any rate we do not try to
better it for we know it can't be improved upon, and the formula is our
sole property.

You've known all along what worms will do to a dog as a puppy or adult.
Now you know the best remedy for ridding a dog of worms.

SERGEANT'S "SURE SHOT"

is a remedy with a string of successful years behind it, because it is
thoroughly safe and reliable. No harm can follow its use even if worms
are not the trouble, and it will give puppies a strong, healthy constitu-
tion that will fight victoriously the ravages of disease later in life. No
first-class kennel manager or private owner ever thought of being with-
out it, once he used it.

Lock Box 103, HOLLY SPRINGS, MISS.
"I consider "**SURE SHOT**" the best medicine I have ever used for worms in
puppies, and the least trouble to administer. MRS. ROBERT HASTINGS.

SERGEANTS "SURE SHOT" per bottle 50c. Sold by Druggists or
Sporting Goods Dealers everywhere or mailed (prepaid) from

POLK MILLER DRUG CO.,
RICHMOND, VIRGINIA, BOX 217.

There isn't anywhere a dog lover or owner who wouldn't
like to have our 48 page Treatise on
Dogs. We will send it and a Ped-
igree Blank to any address for
3 cents in stamps, which
go to pay the postage.

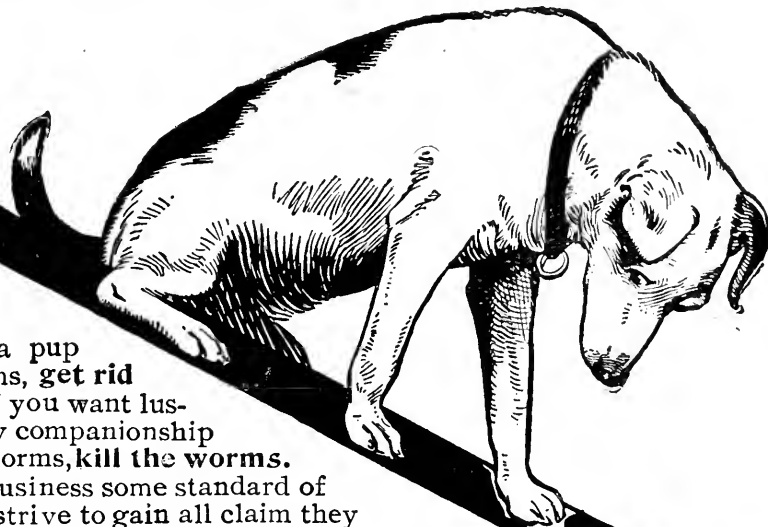

Marble's Automatic Gaff.



One of Marble's Automatic Gaffs will catch and hold any fish you can hook. You just reach out and touch the fish when near the boat and the gaff automatically seizes and holds him.

No. 1 Gaff, big enough for bass or any fish up to 15 lbs, in weight, **\$1.50**

No. 2 Gaff for all fish between 10 and 60 lbs., postpaid, **\$2.00**

Either finished in Nickel, 50 cents extra.

MARBLE'S HANDY FISH KNIVES are more satisfactory than others because hand-somer and better made. Postpaid, **85 cents** and **\$1.00**.

SEND FOR CATALOG A.

Sold by Dealers or Direct from

MARBLE SAFETY AXE CO., Gladstone, Mich., U. S. A.



PATENTS

Quickly secured. **OUR FEE DUE WHEN PATENT OBTAINED.** Send model, sketch or photo. with description for free report as to patentability. **48-PAGE HAND-BOOK FREE.** Contains references and full information. **WRITE FOR COPY OF OUR SPECIAL OFFER.** It is the most liberal proposition ever made by a patent attorney, and **EVERY INVENTOR SHOULD READ IT** before applying for patent. Address:

H. B. WILLSON & CO.
 PATENT LAWYERS,
 LeDroit Bldg., WASHINGTON, D. C.

No Other Reel Will Give

Satisfaction after you have seen the

"TALBOT"

A thing more perfect was never wrought in metal. In tournaments always a victor. Among fishermen's treasures, the chief.

Send for Booklet F:

W. H. TALBOT, Nevada, Mo

PAROID ROOFING

"IT LASTS"

If you are looking for a roofing that is better than shingles for your camp, you will find Paroid does the work. Each roll a complete roofing kit, and anyone can apply it.

F. W. BIRD & SON

Mills and Main Office

East Walpole, Mass., U.S.A.

New York Chicago



The most artistic and durable color effects on shingles are produced with Shingletint, which is a scientific combination of linseed oil, coloring matter, creosote and the necessary drying agents.

Among the many shingle stains offered Shingletint is conspicuous not only for its superiority but because it can be called for by its distinctive name, thus offering the consumer protection against inferior goods offered for the same purpose.

When buying Shingle Stains it will be worth while to ignore the "just as good" argument and insist upon Shingletint.

Stained woods and descriptive literature sent free upon request.

BERRY BROTHERS, Limited,

Varnish Manufacturers,

NEW YORK PHILADELPHIA CHICAGO ST. LOUIS
BOSTON BALTIMORE CINCINNATI SAN FRANCISCO

Factory and Main Office, DETROIT

ATTENTION BASS FISHERMEN!!

What It Is. A Bass lure combining all the good points of the old fashioned spinner baits with the construction of the modern wooden minnow.

What It Will Do. This lure is constructed in a new manner with a new feature and will catch more bass than any other artificial lure.

How To Get It. Send one dollar to Recreation for a year's subscription to be credited to my account and I will mail you one postpaid. **W. B. HAYNES, 274 Park Street, Akron, Ohio.**

THE HILDEBRANDT SPINNER



For Fly Fishermen. A spinner which spins, and also catches fish. Strictly hand-made and of the best material. No swivel required. Made with all kinds of Feather and

Buck-tail flies. For sale by dealers. Sent on receipt of 25c.

J. J. HILDEBRANDT, Logansport, Ind.



BOAT BUILDING SYSTEM.

23 ft. Long. 5 1/2 ft. Beam To build this boat requires 250 ft. of Oak, 475 ft. of Pine or Cypress, \$4.50 in hardware and paints, and a set of our \$15. Patterns. We sell Row Boat Patterns for \$3. Our Printed Patterns are actual size of each piece and include a complete set of working illustrations and instructions by which anyone can build a Launch or Row Boat for one-tenth the factory price. We build completed boats and knock down frames. Particulars, address **BROOKS BOAT MFG. CO. Ltd., BAY CITY, MICH.**



AUTOMATIC REELS

do what no ordinary crank reel can possibly do—keep your fish from getting the least bit of slack line. Ever

see a man who could move as quickly as a wide-awake trout or bass? Guess not! First thing you know Mr. Fish drops your hook and away he goes. But a "Y and E" Automatic Reel is built to

PREVENT LOST FISH



"Auto-matic Combination," Style B, Diameter 3 3/8 in. Weight 11 oz. Carries 300 ft. No. 5 silk line. Winds 90 feet automatically without rewinding. Price . . . \$8.00 at your dealers, or sent postpaid anywhere in the U. S. or Canada. Four other styles.

\$8.00

by automatically keeping the line taut all the time. That gives you a chance to play your fish, to have all the sport there is in it. We give three money prizes for grown-ups and two for young people not over 16, for best catches made with "Y and E" Automatic Reels during 1903. No "entry fees." Write today for free Contest

blank and handsome catalogue "299 R."

YAWMAN & ERBE MFG. CO.
ROCHESTER, N. Y.

"The Little Finger Does It."



Fine Fishing Tackle Free

The Famous Shakespeare Reels and Baits That Catch Fish, Free on Trial to Any Enthusiastic Angler Who Sends Name and Address.

I want every enthusiastic fisherman, whether amateur, beginner or professional to have a personal knowledge of the fine points of the Shakespeare Reels and the marvelous catching qualities of the Shakespeare Baits—and to do this I propose to send to every man or woman who fishes for the real sport there is in it, one of my reels and baits for free trial on their next fishing trip. Write to-day. Send your name and address and the name and address of the leading sporting goods dealer of your city to Wm. Shakespeare, Jr., 254 Shakespeare Bldg., Kalamazoo, Mich. The Shakespeare Reel is especially designed for accurate and long-distance casting, and it is without doubt the best reel in the world, and you will say so when you see it. The metal used in the manufacture of the Shakespeare Reel is hard-drawn brass and the finest English Stubbs steel—the best obtainable. Painstaking care is used to secure perfect accuracy in every detail. In beauty of design, and simplicity of construction it is unequalled. Its easy, silent running suggests perpetual motion and it is fitted with the most perfect drag and click ever invented. Words will not describe its

beauty, its usefulness and its many advantages over all other reels. My reels and baits are for sale by all first-class dealers, but I want you to see them and try them for yourself and I will send them to you direct, express prepaid, for a free trial on your next fishing trip. The Shakespeare Baits are really marvelous. With them the fisherman is sure of a good catch, no matter where the fish are, in the lake or stream. If they are in deep water, Shakespeare makes the bait that attracts them. If they are in shallow water, Shakespeare makes the bait that catches them. If they are hidden in the lily pads or moss, Shakespeare makes the bait that makes them strike. And Shakespeare offers \$100 in prizes for the photograph and authentic dimensions of the biggest large or small mouth bass caught this year. Write to-day for particulars. His little booklets, "How to Catch Bass," "Fine Points about Tackle" and "The Art of Bait Casting" are free to every angler. Write to-day and send your name and address.

THE "BRISTOL"

STEEL FISHING RODS

HAVE BECOME A STAPLE NECESSITY.

As they are made in twenty-five different styles and sizes weighing from 6½ to 11½ ounces, there is a wide range of choice. Fisher-men—and women, too—are delighted with their action, and are pleased to recommend them. Send for our FREE CATALOGUE, and learn what it tells—then buy a rod and see what it will do. Address

The Horton Mfg. Co.
No. 73 Horton Street,
Bristol, Conn.



WITH THE YOUNG LADY SAID.

IT NEVER FAILS

The S. & W. Artificial Bait



Is the most successful bait made. When in motion it resembles a minnow so closely that it never fails to delude the fish.

Its construction makes it almost impossible for a fish to strike and not get caught.

A GREAT SELLER

Do you fish? Buy one. You will never be without one afterward. Why? It will catch fish. Can be used with rod or hand line.

Dealers send for illustrated booklet and get our prices.

If your dealer cannot supply you, send 50c. at once for one (post paid) to

STARK & WECKESSER

57 S. Main St. : : : DAYTON, OHIO, U. S. A.

Small Profits—Quick Sales

TROUT FLIES



for trial—send us

- 15c for an assorted sample doz. Quality A Flies
Regular price, 24 cents.
- 30c for an assorted sample doz. Quality B Flies
Regular price, 60 cents.
- 60c for an assorted sample doz. Quality C Flies
Regular price, 84 cents.
- 60c for an assorted dozen Bass Flies
Regular price 84 cents.

SPLIT BAMBOO RODS

Fly Rods 10 feet, 6 ounces **57 cents** Bait Rods 9 feet, 8 ounces

With cork grip and extra tip, in wood form

Try our new Braided Silk Enameled Waterproof

METAL CENTER LINE

Size No. 5, 4½ cents per yard. Size No. 4, 5½ cents per yard.
Put up in 10-yard lengths connected.

THE H. H. KIFFE CO.

523 Broadway, New York City

Catalogs of any of above goods free on application.
Mention RECREATION.

Patent Independent Level Winding Device

Patented Jan. 13, 1903.

Below we quote the following delivered price on guaranteed strictly high-grade quadruple casting reels, with even spooler attached. They are strong cut gear, light running, and as fine outside and in as a watch, and should last a lifetime.

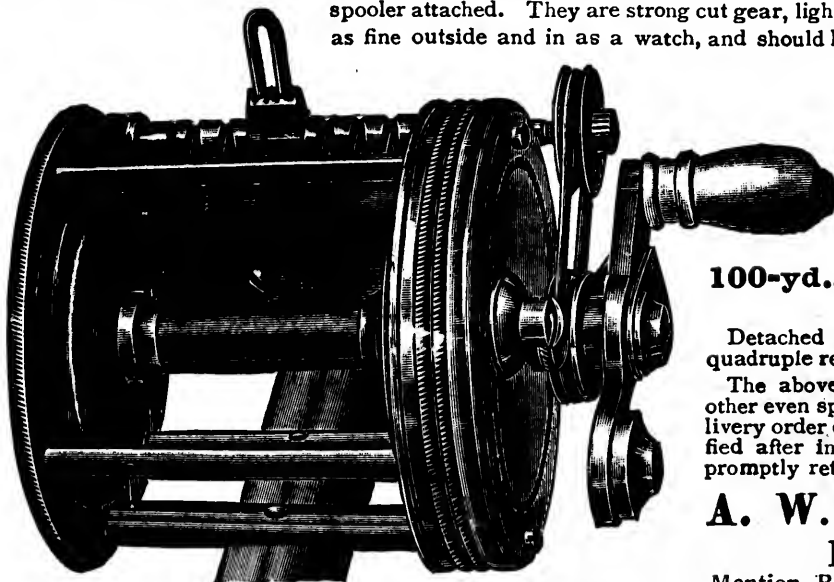

Jeweled Bearing:

100-yd., \$6.75

80-yd., 6.50

60-yd., 6.00

Stubs Steel Pivot Bearing:

100-yd., \$5.75. 80-yd., \$5.50
60-yd., \$5.00

Detached even spooler for such old or new quadruple reels as they will fit, . . . \$2.50

The above prices are less than half of any other even spooling reel. To insure prompt delivery order early. If you are not perfectly satisfied after inspection, return to us and we will promptly return your money. Catalogues free.

A. W. BISHOP & SON,

RACINE, WIS.

Mention RECREATION.

WHEN ANSWERING ADS ALWAYS MENTION
RECREATION

SAILING. CAMPING. PROSPECTING. FISHING. HUNTING.

Established 1840
GEO. B. CARPENTER & CO.
 MAKERS OF HIGH GRADE
**TENTS, SAILS
 CAMP FURNITURE**

Folding Cots
 Tables and Chairs

Oars, Paddles
 Marine Hardwar

copyright 1899
 Geo. B. Carpenter & Co.

**The Largest and Most
 Complete Stock in the U. S.**

Send 4c. in stamps for Tent and Camp Catalogue, or
 6c. in stamps for Marine Hardware Catalogue.

200, 202, 204, 206, 208 S. Water St.
CHICAGO, ILL.

WHITESTONE HOLLOW SPAR AND BOAT CO.

Successors to

The Spalding St. Lawrence Boat Co.,

Builders of

- The FAMOUS St. Lawrence River Skiffs
- Cedar Canoes
- Canvas Covered Cedar Canoes
- Speed Launches
- YACHTS' DAVIT BOATS

Makers of

Send for Spar Book-
 let No. 4.



**SKIFF, ROWBOAT and CANOE
 CATALOGUE No. 5.**

WHITESTONE HOLLOW SPAR AND BOAT CO

J. G. FRASER, Manager

Whitestone Landing, Long Island, N. Y.

Handsome
Boats

Perfect running
Motors

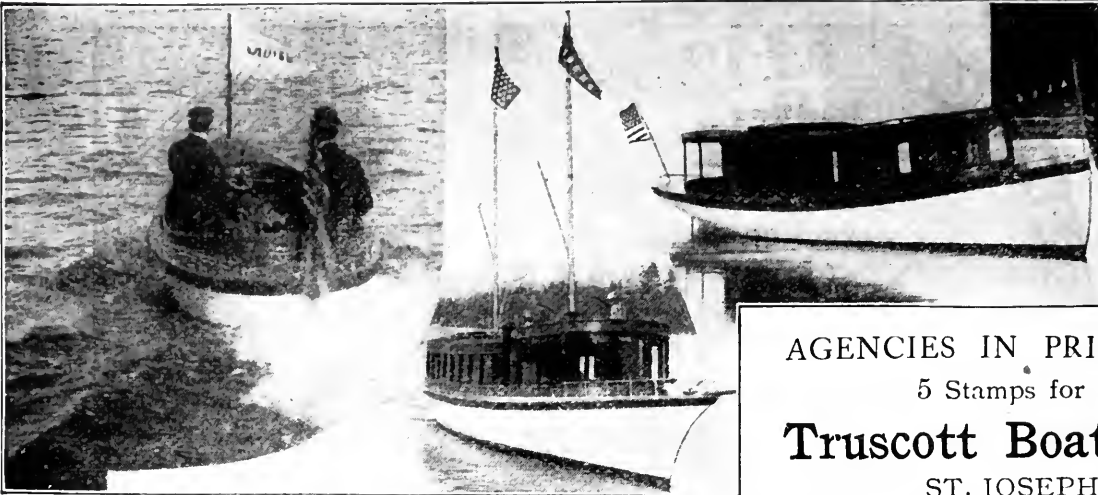

AGENCIES IN PRINCIPAL CITIES

5 Stamps for Catalogue

Truscott Boat Mnfg. Co.

ST. JOSEPH, MICH.

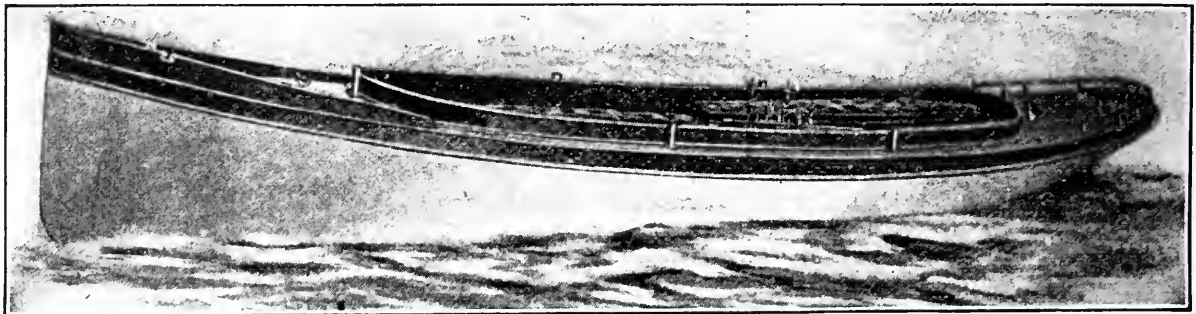

LEAMAN BOAT COMPANY

WINNECONNE, WIS.

Manufacturers of Gasoline Launches, Sail, Row, and Hunting Boats. Our prices are low, our work guaranteed. Launches, \$150 up. Row Boats, \$22 up. Hunting Skiffs, \$20 up. The oldest Boat Company in the State. Write for Wants. Mention RECREATION.

FOLDING CANVAS BOATS were not satisfactory until the

K I N G

was produced. It's a revelation in boat construction, nothing like it ever



11-foot Special

made. *Nonsinkable. Can't tip over. Puncture Proof*, wear longer than a wooden boat. No repairs. No cost for storage, always ready, folds into a small neat package, carry by hand, used by the U. S. Navy. They are simple, wonderful. A thoroughly patented article. Beware of imitations. Made only by ourselves. *A catalog of 70 engravings and 350 testimonials sent on receipt of 6 cents.*

Bottom Boards rest on the frame not on the canvas, ribbed, longitudinally and diagonally. They are *stiffer and safer* than

a Wooden Boat because the lines are fuller, and are much easier to row or paddle.

KING FOLDING CANVAS BOAT CO.

Mention RECREATION.

KALAMAZOO, MICH., U. S. A.

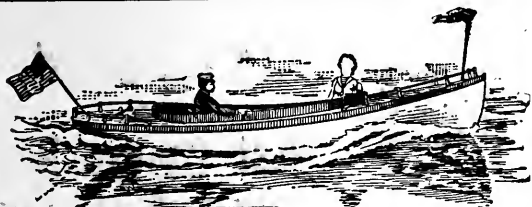

**BULLARD STEEL LAUNCHES,
ROW AND PLEASURE BOATS,
ARE EVERLASTING!**

Safer than wood; have greater carrying capacity; always dry; no bolts or nails to rust.

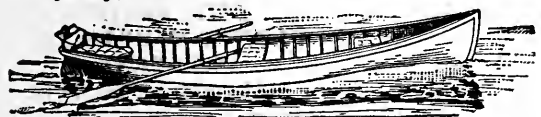

Boat Liveries equipped with the Bullard Steel Boats. Always have dry boats, that last a lifetime.

STEEL BOATS CHEAPER THAN WOOD.

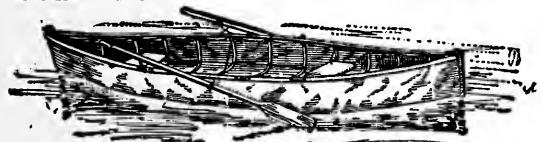

THE OSGOOD FOLDING CANVAS BOATS

Original Canvas Boat; made for 30 years. Sold all over the world; used by U. S. Government; best Fishing and Hunting is where there are no boats, take one with you in trunk or bag. Non-puncturable. Folded or extended in one minute.

Send for catalogue illustrating all improved popular designs of Steel, Wood, and Canvas Boats, and Marine Engines.

**MICHIGAN CONSOLIDATED BOAT CO., LTD.
505 Main St., Battle Creek, Mich.**

WANT A REEL?

You can get one for nothing.
Or at least for a few hours' work.

Send me

15 Yearly Subscriptions

to

RECREATION

and I will send you

A TALBOT REEL

Listed at \$20.00

Made by W. H. Talbot, Nevada, Mo.

This is one of the finest pieces of fishing tackle ever made. It is built like a gold watch. Equal to any Kentucky reel you ever saw.

**In To rnaments, Always a Victor
Among the Angler's Treasures, Always the Chief**

I have but a few of these reels in stock and this offer will be withdrawn as soon as the present supply is exhausted.

Sample copies of RECREATION for use in canvassing furnished on application.

**RUSHTON
CANOES**

Are Tried and True

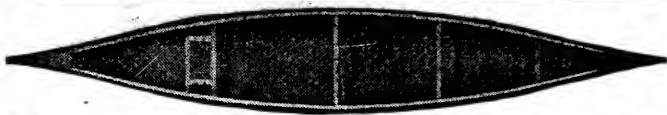

**Indian Girl
Model**



**15, 16, 17, 18
Feet**

Northern White Cedar, Canvas Covered, \$30 to \$43

Will be very popular this season. They are as thoroughly well made in every particular for their class as my all-cedar boats, with a considerable saving in cost to the purchaser.

An experience of nearly thirty years enables me to furnish better boats for the same money than can be had anywhere else.

Write for my complete catalogue of pleasure boats, canoes and fittings — sent FREE

J. H. RUSHTON, 817 Water St., Canton, N. Y.

FAY & BOWEN

Motors & Launches

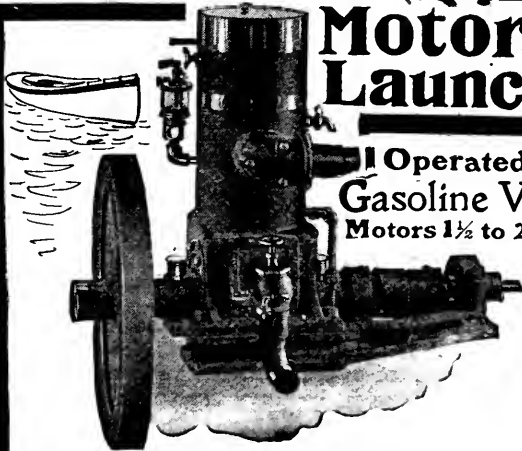

Operated by
**Gasoline Vapor
Motors 1½ to 25 H.P.**

THE Fay & Bowen Marine Motor is a revelation to those who have used others. Reliable, safe, durable and easy to operate. Remarkable speed control. Best of all, it starts when you start it. No handle or crank is used. Our patent ignitor is absolutely unique and always instant and positive in action. It is really the only perfect and satisfactory ignitor.

Motors complete from 1½ to 25 H. P. ready for installation. We also build handsome launches with motors installed and ready to run.

Send for Catalogue.

Fay & Bowen,
28 Mill Street, Auburn, N. Y.

Latest patent and improved Canvas Folding Boat on the Market.



Puncture proof. Tempered steel frame. No bolts to remove. Folds most compact of any boat made.

THE
Latest, Safest,
AND
Best Canvas Boat

Is what we offer you. A Boat built on modern lines that will prove a pleasure to own and use. Selected materials used throughout, and it comes to you **guaranteed** the best. A handy and safe boat for fishing and shooting. Write for descriptive circular and catalog.

Mention RECREATION.
LIFE SAVING FOLDING CANVAS BOAT COMPANY
Kalamazoo, Michigan

IT PAYS TO BE PARTICULAR IN BUYING A BOAT

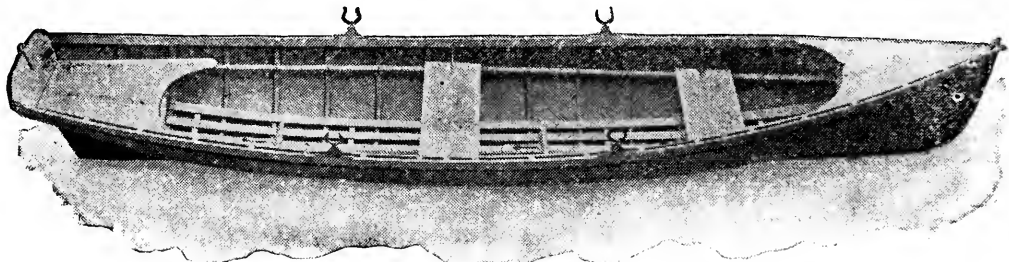

MULLINS' STEEL BOATS

New designs, carvel built—Air chambers—Low in cost—Will last a lifetime. No calking—No drying out—Always ready for use. Send for a copy of our **NEW CATALOGUE** with full information.

W. H. MULLINS, 228 Depot Street, **SALEM, OHIO.**

Sportsman's Electric Flashlight

Will show up a coon in the tallest tree. Brilliantly lights up hollow tree, burrow or cave.

Invaluable about the camp or in the stable where lamp or candle would be dangerous. No wires or chemicals

Powerful, compact convenient Can be carried in pocket.

Good for **5000 Flashes** without renewing battery

American Electrical Novelty and Mfg. Co.
Dept. A. Hudson & Spring Sts., New York



Price, **\$2.00** complete.

Extra batteries 30 cents. Catalogue of novel and useful electrical articles free.

Points on Angling

More complete than ever before

The Habits and Haunts of

GAME FISH

and How to Catch Them

Mailed free on application

THE SPECIALTY MFG. COMPANY
Box 62a, Goshen, Indiana



MARINE GAS ENGINES

Experts for years have ranked our engines with the highest grade, and it is now being copied by other builders. We always endeavor to be on top and for 1903 offer an engine built from brand new patterns, with **NEW** and **ORIGINAL** features—just what other engines will have five years hence.

If you want to be in the lead send for catalog fully describing all parts, and then buy a "Rochester".

ROCHESTER GAS ENGINE CO.
700 Driving Park Ave. Rochester, N. Y., U. S. A.

For Exchange: Ithaca hammerless gun, 12 gauge, 28-inch Damascus barrels, first-class condition, listing at \$50, for 16 gauge gun, equally good make and quality. **LINN BROWN,** Oxford, O.

For Sale: A 1½ H. P. Electro-vapor Marine Motor, very cheap. **F. G. WINTER,** 18 Patchen Avenue, Brooklyn, New York.



U. S. Government who prefer our boats. If you investigate we will get your order.

Send for catalogue of our full line of Folding Canvas Boats and Canoes, which have been adopted by Governments of United States, Canada and England. Just filled an order for Received medal and award at Chicago World's Fair.

Mention RECREATION.

Acme Folding Boat Company, Miamisburg, O.



"ZORADA"

Standard Marine Engines

10 h. p. to 75 h. p., two, three and four cylinders. Cruising Yachts, Auxiliaries, Launches and Working Boats. The most effective engine made. *Smooth Running, Safe, Positiveness in Action, Simple, Economical.* Send for our illustrated book.

United States Long Distance Automobile Co.

307 WHITON STREET, JERSEY CITY, N. J.

PALMER

Gasoline Engines and Launches

MARINE and STATIONARY ENGINES

of both two and four cycle type in stock

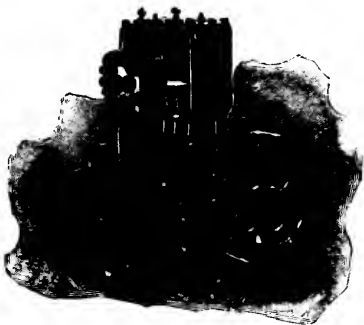

17 foot Launch 1½ H. P. Motor, \$200.

20 foot, 3 H-P. \$325.

25 foot, 5 H-P. \$500. in Stock

WRITE FOR CATALOG.

Mention Recreation

PALMER BROS., - Cos Cob, Conn.

NEW YORK OFFICE: 136 Liberty Street

D.M. TUTTLE CO. 10 PINE STREET CANASTOTA, N.Y.

CATALOGUE
FREE.

BREAK SPARK. GASOLINE ENGINES & LAUNCHES. JUMP SPARK.

LOZIER

GAS ENGINES and LAUNCHES

The LOZIER MOTOR CO.
PLATTSBURG,
N.Y.

BRANCHES:
NEW YORK, 1 BROADWAY.
BOSTON, 185 SUMNER ST.
PHILADELPHIA, 22 RICE ST.

Solar Lamps
 OIL SIDE-LIGHTS GAS HEAD-LIGHTS
"SHOW THE WAY"
 CATALOG OF LATEST MODELS SENT ON REQUEST
BADGER BRASS MFG. CO.
 KENOSHA, WIS.
 EASTERN BRANCH 11 WARREN ST. NEW YORK

Swedish COLLAN OIL
 Waterproof LEATHER DRESSING AND RUST PREVENTER
"Collan-Oil"
 preserves leather and renders shoes and harness positively **WATERPROOF**
 Used by the U. S. the Army and Navy, and National Guard
 Send 25c. for trial can. **AGENTS WANTED**
 Write for terms and circulars
J. R. BUCKELEW
 Dept. A. 111 Chambers St., N. Y.



ANGLING FOR
Salmon
Trout
Black Bass
Tarpon
AND ALL OTHER GAME FISH

is fully described and beautifully pictured in our new 128 page catalogue of

FISHING TACKLE

It is a fine specimen of angling literature and is sent free to all who write for it.

WILLIAM MILLS & SON
 21 and 23 Park Place New York

SOME GOOD GUIDES.

Following are names and addresses of guides who have been recommended to me, by men who have employed them; together with data as to the species of game and fish which these guides undertake to find for sportsmen.

If anyone who may employ one of these guides should find him incompetent or unsatisfactory, I will be grateful if he will report the fact to me.

ALASKA.

Edwin Edelman, Kenai, Cook's Inlet, moose, bear, caribou, mountain sheep, ducks, grouse and trout.

FLORIDA.

Carson Bros., Frostproof, bear, deer, turkeys, quail, snipe.

C. H. Stokes, Mohawk, deer, alligators, turkey, quail, and snipe.

IDAHO.

John Ching, Kilgore, elk, bear, deer, antelope, mountain sheep, trout and grouse.

Chas. Petty's Kilgore, ditto.

MAINE.

H. R. Horton, Flagstaff, deer, bear, moose, caribou, fox, grouse and trout.

W. C. Holt, Hallowell, moose, caribou, deer, grouse and trout.

NEW YORK.

Le Roy Still, Bayport, Long Island, ducks, quails, rabbits and grouse.

WYOMING.

S. N. Leek, Jackson, elk, bear, deer, mountain sheep, antelope, grouse and trout.

James L. McLaughlin, Valley, elk, bear, deer, mountain sheep, antelope, grouse and trout.

CANADA.

Wm. S. Andrews, Lillooet, B. C., deer, bear, mountain sheep, goats, grouse and trout.

B. Norrad, Boiestown, N. B., moose, caribou, grouse and trout.

Carl Bersing, Newcastle, N. B., moose, caribou, deer, bear and grouse.

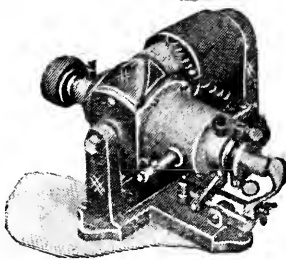

To Owners of Gasoline Engines, Automobiles, Launches, Etc.
The AUTO-SPARKER
 does away entirely with all starting and running batteries their annoyance and expense. No belt—no switch—no batteries. Can be attached to any engine now using batteries. Fully guaranteed; write for descriptive catalog—**Motsinger Device Mfg. Co.**
 75 Main Street, Pendleton, Ind.

AN IMPORTANT OFFER

For 2 Yearly Subscriptions to RECREATION

I will send you

A RIFLE WICK PLUG

Made by HEMM & WOODWARD, Sidney, Ohio, 30 caliber up to 50 caliber.

OR

A SHOT GUN WICK PLUG

20 gauge up to 10 gauge

For 3 Yearly Subscriptions to RECREATION

A Pair of Shot Gun Wick Plugs

20 to 10 gauge.

Sample copies for use in canvassing furnished on application.

Address **RECREATION, 23 W. 24th St., N. Y. City**



*The
Automobile
that solves the
problem*

of rapid, safe and pleasant motor travel on all kinds of roads and in all kinds of weather. Very powerful gasoline engine of new type; an entirely new transmission gear; perfect and very sensitive steering mechanism; powerful brakes that cannot fail to act. Simplicity joined to durability; speed united with safety; strength wrought in grace. Runabout body for two, \$750; with detachable tonneau, making a luxurious touring car, \$850. Our free illustrated booklet K gives address of agency nearest you where the Cadillac may be seen and tried.

CADILLAC AUTOMOBILE COMPANY, Detroit, Mich.

\$50 BUYS A RUNABOUT

**Full
Bike
Gear**

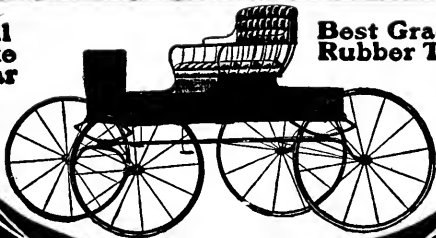

**Best Grade
Rubber Tires**

**SAVE
DEALERS
PROFITS**

The rapid increase in the volume of our business and the vast number of satisfied customers on our books prove we can serve your interests best.

We manufacture a full line of Buggies, Carriages, Wagons and Harness of very superior

**Quality—Style
Durability and Finish**

These four essentials are to be found in every vehicle and set of harness sent out by us. We employ only skilled mechanics in all departments and furnish them with the very best materials. With the entire output of two enormous modern factories and superb shipping facilities at our disposal, we are able to furnish high-grade vehicles at prices that—quality considered

Positively Defy Competition.

All goods guaranteed and shipped on approval. Money back if you are not satisfied. Write at once for our catalog and special inducement, it will interest you.

UNION BUGGY COMPANY, 495 Saginaw Street, Pontiac, Mich.

**Kerosene OIL
STOVE**

BLUE FLAME

Size, 8½ x 8¼

Price, \$3.75

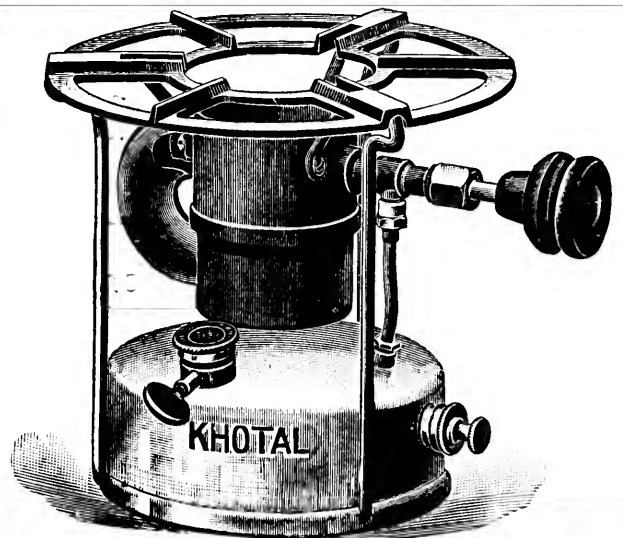

FOR CAMPING AND YACHTING

Odorless and wickless. Best in the World for Cooking—you can regulate it to any temperature Made in all sizes. Send for descriptive catalog

THE KHOTAL BURNER CO.

197 Fulton St., New York

Every Sportsman

Every Prospector

Every Surveyor

Every Timber Hunter

Every Explorer

Who goes into the woods or the mountains should carry one of

MARBLE'S POCKET AXES

This is the most convenient and useful tool ever invented for such men.

It is as important as a hunting knife, and almost as much so as a match box. This Ax is

neat, light, safe and effective.

You can do more things with it than with any other one instrument known to the craft.

I have made an arrangement with

W. L. Marble, Gladstone, Mich.,

The Maker of this Ax,

which enables me to offer, for a short time, one of these axes as

A Premium for Three Subscriptions to RECREATION.

This is

Another Great Opportunity

and should be taken advantage of *at once* by every woodsman who is not already supplied with one of these handy tools.

Sample copies of RECREATION for use in canvassing furnished on application.



START the season right by owning a J. C. Hand Trap. Most convenient little trap ever made. NO need of Gun Club grounds—any vacant field will do. No pit to dig, no stakes to drive. It is always ready and does not get out of order. Weighs but 6 lbs. and is handsomely finished. Sent by prepaid express on receipt of price, \$4.

Newhouse Traps

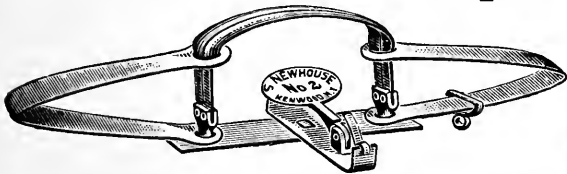

THE STANDARD FOR OVER FIFTY YEARS

Used by all professional hunters and trappers, who find that

The Best Trap is the Cheapest

Complete illustrated catalogue on application.

ONEIDA COMMUNITY, LTD., Kenwood, N. Y.

KOENIG'S SHELL EXTRACTOR.



Every shooter should have one—carry it in a vest pocket. Fits any gauge shell. Koenig's Gun Catalogue, Free.

10 Cts. Postpaid.

E. G. KOENIG, NEW JERSEY'S LARGEST GUN HOUSE
SOUTH BROAD ST., NEWARK, N. J.

THE BRADLEY SHOT GUN SIGHT



The Bradley system of sighting shot guns is a radical departure from the old methods, and makes wing shooting easy and certain. There are two beads, one for each barrel, and instantly attachable to the gun in such a manner that there is no interference with the sight originally on the rib. Shooting at stationary objects or straight-away birds the beads plainly define the killing circle of the arm, since a bird seen between them, if not out of range, will certainly catch a good portion of the charge. But it is in the crossing shots that the Bradley sights are most valuable. All double barrel shot guns cross the central line at about thirty yards, beyond which the right barrel throws to the left and the left barrel to the right. Sighting directly down the barrel fired compensates for this, but there is still a difficulty of judging how much to lead crossing birds, and some shooters are never able to get the knack of doing this correctly. With the Bradley Sight it is only necessary to aim at a left flyer down the barrel and fire the right, or reverse in case of a bird crossing to the right, which gives the proper lead and will almost invariably insure a kill. With this sight anyone can very soon become a good wing shot.

PRICE 50 CENTS POSTPAID

Invented by C. L. BRADLEY, Clarksville, Tenn.

IF YOU SEE

A KEG OF POWDER

The Chances are It's

DU PONT

GENUINE

BLAKE, LAMB & CO.

ANIMAL TRAPS

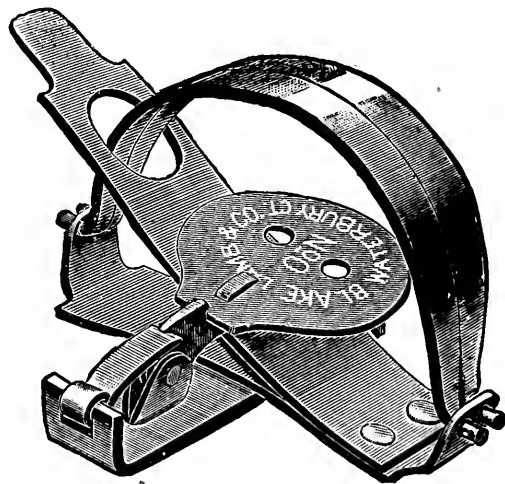

For Woodchucks, Skunks, Mink, Muskrat.
Gophers and all mischievous night prowlers set a Blake & Lamb Trap.

Lightest, Smallest and Strongest Trap Made.

25 cents in 5 cent stamps for a sample Trap and Catalog to

THE HAWKINS CO.,
SOUTH BRITAIN, CONN.

Mention RECREATION.

Do You Want a Gun?

Send me 30 yearly subscriptions to
RECREATION and I will send you a

No. 1 Double Barrel Breech Loading Gun

Made by the Ithaca Gun Co.
and Listed at \$40

I have contracted for 20 of these
guns at a price which enables me to
offer them as above, and they will
doubtless all be taken within the next
3 months.

If You Want One Get Busy at Once

Sample copies of RECREATION for
use in canvassing furnished on application

RECREATION, 23 West 24th St., New York.

THE "BROWNIE" RIFLE



**SIMPLE, DURABLE, RELIABLE,
AND EXTREMELY ACCURATE.**

Popular with the Boys because of its Superior Shooting Qualities, Light Weight, and Special Features of Construction.

Furnished in 22 caliber only. Weight $4\frac{1}{4}$ to $4\frac{1}{2}$ pounds. It is supplied by RECREATION as a Premium. Write for Catalogue

The W. H. Davenport Fire Arms Co., Norwich, Conn.



**We make a specialty of Featherweights
and Trap Guns with our new
SINGLE TRIGGER**

**Guaranteed
Perfect**

**Our New
Perfect
Gun Cleaner
By Mail,
30 Cents**

Send stamp
for 1903 Catalogue
Mention RECREATION

D. M. LEFEVER SONS & CO.,

Manufacturers of the "NEW LEFEVER"

Not connected with Lefever Arms Co.

SYRACUSE, N. Y.

**Practical Common Sense
in 6 Sizes.**

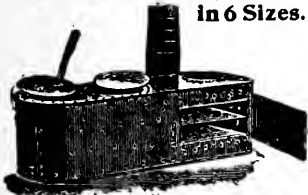

CAMP STOVE

Either with or without oven. The lightest, strongest, most compact, practical stove made. Cast combination sheet steel top, smooth outside, heavy lining in fire

box and around oven, holds its shape, telescopic pipe carried inside the stove. Burns larger wood and keeps fire longer than any other. Used by over 9,000 campers and only one stove returned.

For catalogue giving full particulars, mention RECREATION and address.

D. W. CREE, Manufacturer, Griggsville, Ill.

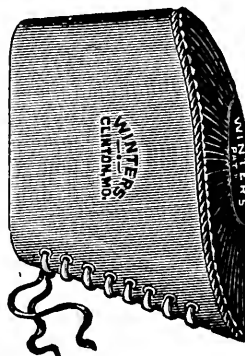

\$40,000 Given Away

Five free coupons with each order for one of the 1902 Model leather-covered pneumatic recoil pads. No Pump, No Valve, No Recoil, No Flinch, No Headache, No Bruised Shoulders. Perfect Score.

PRICE \$2.

J. R. WINTERS, Clinton, Mo

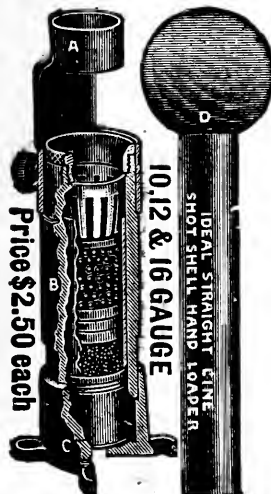

Price \$2.50 each

10, 12 & 16 GAUGE

IDEAL STRAIGHT LINE
SHOT SHELL HAND LOADER

There is **ECONOMY** and **PLEASURE**

in *Loading and Re-Loading* your own *Shot Gun Shells* if you have the proper implements. There is an entire line of

NEW TOOLS UP TO DATE

for this purpose *Now Ready*. Full description and prices of all will be found in our new booklet entitled "*Hints on Loading and Reloading Shot Gun Shells*," which will be sent to any address upon application to

IDEAL MANUF'G CO., 12 U St., New Haven, Conn., U. S. A.

THE PHIL. B. BEKEART CO., of San Francisco, Cal., Agents for Pacific Coast.

When you write please mention Recreation.

STILL ANOTHER GREAT OFFER

Send me 25 yearly subscriptions to
RECREATION and I will send you

A Grade 00 Syracuse Gun

Listed at \$30.

I have contracted for 20 of these
guns at a price which enables me to
offer them as above, and they will
doubtless all be taken within the
next three months.

If you want one of the Guns get a move on you

Sample copies of RECREATION
for use in canvassing furnished on
application

RECREATION, 23 W. 24th Street, New York

H. & R.

"Bicycle Hammerless" Revolver

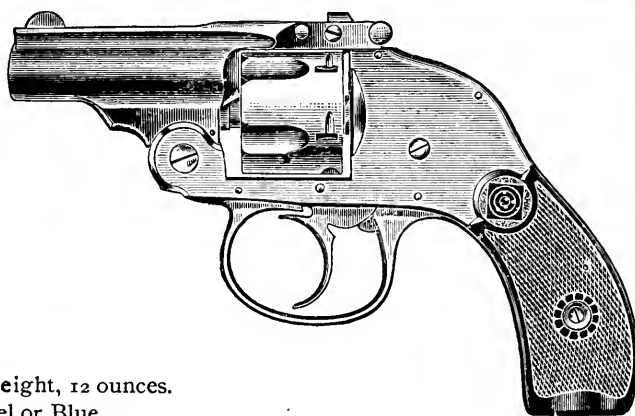

Description

32 Caliber, 5 shot. 2 Inch Barrel. Weight, 12 ounces.
C. F., S. & W. Cartridge. Finish, Nickel or Blue.

IMPOSSIBLE TO CATCH on the pocket and discharge accidentally. **ABSOLUTELY SAFE.** Although designed for cyclists, this revolver is equally adapted to all cases where a small, light weight, effective and handy pocket weapon is desired. It has small frame and automatic ejector. Sold direct where dealers will not supply.

HARRINGTON & RICHARDSON ARMS CO.

Makers of H. & R. SINGLE GUNS

Catalog for Postal
Dept. R.

WORCESTER, MASS.

For Sale: A mounted elk head. Exceptionally good antlers. Selected from a stock of over 300 heads for its beauty and shapeliness. Address G. W. Dowe, Port Jervis, N. Y.

For Exchange: A set of 4x5 Turner-Reich Anastigmat Lenses in shutter for a good canoe. Must be in A1 condition. A. S. G. 11 Meigs Street, Rochester, N. Y.

Rifles and Shotguns Cannot Pit or Rust

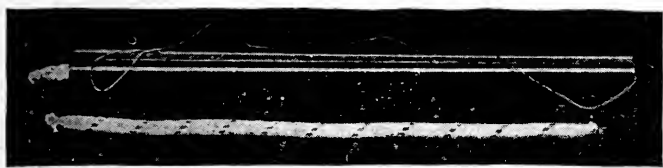

If Oiled **WICK PLUGS** are Used
30, .303, .32, .38, .44, .45 and .50 Caliber
10, 12, 16 and 20 Gauge.

Rifle Plugs, 75c. each, postage paid.
Shotgun Plugs, \$1 each, per pair \$1.75.

Give Length and Caliber.

Write for
Circulars **HEMM & WOODWARD, SIDNEY, OHIO**

THE PARKER AUTOMATIC EJECTOR



New York Salesroom, Send for Catalogue. **PARKER BROS.,**
32 WARREN ST. Mention RECREATION. Meriden, Conn.

WOLF SMOKELESS

A Bulk Powder made at the Walsrode Powder Mills.



The most pleasant, quickest, cleanest and cheapest Powder in the Market.

A 120 load can be shipped free anywhere in the U. S., (east of the Rockies) on receipt of 75 cents.

Schoverling, Daly & Gales

302-304 Broadway

New York

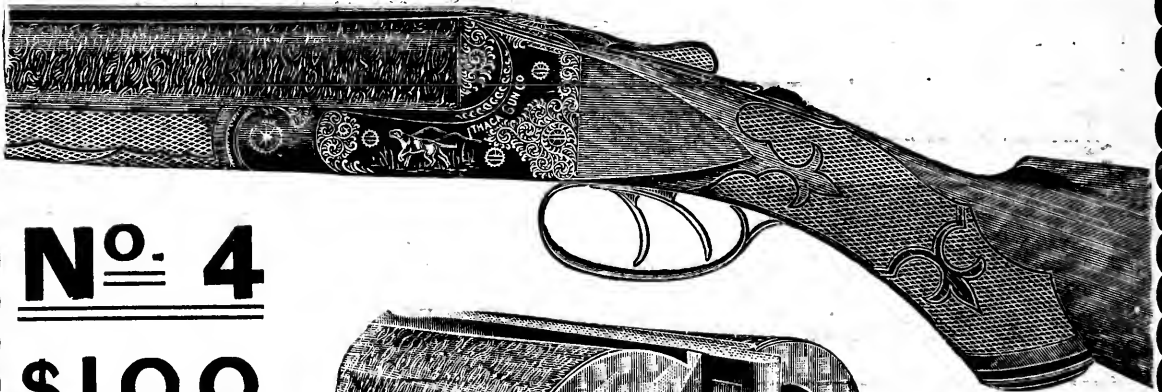

No. 4

\$100

LIST

ITHACA

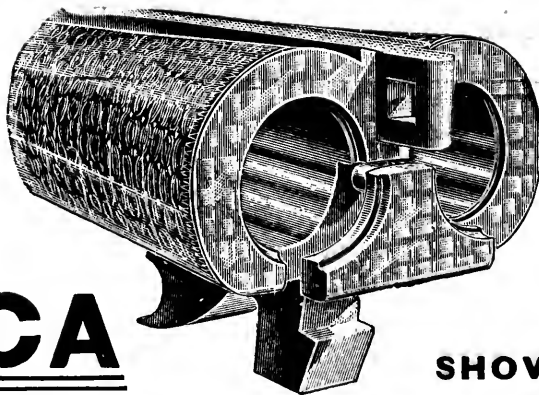

THE
**NITRO
BREECH**

SHOWING NEW
CROSS BOLT

GUARANTEED to be worth \$25.00 more than any other make of Gun at Same Cost.

Send for Catalogue Describing Sixteen Different Grades of Guns, Ranging in Price from \$19.50 to \$300.

ITHACA GUN CO., Ithaca, N. Y.

Mention RECREATION.

"HOPKINS & ALLEN" Single Barrel Shot Guns

(Made for any powder and good for any shot.)

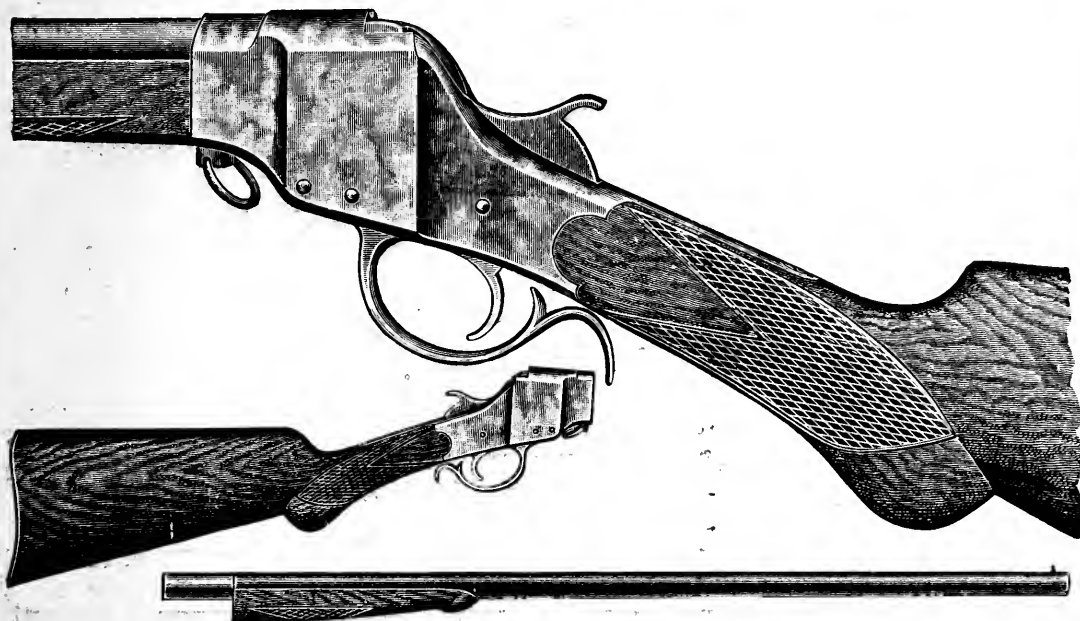

Our "Lever Action" has more friends than any single gun made, has stood the test of fifteen years' continued approval. Simple, durable and reliable, 12 and 16 gauge blued steel barrel..... **\$8.00**

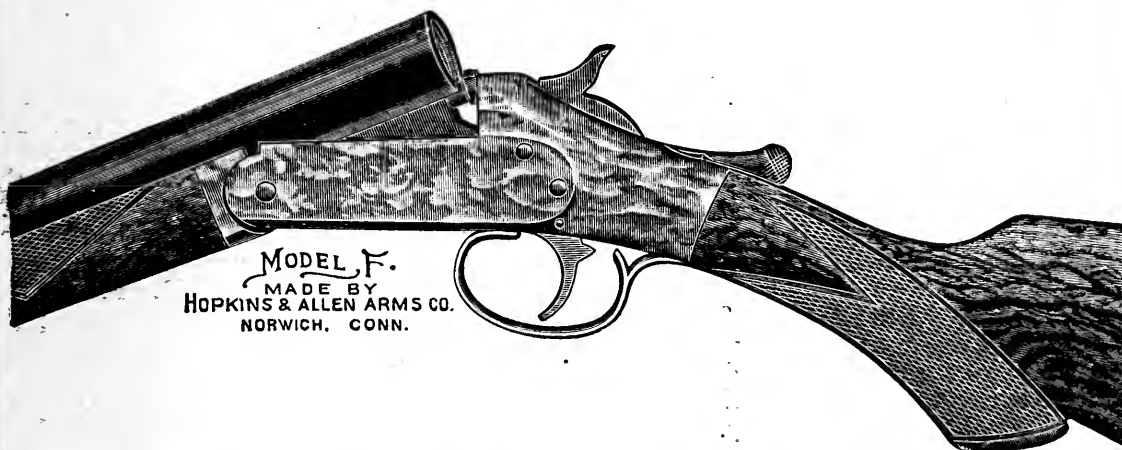

MODEL F.
MADE BY
HOPKINS & ALLEN ARMS CO.
NORWICH, CONN.

Our new model top snap action, combining all up-to-date features of a modern gun, including patent compensating snap fore end. Automatic shell ejector, **Full Choke Bored.** 12, 16 and 20 gauge decarbonized steel barrel **\$9.00**
12 and 16 gauge Stubbs twist steel barrel..... **\$10.00**

We will ship, all charges prepaid, on receipt of remittance with order, to any express office in the U. S. A.

The Hopkins & Allen Arms Co.,
NORWICH, CONN., U. S. A.

FINE GUNS

OUR SPECIALTY

SCOTT'S MONTE CARLO

Automatic Ejector Hammerless,

Established
1826

All the Prominent
English and
American Makes.

Also Westley Richards,
Greener, Purdy Lang, Parker,
L. C. Smith, J. P. Clabrough
& Johnstone, Ithaca, Baltimore
Arms Co, Forehand, etc

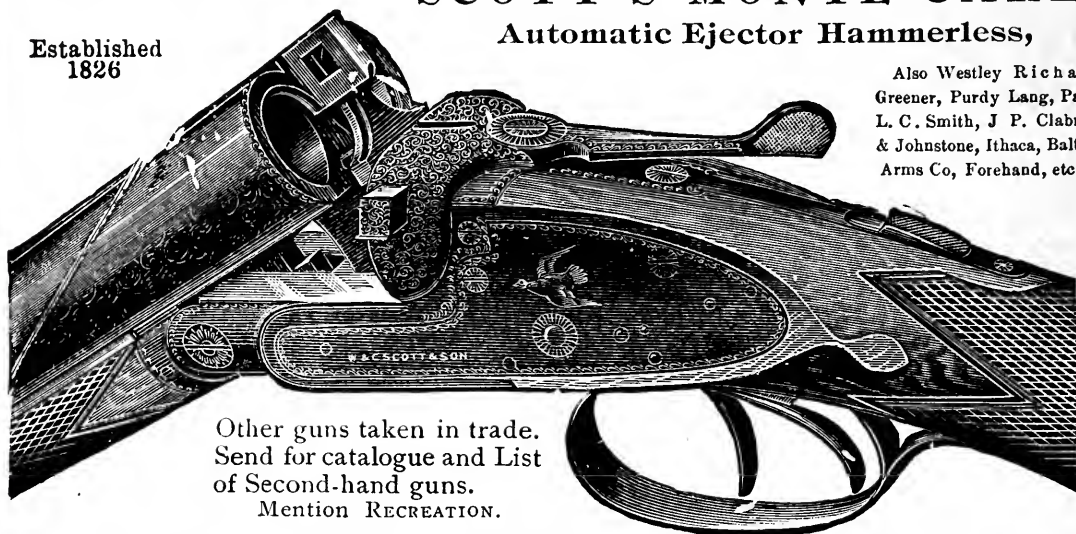

Other guns taken in trade.
Send for catalogue and List
of Second-hand guns.
Mention RECREATION.

SWEDISH LEATHER JACKETS

For Duck Shooting.

Soft as Kid.

Finest Quality, \$18.00

We take the entire product of the manufacturers of above Finest Jackets and this make cannot be obtained elsewhere in the United States

Gun Repairing

BY FIRST-CLASS GUN REPAIRERS
RESTOCKING, BROWNING, Etc., Etc.

Send for Catalogues

WM. READ & SONS,

107 Washington Street, BOSTON, MASS.

The Old Gun House. Established 1826

For Sale: 44 caliber Smith & Wesson, Russian, single action, plated revolver, 6½ inch barrel, in first-class condition; lists at \$25.66. Will send by registered mail anywhere in the U. S. for \$11. Also 6½-inch barrel, only for 44 Smith & Wesson Russian, \$2.50. A. A. Wawrzyniak, Berlin, Wis.

For Sale or Exchange: Fine 8-point mounted deer head and 14-point moose head. Want canvas boat, camera, books on ornithology, or offers. Box 613, East Sherbrooke, P. Q., Canada.

For Exchange: Bristol No. 4 Steel rod and Yawman & Erbe automatic reel, with 100 yards best silk line. Will pay difference for Savage or Winchester 30-30 rifle. All letters answered. C. F., Sunday, Hayti, S. D.

For Sale: A fine location for sportsmen's hotel and winter resort in Florida, 3 miles from Osprey; 38 acres with 2,000 feet frontage on Little Sarasota Bay and ¼ mile from Boca Grande. Extension of Seaboard Air Line Railway. Buildings and fruit trees. Best of fishing, including tarpon, and game plenty. Write for full description and price. Dr. J. H. Bissell, Sarasota, Fla.

For Sale: Marlin repeating shot gun. Good as new. Will take \$15 and Vibe M. P. C. magazine camera; new; 12 exposures. Omer L. Wood, R. F. D. 1, Pennville, Ind.

For Exchange: Moose head, in good condition, for a Goerz field glass or some make of equal value, or a good hammerless gun. J. W. B., care of RECREATION.

THE BAKER

THE GUN
THAT'S SAFE

SO DURABLE TOO
IT LASTS A
LIFETIME



If you want to be right up in the front rank of style and efficiency shoot one of our Special Paragons with Whitworth or Krupp fluid steel barrels. We have other patterns also that would please you. Our "Quarterly" tells about them and other matters that would interest you. We will send it to you free a year if you want it.

BAKER GUN & FORGING CO., 42 Liberty Street, Batavia, N. Y.

Guaranteed Not to Shoot Loose.

One of the **9**

"SYRACUSE"

Built for Business.

DAMASCUS BARRELS.

AUTOMATIC EJECTOR.

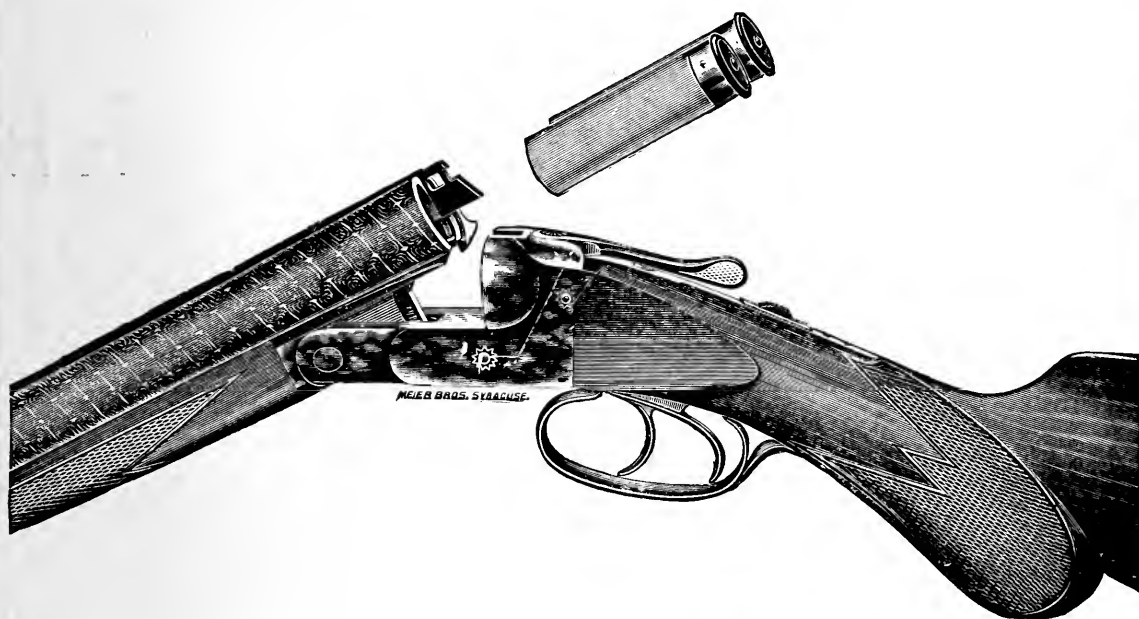

Grade 2 Ejector

\$50. LIST

Nothing Fancy—Makes no pretensions to beauty. It has that friendly way of coming up, that makes you feel that you have found it at last. And Shoot? Well it has all of the "Get There" quality of the "Syracuse."

Made in 20, 16 or 12 Gauge.

Ask your Dealer; if he is asleep, write to

SYRACUSE ARMS CO.,

SYRACUSE, N. Y.

Catalogue yours for the asking.

Mention Recreation.



It's Wrong to Stay Sick

Here is the utmost that medicine can do.
 I know it so well that I supply it on trial.
 All I ask is a postal card—no money wanted.
 You are wronging yourself by delay.

How Thousands Get Well.

I have actual records of over half a million chronic cases which I have cured in the past twelve years—cured them with my Restorative—cured them on just the terms that I offer you.

My offer is this:—

Simply mail me this coupon, or write me a postal stating which book you need. I will then mail you an order on your druggist for six bottles Dr. Shoop's Restorative. You may take it a month on trial. If it succeeds, the cost is \$5.50. If it fails, I will pay the druggist myself. And your word shall decide it.

My Restorative is the leading remedy of the world to-day. I have furnished it on those remarkable terms to nearly 550,000 people, and 39 out of each 40 have paid for it gladly, because they were cured. In practically every neighborhood everywhere there are cured ones telling others about it.

There are 39 chances in 40 that it will cure you, and I'll take the entire risk.

The Only Way to Cure.

In most chronic cases the only way to cure is to strengthen the *inside* nerves.

Remedies that merely doctor the weak organs may seem to bring brief benefit. But real results come only when we restore the inside nerves. This is the power which alone operates the vital organs. And no weak organ can do its duty until that nerve power comes back.

My Restorative does that—always. I have spent a lifetime in perfecting it for just this one purpose. It treats a weak organ as you would treat a weak engine—by giving it more power. It does all that is needed, and does that which must be done, whether the trouble is little or severe.

Cut Out This Coupon

For we all resolve to send for something, but forget. Mark the book desired and mail this with your name and address to

Dr. Shoop, Box 214, Racine, Wis.

Book 1 on Dyspepsia.

Book 4 for Women.

Book 2 on the Heart.

Book 5 for Men (sealed).

Book 3 on the Kidneys.

Book 6 on Rheumatism.

Mild cases, not chronic, are often cured by one or two bottles. At all druggists.

A bottle of
Pabst
Blue Ribbon

The purest and most
widely known brand
of beer in use.

Millions of bottles
annually consumed
by an appreciative
and critical public
in every part of the
civilized world.

TO SHOOT WHERE YOU WOULD
 HOLD A SAVAGE WHEN YOU SHOOT.



To select a fire-arm at haphazard may spoil the pleasure of your hunt. Certain rifle loads are designed purely for a given purpose, and a particular cartridge that is excellent for target work may be useless as a hunting load. Savage Hammerless Rifles are made in all the desirable standard sizes, and will give the hardest sort of accurate service. Write us—we may be of assistance in your selection.

Our new catalogue (G) is full of interest to sportsmen. Mailed on request.

Savage Arms Company, UTICA, N. Y.
 U. S. A.
 BAKER & HAMILTON, Pacific Coast Depot
 San Francisco and Sacramento, California.

Money to Cooks

**\$7,500.00 Donated, to be Divided
 Among Family Cooks.**

The sum of \$7,500.00 will be distributed between now and midsummer among family cooks, in 735 prizes ranging from \$200.00 to \$5 00.

This is done to stimulate better cooking in the family kitchen. The contest is open to paid cooks (drop the name "hired girl," call them cooks if they deserve it) or to the mistress of the household if she does the cooking. The rules for contest are plain and simple. Each of the 735 winners of money prizes will also receive an engraved certificate of merit or diploma as a cook. The diplomas bear the big gilt seal and signature of the most famous food company in the world, The Postum Cereal Co., Ltd., of Battle Creek, Mich., the well-known makers of Postum Coffee and Grape-Nuts. Write them and address Cookery Department, No. 119 for full particulars.

This remarkable contest among cooks to win the money prizes and diplomas will give thousands of families better and more delicious meals, as well as cleaner kitchens and a general improvement in the culinary department, for the cooks must show marked skill and betterment in service to win. Great sums of money devoted to such enterprises always result in putting humanity further along on the road to civilization, health, comfort and happiness.

Camp Cookery

A book containing numerous receipts, directions and helpful hints for the preparation and cooking of wholesome camp foods, fish and game.

A Complete Manual of

—CAMP—

COOKERY

prepared by experts and full of useful pointers on all the details of this important phase of camp life. Invincible to beginners and suggestive to the seasoned camper. It will be mailed free of charge on immediate application to

*The Royal Baking Powder Co.
 New York*

VOSE

PIANOS

have been established over 50 YEARS. By our system of payments every family in moderate circumstances can own a VOSE piano. We take old instruments in exchange and offer the new piano in your home free of expense. Write for catalogue and explanations.

VOSE & SONS PIANO CO., 150 Bayiston St., Boston, Mass.

FISHING IN NEW BRUNSWICK; By CHARLES D. LEONARD, With full page drawing by CARL RUNGIUS.

OFFICIAL ORGAN OF THE LEAGUE OF AMERICAN SPORTSMEN

RECREATION

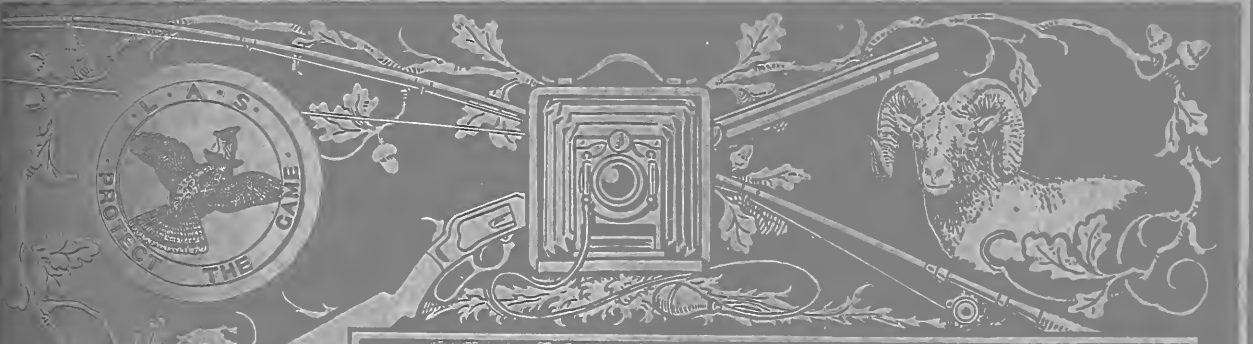

AMATEUR PHOTO BY D. W. FLINT.

THE FINISH AT SUNDOWN
Winner of 36th Prize in RECREATION'S 7th Annual Photo Competition.

PUBLISHED BY G. O. SHIELDS (COQUINA)
23 WEST 24TH ST., NEW YORK

Canoeing on the Delaware;

A Story of an Exciting Cruise, by DR. ZANE GREY, Illustrated with photographs.

“After vainly endeavoring to catch some glimpse of to-morrow, you may wisely conclude to make the best of to-day with its sunshine, its roses and its wine.”

WE invite your confidence with the assurance that we will not attempt to deceive you. **We are Not Distillers**, though we do distribute the entire output of one distillery.

We are Importers of many of the good varieties of Wines, Spirits and Cordials, the product of England, Germany, France, Italy and Spain.

We are Rectifiers, Blenders or Compounders, as you please. Choose your own name for that department of our line of business that so many people foolishly jeer at, so also is your Apothecary, your Confectioner and your Cook. How often do you receive one cow's milk.

We are Wholesale Dealers. We confess to belonging to that class of middle men, who are supposed to make enormous profits. Searching for our share of those profits the commercial telescope comes always to our eye wrong end to.

We are Retailers. We claim fellowship with that patient, long suffering, much abused, overtaxed, unprotected class of retail dealers, who fill the gap between the unreasoning Consumer and the unreasonable Total Abstainer.

We are one of the few houses in our line that can supply a patron with a glass of beer or two thousand barrels of whiskey of one inspection of a single brand.

If as **Importers, Blenders, Wholesale and Retail Dealers** we make Four profits, we will give you Three of them on any purchase you make of us. We will retain only a reasonable reward for labor, and earnestly and honestly applied energy, and a fair return on capital invested.

If you accept our offer you will surely receive the Best and the Most for your money that ever came to you from any similar proposition.

REGISTERED AND SPECIAL BRANDS

	Per Gal.		Per Gal.
Holiday Pure Rye	4.00	Old Gold Bourbon	\$4.00
(Eleven Years Old)		(Eleven Years Old)	
Hermitage Rock & Rye	4.00	Jewel Port	4.00
Superior		From Silva & Cosens, Oporto. A	
Five pounds of rock candy crystals		choice product of the grape.	
to each gallon of seven year old		Rainbow Brandy V.O.	4.00
Hermitage Rye whiskey, is used in		The product of one of the best American	
the preparation of our Celebrated		Vineyards, with all the medicinal	
Rock and Rye.		qualities of French Brandy.	
Bon Ton Cocktails	4.00	Jupiter Gin	4.00
Martini, Manhattan, Vermouth,		From the Swan Distillery, Schiedam,	
Whiskey, Tom Gin and Holland		Holland, where Good Gin comes	
Gin. Carefully prepared from the		from. Tastes differ. Many people	
choicest materials, perfectly blended.		appreciate Good Gin. Jupiter is the	
Ruthven Sherry	4.00	best the world affords.	
From Duff, Gordon & Co. Warranted		Medford Old Rum	4.00
twenty years in the wood before		From Daniel Lawrence & Sons, Med-	
bottling. Rich and fruity.		ford, Mass.	

On receipt of your order with \$6 00, we will ship 6 full quarts, assorted to suit, transportation charges prepaid, to any railroad point in the United States where the charges for transportation do not exceed \$2.00. You cannot afford to let this chance go by. You never before had as good an offer.

Remit cash in registered letter or by express company or P. O. money order.

References: Any bank in Boston. Any mercantile agency or any distiller of importance in the United States.

W. H. JONES & CO., Hanover & Blackstone Sts.,
BOSTON, MASS.

ESTABLISHED 1851

RECREATION

Copyright, December, 1902, by G. O. Shields

A Monthly Magazine Devoted to Everything the Name Implies

\$1.00 A YEAR.
10 CENTS A COPY.

G. O. SHIELDS (COQUINA),
Editor and Manager.

23 WEST 24TH STREET,
NEW YORK

CONTENTS OF THIS NUMBER

	PAGE
He Came Near the Surface and Headed Toward Vancouver.....	FRONTISPIECE
An Indian Harpooner's Catch. Illustrated.....	J. P. TODD 413
Canoeing on the Delaware. Illustrated.....	DR. ZANE GREY 415
Fishing in New Brunswick. Illustrated.....	CHAS. D. LEONARD 419
The Chronicles of a Chipmunk. Illustrated.....	DR. C. C. CURTIS 423
Home River Fishing. Poem.....	MILO THOMPSON 427
Sunday Inspiration.....	E. M. LEETE 428
A Haven of Refuge.....	CHAS. C. TOWNSEND 431
A Day Dream. Poem.....	L. C. ELERICK 431
The Song of the Fisherman. Poem.....	SYDNEY B. CARPENTER 432
Hunting and Fishing in the Highlands of Ontario.....	H. R. CHARLTON 433
With Worms for Bait.....	AL 435
Fishin'. Poem.....	EMMA G. CURTIS 437
The Florida Kid.....	CHARLEY APOPKA 440
The Reason.....	CHAS. E. SCOFIELD 482
Who Said Rats? Poem.....	L. N. DOUGLAS 482
Why Peaceful Valley Left Home.....	TIMOTHY xxiv
From the Game Fields.....	443
Fish and Fishing.....	453
Guns and Ammunition.....	459
Natural History.....	463
The League of American Sportsmen.....	467
Forestry.....	471
Pure and Impure Foods.....	473
Book Notices.....	475
Publisher's Notes.....	476
Editor's Corner.....	479
Amateur Photography.....	484

Entered as Second-Class Matter at New York Post-Office, Oct, 17, 1894.



YOU CAN'T LOSE 'EM
WITH
WASHBURNE'S PATENT IMPROVED FASTENER and KEY CHAIN

Your keys are always with you. You cannot lay them down or leave them anywhere but in your pocket. At your dealers or sent on receipt of price--Key Rings and Chain, 25c.; Cuff Holders, 20c. a pair; Scarf Holders, 10c. Send for illustrated catalog.

AMERICAN RING CO., Dept. 44, Waterbury, Conn.

Skin Diseases

Eczema, Salt Rheum, Pimples, Ringworm, Itch, Ivy Poison, Acne or other skin troubles, can be promptly cured by

Hydrozone

Hydrozone is endorsed by leading physicians. It is absolutely harmless, yet most powerful healing agent, that cures by destroying the parasites which cause these diseases.

Cures sunburn in 24 hours. In cases of Prickly Heat and Hives it will stop itching at once, also will relieve mosquito bites instantly. Take no substitute and see that every bottle bears my signature.

Trial Size, 25 Cents.

At Druggists or by mail, from

Prof. Charles Moreland

F-59 Prince St., New York.

FREE {Booklet on the rational treatment of diseases sent free.

Waltham Watches

Mechanical skill and knowledge have made them the best in the world.

“The Perfected American Watch,” an illustrated book of interesting information about watches, will be sent free upon request.

*American Waltham Watch Company,
Waltham, Mass.*

Best Hunting and Fishing Grounds

of the

West and Northwest

are reached via



Special Excursion Rates

for the

Sportsman and Tourist

For illustrated pamphlets, rates, maps, time tables, fish and game laws, tickets and detailed information, call at Ticket Offices, or address W. B. KNISKERN, Passenger Traffic Manager.

Chicago & North-Western Ry.
CHICAGO, ILL.



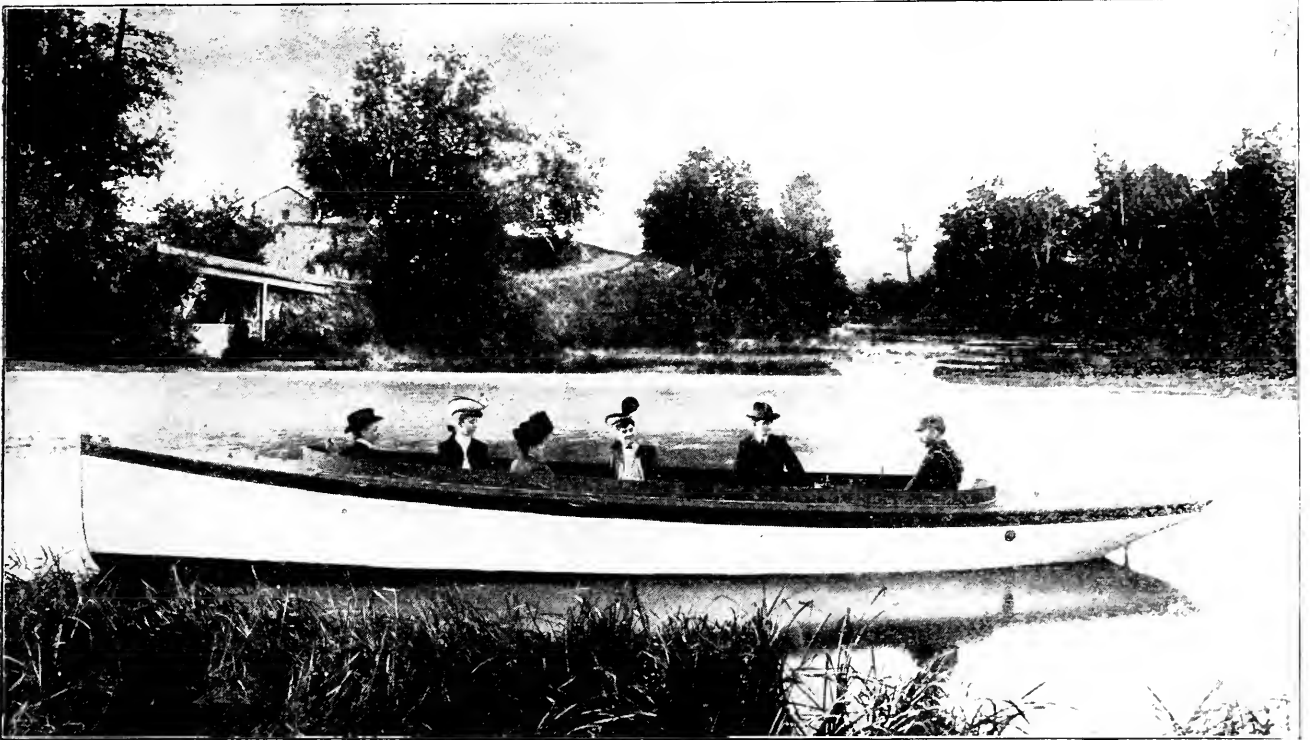

Twentieth Century Launches

THE IDEAL GENTLEMAN'S PLEASURE CRAFT
Elegantly Finished, Safe, Reliable and Speedy

15-foot Fishing Launch, \$150 ; 16 foot Family Launch, \$200 ; 35-foot Cabin Launch, \$1,500.

Salesrooms in all the large cities, where samples may be seen and demonstrations given
 Send ten cents for catalog of Launches, Sail Boats, Row Boats, Canoes and Hunting Boats

Mention RECREATION.

Address RACINE BOAT MFG. COMPANY (RIVERSIDE), RACINE, WIS.





CANOES
GUNS · FISHING TACKLE
CAMPERS' AND EXPLORERS' OUTFITS.
ABERCROMBIE & FITCH 314 ~ 316 BROADWAY NEW YORK



**FIVE
KINDS
of
TROUT
ARE FOUND IN
YELLOWSTONE PARK**

*Fishing free to every body
Greatest trout Preserve in America*

Send 6 Cents for "WONDERLAND 1903."
25 Cents for "YELLOWSTONE NATIONAL PARK,"
and read about Wonderland.
"WILD FLOWERS FROM THE YELLOWSTONE"
will be sent for 50 Cents.

CHAS. S. FEE, GEN'L PASS'GR AGENT, ST. PAUL, MINN.



The Commercial Revolution

In the space of quarter of a century there has taken place along all lines of commerce a change so tremendous and far reaching in its consequences, that it might well be termed a revolution. The force that has produced this change is publicity. It has altered methods, recreated standards of comparison, multiplied results. It has raised infinitely the expansive power of each and every business. It has almost eliminated the factor of time, so that a colossal business, instead of being the slow growth of years, may spring into existence full grown, as Minerva is said to have sprung from the head of Jove.

The business man has no longer justification for wasting time over the question: does advertising pay? His attitude would resemble that of the rustic in the fable who stood by the river's brink to wait till the water flowed past. While he questioned the dollars and cents value of publicity his competitor would have stolen a march and left him far in the rear. But though no one can doubt the efficiency of advertising in view of the results which it — and in some cases it alone — has accomplished, it must be admitted that the simple recommendation: "Go ahead and advertise" cannot be profitably followed without a large amount of deliberation.

The questions that have to be intelligently answered before a business man is safe in spending his money on advertising are many and various. Experimentation is always interesting but in advertising it is very costly, and there is no problem involving the welfare of his business in which a man should more earnestly seek for light than in this of publicity. How much should he spend in advertising; what mediums will bring him the best results; in what form should his appeal to the public appear; should it be reinforced by the aid of illustrations; should he use large space in a few publications or small space in many; how should he proceed when the public responds to his published appeal?

It is in answering such questions that we, as a fully organized and equipped advertising agency, are in a position to be of substantial service to the advertiser. We do not merely expend the appropriation which he decides to apply on publicity — *we think for him*. We give earnest consideration to the question: what is best for *this particular case*? We select the mediums, write the advertising and advise as to the best methods of following up results, always keeping in mind the *individual* characteristics of the advertising proposition. And this we are able to do efficiently because we possess the *combined* knowledge and experience which alone will make advertising successful. Our clients are making money through our efforts. We will be pleased to number you among them

Snyder, Johnson & Hindman

Newspaper and Magazine Advertising

Tribune Building, CHICAGO

"There's recreation in the books themselves."

77 Information

Bureaus of the

New York Central Lines

Each city ticket office of the New York Central, Boston & Albany, Michigan Central, Lake Shore, Big Four, Pittsburg & Lake Erie, and Lake Erie & Western Railroads in the cities of New York, Brooklyn, Boston, Worcester, Springfield, Albany, Utica, Montreal, Syracuse, Rochester, Buffalo, Niagara Falls, Toronto, Detroit, Cleveland, Pittsburg, Columbus, Indianapolis, Cincinnati, Louisville, St. Louis, Chicago, Denver, San Francisco, Portland, Los Angeles, and Dallas, Texas, is an information bureau where desired information regarding rates, time of trains, character of resorts, hotel accommodations, and a thousand and one other things the intending traveler wants to know will be freely given to all callers.

A copy of the 52-page Illustrated Catalogue of our Four-Track Series sent free on receipt of a two-cent stamp by George H. Daniels, General Passenger Agent, Grand Central Station, New York.

THE FOUR-TRACK NEWS

An Illustrated Magazine
of Travel and Education

MORE THAN 100 PAGES MONTHLY

Its scope and character is indicated by the following titles of articles that have appeared in recent issues:

Picturesque Venezuela—Illus. . .	Frederick A. Ober
Haunts of Eben Holden—Illus. . .	Del B. Salmon
A Journey Among the Stars—Illus. . .	Frank W. Mack
In the Great North Woods—Poem . . .	Eben B. Rexford
Beautiful Porto Rico—Illustrated . . .	Hezekiah Butterworth
In Rip Van Winkle's Land—Poem . . .	Minna Irving
Nature's Chronometer—Illustrated . . .	H. M. Albaugh
Van Arsdale, The Platitudinarian—Ill. . .	Chas. Battell Loomis
The Three Oregons—Illustrated . . .	Alfred Holman
Ancient Prophecies Fulfilled—Illus. . .	George H. Daniels
The Stories the Totems Tell—Illus. . .	Luther L. Holden
A Little Country Cousin—Illustrated . . .	Kathleen L. Greig
The Mazamas—Illustrated . . .	Will G. Steel
When Mother Goes Away—Poem . . .	Joe Cone
A Little Bit of Holland—Illustrated . . .	Charles B. Wells
The Romance of Reality—Illustrated . . .	Jane W. Guthrie
Samoa and Tu'ula—Illustrated . . .	Michael White
Under Mexican Skies—Illustrated . . .	Marin B. Fenwick
Niagara in Winter—Illustrated . . .	Orrin E. Dunlap
Little Histories—Illustrated . . .	
Old Fort Putnam . . .	William J. Lampton
The Confederate White House . . .	Herbert Brooks
The Alamo . . .	John K. Le Baron

SINGLE COPIES 5 CENTS, or 50 CENTS a YEAR

Can be had of newsdealers, or by addressing

GEORGE H. DANIELS, Publisher

Grand Central Station, New York

"The Nation's pleasure ground and sanitarium."

THE

ADIRONDACK

MOUNTAINS.

The Lakes and streams in the Adirondack Mountains are full of fish; the woods are inviting, the air is filled with health, and the nights are cool and restful. If you visit this region once, you will go there again. An answer to almost any question in regard to the Adirondacks will be found in No. 20 of the "Four-Track Series," "The Adirondacks and How to Reach Them;" issued by the

NEW YORK CENTRAL

A copy will be mailed free on receipt of a two-cent stamp, by George H. Daniels, General Passenger Agent, Grand Central Station, New York.

"Free from the care which wearies and annoys,
Where every hour brings its several joys."

"AMERICA'S

SUMMER

RESORTS"

This is one of the most complete publications of its kind, and will assist those who are wondering where they will go to spend their vacation this summer.

It contains a valuable map, in addition to much interesting information regarding resorts on or reached by the

NEW YORK CENTRAL LINES

A copy will be sent free, postpaid, to any address on receipt of a two-cent stamp, by George H. Daniels, General Passenger Agent, New York Central & Hudson River Railroad, Grand Central Station, New York.



FISHING on the Picturesque Erie

THE best fresh water fishing
in the vicinity of New York
is to be found along the lines of

THE ERIE RAILROAD

in Orange and Sullivan Counties, New York; and Pike
and Wayne Counties, Pennsylvania.

A FEW OF THE WATERS

GREENWOOD LAKE, 45 miles from New York, for **Black Bass** and
Pickereel. Fine sport throughout the season.

GLENMERE LAKE, 3 miles from Chester, N. Y., 56 miles from New
York, for fine **Pickereel** fishing in May and June; also good **Black
Bass** fishing in season.

LAKE MOMBASHA, Round Lake, and Long Lake, near Monroe,
N. Y., 50 miles from New York, **Black Bass** and **Pickereel**.

DELAWARE RIVER, Superb **Black Bass** fishing at **Pond Eddy**,
Shohola, Lackawaxen, Narrowsburg, Cochocton, Callicoon,
Long Eddy, Lordville, Hancock and Deposit. The **Black Bass**
of the Delaware are the gamest of all.

Trout Streams too numerous to mention.

“ FISHING ON THE PICTURESQUE ERIE ”

A beautifully illustrated guide book of 88 pages (with large map), containing interesting
articles on the fresh water game fish, and a complete directory of the lakes, rivers and
streams along the ERIE, easily reached from New York, may be obtained from any Erie
Ticket Agent in New York or Brooklyn, or by sending 3 cents in stamps for postage to

D. W. COOKE,
General Passenger Agent,
New York

Go West to the Ocean



California's summer climate is finest in the world.

Cool Trip on the Santa Fe.

Surf-bathing—ocean breezes—snow-capped Sierras.

You can buy a combination round-trip ticket to San Diego this summer—including railroad and Pullman fare, meals en route, one day at Grand Canyon, and two weeks' board and lodging at Coronado Tent City—at a very low price.

Tent City is a popular Southern California summer seaside resort.

For full particulars, address

Gen. Pass. Office, Atchison, Topeka & Santa Fe Railway, Chicago.

Santa Fe All the Way

VACATION DAYS

Where are you going for your vacation this summer, and how?

There are many delightful places: Lake Chautauqua, St. Lawrence River, Adirondack and White Mountains, Atlantic Coast, Canada, Niagara Falls, South Shore of Lake Erie country, and its lovely Islands; lakes of the Northwest, Yellowstone country and Colorado places.

The service of the Lake Shore & Michigan Southern Railway—unequaled for completeness and comfort—may be used with greatest advantage for reaching all these summer places.

Privileges—Enjoyable privileges accorded on tickets over Lake Shore—stop-over at Lake Chautauqua, Niagara Falls, Lake Erie Islands, option of boat or rail between Cleveland and Buffalo, etc.

Summer Books—Sent for 6 cents postage by undersigned: "Lake Shore Tours," "Lake Chautauqua," "Quiet Summer Retreats," "Privileges for Lake Shore Patrons," "Book of Trains."

Boston Excursions—Over the Lake Shore, July 2, 3, 4 and 5. Good until September 1. Very low rates. All railways sell in connection with Lake Shore.

Chautauqua Excursions—Over Lake Shore, July 3 and 24, from all points west of Cleveland. Good 30 days. Low rates.

A. J. SMITH, G. P. & T. A., Cleveland, O.





IN THE ADIRONDACKS—The New Hermitage At Lake Bonaparte, New York,

Once the property of King Joseph Bonaparte, and named in his honor.

The hotel has all the modern improvements and accessories. Broad verandas, wide roomy halls, large open fire-places, reading rooms, billiard rooms, telephone, daily mail.

Guests have the opportunity of enjoying delightful rowing, canoeing, bathing. The finest fishing in the Adirondacks, Croquet, Tennis.

A park containing 800 acres; beautiful walks and drives.

Handsomely illustrated book, giving full information, sent on request. Mention *Recreation*.

DAVID SCANLIN, Proprietor, Bonaparte, New York.

“AT THE GATEWAY OF THE ADIRONDACKS”

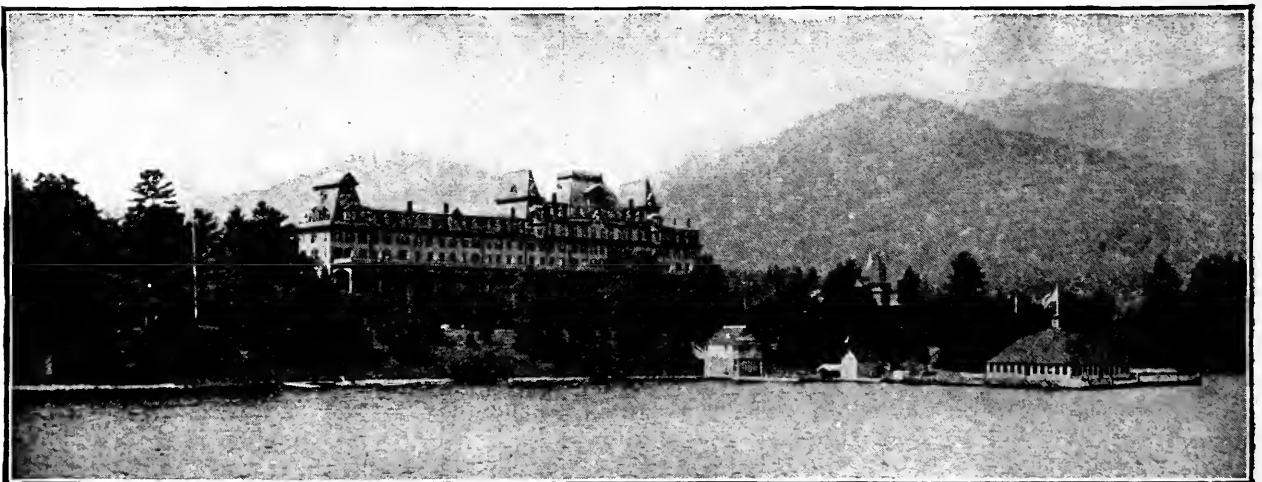

THE NEW Fort William Henry Hotel

ONE HOUR NORTH OF SARATOGA SPRINGS

Lake George, New York

Owned by the Hudson Valley
Railway Company



Hourly trolley service between
Lake George and Saratoga

W.W. Brown, Mgr., Fifteen years with Sagamore Hotel, Lake George, N.Y.

SITUATED in a delightful wooded park on the shores of one of the most beautiful of American Lakes. Every modern improvement; hotel elaborately refitted and refurnished; perfect fire safety equipment; modern plumbing; boating; bathing; golf; fishing; charming drives.

Open June to October

PLEASE MENTION RECREATION

A SUMMER PARADISE

**GRAND
TRUNK
RAILWAY
SYSTEM**

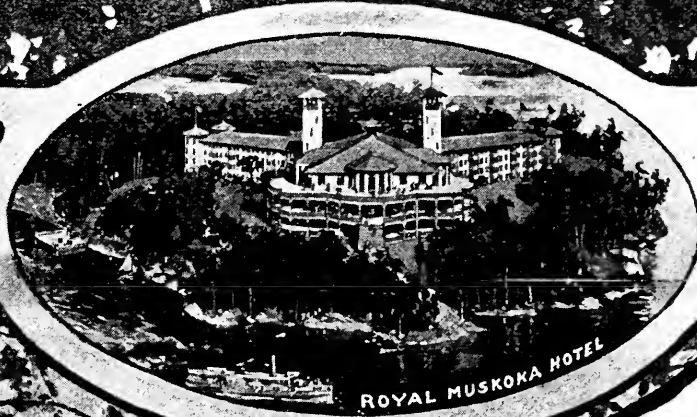

ROYAL MUSKOKA HOTEL



HIGHLANDS OF ONTARIO

1000 FEET ABOVE SEA LEVEL.
MOST CHARMING SUMMER
RESORTS IN AMERICA

INCLUDING

MUSKOKA LAKES
LAKE OF BAYS
MAGNETAWAN RIVER

30,000 ISLANDS OF GEORGIAN
BAY

KAWARTHA LAKES
LAKES SIMCOE
AND COUCHICHING
LAKE NIPISSING
AND FRENCH RIVER

EASY OF ACCESS. PERFECT IMMUNITY FROM HAY FEVER.
GOOD HOTEL ACCOMMODATIONS.
RATES TO SUIT ALL POCKETS.

THE "ROYAL MUSKOKA"
FINEST SUMMER HOTEL IN CANADA.

FREE ILLUSTRATED PUBLICATIONS

CAN BE HAD FROM GRAND TRUNK RAILWAY
SYSTEM. ADDRESS NEAREST OFFICE.

BOSTON, MASS.	T. Wynne	206 Washington Street
BUFFALO, N. Y.	Chas. L. Cook	250 Main St. (Ellicott Square Bldg.)
CHICAGO, ILL.	G. W. Vaux	917 Merchants Loan and Trust Building
	J. H. Burgess	219 Clark St. cor. Jackson Boulevard
DETROIT, MICH.	Geo. W. Watson	124 Woodward Avenue
LOS ANGELES, CAL.	W. H. Butler	372 Wilcox Building
MONTREAL, QUE.	J. Quilley	Bonaventure Station
	W. H. Clark	117 St. James Street
NEW YORK, N. Y.	F. P. Dwyer	Dun Building, 200 Broadway
SAN FRANCISCO, CAL.	W. O. Johnson	12 Front Street
ST. PAUL, MINN.	David Brown, Jr.	111 Euclid Arcade
	J. D. McDonald	Union Station
TORONTO, ONT.	J. W. Ryder	N. W. cor. King and Yonge streets

OR TO G. T. BELL,
GENERAL PASSENGER AND TICKET AGENT.
MONTREAL, CANADA.

MENTION THIS MAGAZINE.

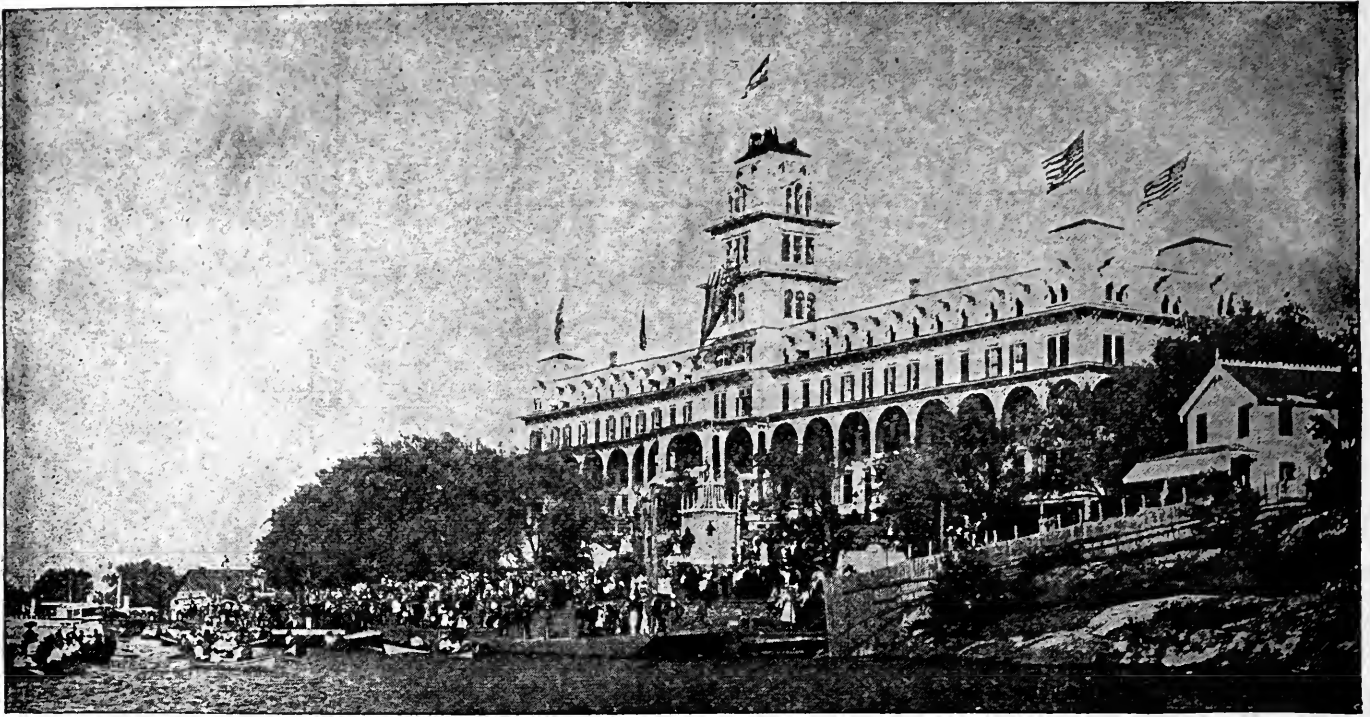

1000 Island House

In the midst of the "Thousand Islands," the so-called "Venice of America," and really the most charming and delightful Summer Resort on the Continent.

Send me two 2-cent stamps and I will send you a beautifully illustrated guide book. Mention RECREATION.

O. G. STAPLES, *Owner and Proprietor*

Alexandria Bay, N. Y.



Hotel Champlain

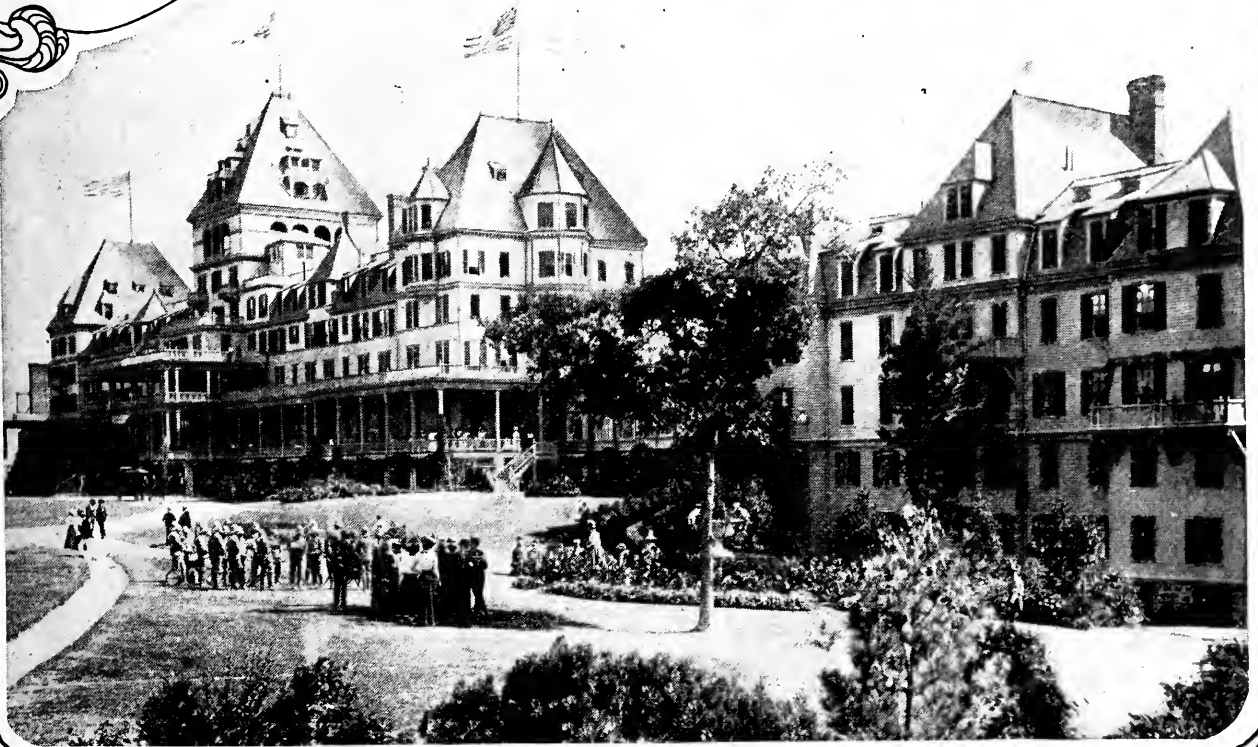

BLUFF POINT NEAR PLATTSBURG, N. Y.
**THE PEERLESS LAKE AND MOUNTAIN
 RESORT OF THE ADIRONDACKS.**

**Known everywhere as one of the most
 magnificent summer hotels in America.**

Located on a bold eminence on the shore of Lake Champlain in the center of a natural forest park of 450 acres.

Superb views of the Lake and Green Mountains of Vermont to the East, and the highest peaks and ranges of the Adirondacks to the West.

GOLF on full-length 18-hole course, kept in pink of condition. Attractive club-house with all conveniences.

HOTEL CHAMPLAIN is three miles from Plattsburg, N. Y., on main line Delaware & Hudson R. R., and is reached in through Pullmans.

BOATING, FISHING, and ideal fresh-water bathing, complete facilities. Splendid roads for automobiling.

A beautiful booklet of illustrations sent upon request.

E. L. BROWN, Mgr., Until July 1st care Lincoln Safe Deposit Co., 42d St., New York

"FOR 34 YEARS A STANDARD PIANO."

THE WING PIANO

YOU NEED THIS BOOK IF YOU INTEND TO BUY A PIANO. A book —not a catalogue—that gives you all the information possessed by experts. It makes the selection of a piano easy. If read carefully, it will make you a judge of tone, action, workmanship and finish; will tell you how to know good from bad. It describes the materials used; gives pictures of all the different parts, and tells how they should be made and put together. It is the only book of its kind ever published. It contains 116 large pages, and is named "**The Book of Complete Information About Pianos.**" We send it free to anyone wishing to buy a piano. Write for it.

SAVE FROM \$100 TO \$200 We make the WING PIANO and sell it ourselves. It goes direct from our factory to your home. We do not employ any agents or salesmen. When you buy the WING PIANO you pay the actual cost of construction and our small wholesale profit. This profit is small because we sell thousands of pianos yearly. Most retail stores sell no more than twelve to twenty pianos yearly, and must charge from \$100 to \$200 profit on each. They can't help it.

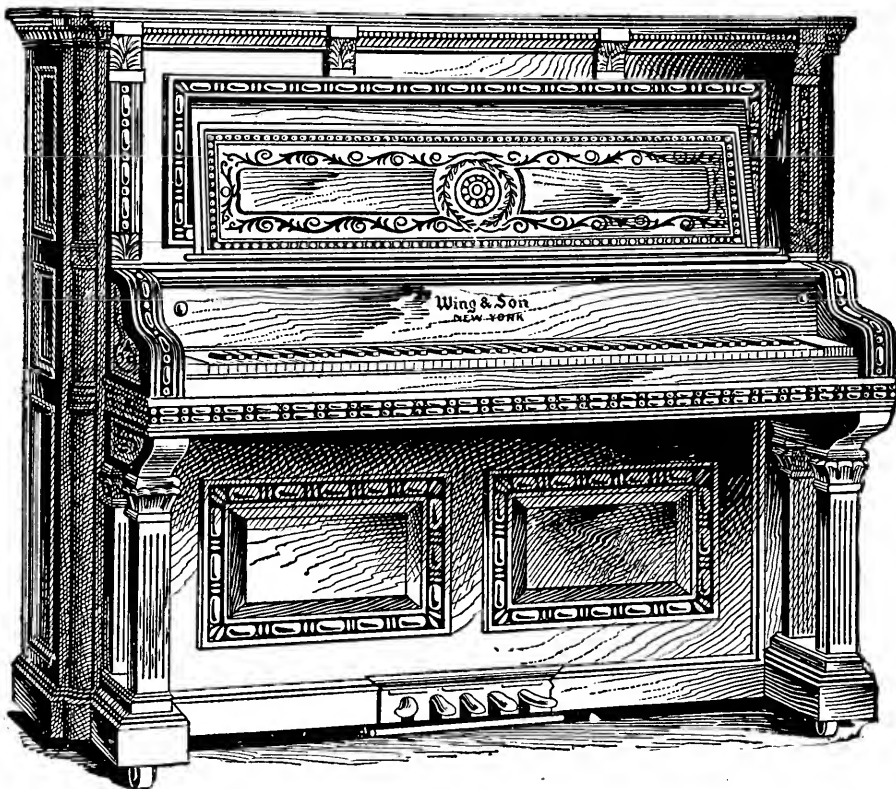

A Wing style—45 other styles to select from.

SENT ON TRIAL WE PAY FREIGHT. NO MONEY IN ADVANCE. We will send any WING PIANO to any part of the United States on trial. We pay freight in advance and do not ask for any advance payment or deposit. If the piano is not satisfactory *after twenty days' trial in your home, we take it back entirely at our expense.* You pay us nothing unless you keep the piano. There is absolutely no risk or expense to you.

Old instruments taken in exchange.

EASY MONTHLY PAYMENTS.

INSTRUMENTAL ATTACHMENT A special feature of the Wing Piano; it imitates perfectly the tones of the mandolin, guitar, harp, zither and banjo.

IN 34 YEARS 33,000 PIANOS We refer to over 33,000 satisfied purchasers in every part of the United States. WING PIANOS are guaranteed for twelve years against any defect in tone, action, workmanship or material.

WING ORGANS Are just as carefully made as Wing Pianos. They have a sweet, powerful, lasting tone, easy action, very handsome appearance, need no tuning. Wing Organs are sold direct from the factory, sent on trial; are sold on easy monthly payments. For catalogue and prices write to

WING & SON, 226 and 228 East 12th St.,
NEW YORK.

1868—35th Year—1903.



\$500.00 in Cash Prizes

for the Five Best Reasons why
Everyone Should Use the

Ostermoor \$15. Patent Elastic Felt Mattress

- | | |
|---|-------|
| 1 Person sending five best reasons, | \$100 |
| 2 Persons sending five next best, EACH \$50, | 100 |
| 3 Persons sending five next best, EACH \$25, | 75 |
| 5 Persons sending five next best, EACH \$10, | 50 |
| 10 Persons sending five next best, EACH \$5, | 50 |
| 125 Persons sending five next best, EACH \$1, | 125 |

146 Prizes amounting to \$500

Send for
Free
96 = Page
Book



“The Test of Time,” which tells about the good points of the OSTERMOOR MATTRESS that we can think of. You don't have to own an OSTERMOOR to enter this competition, but experience regarding its qualities might help you in winning.

CONDITIONS: All answers must be mailed not later than midnight July 31st, 1903, and all competitors must answer *all* of the three following questions:

1. Do you own an OSTERMOOR MATTRESS?
2. Have you ever sent for a copy of our free book?
3. Do you wish us to send at once a copy of “The Test of Time” (mailed free)?

AWARDING OF PRIZES

will be in charge of Mr. F. A. Ames, of Ostermoor & Co., Mr. C. M. Nast, of *Collier's Weekly*, Mr. George H. Hazen, of the *Century Magazine*, Mr. E. W. Spaulding, of the *Ladies' Home Journal*, and Mr. William H. Johns, of George Batten & Co., Advertising Agents, who will judge the answers and award the prizes.

THIRTY NIGHTS' FREE TRIAL

You can have an OSTERMOOR MATTRESS, sleep on it 30 nights, if it is not better than any other mattress you have ever used, return it at our expense and your money will be refunded immediately without dispute.

OSTERMOOR & CO., 114 Elizabeth St., New York.

YOUR MONEY BACK IF YOU ARE NOT SATISFIED.

DO YOU SUPPOSE that a company with a capital of \$500,000.00 paid in full, and the proud reputation of 37 years of continuous success, would make such an offer and not carry it out to the letter?

DO YOU SUPPOSE we would injure our standing with the public and our chance, of still greater success by failing to fulfil our offer?

DO YOU SUPPOSE we would make such an offer if we did not have the utmost confidence in the satisfying quality of our goods?

WE KNOW we can please you and save you money, for HAYNER WHISKEY goes direct from our own distillery to you, with all its original strength, richness and flavor, carries a UNITED STATES REGISTERED DISTILLER'S GUARANTEE of PURITY and AGE and saves you the big profits of the dealers. That's why it's best for medicinal purposes and preferred for other uses. That's why we are regularly supplying half a million satisfied customers. That's why YOU should try it. Your money back if you're not satisfied.

HAYNER WHISKEY

4 FULL QUARTS \$3.20

EXPRESS CHARGES PAID BY US.

We will send you **FOUR FULL QUARTS** of HAYNER SEVEN-YEAR-OLD RYE for \$3.20, and we will pay the express charges. When you receive the whiskey, try it and then if you don't find it all right and as good as you ever drank or can buy from anybody else at any price, you may send it back at our expense and your \$3.20 will be returned to you by next mail. How could an offer be fairer? We stand all the expense, if the goods do not please you. Won't you let send you a trial order? We ship in a plain sealed case; no marks or brands to even suggest contents.

Orders for Ariz., Cal., Col., Idaho, Mont., Nev., N. Mex., Ore., Utah, Wash., or Wyo., must be on the basis of 4 Quarts for \$4.00 by Express Prepaid or 20 Quarts for \$16.00 by Freight Prepaid.

ESTABLISHED
1866.

THE HAYNER DISTILLING COMPANY,

DISTILLERY,
TROY, OHIO.

DAYTON, OHIO.

ST. LOUIS, MO.

ST. PAUL, MINN.

ATLANTA, GA.





HE CAME NEAR THE SURFACE AND HEADED TOWARD VANCOUVER.

RECREATION

Volume XVIII.

JUNE, 1903.

Number 6.

G. O. SHIELDS, (COQUINA) Editor and Manager

AN INDIAN HARPOONER'S CATCH.

J. P. TODD.

I often wonder how Eastern anglers, who are so delighted when they catch 10 inch trout or 2 pound bass, would feel if they could hook a royal chinook salmon, on Puget sound. Spring salmon weighing 50 pounds are frequently taken with the rod, and an Indian at Neah bay recently caught an 81 pounder on a troll. So far sportsmen seem to have overlooked the king of all sports, which, in my opinion, is trolling for salmon. A few enthusiasts troll here for sport; while market fishermen often catch 50 to 150 fish in one day.

I spent 2 weeks last August at Neah bay, and in that time saw over 20,000 salmon sold to the canneries. A white man can stop there only by permission of the Indian agent; and unless he takes a tent, he will have to put up with Indian accommodations. Still, I was treated as well there as in almost any rural district.

During my stay I saw the Indians kill a whale. Three canoes, each containing 8 men, went out about 30 miles before finding game. When we found our whale he was asleep on the surface of the water. The Indians refused to approach until he awoke, saying he would smash a canoe if harpooned while sleeping.

We waited 2 hours before he stirred. When he began moving his flippers and spouting, the canoe of Young Doctor, the boss harpooner, drew cautiously behind him. From a distance of about 12 feet the harpoon was launched with a force of which I would not have believed the human arm capable. The whale sounded instantly, and the harpoon

line ran out with a whiz that made the gunwale smoke. A buoy made of a seal skin, filled with air, was attached to the line near the harpoon. The whale soon tired of holding that down. He came near the surface and headed toward Vancouver at a speed I feared would swamp the canoe. The Indians held on, however, baling out the water as fast as it was shipped; one standing by, knife in hand, ready to cut the line if necessary.

Twice the whale came up to blow, each time resuming his course. The third time he rose another canoe succeeded in fastening a harpoon and skin buoy to him. After that his spurts were shorter and less rapid, and the third canoe put a harpoon into the unlucky monster. By that time he was spouting blood; but not until 20 buoys were attached to him, making it impossible for him to dive, could Young Doctor give him a finishing blow. This he did with a lance.

It then remained to get the victim ashore. Two canoes remained with the prize, while the third, on which I was, hoisted sail and made for Cape Flattery to hire a tug. By noon next day the whale was on the beach in front of the Indian village at Neah bay.

A piece of the whale's back about 8 feet square was donated to the village for a feast. The remainder was sold at \$1 a square foot, netting the captors \$500. The piece given to the village was hung up and the oil was allowed to drain from it 4 days. Then a grand potlatch dance and feast celebrated Young Doctor's great catch.

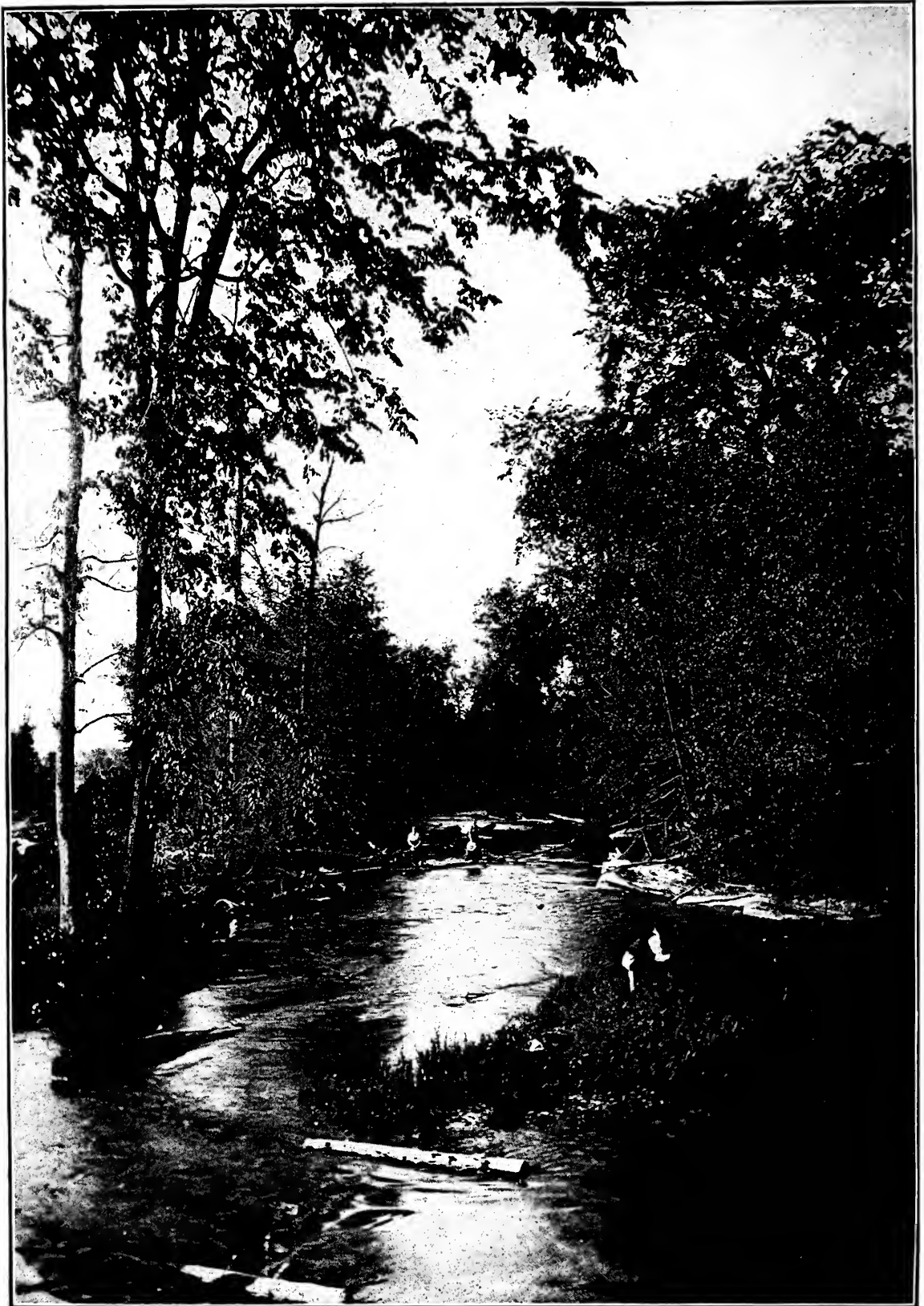

AMATEUR PHOTO BY W. H. THURSTON.

A LAZY FISHERMAN.

One of the 13th Prize Winners in RECREATION'S 7th Annual Photo Competition.

CANOEING ON THE DELAWARE.

DR. ZANE GREY.

"Boys, it is 7.30 and it is going to stop raining. Get up! After breakfast we are going up to Mast Hope and then we will come down the river in the canoe. Hurry now," I said, breaking in on their slumbers one July morning.

The yell that went up from my brothers would have put any baseball umpire out of business. Cedar showed me a great bruise on his leg and

"My dear man, Westcolang rapids have claimed 2 victims already this season and it is my belief they will claim several more if we follow your pace," growled Cedar.

"Very well, I will go alone; but if I return I shall have something to say to those young ladies who were only last night eulogizing the daring of 2 young men I know. 'Real flesh and blood men.' 'Not afraid of a n y - thing,' 'That's



s wore he was lame and could not stand up straight. Reddy pleaded a weak back, a cold, an important engagement and several other excuses.

"Not any more in mine! Not after that awful trip you steered us on yesterday! Not on your life!" said Reddy.

"But, fellows, I can't go alone. The team has been hitched, the canoe tied on the wagon, and we have been talking about this ride for days. Do you want the people here to think we are afraid and all because some fellow was drowned last week?"

t h e k i n d of man I would be,' etc. I'll queer you fellows all right, all right."

That settled it. With some more grumbling and language not exactly righteous the boys got up and into their wading clothes.

It cleared off after breakfast, and when I climbed up on the hay wagon, which was to carry our canoe, all the guests of the hotel were on the front piazza to see us depart.

"When you fellows finish saying goodbye to those girls we will proceed," I called in disgust. During the breakfast hour there had been enough reproachful glances cast

AMATEUR PHOTO BY R. C. GREY.
A CANOEIST'S DREAM.

my way to mar the most cheerful disposition. Heavens! I wasn't exactly a murderer just because I wanted the boys to take a rather risky trip.

We rode 6 miles up the valley along a winding mountain road whose sides were lined with hemlock and laurel and the beautiful pink and white blossoms of the rhododendron. At Mast Hope, a pretty little hamlet nestling down among the hills, we carried the canoe down to the water and prepared for our momentous voyage. Well pleased with ourselves we pushed off and went floating down the river. I admit that I recall some slight misgiving, some foreboding of evil, but it was so far in the background that it seemed vague. Besides, I was eager for this trip.

There was a long stretch of water which was deep and swift, and there it was delightful, sailing along so smoothly, for where there were no deceitful stones hiding their ugly noses under a riffle we had no difficulty; but the easy, gliding motion of the canoe, the limpid waters, the blue sky studded with fleecy white clouds, and the thickly wooded mountains rising grandly on either side, although they were glorious, did not entirely lull me into a sense of repose. I knew the river. I knew that it was 5 feet higher than usual and in places must be a raging torrent. Cedar and Reddy had forgotten their complaining in the keen pleasure of the moment. They laughed and chatted and waved their hands at the lone fisherman whom we met coming along the river and who stopped to shout a warning word. I am sorry to state that this large assortment of ginger lasted the boys only a brief spell.

We got through the first rapid. I can not give an adequate description of what happened because all I can recall is a confused impression of roaring waters, of black rocks, a bobbing red object, which I have since reasoned out must have been Reddy's head; then an awful bump and something enveloped us like a huge wet blanket. Afterward I found myself standing on a stone and holding to the canoe, which was half full of water. There was an awful pain in my leg and looking down I saw a nasty bruise on my shin. Cedar looked rather queer; quite like a man I had seen just after he had been hit by an automobile. He was wagging his head and muttering to himself as he wrung the water out of his shirt. Reddy was quiet and intense. Presently he expressed himself.

"I'll walk! I will never go over the falls in that d—d paper thing. I'll go down below and take your picture as you go over and I will have it framed and labeled, 'In Memoriam.'"

"Cedar, Westcolang falls are just around that bend," I said, as we watched Reddy

depart. "Listen! Do you hear that roar? I am going over those falls in the canoe. Once is enough, but I am going once. Are you game?"

"I'm there, Doc. You are not going alone," was all he said.

A sharp turn in the stream, and that is one of the most fascinating things about canoeing, the ignorance and uncertainty as to what lies before you; a roar of waters, a quickening of the current until we are fairly flying, warn us that we are at the head of Westcolang rapids, famous for their beauty, more famous for their fine fishing, but most famous for their deceiving currents and cruel rocks. Here many fatal accidents have occurred. It is only the 10th of July and already this month 2 venturesome canoeists have met their death in these seething waters. But of this I did not think at that moment.

I saw that perhaps 100 yards below, the river seemed to drop out of sight, and I had a funny tightening around my heart as I saw the smoky mist, the spray flying up, and the snowy tips of some white crested waves. No time to turn and reach the shore! I stood up for one brief moment and tried to get the lay of the best water; then gripped the paddle with a firmer hand and shouted an encouraging word to Cedar.

Dead ahead was the worst place along the river, rendered doubly perilous by reason of the high water. There was nothing to do but keep the canoe's head straight until we entered the rapids. We seemed an age covering that short distance. A recklessness had come over me; fever had roused my blood and I would have steered the canoe over the Grand Discharge of the Saguenay with as little hesitation. It is this feeling that makes canoeing so fatal.

We were shooting straight for 2 immense boulders which guarded the channel. Barely a dozen feet separated them. A long smooth incline of water led to the big stones. The canoe dipped as we went over the head of this incline and then sped like an arrow toward what seemed sure destruction. We were flying with almost the quickness of light toward that roar of tumbling waters. Cedar turned around and his face was as white as a sheet. He yelled something but I could not hear his voice.

I fixed my gaze on that narrow space, then only a few rods away. Though that channel alone lay safety. The canoe was out of line with this clear space and was going direct for the larger stone around which the water surged madly as if resenting an obstacle. When within a few yards I gave a quick, powerful stroke with the paddle and we shaved the rock and shot over the fall.

For what seemed an endless time all was roar and bouncing white caps and flying spray and then we floated into a placid

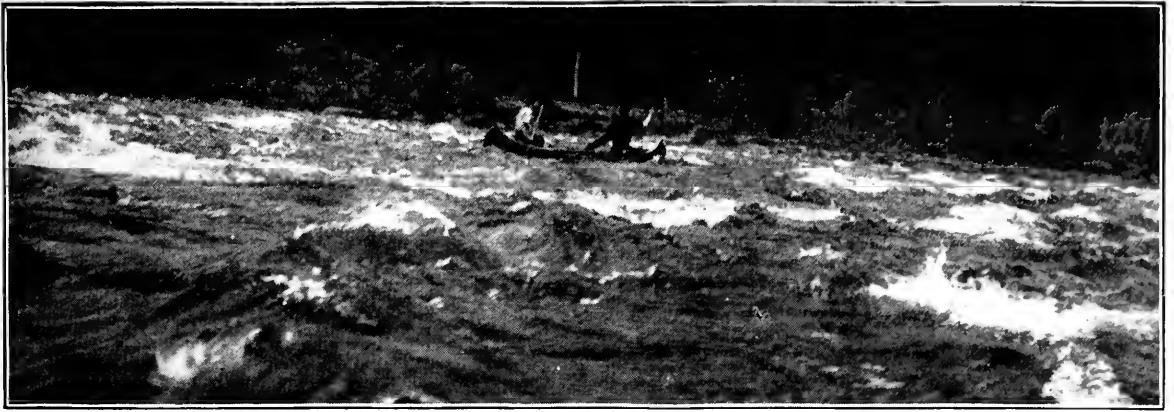

A. VATEUR PHOTO BY R. C. GREY.

WESTCOLANG RAPIDS ABOVE THE FALLS.

eddy below the falls. The canoe was half full of water and it was a miracle that she did not sink with us. We beached her and turned out the water.

Reddy, who in the meantime had come up, delivered himself of the following:

"Say, but that was tough! You went clear out of sight once, and I was scared to death. Before you can try that trip again I will smash the canoe."

"Doctor, I have seen some bad pieces of water in my time," said Cedar, as he sat down on a stone, "but for a nasty place

this is the worst. I have tried the Columbia, the Snake, the Clearwater, the Rio Grande, the Ohio and other big rivers, but the Delaware seems to beat them all. Rapids that look a great deal more difficult than this piece of water are easily navigated. The Delaware is deceitful. It is clear and yet hides its stones; it is swifter and more powerful than it looks. Not one man in 1,000 could swim out of that place. When the Delaware is high leave canoeing alone."

It is good advice.



FROM A SERIES OF PHOTOS BY AUGUST BUSCK DECORATIONS BY J. O. NUGENT.

SEA GULLS IN FLIGHT.



HE LIT OUT FOR SHORE AT A MIGHTY PACE.

FISHING IN NEW BRUNSWICK.

CHAS. D. LEONARD.

A decade ago there were dozens of rivers in New Brunswick and the other Canadian provinces, where the angler in moderate circumstances could cast a fly and lure the salmon and the trout from foam-flecked pool or swirling rapid. Today all this is changed, and the number of rivers open to anyone less than a millionaire is small and yearly diminishing.

The true angler can never be known by the size of his wallet; and there are thousands of the truest of anglers who, while reading of the delights of the Cascapedia or of the Restigouché, realize that those pleasures are not for them; but for the general public there is left at least one river rivaling in the beauty of its scenery the proudest stream of which our Lady of the Snows can boast. It flows from a region of lakes in which the largest of trout abound, and is accessible for a comparatively moderate outlay.

The canoe has been called the poor man's yacht, and in one of these our trip must be taken. Lying on our back in the canoe, with a stalwart Indian in the stern steadily poling—

"Wait a minute," I fancy I hear my readers exclaim; "you said this was to be a cheap trip."

So it shall be. You have been reading about the Restigouché, where the wage of an Indian guide alone is \$5 to \$6 a day. It is not so, however, in our case; our Indian friends are only too glad to work to their uttermost for \$2 a day, and furnish the canoe in the bargain. To be sure, we must supply them with food; but provisions are cheap, and with an added ration of cut plug for their pipes our guides will be happy.

When I first spoke of the Tobique to an acquaintance of mine, an old log driver, his remarks concerning the river were not commendatory.

"Don't go near the Tobique," he said; "it's nothing but a nasty, crooked, little stream." That description captivated me at once. He looked at the river from the standpoint of the river driver. I saw it with an angler's eye, and knew that the "nasty, crooked, little stream" might prove one of the most charming aquatic byways a birch had ever traveled.

The Tobique river flows into the St. John at Andover; and at its mouth is an Indian village, where guides may be obtained.

We left Boston, on the night express, one moonlight night a few years ago and

the next afternoon arrived at Andover, where we spent the night. Our Indian guides had left Andover, with the canoes and luggage, 3 days before, and were to await us at Riley Brook, as we intended to save time by driving up the river valley and meeting them there. After a comfortable night's rest at Andover, we started for our 56 mile drive. It was a most enjoyable ride. At times the road skirts the river bank; at other times, forsaking the charming stream, it winds over the hills, from whose summits wide vistas of forest and mountain spread out before us. At Three Brooks we stopped for lunch. We joined our rods, and making a few casts below a mill dam near at hand, caught the first trout of the trip. It was a pleasant wayside spot, but as Riley Brook, which we must reach before nightfall, was far away, we could not tarry.

A long ride, even through the best of scenery, becomes tiresome at last, and no one was sorry when, just before sunset, we reached the little settlement of Riley Brook. In the distance by the river bank our white tents stood waiting for us, where we were cordially welcomed by our guides. There were 5 of them, Joe Alexander, John Solis, John Moulton, Nicholas Lawler and Charlie Nichols.

The first night under canvas is often a sleepless one; but we were tired from our long ride and slept soundly. We were awakened at the break of day, breakfast was dispatched, the duffle placed in the canoes, and in a few minutes we were afloat on the Tobique. Before noon we reached the forks of the Tobique, the site of the principal salmon pool of the river, where we found Senator Proctor and a party of his Vermont friends. They had had splendid success, having secured a large number of salmon.

At the forks we took the left hand branch, or Little Tobique, which we ascended to reach Nictor lake. Soon after leaving the salmon pool we saw evidence that we were approaching a big game country. Moose sign abounded on every hand, while sometimes, as we poled around a point in the river, we saw a moose drinking at the waterside or wading in the stream. We soon learned to keep our cameras always in readiness for these glimpses of wild life. More than one moose is roaming the Tobique wilderness today little dreaming that the sensitive film has trapped his likeness as he stood gazing, half in alarm and half in curiosity, at the

strange beings who invaded his domain. At our first camping place a large buck walked between the fire and our tent while we were sleeping; this we learned in the morning from his tracks.

While this is a moose country, par excellence, no great claim can be made for the Tobique as a trout stream. Its waters are clear as crystal and it has numerous most inviting pools, but trout are scarce. By constant casting, however, we managed to get enough for our meals; but it was not until we reached Bathurst lake that trout fishing to satiety was obtained. There are many salmon in the Tobique, but as the river is protected, we did not attempt to take any.

About noon of the first day we arrived at a logging camp, a busy enough place in the winter, but quiet and almost deserted now. It had been left in charge of an old man, who greeted us as voyageurs from an almost unknown world, for ours was the first party to ascend the stream since it was deserted by the river drivers earlier in the season.

A little way above this camp we *cachéd* our large camera and reserved only the kodak, for there were carries ahead and the river was growing shallow in places. It was a mistake, for we could have taken the 8x10 throughout the trip. The carries were short and not difficult, and we made better progress than we would have thought possible. In its upper part the stream is narrow and very swift. Several times we were obliged to wait while some dead tree or grounded drift wood was cut away to allow the passage of the canoes. The water was clear as crystal and, in the quiet pools, mirrored the branches of the trees which, in the narrower parts, met overhead, forming one of the pleasantest green pathways imaginable.

About mid-afternoon of the third day we emerged from the narrow stream upon Nictor lake. The lake is beautiful, hemmed in by green mountains, mostly low and picturesque, though at the North rises a rocky, precipitous mountain, some 2,000 feet in height. As we entered the lake there were indications of the approach of a thunder storm, so the setting poles were discarded and paddles plied vigorously to reach our camping place before the storm broke. An Indian rarely uses a paddle when bottom can be reached with a pole, but in some places ahead of us the water was more than 80 feet deep.

We had a most novel place for our camp; a small, rocky island 100 feet in length and rising perhaps 5 or 6 feet above the water. It was far enough from the shore to be free from midges, black flies and mosquitoes, and it had been swept by ice until scarcely a vestige of vegetation

remained. Our tents were speedily set up on it and carefully guyed, for the spot had no protection from the wind. Our beds of fragrant browse were ferried from the shore and soon the cold rock floor of our tent was transformed into a soft, green couch. The storm, which held off longer than we dared to hope, broke at last, but it was of short duration.

As the sun reappeared we looked down the lake and saw it ringed in many places by the trout as they rose to the surface in pure sportiveness. The canoes were instantly pushed out, a cast of flies looped to the leaders and sent fluttering over the water. The fishing in Nictor lake was a little disappointing to some of us, but we never had any trouble in securing all the trout we needed. It is said that trout will not take a fly immediately after a thunder storm; but that theory was disproved in this case at least, for we caught several trout in our half hour's fishing, most of them of good size.

Several days of perfect weather followed our arrival, and the trout were just scarce enough to give true zest to the fishing.

Not far from our camp, on the nearer shore of the lake, stood a tall tree, towering far above its neighbors, in which 2 magnificent eagles had a nest. One day the tree was cut down and a baby eagle taken from the nest. It seems like vandalism as I write it, but it did not seem so then. He soon learned to eat fish from our fingers; but he was a treacherous little rascal, and not at all particular whether he dined on fingers or fish. On our return trip he was taken with us, and he is now healthy, if not happy, in a park not far from Boston, where he is the subject of interesting newspaper items inspired by the press agent of the park.

We frequently saw moose wading in the edges of the lake; and one morning we were hastily called away from breakfast by the tidings that a big bull was swimming across the lake. A moose can swim fast, but he is no match for 2 active paddles. We soon had a canoe on each side of him, but a few yards distant from the immense head, which was forging through the water with ears laid flat against its neck. The kodak was brought into requisition, and several films were exposed on him. When he struck the bottom he lit out for shore at a mighty pace, sending the water in every direction. When landed, he shook the water from his great shaggy coat and disappeared in the forest without waiting to bid us adieu.

After some weeks spent at Nictor, camp was struck and a short carry made to Bathurst lake. This is neither so large nor so beautiful as Nictor, but it is a delight to the fisherman's heart. I believe there is no water in the world where trout are more

plentiful; indeed, the entire lake may be called one vast trout pool.

Our camp at Bathurst was delightfully situated near a beautiful little mountain stream, whose water was clear as crystal and cold as the ice from which it sprang. At the mouth of this brook was an ideal trout pool. I believe we might have taken barrels of fish from that one spot had we so desired. The trout in the lake were not large, ranging from $\frac{1}{2}$ to $1\frac{1}{2}$ pounds in weight. Most delightful was our stay at Bathurst. The days were bright, the air cool, and the fishing such as we had never dreamed of.

Perhaps the most enjoyable part of our trip was the journey down the Nepisiquit. After leaving Bathurst lake, we passed through 2 smaller lakes connected by streams so narrow as hardly to admit the passage of our canoes. The main river, in its upper course, is rather shallow and swift, but further down there is a constant succession of the finest pools on which a fisherman ever set eyes. There are no salmon in the upper Nepisiquit, as they are prevented from ascending by high falls near the mouth of the river; but the trout are abundant and large. Scarcely a pool through which we passed, although fished in the most careless manner, failed to yield several trout running from 2 to 5 pounds. Most of them we returned to the water.

The fish, no matter what their size, are fighters, every inch of them. The cold water of the river is not conducive to laziness, and when a Nepisiquit trout is telegraphing through the leader, it is well for the operator to watch his keys closely. These trout take the fly without hesitation, and a cast at any hour of the day will awaken trout life in a manner surprising to anglers in other waters. It makes little difference what flies are used, the most elaborate combination of fancy colors or the plainest hackle being taken with equal readiness.

The scenery is beautiful beyond expression, and the moose more plentiful than in any other region through which we passed. One moose, at least, seemed possessed with a human vanity. On the trip down the

river one of our party went ahead with his canoe, saying, jokingly, "I'm going to photograph a moose." A few minutes afterward, while drifting down a quiet stretch in the river, the largest bull I ever saw walked deliberately out of the bushes into the river, stood a minute with his head in the air, while the camera was snapped, and then turned and went slowly back. It seemed that he came out to have his picture taken and for no other purpose.

After 2 days' drifting down the river, we returned to Bathurst and Nictor. It seemed almost like home to find our little rocky island waiting for us. Once more we pitched our tents in the familiar place for the few days which remained before our return to civilization.

Soon, too soon, came the hour when our tents were struck for the last time and our canoes headed for the outlet of the lake. We were silent as we glided along the shores we had learned to love so well, realizing that perhaps we were seeing them for the last time.

The return trip down the Tobique, though charming, was uneventful. We glided through the rapids up which we had laboriously poled, and were less than 2 days in covering the distance which had taken 3 in our ascent. We did not disembark at Riley Brook, but made the entire distance to Andover in our canoes. It was well we did so, as we saw on our way down the finest scenery of the Tobique, including the celebrated plaster cliffs and the foaming narrows, the forests now wearing their glorious autumn tint.

If you are a lover of nature and desire a charming summer trip take the journey I have endeavored to describe. If you do not find it thoroughly enjoyable, I am sure the fault will be with yourself; not with the locality. The entire trip up the Tobique, through the lakes and down the Nepisiquit, returning by the same route, need not occupy more than 3 weeks. That will give plenty of time for remaining at the lakes, particularly at Bathurst lake. The expense will be between \$75 and \$100, including car fares from any New England or New York point.

"Do you ever think what you'd do if you had Pierpont Morgan's income?"

"Yes, and I often wonder what he'd do if he had mine."—Philadelphia Press.

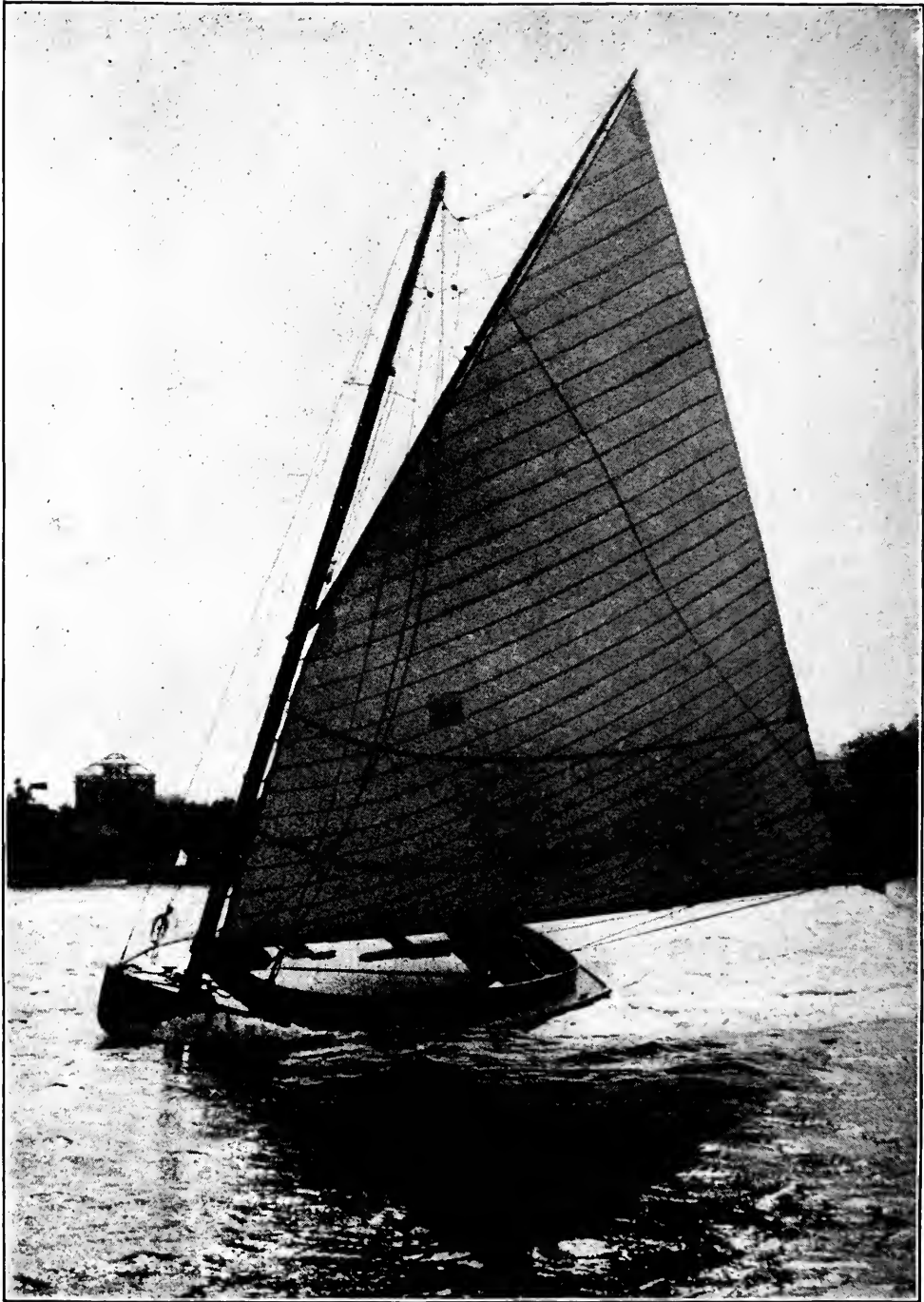

AMATEUR PHOTO BY D. W. FLINT.

THE FINISH AT SUNDOWN.

Winner of 36th Prize in RECREATION'S 7th Annual Photo Competition.

THE CHRONICLES OF A CHIPMUNK.

DR. C. C. CURTIS.

Rex made his *debut* into this life amid unique and startling surroundings. While taking a walk one day early in the spring, I came upon the devastated home of a chipmunk. The author of this vandalism was a collie. In searching the *debris* I was shocked to find the remains of a brother of Rex, but further careful scrutiny failed to reveal any trace of the parents or of other members of the household. As I was viewing the desolation I saw the slight motion of a little ball of fur clinging to a neighboring fence. I approached and discovered Rex. He accepted the situation without emotion, possibly being too young or too cold to run away. He was not over 5 centimeters long. At any rate he suffered his beautifully pencilled anatomy to be picked up without protest and seemed to nestle in my hand with satisfaction, making no effort to move or escape.

We never learned whether Rex was left an orphan in the destruction of his home or whether his parents escaped.

A certain seriousness in the character of Rex amounting almost to melancholy at times, led me to believe that Rex was the sole surviving member of the household.

The problem of feeding Rex sorely perplexed us at first. He was averse to all the delicacies of the season and it was with great satisfaction that we finally saw him partake of his first dinner of crumbs of bread soaked in warm milk, after having his nose moistened in the mixture. From that time he grew strong.

The third day of his stay with us he made the acquaintance of Waggles, a little pup, who, like himself, had been left an

and she came to attend to him faithfully; not only giving him his rations regularly, but teaching him to wash himself in the most approved cat fashion.

Rex and Waggles soon learned to know each other, but Rex never permitted any familiarity. Some people were mean enough to say he was jealous of the more rapid growth of Waggles, while others thought he did not approve the pup's flip-pant and frivolous actions. It was the dignified bearing and reserve, together with the splendor of his exquisitely pencilled coat that gave the chipmunk the *sobriquet* of Rex. Whatever was the cause of this reserve, certainly it was interesting to watch the 2 animals carry on conversations by a sort of telegraphic code, using their noses as a key board. Waggles was a regular visitor for a time to the home of Rex, and they talked in that way, separated only by the barriers of Rex's castle. This acquaintance, however, never ripened into a friendship, and after a little they drifted apart and never spoke when they passed. Possibly Waggles' ears burned whenever he saw Rex, but it is more reasonable to suppose there was nothing in common in their natures; their thoughts, associations and tastes were entirely different.

The diet of Rex changed with surprising rapidity until it comprised nearly everything the house afforded.

The most interesting feature of his life was revealed in the role that instinct played. He had little to learn under the artificial conditions which circumstances thrust upon him. Instinct supplied all demands; education had no call. We could not make a bed for him even in his second month, but that he pitched it all out and reconstructed it, although it was impossible to see wherein it was improved. Without a lesson he knew the proper way to hold a nut, and with marvelous instinct culled the good from the bad. He gave the calls of his kind, though manifestly never having heard them, and as the summer drew to a close he providently provided for the winter. His appetite, which was always colossal, became alarming. He got up nights to eat, and, not content with eating almost constantly, he insisted on keeping his larder empty by concealing whatever food might be given him. It was amusing to see him hide the nuts, quite in sight, between the bars which formed the floor of his house, stamping them down with all his might, and apparently believing them hid-den.

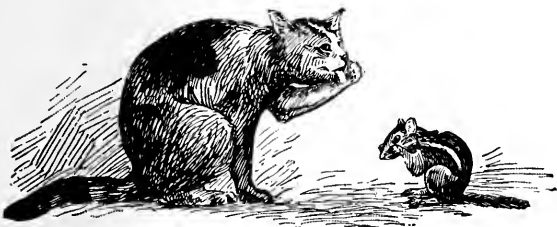

HIS FIRST LESSON.

orphan. This had happened before he had his eyes open to the realities of life, and he had been forced to accept the hospitality of our cat, who had been robbed of all but one of her kittens of the same tender age as Waggles.

The old cat, it was evident, had no love for Waggles, but her mother nature could not turn away from his helpless condition,



AMATEUR PHOTO BY F. S. MERRILL.

AN INTERRUPTED LUNCH.

Winner of 28th Prize in RECREATION'S 5th Annual Photo Competition.

Made with Korona Camera.

To gratify this propensity I covered his room with dry leaves one day while he was out on a visit in another part of the house. It was indeed amusing to see the little chap revel in those leaves. He had never seen any before, yet he knew perfectly their use. He first reconstructed his bed. Out came part of the cotton and household furnishings and then he began to stuff bits of leaves into his face until it was swollen out of all shape. Cautiously glancing about, as if to note whether any one was watching to find his nest, with a dash he was in his den. When the nest was furnished and filled to bursting, he continued to carry in material, although there was scarcely room for himself.

What a marked influence those dried leaves seemed to exert on him, awakening into life much of his wild nature that had previously lain dormant! He would peer cautiously out, watching his best friends with grave suspicion. We were at a loss at first to account for this strange change of manners. Certainly there was no reason for it. It was simply nature; a trait of his ancestry quickened into life by the magic touch of environment. It was none the less interesting to watch the little creature in his blind maneuvers, as he sought to obey the laws of his ancestors. Often have I tried to tire him out when he had loaded his saddlebags and was ready to enter his den. If he caught my eye, not a step did he budge, but motionless as an image he sat until I looked away and gave him a chance of slip-

ping in, in plain sight to be sure, but then I was not watching; that was the point.

Those dried leaves inspired him to that charming cluck of his kind when curiosity or suspicion is aroused; also the shrill whistle of fright. Apparently the attainment of these inherited powers so pleased him that he was ever on the watch for a pretext that would justify him in testing his voice. Certainly his actions could only be interpreted in this way; otherwise he must have been in a state of wonderment or alarm several times an hour. When it became impossible to find anything that by a stretch of imagination could excite his suspicion, he would steal up to my desk and patiently wait for me to move or turn, so he would have an opportunity to whistle and rush off in mad, headlong fright.

As the fall days shortened he became less and less active, his appetite failed him, and he would often sleep the best part of the day. Later he would sleep an entire day or even 2 days. His appearance outside his den became irregular and finally ceased entirely. While suspecting the nature of this sleep our curiosity prompted us to investigate. Cautiously opening the nest, we found him well in the center, round as a ball, and cold and stiff as in death. His limbs on being gently pulled sprang back as with the death rigor. Not a trace of respiration or heart beat. It did not seem possible that hibernation could so completely stop all bodily functions. For fully an hour he was placed by the fire before any sign of softening or relaxation of the muscles appeared, but even then there came no token of returning life. Finally I detected a slight contraction of the muscles, and there followed a most interesting awakening. For some time there was a nervous twitching of the fore feet, and the eyes would open occasionally. At length it was manifest that his head was wide awake, but not so the rest of his body. I believe he knew us, for he was on my knee and showed no sign of fear or wonder. There he lay quietly, and slowly the control of his forward feet came back to him. He even attempted to drag himself about a little, though the entire hind portion of his body was paralyzed. It seemed strange that one part of the body could be so completely dormant, and the other in possession of all its functions. Slowly he gained control of his hind legs, but at first with uncertain motion. When quite himself he was not at all sprightly, and that night again went into the winter sleep.

Some weeks later our curiosity led us once again to disturb his dreams. The result on that occasion leads me to think that the awakening is not a pleasant experience. While holding him in my hand and while the muscular reaction was going

on as described, he bit me severely, a thing he never did when in his right mind. It seems that the awakening may not be unlike that of a foot asleep, but possibly intensified. In after years Rex was never disturbed, and was allowed to sleep in a room of his own choosing.

It would not be possible to chronicle all the events of the remaining 2 years of his life. The most striking feature was his intuitive knowledge of nature. Anything brought from the woods he seemed to know at sight. The cone of the arbor vitæ he handled as cleverly as if his home had been for years in a stump at its base. Sitting erect he would deftly balance a stalk of grass in his paws and shuck out the seeds with amazing rapidity. Whence comes the cleverness that launches these little creatures full armed at the beginning of life? It is said that instinct is but another form of reason, the former ending where the latter begins. While this is true, as to the separation of the 2 attributes, nevertheless reason is slowly acquired by animals; whereas instinct comes into play in all its perfection, almost with birth. It is not to be inferred that Rex did not gain knowledge. He learned to know his friends right well, and he acquired appetites which I am sure were injurious; but all his acquired knowledge was of small moment compared with his wide fund of information which could be traced to no other source than that of instinct. It was most interesting to see him displaying this knowledge and he never appeared to such great advantage as when acting without reason and under the direction of instinct.

Rex never cared to wander from his own fireside; he thoroughly loved and enjoyed his home. Thoughts of his home seemed ever present in his mind, and any alterations that affected his domicile greatly disturbed him. It became necessary on one occasion to take Rex on a journey, owing to the departure of the family from the house. I think he never forgave me for that indignity. The idea of being boxed up, and bundled off on a train for the best part of a day, was too much for his nature to put up with. He positively refused to have anything to do with me on the train, and for a long time thereafter resented the treatment by his shyness. He had a peculiar fondness for licking the tips of one's finger. I suppose its saltiness attracted him, and he was always ready to respond in that way to my proffered hand. On that trip he curled up in his nest

and refused to show his head. No amount of coaxing would induce him to move, and favorite dishes offered no temptation. Most remarkable of all, when my finger was thrust down through the coverings of his bed, he positively refused to notice it. During our short stay he did not appear like himself and manifestly was not enjoying the visit at all.

One night I was disturbed by a great gnawing, as from the depredations of mice. This was repeated the following night, together with the scampering of feet, as I thought, in the walls of my room. For several days I failed to locate the trouble, but one night I decided that the sound came from the dresser. Making a light I opened the drawers and out popped Rex and stood blinking on the floor. He had climbed up the back of the dresser and gnawed his way into the second drawer. He had transported practically all his household furnishings from his nest below, but they had been liberally augmented by additions from various articles in the drawer, some of which were a sight to behold. Rex knew it would be useless to argue or explain his proposed plan, so he had performed the work in the dark. Now that it was completed I could see it was a much better place for a chipmunk, so taking out of the drawer such articles as had escaped his attention I left him to his enjoyment. That occurred early in the spring of his second year, which I think was the happiest of Rex's life. His new home suited him, and having our consent, as well as the run of the house, he worked on his home diligently, finding something every day that needed his attention.

There Rex passed the winter, asleep, and many a jolly journey we made the following summer to the woods. To see the little fellow sometimes look out of his cage at the forms about him, all of which he knew intuitively, would have caused me many a time to open the door for him, had I not realized that the degenerate customs of man had unfitted him for the struggle of life.

During the latter part of the summer, symptoms appeared that I took to be gout. He rapidly grew worse. By fall Rex could only drag himself about with difficulty, and we would place him on a mat in the sunshine, where he would sleep for hours. He did not seem to suffer, and enjoyed being petted. One bright morning in October we went to take him from his nest only to find him rolled up in his final hibernation.

Blibson—So the will was read?

Glibson—Yes; but the air was blue.—

Four-Track News.

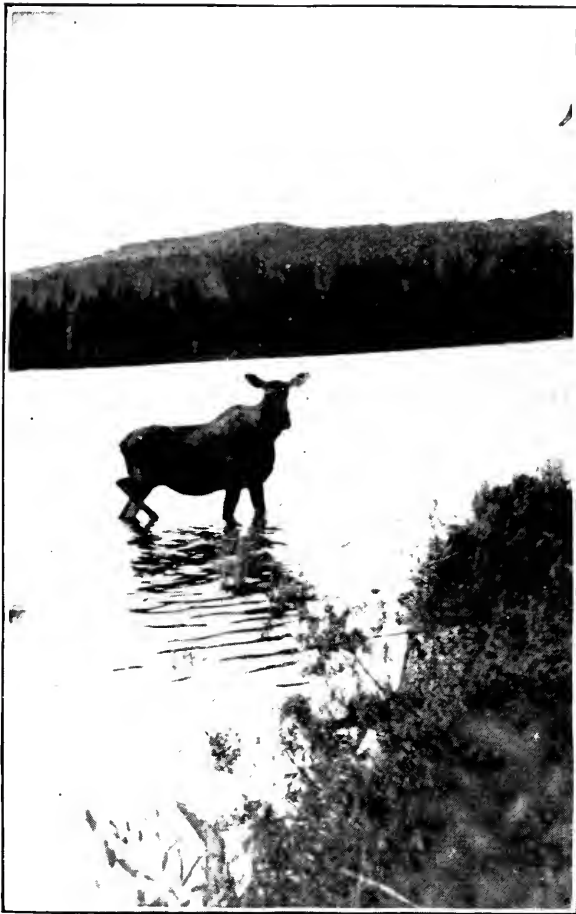

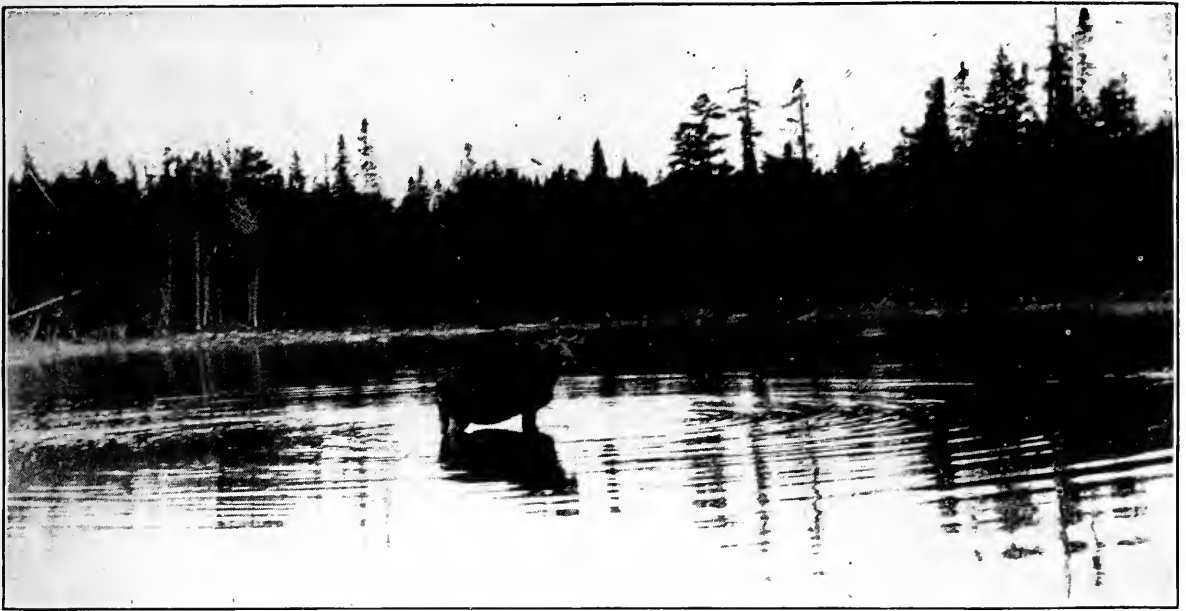

MOOSE IN THEIR SUMMER HAUNTS.

AMATEUR PHOTOS BY DR. J. M. RAINIE,

Winners of 6th Prize in RECREATION'S 7th Annual Competition.
 Made with Eastman Cartridge Kodak, Bausch & Lomb Lens.

HOME RIVER FISHING.

MILO THOMPSON.

When the frost from lake and river
 To the spring has given way,
 And the bullhead for the summer
 Down the stream has come to stay;
 To the boys within the village
 There's no sport of greater rank
 Than to spend an evening fishing
 From the old home river bank.

When the corn in field is planted,
 After sun has warmed the soil,
 And the holiday, as promised,
 We have earned by honest toil;
 To the boys within the country
 There's no greater privilege,
 Than to spend the day at fishing
 From some old home river bridge.

There's the black bass and the speckle,
 There's the sunfish and the perch,
 With the dogfish and the pick'rel,
 Ready for the daytime lurch;
 While the glow on bank at evening
 Shows the angler by its light,
 There with baited hook in waiting
 For the bullhead's eager bite.

Some will tell you time at fishing
 On that stream you should not spend,
 But for pleasure, sport, or profit
 To a lake your way should wend.
 Well, perhaps they may be honest
 In their statement to you made,
 But I've seen from that stream's catches
 Strings that put the lake in shade.

From the days I've spent at fishing,
 With their sorrows and their joys,
 I would give as my experience—
 Same endorsed by "Walton" boys—
 If you'd cast your line while waiting
 Where between bites you can't dream,
 Then just spend the same at fishing
 'Long the old home river stream.

SUNDAY INSPIRATION.

E. M. LEETE.

If the 29th of June had not been a rainy Sunday this yarn would probably never have been written. As things happened, however, it rained hard all day. The 30th and last day of the month was Monday, and was also the close of the open season for brook trout. Whether fishing is a habit, disease or hobby, I can not say, but after one has contracted the appetite for fishing it is hard to break off. I could always see more days when I knew fish would bite than days that I should call good days to work in.

That Sunday morning my wife, my 3 children and I attended church. My wife occupied the farther end of the pew, I next the aisle, and the children between us. It is always pleasant for me to attend church with my family, to feel that the cares and troubles of the week are past, and that Sunday, set apart for us as a day of rest, is once more to be enjoyed. I listened to the organ voluntary and to the minister as he opened the service. About in the middle of prayer before the sermon the storm outside suddenly increased. The rain came down in torrents and ran in floods from the eaves. I was glad to be under shelter and to feel that my family were sheltered with me. With this thought came an idea that was entirely out of place.

A mile or more from my home is a small brook that lacks only one thing to be quite a success as brooks go. The one thing lacking is water. From the hills and woods back of the village comes this little stream, so small one can easily step over it; and in the meadow the grasses grow so rank that they cover the stream entirely except in the wider places. Down through the fresh meadow it runs, across the road, and into the salt meadow beyond, where from a clear and limpid trout stream it becomes simply a salt creek. It never, to my knowledge, quite ran dry, although in midsummer there was hardly water enough to furnish a horse a good drink. This brook, when bank full, late in the season, was almost sure to contain trout, and this same brook made all the mischief with me that rainy Sunday morning. I stood it very well until the water poured from the eaves, when it flashed through my mind that if this would only continue, Monday morning early would be the time to fish this stream. The rain would fill the brook, Monday was the last day, and, furthermore, I was sure the brook had not been fished for some time. This whole combination made sad work of my Sunday service.

I do not approve of Sunday fishing. I never caught a fish on Sunday in my life, and I knew the house of God was not the place to plan a fishing excursion; but my mind was wandering. I wondered whether the rain would continue, whether it would be clear in the morning, and where I could find any worms. After awhile I straightened myself up and put such worldly thoughts out of my head. The minister was to blame for the rest, when he gave out his text, John 21, 3: "Simon Peter saith unto them, 'I go a-fishing.'"

That was the cap sheaf, and I wondered whether Peter had a split bamboo or a steel rod; whether he was a fly fisherman or used worms for bait; and whether it was not breaking the law to take so many fish with one haul of the net. About that time there was a commotion in the farther end of the pew. Something ailed my wife and I found the plate was being passed for the collection. I looked at the Mrs. with mild reproach and put in our offering. When we returned home my wife accused me of having slept in church.

That night before retiring I found my tackle. Early the next morning I was up. My wife asked me what was the matter, and I gave her to understand that I would be busy all day and wanted to get a good start. After making a fire I prospected around for some worms. Now, farming as a business I object to, and hoeing in particular; but before I had what worms I wanted our tomato patch was thoroughly cultivated. It was not just what you call smooth; but the weeds were killed. The worms were in my box and my wife would surely be pleased with my gardening.

Stopping long enough to drink a cup of coffee and tell madam that I was "just going up on the brook a while," I started. To reach the stream it was necessary to go through a field of young corn and the tall grass in the meadow beyond. Then I realized that rubber boots were a mistake. What was needed was a bathing suit. The lower part of my legs was dry, but from my knees to my hips I was wet through. The grass was so tall that I almost despaired of finding the brook, and wondered if it had not been moved since my last visit. However, a little patch of water was visible, and into that I dropped my hook, recalling a definition I had once read of the word "fisherman," "A pole with a string at one end and a fool at the other."

All the same, I felt a bite and landed a small trout. My creel was home, so I

stuffed the fish into one of my coat pockets and tried again with the same success, and worked slowly down the meadow, fishing in the holes for trout, and falling into muskrat holes for my own amusement. When I reached the lower end of the meadow I had 13 trout in my coat pockets and one too large to go in. That I put on a stick. The big one weighed a pound, while several of those in the pockets weighed $\frac{1}{2}$ a pound each. The pockets bulged somewhat, but I did not know what else to do with the fish.

This for me was good luck, and I started home, knowing how pleased my wife would be with the delicious dinner in prospect. She was pleased when she saw the big one. It was when I began to unload my pockets that her eyes showed trouble was coming. As I pulled out a fish with a slight kink in the tail, that I hastened to straighten, she looked at me.

"John, did you put that dirty fish in your pocket?"

I had to admit that I was the author of the deed, and I hastened to tell her that the fish were not dirty, as they had all been washed before taking.

"But in your pocket! You should have known better."

I explained that the fish would all straighten out and that it did not hurt them a bit. Then I took out another.

"But your pockets are no place to put fish!"

My wife is dear to me, so I told her it was impossible to put the fish in the button-holes, on the collar, or to pin them on the lapel.

Her reply is a matter between the lady and myself; but I have since made different arrangements about transporting what trout I catch.

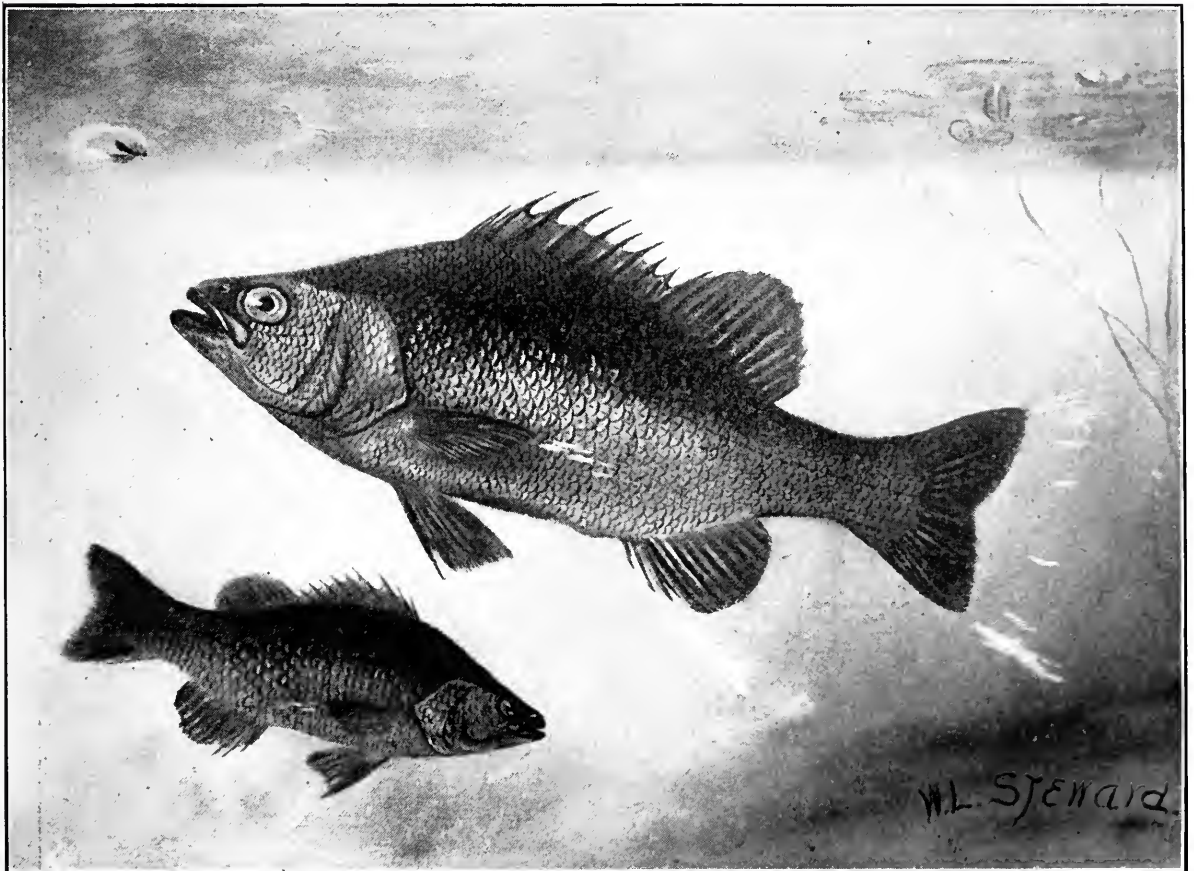

WHITE PERCH.

FROM PAINTING BY W. L. STEWARD

"Help! Help!" came the cry of distress through the midnight stillness.

The policeman in the neighboring doorway stirred uneasily. "Advertise in the want column," he muttered, and resumed his nap.—Philadelphia Press.

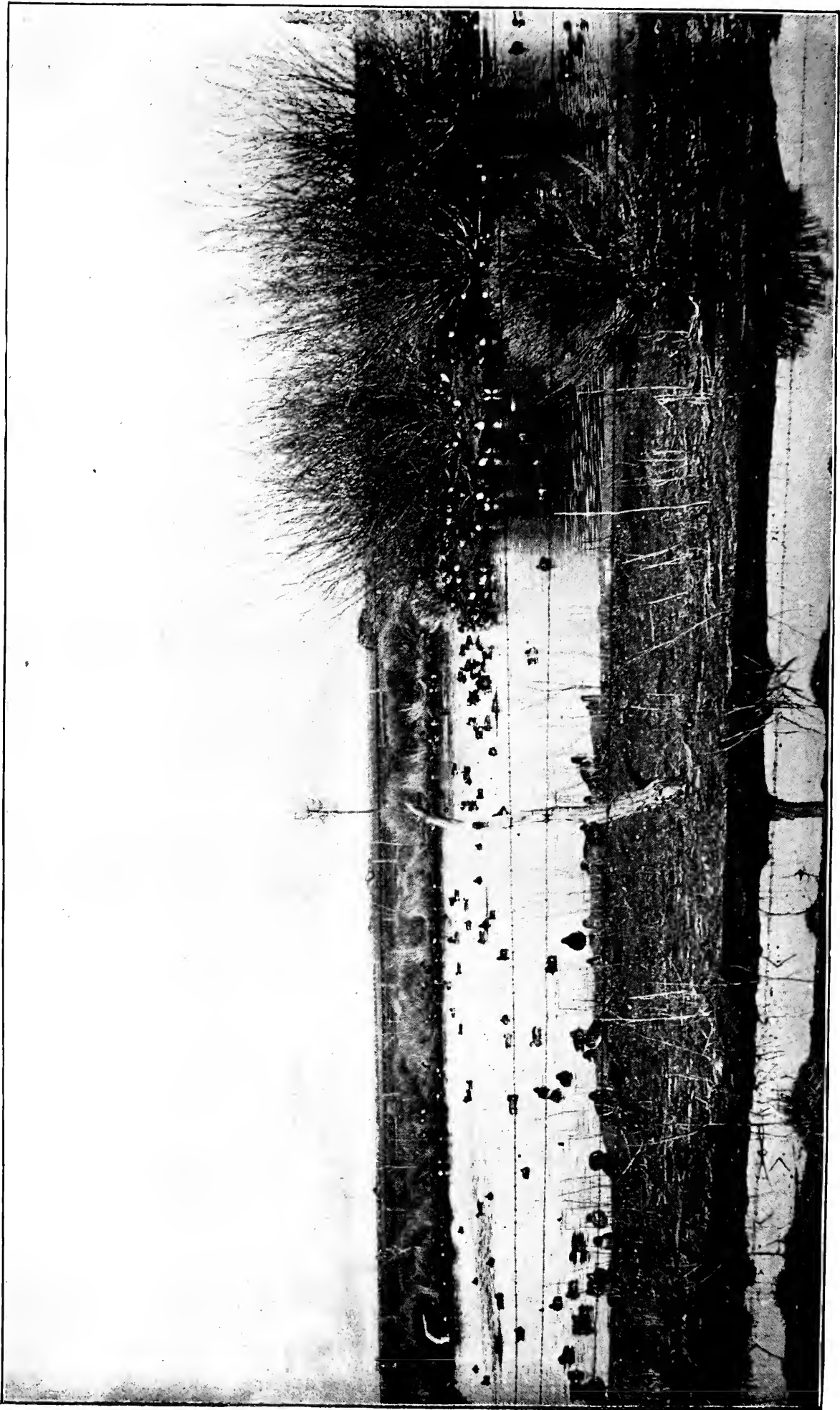

PHOTOGRAPHER UNKNOWN.

AN OBJECT LESSON IN KINDNESS TO BIRDS.

A HAVEN OF REFUGE.

CHAS. C. TOWNSEND.

One mile North of the little village of Mosca, Colorado, in San Luis valley, lives the family of J. C. Gray. On the Gray ranch there is an artesian well which empties into a small pond about 100 feet square. This pond is never entirely frozen over and the water emptying therein is warm even during the coldest winter.

Some 5 years ago Mr. Gray secured a few wild duck eggs and hatched them under a hen. The little ducks were reared and fed on the little pond. The following spring they left the place, to return in the fall, bringing with them broods of young; also bringing other ducks to the home where protection was afforded them and plenty of good feed was provided. Each year since, the ducks have scattered in the spring to mate and rear their families, returning again with greatly increased numbers in the fall and again bringing strangers to the haven of refuge.

I drove out to the ranch November 24, 1902, and found the little pond almost black with the birds, and was fortunate enough to secure a picture of a part of the pond while the ducks were thickly gathered thereon. Ice had formed around the edges, and this ice was covered with ducks. The water was also alive with others, which paid not the least attention to the party of strangers on the shore.

From Mr. Gray I learned that there were some 600 ducks of various kinds on the pond at that time, though it was then early for them to seek winter quarters. Later in the year, he assured me, there

would be between 2,000 and 3,000 teal, mallards, canvasbacks, redheads and other varieties, all perfectly at home and fearless of danger. The family have habitually approached the pond from the house, which stands on the South side, and should any person appear on the North side of the pond the ducks immediately take fright and flight. Wheat was strewn on the ground and in the water, and the ducks waddled around us within a few inches of our feet to feed, paying not the least attention to us or to the old house dog which walked near.

Six miles East of the ranch is San Luis lake, to which these ducks travel almost daily while the lake is open. When they are at the lake it is impossible to approach within gun shot of the then timid birds. Some unsympathetic boys and men have learned the habit of the birds and place themselves in hiding along the course of flight to and from the lake. Many ducks are shot in this way, but woe to the person caught firing a gun on or near the home pond. When away from home, the birds are as wild as other wild ducks and fail to recognize any members of the Gray family. While at home they follow the boys around the barn yard, squawking for feed like so many tame ducks.

This is the greatest sight I have ever witnessed and one that I could not believe existed until I had seen it. Certainly it is worth traveling many miles to see, and no one, after seeing it, would care to shoot birds that, when kindly treated, make such charming pets.

A DAY DREAM.

L. C. ELERICK.

To one grown tired of city streets,
And dusty halls of trade,
A vision comes of cool retreats,
A glimpse of forest shade.

His dingy office walls are gone,
And sylvan nooks he sees;
He views again a country dawn,
And wanders 'neath the trees.

On every side are fragrant flowers,
The air is fresh and cool;
Birds' carols come from leafy bowers
As he stands beside the pool

Where years ago, a barefoot boy,
With comrades young and gay,
He plunged with careless shouts of joy,
And frolicked in the spray.

He feels upon his throbbing brow
The pleasant, cooling breeze;
All weariness has left him now,
For he lives among the trees.

And then—ah! swift the vision fades,
Again he hears a din,
Gone are the pleasant woodland glades,
His office shuts him in.



AMATEUR PHOTO BY R. T. KING.

THE HOME OF THE TROUT.
Made with Al Vista Camera.

THE SONG OF THE FISHERMAN.

SYDNEY B. CARPENDER.

With a bent pin hook and a willow wand,
We steal to the long-forbidden pond,
Where the sunfish swim,
And the shiners swim,
And the catfish swim,

Then sing:

"There's no such sport in our early days,
As to lie on the shady bank and gaze
At the cork as it floats in the noonday
rays."

Joy for the little fisherman!

When the sun is hot and the water still,
When the gulls cry out with their voices
shrill,

When the mackerel leap,
And the bluefish leap,
And our own hearts leap,

Then sing:

"There's no such sport on land or sea,
On the heaving tide or by sheltered lea;"
And we laugh as we fish, and shout with
glee.

Joy for the deep sea fisherman!

With the sun coming up, or sinking down,
When the foam flakes soften the dark
rock's frown,

When the waves dash on,
And the bass darts on,
And the reel spins on,

Then sing:

"There's no such sport 'mongst the finny
host,
For this is the patient fisher's toast:
'To the striped bass along the coast!'"
'Way for the 'longshore fisherman!

In a deep, cool pond or a running brook
Lie the speckled trout with watchful look.

With a willow rod,
Or a bamboo rod,
Or a greenheart rod,

We sing:

"There's no such sport on a summer's day,
When the brooklet ripples and the sun-
beams play,

When the wary trout to their young ones
say:

"Way for the silent fisherman!"

When the years have flown and our youth
is spent,

When our backs like our well worn rods
are bent,

Then our thoughts fly back,
And our hearts fly back,
And our voice comes back,

And we sing:

"There was no such sport in the whole
broad land,

With silk-wound rod or the willow wand,
When we whipped the pool with steady
hand."

'Way for the aged fisherman!

HUNTING AND FISHING IN THE HIGHLANDS OF ONTARIO.

H. R. CHARLTON.

Each year, after the deer hunting season in the Province of Ontario is over, a number of people resort to a newspaper controversy on some question regarding the laws that are in force for the protection of these animals, and give suggestions for the protection of the game and the betterment of the hunters. One of the principal causes of complaint after the season of 1902 seems to have been that the season is too early, and that, owing to the mild weather, it should be extended from the first 2 weeks of November to the last 2 weeks of the same month. Others have urged that hunting with dogs be prohibited, or that on a certain number of days in the early part of the season hounding should be allowed and the remainder of the open season given over to the still hunter; during the latter period dogs absolutely prohibited under a sufficient penalty.

It has also been urged that nothing be killed except carrying horns, for at least 2 years, this correspondent giving as his reason that the killing of a doe is getting at the base of life, and that a fawn should be given a chance to grow into something worth shooting. The killing of deer in the water has also been under discussion.

It is well known that the deer hunting in the Province of Ontario is the best in the world, and the natural advantages make it possible to retain this great heritage and revenue-producing attraction. The lines of the Grand Trunk Railway system reach probably the best red deer hunting grounds of Northern Ontario, including the Lake Nipissing and French River districts, the many hunting camps reached through Powassan, Trout creek, South river and Sundridge, the exceptionally fine hunting grounds on the Magnetawan river, the Lake of Bays region, and the Muskoka lakes district, not excepting the many points on the Georgian bay. The railway company is therefore taking particular interest in the preservation and protection of one of Canada's most lucrative attractions, and a few remarks on this important subject will perhaps not be out of place in this connection.

The majority of hunters going into these districts are transported over our Northern division. I have therefore had the opportunity of interviewing several sportsmen on the subjects mentioned in the foregoing part of this paper. The consensus of opinion seems to be that hunters do not care to go up into these districts to shoot in the winter. It is too cold to camp out

after November 15, and the hardship would more than offset the pleasure derived. Again, navigation would be liable to be closed and the majority of hunters depend on that means of getting out of their camps. Another objection to changing the season to the last 2 weeks in November is that the busy season for men in commercial life commences about December 1, and many camps would be obliged to break up on or about November 25.

The season of 1902 was exceptionally mild, and no doubt many carcasses spoiled from that cause; but last November was the warmest since 1848, and it may be 50 years more before we have another November with a similar temperature. For means of comparison I have asked the navigation companies that operate on the waters of Northern Ontario the dates on which navigation was closed for the past 5 years, and elicited the following information:

Muskoka Lakes—December 2, 1897; December 6, 1898; December 12, 1899; December 9, 1900; December 3, 1901; December 5, 1902.

Magnetawan River—November 23, 1897; November 25, 1898; December 3, 1899; November 27, 1900; November 30, 1901; November 29, 1902.

Lake of Bays—November 28, 1897; November 29, 1898; December 5, 1899; November 27, 1900; November 27, 1901; December 3, 1902.

From these statistics it would not be advisable to change the season to the last 15 days of November, as the probabilities would be that during the last week of November navigation might be closed and the difficulties of transport to the railway line over practically impassable roads, if a heavy snowfall should occur, would be insurmountable.

If the Game Commission should decide to change the open season, the end of the time should not be later than November 20, and I recommend that the season be made November 5 to November 20.

Though I consider hounding unsportsmanlike, it is probably a necessary evil under the conditions that are found in the localities in question, as probably 90 per cent of the hunters would never see a deer in the 15 days' open season without the aid of a dog. Another point in its favor is the minimum chance of mortality to the hunter. Only the best hunters can get a shot by still hunting. It is the most dangerous of all methods, and more men are shot while still hunting than when using any other meth-

od. It requires men who are brought up to it, who are in the prime of life, cautious, and with keen eyesight, and not apt to shoot until they are satisfied there is no danger to other human beings. The main point for hounding is in this connection, and the principal objection to still hunting, is the danger to sportsmen. A large portion of our Northern district is covered with a dense second growth, in which still hunting is out of the question.

As to the killing of does and fawns, the correspondent is correct in stating that "the slaughter of a doe is getting at the base of life." Deer are so numerous in the districts under consideration, that probably each hunter could secure his quota of horned animals, sparing the does, and giving the fawns an opportunity of growing to a size worth shooting. This is a matter on which the Government might look favorably, and place restrictions to protect the female and her offspring.

Killing deer in the water is a mode of hunting of which no true sportsman would be guilty. It is one style of hunting that does not require any strategy or cleverness, and is a cruel way to secure the game. It is one feature of the present law which should be rescinded.

Instead of the supply of deer decreasing, they seem to be growing more numerous each successive year. This is due, no doubt, to the shortness of the open season, and to the strict prosecution by the Ontario Government of all who transgress the laws, as well as to the protection to the deer by the new dense undergrowth, which is replacing the timber lands in several of the Northern districts. Information lately received from Mr. E. Tinsley, Chief Game Warden of Ontario, gives the number of licenses and permits issued for the season of 1902 as nearly 10,000, and Mr. Tinsley states that a conservative estimate places the number of animals killed at about 12,000. In addition to these about 100 moose were killed.

The Canadian Express Company carried 2,376 carcasses, with an aggregate weight of 248,993 pounds; an increase over 1891

of 4 deer. A large majority of these were taken from points on the Grand Trunk Railway system, the greatest number having been brought from the Magnetawan river region, the Lake of Bays district, Muskoka lakes region and the several stations between Gravenhurst and North bay. In addition to these the Dominion Express Company carried 240 deer and 40 moose. Of course these figures do not by any means represent the number of deer killed, as Chief Game Warden Tinsley states that $\frac{3}{4}$ of the hunters are settlers, and carry their deer to their homes by teams. There were 972 hunters in excess of previous year carried by the Grand Trunk to the hunting districts.

The railroads not only take a deep interest in the hunting in this country, but in the fishing as well, as has been demonstrated during the last few years. The Grand Trunk has worked in harmony with the fish commissions of not only Canada, but of the several States through which their lines run, and to the betterment of all concerned. Several of the lakes in Northern Ontario had, during recent years, been somewhat depleted. The Ontario Government, in conjunction with the Grand Trunk, arranged to restock these lakes with parent bass. To this end the Grand Trunk built, in 1901, at their shops, a fish car, with modern devices, for the purpose of transporting these fish, the car having a capacity of about 1,000 fish. During 1901 the Government contracted for 10,000 parent small mouth bass. These were all successfully transported and planted in the several lakes, with a loss of only 356 fish, all of which perished in the first shipment, because of extremely hot weather. The waters which were stocked in 1901 included the Muskokas, Lake of Bays, Lake Couchiching, Lake Simcoe, Stony lake, River Thames, Welland river, Sparrow lake and Grand river. During 1902 the results were not so successful as in the previous year, only about 2,000 bass having been planted in some of the same waters. This was caused by the unpropitious weather during the time the bass were running.

"You say Grace married into the smart set?"

"Gracious, no; she was divorced into it."
—Baltimore Herald.

WITH WORMS FOR BAIT.

AL.

"Do you know," said Mrs. C., "I am tired of fly fishing for bass, especially when they run as small as they have lately. What has become of the big fellows?"

"I presume you caught all of them last summer," I replied.

Mrs. C., be it known, is a crack-a-jack with rod and reel, and not a little proud of her prowess. We were sitting on the porch admiring a brilliant sunset following an afternoon thunder storm. The rain had driven us from the lake earlier than we were wont to leave it. That day our catch, for 3 persons, mind you, was 4 bass, barely above legal size. It was discouraging, I admit.

"We might try the trout," suggested Mr. C.

"But you say," said Mrs. C., turning to me, "that all the trout streams hereabout are preserved."

"That is true," I answered; "at least as regards streams known to contain trout. But when I was a boy I fished all the water in this region, and I think I can find a little brook that used richly to reward my trouble in reaching it. No one but I knew of it in those days, and perhaps no one has discovered it since. I remember that when going there I used to walk miles out of my way, lest anyone should follow me."

"Let's go there to-morrow!" cried Mrs. C. "How far is it?"

"About 4 miles across lots or 6 by the road."

"Then we'll start at sunrise and go across lots," she said.

"I doubt if you would care to walk so far through woods," I replied. "Besides, your tackle would be useless; there is no open water for casting."

"Then we'll fish with bait," said Mrs. C.

"I don't know where you will get it," her husband remarked. "I heard a boy at the hotel say there was not a worm within a mile. If he could not find any, I'm not going to try."

"Well," I said, "near that brook is a farm house belonging to old friends of mine. We'll get worms there if we have to dig their garden over."

So it was agreed we should try the trout and we did so the next day, starting at day-break and carrying only a can for the worms

we hoped to find, and lines and hooks. It was a bright, clear morning, with every promise of a fine day. We reached the farm house by 8 o'clock and received from the old couple a hearty welcome; also much incidental milk and sweet cider. After resting a while, we dug our bait and went on a half mile or so to the brook.

"Here we are," I said, when we came at last to a great field of ripening timothy.

"But," cried Mrs. C., "we don't want hay."

"Surely not," I said. "We want trout, and we'll find them in this hay."

"You must be mistaken," said Mr. C., gazing over the field, "there is no water here."

"Yes, there is," I replied, "unless it has dried up or moved away. We will cut some alder poles at this hedge and rig our lines. Then you follow me and I will try to keep you from stepping in the brook."

In the middle of the field we came, surely enough, on a little spring brook, not 3 feet wide.

"Now," said I, "bait your hooks and drop them in any open water you see, letting the worm just touch the surface."

Before I had finished my instructions and was yet struggling with a refractory worm, I heard a cry from Mrs. C. and saw a 10-inch trout flying heavenward. We worked our way through the tall grass to the woods, occasionally making a finny capture. Then through the woods we went until the little stream was lost in a swamp. We retraced our steps, fishing carefully, lest we should have overlooked some likely spot. We were about ready to give up when Mrs. C. took a 14-inch fish from the stream she could have stepped across at its widest point. That was the last and crowning triumph of the day.

We returned to the farm house carrying 22 trout on a forked twig and 3 inexpressibly contented souls wherever you are pleased to locate them. My good old friends had a bountiful dinner ready for us, with more milk and cider. Later, and until it was time to trudge homeward, we lounged under the big elms in the farm yard and wondered when we would enjoy another so glorious a day.

Johnson—He said I was an addle pated jackass. What do you advise me to do about it?

Jackson—See a good veterinary.—Judge.



FLAPPING WINGS.



A TEMPTING MORSEL.



LOON ON NEST.



PIED-BILL GREBE AND NEST.



A GOOD TIME.



AMATEUR PHOTOS BY J. E. STANLEY

CATCHING MINNOWS.

Winners of 8th Prize in RECREATION's 7th Annual Photo Competition.
Made with Premo Camera.

THE JELLYFISH.

J. C. EDWARDS.

Slow drifting, drifting, drifting with the
tide,
With endless, aimless wand'rings through
the sea,
Its pliant body, fringed with softest lace,
As delicate as ever yet was wrought
By skillful hand for rare and dainty work,
Yields gently to each light, caressing touch
Of moving wave which helps it on its way,
And aids it in its lifelong wanderings.
Its mind, a tiny gleam of instinct blind,
Has knowledge of no science, art, or love;

And yet it serves its every hourly need,
And makes of it a sentient being whole,
That lives and moves and dies and serves
its day

In God's stupendous plan of earthly life.
It is a branch that in the ages past
Was parted from the primal, living trunk,
And still exists, a thing to help to prove
That this mysterious, wondrous world of
ours
Is ruled by wisest law and not by chance.

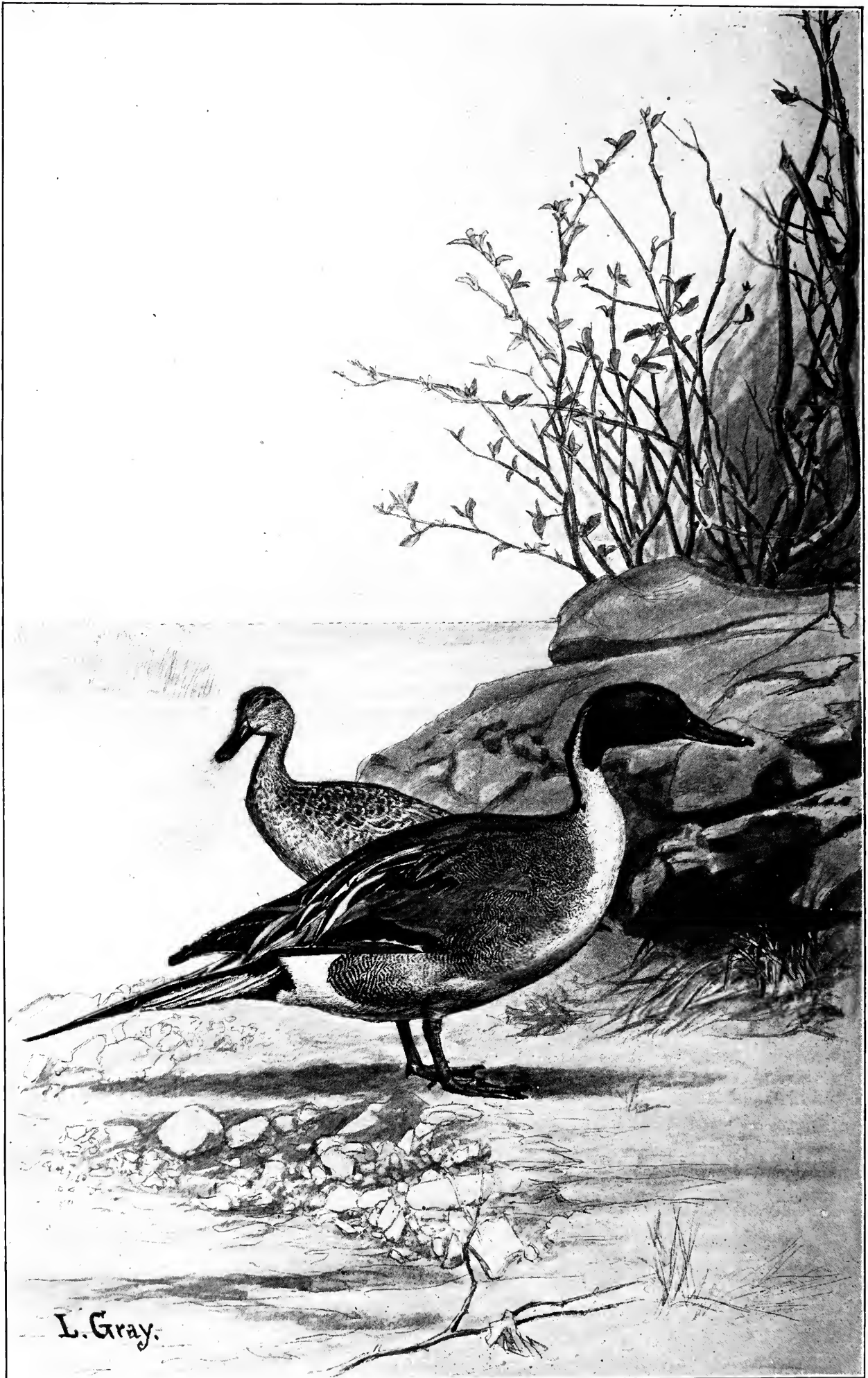

PINTAIL DUCK. *DAFILA ACUTA*.



YELLOW LEGS. *TOTANUS FLAVIPES.*



Miss Gertrude Lynch
roasted the Camp Fire Club
in the New York Sun, and the Camp Fire Club is now waiting
for Miss Lynch to come to dinner.

THE FLORIDA KID.

CHARLEY APOPKA.

X.

The nex' day we didn't do much, 'ceptin' tend ter the traps. We got 3 more coons, an' Mr. Sam cut a turkey's neck off with 'is Winchester. A Winchester is the slick-est thing I ever seen. Look like its got sense, same's a human; fer when you work the lever, it throws out the empty shell, an' takes a hold of a good one, an' puts it in the right place, an' never fails.

That night they was low clouds a flyin' up from the Southwest, an' pa said he reckoned we'd git that rain we was a wish-in' fer, an' he said if it 'ud turn off cold after it, we'd kill 3 or 4 deer an take home with us. Shore 'nuff, before day it commenced ter rain, an' I woke up an' heerd it a patterin' on the tent over my head. I shore love ter lay in a warm bed in camp, an' hear the rain, an' know it kaint git to me.

"Ter-morrer," sez pa, "we'll have a go at the old varmint, an' the day after, if it turns cold, we'll all take ter the woods, an' see'f we kaint git a load of venison ter take home."

Long erbout 2 o'clock, the wind got around inter the Northwest, an' the clouds begun ter break, an' Uncle Dick said it 'ud be coldern cats aflightin' 'fore mornin'. Pa 'n me tore fer the traps fer the last time. We found 2 coons in 'em, an' a 2 thirds grown otter. We pulled 'em up as we come to 'em.

We was on our way back ter camp, an' pa was a totein the traps on 'is shoulder, an' I was a carryin' his gun an the hides, an' a little buck jumped outen the bushes right at us, an' run quarterin off. Pa sez, "B-a-a-a," an' he stopped right still, an' went ter lookin' round.

"Shoot 'im, son; shoot 'im, drap yore hides, an' aim fer his flank," pa whispered.

The little old deer weren't over 50 yards off, an' I 'membered what Uncle Dick said 'bout gittin me a rifle if I killed a deer. Seem like it sorter steadied me, fer I weren't no more excited 'n if I was aimin' at a killdee. I fetched 'er ter the right place, an' pulled down. 'Er-r-o-o-o-m, 'er-r-o-o-o-m, with both barrels, an' the old gun like to a' kicked me down.

"He's down, you've got 'im," pa hollered. Run an' cut 'is throat, but look out he don't strike yer with 'is feet."

An' I laid the gun down, an' run to 'im, but 'fore I cud git there, he riz to 'is feet, an' went a runnin' off with is tail down. I dashed after 'im, but pa hollered ter come back, an' I was shore the chawed boy an' I wouldn't fool yer. I seen my rifle a disappearin' over the horizon, as the sayin' is,

but pa said he was hit bad, an' we'd shore git 'im.

We set down an' waited 'bout 10 minutes an' then started after 'im. Where he fell it look like a quart of blood had been spilt, an' there was a plenty on the grass an' leaves ter trail 'im by. We follered the trail toward a little bayhead 'bout a quarter off, an' we found 'im in a gully that run out of it. Look like he'd tried ter jump it, an' is breath failed 'im. I was shore the tickled boy an' that's a fact. I grabbed out my knife and bled 'im, an' pa 'n me drug 'im outen the ditch an' hung 'im in a saplin, an' took out is innards. His kidneys was nearly buried in fat. Four blue whistlers went plum through 'is liver, an' one in 'is bladder, but he run a quarter of a mile. I'd rub down 'is hair an' feel of 'is horns, an' I reckon I said a dozen times.

"Oh, pa, ain't he purty!" I reckon I was the proudest boy in the world.

Pa taken the buck on 'is shoulder, an the gun in 'is hand, an' I taken the traps an' the hides, an' they made me a purty big turn. It was dark 'fore we got ter camp, but we could see the fire a far ways through the woods. We stopped ever 'casionally, ter rest, an' one time, jest after we'd sighted the fire, we hearn a painter holler, not more'n 200 yards back of us. Well, sir, of all the fusses I ever hearn, that was jest natchelly the scariest, an' if pa hadn't a been with me, they ain't no tellin' what I'd a done. Pa said,

"Don't be skeered, son; he won't bother us, he's thes a follerin' this fresh meat"; but, all the same, I was mighty glad when we got ter camp, an' I reckon pa weren't so powerful sorry, but I don't bleeve he's afear'd of nothin' that draws breath. Uncle Dick sez,

"Doggone yore little hide, you've stuck me fer a Winchester, ain't yer; an you shall shore have it, soon's I sell them steers."

Mr. Sam said when I got that rifle, look out deer an' varmints, fer I was deadly pizen. We went ter whittlin' steaks offen my deer, an' we fried up a whole hind quarter, an' it seemed like it was the best meat I ever tasted. I fried some of the liver, but it was so strong I couldn't eat it. We told 'em about the painter a follerin us, an Mr. Sam said we could strike 'is trail in the mornin' where we cleaned the deer.

We went ter bed soon's we was done eatin', fer we aimed ter git up 'fore day, an' give the old varmint a run fer 'is money. Uncle Dick said he'd stay an' keep camp fer us.

BRISTLY BUFFALOES

The photo reproduced herewith is that of Dr. William Preiss and Mr. A. C. Bidwell, Buffalo hunters, and a day's bag of black squirrels from Canadian woods. Over 50

squirrels are now exceedingly rare anywhere on this continent; yet 2 men who would undoubtedly claim to be sportsmen, and one of them a physician, go out and kill



squirrels fell to their guns in 10 hours, close to the great game preserves in Western Ontario.

This is another pathetic and disgusting case of the slaughter of squirrels. Black

50 of these beautiful and innocent animals in one day. These men should be ashamed of themselves and I trust we may soon have laws in all the States that will prevent such reckless butchers from gratifying their bloodthirsty tastes.—EDITOR.

Mr. Von Blumer: What sort of a hostess does Mrs. Caterby make?

Von Blumer: Splendid. She made me feel as if I wasn't at home.—Life.

FROM THE GAME FIELDS

The man who quits when he gets enough, with plenty of game still in sight, is a real sportsman.

KELLEY KICKS.

In November RECREATION there appeared an article on moose snaring in Nova Scotia. The story is based on the report of the Nova Scotia Game Society, and on my personal observations. It is truthful, temperate, and was written with the intention of awakening the people of the Province to the inhumanity of the practice, its general prevalence and the need of greater energy in suppressing it.

That the intent of the article was understood and approved by Nova Scotians in general is proven by its having been reprinted in full in several Nova Scotia newspapers, by its commendation in the Game Society's report for 1902 and by the receipt of an endorsement of the article signed by a group of the Society's agents.

The Weekly Courier, of Digby, Nova Scotia, published in full my moose snaring article in RECREATION and showed by the frank avowal of its truth and justice a commendable editorial spirit. This paper is published in the heart of the snaring region and such an editorial can not fail to have a good effect just where it is most needed. After publication of the article mentioned I received from the Nova Scotia game wardens a complimentary round robin, and letters from several individuals, showing conclusively the value of RECREATION'S wide circulation in furthering reform methods.

The report of the Society for 1902, although it shows a growing energy in the matter, gives a list of only 5 convictions for snaring. This proves the soundness of my position.

There is, however, one man in the Province who did not relish the frankness displayed in the treatment given the subject. This man is a member of the Society's Council and a game agent. His name is C. R. Kelley, "Yarmouth Kelley," they call him at home, and they smile when they say it.

Kelley has always displayed a genuine zeal in the sale of game licenses. Fortunately for himself he is situated where he can meet the incoming hunter at the Yarmouth wharf and induce him to take out his license before going farther. Incidentally there goes into Kelley pockets a snug commission on the fees thus collected. Thus he feels a lively interest in the reputation of the Province as a game country. He has not figured prominently in the brief list of prosecutions for illegal hunting. In fact, his name does not appear at all, in this

connection, in the reports for 1900-1901. In the sale of licenses he looms up well, having disposed of 13 out of a total of 30 in 1900 and of 27 out of 67 in 1901. In 1902 he sold 18 out of a total of 59. It may seem rather hard to deprive the other 20-odd wardens of their fair share of these commissions, but Kelley knows his business and charity begins at home.

In 1902, Kelley, or rather men employed by him, actually secured evidence to convict 2 moose snarers, his first real success in this line, and no doubt this turned his head. Then he read the article in RECREATION and got mad. He saw danger menace his commission business; saw possible visitors shun the Province; saw his principal source of income fade away like smoke; and he took his pen in hand. He wrote a reply to me, sent it to an editor, and it was published. It is an incoherent, rambling mixture of cheap insinuation against me, a denunciation of certain alleged license-evading Yankees and a big advertisement of Kelley's own work!

He does not deny the essential points of the article in RECREATION, for that is straight goods, and Kelley knows it.

Not to detract by any means from the magnificent work of such men as Daley and Jenner, of Digby; Pritchard, of New Glasgow; Hunt, of Milton, and one or 2 others, who are hampered in working against odds by insufficient funds and a lack of organized support, it remains a patent fact, to anyone familiar with the conditions, that the majority of the game agents do not attempt in any determined or systematic manner to stop the snaring and other abuses carried on under their very noses. In one locality where snaring was found most prevalent the game agent reported that none existed. The snaring and driving of moose exist to-day in Kelley's own district; not spasmodically, nor practiced by one or 2 men, but by many who could and should be put out of business. Kelley would have us believe it requires the ability of a Roberts of Candahar to outwit and convict the rascally snarer.

I lay no claim to any detective ability, but from my own experience I know that nerve, a little patience, the aid of a camera and a knowledge of the scene of operations, common to frequenters of the woods, are all the equipment required.

When the article in question was written it was not deemed necessary to give the precise localities where moose snaring is being carried on, nor the names of those

persons known to be engaged in the business. For equally well-considered reasons the fixing of responsibility for failure to attack this evil vigorously was not placed on individuals, but was charged to the Game Society collectively.

However, if Kelley or any other official of the Society doubts my sincerity or the accuracy of my statements, a mere word to the editor of RECREATION will result in placing before the public not only the details purposely omitted, but certain other facts connected with the subject which may prove entertaining and instructive.

The license fee for hunting big game in Nova Scotia is \$40. Big game means moose, as caribou are practically extinct and the few deer are under timely protection. This fee seems large to an American familiar with the rival claims of Maine and New Brunswick, where the fee is less. Still, no one but a poor type of sportsman would enter the Province to hunt and evade the fee which the law imposes. I join heartily in all the invectives Kelley heaps on this class of Americans wherever merited, though I can but feel, as Kelley waxed wroth over the matter, that it is the loss of his coveted commissions rather than the actual law breaking which moves him so deeply. If the Game Society would only demonstrate its efficiency by correcting this abuse, as well as that of snaring, it would merit and receive the commendation of all law-abiding American sportsmen.

I do not wish to be understood as belittling Mr. Kelley's work. He is evidently an active, pushing sort of man who, once started on an undertaking, perseveres to the end. His success in acquiring a corner on license fees demonstrates this fact, and I hope his 2 convictions of last year may only be the forerunners of many to follow. His slurs on the standing or sincerity of a man who, though an American, is laboring faithfully and honestly in the good work of game preservation in Nova Scotia are in bad taste.

Ernest Russell, Worcester, Mass.

NEW PATENT TENTS.

720,344. — Canvas Covered Knockdown House. John H. Hagedorn, Cleveland, Ohio. Filed July 15, 1902. Serial No. 115,645. (No model.)

Claim.—1. The framework for a canvas house comprising the upper and lower horizontal pieces, metallic straps uniting said pieces at their corners, and sockets for the corner posts formed within such corner straps, top and bottom.

2. The frame described having base pieces with sockets in their corners and straps on the outside connecting said pieces around said sockets, the top pieces of said

frame having inside and outside straps connecting their corners and the inner of said straps bent to form a socket in its angle, and the corner posts socketed within said straps, top and bottom.

3 A suitable frame having vertical sides, in combination with a canvas covering the

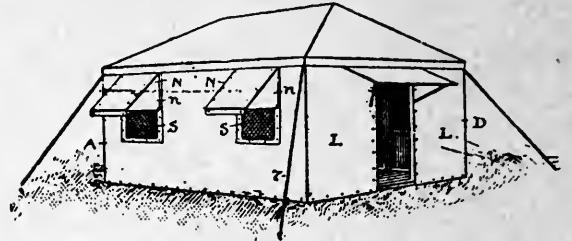

side of said frame formed in a single piece and provided with openings between its ends for windows, and having buttonholes to fasten it upon said frame.

4. A suitable frame having a truss on the top thereof, in combination with a canvas top stretched over said truss and having an inside flap with buttonholes to secure it upon the top of the frame, and the said canvas top overlapping the lower edge of said flap, and the buttons to which it is secured, thereby shedding the water, and the side wall of the house overlapped by said top.

5. A suitable skeleton frame and a canvas wall having openings for windows, and a covering for said windows consisting of an awning having buttonholes in its edges adapted to be fastened down upon the window and closing the same, said awning provided with a suitable brace at its bottom to hold it open.

6. The house substantially as described, having a canvas wall with window openings and a framework about said openings, provided with buttons, and a window screen having buttonholes in its edges engaged on said buttons.

721,993. Tent, Canopy, or Awning. Effie Arnett, Lincoln, Neb. Filed March 20, 1902. Serial No. 99,158. (No model.)

Claim.—1. The combination with a supporting frame having oppositely extending

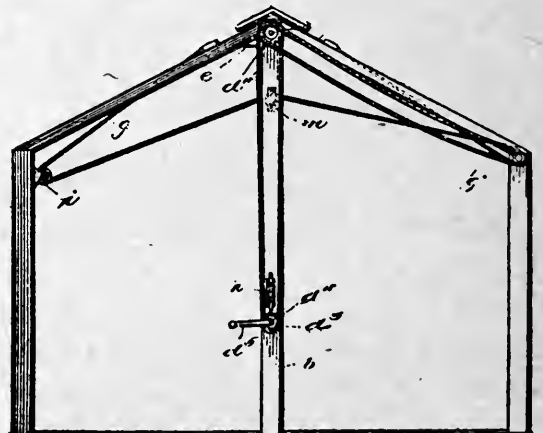

portions at opposite sides of its ridge, of a longitudinally arranged roller constituting the ridge pole of the frame structure, separate canopy flaps arranged to simultaneously wind and unwind on the ridge pole roller and provided at their outer edges with carrying bars guided on the oppositely extending portions of the frame, a second roller carried by the supporting frame, operating ropes or cables winding and unwinding on said second roller and having connections respectively with the carrying bars of the separate canopy flaps, said ropes or cables being arranged to provide for simultaneously drawing out the canopy flaps in opposite directions, and a driving mechanism having geared connection with both the ridge roller and the said second roller.

2. The combination with a frame of a roller forming the ridge pole thereof, 2 flaps having their inner edges secured to said roller, an operating crank and sprocket wheel operated thereby geared to said roller, a sliding locking bolt co-acting with said sprocket, a second roller geared to the first, a rope secured to the edge of each flap and wound on the second roller, and guide pulleys for one of said ropes, one of said pulleys being arranged on the opposite side of said frame to said second roller.

720,445.—Portable Pleasure Tent. Christian U. Kreig, Sr., Nashville, Tenn. Filed February 1, 1902. Serial No. 92,200. (No model.)

Claim.—1. The combination in a pleasure tent of 4 supporting legs, connected at the top and an awning-distending frame comprising pendent bar H, 2 braces A³ A³ on

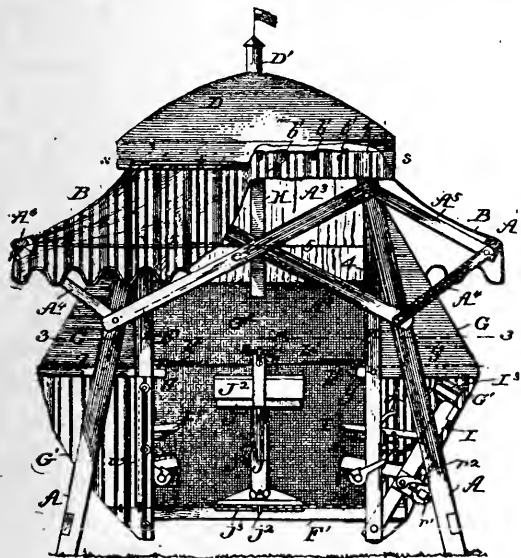

each side, having their middle parts bolted together and to the pendent bar and their outer ends bolted to the corner posts, the projecting cantilever bars A⁴ A⁵ bolted respectively at the ends of the cross bars

and at their outer ends to each other, cross bars A⁶ mounted on said outer ends and an awning distended over the cross bars and cantilever projections.

2. The combination, in a pleasure tent, of the 4 supporting legs, having cantilever projections at the upper ends of the same and a rigid rectangular framework connecting the upper ends of the legs, an awning B extending over said cantilever projections, and a cupola top having a pendent skirt extending down over the upper edges of the rectangular frame and awning.

3. The combination, in a pleasure tent, of the 4 corner legs, a framework connecting the upper ends of the same, a horizontally projecting frame at the top of these legs, an awning distended over said frame, a separate cupola surmounting the awning and overlapping its upper edges and a separate interior canopy C.

A CONTRABAND ABATTOIR.

There is a wilderness of 40,000 square miles in Idaho and Montana that is not penetrated by a wagon road. A large portion of this area is now a forest reserve. At the same time it is a natural game preserve. A united campaign should be organized by the sportsmen of the United States to establish game protection on all timber reserves. Although this great Idaho wilderness has been a natural game preserve in the past, the discovery of gold in the heart of the untrodden region has brought a ruthless destruction of game. The Thunder mountain stampede of the summer of 1902 caused the Salmon river basin watershed to be overrun by a murderous class of pilgrims. The true Western mountaineer never slaughters the game. He is a lover of nature and he regards the game animals of the wilderness his heritage. This mountain fastness has been traversed by the prospectors for 40 years, and the camps of the placer miners are often the playgrounds of the fawns, while the timid mother-does defy the intruders by stamping their feet at them as they go about their work. The humane prospectors have made the deer in the remote sections of this wilderness as gentle as sheep on the old homestead. The pioneer, it is true, supplies his larder from the wild herds, but he selects his victims with judgment and never butchers the mother of a helpless fawn at least.

During the past summer I saw many tragedies. Starving fawns were often found by the side of a dead mother-doe that had received a mortal wound at the hands of a tenderfoot. It is estimated that 5,000 deer were killed in the Thunder mountain district alone in 1902. When the advance of the stampede entered this home of the deer, the unsuspecting animals were

as gentle as dairy cows in a meadow. It is true that the gold hunters were confronted by a meat famine. All food that was consumed by thousands of men from February till June was either carried over 100 miles on snowshoes, or unlawfully supplied from the game of the forest. The mountaineers, who had been accustomed to the selection of game animals, chose their victims carefully; but the tenderfeet shot recklessly and indiscriminately. It was not uncommon to find dead does that had been shot and left where they fell, after the discovery that they were nearing the close of the period of gestation; or sometimes fawns might be found dying beside the carcass of a mother from which the hams had been cut and carried away. The men who committed these murders were invariably from the cities and the Eastern States, and had not been accustomed to the conservative practice of butchering wild meat as they would kill domestic animals on the farm.

At the town of Roosevelt, in the Thunder mountain district, the sacrifice of game became so shameful that the old mountaineers and the merciful sportsmen revolted against the practice. There was no game warden or even constable to whom an appeal for the enforcement of law could be made. Public sentiment was weak in the face of the necessity of the occasion. The old prospectors who had seen these herds multiply and grow gentle from merciful treatment suffered from the constant evidence of ruthless slaughter. Thorough investigation revealed the fact that the indiscriminate killing, especially the wounding of does while they were worthless for the larder, was largely due to the uncontrollable impulse of the tenderfoot to kill everything in sight, and to the excitement which made it impossible for him to discriminate between a buck and a doe or a fat and a poor animal. It was, therefore, determined by the prospectors and experienced sportsmen to supply their neighbors with the best quality of venison free of charge if they would use their influence to prevent the killing of does in the late period of gestation and early periods of motherhood. It might be said that a contraband abattoir was conducted for 2 months, and in a spirit of mercy.

It was found easy to promote sentiment against the indiscriminate tenderfoot murder of mother-does and the starvation of fawns, but it was found impossible to control the man who was subject to buck ague when he was brought in contact with the wild herds of the mountains. I saw more than 100 does that had been shot to death and either left where they fell by the conscience-stricken hunter after he had discovered the enormity of his crime, or that

had been mortally wounded by a tenderfoot who had buck ague too badly to make an accurate shot.

These deer were of the blacktail species, and they were as gentle as domestic sheep. I have counted 300 in one day during a journey along a trail of only 15 miles. The ordinary Eastern man never passed one of these animals without trying to kill it. One day generally exhausted the supply of rifle cartridges, after the deer country was reached. The price of 30-30 shells ruled at 25 cents each for 3 months in the Thunder mountain district last summer. Only the bad marksmanship of the tenderfoot and the scarcity of ammunition prevented the annihilation of the deer of that vicinity in one year. Wild goats and mountain sheep were more shy and therefore more secure from the merciless tenderfoot. Hundreds of moose and elk were killed, notwithstanding the strict protective statutes of the State.

Could there not be an effective campaign organized for the purpose of enlisting the forest reserve commission in the interest of game protection on the forest reserves? On the reserves in this section of the West the game is worth more than the timber. The lumber monopolies seem to have defined the boundaries of these reserves in a manner that left the timber outside of the limits.

Newton Hibbs, Salmon, Idaho.

SPORTSMAN APPEALS TO TEXAS.

I have just read in a weekly paper this statement:

"Texas, if she is not ready to stop the sale of game, is at least going to try to qualify its sale and to limit the legal bag."

I am most thankful to hear it. I have been a sportsman all my life. Twenty-five years ago, as a boy, I came from England to Texas. I have always delighted in visits to the Lone Star State. From that time to this I have frequently returned there on hunting trips, but it was not until last autumn, November, 1902, that I received the greatest shock of my life in a sporting way. I had been staying in Austin. I went to Rockport, on the coast, for ducks. I had been directed to a place 8 miles from the town. I had intended to remain there 5 days at least, but the things I saw and heard so shocked and disgusted me that on the second morning after my arrival I left, heavy hearted and filled with ire toward the pot hunters. I had fallen in with such a family. It was supposed to be a place where sportsmen might find comfortable lodgings and have duck shooting from blinds for a total expense of \$2.50 a day; but on reaching my quarters I found the arrangement required was this: Kill all

the ducks you can and give them to the pot hunter who has made this most reasonable rate of \$2.50 a day to hunters on this condition.

I found the order of each day as follows: The pot hunter and his 2 sons breakfasted long before daylight and were in the blinds by sunrise or before. By long years of constant practice they had learned to call artificially every duck that utters a sound. At half a mile they were able to recognize at sight the different varieties of ducks on the wing; redheads, bluebills, canvasbacks, mallards, etc. When ducks came in sight, the boy in the boat with me, an expert at calling, would at once pipe up, and if he could make the ducks hear, 10 chances to one they would swerve, circle over us, and come down among our decoys. Then the young demon would show great anger, though I was a paying sportsman with, as I supposed, merely a boy in attendance, if I attempted to shoot before the ducks were on the water, well settled there and bunched.

One day the 2 brothers, with pump guns, killed at one double shot 53 ducks. They told me they and their father have killed for many years an average of 10,000 ducks each season; and they evidently never dreamed of anyone's objecting, or regarding it in any other way than with admiration.

Every night, after all hands are in from the day's hunt and the various bags of ducks have been piled together in the wagon bed, the drive is made to Rockport to cold storage rooms, where a man stands in readiness to check off the ducks as they are unloaded; sprigs so many, gadwalls so many, mallards so many. These all bring various prices, canvasbacks the highest, redheads next, and so on down the scale.

My eyes were opened to the horrors of pot hunting and the beastly, degrading effect it seemed to have had on the men. Not the life of a living creature that runs or flies was regarded by them. They never allowed a bird on the wing or a quadruped on the run to go by unharmed. With an oath and a coarse laugh the boy with me would let drive at every pelican, heron, loon, cormorant that came within reach of his firearm, leaving the bird, after wounding it, unnoticed on the water, to die or flutter away. I had an experience I trust I may never have again, and I would rather put my gun away forever than take a small part, even under protest, in such carnage as I witnessed while spending 2 days and a half with this family of pot hunters.

Not long ago I read an article under the caption, "Why Is Duck Hunting on the Wane?" I have given you here a good part of the answer. How can duck shoot-

ing go on for any length of time at this rate without waning? I have told you of the routine of life, through the entire winter months, of one family. How many more families on the Texas coast are doing the same thing? Making a living by destroying ducks and geese daily at wholesale, and killing every other living thing for practice or through sheer wantonness?

I sincerely hope the State of Texas will speedily take some steps to stop this shocking slaughter of game; and I wish that any sportsman who has it in his power to do anything in the matter might have his blood heated to the boiling point, his ideas of decency and moderation shocked and his activities aroused as I had by a 2½ days' visit at a pot hunter's abode in Texas.

H. M. Dumbell, Great Barrington, Mass.

ON THE STINKING WATER TRAIL.

I am not certain but I invite a roast by giving you an account of a trip I made to Wyoming last fall. I started out to get an appetite and some sport at the same time.

Arriving at Red Lodge, Mont., I fell in with Jim McLaughlin, one of the best known guides in Wyoming, who had just got in with a party from Illinois, and having nothing in sight for the next few days we soon came to terms for a trip to Jackson Hole.

On the evening of the fourth day we arrived at our guide's house, wet through, tired and hungry as bears. By the time we had the horses cared for Mrs. McLaughlin had a roaring fire in the sitting room, and when we were warm and dry they called us in to supper. This was not camp-out grub; fresh butter, eggs, milk, fried trout, roast elk, white and brown bread, preserves, fruit, and I do not recollect all of it, but it did not take long to get rid of that hungry feeling.

This was as far as we could go with a wagon, being up on the head of South fork of Stinking Water and about 20 miles up from Ishawood, P. O., where they get their mail. The next morning, while Jim was getting our pack train ready, Mrs. McLaughlin got out his Bristol steel rod for me, and off I went to try my luck on trout. On the road coming in Jim had told me that he would like to let me have this rod, but as I never had used one he did not think it safe in green hands, and seemed to think that a willow would about fit me. I thought it too good a joke on him to miss, and saying nothing about our previous conversation I shouldered the rod and went to the creek. Following the stream about 2 miles I commenced to fish back. Long before getting back to the house I had all I could carry, about 100. Some we cleaned for immediate use, and about 30 Mrs. McLaugh-

lin put in pickle to be ready for me on my return home a month later.

Our pack train then being ready, we started for the divide, which we crossed the second day. We were then in elk country and went into camp. By 9 the next morning I had a fine elk turned up to cool, which Jim and I skinned after dinner and took down on the pack horses.

That night came a light snow. Next morning I was out bright and early. The first track I struck was a mountain lion's, but the sun spoiled the trailing, and hearing a bull elk whistle I left the trail and went after him. I followed him 2 miles. Then, looking over some rocks, I saw not one but 10 cows and one bull. After watching them 5 minutes the cows went down the mountain side, but the bull is looking down at me from the wall as I write this; the head is a proud trophy.

Next day we moved camp 15 miles. I started out to get the lay of the country before night. About $\frac{1}{2}$ mile from camp I ran on a bunch of elk and before I took a second thought I had 2 down within 5 rods of each other. I felt ashamed of myself and determined that I would not kill another one while in the mountains. Next morning we skinned them and took the meat and hides to camp. The next 2 days it snowed and we packed up and rode 3 days in a hard storm. In places the snow came up to our saddles, but being light the horses could wallow through it.

Just as we got over the divide and started down the cañon we came face to face with a big bull elk. He turned and went down the trail we were on, and I think for the first mile jumped 30 feet at a clip. His trail crossed ours back and forth for 5 or 6 miles, but as we were not hunting elk then we paid no attention to him.

The third day from camp we pulled in at the ranch. By this time I had got a mountain appetite, and didn't I hide the good things Mrs. McLaughlin set out!

After resting 2 or 3 days, we started for the railroad, 110 miles North. I got home 15 pounds gainer.

The gun I used was a 30-30 special light Winchester. It is as big as a cannon for all practical purposes. I expect to go over the same territory for a good long vacation next fall, and if you know of any good party contemplating such a trip, should like to correspond with him, with a view of joining, as a party of 4 or 5 can have a better time and reduce expense.

D. Morrill, South Omaha, Neb.

A COOL MOUNTAIN RETREAT.

The summer of 1898 was said to be an exceptionally hot one throughout the United States, but we who stayed in the mountains of Colorado knew little about it ex-

cept through the newspapers. In the upper Arkansas valley, 35 miles below Leadville, where the blue sky is shut out by a canopy of spruce boughs, you can fish in streams flowing down straight from Nature's refrigerators.

The valley from Salida to Buena Vista and beyond, is broad and fertile, and cut with ranches and irrigating ditches, but to the Westward in a jumbled mass, split by forest-skirting canyons, and surmounted by stupendous peaks, rises the Continental Divide. Perhaps not one tourist in 100 knows that from the rugged headlands far above them, spiked deer and mountain sheep look down on the rushing trains, while coyotes lope through the pinyons at the sound of the locomotive whistle. To know and appreciate Colorado thoroughly you must camp here awhile; not pass through on the wings of the wind.

My experience with that section of the Rocky mountains embracing the 3 Collegiate peaks, Mounts Princeton, Yale, and Harvard, opposite Buena Vista, has covered 3 years' of short enjoyable excursions into their hidden recesses. In a 2 hours' ride from the D. & R. G. R. R. tracks I have startled the deer from his bed, and plunged into sylvan depths where the song of the pines and the rustle of the aspens were the only sounds.

One day while among the dwarfed spruces near timber line, I ran into a magnificent flock of grouse, that took to the low branches about me. I had no gun, nor did I wish for one, but lay on the needle-carpeted ground and watched "Hiawatha's chickens" as they played hide and seek through their evergreen cover.

They were so innocently tame that I doubted if they had ever seen man before, or been frightened by the explosion of a cartridge. Going out on the bald cone of the mountain for a better view, I startled numberless conies among the rocks, which disappeared into convenient crevices with indignant chattering. Through a field glass I swept the world below me, and at last my gaze rested on a serrated peak half a mile away across a precipitous canyon.

There, on a pinnacle, gazing down into the depths below, stood a hoary mountain sheep.

No finer horns ever crowned the head of one of these mountain sentinels than he wore, and I hope they will never grace a museum other than nature's, until the wearer has died a natural death. Sliding down into the canyon, ankle deep in loose shale, I found cool ledges of dripping ice and snow at the bottom, showing how rivers are born. Descending the gulch green timber appeared, and the mossy banks of a silvery stream deadened my footsteps like moquette carpet. At every descending rod

new flora appeared, and a changing orchestra of birds flitted among the tree tops. From beds of sweet ferns, shaded by tall spruces, I passed stooping under the sweeping branches of alders and willows, and swinging around the white trunks of green crowned cottonwoods.

In a little open glade I lay on a log dam that churned in the whirlpool of the creek current, and saw mountain trout fanning the limpid water. It was evening when I left the beautiful wooded foothills to the Westward, and crossing the mesa brilliant with its covering of yellow cactus blossoms, tried to make friends with the wild doves that arose in whirring flocks from my feet.

Although I carried in my hand nothing more formidable than a bunch of Columbine, I think the poor doves, having been deceived so often, considered me their enemy and so flew away to the pinyons.

I wish more readers of RECREATION could enjoy our Alpine scenery with its cool summers as I have. It banishes lassitude and acts on the body as a Ponce de Leon spring.

I like RECREATION because it breathes love and kindness toward our fast decreasing wild birds and game.

Geo. E. Newell, M. D., Buena Vista, Colo.

ON THE SUSQUEHANNA FLATS.

Probably no shooting in the country is better known than the flats of the Susquehanna river; and certainly no other game holds as high a place in the affection of both sportsman and epicure as the canvasback duck.

The flats extend from Havre de Grace down the bay about 10 miles, and cover nearly its whole width. On them grows the wild celery which gives to the canvasback its unrivaled flavor. It grows below the surface, and the duck has to dive for his dinner.

Opening day on the flats is an occasion of great interest to sportsmen. Many yachts from distant cities come up the bay, and anchor off Havre de Grace in time for the first day's sport. Shooting is allowed only on Mondays, Wednesdays and Fridays, and the first of these days in November sees the commencement of the season. Boats are not allowed to cross the imaginary line which bounds the flats before 5 a. m.; but all the night before they are waiting, each trying to get a position of advantage. At 5 the boats cross the line, and there is a great rush to get the places considered best.

Duck shooting on the flats is pursued chiefly in 2 ways; by sink boxes and by bushwhacking. The sink box is simply a box just big enough to contain a man lying down. It has flaps, extending from the side at the top, which keep it from sinking entirely. This unwieldy contrivance is car-

ried to the desired position on a boat, and is so adjusted as to be flush with the water, when occupied by the shooter. Around it are placed the decoys. The shooter gets in, lying perforce on his back, and waits for a flock of ducks. When they come, he rises to a sitting position and pours his broadside into the flying birds. The experienced hunter can get 2 guns into operation on the same bunch. This is the most deadly method of shooting for the practised hand, though rather awkward for the beginner. Of course the sink box must have a row boat in attendance to pick up the killed and crippled. With such an outfit more than 100 ducks are often bagged on one tide.

In bushwhacking, the gunner sets out his decoys, some 50 or so, and rows off a considerable distance. When he sees a bunch of ducks alight he quickly and noiselessly sculls his boat up to them. If fortunate, he may get some good shooting, though frequently the ducks rise out of range, especially if they have been much shot at. Of late years launches have been used with considerable effect in bushwhacking. A launch, with noiseless engine, steals up to the ducks before they are aware of it.

There is an illegal method of shooting called big gunning. This requires a small skiff in whose bow is placed a swivel gun of about No. 1 bore. During the day the hunter locates a large bed of ducks. At night he paddles his skiff up and discharges his cannon broadside into the flock. The result of such a shot is murderous; scores of ducks are often picked up, besides the many crippled which must necessarily be lost. After getting his ducks the pot hunter makes his escape as soon as possible. Of course this is the rankest form of slaughter, and no punishment is too severe for the offenders.

The shooting continues to late afternoon, until the sportsman has had enough, or oftentimes considerably more than enough. There is one weather condition, however, that can almost completely ruin the shooting, and that is fog. In foggy weather there are few ducks on the wing and those that are moving will not decoy. The opening day in '02 was of such a nature and as a consequence few ducks were brought in.

Duck shooting everywhere possesses a fascination for the hunter; on the flats it becomes a truly royal sport.

James A. Newell, Princeton, N. J.

THE GEYSERS WILL KEEP.

Captain H. M. Chittenden, U. S. A., in charge of improvement of Yellowstone National Park, in a recent letter to the New York Herald, says:

There was recently published in a French scientific paper, *Ciel et Terre*, of Paris, an article

on the Yellowstone National Park, in which the writer, who had lately visited the Park, holds that the geysers are rapidly approaching extinction. The article has been widely copied throughout the United States, and has gone a long way toward creating an impression that the Yellowstone wonderland, so far as relates to the hot springs and geysers, is practically a thing of the past.

Both in his premises and conclusions the author of this article is wholly astray, and it is a good example of how even a scientific observer may draw wrong conclusions if he fails to examine all sides of a question. A few examples will illustrate.

Roaring mountain, which the author of the *Ciel et Terre* article did not hear roar, never roared to any noticeable extent. Some enthusiastic explorer in past years happened by this hill when there was an excessive escape of steam, heard the loud, shrill sound which it caused, and dignified the hill with the name of Roaring Mountain. But it is doubtful if any one has ever heard it roar any more than it does now; certainly it is as active as it has been for 15 or 20 years past.

The Growler is another example in which the author's conclusions are exactly the opposite of the facts. This steam vent has quadrupled in power in the last 10 years. A close observer would have seen this if he had taken note of the great destruction which is going on in the surrounding trees. There are several acres of ground around this spring on which the trees have been killed during the last 6 years. Obviously its force and volume have greatly increased, or its destructive influence would not be so much extended.

A little inquiry would further have shown this investigator that close by the Growler the government has in recent years been compelled to change its road because of the outbreak of new springs and geysers of great energy and power. In fact, this entire basin, called the Norris Geyser basin, is steadily increasing in activity.

The old Fountain geyser, in the Lower Firehole basin, has indeed become extinct, but its energy has been transferred to another near, which appeared simultaneously with the disappearance of the old.

The Great Fountain geyser displays the same activity that it did when described by Folsom in 1869. Excelsior geyser has erupted but 2 or 3 times since the discovery of this region. It is the most powerful geyser in the Park, and during its last eruption it burst through the rim which separates it from Firehole river. This let the water in the pool escape and lowered its level several feet. The relief of pressure thus brought about, very likely accounts for its failure to erupt in recent years, but its volume of discharge is as great as it ever was.

Old Faithful shows no perceptible change in regularity or height of eruption. The Bee Hive is less frequent in eruption than it used to be, but others in the neighborhood are more active.

Geyser action on the shore of the Yellowstone lake is more vigorous than it was 10 years ago. Mud geyser in the last few years has shown more violence and power than before. The springs on Sulphur mountain appear exactly as they did 10 years ago. The various features throughout the Park known as "Paint Pots" show no perceptible change.

The Mammoth Hot springs show more change than any other feature; but this is due to migration rather than extinction. While the springs on one side are dying out, those on the other are increasing, and it is difficult to say on which side the balance lies.

To those long acquainted with the Park the changes do not appear extensive. The total sum of thermal energy displayed seems about the same as it was 25 years ago. Springs die out and others take their places, and there is a constant change of this sort going on. If an observer

wishes to make out a case on *ex parte* testimony that the geysers are becoming extinct, he can easily do so. With equal ease can he make out exactly the opposite case.

It is entirely probable that the broad operation of general causes is on the side of ultimate extinction of all thermal activity in this region. The evolution of the earth is in that direction. But the process is a slow one, and the tourist in the year 2000 will find things in this region much as we find them to-day. Apart from the geysers and hot springs the other scenic attractions remain the same, but are more accessible than ever before, while the function of the Park as a game preserve is yearly increasing in importance.

A POOR SHOT THAT SCORED.

We left Boston Tuesday afternoon on the steamer "Boston," of the Yarmouth line, and were glad to escape the covert jeers of those friends to whom we had confided our intention of returning with a moose. Their jibes grated on our ears, for we were off to Nova Scotia, and a moose we were going to have if there was one there. We landed in Yarmouth the next morning about sunrise. A ride of a few hours by rail took us to our destination, Indian Gardens, on the Liverpool river. There we found our camp and the best guides in the Province. Soon Sam Freeman and Bordie Hunt had supper ready, and Tom Hunt and his brother Lem had our beds fixed.

Scarcely had we fallen asleep when we heard our Indian guide trying his new birch bark moose call to see if it would work and if there were any moose around. I rushed from the tent, and far in the distance heard a muffled answer. It gradually drew nearer and louder. Then all was still. The Indian beckoned to me, and taking my rifle, I followed him as silently as I could. We crept to the shore of the lake, got into a canoe, and the Indian paddled around until we were in the deep shade of trees overhanging the water. Then we waited. Occasionally the Indian used his call and gave a low, muffled roar and grunt that woke echo after echo from the farther shore.

I watched the Indian's face by the moonlight. Once more he called. Quickly came the answer. The moose was coming down to the opposite shore of the little bay. We could hear the twigs break as he plunged along. The guide swung the canoe quietly around. With a rush and a grunt out came a large bull moose, his huge form outlined against the dark trees behind him. The guide made signs to me to fire. Should I? Could I? Why is it I could not get the rifle to my shoulder? The guide saw me tremble and hesitate. He reached for my rifle with the only determined look I ever saw on his swarthy face and he muttered,

"White man big fool. Go hunt moose. then go get buck fever, then go lose him all."

That was enough; I managed to get the rifle to my shoulder and to fire. Bang! A rush and roar and the sound of hoofs breaking branches; a thud; another rush. With a grunt the Indian sat down.

"Now, Neul," I said, "put me ashore and let's find the moose." Old Neul gave another grunt and began to paddle toward camp.

"Guess white man must want die bad. Injun no find moose now."

At daylight we set off to find our game. In about 30 minutes we came to a place where the ground was torn up and the small trees beaten down. There lay the dead moose, and I had really shot him. The Indian smiled. "Mean, poor shot," he said, and then began to skin the animal. But I had killed my game and could afford to disregard the Indian's sneer at my shooting.

A. T. Kempton, Fitchburg, Mass.

IN THE MOUNTAINS OF WEST VIRGINIA.

For several weeks my neighbor, Harry Cannon, had been planning a trip with me to a region where, so rumor had it, numerous bear and deer had been seen. November 6, 1902, we left our home at Harrisville, and on the second day we were in the Williams River country. Saturday, after fixing up our camp, we took a turn in the range with no result save that we saw one deer. Sunday we rested from our labors. Early Monday morning we were on choice stands, 1½ miles apart, with our guide in the bush, assisted by 2 drivers.

I was posted at a spot where, 2 years before, 3 bears were killed at one time. After 2 hours of waiting, something made its appearance about ½ mile from me. On first sight I took it for a cow, but, as it was coming directly toward me, I soon saw it was a large bear, the first wild one I had ever seen. When about 175 yards from me instinct seemed to warn him of lurking danger. He rose on his hind legs, turning his shaggy head from side to side. That was my opportunity for a fine shot, but I wanted him closer. Down and away to the right he went, and I decided that it was then or never. I followed on the run, firing one shot from my Savage. He turned again, and taking the back track, was lost to view until he crossed the line of his approach, near the top of the ridge. After him I went, helter skelter, over logs and rocks, through bush and briars, all the time pumping away at my gun. When at last he hove in sight, a snap reminded me that in my excitement I had ejected the other 5 cartridges from my magazine. That snap restored my coolness, and, refilling the magazine, I got in 2 shots that settled the business. The

bear was a large 4 year old. The last shot was precautionary and, as it proved, unnecessary. We spent the remainder of the day in skinning, cutting up and getting our meat to camp.

The next day brought us nothing. Wednesday morning we went up the mountain and took stands 2 miles East of where we got the bear. That was Harry's day, for after a few hours' waiting his patience was rewarded by the approach of a 4 prong buck. It fell in its tracks, shot through near the heart at the first fire.

One more day of unsuccessful hunting, and the next we set out for home, with glory enough to last us till next year.

R. E. L. Frymire, Harrisville, W. Va.

ANSWERING DOUBLE BARREL.

That was an amusing spasm of Double Barrel in the December issue. He intimates that a game hog with a Winchester pump is sure of 6 chickens if he flushes a flock. That sounds all right in theory; but in practice he will find that by the time a hunter has fired the second shot from a pump gun at flying birds, they will have moved out of range. I have a pump gun of the vintage of '85, but have never made a big record.

The second shot from a Winchester can not possibly be fired as quickly as that from a double barrel. The lever action gun must be jerked down from the shoulder for every shot. The sliding action is probably quicker, but not nearly so quick as a trigger pull.

In shooting at a flock of ducks flying on schedule time, a man must make his coat tails pop to fire a second shot before the birds get out of range. When jumping a flock of ducks in a creek or under a bank, they often get up in a scattering manner, and the hunter can sometimes kill with the third shot; but I seldom do, unless I fire the first shot too quickly and without aim. A quail is safe after the first 2 shots.

Every one knows that the original game hog was the old fellow with the double barrel muzzle loader, who sneaked up and ground raked his birds with both barrels. Unfortunately there are a few of them at large yet, and they would all be in jail if they had their just deserts.

Here are some of the good points of the Winchester: It is a close shooting, durable gun at a reasonable price; there is less iron to carry than in a double barrel of equal strength. The magazine can be filled, leaving the chamber empty, then it is a safe gun to carry in a wagon or stand in a corner, and when you grab it in a hurry it can be loaded in a second. The No. 12 is not an ideal gun for a game hog; it shoots too close to kill more than one bird at a shot.

Black Jack, Hopkins, Okla.

GAME NOTES.

I want to say a good word for the much abused fox. He is game to the backbone and affords more sport than any other animal we have in Vermont. He does little harm, and deserves protection rather than outlawry. An old farmer and sheep breeder told me he never but once saw a fox chase a lamb; and, in this country, at least, foxes seldom molest poultry. Their food is mostly mice. An open season from November 1 to February 1 would prevent foxes from becoming too numerous, yet preserve enough to afford delightful sport for the many fox hunters of this State.

H. C. Prindle, West Rupert, Vt.

I have read A. C. Goodchild's story in December RECREATION, entitled "A December Duck Shoot." It seems to me his kill in the morning, of one spoonbill, 2 widgeons, 6 teal, 3 butterballs, one gadwall, one mallard and 4 snipe should have satisfied a reasonable man for the day. It was not enough for Mr. Goodchild, however, for he tells us that late in the afternoon "the air seemed full of ducks. The fun grew fast and furious, and many a sprig, widgeon and teal made the fatal mistake of venturing too near." Reads like an announcement of candidacy for the pen, doesn't it?

C. C. Pickering, Columbus, O.

I should be glad to see a law passed in Michigan allowing each hunter one or 2 bucks only, instead of 3 bucks, does or fawns, as hunters are shooting too many fawns and does. One pot hunter living in Champion told me that before the season was opened he shot 25 deer just for the fun of shooting. Our party certainly roasted him good and plenty, but we could not make him appear ashamed of himself. Charles Lavigne, our guide, has undertaken to report the fellow.

C. S. Monnier, Detroit, Mich.

Game is not so plentiful here as formerly. One of our townsmen, S. B. Wallace, was up in New Brunswick last fall and killed a large moose. He also got 2 deer on the Alleghenies. I was in Georgia last summer, in the mountains among the lumbermen. They were killing turkeys in September. One man told me he had got 3 a few days before. He does most of his shooting with a 38 revolver. He wanted me to go quail hunting; said he knew where there were thousands of them.

L. S. Goodwin, Huntingdon, Pa.

I have lately imported from New Brunswick a pair of red deer. It is my intention to breed them for the purpose of stocking our game districts, now entirely destitute of these animals. I should like to

communicate, through RECREATION, with any one doing similar work. The game hog is comparatively unknown in this part of the country; the chief reason is the scarcity of game.

W. B. Bishop, Canning, N. S.

H. E. Hubbard, of 54 Billard avenue, was arrested Christmas day by Lieutenant Bowen on 3 charges, one of which is the first case of the kind ever brought before the local police court.

The most serious charge against Hubbard is shooting English pheasants, the property of S. L. Burgess, of Kensington avenue. The accused will also have to answer to selling the birds and for discharging firearms on Sunday, 3 distinct offenses. The prisoner was released under \$100 bonds, furnished by Edward Sage, a neighbor.—Hartford, Conn., Paper.

The residents of Okanogan county, Washington, are becoming aware that if they do not strictly enforce the game law, deer and other game will soon be gone. Deer are scarce; there is not one now where there were 5 last year. The only game that is holding its own with the pot hunters and bristlebacks is the prairie chicken.

F. O. Stephan, Chesaw, Wash.

Game was plentiful here last fall. We have kept the Indians out all summer and stopped all market hunting, so the game has had a chance. There were deer and quails around my ranch all summer. The quails are still here, and my little girl feeds them every morning. They are so tame that they come in the dooryard and pick up crumbs.

G. C. Goddard, Harmony, Utah.

Whitetail deer, mule deer, black, brown and silver tip bear are as plentiful as I ever saw them in this country. I was on one bear hunt and found a large brown bear. Sent his pelt East to be mounted. His weight was about 800 pounds.

A. J. Scheibelhut, Newyear, Mont.

William Vivian, of Gloucester, shot a whistling swan here recently, which is supposed to be the only one ever shot in Massachusetts. Does any one know of another being shot in this State?

Oscar Haselgard, Gloucester, Mass.

Please advise fox hunters and wolf hunters that this part of Iowa is well stocked with the pesky varmints. Much to the sorrow of quail hunters, the birds are being killed off by foxes.

D. E. Baird, Arbia, Ia.

RECREATION has made a true sportsman of me. I wish more gunners would read it and learn moderation. I never take more game than I need and always give it a chance for life.

Ralph E. Bassett, Bassett, N. J.

FISH AND FISHING.

ALMANAC FOR SALT WATER FISHERMEN.

The following will be found accurate and valuable for the vicinity of New York City:

Kingfish—Barb, Sea-Mink, Whiting. June to September. Haunts: The surf and deep channels of strong tide streams. Baits: Blood worms, shedder crabs and beach crustaceans. Time and tide: Flood, early morning.

Plaice—Fluke, Turbot, Flounder. May 15 to November 30. Haunts: The surf, mouth of tidal streams. Baits: Shedder crabs, killi-fish, sand laut. Time and tide: Ebb, daytime exclusively.

Spanish mackerel—Haunts: The open sea, July to September. Baits: Menhaden, trolling—metal and cedar squids.

Striped Bass—Rock Fish, Green Head. April to November. Haunts: The surf, bays, estuaries and tidal streams. Baits: Blood worms, shedder crabs, Calico crabs, small eels, menhaden. Time and tide. Night, half flood to flood, to half ebb.

The Drums, Red and Black. June to November. Haunts: The surf and mouths of large bays. Bait: Skinner crab. Time and tide: Day, flood.

Blackfish—Tautog, April to November. Haunts: Surf, vicinity of piling and old wrecks in bays. Baits: Sand worm, blood worm, shedder crabs, clams. Time and tide: Daytime, flood.

Lafayette—Spot, Goody, Cape May Goody. August to October. Haunts: Channels of tidal streams. Baits: Shedder crabs, sand worms, clams. Time and Tide: Day and night flood.

Croker—July to October. Haunts: Deep channels of bays. Baits: Shedder crabs, mussels. Time and tide: Day, flood.

Snapper—Young of Blue Fish. August to November. Haunts: Rivers and all tide ways. Baits: Spearing and menhaden; trolling pearl squid. Time and tide: Day, all tides.

Sheepshead—June to October. Haunts: Surf and bays, vicinity of old wrecks. Baits: Clams, mussels, shedder crabs. Time and tide: Day, flood only.

New England Whiting—Winter Weak-fish, Frost-fish. November to May. Haunts: The surf. Baits: Sand laut, spearing. Time and tide: Night, flood.

Hake—Ling. October to June. Haunts: Open sea surf, large bays. Baits: Clams, mussels, fish. Time and tide: Day and night, flood.

Weak-fish—Squeteague, Squit. June to October. Haunts: Surf, all tideways. Baits: Shedder crabs, surf mullet, menhaden, ledge mussels, sand laut, shrimp. Time and tide: Day and night, flood preferred.

Blue Fish—Horse Hackerel. June to November 1st. Haunts: Surf, open sea and large bays. Baits: Menhaden, surf mullet and trolling squid. Time and tide: Daytime; not affected by tides.

DO WE DEGENERATE?

Should genial Isaak Walton, patron saint of fly casters, visit this world to try his luck along the purling rapids of his old haunts, I doubt if he would again leave record of his achievements. His degenerate disciples of the present day would undoubtedly question the veracity of his statements and set them down as fish stories. Why this should be is difficult to imagine; but it is a fact that, no matter how plausible an account may be given of fishing experiences, it is always received *cum grano salis*. Knowing this, it is with considerable diffidence that I relate the following true incident:

Judge B., of San Francisco, a fisherman

who boasted not a little of his skill with rod and reel, invited a friend, General M., to join him on a trip to Mendocino county for a few days' fishing and shooting. Arriving at a farm near a fine trout stream, they concluded to accept the invitation extended to them to eat their luncheon before proceeding to try their luck. The day was warm. On reaching the creek they agreed to separate, one going above and the other below, so as not to interfere with each other.

The General, working the rapids down stream for a short distance without results, became sleepy. Seeing a large redwood log in the shade, he stretched himself at full length on it, and was soon fast asleep. He had caught only 2 small trout, and these he had strung on a forked stick and placed, together with his rod and line, beside him.

The farmer at whose house they had lunched, curious to see what success they were having, strolled down to the creek and found the General asleep. Determined to add a few fish to his guest's catch, he took the rod from beside the sleeping man and went to the creek. In about an hour he returned with several dozen trout on the general's string, which he replaced, with the rod and line, just where he found them. Then he retired to the adjacent brush to await developments. Presently the Judge returned in search of his friend. Seeing him on the log near where they parted, he cried,

"Wake up there, General. What have you been about? Is that the way you fish? How many have you?"

The General sat up, rubbed his eyes, and reached down for his 2 little trout, intending to plead weariness and the effect of country air. Finding a string of fish where he had expected only 2, he rubbed his eyes again and looked around to see if any one else was in sight. Then he held up the trout, saying modestly, "That's all I caught."

"All you caught!" cried the Judge; "where in thunder did you get them? I've walked 5 miles, and have not half so many."

"Well," said the General, "you bragged how you were going to beat me, so I put in my best licks."

When they reached the house, the farmer was there ahead of them, and apparently dozing in a hammock. He held his tongue; and the General still vows that he caught the whole string.

Isaak would not have done this thing? Do we degenerate?

A. V. LaMotte, Ukiah, Cal.

DENY THE CHARGE.

Harry Hake, Louis A. Ireton and I. N. Miller have just returned from a fishing and hunting trip to Cass lake and Turtle creek, in Northern Minnesota. They report one catch of 50 bass in 48 minutes, and 8 muskalonge in 2 hours. In 2 day's shooting over the marshes they bagged 400 ducks, while 13 deer and 5 moose passed within sight of the camp in 11 hours.—Cincinnati Post.

Regarding the truth of this report are the following letters:

I am of the opinion that my friend and I are being made the subject of a practical joke. We have just returned from a trip to Northern Minnesota where we enjoyed excellent fishing, but no duck shooting worth mentioning. In fact, we were not able to kill enough for camp use, much less any such number as mentioned in your letter. I should indeed be ashamed of such a record as your information credits us with. If such were true the game would necessarily spoil or be sold in the market, and no gun of mine shall ever destroy any of the wild animals or wild fowl for either purpose. I may well add as much for my friend, Mr. Harry Hake, who was with me.

We enjoyed excellent muskalonge fishing in the Itasca lake region of Northern Minnesota, on the line of the Great Northern Railroad. We took as high as 13 fish per boat a day, with 2 rods to the boat, and the fish ranged in size from 5 to 18 pounds each. All that were not needed for use in camp were returned to the water to grow larger, perpetuate the species and furnish sport for some other disciple of Walton. The bass fishing was exceptionally good. We landed several weighing $5\frac{1}{4}$ to $5\frac{1}{2}$ pounds.

I trust your magazine will continue to be devoted to the preservation of the birds, game and fishes of North America.

Louis A. Ireton, Cincinnati, Ohio.

Your information is not correct. Two friends and I recently made a trip to Minnesota and were there 3 weeks. Ducks were scarce, and we did not kill over a dozen all told. Two of us caught 8 muskalonge in one day, the largest weighing 12 pounds. As bass and 'longe are not common in the same waters, we did not catch any bass the same days we caught muskalonge. Bass, however, are plentiful, and one can catch all he can make use of, weighing 3 to 5 pounds each. Few are caught weighing less than 3 pounds. Two years ago, when I tried to make a bass record, I caught 50 good sized ones in 48 minutes by the watch. It is strange that in 2 lakes in Minnesota, only $\frac{1}{2}$ mile apart, one can catch nothing but muskalonge in one of them, while apparently the other will have no muskalonge, but bass, pickerel, and other varieties are plentiful.

Grouse are plentiful in Minnesota this year, and one man can easily kill 50 a day if he had a well trained dog.

I. N. Miller, Cincinnati, Ohio.

I am glad to learn you returned most of your muskalonge to the water. If I were you, I would never fish for a record, for muskalonge, bass or any other fish. That kind of work is only indulged in nowadays by men who do not read or think, and who do not care to be classed as true sportsmen.—EDITOR.

SALMON TROUT.

It has been my intention since reading your note at the bottom of my article on salmon fishing in Charleston lake, in the September, 1902, issue of RECREATION, to obtain and give the correct names of the fish contained in the lake; and as the salmon-trout fishing season is now open, it may be of interest to your readers at this time. The Department of Marine and Fisheries, at Ottawa, has annually deposited salmon-trout fry in Charleston for some years and at different times in Big Rideau lake. These fish are somewhat different in color and shape from the indigenous variety. I asked F. Gourdeau, Deputy Minister of Marine and Fisheries, to give me the names of both varieties; also of other fishes in these lakes. His reply is as follows:

"The common and scientific names of the fish deposited in Charleston lake, Ontario, are, (a) salmon-trout, great lake trout, gray trout and Mackinaw trout; (b) *Salvelinus namaycush*, *Cristivomer namaycush* (Walbaum). The introduced variety and the variety indigenous to Charleston lake bear the same specific name, and have never been regarded as distinct species.

"The scientific names of small mouth black bass, large mouth black bass, pike, pickerel and those of the salmon and salmon-trout are: Small mouth black bass, *Micropterus dolomieu* (Lacepede); large mouth black bass, *Micropterus salmoides* (Lacepede); common pike, *Esox lucius*—*Lucius lucius* (Linnæus); pickerel, or dore, *Stizostedion vitreum* (Jordan and Gilbert)—*Lucioperca Americana* (Cuv. and Val.). In some localities fishes of the pike genus (*Esox*) are called pickerel."

There are many lakes in the Rideau, Beverly and Charleston chain in which salmon-trout are caught in large numbers. The record weight of salmon-trout for 1902 for Devil lake, one of the Rideau group, was 30 pounds, and for Red Horse, adjoining Charleston lake, 25 pounds. Under the careful protection of the fishery overseer and local fish and game association the fishing is getting better each year.

West Rideau lake, one of the best black bass lakes, is well adapted for salmon-trout, and the department has been asked to deposit 100,000 to 200,000 fry in it this year. I shall be pleased to give any information desired on the black bass and salmon-trout fishing or as to facilities for reaching these lakes.

E. A. Geiger, Brockville, Ont.

WITH VIRGINIA BASS.

One day last spring, in company with my old fishing partner, Herman B., a whole-souled fellow without a bristle, I left Richmond at 7.45 a. m. for a day's fishing. We reached the river about 10 a. m., secured young mullets for bait, and proceeded to try our luck.

At first we rowed carefully to the known hovers of the bass, such as stumps, sunken logs, submerged knees of cypress trees, etc., but the weather was so rough we had difficulty in managing our boat. We then decided to try drifting, or more properly trolling, but as each of us had forgotten to bring either spoon or swivel, we used a live minnow instead. We had drifted probably $\frac{1}{4}$ mile when I got a strike. After seeing him break and enjoying several fine rushes, I lost him. I felt bad, but tried again, and a few minutes afterward I landed a $2\frac{1}{2}$ pounder.

A few minutes later the Dutchman had a strike, and after a fine piece of playing he boated a beautiful bass; the largest, with one exception, I have ever seen taken in Virginia waters.

It was then my turn, and I responded by scoring a $2\frac{1}{4}$ -pound pike, which made a fierce fight and cut one of my fingers to the bone on his ivories.

At that moment B. landed another bass, larger than his first one. He then, in less than $\frac{1}{2}$ hour, landed 2 bass weighing $2\frac{1}{2}$ pounds each, and one pike, $5\frac{3}{4}$.

We then had glory enough for one day and quit, went to the hotel and weighed our fish. The 2 larger ones weighed 15 pounds one ounce, together.

The fish are plentiful here but wary, sometimes not biting at all for weeks at a time. As the fish hog and the seine and dynamite hog are strongly in evidence here, too, as elsewhere, I love the way RECREATION goes for the bristled ones, irrespective of who they are.

A few seasons ago I remonstrated with a man for killing a whole covey of quails in the squealer stage, hardly able to rise, and his reply was that the law was out and he was after numbers, not meat; he could buy that at a butcher stall. I thought that in doing so he ran great risk of eating some of his own "kin-folks."

E. C. Payne, Richmond, Va.

WHERE TO GET FLY FISHING.

Can you tell me of a good place for fly fishing, rainbow trout preferred? I have just come over from England, where I had a lot of fly fishing.

C. A. Lindner, Hamilton, Ohio.

ANSWER.

The rainbow trout has been introduced into a great number of rivers of the Eastern, Middle and upper Mississippi valley States. It is, as you know, a native of California. In the streams of Southwestern Missouri, particularly in the neighborhood of Waynesville, Springfield, etc., this trout is now found in abundance and affords excellent sport. It reaches a larger size in those streams than in the mountain streams of California. In the streams of Colorado it is also abundant and said to be very game. In Peach Bottom creek, a tributary of New river, Virginia, it is also abundant; also in the Holston river, Smyth county, Virginia. One was recently reported from that river, at the mouth of Staley creek, 24 inches long, weighing $6\frac{3}{4}$ pounds. Mr. A. H. Gibboney, of Marion, Virginia, and a friend, took 90 rainbow trout from Staley creek in 2 days' fishing, the fish averaging a foot in length. The rainbow trout has also been successfully introduced into the Au Sable river, Michigan, and they are frequently taken weighing 5 to 7 pounds. Other waters in which they are said to have been successfully introduced are the tributaries of the Susquehanna, in Maryland, the Green river, in North Carolina, Silver creek and other tributaries of the Chattooga river in Georgia, Broad river in South Carolina, and the Batterkill in Vermont. They are also found in many of the ponds and streams in the Adirondack region.

Perhaps the best fly fishing for this and the Eastern brook trout that you could most readily find would be in the Adirondack region of New York or in Northern Michigan. Splendid fly fishing for black bass can be obtained in the small lakes of Southern Wisconsin, Michigan, and Northern Indiana. One of the best places for both species of black bass and for the wall-eyed pike is Lake Maxinkuckee, in Northern Indiana.

B. W. E.

TROUT AND BASS IN MAINE.

Last season I packed my grip and went to Portland, where I took the Boston and Maine railroad, changing cars at the junction for the Rumford Falls line, and alighted at Falls Station. Thence by 4 horse stage to Andover, passing thrifty farms, magnificent scenery and countless brooks, to French's, where mine host greeted the stage load and made all hands feel at home. I found almost all the guests were there to catch trout, so I fell into pleasant com-

pany, and after arranging a trip in the morning to Old Maids' brook with Robert Adams I slept my first night in Maine. Mr. French called us at 4 o'clock a. m., and after a hasty breakfast we shouldered our rods and, going about 3 miles up the brook, fished down stream. The trout bit freely and we had good sport from the start, returning to the water many under-sized fish.

The following day we could not fish for trout, as the law permits trout fishing in this vicinity only every other day in the season. The off days we went bass fishing in a lake 3 miles from Andover, where bass rise to the fly and are great fighters.

Among the many streams within 7 miles of Andover are Lone, Sawyer, Black, Bog, Old Maids', Ellis and Devil's Den brooks, all of which afford fine trouting. My time being limited, I left this region with regret, and taking the stage to South Arm, up the Rangeley lakes, boarded the boat for the upper dam, stopping at the Upper Dam hotel, a fisherman's headquarters. There I enjoyed lake trout fishing and made some good catches of rainbow trout, of which the lake has a great many at that point. From Upper Dam you can cross on the boat to Bemis and return to Portland by way of the Rumford Falls line. I am sure readers of RECREATION would be well pleased with a visit to this section of Maine.

Thomas A. Bennett, Scarborough, Me.

SALT PORKERS.

It is not often that I say anything about salt water fish hogs. As a rule, I let them wallow in the brine, for the ocean is great and there is plenty of room there for them. A case has recently been reported to me, however, that is so flagrant and so disgusting in its character as to require attention.

The Pittsburg Dispatch of March 23, 1903, printed a picture showing a large number of kingfish hanging up on the side of a building, and 3 men ranged about them. The report printed with the picture states that Congressman W. H. Graham and his party hold the record for the greatest catch of kingfish for the season; that on March 3, in Miami bay, Florida, they took 267 fish, of a total weight of 2,403 pounds; that on returning to Pittsburg they had their catch photographed, and that the picture above referred to is the result.

I wrote Congressman Graham and W. T. Lindsey, of Pittsburg, for confirmation of the story, and Mr. Lindsey answers as follows:

Two of us caught the kingfish mentioned, the particulars of which I may give you when I hear from the dealer who disposed of them.

Wm. T. Lindsey, Pittsburg, Pa.

Thus it seems that these political salt water swine not only violated the rules of decency in slaughtering 2,403 pounds of fish in a day, but that they sold the fish to a fishmonger. If the butchers had given their fish away, the case would not have been so repulsive, but it seems the brutes wanted to realize something for their time.

It is a disgrace to the sportsmen of Pittsburg and vicinity that they should have sent Graham to Congress and allowed Lindsey to occupy the position of Clerk of the U. S. District Court, as he does.

NEW PATENT FISHING ROD.

719,603.—Folding Fishing Rod. Hiram M. McNamee, Guysville, Ohio. Filed June 18, 1902. Serial No. 112,133. (No model.)

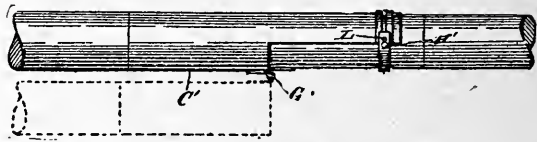

Claim.—1. In a joint for folding fishing rods, a ferrule fitted on one section of the rod, said ferrule being cylindrical where it surrounds the rod, a semicylindrical portion formed with the ferrule and extending outward beyond the rod, a cylindrical ferrule fitted and secured upon the other section of the rod, the last named ferrule being of such diameter as to fit snugly within the semicylindrical portion of the first named ferrule, the cylindrical portion of the first named ferrule being hinged to the other ferrule, and means for holding the male ferrule within the female ferrule.

2. A ferrule C fitted and secured upon the end of one section of the rod, said ferrule consisting of the cylindrical portion C' surrounding the rod, a semicylindrical portion C² formed with the ferrule and extending out from the end of the rod, a cylindrical ferrule E fitted and secured upon the end of the other section of the rod and adapted to fit snugly within the semicylindrical portion of the other ferrule, the cylindrical portion of the ferrule C hinged to the ferrule E, a curved strap fitted in suitable guideways in the outer end of the semicylindrical portion of the ferrule C, said strap adapted to be pulled around the ferrule E, and means for securing it around said ferrule to the semicylindrical portion C².

FISHING AT AVALON, CAL.

Jewfish and barracuda have already made their appearance along the coast of Southern California, and some good catches have been made. Four large jewfish were taken recently off Redondo beach. W. W. Woolley, of Redondo, caught 3,

weighing 350, 250 and 150 pounds, respectively. Harry Guthrie also took one weighing 350. They were all taken on hand lines.

Mackerel and halibut have also been running freely and several good catches have been made from the wharves at Redondo and Long Beach. Striped bass are beginning to find their way down the coast. Several fine specimens were taken in nets along the Orange county coast the past winter.

Surf fishes, such as blackfin croaker, crobina, yellowfin and perch, are running much earlier than usual this season, and the seine fishermen have been making good hauls for the past month.

A new town is being laid out at the isthmus, Catalina island, and many improvements are under way. The waters in the vicinity of the isthmus are famous fishing grounds. Many enthusiastic anglers who formerly made their headquarters at Avalon will this season stop at the new town, or at least divide their time between the 2 places.

The tuna fishermen will find themselves up against a hard record this year, and the man who beats Colonel Morehouse's record tuna of 251 pounds will know he has been fishing.

B. C. Hinman, Bolsa Bay, Cal.

GOOD CHEER FROM OREGON.

I have been a reader of RECREATION for more than 2 years and have the copies all filed away. Long live RECREATION! There are many game hogs here who think it proper to slaughter as much game as possible. I was as big a hog as any of them till a little over 2 years ago I bought a copy of RECREATION. From that day I have never exceeded the limits of decency.

In Crook county is a noble trout stream. An average angler can easily take 100 trout in a day from its waters. An expert can double that figure, and I have known men to more than quadruple it. On this stream I learned to fly-fish. There are no settlements on it for miles. It flows for long distances through primeval forests, abounding in mule deer in summer; a sportsman's Eden. Here the rainbow trout reach perfection in size and flavor. I took one measuring 23 inches in length, but had no means of weighing it. I have seen large strings of 20 inches each; Dolly Varden trout and another, which has never been classified, reaching 12 inches, silver bluish; black rock trout, and grayling. Except the last all the fishes in this stream will rise to a fly. The lake from which this stream flows is also abundantly stocked.

In the Willamette valley the game hog has done his work brown. Pheasants and grouse are nearly extinct.

I wish you success in your noble work,

and shall hope to be of service to you in some way.

Frank L. Poindexter, Eugene, Ore.

NETTER CONVICTED.

One John Swanson, of Worthington, Minn., was arrested by Sheriff Fauskee and a policeman at Ocehydan lake, in April last, for netting fish in violation of law. The officers had been informed by members of the L. A. S. that nets were being used, and drove to the lake one morning before daylight. They hid in the brush and waited until daylight, when Swanson and Peter Hawkinson showed up. Hawkinson waited on shore while Swanson rowed out, pulled up the net and took from it about 20 fish. The officers nailed both men, took them into court, and Swanson was fined \$25, or 30 days in jail. He declined to pay his fine and was locked up. In his evidence, he stated that he did not know who set the net. In making that statement he confessed, in effect, that he was a common thief, and that he was stealing fish from another man's net. However that may be, he got what he deserved. The editor of the Worthington Advance, in reporting the case, says:

A local chapter of the League of American Sportsmen has been organized here, numbering 25 members. Having had notice of fish being caught by net, they took the matter up, and the State game warden instructed the sheriff to make the arrests. Mr. Fauskee performed his duty well. He has the local organization to support him in this work. The League is prepared to act on any information as to unlawful killing of game. This League covers the entire United States, and in this way the game is bound to be protected, as every member is determined to see that it is done.

FISH TRAPPERS IN MASSACHUSETTS.

For the past few years Foxboro has been troubled by a species of vermin that may be classified as fish hogs. I should like to know if any other town in this State has been afflicted in a like manner, and to let true sportsmen know what an effective plan is under way to get relief.

There is a large pond here that offers some of the best of pickerel fishing. It has been a source of enjoyment for sportsmen and a good provider for the poor man's table, for years, as it was a good breeding place for fish. For the past few winters it has been visited, nearly every suitable day, by men from neighboring towns, some of whom hired other men to come with them. Several hundred traps would be put down, and hundreds of pounds of fish carried away and sold for a few cents a pound. One man has been here every fair day for over 3 weeks, with men and boys hired to help him. It is estimated that he has taken away over 1,200 pickerel and thousands of shiners.

I have a bill before the present Legislature which I hope may have enough support from other anglers to secure its passage, and I trust it will stop this dirty work.

Robert W. Carpenter, Foxboro, Mass.

ANOTHER SPECIMEN OF THE MICHIGAN BREED.

W. H. Barrett, Jas. Ryan and J. C. Decker returned Saturday from a 5 days' fishing trip to Long lake. They brought back 492 fish, the majority of which were striped bass.—Flint, Mich., Journal.

Here is what Barrett says about it:

The report of our fishing trip is correct. We caught 492 fish; 11 pickerel, 4 bluegills, one rock bass, one bullhead, and the others yellow perch. The pickerel and bluegills were taken with a spear, through the ice. The perch were caught by cutting holes in the ice and baiting with minnows.

I have just returned from another 5 days' fishing trip to the same place. J. C. Decker and I caught 313, all perch but 3. These were 2 pickerel and one black bass.

W. H. Barrett, Flint, Mich.

So you and your friends belong to the great herd of Michigan swine. You are a disgrace to your State, and it is strange the decent sportsmen of Michigan do not thin out your herd occasionally.

I think Michigan has a law prohibiting spearing, and she certainly has against the taking of black bass in winter. I shall send a marked copy of this to your State game warden and I trust he will take you into court and have you properly punished.

—EDITOR.

REEL SIDE PLATE.

720,063.—Side Plate for Fishing Reels. Joseph E. Pflueger, Akron, Ohio. Filed November 21, 1902. Serial No. 132,241. (No model.)

Claim.—1. A side plate for fishing reels, consisting of a sheet of strengthening material interposed between sheets of hard rubber.

2. A side plate for fishing reels, consisting of 2 plates of hard rubber, having interposed between them a strengthening material, the 3 sheets being united together.

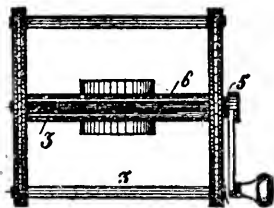

3. A side plate for fishing reels, consisting of a sheet of strengthening material interposed between sheets of a non-corrosive substance, the 3 sheets forming a unitary article.

THE CARP OF CALIFORNIA.

Having just read an article in RECREATION about carp and carp fishing, I find that

my experiences are similar and more extensive. Our interior rivers swarm with these fish, and I have heard many complaints of their destroying duck feed as well as salmon spawn. In spite of his faults, I have found the carp game and exceedingly powerful. I have had a 3 pounder take line for 35 or 40 yards at the first run, and to the end at the second, 50 yards in all. When carp get heavier they lose their quickness, but gain in strength. In the interior rivers and warm waters they are sluggish, but in cold streams and lakes they maintain all their game qualities. I use chiefly worms for bait, but I have caught carp on a spoon when trolling slowly. At times I have had exceedingly good luck with a fly, filling my basket in 2 hours. The fish averaged $\frac{3}{4}$ of a pound. The flies they took were large gray and white ones.

E. R. Preston, Sonora, Cal.

NIBBLES.

You deserve all the backing you can get for the stand you have taken in the interest of real sport. After you publishing "Another Bunch of Michigan Swine," how could any one have the face to still further display himself as did that Justice (?) of the Bunch in your December number. The "contempt and shame from every American" is theirs, not yours. They brought their names into "disrespect and scandal;" you only brought their shameful work into right. They admit their dirty business, yet they cry shame! It is not convincing. They are mistaken in thinking it makes no difference whether they caught one pound or 100 pounds of fish. I should not wish to live in Calumet if the people there are of the class who sanction such brutality.

C. G. Adams, Springfield, Ohio.

Was greatly interested in your Puget Sound salmon story. When I was in Tacoma, in '94, the market fishermen used to go up the Puyallup river in the evening with nets, which they stretched across the river and allowed to float with the current. All salmon bound up stream, that did not swim deep, would run into the net, be gaffed, killed and taken on board. In this way a fisherman would take all the fish his boat could carry. Will some Tacoma reader say how it is now?

Samuel Rudy, Anaconda, Mont.

The new Montana fish law permits seining anywhere in the Missouri river except in Lake Sewall, in Lewis and Clarke county. The size of the mesh of the seine to be used is fixed at $1\frac{1}{2}$ inches square.

Under the new act any person who catches any trout, grayling or black bass, or who removes any eggs or spawn from any such fish for speculative purposes, or who sells any of the trout, grayling, black bass or spawn thereof is guilty of a misdemeanor. The new act prohibits absolutely the sale of any of these.—Montana paper,

GUNS AND AMMUNITION.

Anybody can shoot all day, but a gentleman will quit when he gets enough.

PROTESTS AGAINST UNFAIR CRITICISM.

In March RECREATION appears an article entitled "Jammed a Savage," which deserves more than passing mention. Taking the evidence as stated by the writer himself; using his words literally or with any reasonable construction, he convicts himself of either wilful or ignorant misuse of his rifle, and further of an unfair and childish desire to saddle the consequences of his own lack of understanding on the makers of the rifle.

I do not believe there is a rifle mechanism manufactured, and using fixed ammunition, which can not under some conceivable conditions be jammed; that is, by some combination of circumstances be rendered temporarily incapable of use. No rifle, repeating or single shot, can have a shell appreciably larger than its chamber crowded forcibly into it and still permit free action of the mechanism. No person conversant with such matters would ever exert any unusual force to close the action. He should and would know that something was wrong and investigate before going farther. A man who would thus maltreat an unoffending rifle mechanism deserves to have his rifle jammed and should expect nothing else.

The diagnosis in this man's case is plain. He attempted to force into the chamber of his rifle a shell too large for it.

All American rifles are chambered closely. Cartridge makers use extreme care to keep the dies in which the brass cartridge cases are drawn, true to gauge. There is, however, an unavoidable variation common to the product of all rifle and ammunition makers, in the size of both rifle chambers and of the cartridges adapted thereto. This variation is usually within 4-10,000 of an inch. It could conceivably happen that a customer might buy a box of fixed ammunition of which all the shells were drawn in a die which was worn to the limit of wear permitted by the factory; and the rifle in which he essays to use them might be chambered exactly to the minimum limit. Even if the shells were bright and clean, and the interior of the chamber equally so, he might have trouble; but if the shells have for any reason acquired any dirt or corrosion, or if the chamber be not perfectly clean and free, he surely will have trouble and lots of it.

Some years ago I adopted a rule which has undoubtedly saved me much annoyance. Every cartridge I take into the

woods on a hunting trip has beforehand been carefully put into the chamber of my rifle and the action then closed. Those shells which stick in any degree are rejected. The result is I never have a jam or anything approximating one.

I once saw a most excellent and careful guide hopelessly jam his tried and well seasoned repeater, and it was not a Savage either. On dismounting the arm, piece by piece, we found a 44-40 shell tightly jammed in the chamber, although his gun was a 38-40 and there was no 44-40 ammunition in camp. On examining his box of ammunition; bright, new factory loads, we found 2 other 44-40 shells in the lot. They were of the highest grade of manufacture, and their makers have an unexcelled reputation for accuracy and perfection of product. Somewhere and somehow in the packing, strange as it may seem, those shells must have become mixed, for the box was not opened until we went into camp. The guide had fired one shot at a deer, and in his haste had pumped up one of the fatal 44-40's, with such force that his gun was out of the race at once.

Three years ago, up near the foot of Mount Seward, in the Adirondacks, a party consisting of a well-known New York physician and his 2 guides were hunting. The doctor carried a Winchester 30-30 carbine. He had, the day before, while targeting his rifle, found a 30-30 cartridge which would not chamber, and instead of throwing it away, he foolishly put it in his vest pocket. The following day, while hunting, they jumped a black bear. At short range the doctor gave him the load in his chamber, and on attempting to pump up the next shell from the magazine jammed his gun. Although the bear was badly wounded, and was tracked by his blood several miles through swamp and slash, by one of the guides, he never was found. The shell, which was too large for the chamber, was finally removed, and the circumstances of the target shooting of the day before were recalled. The vest pocket contained no shell, and the reasonable explanation of the matter was that the doctor, finding the lone shell in his pocket and forgetting the reason therefor, had carelessly put it in with the rest of his ammunition. When loading his arm for the day's sport by some ill chance he put the faulty shell just where it did the most damage. Did he "cuss" the Winchester people and their gun? Did he write and ask them to refund the money he had paid for it? Nay,

Nay, Pauline: he did what any reasonable gun crank or honorable sportsman would have done. He made the appropriate and necessary remarks adapted to the occasion, and went on his way, if not rejoicing, nevertheless a bit wiser. He killed 2 as pretty bucks that same week as ever came out of the Cold River country, with the same gun that jammed and that should, according to Mr. Cone, have been returned to the makers and a refund of purchase price demanded.

On Page No. 211 of the same issue of RECREATION is an article by Lieutenant Raymond, U. S. A., yclept "Follow Manufacturers' Instructions." It seems to me that the closing remarks of the powder expert to the complainant, in the lieutenant's story, fit this case. If Mr. Cone had been able to attribute any just blame whatever to his rifle, I am confident that every amend possible would have been made by the manufacturers. They stand by their product and their guarantee means just what it says.

E. B. Guile, M. D., Utica, N. Y.

I had hoped the Savage Company would reply to Dr. J. F. Keenan's criticism of their rifle; but since they have not done so, I can not let the Doctor's statements go unchallenged.

He starts out by saying the Savage should handle the standard army cartridge and no other to give it standing with riflemen, who know that a gun shooting many cartridges can not be depended on to shoot any one of them reliably. He adds that a gun that does not require extended experimentation and constant alteration of sights to suit different loads is what the practical rifleman wants. For that reason the Doctor turns to the '95 model Winchester.

A rifleman desiring an arm to handle the standard army cartridge and that alone would certainly be disappointed if he took such advice, for the Winchester people recommend 3 different cartridges for the 30 army and the .303 British, corresponding exactly to Nos. 1, 2 and 6 of the Savage. "For the 38-72 and 40-72," their catalogue says, "soft lead, full metal patched, or metal patched soft point bullets, and either black or smokeless powder give excellent results." How many varieties of cartridges could be made as suggested? Does the Doctor consider that this gun "lacks character, like a Jack-of-all trades"? What is his opinion of the 32 caliber Special, which is offered to meet the demand of many sportsmen for a smokeless powder cartridge that can be reloaded with black powder and give satisfactory results?

As to the statement, "Even the Savage Company acknowledges its inability to sight the guns at the factory for accuracy before putting them on the market," it seems the

Doctor must be prejudiced against the arm without having tested it. Every rifleman knows that, to quote the Savage catalogue, "however closely the sights may be adjusted for one shooter, it will generally be found necessary to alter them somewhat to give perfect satisfaction to another user of the rifle."

The Savage is bored to shoot the regular No. 1 or No. 2 cartridges, just as the Winchester is bored for its regular hard or soft point cartridges; no "compromise of twist" has been made to the lighter loads. If held right, a Savage will group the shots in as small a circle as any similar rifle I have ever handled.

A study of the article leaves the impression that it was written with undue haste and without careful examination into the facts, for while the Savage Company advertises its different cartridges, the Winchester Company recommends its varieties in the catalogue; thereby vouching for them. If the Savage can not be considered a standard arm because it uses more than one cartridge, there are no standard rifles. All the modern high pressure smokeless rifles of which I have heard will handle at least 3 different cartridges corresponding to the Savage numbers mentioned above.

This article is not meant to criticise the Winchester arms, for those guns are generally accepted as the standard by which others are judged in this country; neither is it a recommendation of the Savage. My object is simply to throw cold water on much ado about nothing.

It is thought, however, that the Savage would be improved by placing the safety on top of the receiver for the benefit of those accustomed to the hammerless shot gun.

J. E. B., Mobile, Ala.

NEW MAGAZINE GUNS.

719,955.—Magazine Firearm. John D. Pederson, Denver, Colo. Filed June 12, 1901. Serial No. 64,322. (No model.)

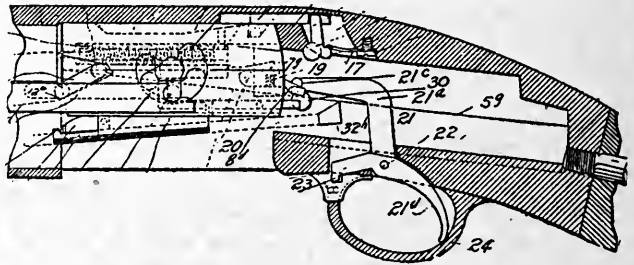

Claim.—1. In a magazine gun, the combination of a receiver, a breech block longitudinally movable therein, the receiver being provided with a recoil shoulder which engages the rear extremity of the breech block when the mechanism is in the locked position, a crank mounted to turn in the

breech block, a firing pin moved to the cocked position by the action of the crank, a sear mounted in the breech block in operative relation with the firing pin, and an action bar arranged to move in a line parallel, or nearly so, with the axis of the gun barrel, said bar engaging and actuating the crank, the engaged part of the latter being carried in a straight line with the action bar, whereby the rear end of the breech block is lowered to release it from the recoil shoulder as the action bar begins its rearward movement, and raised to lock the breech block as the action bar completes its forward movement.

2. The combination with a receiver, and a breech block located therein, of a crank mounted to turn in the breech block, a firing pin moved to the cocked position by the action of the crank, a sear mounted in the breech block in operative relation with the firing pin, and an action bar arranged to move in a line parallel, or nearly so, with the axis of the gun barrel, the action bar engaging a part of the crank outside of its axis and causing said part to move with it in a straight line, whereby the axis of the crank is lowered while the action bar is moving in one direction and raised while the action bar is moving in the opposite direction.

722,125.—Magazine Firearm. Anson Mills, Washington, D. C. Filed August 13, 1902. Serial No. 119,527. (No-mod-el.)

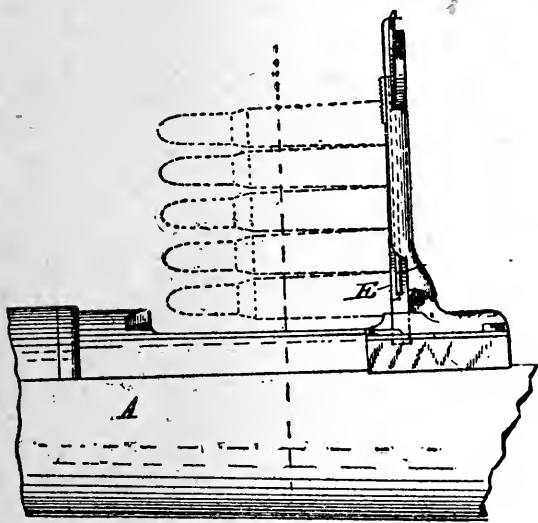

Claim.—1. In a magazine firearm the breech frame provided with a chamber c^1 for the breech bolt, and an opening c^1 in said chamber, and the magazine beneath said chamber, in combination with a guide clip hinged to the breech frame at one end of the opening c^1 adapted when turned down to lie in said opening in the breech frame out of the way, and when turned up to receive a charge of cartridges and guide

and conduct the same down through the opening c^1 and chamber c into the magazine.

2. A guide clip consisting of a holder hinged thereto, and a clip proper constituting a guideway for the charge of cartridges to be delivered to the magazine, held to and longitudinally movable on said holder.

TO AVOID SPOTS.

Will some one tell me how to keep spots out of gun barrels? I have 2 fine guns that I bought a short time ago, and I can not keep them clean. I have tried everything recommended in RECREATION. Have used oils, plenty of rags and lots of elbow grease. I also used a Wise cleaner; it has scratched the barrels, but the spots are still there. Will the scratches impair the shooting of the gun? The spots can not be rust, for I have been careful to clean my guns soon after using them. The spots can not be from lead, for I have used these guns only a short time. The guns are high grade Parkers.

A. C. Rowson, St. Louis, Mo.

ANSWER.

To keep the barrels of your guns from spotting, you should clean them thoroughly after each day's shooting; so clean that you can run a tightly fitting white cloth through without soiling it. Then grease the barrel thoroughly with vaseline, applied by a cloth fitted loosely on a cleaning rod. The muzzles of the barrels should then be corked, so the air can not get in. When putting your gun away for the winter, or for any considerable time, it is a good plan to fill the barrels with beef or mutton tallow. When you want to use the gun it is only necessary to warm the barrels and the tallow will drop out. Another absolute preventive of rust is the wick plug advertised in RECREATION.—EDITOR.

A NEW REMINGTON.

I was glad to read W. H. Nelson's just tribute to the Remington, long my favorite rifle. A new Remington will soon be on the market that for fine shooting qualities, beauty of outline and finish will not be excelled by any rifle now manufactured.

The action will be the well-known Remington, but the trigger is checked and the sear is ground on an oilstone, rendering the trigger smooth and positive at $2\frac{1}{2}$ pounds. The barrels will be made 24, 26 and 28 inches in length. They are half octagon and beautifully tapered. Rear sight slots are omitted. They are adapted to 22, 25, 32 and 38 cartridges. The weights are $5\frac{1}{2}$ to $6\frac{1}{2}$ pounds. The stock is entirely different from those of other Remingtons. The grip is exactly like those of the Remington pistols, straight and long, giving a splendid hold for the hand, and is

checkered and capped with rubber. The forearm is also checkered. The stock is well formed and has a rubber shot gun plate. The sights are a special Lyman combination rear and combination front.

Ira Sweet, Little Marsh, Pa.

SMALL SHOT.

I saw in January RECREATION what M. B. Beecher said in regard to his \$80 Ithaca being as good as a \$100 gun of any other make. I think the difference between an \$80 and a \$100 gun of any make is in the engraving and finish and not in the shooting quality. I have a 16 gauge, \$57 grade, Lefever gun which has only line engraving, that being the only difference between it and the \$80 grade. I have tried my gun on equal terms with a W. C. Scott that cost \$200. It made as good a pattern, and the owner of the Scott admitted that my gun gave the better penetration. I think I am safe in saying I have as good a gun as any made at the same price. I should like to see a gun that is stronger or more simple in its mechanism than the Lefever.

R. B. Edmiston, Milan, Pa.

I have used a rifle 25 years, and am perfectly satisfied with my Winchester 45-70-300 and the 330 grain bullet. I notice that men who were using 30-30's and .303's are fast going back to 38-55's and 45-70's. I don't believe in wounding game and letting it get away, as is often done with the 30-30. Many men still crack up the small bore rifle, but let them go into the Maine woods and try to shoot moose, bear, or deer, running, with small bores, and they will soon change their minds. Of course, if game is standing, a small bore rifle may answer, but even then the bullet must strike a vital spot to do much damage. Many men have many minds, but give me the 45-70 Winchester with the 300 or 330 grain bullet.

C. F. Walker, Brockton, Mass.

I have a 4 bore gun which is 7 feet 8 inches in length. It was used, many years ago, as a sealing gun in Newfoundland, and was bought and sent to me by a friend as a souvenir. The stock runs to the end of the barrel and is bound to it by heavy brass bands. It was a flint lock when it came into my hands, but I have had it fitted with a percussion lock. It is my intention to test the weapon as soon as my family is comfortably provided for.

R. H. Goudey, Port Maitland, N. S.

Answering query in October RECREATION re Mauser pistol: I have used one. Used as a revolver is used, have found it not as good as a Colt; it has too light a bullet to be really effective. I do not consider it as accurate as it might be, even when used

with the holster stock. Would rather have a Colt Frontier, which, in my experience, shoots better and it costs less.

Six Shooter, Howick Rail, Natal, South Africa.

721,050.—Gun Cleaner. James M. Kersey, Bethany, W. Va., assignor of one-third to F. A. Chapman, Wellsburg, W. Va. Filed September 10, 1901. Serial No. 74,969. (No model.)



Claim.—A gun-cleaning projectile made of rubber or similar self-expansive material, elongated and provided with rifling.

Should like to hear from readers of RECREATION who have used either the 33 or 35 caliber, '95 model, Winchester, which is best for large game at both long and short ranges? Has either or both greater killing power than 30-40 or .303? I have had a little experience with the small bore smokeless on moose and think a large caliber preferable.

P. S. Marsten, Meductic, N. B.

Please ask if any of your readers ever tried buck shot in a choke bore gun. Also whether they ever tried cutting a shell between the powder wads in order to bunch the shot at long range. I can, in that way, put buck shot through a 2 inch soft wood plank at 75 yards.

Buck Shot, Milnor, N. D.

I should like to hear from some experienced sportsman if there is a smokeless powder that will throw shot as far as a good brand of black powder. I use an Ithaca gun and have decided I can kill squirrels farther with black than with smokeless.

J. B. Knapp, Parkersburg, W. Va.

Please give me instructions as to building a good load for a 16 gauge choke bore gun, for long range squirrel shooting.

Chas. Goss, Paoli, Ind.

Will some of your readers who have had experience with automatic ejecting guns kindly give me their opinions regarding the automatic ejector feature?

A. P. Bean, Philadelphia, Pa.

I do not see any complaints about the 25-35 rupturing in the breech like the 30-30. Is the smaller caliber actually as effective on deer as a 30-30?

G. W. McKay, Kelsey, Minn.

NATURAL HISTORY.

When a bird or a wild animal is killed, that is the end of it. If photographed, it may still live and its educational and scientific value is multiplied indefinitely.

THE GREAT BLUE HERON.

The name great does not mean heroic, for few birds are so shy as the heron; but in Alabama we have several species of herons. The most common are the great blue heron, the lesser blue heron, and 2 species that seems to be a cross between the lesser blue and the white herons. There are many swamps in Alabama and herons are common in some localities. As the smaller birds are fond of the cypress swamps, where the "knees" and undergrowth hide them, it is hard to get data as to their private lives. The great blue heron I have often watched as he was fishing. He is a fish hog, yet he is such a patient, persevering one that I am tempted to claim pardon for him. He uses only the proper equipment on his expeditious and this is his livelihood.

On the Tennessee river in Northern Alabama small game abounds. In season ducks, geese, teals and herons are numerous. The herons are often over 4 feet long and their wings stretch out to a good length. From a hilltop I have often watched one of these birds standing in a shoal waiting for some unwary or helpless fish to come washing over. Then, like a lightning flash, the heron straightens his neck, down goes his long, sharp beak into the water, and the game is hoisted aloft, fluttering, but helpless. A moment more finds Mr. Heron again in a silent meditation, head on breast, the picture of stupor and dejection; but a fish soon wakes him. His keen eyes pierce the muddy waters and his long, muscular neck is too quick. He will stand for hours at a time in one place. The kingfisher sits on a dead branch above and flashes down every now and then. The sun climbs up or goes down in the heavens, but Mr. Heron stands seriously, silently, in the same place. Night comes, the katydids begin their chatter, Mr. Heron rises slowly and gracefully, his long legs and clean feet tucked up and sticking out behind. He flies silently, each motion of his wings denoting a serious thoughtfulness, each turn of his head a careful, watchful character.

I have never had the honor to visit the gentleman in his home, and must let some one else tell of his domestic life. He looks somewhat henpecked, but I may be mistaken. It would pay one to go through the wooded regions of Alabama before the lumbermen destroy the homes of our game birds and animals. The lover of nature, of the picturesque, of silence, of weirdness,

would find enough to please him, to satisfy his tastes. The canebrakes, the cypress swamps, the pine woods, the hush and stillness impress us that we are near to Nature as nothing else can. Let our blue heron plead for his home. Let the squirrel, the fox and all the others beg for a corner, a hole in the ground. Must our herons fish in streams made muddy by sewage? Must our woodcock live in bare, barren hills? Where are our silent, hushed sloughs and swamps going? Must we change the old poem from "Woodman, spare that tree," to "Millmen, spare that county"? Let some one act before it is too late.

Thos. H. Williamson, Kyle, W. Va.

AN UNFORTUNATE CLASS.

"They seeing see not; and hearing they hear not, neither do they understand."

Undoubtedly you know the kind of "theys" I have in mind. Those who hear only "noises" when they go into the woods, class all smaller life as "bugs," refer to the cricket's cheerful chirps as "squeaks," and insist that you are trying to stand on your head when you are merely looking for some insect friend under the corner of a big rock.

The class I mean are to be received with a sigh of resignation only. It seems incredible that such people can keep alive without the sympathy which friendship with nature can give us. Human friends are well meaning, but there is a line beyond which they can not come. We shrink from telling them our disappointments or bright dreams, and only can they catch a hint of our thoughts as they see our countenances off guard. But how different when we go out among the trees with the solid hills near and a clear sweep of sky. Even if it is only a winter day and wood life is dormant, with a few deep breaths and half closed eyes we drift out of ourselves into that blissful state where we have no name, no identity, and are just nature's children, listening to her and letting her take the tiredness out of body and mind.

Can the "theys" ever refresh themselves in this way? No, never; not even if they had trinocular vision and ears attuned to the faintest sounds. Their imagination takes no part in the photographing work of their eyes, and the impingement of sound waves on their ear drums results in their hearing noises, and noises only.

"Neither do they understand"; that is it.

They may see or hear, but never understand. Their perceptive organs may be perfect, yet in reality they hear and see nothing. Poor things! They are to be pitied; they do not live. They are automata, existing in a man made city, and to them the God-made country is incomprehensible.

Sara M. Armstrong, Everett, Mass.

A RATTLESNAKE SOUVENIR.

CHAS CRISTADORO.

We slowly, on a hot August day, drove up the winding road toward the crest of the Blue Ridge mountains in search of change of air and scenery and incidentally to try for a few trout in the Rapidan.

As our panting horses slowly crawled along I noticed a gigantic rattler outstretched in the dust beside the road, its head partly hidden. To all appearances it was as dead as a mackerel, and presumably, having been wounded by some passerby, had crawled to where we saw it and there died. Its tail was ringed with over a dozen rattles and ended in a button. What a souvenir of Blue Ridge I thought, and reaching for my knife I told my friend to stop the horses while I jumped out and cut off those rattles.

"Rattles be blowed!" said my companion. "You don't want them, and there is no use wasting time at this hour of the day. Leave the snake alone. He'll be there when we come back."

With that we jogged along, reached the mountain top, drank at the spring until we could hold no more, tried the trout, and long before sunset were again on the way down the mountain. As we neared the place where our dead snake was we looked carefully for the overhanging chestnut limb under which he lay. When we stopped at the spot the snake was missing; but across the road through the undisturbed dust was the trail of the serpent, almost broad enough to walk in.

I never see a snake without thinking of what might have happened had I perished in securing my souvenir of rattles. I presume as my foot struck the ground the snake would have coiled, rattled and before I could have recovered my equilibrium and moved backwards, struck me; and then there would have been a wild race to town for help, and perhaps a dead man before we reached it.

Since then I would not attempt to cut rattles from the most inanimate appearing snake until the fact and manner of its death had been certified by a coroner's jury.

THEY WERE SALAMANDERS.

A year or so ago I saw in a pond thousands of pinkish vertebræ that looked like

young trout except for a pair of legs attached to their shoulders in about the same place that pollywogs have their legs. These vertebræ were like pollywogs, but their heads were larger and flatter. Can you tell me what they were?

Samuel Rudy, Anaconda, Mont.

ANSWER.

These animals were evidently larval salamanders, most certainly of the species *Amblystoma triginum*. In Cope's "Batrachia of North America," page 83, it is stated that the "Larvæ of this species are exceedingly abundant in all still water in the Rocky Mountain region and the plains. They are rapacious, eating animal food, and taking the hook readily. Late in the summer they complete their metamorphosis and take to the land, where they hide in the holes of marmots, badgers, etc. From these they emerge during and after rains. The larvæ are much less frequently seen in the East, where the species is less abundant, and the opportunities of concealment are greater. Market lake is a temporary body of water covering many square miles in Eastern Idaho. It is formed by the overflow of the Snake river in spring. On its shores I have found this species. On the shore of an adjacent pond of more permanent character I have observed this species occupying vertical holes which were kept filled with water by occasional waves, but from which their heads emerged into the air. In this position their branchiæ were gradually absorbed."—B. W. E.

HOW TO TAKE CARE OF A COON.

I have a coon that was given me last summer, and I wish to know how to take care of it during the winter. It is only partly tamed, is fastened by a chain from its collar to a post in the yard, and on top of the post is a box for its home. I think it will be too cold for it there in winter, but do not know its habits or what to provide for it.

Mayne Mason, Buda, Ill.

ANSWER.

The thing most necessary in providing a winter shelter for a raccoon is to make its sleeping place free from direct drafts. In other words, the sleeping box should have a sort of vestibule, with the outside door on the left, and the inside door on the right. Of course, the interior must be kept perfectly dry; for a leaky roof means wet bedding and a dead animal. In stormy weather it is a good plan to hang a piece of canvas or gunny sack over the door, to break the force of the wind. The door should be toward the South or Southwest. In the matter of food, a raccoon is omnivorous, and eats almost anything that

can be chewed. Give it stale bread, bits of meat and table scraps generally, and it will pick out what it most prefers. Raccoons are fond of water, and often take their food and soak it in water before eating it.—W. T. H.

A YELLOWLEG.

One day last spring I was sitting in an old skiff on Wing lake, waiting for a flock of wary butterball ducks to get within shot gun range, when I was startled by a clearly whistled "pleidel." Glancing up I noticed a light grayish colored bird, with wide spreading, pointed wings, circling around as if he were about to light, which he soon did. He did not notice me, hid in the rushes, but began to hunt eagerly for food, running along the beach until he came quite close to me. He looked to me a little larger than the killdeer. His bill was fully an inch long, black and straight. His body was light, spotted with black, and his tail was slightly rounded at the end. The legs were the queerest part of the bird, being long in proportion to his size, and bright yellow in color.

I would be obliged if you could tell me the name of the bird.

Archie Brooks, Detroit, Mich.

ANSWER.

Mr. C. William Beebe, Curator of Birds in the New York Zoological Park, identifies the bird described as a yellowleg, *Totanus havipes*.—EDITOR.

DOMESTICATING BOB WHITES.

Three years ago I secured 6 Bob White quails and kept them in a yard covered with fine mesh wire, with a sort of shed at one end. They became tame and in the spring would whistle the mating call and appear perfectly contented. On looking in the house one day I found about 15 eggs and supposed the birds were about to begin setting. On going to feed them the next day I was surprised to find all the birds dead. They had shown no sign of sickness, and must have been in some way poisoned. This year I resolved to try again and secured a dozen good birds. I keep them in 2 pens, 3 pairs in each. They were wild when I got them, but in 6 weeks became so tame that I could let them enter the yard, which is about 12 x 25 feet, with a house 4 x 5 feet. They come out early in the morning to feed, and can be heard whistling when the weather is warm and clear. I have not made any nests for them yet, but if they lay I am going to try letting them raise their own young and shall also set some of the eggs under bantams. I will let you know how I succeed.

R. S. Van Buren, Norwalk, Conn.

NATURAL HISTORY NOTES.

I notice your claim that gray squirrels do not steal corn, but I do not know whether you included the red or fox squirrel, as here known. If so, can say that the red squirrels can, and often do, carry whole ears of corn. On my experimental farm, within this city's limits, some 10 to 16 years ago, were many red squirrels. A few were native on the property, but I added many more, and allowed none to be destroyed. They became very tame, and some would even enter the dwelling houses and office on the place and take therefrom any food they found. In my corn field, where many varieties of corn were being crossed, I have often been astonished to see one of these audacious squirrels climb the stalk, strip the ear, and finally carry it off. Some would take only the smaller ears, while others would succeed in carrying off the largest ears. This field contained but a few acres and was surrounded by grazing land and groves of oaks and walnuts.

D. H. Talbot, Sioux City, Ia.

One evening, in passing a house with a large, old-fashioned chimney, I stopped to watch the swallows darting in and out. Noticing an object on the point of the lightning rod, I went closer to see what it was. A swallow, evidently coming in late, had impaled himself on the sharp point of the rod. His position was very natural, head pointing downward toward the mouth of the chimney and wings and tail extended as in flight. I was sorry I could not get close enough to photograph it. Another time I was watching a night hawk flying leisurely along. As he approached a high flag pole with the remnant of an American flag on it, he paused, and circled a few times. Then, dropping down to the level of the flapping silk, he put up a lively scrap. He fought the flag fully five minutes; then, evidently concluding that he was no match for Old Glory, he flew away.

W. L. B., Oxford, O.

For 40 years I have studied the habits of hawks, owls and crows, and would sooner trust the report of my own eyes than the generalities of all the scientists in Washington. Hawks feed mainly on grouse, swallows, bluebirds, robins, ground birds and mice, and on chickens when they can get them. The pigeon hawk lives almost wholly on birds, and insectivorous birds at that. His savage, hooked bill was designed to tear flesh, and he knows it. Owls depend mainly on rabbits, grouse, squirrels and mice. The big horned owl is death to poultry roosting out of doors, but his main dependence is bunny. The crow probably

does as much good as harm. His food is insects, frogs, mice, corn, potatoes and often young birds.

C. W. Johnson, Plymouth, Vt.

While near Bellefontaine, Ohio, I saw recently large flocks of birds alighting in a pasture among a herd of cattle. The birds were a little larger than the common sparrow. Some were jet black and others brown. They kept coming in flocks until the ground was black with them. While flying they make a chirping sound. What were they?

Edward Thickinger, Gation, O.

ANSWER.

These were evidently cowbirds, *Molothrus ater*; a species of marsh blackbird. They are parasitic, laying their eggs by stealth in the nests of various other small birds. The brown individuals are females.—EDITOR.

While fishing in Claybank creek I killed a snake. Passing the spot an hour later I saw another snake apparently trying to move the dead one. Several times I drove the living reptile away, but each time it returned and twisting around the dead snake, endeavored to drag it toward some holes near by. I watched the performance at least half an hour, and am sorry I did not wait to see the final result. I have wondered whether the snake was trying to bury its dead comrade, or, supposing it merely stunned or torpid, was trying to drag it home. Anyway, I haven't killed a snake since.

J. G., East Lake.

Several years ago, while shooting near Dunkirk, Ind., I asked permission to hunt over a certain farm. Its owner offered to go with me if I would try to kill for him a marked bird in a flock of quails he had located. We found the birds without trouble. I killed a number and finally secured the one the farmer wanted. It was a big plump quail with perfectly white wings; the rest of its plumage being normal. I have hunted all my life, and never saw another quail with a mark of any kind. In the same vicinity I afterward saw and killed a pure white kingfisher.

Ollie Hoffman, Elwood, Ind.

My boy has a little land turtle to which he is greatly attached. Please tell me how he can keep it through the winter and what to feed it.

B. F. Aurandt, Altoona, Pa.

ANSWER.

The proper course is to keep the tortoise in a box of dry sand in a warm room. Feed it chopped raw beef, bananas, lettuce and young celery. Give it drinking water in a small dish.—W. T. Hornaday.

It is not strange that Mr. Stowers never saw a squirrel drink water in Kentucky. I have been informed that even horses refuse water in that State. In Oregon squirrels drink water. I have often seen numbers of them drinking at springs in the mountains.

S. K. Ogle, Klamath Agency, Ore.

A SMART ONE.

H. C. D.

There is a man in our town,
Who thinks he's mighty cute;
He kills the grouse and squirrels
'Ere it is time to shoot.

He hunts deer in the summer,
And catches bass in May;
He snares the scrawny rabbit
While the farmers cut their hay.

He'd like to make the game laws,
And run the Ship of State—
'Twould puzzle him to do it,
For he is out of date.

He sneers at RECREATION,
Thinks Shields is off his base;
For Hampshire's herd of game hogs
He tries to set the pace.

This man has got the big head,
From shooting on the wing;
No wonder he's a marksman,
He shoots from spring to spring.

Down South he goes in winter,
He hates a chilly spell;
But, say, Coquina, is there
A hog pen down in —?

RECREATION is the best magazine for the lover of gun and rod that I have ever read, and is worth all the other sportsmen's journals combined. I would not be without it for 3 times its cost. To read the stories which are told in it is almost like being there and participating in the sport. The department of guns and ammunition especially interests me, and I also heartily approve the roasts you give the game hog.

Edw. F. Loomis, Troy, Pa.

Physician—The truth can no longer be hidden, madam. I am obliged to tell you that your little son is—er—weak minded; that is—well, it must be said—he is an idiot.

Mrs. Highupp—How fortunate that we are rich! No one will ever notice it.—New York Weekly.

Anxious Mother—Daughter, why do you persist in reading those sensational stories?

Pretty Daughter—Because they make my hair curl, mamma.—Chicago Daily News.

THE LEAGUE OF AMERICAN SPORTSMEN.

GENERAL OFFICERS

President, G. O. Shield, 23 W. 24th St., New York.

1st Vice-President, E. T. Seton, 80 West 40th St., New York.

2d Vice-President, W. T. Hornaday, 2969 Decatur Ave., Bedford Park, N. Y.

3d Vice-President, Dr. T. S. Palmer, Dept. of Agriculture, Washington, D. C.

4th Vice-President, A. A. Anderson, 80 West 40th St., New York.

5th Vice-President, Hon. W. A. Richards, General Land Office, Washington, D. C.

Secretary, A. F. Rice, 155 Pennington Ave., Passaic, N. J.

Treasurer, Austin Corbin, of the Corbin Banking Co., 192 Broadway, New York City.

ALASKA DIVISION.

Dr. E. M. Rininger, Chief Warden, Nome.

ARIZONA DIVISION.

M. J. Foley, Chief Warden, Jerome.

ARKANSAS DIVISION

W. R. Blockson, Chief Warden, Eureka Springs.

CALIFORNIA DIVISION.

Dr. David Starr Jordan, Chief Warden, Leland Stanford University. C. Barlow, Sec.-Treas., Santa Clara.

COLORADO DIVISION.

A. Whitehead, Chief Warden, 303 Tabor Building, Denver.

CONNECTICUT DIVISION.

Hon. F. P. Sherwood, Chief Warden, Southport; Dr. H. L. Ross, Vice-Warden, Canaan; H. C. Went, Sec.-Treas., Bridgeport.

DISTRICT OF COLUMBIA DIVISION.

C. H. Townsend, Chief Warden, U. S. Fish Commission.

FLORIDA DIVISION.

W. W. K. Decker, Chief Warden, Tarpon Springs

GEORGIA DIVISION.

J. J. Doughty, Chief Warden, Augusta.

IDAHO DIVISION.

L. A. Kerr, Chief Warden, Kendrick

ILLINOIS DIVISION.

M. D. Ewell, M.D., Chief Warden, 59 Clark St., Chicago; F. M. Taber, Vice Warden, 144 Kinzie St., Chicago; G. C. Davis, Sec.-Treas., 123 S. Central Ave., Austin.

INDIANA DIVISION.

Frank L. Littleton, Chief Warden, 30½ East Washington St., Indianapolis; J. J. Hildebrandt, Vice Warden, Logansport; T. J. Carter, Sec.-Treas., State House, Indianapolis.

IOWA DIVISION.

Carl Quimby, Chief Warden, Des Moines; C. C. Proper, Sec.-Treas., Des Moines.

KANSAS DIVISION.

O. B. Stocker, Chief Warden, Wichita; A. J. Applegate, Sec.-Treas., 113 E. 1st St., Wichita

KENTUCKY DIVISION.

Geo. C. Long, Chief Warden, Hopkinsville.

R. L. Brashear, Sec.-Treas., Bowling Green.

MAINE DIVISION.

Col. E. C. Farrington, Chief Warden, Augusta.

MARYLAND DIVISION

J. E. Tylor, Chief Warden, Baltimore.

MASSACHUSETTS DIVISION.

Heman S. Fay, Chief Warden, Hazleton Block, Marlboro; J. E. Tweedy, Vice-Warden, North Attleboro; A. C. Lamson, Sec.-Treas., 194 Main St., Marlboro.

MICHIGAN DIVISION.

J. Elmer Pratt, Chief Warden, Grand Rapids; R. S.

Woodliffe, Vice-Warden, Jackson; A. B. Richmond, Sec.-Treas., Grand Rapids.

MINNESOTA DIVISION.

Dietrich Lange, Chief Warden, 2294 Commonwealth Ave., St Paul.

H. A. Moigan, Vice-Warden, Albert Lea; Prof. O. T. Denny, Sec.-Treas., St. Paul.

MISSOURI DIVISION.

Bryan Snyder, Chief Warden, 726 Central Bldg., St. Louis.

MONTANA DIVISION.

Professor M. J. Elrod, Chief Warden, Missoula; Sidney M. Logan, Vice-Warden, Kalispell; R. A. Waagner, Sec.-Treas., Bozeman.

NEBRASKA DIVISION.

Fred. E. Mockett, Chief Warden, Lincoln; P. O'Mahony, Sec.-Treas., Lincoln.

NEVADA DIVISION.

Dr. W. H. Cavell, Chief Warden, Carson. Geo. W. Cowing, Sec.-Treas., Carson.

NEW HAMPSHIRE DIVISION.

Dr. A. F. Barrett, Sentinel Bldg., Keene, Sidney Conant, Sec.-Treas., Keene.

NEW JERSEY DIVISION.

Percy Johnson, Chief Warden, Bloomfield; Dr. W. S. Colfax, Vice-Warden, Pompton Lakes; I. V. Dorland, Sec.-Treas., Arlington.

NEW MEXICO DIVISION.

W. M. Borrowdale, Chief Warden Magdalena.

NEW YORK DIVISION.

John R. Fanning, Chief Warden, Powers' Bldg., Rochester; Col. R. E. Moss, Vice-Warden, Wallack's Theatre, New York City; Dr. C. C. Curtis, Sec.-Treas., Columbia College, New York City.

NORTH DAKOTA DIVISION.

Dr. W. D. Jones, Chief Warden, Devil's Lake.

OHIO DIVISION.

W. E. Gleason, Chief Warden, Mitchell Bldg., Cincinnati; A. C. Thatcher, Vice-Warden, Urbana.

OKLAHOMA DIVISION.

W. M. Grant, Chief Warden, Oklahoma City.

ONTARIO DIVISION.

C. A. Hammond, Chief Warden, Box 701, St. Thomas; D. L. Mells, Sec.-Treas., St. Thomas.

OREGON DIVISION.

Robert F. Kelly, Chief Warden, Box 188, The Dalles; C. B. Cushing, Sec.-Treas., The Dalles.

PENNSYLVANIA DIVISION.

C. F. Emerson, Chief Warden, 189 N. Perry St., Titusville; Hon. C. B. Penrose, Vice-Warden, 1720 Spruce St., Philadelphia; E. Wager-Smith, Sec.-Treas., 1026 Ridge Ave., Philadelphia.

RHODE ISLAND DIVISION.

Zenas W. Bliss, Chief Warden, 49 Westminster St., Providence.

SOUTH CAROLINA DIVISION.

C. F. Dill, Chief Warden, Greenville.

SOUTH DAKOTA DIVISION.

D. C. Booth, Chief Warden, Spearfish; John C. Barber, Sec.-Treas., Lead.

TENNESSEE DIVISION.

Hon. G. C. Martin, Chief Warden, Clarksville; Hon. Austin Peay, Jr., Sec.-Treas., Clarksville.

TEXAS DIVISION.

Prof. S. W. Stanfield, Chief Warden, Weatherford; W. E. Heald, Sec.-Treas., San Angelo.

UTAH DIVISION.

Hon. John Sharp, Chief Warden, Salt Lake City.

VERMONT DIVISION.

W. E. Mack, Chief Warden, Woodstock; S. C. White, Sec.-Treas., Woodstock.

VIRGINIA DIVISION.

Franklin Stearns, Chief Warden, 13 N. 11th St., C. O. Saville, Vice Warden, Richmond; M. D. Hart, Sec.-Treas., 1217 East Main St., Richmond.

WASHINGTON DIVISION.

F. S. Merrill, Chief Warden, Spokane; F. A. Pontius, Sec.-Treas., Seattle; Munro Wyckoff, Vice-Warden, Pt. Townsend,

WEST VIRGINIA DIVISION.

E. F. Smith, Chief Warden, Hinton,

WISCONSIN DIVISION.

Frank Kaufman, Chief Warden, Two Rivers; Dr. A. Gropper, Sec.-Treas., Milwaukee.

WYOMING DIVISION.

H. E. Wadsworth, Chief Warden, Lander; Frank Bond, Sec.-Treas., Cheyenne.

Applications for membership and orders for badges should be addressed to Arthur F. Rice, Secretary, 23 W. St., New York.

LOCAL WARDENS IN NEW YORK.

County.	Name of Warden.	Address.
New York,	Conrad L. Meyer,	46 W. Broadway.
Livingston	M. De La Vergne,	Lakeville.
"	K. S. Chamberlain,	Mt. Morris.
"	Henry Skinner,	Springwater.
"	Dr. J. W. Cowan,	Geneseo.
Albany,	C. D. Johnson,	Newtonville.
"	Kenneth E. Bender,	Albany.
Broome,	John Sullivan,	Sanitaria Springs
"	R. R. Mathewson,	Binghamton.
Cayuga,	H. M. Haskell,	Weedsport.
Chemung,	Fred. Uhle,	Hendy Creek,
"	M. A. Baker,	Elmira.
Cortland,	James Edwards,	Cortland.
Erie,	E. P. Dorr,	103 D. S. Morgan Building, Buffalo.
"	Marvin H. Butler,	Morilla.
Essex,	W. H. Broughton,	Moriah.
Franklin,	Jas. Eccles,	St. Regis Falls.
Montgomery,	Charles W Scharf,	Canajoharie.
Oneida,	J. M. Scoville,	Clinton.
Orange,	Wilson Crans,	Middletown.
"	J. Hampton Kidd,	Newburgh.
"	Thomas Harris,	Port Jervis.
Richmond,	Lewis Morris,	Port Richmond.
St. Lawrence,	Dr. B. W. Severance,	Gouverneur.
"	A. N. Clark,	Sevey.
Schenectady,	J. W. Furnside,	Schenectady.
Suffolk,	F. J. Fellows,	Central Islip, L. I.
"	P. F. Tabor,	Orient, L. I.
Tioga,	Geo. Wood,	Owego.
Washington,	C. L. Allen,	Sandy Hill.
"	A. S. Temple,	Whitehall.
"	J. E. Barber,	Dresden.
Westchester,	George Poth,	Pleasantville.
"	Chas. Seacor,	57 Pelham Road, New Rochelle.
"	M. W. Smith,	Croton Falls.
"	Ralph Gorham,	Mt. Kisco.
Dutchess,	A. B. Miller,	Jackson's Corners
Columbia,	James Lush,	Memphis.
Onondaga,	B. L. Wren,	Penn Yan.
Yates,	Symour Poineer,	Branch Port.
Dutchess,	Chas. H. DeLong,	Pawling.
"	Jacob Tompkins,	Billings.
Queens,	Gerard Van Nostrand,	Flushing, L. I.
"	W. S. Mygrant,	46 Elton Street, Brooklyn.
"	P. A. Geepel,	473 Grand Ave., Astoria, L. I.
"	L. B. Drowne,	119 Somers Street, Brooklyn.
Ulster,	M. A. DeVall,	The Corners.
"	Wm. S. Mead,	Woodstock.
Jefferson,	C. J. Smith,	Watertown.
Herkimer,	D. F. Sperry,	Old Forge.
Oswego,	J. E. Manning,	154 West Utica St.
Putnam,	H. L. Brady,	Mahopac Falls.
Schuyler,	G. C. Fordham,	Watkins.
Allegany,	G. A. Thomas,	Belvidere.
Schoharie,	O. E. Eigen,	Sharon Springs.
Warren,	Geo. McEchron,	Glen Falls.
Orleans,	J. H. Fearby,	E. Shelby.
Greene,	W. J. Soper,	Windham.
Hamilton,	David Aird, Jr.,	Lake Pleasant.

LOCAL WARDENS IN OHIO.

Stark,	A. Dangeleisen,	Massillon.
Franklin,	Brook L. Terry,	208 Woodward Av., Columbus.
Cuyahoga,	A. W. Hitch,	161 Osborn St., Cleveland.
Clark,	Fréd C. Ross,	169 W. Main St., Springfield.
Erie,	David Sutton,	418 Jackson St., Sandusky.
ulton,	L. C. Berry,	Swanton.

County.	Name of Warden.	Address.
Hamilton,	W. C. Rippey,	4465 Eastern Ave., Cincinnati.
Allen,	S. W. Knisely,	Lima.
Knox,	Grant Phillips,	Mt. Vernon.
Lorain,	T. J. Bates,	Elyria.
Ottawa,	Frank B. Shirley,	Lakeside.
Muskingum,	Frank D. Abell,	Zanesville.
Scioto,	J. F. Kelley,	Portsmouth.

LOCAL WARDENS IN CONNECTICUT.

Fairfield,	George B. Bliss,	2 Park Row, Stamford, Ct.
"	Harvey C. Went,	11 Park St., Bridgeport, Ct.
Fairfield,	Samuel Waklee,	Box 373, Stratford.
Litchfield,	Dr. H. L. Ross,	P. O. Box 100, Canaan, Ct.
Middlesex,	Sandford Brainerd,	Ivoryton.
New Haven,	Wilbur E. Beach,	318 Chapel Street, New Haven, Ct.
"	D. J. Ryan,	188 Elizabeth St., Derby.

LOCAL WARDENS IN MASSACHUSETTS.

Norfolk,	Orlando McKenzie,	Norfolk.
"	J. J. Blick,	Wrentham.
"	S. W. Fuller,	East Milton.
Suffolk,	Capt. W. J. Stone,	4 Tremont Row, Boston.
Worcester,	B. H. Mosher,	Athol.

LOCAL WARDENS IN NEW JERSEY.

Mercer,	Edw. Vanderbilt,	Dentzville, Trenton.
"	Roland Mitchell,	739 Centre St., Trenton.
Morris,	Joseph Pellet,	Pompton Plains.
"	Chas. W. Blake,	Dover.
"	Francis E. Cook,	Butler.
"	Calone Orr,	Hibernia.
Somerset,	G. E. Morris,	Somerville.
Sussex,	Isaac D. Williams,	Branchville.
Union,	A. H. Miller,	Cranford.
"	C. M. Hawkins,	Roselle.
Warren,	{ Jacob Young,	{ Phillipsburg.
Monmouth,	{ Reuben Warner,	{ Wanaque.
Hudson,	Dory-Hunt,	51 Newark St., Hoboken.
"	A. W. Letts,	

LOCAL WARDENS IN PENNSYLVANIA.

Jefferson,	John Noll,	Sykesville.
Perry,	Samuel Sundy,	Lebo.
Warren,	F. P. Sweet,	Goodwill Hill.
"	Nelson Holmes,	Cornplanter.
Juniata,	Clifford Singer,	Oakland Mills.
"	Ezra Phillips,	McAlesterville.
Venango,	G. D. Benedict,	Pleasantville.
Potter,	Ira Murphy,	Coudersport.
"	Wiley Barrows,	Austin.
"	Chas. Barrows,	Austin.
Crawford,	Jasper Tillotson,	Tillotson.
"	Geo. T. Meyers,	Titusville.
"	J. B. Lamb,	Buel.
Cambria,	W. H. Lambert,	720 Coleman Ave., Johnstown.
Butler,	F. J. Forquer,	Murrinsville.
Allegheny,	S. H. Allen,	Natrona.
Beaver,	N. H. Covert,	Beaver Falls.
"	W. R. Keefer,	"
McKean,	C. A. Duke,	Duke Center.
"	L. P. Fessenden,	Granere.
"	Wm. Holsinger,	Stickney.
Lackawanna,	Wm. Weir,	Moosic.
"	Wm. Major,	"
Carbon,	Asa D. Hontz,	East Mauch Chunk.
Cumberland,	J. C. Gill,	Mechanicsburg.
Wyoming,	Cyrus Walter,	Tunkhannock.
Tioga,	E. B. Beaumont, Jr.,	Lawrenceville.
"	G. H. Simmons,	Westfield.
Lycoming,	Jas. J. Brennan,	Oval.
"	B. D. Kurtz,	Cammal.
Delaware,	Walter Lussou,	Ardmore.
Montgomery,	L. C. Parsons,	Academy.
Bradford,	Geo. B. Loop,	Sayre.
Clarion,	Isaac Keener,	New Bethlehem.
Cameron,	Harry Hemphill,	Emporium.
Clinton,	M. C. Kepler,	Renovo.
"	Geo. L. Kepler,	Renovo.
Northumber-land,	G. W. Roher,	{
Elk,	505 Anthracite St.,	{ Shamokin
"	D. R. Lobaugh,	{ Ridgway.

LOCAL WARDENS IN MICHIGAN.

County.	Name of Warden.	Address.
Ottawa,	W. H. Dunham,	Drenthe.
Kalamazoo,	C. E. Miller,	Augusta.
Berrien,	W. A. Palmer,	Buchanan.
Cass,	Thomas Dewey,	Dowagiac.
Hillsdale,	C. A. Stone,	Hillsdale.
Lake,	John Trieber,	Peacock.

LOCAL WARDENS IN VIRGINIA.

Mecklenburg,	J. H. Ogburn,	South Hill.
King William,	N. H. Montague,	Palls.
Smythe,	J. M. Hughes,	Chatham Hill.
King & Queen,	R. D. Bates,	Newtown.
Louisa,	J. P. Harris,	Applegrove.
Henrico,	W. J. Lynham,	412 W. Marshall.

East Rockingham,	E. J. Carickhoff,	Harrisonburg.
------------------	-------------------	---------------

LOCAL WARDENS IN WYOMING.

Fremont,	Nelson Yarnall,	Dubois.
Uinta,	{ S. N. Leek,	} Jackson.
	{ F. L. Peterson,	
Carbon,	Kirk Dyer,	Medicine Bow.
Laramie,	Martin Breither,	Cheyenne.

LOCAL WARDENS IN TENNESSEE.

Sumner,	W. G. Harris,	Gallatin.
Stewart,	John H. Lory,	Bear Spring.
Robertson,	C. C. Bell,	Springfield.
Montgomery,	P. W. Humphrey,	Clarksville.
Madison,	H. T. Rushing,	Jackson.

LOCAL WARDENS IN NEBRASKA.

Hall,	E. C. Statler,	Grand Island
-------	----------------	--------------

LOCAL WARDENS IN NEW HAMPSHIRE.

Cheshire,	S. C. Ellis,	Keene.
Sullivan,	G. A. Blake,	Lempster.
	J. W. Davidson,	Charlestown.

LOCAL WARDENS IN VERMONT.

Rutland,	Wm. J. Liddle,	Box 281, Fair Haven
Windsor,	F. A. Tarbell,	West Bridgewater.
Orleans,	E. G. Moulton,	Derby Line.
Essex,	H. S. Lund,	Granby.

LOCAL WARDENS IN ILLINOIS.

Rock Island,	D. M. Slottard,	12th Ave and 17th St., Moline.
Iroquois,	J. L. Peacock,	Sheldon.

LOCAL WARDENS IN OKLAHOMA.

Kiowa and Comanche Nation,	A. C. Cooper,	Ft. Sill.
----------------------------	---------------	-----------

LOCAL WARDENS IN IOWA.

Clinton,	D. L. Pascol,	Grand Mound.
Pottawattamie,	Dr. C. Engel,	Crescent.

LOCAL WARDENS IN WASHINGTON.

Okanogan,	James West,	Methow.
Stevens Co.,	Jacob Martin,	Newport.

LOCAL WARDENS IN UTAH.

Washington,	S. C. Goddard,	New Harmony.
	J. A. Thornton,	Pinto.

LOCAL WARDENS IN KANSAS.

Ness,	Frank Lake,	Ransom.
-------	-------------	---------

LOCAL CHAPTERS.

Albert Lea, Minn.,	H. A. Morgan,	Rear Warden.
Angelica, N. Y.,	C. A. Lathrop,	"
Augusta, Mont.,	H. Sherman,	"
Austin, Minn.,	G. F. Baird,	"
Austin, Pa.,	W. S. Warner,	"
Boston, Mass.,	Capt. W. I. Stone,	"
Buffalo, N. Y.,	H. C. Gardiner,	"
Cammal, Pa.,	B. A. Ovenshire,	"
Champaign Co., O.,	Hy. F. MacCracken	"
	Urbana,	"
Charlestown, N. H.,	W. M. Buswell,	"
Cheyenne, Wyo.,	J. Hennessy,	"
Choteau, Mont.,	G. A. Gorham,	"
Cincinnati, Ohio,	B. W. Morris,	"
Coudersport, Pa.,	I. L. Murphy,	"
Cresco, Iowa,	J. L. Platt,	"
Davis, W. Va.,	J. Heltzen,	"
Dowagiac, Mich.,	W. F. Hoyt,	"
East Mauch Chunk, Pa.,	E. F. Fry,	"
Evansville, Ind.,	F. M. Gilbert,	"
Fontanet, Ind.,	W. H. Perry,	"
Ft. Wayne, Ind.,	W. L. Waltemarth	"
Great Falls, Mont.,	J. M. Gaunt,	"
Heron Lake, Minn.,	K. C. Buckeye,	"
Holidays'g, Pa.,	T. J. Hemphill	"
Hopkinsville, Ky.,	Hunter Wood,	"
Indianapolis, Ind.,	Joseph E. Bell,	"
Jerome, Ariz.,	Dr. L. A. Hawkins,	"
Johnsonburg, Pa.,	W. J. Stebbins,	"
Kalispell, Mont.,	John Eakright,	"

Keene, N. H.,	F. P. Beedle,	Rear Warden
Kingfisher, Okla.,	A. C. Ambrose,	"
Lake Co., Ind.,	Dr. R. C. Mackey,	"
Lawton, O. T.,	Marion Miller,	"
Logansport, Ind.,	E. B. McConnell,	"
Ludington, Mich.,	G. R. Cartier,	"
Mechanicsburg, Pa.,	Dr. J. H. Swartz,	"
Minturn, Colo.,	A. B. Walter,	"
New Albany, Ind.,	Dr. J. F. Weathers,	"
New Bethlehem, Pa.,	Isaac Keener,	"
Oklahoma City O. T.,	N. F. Gates,	"
Penn Yan, N. Y.,	Dr. H. R. Phillips,	"
Phillips, Wis.,	F. K. Randall,	"
Princeton, Ind.,	H. A. Yeager,	"
Reynoldsville, Pa.,	C. F. Hoffman,	"
Ridgway, Pa.,	T. J. Maxwell,	"
Rochester, N. Y.,	C. H. McChesney	"
St. Paul, Minn.,	O. T. Denny,	"
St. Thomas, Ont.,	L. J. Hall,	"
Schenectady, N. Y.,	J. W. Furnside,	"
Seattle, Wash.,	M. Kelly,	"
Syracuse, N. Y.,	C. C. Truesdell,	"
Terre Haute, Ind.,	C. F. Thiede,	"
The Dalles, Ore.,	C. B. Cushing,	"
Walden, N. Y.,	J. W. Reid,	"
Wichita, Kas.,	Gerald Volk,	"
Winona, Minn.,	C. M. Morse,	"

DISCOUNTS TO LEAGUE MEMBERS.

The following firms have agreed to give members of the L. A. S. a discount of 2 per cent. to 10 per cent. on all goods bought of them. In ordering please give L. A. S. number:

- Syracuse Arms Co., Syracuse, N. Y. Guns.
- Davenport Fire Arms Co., Norwich, Conn. Shot guns, rifles.
- Gundlach Optical Co., Rochester, N. Y. Photographic goods.
- Blair Camera Co., Rochester, N. Y. Photographic goods.
- James Acheson, Talbot St., St. Thomas, Ontario, Sporting goods.

LIFE MEMBERS OF THE LEAGUE.

- W. D. Ellis, 136 W. 72d street, New York City.
- A. F. Rice, 155 Pennington avenue, Passaic, N. J.
- Dr. W. A. Valentine, 5 W. 35th street, New York City.
- A. A. Anderson, 6 E. 38th street, New York City.
- A. V. Fraser, 478 Greenwich street, New York City.
- E. S. Towne, care National Blank Book Co., Holyoke, Mass.
- F. G. Miller, 108 Clinton street, Defiance, Ohio.
- Gen. J. F. Pierson, 20 W. 52d street, New York City.
- E. T. Seton, 80 W. 40th street, New York City.
- J. H. Seymour, 35 Wall street, New York City.
- A. G. Nesbitt, Maple street, Kingston, Pa.
- D. C. Beard, 204 Amity street, Flushing, L. I.
- C. H. Ferry, 1720 Old Colony Bldg., Chicago, Ill.
- Hon. Levi P. Morton, 681 5th avenue, New York City.
- H. Williams, P. O. Box 156, Butte, Mont.
- D. B. Fearing, Newport, R. I.
- E. H. Dickinson, Moosehead Lake, Me.
- Lorenzo Blackstone, Norwich, Conn.
- A. L. Prescott, 90 W. Broadway, New York City.
- G. S. Edgell, 192 Broadway, New York City.
- W. B. Mershon, Saginaw, Mich.
- Hon. H. W. Carey, East Lake, Mich.
- George Carnegie, Fernandina, Fla.
- Andrew Carnegie, 2nd, Fernandina, Fla.
- Morris Carnegie, Fernandina, Fla.
- W. L. Underwood, 52 Fulton street, Boston, Mass.
- C. E. Butler, Jerome, Ariz.
- Mansfield Ferry, 183 Lincoln Park, Boulevard, Chicago, Ill.
- Austin Corbin, 192 Broadway, New York City.
- J. Stanford Brown, 489 Fifth Ave., New York City.
- W. H. Smith, Bryn Mawr, Pa.
- E. B. Smith, Bourse Bldg., Philadelphia, Pa.
- A. J. McClure, 158 State street, Albany, N. Y.
- Walter Thompson, Times Bldg., New York City.
- Clinton Gilbert, 2 Wall St., New York City.
- E. J. Hudson, 33 East 35th St., Bayonne, N. J.

There are thousands of men in the United States who should be life members. Why don't they join? Will someone please take a club and wake them up?

REPORT OF KALISPELL LOCAL CHAPTER.

Montana is one of the greatest game States of the Union, but our game has had a hard time in past years. Deer, goats and elk, more especially deer, have been routed by pot hunters and game hogs. The office of game warden was created less than 2 years ago, since which time much credit is due the present efficient incumbent, W. F. Scott. Aided by members of the L. A. S. in different parts of the State, he has brought to justice many violators of our game laws. Montana being large, and the State warden allowed only 8 deputies, Mr. Scott was obliged to divide the State into 8 districts, each containing 18,600 square miles. Such large areas, consisting mostly of mountainous country, with few railroads, make it hard for the deputies to perform their duties to the extent of their wishes. However, they are all zealous workers and do remarkably well. Within the last 20 months more arrests and successful prosecutions for game law violations have been made than in the whole previous history of our State; and much more has been done to prevent violations and to educate the people to respect the game laws. Much credit is due Major John Pitcher, Acting Superintendent Yellowstone National Park, for the able assistance rendered by himself and scouts. His scouts have been appointed special deputies, to act without pay, and they have done much efficient work.

The head, hide and market hunters have been practically driven out of business by enforcement of the laws, and the results are evident at the present time. By the combined efforts of State Game Warden Scott and members of our League, Montana's last Legislature passed much more efficient game and fish laws. Many important changes were made. Chief among these is the abolishing of spring shooting of ducks, geese, brant and other water fowl. This will give our ducks, which have hitherto been driven North by the spring hunters, a chance to nest in the Montana lakes and rivers.

Another good feature of our new law is the changing of the season for hunting large game from September 1 to December. This leaves out December, when the snow in the mountains is very deep, making it possible to kill any number of deer. Pot hunters always took advantage of the snow to supply the lumber camps.

Under our new laws all guides are required to procure a license, for which they pay \$10 a year. Each guide is made a deputy warden and while acting as guide for any person or party shall be equally responsible with said person or party for any violation of the game law. For failure

on his part to report any violation of the law he shall be liable to the penalty imposed. Each guide so employed by a person or party is required to make a written statement to the State game warden as to the number of days he was employed, the number of persons guided, their names, residence and number of each kind of game killed; and if non-residents the number of their license.

There is created by the act what is known as the fish and game fund. All fines, licenses and other moneys collected under the provisions of the law shall be paid to the State Treasurer and placed by him in this fund. The number of deputy wardens will be increased and their salaries set at \$900 a year, and mileage when making arrests.

Any one person is allowed to kill 3 deer, one Rocky mountain goat, one elk, and one mountain sheep during the open season. Moose, bison, caribou, buffalo, antelope and beaver are protected at all times.

Montana is wonderfully blessed with large game. Deer, elk and Rocky Mountain goats are numerous. Mountain sheep are becoming scarce and hard to get. Bears have been more numerous the last season than for many years. A party of 3 and myself, last September, killed one silvertip, one black and 2 brown bears.

I note the State game warden has estimated the probable number of elk to be between 25,000 and 30,000. Blacktail deer are numerous West of the Rockies.

The most troublesome lawbreakers we have to deal with are the Indians, who go out from their reservations in large bands, accompanied by their squaws, ponies and dogs, and kill all the deer in the locality.

The Kalispell Chapter about 5 years ago turned loose several coveys of quails in Flathead valley and they are multiplying rapidly. It is now common to hear the whistle of the Bob White and frequently see them while driving along the country roads. Last spring the chapter planted a large quantity of wild rice. As yet we are unable to say how it is thriving.

Our duck and goose shooting is good and nearly all hunters return with a good bag. Two of us on a 2 days' hunt brought home 5 geese and a large bunch of ducks. We are having a hard time with the dynamiters. We will soon land a few and make examples of them.

On behalf of Kalispell Chapter of the L. A. S., I extend a hearty welcome to League members and all true sportsmen to visit our fishing and hunting grounds. I promise them the best of sport and that they will not return empty handed.

Thomas E. Dosson, Midvale, Mont.

FORESTRY.

EDITED BY DR B. E. FERNOW,

Director of the New York School of Forestry, Cornell University, assisted by Dr. John C. Gifford of the same institution.

It takes 30 years to grow a tree and 30 minutes to cut it down and destroy it.

FOREST RESERVE POLICY.

The following statement respecting the present and future policy of the administration relating to the establishment and control of forest reservations was recently made by Commissioner Richards, of the General Land Office:

"The President's desire and purpose are to protect and preserve the remaining forests on public lands from the devastation and destruction which have been the fate of those in large portions of the Appalachian mountains and in other forested sections of the country. In doing this timber will be preserved for future needs, and natural sources of water supply will be so protected as to prevent flooding of the streams during the spring and the melting of the snows, and to insure water for irrigation and other purposes during the dry season. The establishment and proper maintenance of forest reserves are indispensable to any extensive reclamation or cultivation of lands in the arid region under the recent act of Congress which appropriates for that purpose the proceeds of the sales of public lands.

"It is and has been the President's consistent policy to encourage the actual settlement of the country by home builders in every way, to see that actual settlers within the forest reserves are accorded every reasonable protection, and that those living within the immediate vicinity of these reserves, who are dependent on the reserves for grazing areas for cattle and horses and for necessary timber for building and fuel, are accorded access to the reserves for these purposes under such reasonable restrictions as will prevent waste and destruction. It has been so conclusively demonstrated that uncontrolled sheep grazing within forest reserves is injurious to the forest growth and to the natural water cover, that the great migratory flocks of sheep are necessarily kept out of the reserves; but even this policy is pursued with cautious attention to the prevention of injury to those engaged in sheep raising. The preservation of wild game, such as moose, elk and deer, which is only a minor feature of the control of the forest reserves, is authorized by an act of Congress, which directs that those employed in the forestry service shall in all practical ways aid in the enforcement of the game and

fish laws of the State or Territory in which the forest reserve is located. The law of the State or Territory on this subject is to be the sole guide of these officers. The United States has interposed no law of its own, and the administration has given no directions to its forest officers other than that the local laws, whatever they may be, shall be enforced. In some of the Western States and Territories, notably Wyoming, the government forest rangers are by the laws of the State made assistant game wardens of the State.

"The work of establishing and maintaining forest reserves will have such a vast and beneficial influence in the settlement and development of the Western States and Territories that it must be controlled by a fixed policy, to which matters of minor or temporary concern must give way for the general and permanent public good. The one guiding purpose of the administration in dealing with forestry, with pasturage, with irrigation, with the land generally, is to help and make easy the path of the home-builder, the small ranchman, or tiller of the soil, and not to let the land be exploited and skinned by those who have no permanent interest therein, and who do not build homes or remain as actual residents."

SEEDLINGS.

In the hardwood forest of the Adirondacks, where the pine and spruce have been severely culled, the only practicable method, both from financial and silvicultural points of view of securing a desirable new crop, is a clear cutting system, followed by artificial regeneration of the conifers, leaving only enough of the hardwoods to produce an admixture by natural regeneration, and saving only so much of the promising volunteer growth of young hardwoods and conifers as is not liable to be thrown by the winds. Indeed, it may often be best to make a clean sweep; denude, though the word has been used to denote vandalism, and replace artificially without reference to existing volunteer growth. This planting, of course, costs; it is an investment for the future, but one that can be easily shown to be profitable in the long run. This method can not be practiced without taking care of the rubbish resulting from the logging operation, and this, of course, again entails expense. When a simple and efficient sys-

tem of clearing, followed by planting, is practiced, the *débris* can be burned more cheaply, using the early spring season, before the snow is quite gone; and thus the fire danger, always attending logging operations, can be most readily reduced.—From 5th Annual Report of the Director of the New York State College of Forestry.

The New York State College of Forestry has, during the past year, made a substantial growth. The registration during the college year 1901-1902 began with 38 and grew through the year to 44. At the beginning of the college year 1902-1903, 30 of the old students returned and 43 newcomers were registered. Owing to withdrawals and to some changes in registration to other courses, the number was reduced to 70, namely, in addition to 2 studying for the degree of Doctor of Philosophy, having taken forestry as their minor subject: 2 seniors, 8 juniors, 11 sophomores, 38 freshmen, 9 specials. The geographical distribution of these students is as follows: From the State of New York, receiving free tuition, 45; from New Jersey, 4; Ohio, 4; District of Columbia, 2; Michigan, 2; Pennsylvania, 2; and one each from California, Connecticut, Iowa, Louisiana, Maine, Maryland, Minnesota, West Virginia, Austria, Canada and the Philippine Islands. Of the students registered, 15 hold post-graduate degrees from other institutions.

A fruit grower of Northern Kent county, Michigan, has planted a grove of chestnut trees on his farm. The nuts, it is believed, will yield an annual revenue, while the trees, when matured, will be valuable for timber. The Press, of Grand Rapids, comments editorially on the matter as follows:

If his experiment shall prove successful the promoters of reforestation will have a powerful argument to present to other Northern Michigan farmers. At present there are thousands of acres of land in the State yielding practically no profit. They are the pine barrens that stretch North from this vicinity to the straits of Mackinac. The chestnut trees, it is said, grow readily on the barrens. Here seems a chance to derive profit from hitherto reluctant soil.

The final solution of the forestry problem in this State seems to lie in the finding of various species of trees that will take kindly to the Michigan soil and yield an income while they are growing. The chestnut tree is one of these desirable species. The walnut is another. Still a third is the sugar maple. When farmers are shown an immediate as well as a distant profit from their timber lots they will pay far more attention to forestation matters than they do at present. The American farmer, like the American business man, wants quick returns. That is why he displays hesitation in planting trees from which he can not expect financial results for many years.—Exchange.

For the past 20 years the cause of forestry has been talked and worked for in this country. Nature lovers, sportsmen and economists have worked,

as forestry associations, forestry commissions and individuals. In these 20 years much has been done. Departments of forestry have been established under State and national government; State reserves have been created; the vast system of national reserves conceived and carried out; forestry schools founded; and last and most important, the education of the people has been accomplished. They have been told of the destruction of the forests, taught that the tree can be cut and the forest preserved, taught that the waters of the lowland are born of the forest.

A new era is opening, one in which we will no longer talk why anything is to be done, but of what is to be done, and how to do it; an era when forest preservation has ceased to be a question of sentiment and foresight but of actual economic necessity.

It is the lumberman who finally will preserve the forest, not for its beauty, for its benefit to the community, but for the reason which led him to destroy it, his own financial benefit. Do we find any evidence that this state is approaching, that the lumberman is ready to cut without destruction, to sacrifice the present for the future?—Forestry Quarterly.

In May, Dr. B. W. Evermann, of the U. S. Fish Commission, gave a course of 25 lectures on fish culture and fish and game protection to the juniors and seniors of the New York College of Forestry. These lectures were of great interest and value.

THE GRAND OLD FOREST.

IRA SWEET.

I love the grand old forest when it's dressed
in brightest green,
When violets are blooming in the dells
along the stream;
When its sylvan shades are ringing with
the songs of many a bird,
And the woodland fairies' love notes
through the pines are nightly heard:

I love the grand old forest when its leaves
are turning gold,
When the colors of the rainbow brightly
gleam in every fold;
When the quail tunes up his whistle and
the partridge beats his drum,
And the siren voice of Nature bids the
woodland hunter come.

I love the grand old forest when it's cov-
o'er with white,
When the silver moonbeams glisten on its
branches through the night;
When its soft and fleecy carpet gives no
echo to your tread,
And the only sound that lingers is the night
wind overhead.

Yes; I love the grand old forest through
each shifting, changing scene,
Whether white or gold and crimson, or
beauteous shades of green;
For it brings me health and pleasure as the
swift years come and go,
And I'm better for an outing in the forest
shades I know.

PURE AND IMPURE FOODS.

"What a Man Eats He Is."

Edited by C. F. LANGWORTHY, PH.D.

Author of "On Citraconic, Itaconic and Mesaconic Acids," "Fish as Food," etc.

DRINKING WATER WITH MEALS.

It is often said that drinking water with meals is injurious, one reason advanced being that the digestive juices in the stomach become unduly diluted and that thus digestion is hindered. On the other hand, the importance of taking a reasonably large quantity of water during each day, is as frequently insisted on.

It is doubtful if the water taken with meals, unless excessive, hinders stomach digestion to any great extent, and at any rate the intestines will complete the work begun by the stomach; a fact often overlooked in popular discussions. Water should not be used instead of thorough mastication, to facilitate the swallowing of food, nor does it seem advisable to drink very cold water in too large quantities. Otherwise, it appears from some recent experiments made by Ruzicka that the quantity of water taken has little effect on the thoroughness of digestion. The author was himself the subject of experiments in which the digestibility of a mixed ration was determined when a fairly large quantity of water was consumed at intervals during the day, and when practically the same quantity was consumed immediately before, during and after meals. In each case the quantity of water consumed was practically the same, averaging nearly 1,480 grams daily. The results obtained showed that the mixed diet was somewhat more thoroughly digested when the bulk of the water was taken near meal-times. The author believes that the results are not numerous enough for general deductions, but they do not warrant the conclusion that a reasonable quantity of fluid taken at meal-times can have any bad effects.

Often experiments with animals throw light on problems connected with human nutrition, and it is worth noting that results similar to the foregoing were obtained by tests made by Tangl, at Budapest, with horses, on the effect of watering before, after and during meals. So far as was observed the time of drinking had no effect on the digestibility of a ration of grain and hay. When hay only was fed there seemed to be a slight advantage in watering before feeding. The conclusion was drawn that, in general, horses may be watered before, during or after meals without interfering with the digestion and absorption of food. All these methods of watering are equally good for the horse, and

each of them may be employed, according to circumstances. It is obvious that certain circumstances may make it necessary to adopt one or other method. For instance, after severe loss of water, such as occurs in consequence of long continued, severe exertion, the animal should always be allowed to drink before he is fed, as otherwise he will not feed well. Although all methods of watering are equally good for the horse, it is not desirable to change unnecessarily from one method to another. Some animals appear not altogether indifferent to such a change. In the experiment referred to it was found that whenever a change was made from the plan of watering after feeding to that of watering before, the appetite fell off for some days. Not that the horses did not consume the whole of the food given them, but for some days together they did not eat with the same avidity as before; and they took a longer time to consume their rations completely. A similar effect was not observed when the change was from watering before to watering after feeding, or from watering after to watering during meals, or when the change was in the opposite direction to the last. It is possible that the method of watering before feeding, until the animal has become accustomed to it, produces a certain feeling of satiety. The time of drinking exercised a marked effect on the quantity of water consumed, and on the amount of water excreted. The horses drank the greatest quantity of water when it was given after feeding, and the least when it was supplied before feeding. This was especially noticeable in the morning, when water was sometimes refused if offered before feeding.

CAMP COOKERY.

The pleasure of a summer spent in camp can hardly be overestimated. Those who prefer to superintend the preparation of their own menus know that it is not always easy to provide wholesome and attractive dishes. The best ways of using the ordinary food materials which should form part of the equipment of every camp, and the methods of cooking without the conveniences of a well equipped kitchen have been treated of by a number of writers. It is now some years since Miss Maria Parloa published her "Camp Cookery," a little book which gives clear and concise directions for making many palatable

dishes from a limited list of supplies. Boiling, baking, broiling, and other methods of preparing food are explained with reference to camp conditions, the information being presented, as is always the case with this author, in a clear and interesting manner. She recommends self-raising flour, wheat, rye, cornmeal, etc., as a ready means of securing fresh bread. The list of provisions also includes salt pork, smoked ham, bologna sausage, eggs, dried beef, salt fish, pilot bread, crackers, canned fruit and vegetables, where fresh can not be obtained; potatoes, beans, onions, Indian meal, molasses, sugar, salt, pepper, mustard, vinegar, butter, coffee, tea, chocolate, rice, oatmeal, baking soda, ginger and spice. Game, fresh fish and fresh meat are supposed to be obtained in the vicinity of camp.

In a recently published volume, "Camp Fires in the Wilderness," E. W. Burt devotes a number of pages to the subject of foods, a valuable feature being the fact that his opinions are based on experience. Plain, substantial fare, he believes, is needed. "Pie and cake are not good to climb hills on. Bread, meat, vegetables and fruit are what you should select, and always buy the best quality, as it is none too good for a camper. Fruits are evaporated in such excellent style that it is not necessary to buy them canned and fill space with tin and water. All provisions should be carried in strong canvas bags, tied at the top with strings.

The following list of provisions is regarded as sufficient for 3 men for 2 weeks: 15 pounds hard bread, 15 pounds bacon in bag, 3 pounds dried apples, 2 pounds dried prunes, 2 pounds salt in bag, 5 pounds sugar in bag, 5 pounds coffee in tight can, $\frac{1}{2}$ pound tea in can, 5 cans condensed cream, 6 cans Boston baked beans, 3 cans chicken, 5 pounds butter, 5 pounds lard, 5 pounds white flour, 10 pounds Indian meal, 2 packages buckwheat flour, 2 packages oatmeal, $\frac{1}{2}$ bushel potatoes, 10 pounds onions, 1 pound baking powder, $\frac{1}{4}$ pound pepper, 1 quart vinegar, 2 gallons maple syrup, 1 jar pickles, 2 dozen eggs.

"The cost of the foregoing will be about \$15. Butter, lards, etc., should be bought before you start into the woods, while the rest can be taken up with you in an old trunk or box."

Such a list would naturally be supplemented by fish or game. Of camp fires convenient for cookery he says:

"It requires considerable skill to build a good fire. Proceed in this manner: Lay down 2 green poles, 5 or 6 inches thick, 2 feet long, and 2 or 3 feet apart. Make notches in these about one foot apart. Then cut 2 poles about the same size and lay them in the notches. Procure a good supply of dry wood and brush and start the fire on the ground between the upper

poles. The air will circulate under and through the fire, and the top poles will be found just the right distance apart to hold your camp kettle, frying pan and coffee pot. Over the fireplace you can erect a crane as follows: Cut 2 green sticks with crotches at the top, across which lay a green pole about 2 inches thick. Then cut a hooked limb and hang it on the cross pole, at the other end of which drive a nail for hanging pails over the fire."

TAMARINDS.

An old fashioned food product which is worth more attention than it now receives is the thick jam or preserve made from tamarinds. In earlier times this, with guava jelly and other delicacies, was brought to our markets by the vessels engaged in the West India trade. Some tamarinds undoubtedly come from the East Indies also, as the tree will grow in most warm countries. The dark colored acid preserve, full of shiny, round, flat, brown seeds was much liked; and "tamarind water," made from it, enjoyed a considerable vogue as a drink during sickness. Preserved tamarinds can still be bought from dealers, and one New York firm makes them.

Of the tree, a recent writer says:

"Being a member of the *Leguminosæ* family, the tamarind is allied to the pea and the bean. There are 2 varieties of the plant, the one East Indian, *Tamarindus indica*, and the other from the West Indies, *Tamarindus occidentalis*. The name of tamarind itself is derived from *Tamar*, the Arabic name for the date palm, and *Indus*, Indian. The word 'tamarind,' therefore, literally means Indian date. The pods which contain the fruit are flat in shape, brown in color, are 3 to 6 inches long, and often as thick as a man's finger. The fruit inside consists of a reddish black pulp, in which seeds, varying in number from 4 to 12, are embedded. The pulp contains potash, citric, malic and tartaric acids, in addition to gum and vegetable jelly.

"The tamarind is too acid to be eaten as a fruit, but it is used in many ways. It is employed in cookery for flavoring various dishes, especially curries, and for the preservation of fish. The West Indian variety, which is generally selected for this purpose, is imported in casks and jars, in which it is packed in layers, alternating with sugar. The East Indian tamarind, being prepared without sugar, has a medicinal value; and is refrigerant and cooling, when given as a drink, made by pouring boiling water over the fruit. The tree is a handsome evergreen, generally 30 to 40 feet in height, or even higher, with wide, spreading branches. It is decidedly ornamental, with its bright green leaves and leaflets, and is greatly used for street planting in tropical countries.

BOOK NOTICES

A GREAT BOOK FOR CAMPERS.

Buzzacott, the famous camp outfit man, has written and published a book entitled "The Camper's Manual" which is certainly the most complete of the many books on this subject that have recently been placed on the market. It has evidently been re-written and boiled down until it simply bristles with facts and information from start to finish; yet there is scarcely a line of type in it that could have been omitted without detracting from the value of the book. Mr. Buzzacott knows the camping business, if any man does. He served 10 years in the United States Army, 2 years in the British Army in Africa, 3 years on one of the Arctic voyages, and 3 years on an Antarctic exploring expedition. If this does not give a man a chance to learn all there is to know about camping, then there is no use of anyone's trying to learn the trade. Buzzacott has evidently studied every situation in which this wide range of travel has ever placed him, and has learned to make the best of his opportunities in all cases. His "Camper's Manual" tells it all, and there is scarcely a campaigner anywhere, no matter how old he may be, who can not learn something from this book. For instance, Buzzacott tells you how to heat a tent without fire, and his scheme is eminently practical, as you will see when you read the description. I will leave you to guess how it is done until you get his book and read it.

The book fairly glitters with pictures from beginning to end, and they are so glibly drawn and so sharply printed that you know at sight what everyone of them means without reading the accompanying text. There are several pictures of camp fires and of methods of cooking and baking on these that will surprise any old camper, and many of you will say when you glance at these pictures "It's strange I never thought of that before."

Buzzacott tells you how to cut the neck off a beer bottle and make a lantern of it. He also tells you, and shows you in a picture, how to make a practical camp lamp of an empty tomato can. He tells you, and shows you, how to make a camp clock. He gives you a formula for drying wet boots or shoes that few men ever thought of or heard of before, yet when you read it you will be ready to bet money that the scheme would work every time.

Buzzacott started in Chicago many years ago with a camp stove which he invented, but he is now making and handling nearly

every article that a man can want or use in camp, whether his camp is to be in the Arctic regions, the tropics, in the sunrise or the sunset country. "The Camper's Manual" tells about all these things. You are probably estimating from what I have said that this book would cost about \$2, or \$3, or possibly \$5; but strange to say, Mr. Buzzacott offers to send a copy free to each reader of RECREATION who will write him and mention this magazine. The address is simply Buzzacott, Racine, Wis.

A NATURE BOOK FOR CITY CHILDREN.

Doubleday, Page & Co., New York, have issued a book entitled "The Nature Study Idea." It is the work of Professor L. H. Bailey, and deals mainly with the modern system of conducting nature study in the common schools. This movement aims to supply a connecting link between the life and the training of children growing up in towns and cities with the great outdoor world, and Professor Bailey has aimed in his book to elucidate and popularize this modern line of study. The subject is of greater importance to future generations than most teachers in our schools realize. Nearly all the great men whom America has produced have grown up on farms, and the few others have come from among the boys and men reared in cities who have spent considerable portions of their youth and early manhood in the woods. It is of the utmost importance that every boy and girl should know all possible of the natural conditions of the soil and the forests of this country, and of the life they produce. Professor Bailey's book will be found of great value to teachers and to students of nature, and all such should read it. It sells at \$1 a copy.

I am delighted with the 2 Bristol steel rods I got from you as premiums for clubs of subscribers to RECREATION. They are all the manufacturers claim. I advise any man who wants a first class rod to get up a club of subscribers to RECREATION and get it in that way.

I received the Marble axe and knife you sent me for 7 subscribers and am well pleased with them. Every one who has seen them is surprised to know I got them so easily. RECREATION is the best magazine
David Mackie, Ashland, Wis.

PUBLISHER'S NOTES.

WHY THE WINCHESTER PEOPLE QUIT.

What is the cause of the disappearance of the Winchester ad from RECREATION? Did they get their back up about the criticisms of their guns in your magazine?

Lester G. Miller, Asbury Park, N. J.

You are correct in your surmise. The president of the Winchester company took offense at an article on revolver shooting, printed on page 349 of November, 1902, RECREATION, in which Dr. Conyngham said:

"Do not use factory ammunition. Buy the best shells and powder you can get and load them yourself, starting with a 5-grain powder charge."

Soon after that issue of RECREATION appeared Mr. Bennett, president of the Winchester company, wrote me a letter in which he claimed I should not have allowed that sentence to appear in print, and that it would work a serious detriment to their business.

I replied at length, and in the most courteous manner possible, to the effect that RECREATION is conducted as an experience-meeting, in which sportsmen are allowed to express their views and opinions and to state their experience on all matters of general interest to the craft; that under these conditions I could not well have cut out that paragraph from Doctor Conyngham's article.

I told them the Doctor's statement would undoubtedly call out contradictions from several of my readers, and that if so such would be printed.

In order to insure this, I took pains to send the Winchester letter to several expert riflemen and revolver shooters in turn, asking them to reply to Doctor Conyngham. These gentlemen all complied with my suggestion, and their articles were printed in the Gun and Ammunition Department of RECREATION, for February and March, occupying about 2½ pages. Though the item to which the Winchester people objected consisted of only 5 lines, and the answers covered more than 2 pages, Mr. Bennett refused to be comforted.

Then, in the December number, I printed an article from a contributor condemning the Winchester pump gun, whereupon Mr. Bennett wrote me another letter instructing me to drop their ad from RECREATION.

I have printed hundreds of articles commending Winchester goods, but now, when I print a few lines of adverse criticism these people drop out.

What do the readers of RECREATION think of such business methods?

BEN, THE LIFE STORY OF A CUB.

As announced in May RECREATION, this remarkable bear story will be printed in the July issue: I have had 17 drawings made for it, and as it now stands the story and illustrations will occupy about 14 pages of RECREATION. It is safe to say the narrative will be more eagerly read and discussed than any ever printed in this magazine.

Ben was a remarkable product of a mountain wilderness. He seemed endowed with more than ordinary ursine instinct, ingenuity and cuteness; and Mr. Wright, who captured him, had a better opportunity to study him than any other writer has ever had to study a wild animal in its native environment. Ben was captured when a baby, and traveled with a pack outfit all summer. He was made the guest of honor as well as the pet of a hunting, fishing and exploring party; and the things he did to amuse and puzzle his friends were legion. Mr. Wright is a close student of wild animals. He has spent 25 years in the mountains, and has killed more than 100 bears. In order to have been so successful it has been necessary for him to study their habits closely, to have learned what they feed on, what grounds they seek at various times of the year, how they acquire their food, etc. He used Ben as a living object lesson, and in this story has given to the world the result of this long and careful study. It is doubtful if nature students will ever have another such opportunity to learn just how a cub learns how, when bereft of his natural teachers.

Tell all your friends that this great bear story is coming in July RECREATION, and advise them to make sure of getting a copy. Tell your newsdealer to order an extra lot of that issue, and that he will be supplied in due course with a poster containing one or more pictures of Ben, to hang in his window.

EASTMAN PORTFOLIO.

The Eastman Kodak Co., Rochester, N. Y., has issued a portfolio of the prize winning pictures in its recent competition, which is indeed a luxurious work of art. The reproductions are the finest that it is possible for any engraver in the world to make, and the printing is the best possible. This portfolio is a striking object lesson to the world as to the wonderful progress still being made in photography. Many of us thought years ago that the limit of the possibilities of the camera had been reached, but apparently there is no

limit; the amateurs continue to improve in their work from year to year.

Every student of the science of photography should have a copy of this remarkable publication. If published on a purely commercial basis, it would sell readily at 50 cents a copy. The Eastman people offer it at 10 cents a copy, and say they will charge up the difference between that sum and the cost of production to advertising. It will certainly prove a valuable piece of publicity to the Kodak people. In ordering please mention RECREATION.

The Gundlach-Manhattan Optical Co., Rochester, N. Y., has issued a new catalogue of Korona and Wizard cameras which will prove a revelation to anyone and everyone interested in photography. Good things in the catalogue line come so thick and fast that it is difficult for a busy man to get time even to look at all of them; but this book is so exceedingly interesting, artistic and novel, that the average photographer would even postpone an invitation to take something in order to go through it and look at all the pictures. Then he would be mighty likely to sit up at night to read what this book says about the cameras and accessories made by the Gundlach-Manhattan Optical Co. When you write for it, please say you saw it mentioned in RECREATION, for it always makes a lot of difference to the advertiser and to the publisher of this magazine whether or not you make such mention.

The Northern Rubber Co., St. Paul, Minn., is making a lumbermen's rubber shoe, with a lace top of heavy wool-lined duck canvas, which will certainly prove popular among sportsmen when it shall become known. The shoe has an extra heavy sole, turned up around the edge, and the top is made 8 to 10 inches high, as ordered. The trouser leg may be gathered in and the shoe laced up outside of it; or the shoe may be worn over a heavy German sock if desired. This makes an excellent footgear for use in wet grass, on marshy ground or in snow, and by having 2 pairs of these shoes, so that you can alternate them from day to day, you can have dry feet all the time. The shoes sell at \$3.50 a pair, express paid to any part of the United States.

When you send in your order, please mention RECREATION.

Geo. M. Houghton, Traffic Manager of the Bangor & Aroostook railway, has issued a book entitled "The Haunts of the Hunted," which is the most luxurious and elaborate of the many excellent guide books that have come from his office. The present volume, for so it may properly be

called, is a veritable storehouse of information and contains an almost bewildering array of attractive and interesting pictures. These represent every possible phase of camp life, hunting, fishing, canoeing, etc. No man who loves the woods can spend 10 minutes examining Mr. Houghton's new book without longing to kick the dust of the city from his shoes and make a break for the wilds of Maine.

You can get a copy of this book by writing Mr. Houghton at Bangor, Me., and mentioning RECREATION.

Hemm & Woodward, Sydney, Ohio, have lately added to their stock a full line of rifle wick plugs, which are just the thing that thousands of riflemen have been longing for these many years. Hemm & Woodward are furnishing wicks to fit any rifle from 30 caliber up to 50. Oil the wick, draw it through the rifle barrel 2 or 3 times, and it cleans the barrel thoroughly. Then draw the wick in again, leave it there, and put your rifle away. I believe that if you use good oil or any standard gun grease, your rifle may stand a year without attention and that it will show up as bright and good as new when you pull out the wick. Order a sample wick, and you will never be without a supply of them thereafter. Please mention RECREATION when ordering.

Coffeyville, Kansas.
Marble Safety Axe Company, Gladstone, Mich.

Dear Sirs: Your catalogue received and I find it extremely interesting. The fact that Mr. G. O. Shields, editor of RECREATION, is one of your customers brings me to the conclusion that your goods are all right, for although I am not personally acquainted with Mr. Shields, I have great confidence in his judgment on all matters pertaining to sporting equipment, gained from a constant perusal of his most valuable and reliable magazine. Enclosed herewith find money order for \$4.50, for which please send me one No. 3 5 inch safety pocket knife with German stag handle.

Yours truly, Rudolph A. Hiller.

One of the features of the modern dining car service is the menu card, which, in addition to giving a list of the dishes served, wine list, etc., now frequently contains illustrations calculated to attract the eye and engage the attention of the traveler. The New York Central, with the beginning of the new year, has introduced a very artistic series of menus which have for the illustration quaint and beautiful female heads and figures which will certainly add to the attractiveness of the meals *en*

route. A copy will be given to each lady patron of the dining cars, and persons not fortunate enough to travel on the Central may get copies by writing Geo. H. Daniels, Grand Central Station, N. Y.

Here is a partial list of the good qualities of the new Mullins sheet metal boats:

They do not become water soaked.

They do not have to be calked.

They do not have to be housed or stored away.

They can not sink.

They are lighter and run easier than any wooden boat.

They will outwear any wooden boat.

They are the safest boats afloat.

They are the handsomest boats afloat.

They are the best boats on the market.

One of them will last a lifetime.

They are the cheapest boats on the market.

RECREATION readers are cautioned against sending money to the Magniscope Rifle Sight Co., of York, Neb. The former managers of that concern, J. A. Coxe and W. G. Boyer, have proven thoroughly unreliable. They have failed to fill some of the orders entrusted to them by RECREATION readers, and have failed to make good their guarantees in other cases. Furthermore, they now owe me \$80 for advertising in RECREATION, and refuse to pay their bill. C. A. Schrandt writes me that he has bought out the business, yet he declines to fill certain orders, or to make good certain obligations of his predecessors.

The Chicago & Alton railway has issued a beautiful little book entitled "People You Meet in the Dining-Car." Dudley Walker, the advertising manager of the Alton, is a genius, and is always getting up something new and novel; but in this case he has outdone himself. He has produced here some real gems of the photographer's art and some exceedingly bright bits of text to accompany them. The picture of the girl on page II is alone worth the price of a ticket from Chicago to St. Louis, yet you can get the whole book by writing a request for it on a postal card and mentioning RECREATION.

Geo. T. Tomlinson, of Syracuse, N. Y., who is well known to thousands of sportsmen as the former manufacturer of the Tomlinson gun cleaner, has secured the patents on a recently invented automatic fishing reel, and is organizing a stock company for the purpose of making and putting them on the market. The prospectus which Mr. Tomlinson is sending out is attractive and interesting and it would be well for sportsmen who are interested in the reel problem to get a copy of it. Mr. Tomlin-

son refers to 2 of the Syracuse banks, so that there may be no question as to his reliability.

Every sportsman needs a corkscrew that will draw a cork clean and unbroken. The Yankee cork puller is an ingenious device that can be fastened against any upright surface and that will remove and automatically discharge the most stubborn cork without effort, leaving no broken bits in the bottle. If you can not find the Yankee corkpuller at the hardware stores, write the Gilchrist Company, 125 Lafayette street, Newark, N. J.

Persons looking for places in which to spend the summer or autumn months should read the ad of the New Hermitage hotel in this issue of RECREATION. The hotel is located at Lake Bonaparte, in the heart of the Adirondack mountains, and is surrounded with forests, lakes and streams that afford capital opportunities for the enjoyment of the open season. You can get a beautifully illustrated pamphlet showing many views of surrounding points of interest by addressing David Scanlin, Bonaparte, N. Y., and mentioning RECREATION.

The Blair Camera Co., Rochester, N. Y., has issued a new catalogue illustrating and describing some of its new and some of its older models of Hawkeye cameras. The book is elaborately illustrated, the text is full and complete and any one interested in outdoor photography can get many valuable points from this little book. Send for a copy of it and say you saw it mentioned in RECREATION.

Minneapolis, Minn.

The Mitchell M'fg Co.,
London, Ohio.

DEAR SIRS:

The J. C. hand trap received, through RECREATION, and I am much pleased with it. The first time I used it I got 29 out of 30 clay birds.

Truly yours, O. L. Solberg.

Messrs. Spratts Patent tell me they penned, fitted up and fed the Coshocton dog show, in March, also the Chicago, Buffalo and Atlantic City dog shows; in all of which their work was, as usual, most successful. The week following the show at Atlantic City they put up, on Young's ocean pier, a cat, cavy and pet stock exhibition.

The Hopkins & Allen Arms Co., of Norwich, Conn., has issued a new catalogue of shot guns, rifles and revolvers which will interest all sportsmen who are looking for good serviceable firearms at the lowest possible price. Write for a copy of it and mention RECREATION.

EDITOR'S CORNER.

IDAHO'S NEW GAME LAW.

The Idaho Legislature has passed a modern, up-to-date game law, and it has been approved by the Governor; so that that State now has a proper provision for the protection of its game and game fishes and its songbirds.

This new law provides for the appointment of a State game warden and for a number of deputies, and that they shall be paid reasonable salaries. It limits the number of birds and animals which any man may kill in a day to a reasonable figure. For instance, no man shall kill more than 15 quails, 18 grouse of any species, or 3 geese or swans, in one day. No man shall kill more than one bull elk, one mountain sheep, one goat, one antelope, or 2 deer in a season. No man shall hunt in that State without first having procured a license. The fee for resident sportsmen is \$1 a year, and for non-residents \$25 a year. The fee for a fishing license for a non-resident is \$5 a year. The sale of game of all kinds is absolutely prohibited at any time, and no game shall be shipped out of the State at any time unless accompanied by the man who killed it.

All sheriffs, deputy sheriffs, city marshals and police officers are made *ex officio* game, fish and forestry wardens.

The one serious objection to this new game law is that it does not prohibit entirely the killing of antelope at any time. The League made a strong effort to have that animal protected in Idaho for at least 5 years, but the law makers decided to permit each hunter to kill one antelope each year; such provision having been urged by many thoughtless and reckless ranchmen.

There is one amusing provision in this new law. It is that each hunter is allowed to kill one ibex each year. I assume this carries with it permission for Idaho hunters to go to Africa or India on hunting trips, if they have the price.

CAPTAIN KELLY IN A HOT FIGHT.

Luther S. Kelly, better known to Western men as "Yellowstone Kelly," and an old time contributor to RECREATION, is now stationed at Surigao, P. I., where he is filling the position of Provincial Treasurer. Judge Taft reports to the Secretary of War that in March last 10 prisoners who were serving sentences for various offenses in the local prison, escaped, and that, with 70 or 80 *insurrectos*, they attacked the constabulary barracks, killing 2 Americans and capturing a large quantity of arms and ammunition. Nine of the Americans retreated to the Provincial building, where,

under the command of Captain Kelly, they barricaded the building and stood off the attacking party, with the few guns and other weapons that could be hastily got together. A sharp fight was kept up for 18 hours, at the expiration of which time reinforcements arrived from a neighboring town and the insurgents were put to flight.

Captain Kelly is an old time Indian fighter and scout, and has always been equal to any emergency that has arisen where he has been in command. He is a member of the League of American Sportsmen, and is well known to thousands of good people in this country.

Mr. F. M. Halstead, of Berkley, Va., was arrested some months ago, by county officer H. F. Grinalds, for shooting quails before the opening of the legal season. He was tried before a justice of the peace, and claimed exemption from the law on the ground that he killed the quails on his own ground, because they were destroying valuable seeds which he was raising. The justice denied the validity of this claim and fined Mr. Halstead \$10. He refused to pay the fine and appealed to the Norfolk county court. Judge Portlock, in deciding the question, emphatically reaffirmed the State ownership of wild game, confirmed the decision of the lower court, and Mr. Halstead paid his fine. There are thousands of farmers in this country who claim the right to kill game on their own land at any time of year, but it would be well for all of them to learn this important principle in law, namely, that live wild game does not belong to any man because it chances to feed on his land occasionally or to walk or fly across it.

Two more fish law violators have come to grief. These are Frank Brower and Irvin Walker, of Noble county, Indiana. They were spearing in Loon lake, when Deputy Fish Commissioners R. D. Fleming and Jas. F. Hamilton, of Marion, made a sneak on them. The men had a double barreled shot gun with them, and the officers heard them boasting of what they would do to any man who might attempt to interfere with them. At this point, the officers advanced on them and ordered them to throw up their hands. Brower attempted to stand the officer off with a spear, but in a minute he was looking into the muzzle of a 6 shooter, so both men quietly surrendered. They were taken to court, where they were fined \$38.80. Not having the change in their pockets, they were locked up in jail.

The reports issued from the U. S. Patent Office each week contain frequent notices of patents issued to game and fish hogs, that are enough to bring tears to the eyes of any true sportsman. The infernal devices being invented by bristlebacks and by men who would cater to them, are simply appalling.

In one of these weekly reports now before me, there is a drawing and a description of a bird trap; another of a fish hook, and another of an artificial minnow, which are so manifestly damnable in their nature that their use should be prohibited by law. If we had a true sportsman in the big chair of the Patent Office, he would refuse to issue patents on many of these infernal machines for which governmental sanction is sought.

Caroline Harding, editor of the Palm Beach Daily News, prints in a recent issue of that paper, an eloquent plea for the protection of birds, in which she says, among other things:

"That birds soon became aware of protection is shown in no way more strikingly than by the numbers of lesser scaup ducks that all through the winter dive and sail confidently about the shores and docks of Palm Beach and West Palm Beach. A few miles South it is almost impossible for a boat to get within range of them."

It is indeed encouraging to find so many editors of daily and weekly newspapers throughout the country coming into the ranks of game and bird protectors.

Alphonse Laurence, of Missoula, Mont., was arrested in March last for killing song birds, and on proof of guilt, Justice Phillips fined him \$50. Alphonse refused to pay, and was locked up. It seems almost pathetic that a man who carries such an aristocratic name should be degraded by having to live in a bastille, but Alphonse is not the first man to suffer for slaughtering song birds. It is hoped Alphonse will learn to devote his leisure to something more worthy of his romantic cognomen.

L. A. Petrie, Glace Bay, Cape Breton, will make a determined effort this summer to land one of the great tunas which have of late years frequented that bay in goodly numbers. The picturesque Mira river has its estuary in Mira bay, and is famous angling ground for all the great game fishes. Being tidal for 15 miles of its course, the sea bass, sea trout and the Atlantic salmon use it as a river, and summer in the cool, deep waters of its upper reaches.

Mr. Petrie is an enthusiastic sportsman, and can furnish guides and full information to fellow sportsmen.

Mr. A. W. Fassig, a restaurant man in Columbus, Ohio, was serving quails in close season, entering them on the bill of fare as snow birds. Taken into court by a game warden, Fassig claimed he thought they were snow birds; but every sensible man present knew he was deliberately lying. The court was convinced of this fact and fined Mr. Fassig \$200, which the latter paid. When he advertises to sell snow birds hereafter, he will probably give his customers the real thing.

The Park Commissioners of Tacoma, Wash., recently presented the New York Zoological Society with a pair of Olympian elk, otherwise known as Roosevelt's elk, and so named by Dr. Merriam, in honor of the President. These animals came through from Tacoma by express in good condition, and Director Hornaday has placed them in a section of the elk range by themselves, where they are attracting a great deal of attention.

Oscar North, of Moingona, Ia., recently took a bag of catfish to a hotel at Boone, Ia., where he delivered them to the cook. Before he could get his pay for them, Deputy Game Warden Louis Jensen stepped in, captured the fish and the fisherman; took the latter to Justice Barrett's office, where he pleaded guilty and was fined \$50 and costs. North's sister paid the fine for him, and he says, "There won't be no more fish lines out at Moingona."

W. H. Johnston, foreman of the Electric Light company at Dillon, Mont., killed 2 willow grouse near that place in April last and paid the State \$50 each for them. Deputy Game Warden Henry Avare acted as collector in the case and Judge Vermilion as treasurer. Johnston will probably try to get along on spring chicken and squab hereafter until the legal shooting season opens.

Frank Nichols and Will Faulk, of Allegan, Mich., broke the fish laws of that State, were arrested by Deputy Game Warden Coulter, taken before Justice Cook and fined \$4.35 and costs each. They probably deserved a good deal heavier dose than this, but possibly this may prove sufficient to induce them to walk in the straight and narrow way hereafter.

A young man in Earlville, N. Y., wrote me an interesting letter regarding his observations of certain birds, but as he forgot to sign his name to it I can not use it, nor can I even acknowledge receipt of it by mail. Readers are once more reminded that no notice can be taken of unsigned communications.



Schlitz

THE BEER
THAT MADE
MILWAUKEE
FAMOUS.

The Water Used in Schlitz Beer comes from six wells bored to rock

We are on the shore of Lake Michigan, yet we go into the earth to get water that is absolutely pure.

And we go to Bohemia for hops, when other hops cost but half.

We spend fortunes on cleanliness.

We not only filter the beer, but we filter all the air that touches it.

And we age the beer for months in refrigerating rooms, so it cannot cause biliousness.

Then we sterilize each bottle, to kill every possible germ.

Schlitz sales increased 132,916 barrels last year

That's a greater increase than of any other brewery in the world, and above are the reasons for it.

Ask for the brewery bottling.

THE REASON.

CHAS. E. SCOFIELD.

There had been a light fall of snow during the night. When the morning broke, crisp and frosty, and the air tingled with the delicious vigor of a December morning, the soul of the druggist revolted in him at the thought of the day's dull routine. He yearned for the sights and sounds of the great outdoor; so when, a few moments later, Cottontail George, the most confirmed and inveterate rabbit hunter along the Minnesota river, came in and announced that there were fresh rabbit tracks by the thousand all over the bottoms and that he proposed to follow some of them to their logical conclusion, the idea was eagerly taken up by the druggist. Soon they were combing the bunnies out of the brush heaps and patches of weeds along the river banks. They ate their lunch on foot; and finally, when their bulging game pockets and the declining sun of the short December day, warned them that it was time to strike for home, they found themselves 10 miles from town, very hungry and more tired. The druggist proposed that they turn their steps toward Odessa, which was only 3 or 4 miles distant, have supper there and take the afternoon freight up to Ortonville. Cottontail George was only too willing, for he longed for something hot.

Alas for the frailty of human hopes! As the weary hunters pulled into the outskirts of the town, the freight pulled out! That meant either a 6-mile walk through a gathering storm, or an 8-hour wait for the night mail train. A surprisingly short canvass of the situation brought them to the unanimous conclusion that an 8-hour wait beside a hot stove, was vastly preferable, at that stage of the game, to a 3-hours' tramp through the shifting snow; so after a bountiful feed at Grover's, they sought the comforts of a pipe and glass at Dick's place, to await with patience the coming of the West-bound train.

Odessa is distinctly a way station, the agent retiring from public life at about the same hour as the hens. The traveler wishing to take a night train must equip himself with a lantern and flag the train as it goes through. At 12 o'clock the bartender turned out our hunters and closed his place, first loaning them a lantern and directing them to the station. Finding the door locked, they sought the cold comfort of the lee side of the station, and there they tramped up and down. The storm shrieked louder and the snow blew thicker. The hunters sleepily cursed the time table and the railroad management from the president down to the section crew, and prayed for the coming of the train. At last a shrill whistle and the roar of the approaching train warned them that their weary vigil was over. The druggist, who was carrying the light, moved over to the edge of the platform and signalled for a stop. Just as the engine thundered up to the station,

Cottontail George stepped out from the shadow of the building, with his cap drawn down over his eyes, and his gun at a ready. The startled engineer threw the throttle wide open and tore into Ortonville in record time, reporting an attempted holdup at Odessa.

That is the reason the druggist and Cottontail George were too tired to eat breakfast that morning, and why it is unsafe for even their best friends to approach them on the subject of rabbit hunting.

WHO SAID RATS?

C. N. DOUGLAS.

A pussy cat sat by the kitchen fire and dozed in a listless way;
Full length, inert, as if half dead, she there in slumber lay.
But, oh! A wondrous change came o'er that sleepest of cats
When Mary Ann dropped the frying pan and suddenly shouted "rats"!

Rats! rats! Who said rats?
Who was that said rats?
Only show me where they are,
The little pesky brats!
You thought that I was sleeping,
But wide open I was keeping
One ear any eye so I could fly
If any one said rats!

A sad little dog lay out in the yard and never a hair moved he.
He seemed as if dead, or glued to the earth, or a marble statue must be.
But he sprang to his feet like a lightning flash when Bill Jones and Jonathan Sprats.
Within his hearing began to discuss the peculiar ways of cats!

Cats! Cats! Who said cats?
Who said Thomas cats?
Show me where they are and if you
Are fond of watching sprats.
You thought that I was sleeping
But wide open I was keeping
One ear and eye, so I could fly
If anyone said cats!

A bad little boy reclined on a bench and dreamed in the warm June sun,
And beside the boy was that murderous toy, an elegant new air gun.
And borne on the breeze came a sound through the trees, and that laziest of brats,
Grabbed his gun like a bird and yelled as he heard, "Who's that said rats or cats?"

Rats! Cats! Rats! Dogs! Cats!
Who said rats, or cats?
I'm looking for fun with my little air gun
I'm death on rats or cats!
You thought that I was sleeping,
But wide open I was keeping
One ear and eye so I could fly
If any one said rats!



THE EQUITABLE

HENRY B. HYDE
FOUNDER

J.W. ALEXANDER
PRESIDENT



J.H. HYDE
VICE PRESIDENT

"Defer not till to-morrow to be wise,
To-morrow's sun to thee may never rise."

"MAKE HAY WHILE THE SUN SHINES"

An Endowment policy in the Equitable
makes money for you — and at the
same time protects your family.

But you can only secure it while the
sun of good health is shining.

Vacancies in every State for men of energy and character to act as representatives.

Apply to GAGE E. TARBELL, 2nd Vice President

For full information fill out coupon below, or write
THE EQUITABLE LIFE ASSURANCE SOCIETY of the United States
120 Broadway, New York. Dept. No. 16

Please send me information regarding an Endowment for \$.....
issued at.....years of age.

Name.....

Address.....

AMATEUR PHOTOGRAPHY.

"For sport the lens is better than the gun."

I wish to make this department of the utmost use to amateurs. I shall, therefore, be glad to answer any questions and to print any items sent me by practical amateurs relating to their experience in photography.

8th ANNUAL COMPETITION.

RECREATION has conducted 7 amateur photographic competitions, all of which have been eminently successful. The 8th opened April 1st, 1903, and will close November 30th, 1903.

Following is a list of prizes to be awarded:

First prize: A Long Focus Korona Camera, 5 x 7, made by the Gundlach Optical Co., Rochester, N. Y., fitted with a Turner-Reich Anastigmat Lens, and listed at \$85.

Second prize: A No. 3 Folding Pocket Kodak, made by the Eastman Kodak Co., Rochester, N. Y., fitted with a Bausch & Lomb Lens, Plastigmat Unicum Shutter, and listed at \$61.50.

Third prize: A Royal Anastigmat Lens, 4 x 5, made by the Rochester Lens Co., Rochester, N. Y.; listed at \$36.

Fourth prize: A Waterproof Wall Tent, 12 x 16, made by Abercrombie & Fitch, New York, and listed at \$32.

Fifth prize: An Al-Vista-Panoramic Camera, made by the Multiscope and Film Co., Burlington, Wis., and listed at \$30.

Sixth prize: A No. 3 Focusing Weno Hawkeye Camera, made by the Blair Camera Co., Rochester, N. Y., and listed at \$27.50.

Seventh prize: A high grade Fishing Reel, made by W. H. Talbot, Nevada, Mo., and listed at \$20.

Eighth prize: A Tourist Hawkeye Camera, 4 x 5, and made by the Blair Camera Co., Rochester, N. Y., and listed at \$15.

Ninth prize: A Bristol Steel Fishing Rod, made by the Horton Mfg. Co., Bristol, Conn., and listed at \$8.

Tenth prize: A pair of High Grade Skates, made by Barney & Berry, Springfield, Mass., and listed at \$6.

The 10 next best pictures will each be awarded one dozen 8 x 10 Carbutt Plates, made by the Carbutt Dry Plate Co., Wayne Junction, Philadelphia, Pa.

The 10 next best pictures will each be awarded one dozen 5 x 7 Carbutt Plates.

The 10 next best pictures will each be awarded one dozen 4 x 5 Carbutt Plates.

A special prize: A Goerz Binocular Field Glass, listed at \$74.25, will be given for the best picture of a live wild animal.

Subjects are limited to wild animals, birds, fishes, camp scenes, and to figures or groups of persons, or animals, representing in a truthful manner shooting, fishing, amateur photography, bicycling, sailing or other form of outdoor or indoor sport or recreation. Awards to be made by 3 judges, none of whom shall be competitors.

Conditions: Contestants must submit 2 mounted prints, either silver, bromide, platinum or carbon, of each subject, which, as well as the negative, shall become the property of RECREATION. Negatives not to be sent unless called for.

In submitting pictures, please write simply your full name and address on the back

of each, and number such prints as you may send, 1, 2, 3, etc. Then in a letter addressed Photographic Editor, RECREATION, say, for instance:

No. 1 is entitled — — —.

Made with a — — — camera.

— — — lens.

On a — — — plate.

Printed on — — — paper.

Length of exposure, — — —.

Then add any further information you may deem of interest to the judges, or to other amateur photographers. Same as to Nos. 2, 3, etc.

This is necessary in order to save postage. In all cases where more than the name and address of the sender and serial number of picture are written on the back of prints I am required to pay letter postage here. I have paid as high as \$2.50 on a single package of a dozen pictures, in addition to that prepaid by the sender, on account of too much writing on the prints.

Any number of subjects may be submitted.

Pictures that may have been published elsewhere, or that may have been entered in any other competition, not available. No entry fee charged.

Don't let people who pose for you look at the camera. Occupy them in some other way. Many otherwise fine pictures have failed to win in the former competitions because the makers did not heed this warning.

HELPS OVER PHOTO HURDLES.

Regarding blisters on cyco paper, if the temperature of the various baths be kept at one point the trouble will end. Cyco prints taken from a hypo bath which has been allowed to become warm, and doused into a washing tray full of cold water, are apt to blister. Changes from a warm developer to a freshly made hypo bath will also cause blisters. Notice the fall in temperature in a hypo bath the next time you make it up.

My plan for years has been to make a saturated solution of hypo and have a 5 pint bottle full at all times, with a layer of undissolved hypo on the bottom. Of this solution I take 4 ounces and add 4 to 6 ounces of water slightly warm. This makes it right and saves the annoying delay.

I do not agree with G. W. Damon in his advice to use bromide. It is entirely too rapid for the average amateur. I have been using Carbutt's Vinco paper for years and find it ideal for all kinds of negatives. It is about 6 times as rapid as any of the gaslight developing papers and yields fine prints. It allows more latitude both in exposure and in development. The whites are pure and do not get gray and smoky, as

with other papers. The development is under perfect control at all times. Unless the correct exposure is given with the other papers, the image will either flash up and blacken before the print can be removed from the developer, or it will require prolonged development, in which case the paper becomes stained. This is not the case with Vinco. Then there are no freaks to contend with, such as are found in at least one of the others.

I make a mixture of water, 5 ounces; sulphite of soda crystals, $\frac{1}{2}$ ounce; commercial acetic acid, 3 ounces; powdered alum, $\frac{1}{2}$ ounce. Of this mixture I add 2 or 3 ounces to each quart of hypo solution. This hardens and at the same time clears the film on plates, films and papers. It also admits of longer use of the hypo solution, as it does not discolor so rapidly.

For preventing halation at windows I find Acme halation destroyers all that can be desired. They consist of a sheet of paper cut to negative size, coated on one side with an opaque substance which is only necessary to moisten with a sponge or rag and squeegee on the back of the plate. This may be removed by soaking in water before development.

To A. H. Harlow I would give the following advice: Never touch the face of your ferrotype plates under any circumstance. Keep them clean. Allow all prints to dry over night, and the next day, or at any future time, soak them in clean water until they are limp. Place on the plate cover with a blotter, avoiding undue pressure on any particular spot, and roll out the water between plate and print. Stand aside to dry, when the print will come off and not stick. Greasy fingers coming in contact with the plate cause prints to stick and when once they stick they will continue sticking until the plate is thrown away.

Frequent advice is given to amateurs to make their own developers. To those who wish to do so, I give the following hints, and I have made developers and sold them for years: Buy only the best and purest chemicals. Never buy sulphite of soda in bulk, as it is sure to be coated with sulphate. Buy it in bottles of one pound each and in a dry state, it being twice as strong as the crystals. Do not make up a large quantity at one time unless you put it in small bottles, as whenever a portion is taken out of the bottle its place is taken by air and it is then apt to discolor. Don't use chemicals of any kind over and over, thinking to economize; you can't do it. Each chemical will do so much work and no more. Many dense, slow printing negatives are made so by using an exhausted developer. Such negatives should be re-

duced to save time, if a large number of prints are desired.

Here is a method of intensifying which works well and enables one to get a good vigorous print from a negative which before treatment would yield but a poor one. Dissolve one dr. bichloride of mercury in 7 ounces water; and 3 drams potassium iodide in 3 ounces water. When completely dissolved pour the iodide solution into the mercury solution until the red precipitate is completely dissolved. For use, dilute with water, full strength, and flow over the negative. This may be done dry or the negative may first be soaked a few minutes. When the proper density is reached, wash, and the deposit will turn yellow. Remove the yellow by flowing with a 5 per cent. solution of hypo, and give a final washing. Should some of the yellow color remain, it will not affect the printing qualities of the plate. Try it off an old plate, and you will be astonished at the result.

C., Bethlehem, Pa.

A CAMERA FOR THE BEGINNER.

In selecting a camera, the beginner should determine to have the best he can possibly buy. Nothing but disappointment comes of having poor instruments and material. Needless to say, choice should be made from among the makes advertised in RECREATION. In size, unless some special class of work is designed, the 4 x 5 camera recommends itself as the best for general use. The outfit is not burdensome to carry about, supplies can be procured for it in almost any town, and the expense of operating it is comparatively small. Negatives of this size are convenient for both enlargement and reduction; they are large enough to be satisfactory in and of themselves, yet not so large as to be inconvenient of manipulation in the darkroom and printing processes.

While the press-the-button box cameras are convenient for some kinds of picture taking, they have serious limitations. The bellows type of camera is far the best. The bicycle styles, by reason of their compactness and portability, are desirable; though the double extension box styles, by reason of their great bellows capacity, may well be considered. A bellows draw of less than 15 inches is undesirable and should not be accepted; the longer the draw the greater is the capacity of the instrument for doing things, consequently the greater the satisfaction in it.

By all means let the camera be provided with reversible back; the rack and pinion focussing arrangement, swingback, vertical and lateral movements of lens support are also desirable features. Above all things, a good lens and shutter are essentials to

success. The standard cameras of the day are usually provided with such, and in buying them one is reasonably sure of getting an instrument satisfactory in every respect.

H. D. Grose, Ann Arbor, Mich.

METOL-HYDROCHINONE DEVELOPER.

Will you kindly publish a formula for a good 2 solution metol hydrochinone developer for plates, one that can be kept as a stock solution and used diluted when desired?

I strongly advise all who use developing paper to give Darko a trial. A friend and I have used a quantity of this paper and found it as good as Velox, except that it is not so sensitive. With Welsbach light only 20 seconds' exposure is necessary; with diffused daylight even less is required. Darko is about 50 per cent. cheaper than Velox. I have found the blacks and whites as good with this paper as with others. It can be obtained in a variety of surfaces.

Floyd D. Palmer, Earlville, N. Y.

ANSWER.

Metol-Hydrochinone Developer.

No. 1.

Metol 1 ounce
Hydrochinone 1/8 ounce
Sulphite of soda, crystals..... 6 ounces
Pure hot water.....80 ounces

No. 2.

Carbonate of soda, crystals..... 5 ounces
Pure water80 ounces

For Use.

Solution No. 1..... 1 ounce
Solution No. 2..... 1 ounce
Pure water 2 ounces

REGARDING CITRATE.

In January RECREATION the use of a citrate in place of a bromide as a restrainer is advised. If the author refers to citrate of potassium, I think he is mistaken in saying that the price of citrate is high. Citrate of potassium, citric acid and citrate of sodium are quoted wholesale at a price that allows the druggist to sell them at 60 cents a pound with a good profit, and bromide at 50 cents. The statement that the citrate could be prepared by the addition of sulphuric acid to carbonate of potassium or sodium is wrong. The addition of sulphuric acid to carbonate of potassium or sodium produces sulphate of potassium in one case and sulphate of sodium in the second. Citrate of potassium is prepared by taking 6 ounces of citric acid dissolved in 2 pints of distilled water, to which 8 ounces carbonate of potassium is gradually added. If the resulting solution is not neutral, it is made so by the further addition of carbonate potassium or citric acid. The solution is then filtered and evaporated to dryness. A. M. K., Roxbury, Mass.

SALTING AND SENSITIZING PLAIN PAPER.

Boil 2 ounces of distilled water, to which has been added 1 dram of aqua ammonia. When boiling, saponify as much fine French resin as will neutralize the alkali. Test with litmus. Of this solution of saponified resin, filter out 1 ounce; take of water 4 ounces; heat above and add gelatine, previously swelled, 6 grains; ammonia chloride, previously dissolved in water, 190 grains. Bath at this point should be neutral. Acidify till the blue litmus reaction is decided, and with citric acid make up bath to 40 ounces. Float paper on above bath 3 minutes, dry and float on 80-grain silver bath. This paper fumed 25 minutes will print black, and toned with chloroplatinite of potassium will give engraving black prints of beautiful brilliancy. The sensitized paper is fairly durable.—The Photo-American.

Frequently we see articles on pin holes and spotting mediums. I avoid both by using only the best brands of plates. Cheap plates are cheap in every sense and produce more pin holes than pictures. Dust the plate lightly before putting it in the holder. After exposure, put in a tray of cold water 2 or 3 minutes and then mop well with a tuft of wet absorbent cotton. I do not average one pin hole to 2 dozen 5 x 7 plates since following this method.

T. H. Wade, Helena, Mont.

Please give through RECREATION a formula for developer that will make a dense negative. Will it give better results than any on the market?

Geo. H. Bortz, Sebring, Ohio.

ANSWER.

All makers give such a formula for their individual plates. Use Carbutt B 10 plates and the developer recommended and the results will be all that can be desired.—EDITOR.

I thank those of your correspondents who wrote me direct in reply to my letter in December RECREATION on the subject of cyco paper. I started to answer them, but they came so fast it was practically impossible to answer all. Some of the writers advised me to use argo paper and I shall try it later.

J. E. BATES, Spokane, Wash.

During the past year I have taken regularly 3 sportsmen's periodicals, with occasionally a fourth. I have decided that for this year I shall take but one and of course I have picked out the one I consider the best; it is also incidentally the cheapest, namely, RECREATION.

J. W. Steward, Battle Creek, Mich.

If it isn't an Eastman, it isn't a Kodak.

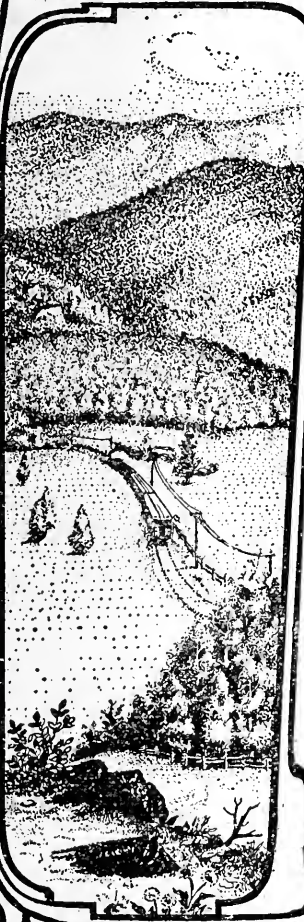

THE KODAK GIRL

A vacation without a
Kodak
 is a vacation wasted

No matter where you go or what your hobby may be, Kodakery will add to the pleasure of your trip. Anybody can make good pictures by the Kodak system. It's all by daylight, now that the Kodak Developing Machine has abolished the Dark-Room.

Kodaks, \$5.00 to \$75.00.

Kodak Developing Machines, \$2.00 to \$10.00.

Catalogues free at the dealers or by mail.

Kodak Portfolio, containing 40 prize pictures from \$4,000 Kodak competition, ten cents.

EASTMAN KODAK CO.

Rochester, N. Y.

OBJECTS WELL CENTERED AND CORRECTLY FOCUSED

The Focusing Weno



Hawk-Eye

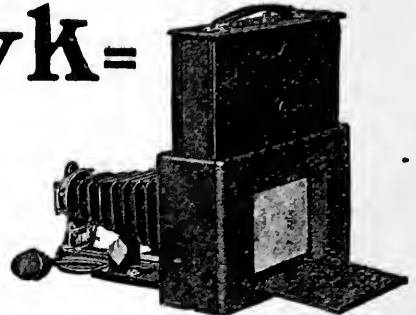

has the advantage
over all cameras

of a ground glass the size of picture, which works automatically and allows focusing when using film. The result is obvious—perfection of work—satisfaction to the user.

No. 3 Focusing Weno Hawk-Eye, with B. & L. Automatic Shutter, and Extra Rapid Rectilinear Lens. Pictures $3\frac{1}{4} \times 4\frac{1}{4}$, " - - - \$27.50

No. 4 Focusing Weno Hawk-Eye, same equipment. Pictures 4×5 , 30.00

Hawk-Eye Film can be developed in the Kodak Developing Machine.

Write for Hawk-Eye Booklet.

BLAIR CAMERA CO., Rochester, N. Y.

DO YOU WANT A LENS?

**If so, why not get a good one?
And why not get it free of charge?
This is easy.**

Any old box will answer the purpose if it does not leak light; but you must have a fine lens to make a fine picture. You can get

A Royal Anastigmat Lens, 4×5 , Series No. 1

Made by the Rochester Lens Co., Rochester, New York,

**And listed at \$45,
For 20 yearly subscrip-
tions to RECREATION**

You can get any other lens made by this Company on a basis of one subscription to \$2. of the list price of the lens.

Sample copies of RECREATION for use in soliciting furnished on application.

EXTRAORDINARY OFFER.

To any person sending me \$1 for a year's subscription to RECREATION, I will give free one of the following books: 6th and 7th Books of Moses. This is a great book. Every home should have one. Volumes I.-II., bound together in one volume; regular price is \$1. "The Almighty Dollar" is a new book just published, and is worth its weight in gold to any one. Can not be obtained for less than \$1 anywhere.

"Hunter's Guide and Trapper's Companion." This is a book every hunter and trapper should have. Descriptions of these books will be sent for a stamp. This is the greatest offer ever made, and you should not let this pass. Old subscribers may avail of this offer by sending 10 cents extra. Address Henry Nelson, Eckwoll, Minn.

The J. C. hand trap arrived O. K., and I can not perceive how it is possible for you to give such valuable premiums for so small a number of subscriptions. The trap works like a charm, throwing targets equally as well as a field trap, and to say that I am pleased with it is putting it mildly. F. Fellgraff, Jersey City, N. J.

Do You Want a Drinking Cup Free?

Send me \$1 for a new subscription to RECREATION and I will send you a fine nickel-plated folding drinking cup. For 10 cents extra will send by registered mail. Mrs. Thomas H. Walker, 205 Merrimac Street, Manchester, N. H.

Premo Film Pack,
daylight loading (twelve
exposures) and

Premo Film Camera
takes pictures $3\frac{1}{4} \times 4\frac{1}{4}$
List price, camera
complete, \$4.00.



Perfection

in

Film Photography

is realized in the **Premo Film Pack** and the **Premo Film Camera**. They are the latest and most notable advances in picture making excellence and picture taking convenience. Here is the story of Photography with the Film Pack: Open the door of the camera, put in the Film Pack; films are exposed one by one by simply pulling out and tearing off the numbered black paper tabs; the final exposure seals the package light tight. With the advent of the Premo Film Pack

Premo Plate Cameras Also Become Daylight Loading Film Cameras

for it can be used with them. Always recognized as the highest type of plate cameras, **Premos** now become the ideal film cameras, possessing at once unequalled mechanical attainments, and the daylight loading film feature besides. With Film Pack and the Premo Plate Camera it is possible to focus between each exposure.

For more complete information in regard to the **Premo Film Pack** and **Premo Film Cameras**, see your dealer, or write for the new **Premo Year Book**.

ROCHESTER OPTICAL CO., Dept. F, Rochester, N. Y.

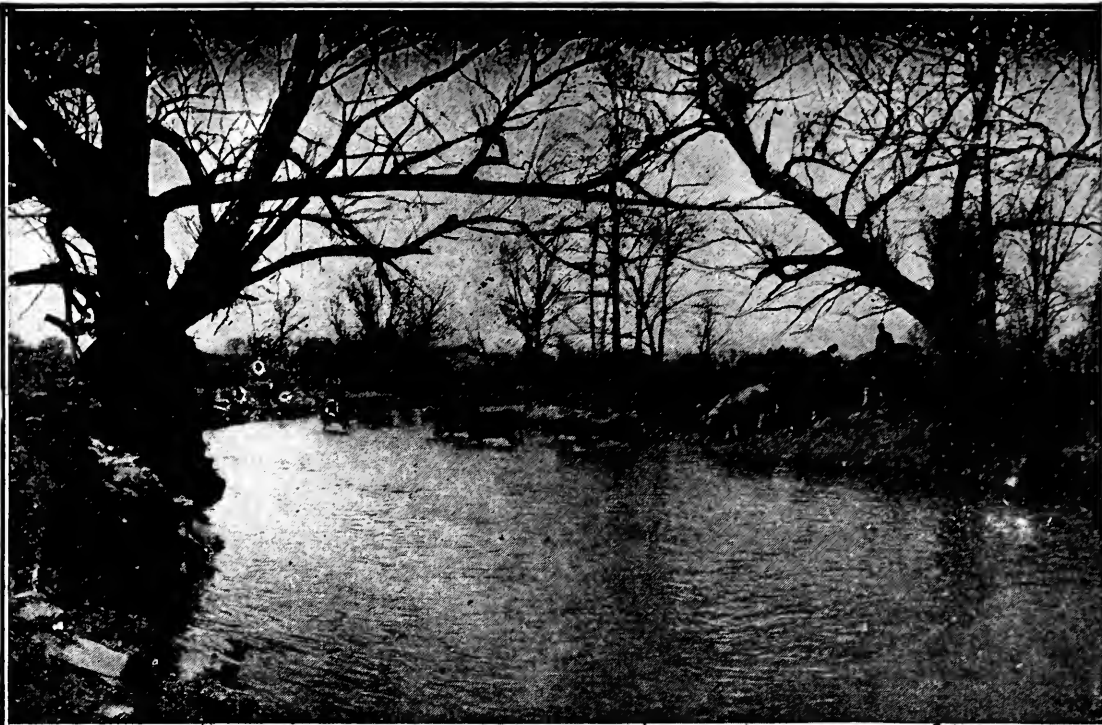

All in one picture, by the

take photos 4 x 5 or almost any size you wish. Some of our models combine the use of both films and plates. You can take a film picture 4 x 12 or a plate photograph 4 x 5, or 5 x 7, as you wish. With no other camera can you do this.

In every city in the country there are amateurs and professionals who are enthusiastic about these

Al-Vista Cameras.

If you will write us we will give you the names of persons who are using the Al-Vista, and who like it.

Of course it is impossible to tell you much about our Camera in this announcement. We want you to write us, and we will mail full information.

Multiscope & Film Co.

136 Jefferson St., Burlington, Wis.



Al-Vista Camera, or you can

A most valuable feature of the Al Vista is the simplicity of operation. There is nothing complicated about the Camera—nothing likely to get out of order. The lens used is of extra quality, the best we can secure. It is universal focus, so that no time is required in focussing.

Our Co-operative Plan

We are sending out now a large number of cameras on this Co-operative Plan. A small first payment being made, we ship you the camera, and you can use it while you pay the remainder in monthly installments. This plan appeals to a great many people and certainly shows our confidence in the quality of our goods. Write us for full information about it.

Multiscope & Film Co.

136 Jefferson St., Burlington, Wis.

STILL ANOTHER GREAT OFFER

Send me 25 yearly subscriptions to RECREATION and I will send you

A Grade 00 Syracuse Gun

Listed at \$30.

I have contracted for 20 of these guns at a price which enables me to offer them as above, and they will doubtless all be taken within the next three months.

If you want one of the Guns get a move on you

Sample copies of RECREATION for use in canvassing furnished on application

RECREATION, 23 W. 24th Street, New York

YOUR VACATION

Will not be completely enjoyable
without the companionship of a

Modern Binocular

But *don't buy* unless you get the
Very Best Obtainable

And when you're looking for the
best, please bear in mind that the

Turner=Reich Field Glass

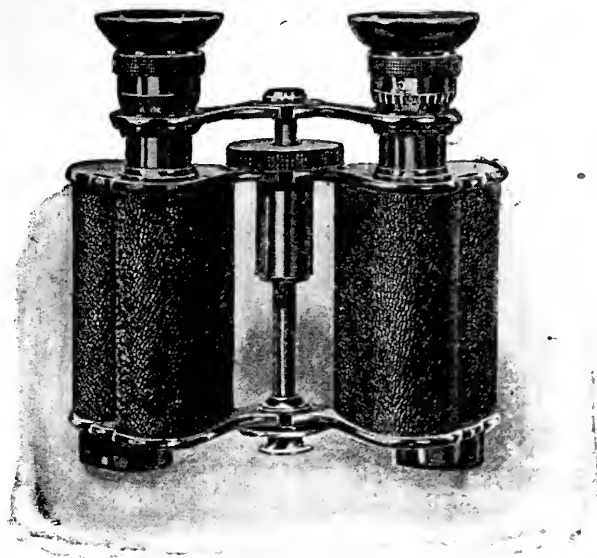

is backed by our **GUARANTEE** of **OPTICAL PERFECTION**

This **GUARANTEE**, in turn, is backed by **NINETEEN YEARS'** study of **OPTICAL**
and **MECHANICAL** theory, and by **NINETEEN YEARS'** **EXPERI-**
ENCE in putting **THEORY** into **PRACTICE**.

Write for Price List. It tells about the wonderful *defining* and *magnifying* power, and the
unprecedentedly large field of the **TURNER-REICH BINOCULAR**.

GUNDLACH=MANHATTAN OPTICAL CO.

730 So. Clinton Ave.

ROCHESTER, N. Y.

The Rocky Mountain Goat

Is a shy, wary animal that ranges
8,000 to 15,000 feet
above sea level

and has rarely been photographed.
Mr. A. M. Collins, one of **RECREATION's** prize winning photographers,
has recently made 4 of the finest
goat pictures ever produced. I
HAVE had enlargements made from
these, 13 x 15 inches, and will sell
them

At \$5.00 a Set.

A rare and valuable group for
sportsmen, amateur photographers
and nature students. Address

**RECREATION, 23 WEST 24th ST.
NEW YORK CITY**

Something New!

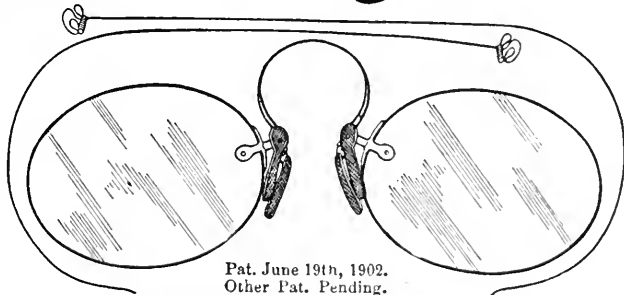

Pat. June 19th, 1902.
Other Pat. Pending.

PRESTO! CHANGE! **Attachable Eyeglass Temples**

Every wearer of eyeglasses wishes occasionally that they
were spectacles. Spectacles stay on, however violent one's
exercise, however warm or stormy the weather. This little
device can be readily attached or detached without injury to
the lenses, thus in a second giving you the choice of either
spectacle or eyeglass. Just the thing for outdoor sports.
The Temple Attachment will fit any of your eyeglasses and
can be carried in the same case with them.

Send thickness of lens when ordering by mail.

Price in Nickel, 50 cents a pair

Price in Gilt, 75 cents a pair.

Send for Circular.

Our illustrated catalogue can be had for the asking

We carry everything in the Optical and Photographic line
Eyeglasses, Spectacles, Cameras, Opera, Field or Marine
Glasses, Thermometers, Barometers, Telescopes, Hygrom-
eters, Sun-dials, etc.

GALL & LEMBKE, Department C.

1 W. 42d Street

21 Union Sq., New York

Established 1842.

ANOTHER GREAT OFFER TO AMATEUR PHOTOGRAPHERS

A 4 X 5 SERIES 1 KORONA CAMERA
LISTED AT \$12, FOR 8 YEARLY SUBSCRIPTIONS TO *RECREATION*;

A 5 X 7 SERIES 1 KORONA CAMERA
LISTED AT \$16, FOR 12 YEARLY SUBSCRIPTIONS;

A 4 X 5 SERIES 2 KORONA CAMERA
LISTED AT \$18, FOR 14 YEARLY SUBSCRIPTIONS;

A 4 X 5 SERIES 3 KORONA CAMERA
LISTED AT \$22, FOR 18 YEARLY SUBSCRIPTIONS;

A 4 X 5 SERIES 4 KORONA CAMERA
LISTED AT \$25, FOR 20 YEARLY SUBSCRIPTIONS;

A 4 X 5 SERIES 5 KORONA CAMERA
LISTED AT \$35, FOR 30 YEARLY SUBSCRIPTIONS.

*SAMPLE COPIES, FOR USE IN CANVASSING,
FURNISHED FREE.*

A D D R E S S

R E C R E A T I O N

23 WEST 24TH STREET, NEW YORK CITY

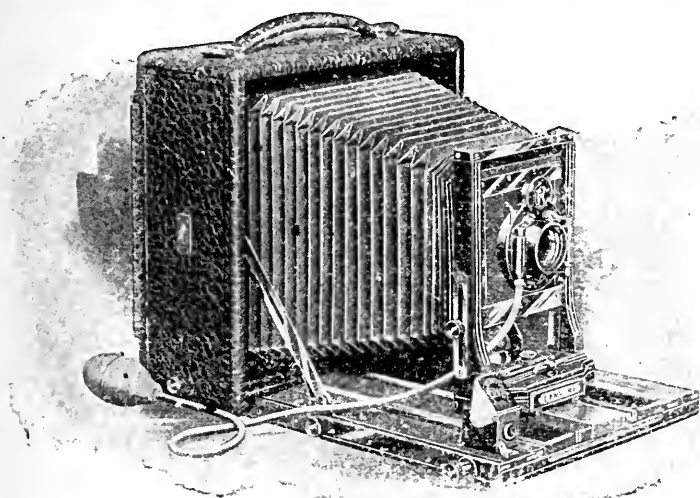

“If I had at command any other words that stood for more than these — *absolute perfection* — I would use them to convey my opinion of the Century Camera received to-day.”

“Century” Cameras

Are the recognized standard cameras of America. Our 1903 Catalogue tells all about them — how they differ from others, and why “Centurys” are so superior in quality. Get a copy from your dealer or write us, and don't overlook the “Century Guarantee.” That tells our story in a nut shell.

CENTURY CAMERA CO.,

MAKERS OF THE FINEST CAMERAS
IN THE WORLD.

ROCHESTER, N. Y.

Do You Want a Gun?

Send me 30 yearly subscriptions to
RECREATION and I will send you a

No. 1 Double Barrel Breech Loading Gun

Made by the Ithaca Gun Co.
and Listed at \$40

I have contracted for 20 of these
guns at a price which enables me to
offer them as above, and they will
doubtless all be taken within the next
3 months.

If You Want One Get Busy at Once

Sample copies of RECREATION for
use in canvassing furnished on application

RECREATION, 23 West 24th St., New York.

C A M E R A S

Néwest Models Best Makes
Factory Prices

G. E. GRAHN, Manufacturers' Agent
1247 Cornell Ave., Indianapolis, Ind.

**LANTERN SLIDES COLORED
SKILLFULLY AND ARTISTICALLY**

F. C. R.

Lecturers, Teachers and others

I refer by permission to the Editor of RECREATION.

MRS. C. B. SMITH
606 W. 115th Street, New York City

Our game consists of grouse, which are scarce, rabbits in goodly number, and ducks. The latter we have only during the migrating periods. None nest here, though they undoubtedly would if spring shooting were abolished. The game laws are loosely observed.

I should like advice on the selection of a light draft canvas, wood or metal canoe for cruising in creeks and rivers. Should especially like to hear about the covered, double paddle canoe.

Grizzly, Anaconda, Mont.

Free ; For 1 year's subscription of RECREATION, through me, will give 1 Bromide enlargement, any size up to 11 x 14 inches, inclusive, from any negative not larger than 4 x 5; or from photographs. Negatives and Photos are to be returned to the owner. Here is a rare chance to get a large Photo from your pet Negative, also RECREATION for \$1. A. F. Evarts, Meriden, Conn.

White Mountain Views Free

To any person sending me a subscription to RECREATION accompanied by \$1. I will send two mounted photos, on velox paper taken among the White Mountains, size 6x8; one shows Mt. Washington snow capped. To any one sending 2 subscriptions with \$2 I will send a souvenir of the White Mountains, size 4½ x 5½ containing seven photos. Send P. O. Money Order.

M. E. TUTTLE, Box 337 Dover, N. H.

OIL PORTRAITS ON APPROVAL.

If you will send me a photo of yourself or a friend and state color of hair, eyes and complexion I will paint and send you on approval a miniature oil or pastel portrait.

Canvas 6x8 or 8x10 inches, \$10 00

Canvas 10x12 or 12x14 inches, \$15 00

Z. EMMONS, 58 West 104th St., New York.

Reference: Mr. G. O. Shields.

Sold Round the World
on all Cameras

Catalogue Free

Bausch & Lomb
Lenses & Shutters

Rochester, N. Y.

NEW YORK. BOSTON. CHICAGO.

TO
GET
THE
PICTURE
YOU
WANT

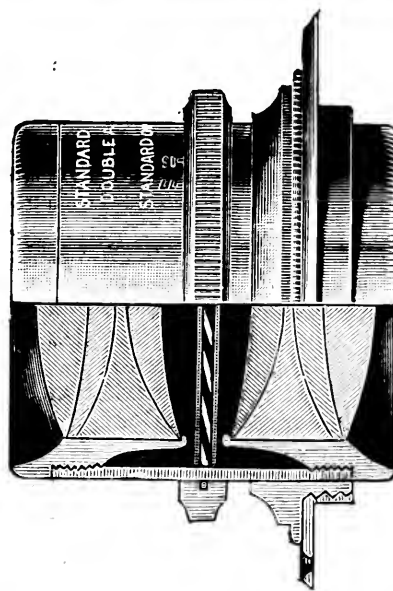

you must have a good lens. The lens that makes good pictures, the kind you want, is the

Standard Double Anastigmat

F/6.8

4 x 5 in., \$25.00 5 x 7 in., \$32.00
Up to 11 x 14 in.

Get one on ten days' trial and compare it with any other lens made. YOU'LL BUY OURS.

The Standard Optical Co.

227-231 Mulberry St., Newark, N. J.

R. S. A. P.

Ready Sensitized Albumen Paper

The only paper that has stood the test of a lifetime in photography.

PICTURES THAT LAST FOREVER

May now be had in any size, in glossy or matte surface, thin smooth, heavy smooth and heavy rough.

We are using paper to-day sensitized six months ago.

Prices and a very generous special offer to those who answer this ad.

The Matte Albumen Co.

156 FIFTH AVENUE, NEW YORK

Free: If you send your subscription to RECREATION through me or direct to the office to be placed to my credit, I will send you free of charge, any one of the articles mentioned below:

Shot gun bench crimper, sells for 75 cents, in 10-12 16-20 gauge.

Shot gun cleaning rod, three attachments, sells for 50 cents, in 10-12-16 gauge.

Micrometer powder and shot measure, adjustable, and for both black and smokeless powder, sells for 65 cents.

U. S. Government rifle cleaner, any caliber, with attachments, sells for 60 cents, packed in neat canvas bag.

A duck, snipe or turkey call, sells for 75 cents each, best made.

A hand painted sporting picture, suitable for framing and just the thing for your den, worth \$1.50.

"Hunting in the Great West," by G. O. Shields. H. S. Hill, 815 11th Street, N. E., Washington, D. C.

Another Good Offer: To the first person sending me five subscriptions to RECREATION and five dollars, before April 1st, I will give a 2 by 3½ printing press, and type to go with it. To any person sending me two subscriptions and two dollars I will give a silver-plated napkin ring. To any person sending one subscription, I will give a sterling silver ring. All persons sending me one subscription, please send finger measurement. A. J. Brodhead, 42 Sayre St., Elizabeth, N. J.



My Brother on the opposite page makes all my negatives for me on ANSCO, the new DAYLIGHT loading film

You Ought to Try Them

They have Better Keeping Qualities and Greater Latitude than others.

If your dealer can not supply you, send to THE GENERAL AGENTS.

The Anthony and Scovill Co.

122-124 Fifth Ave.
New York

Atlas Block
Chicago



My Brother over there says there is nothing like **CYKO** when you want beautiful prints.

You can print it **ANYTIME** by **ANY LIGHT** and **ANY WHERE**.

*Six Different Grades Adapted to
All Sorts of Negatives.*

Send twenty cents and get a dozen 4 x 5 with Developer and Manual.

The Anthony and Scovill Co.

122-124 Fifth Ave. Atlas Block
New York Chicago

ROTOX

PRINTS IN ANY LIGHT!



From daylight to candle-light you are sure of twelve perfect prints from each dozen sheets.

PRICES:

4 x 5, 15c. doz. 6½ x 8½, 55c. doz.
5 x 7, 30c. " 8 x 10, 70c. "

If you want the best bromide paper, buy "Rotograph."

Sample copy of the Photo Critic, containing every month articles on "The A to Z of Photography." Of interest to amateur and professional. Sent on request.

Subscription \$1 per year. Write

ROTOGRAPH

Dept. V 101 Fifth Avenue, - N. Y. CITY

To Amateur Photographers

Here is a Chance to Get a
FINE CAMERA EASILY

A 4x5 Tourist Hawk-eye film camera listing at \$8, for 5 yearly subscriptions to RECREATION. A No. 3 folding Weno Hawk-eye film camera, listed at \$15, for 10 yearly subscriptions to RECREATION.

These are both neat, compact, well made and handsomely finished cameras, capable of doing high-class work. Only a limited number can be supplied on this offer, and same may be withdrawn at any time without notice when the present stock is exhausted.

Sample copies for use in canvassing furnished on application.

Address **RECREATION,**
23 West 24th St. New York City.

WHY PEACEFUL VALLEY LEFT HOME.

TIMOTHY.

In the summer of 1900 Mr. Edward Sterling decided to spend his vacation at a quiet place in Michigan, called Hamlin lake, about 5 miles from Ludington. After a short steamer ride from Chicago, he arrived safe at his destination.

A few guests had already arrived, and more were being added every day or 2; some experts in landing the gamy bass, and others willing to be if they could get a chance. Among the June arrivals were Mr. and Mrs. Swain, from Chicago, and Mr. John McB., of Milwaukee, who had been there before. Mac was a jolly companion, full of enthusiasm, satisfied to catch anything that came along, whether it was a perch, a black bass, or a dogfish, and always ready with a good story. Swain wanted to fish most of the time, and being successful, as a rule, was on the go early and late. His choice was black bass. Sterling's great enjoyment was in taking long tramps through the woods. Being long and lanky, he could get over much ground in a few hours. On account of Sterling's striking resemblance to Sol Smith Russell, Mac named him "Peaceful Valley," which was taken up by everyone at the lake.

Fishing was the great ambition of most of the people who went to Hamlin lake, and there being plenty of fish, all it required was a little dexterity. While Peaceful Valley was totally indifferent as an angler, and could scarcely tell a wall-eyed pike from a sunfish, he would sit by the hour and listen to others relate their experiences, with keen enjoyment. He had no objection to rowing a boat when he was needed, and one fine morning he accepted Swain's invitation to go with him. In a short time they pulled into one of the favorite spots for the sportive bass. Swain, in the language of Shakespeare, "knew where he was at." His outfit was of the best; steel rod, first class reel, etc. With Peaceful Valley's long arms to pull the oars, Swain could see a day of pleasure and a big time in sight. His long suit was casting out among the lily pads near shore, and then reeling in quietly and easily. He had practiced this till he had it pat, and when all went right he seldom failed to land his victim. It is a fact not to be overlooked that along with his enthusiasm was an impatience at times bordering on rage when anything went wrong. At such stages of the game he would sometimes express his feelings so forcibly that everything in sight would take to the woods or to deep water. Fish have been known to run ashore and climb trees on these occasions.

Peaceful had never witnessed any of these outbreaks. Swain's orders were to keep quiet and talk low, but for some rea-

son Peaceful forgot these suggestions. Noticing a large fish, he made a dash for the lily pads, become excited and bawled out, "There he goes! Great Scott! Go for him quick!"

This was accompanied by furious splashing of the oars to bring the boat in position; and the remarks that this effort brought forth from Swain nearly blew up the lake. Peaceful Valley coolly wiped his eyeglasses, and began to shape himself for another effort, but Swain shrieked,

"Stop your infernal racket! Haven't you any sense? Where were you brought up; in a boiler shop? Why don't you go out on a farm and flail wheat?"

When Peaceful recovered from the shock he suggested that Swain do his own rowing, or get someone in his place. Swain responded that he would be glad to do so, if Peaceful would go ashore and lie down in the shade of the pines.

That night when the boat returned to the hotel it was occupied by a solitary fisherman, and the anxious watchers at the dock wondered what had become of Peaceful Valley. They did not apprehend that he had drowned, for they knew that should he fall overboard he could walk ashore from almost any point in the lake; but possibly he might have attempted to rob an eagle's nest, and had his eyes pecked out, and be wandering hopelessly about in his endeavors to reach the hotel.

When Swain pulled up to the landing, he was downcast and blue, and could only produce a solitary bass. In answer to inquiries about Peaceful Valley he said he didn't know where he was, and cared less. When Mac saw the lonely 2-pound bass, he put on a broad smile and said,

"Never mind, old boy, that'll help some."

In the meantime our friend Peaceful had quietly walked home through the woods, entered the back door and slipped upstairs to his room. Half an hour later he appeared in a clean collar and one of his sweetest smiles. At the supper table he was so full of good humor and wit that it became infectious to all, including Swain himself. The dove of peace settled down once more and everybody was happy.

It was often noticed that when Peaceful Valley became tired of the surroundings, or the fish stories were spread on a little too thick, a far away look would come over his countenance, and he would strike out for a walk over to Epworth, about 4 miles distant, where a summer colony of school-ma'ams made merry with life. He always returned with a sunny smile, and it was evident that time did not drag, even for a confirmed bachelor, with Epworth only 4 miles away. When he finally left for home he was a changed man. Returning health had brought back his old-time buoyancy and the Epworth tours had awakened new life in his breast. Some time we may hear why he left home.

Wake up!



Size Up

The next millionaire or successful professional or business man you meet and see if you think he has any cobwebs on his thinking apparatus. Then find out something about his diet, and see if you can discover any connection between the two.

Chances are you'll find he uses the food GRAPE-NUTS which is rich in Albumen and Phosphate of Potash (the food elements that restore wasted gray matter in the brain.) GRAPE-NUTS food also fits his stomach, no matter how weak from overwork or sickness that delicate organ may be, for in this famous food the process that predigests it (transforming all the starches into grape sugar) takes away none of the blood and strength building elements of the *whole* grains.

If you are half sick, and don't earn money, WAKE UP. The fault is a poorly fed brain that simply cannot work successfully, for it don't get the right kind of material from food.

On the outside of each package of GRAPE-NUTS you will find a short explanation of the fundamental theory of dietetics.

Read it!

Inside the package you'll find the theory demonstrated in the form of crisp, nut-like, little golden grains that can be used in a great variety of delicious ways in puddings, pies, salads, etc., or plain, with cream, just as they come from the package.

Try it!

You are a reader, therefore a thinker—here is

The Food for Thought

Sent on Approval

TO RESPONSIBLE PEOPLE

Laughlin

Fountain Pen

Guaranteed Finest
Grade 14k.
SOLID GOLD PEN.

To test the merits of

RECREATION

as an advertising medium we make this grand special offer, your choice of

These
Two
Popular
Styles
For Only **\$1.00**
Postpaid
to any
Address

(By Registered mail 8 cents extra)

Holder is made of finest quality hard rubber, in four simple parts, fitted with very highest grade, large size 14k, gold pen, any flexibility desired—in feeding device perfect.

Either Style—**RICHLY GOLD MOUNTED** for presentation purposes, \$1.00 extra.

Grand Special Offer

You may try the pen a week; if you do not find it as represented, fully as fine a value as you can secure for three times the price in any other makes, if not satisfactory in every respect, return it and we will promptly refund your money.

Illustration on left is full size of Ladies' style; on right, Gentlemen's style. **Lay this RECREATION Down and Write NOW.**

Safety Pocket Pen Holder sent free of charge with each Pen.

ADDRESS :

Laughlin Mfg. Co.

424 Griswold St., DETROIT, MICH.

The Buffalo Is Well Nigh Extinct

And every nature lover wants a relic of him. Here is a chance to get it:

I have in stock a limited number of buffalo horns, highly polished and fitted with nickel plated flanges at the base, so that they can be screwed on the wall, thus forming

A Novel and Effective Gun Rack

So long as the supply lasts I will give a pair of these horns for

3 Yearly Subscriptions to RECREATION

Sample copies for use in canvassing furnished on request. Address

Recreation, 23 W. 24th St., New York

A CASE OF BUCK FEVER.

One day last fall a party of 7 took horse and rode to Mt. Bonaparte for a deer hunt. On getting into heavy timber they thought best to leave their horses, so tied them to some small trees. Then they took to the hills on foot, and, separating, each took a course of his own.

Presently one of the men, coming over the top of a ridge, saw through the thick underbrush, 200 yards or more away, what he thought was a deer, rubbing its head on a small tree. He raised his rifle and fired, but the supposed deer did not move. On taking a second look, the man saw it was a horse. He went down to ascertain the effect of his shot, and found he had missed the gray horse he shot at, but had killed a black horse standing near. The animal lay stone dead with a bullet through its heart. That ended the hunt that day.

The unlucky would-be deer stalked decided to walk home and leave his horse for the owner of the ill fated nag he had killed. He had a 6 mile tramp through the deep snow to get home.

F. A. S., Chesaw, Wash.

The Harrington & Richardson shot gun and revolver you sent me as premiums came to hand. They are A No. 1. I am much pleased with them.

P. B. Knapp, Sharon, Pa.

"Makes Life Happier, More Productive."

You Should Know

ORANGEINE

POWDERS

Because

Orangeine promptly **corrects all pain**, fatigue and the "little ills that lead to serious ailments."

Because

Orangeine **cures** Headache, Colds, Neuralgia, Indigestion and a host of common ills.

Because

Orangeine is a positive "Tissue Builder" and Tonic to the system. **"Acts while you take."**

The Best Indorsed Because Most Useful Prescription.

NOTE—Our direction booklet in every package gives full simple directions from countless successes and describes the composition of Orangeine Powders. Our mail is a delightful panorama of human attest from all over the globe and from every human age and condition.

To Illustrate We Select The Following:

Foreign Appreciation of Orangeine.

The following cable order for \$1800 worth of Orangeine, from a big London distributor, illustrates the London demand:

"London, Apr. 3rd, 1903. Rush 35 gross quarters; ten gross 50's; five gross dollar. GARRATT." LADY DOROTHY STANLEY, in 1893 said: "Orangeine acts like magic."

In March, 1903, she writes: "I am glad Orangeine can be bought here, as I have had to send to America for it. There is nothing like it for headache and nervous fatigue."

Chevalier J. P. SPANIER writes from Rome, Italy:

"Please send me by mail, registered, as usual, with bill, 300 powders of Orangeine. I would not get along without them. Also send the same to Sir John Tyler, Portland Place, London, whose card I enclose. Sir John generally disapproves of patent remedies, but expresses absolute belief in Orangeine. He is one of the greatest physicians in London, and attends royalty."

MR. JAS. R. WALKER, a prominent resident of Chicago, now in Europe, writes from Berlin:

"I have always appreciated Orangeine, but did not fully realize how important it was for the health and comfort of my family and myself, until I was no longer able to buy it. Please send me 12 dollar packages."

Colds and Grip.

Thousands describe the promptness of Orangeine to Prevent—Heal—Dispel after effects.

Saves Time and Suffering.

MR. RALPH McNEIL, 103 West 42nd St., New York City, writes: "I am foreman in a large factory, employing many girls. I find Orangeine very useful, to correct their small ills, and keep them at work. Have so used it for months."

Trial Package Free

Orangeine is sold by druggists everywhere in 25c, 50c and \$1.00 packages. On receipt of 2c postage we will mail 10c trial package FREE with full directions, composition and description of its wide human influence. Orangeine Chemical Co. 15 Michigan Av. Chicago.

Now About Hay Fever.

Our motto for Hay Fever sufferers, "Stay at Home. Go Anywhere" has been appreciated, during the past five years, by thousands of liberated mortals, who have taken Orangeine under our simple directions, beginning two or three weeks before the expected attack.

Specimen Experiences.

MR. W. K. SEAGO, of the great firm of W. K. Seago & Co., New Orleans, writes: "For 15 years, Hay Fever drove me to the mountains or lake resorts. During the past season, by the aid of Orangeine, I remained at home, with greater comfort and relief than any Hay Fever resort ever afforded. What more can I say?"

MR. W. M. HUGHES, a prominent Banker of Newport, R. I., writes: "My first experience with Orangeine Powders was in connection with Hay Fever, which troubled me many years. I am frank to say, Orangeine has accomplished an entire cure."

Nervous Prostration and Melancholia.

MR. WALTER H. BRADLEY, writes from Kallispell, Montana: "Please send me \$10.00 worth of Orangeine, which I use and distribute to friends wherever possible. About two years ago I bought \$2.00 worth of Orangeine, while residing in Michigan, where I was ill with Nervous Prostration. I treated with the best physicians in the state but got no relief until I began to use Orangeine."

MRS. E. B. COLLINS, of Carson City, Mich., whose experience has literally established Orangeine in her community wrote the other day: "We cannot keep house without Orangeine."

HEADACHE.

Nervousness, Fatigue. MRS. PAUL KENNICOTT, Wood Lake, Neb., writes: "Orangeine has become a regular time saver for me, nipping in the bud what used to be all day and all night headaches."

MRS. MILLIE NORRIS writes from Jamestown, New York: "I can not extol Orangeine enough—it has almost entirely cured me of the worst sick headaches any one ever suffered."

MISS HELEN BERTRAM, the popular American song bird, described the peculiar action of Orangeine when she said: "I find Orangeine a perfect remedy for headache and a tonic for the voice and nerves."

Nervous Dyspepsia.

Major J. A. OLMSTED, U. S. A., Commandant Iowa State Normal School, Cedar Falls, Iowa, writes: "I have long suffered from an obstinate case of Nervous Dyspepsia. Orangeine is doing me great good, and I look for ultimate recovery. It is the only medicine I have ever found that helped me and there is no reactive effect from it."

Its Wide Range.

DR. C. L. LAWRENCE of Oakland, Cal., recently telegraphed for \$10.00 worth of Orangeine, and later wrote as follows: "I am using about \$5.00 worth of Orangeine per month with the best of satisfaction to myself and patients. I have used Orangeine during the past 2 years in a hundred different ways, always with the same result of relief, and have yet to find any detrimental after effects. Among other applications I have had many cases of Measles, Neuralgia and even Hepatic Cholice."

DR. EDGAR C. BEALL writes from New York: "Orangeine by its results compels my respect more than any drug or combination of drugs I have ever known."

MISS CELLAH WATERHOUSE, Wausau, Wis., writes: "My father is using Orangeine successfully for Asthma."



Don't wait until your wife or servants **Cut Their Hands**

BUY A

Yankee Cork Puller

An up and down motion of the handle draws the tightest cork and automatically discharges it. No effort. No trouble. No broken bits of cork left in the bottle. Never slips. Lasts a lifetime. Fastens to sideboard, door-jamb or other upright surface. Cannot get lost.

Ask the hardware dealer, or sent direct, express prepaid, on receipt of price.

BOOKLET FOR **Nickel Plated - \$1.25**
 THE ASKING. **Silver - 3.50**

After 30 days' trial money cheerfully refunded if not pleased

THE GILCHRIST CO

125 Lafayette St. Newark, N. J.

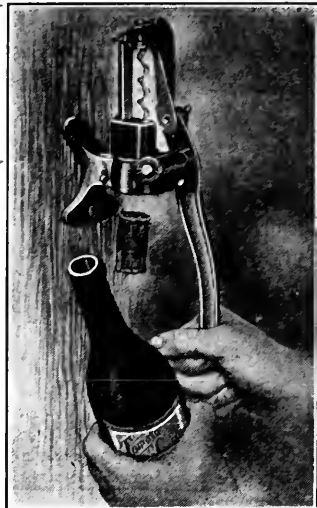

Save Your Cigar Money

And Get *A Better Smoke*

ORTON'S "Always Clean" PIPE

(Patented)

A Half Turn of the Mouthpiece closes draught in bowl and opens port under bowl, and a Blow Cleans it.

Can be Cleaned Instantly While Smoking

No Broom
 Straws
 Required



No poisonous nicotine can reach the mouth. The bowl always dry. No waste. Made of genuine French Briar, German silver tubing. By mail, \$1.00 postpaid. If not satisfactory, money cheerfully returned.

Orton's "Always Clean" Pipe Co.

907 Broadway, New York



Trade
 Mark

Free: To anyone sending, through me, \$1 for yearly subscription to RECREATION, I will send free a No. 1 Sportsman's Medicine Case; for 2 subscriptions a Physician's Pocket Medicine Case; for 10 subscriptions 1,200 12-gauge primed paper shot shells. This offer is not open to old subscribers who formerly have sent in their subscriptions to the office of RECREATION, but to all others.

Walter Luson, Ardmore, Pa.

I am a constant reader of your magazine and take lots of interest in its various departments. My ideal weapon for field, marsh, lake or trap is the Parker, 12 gauge. I have owned 2 of their No. 12 guns and one No. 16, and think them as near perfection as any one could well wish. The company displays good judgment by keeping a constant ad in RECREATION. I learn that the Parker people are now prepared to furnish automatic ejectors on their higher grades. For 35 years they have kept pace with the most skilled gunsmiths, both foreign and domestic, until now the new improved, interchangeable Parker automatic hammerless stands alone as the best all around gun on earth. I am constantly experimenting with all the various powders, and consider DuPont smokeless, for shot guns, peerless. It is clean, quick, safe; keeping qualities unsurpassed; it leaves little to be desired in the line of a sporting powder.

Len I. Whittemore, Redlands, Cal.

The Marble axe arrived safely and is a beauty. I shall take it in camp with me next week.

L. P. Franklin, Hallock, Minn.

No. 58

HERE IS A KNIFE Men Love So Much They Hate to Throw an Old Handle Away

It Was Teddy's Camp Knife!

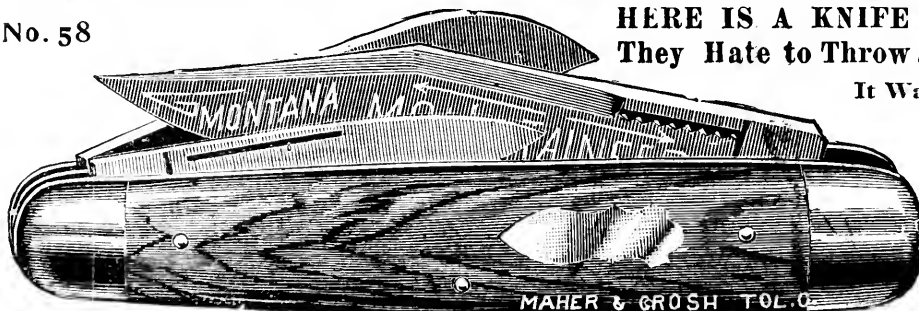

MAHER & GROSH TOL. O.

No. 58. Cut is exact size; ebony handle, 3 blades, German Silver ends. The long blade is for rough or fine work; the medium blade is as thin as a razor. Price, postpaid \$1.66 for \$5

Our JACK KNIFE

sells at 75c.; our special price is 48c., postpaid, 5 for \$2. All our blades file tested; warranted; replaced free if soft or flaky. Barbers' hollow ground **Razor and Strop** to suit, \$1.33. Send for free 80 page list and "How to Use a Razor."

48c.

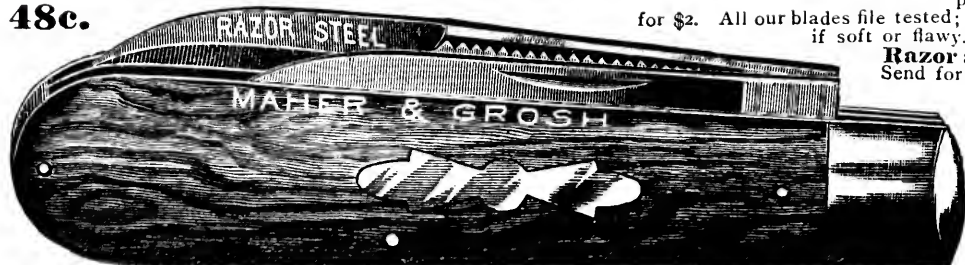

Maher & Grosh Co.

74 A Street

Toledo Ohio

Water is Free!

But it won't take the pain out of a burn; it won't heal a wound; it won't take the ache out of rheumatism, neuralgia, etc. Pond's Extract *will*. It will do it instantly. The claim that ordinary witch hazel is "just as good" or "just the same" as Pond's Extract needs but a mite of consideration to prove its falsity. Ordinary witch hazel is nearly all water. That's why you can get so much for so little—because *water is free*.

Pond's Extract is the pure extract of *Hamamelis Virginica*—that's why it costs more; that's why it CURES. If you want water, get it at the pump—it's cheaper and safer. If you want relief from pain—*any* pain, insist on getting Pond's Extract. Always sold under original label. Sold everywhere.



VARICOCELE

Cured to Stay Cured

EVERY reader of this announcement who has Varicocele, is familiar with the reflex and associated diseases. (My booklet, "Spécial Diseases" is for free distribution to men seeking information.) The selection of a physician to administer the requisite treatment, involving such vital results, is the most important decision you may ever have to make. You cannot run the risk of failure, and you do not want to be made worse by the treatment. For ten years I have maintained a Home for the benefit of my patients. I have the only equipped institution in the world devoted exclusively to the treatment of Varicocele and associated diseases. A consultation and thorough examination will prove most satisfactory. I cannot go more into details in this announcement, but I will freely answer questions and give



complete information to any man who will

write me.

DELMER D. RICHARDSON, M.D., ^{SUITE 106} 119 Michigan Ave. CHICAGO

FREE BOOK, WEAK MEN



My illustrated nature book on losses varicocele, impotency, lame back, free sealed, by mail. Much valuable advice and describes the new DR. SANDEN HERCULEX ELECTRIC BELT. Worn nights. No drugs. Currents soothing. Used by women also for rheumatic pains, etc. 5,000 cures 1902 Established 30 years. Advice free.

DR. G. B. SANDEN,
1155 Broadway, N.Y.

The Best Offer Yet.—To any person who will subscribe to RECREATION for one year through me I will send free a small water color landscape, hand painted, suitable for framing; or a hand painted silk bookmark. For two subscriptions I will send a fine Mexican opal scarf pin worth ordinarily from \$1 to \$1.50.

Dot M. Harris, 308 Crawford Road,
Cleveland, Ohio.

Do you want a Good, Reliable,
Substantial, Well Made

Single Barrel Shot Gun

If so, send me

10 YEARLY SUBSCRIPTIONS

and I will send you such a
Gun as a premium

It is made by the DAVENPORT ARMS CO., and this means it is made of good material and that only good workmanship is put on it.

This is one of the many remarkable opportunities RECREATION is offering to men and boys to fit themselves out completely for shooting and fishing.

Sample Copies for Use in Canvassing
Furnished on Application.

Address

RECREATION

23 W. 24th St., New York City

IF YOU WOULD LIVE NEXT TO
NATURE, READ RECREATION.

MENNEN'S BORATED TALCUM TOILET POWDER

TRADE MARK

A Positive Relief For
PRICKLY HEAT, CHAFING, and SUNBURN, AND ALL AFFLICTIONS OF THE SKIN.

"A little higher in price, perhaps, than worthless substitutes, but a reason for it." Removes all odor of perspiration. Delightful after Shaving. Sold everywhere, or mailed on receipt of 25c. Get Mennen's (the original). Sample Free.

GERHARD BUDDEY CO., New York, N. Y.



H. J. TILLOTSON, M. D.
The Master Specialist of Chicago, who Cures Varicocele,
Hydrocele, and treats patients personally.
Established 1880.
 (COPYRIGHTED)

Varicocele Hydrocele

Cured to Stay Cured in 5 Days.
No Cutting or Pain. Guaranteed
Cure or Money Refunded.

VARICOCELE. Under my treatment this insidious disease rapidly disappears. Pain ceases almost instantly. The stagnant blood is driven from the dilated veins and all soreness and swelling subsides. Every indication of Varicocele vanishes and in its stead comes the pleasure of perfect health. Many ailments are reflex, originating from other diseases. For instance, innumerable blood and nervous diseases result from poisonous taints in the system. Varicocele and Hydrocele, if neglected will undermine physical strength, depress the mental faculties, derange the nervous system, and ultimately produce complicated results. In treating diseases of men I always cure the effect as well as the cause. I desire that every person afflicted with these or allied diseases write me so I can explain my method of cure, which is safe and permanent. My consultation will cost you nothing, and my charges for a perfect cure will be reasonable and not more than you will be willing to pay for the benefits conferred.

Certainty of Cure is what you want. I give a legal guaranty to cure or refund your money. What I have done for others I can do for you. I can cure you at home.

Correspondence Confidential. One personal visit at my office is preferred, but if it is impossible for you to call, write me your condition fully, and you will receive in plain envelope a scientific and honest opinion of your case, Free of charge. **My home treatment is successful.** My books and lectures mailed free upon application.

H. J. TILLOTSON, M. D., 140 Tillotson Bldg, 84 Dearborn St., CHICAGO

REMARKABLE OFFERS

To every person who will send RECREATION \$1 for 1 year's subscription to be placed to my credit I will give as a premium a choice of a Nickel Plated Match Safe, or a Gilt Metal Match Safe, or a Hard Rubber Water-Proof Match Safe, each listed at 40 cents; or a Nickel Dog Whistle and pocket drinking cup, listed at 50 cents; or a Nail Clipper, with file and Nail Clipper attached, listed at 40 cents; or a 25 yard Single Action Reel, listed at 40 cents; or a 25 yard Water Proof Silk Line, listed at 50 cents.

For 2 subscriptions a Hunting Knife, Stag Handle, Blade 5½ inches long, listed at \$1.

For 3 subscriptions a Patent Double Minnow Bucket, listed at \$2; or a 60 yard Multiplying Reel, listed at \$2; or a 3-piece Bamboo Rod, 7 or 9 feet long, listed at \$2; or a Heavy Silk Watch Fob, listed at \$1.50.

For 5 subscriptions a fancy striped Hammock, listed at \$3; or a Hunting Knife, listed at \$3; or a Tackle Box, listed at \$3.

For 9 subscriptions a field glass listed at \$6.

Only a limited number of subscriptions can be accepted on these offers.

E. W. Jacobs, Coshocton, Ohio.

For Exchange: Moose head, in good condition, for a Goerz field glass or some make of equal value, or a good hammerless gun. J. W. B., care of RECREATION.



Club Cocktails

Famous the world over for purity. They never vary. The secret of their perfect blend is that they are kept six months before being drawn off and bottled. Be sure you have them in your camp, on the yacht, and on your outing trips wherever you

go. They are ready and require no mixing. Simply pour over cracked ice.

For Sale by all Fancy Grocers and Dealers

G. F. HEUBLEIN & BRO.
 29 BROADWAY, N. Y. HARTFORD, CONN.



\$5.00 IS ALL YOU PAY FOR

Banner
(TRADE MARK)
Rubber
Coat

Weight $4\frac{3}{4}$ lbs.

Patent,
Absolutely Waterproof
A Gentleman's Rain Coat
STRONG AND SERVICEABLE.
Endorsed by many "RECREATION" readers.
"It is just what I want and is the only coat I ever found that would REALLY SHED RAIN."
Sent express paid anywhere in United States on receipt of \$5.00. Sizes, 36 to 46 inches.
Money returned if Coat does not suit.
Give chest measure over ordinary coat.

Mackintoshes and Rain Coats made to order
All best quality Rubber Goods

NORTHERN RUBBER CO.
Dept. P. ST. PAUL, MINN.

Here is Another!

If you will send me
30 Yearly Subscriptions
to
RECREATION
I will send you
A No. 10 Goerz Trieder-Binocular Field Glass
Listed at \$38.00

Every well-informed man knows the great power of this modern prismatic field glass. It is indispensable to every hunter, and is one of the latest and best on the market.

I have but a few of these instruments on hand and the offer will be withdrawn as soon as the supply is exhausted. Therefore, if you want one

START IMMEDIATELY.

Sample copies of RECREATION for use in canvassing furnished on application.



The "Victor" is the real talking machine; its sound is natural. Band playing, monologues, comic or religious songs, all are reproduced as clear as if the artist was present. When ordering, **get the latest styles**—we charge no more than others who offer you old styles. Get our full catalogue FREE.

E. L. Cuendet, 7 Barclay St., New York.

The Reason the LUTHER HAND-MADE GLOVE will not rip



Machine sewing cuts itself



Hand sewing cannot.



A Practical Hunting and Driving Glove

Made for practical, comfortable, durability. No Oil. No Odor. No Animal Glue. Practically seamless. Cannot Rip. Unaffected by moisture of any kind. If soiled, may be washed with soap and hot water, without injury. The Luther Fastener is adjustable, fits any wrist and cannot get out of order. Illustrated booklet, samples and self measurement rule on application.

If you prefer to buy through your dealer send us his name

No. 308 Driving Glove postpaid anywhere \$1.50, made to measure \$2.50,
No. 320 Gauntlet, " " 3

J. P. LUTHER GLOVE CO., 536 Pearl St., Berlin, Wis.





ARNICA
Tooth Soap
the International Dentifrice

Beautifies the teeth, hardens the gums, sweetens the breath. Preserves as well as beautifies the teeth. Comes in neat, handy metal boxes. No powder to scatter, no liquid to spill or to stain garments.

25 Cents
At all Druggists.
C. H. STRONG & CO., Proprietors,
Chicago, U. S. A.

I just returned from a trip to Dixie land after deer. Had poor success. The weather was too dry. It is a wonder Virginia does not protect deer better. We were in Surrey county, where there are lots of deer, but the residents kill them the year round. They also use dogs, but that, I think, is according to law. If so, that law should be repealed before the deer are exterminated. There are many squirrels and a few quails and turkeys near Clairemont, Va.

F. W. McKee, Fayette City, Pa.

Purchaser—So this is an improved typewriter?

Agent—Yes; if you don't know how to spell a word there is a key that will make a blot.—Philadelphia Record.

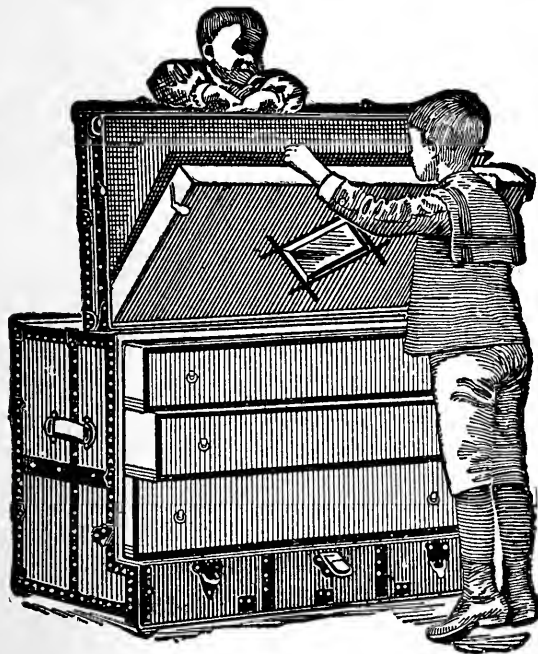

Stallman's Dresser Trunk

Have you seen one? It is up-to-date. Think of it, everything within reach. No heavy trays, but light, smooth drawers. Holds as much and costs no more than a good box trunk. Hand riveted, almost indestructible. Once tried, always recommended. Sent C. O. D., privilege examination.

ec. stamp for catalogue. Mention RECREATION.

F. A. STALLMAN,

87 W. Spring St.

Columbus, O.

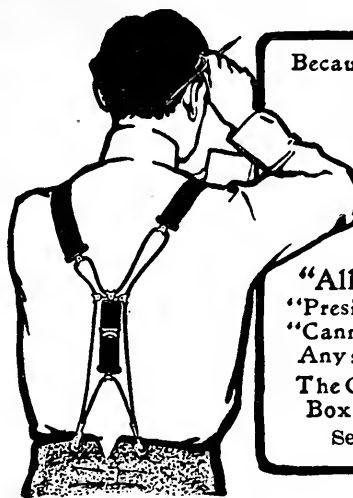

Because of their construction
President Suspenders
give most
Comfort & Service
Guaranteed

"All breaks made good"
"President" on buckle means
"Cannot trust" 50c. and \$1.00
Any shop or by mail prepaid
The C. A. Edgerton Mfg. Co.
Box 219-M Shirley Mass
Send 6c. for Catalogue

PIANO Do You Want a Genuine Bargain

Hundreds of Upright Pianos returned from renting to be disposed of at once. They include Steinways, Knabes, Fischers, Sterlings and other well known makes. Many cannot be distinguished from new yet all are offered at a great discount. Uprights as low as \$100. Also beautiful New Uprights at \$125, \$135, \$150 and \$165. A fine instrument at \$200, fully equal to many \$400 pianos. Monthly payments accepted. Freight only about 65. Write for list and particulars. You make a great saving. Pianos warranted as represented. Illustrated Piano Book Free.

FROM
LYON & HEALY

39 Adams St., CHICAGO.

World's largest music house; sells Everything known in Music

COOLNESS WITH COMFORT

Jaeger
PURE WOOL
UNDERWEAR

Absorbent and Protective

Special Weights for Summer

The Ideal Wear for Hot Weather

ALSO

PURE-WOOL
HOSIERY,
SHAWLS,
SHIRT-WAISTS,
STEAMER
RUGS,
BATH
ROBES,
PAJAMA
SUITS
ABDOMINAL
BANDS,
ETC.

Illustrated Catalogue Free

DR. Jaeger's S. W. S. Co's Own Stores
NEW YORK: 306 Fifth Ave, 157 Broadway
BROOKLYN: 504 Fulton Street
BOSTON: 230-232 Boylston Street
PHILADELPHIA: 1510 Chestnut Street
CHICAGO: 82 State Street

AGENTS IN ALL PRINCIPAL CITIES

ALPHA
New England
Salad Cream

TABLE SAUCE
AND
RELISH.

CONTAINS NO OIL.

ALPHA SALAD CREAM

is the ideal **salad dressing** for all varieties of salads. It is also the ideal sauce or relish for cold meats, canned salmon, shrimp or lobster, fish cakes, baked beans, cold slaw, cold cauliflower or asparagus, cold hash or on sandwiches.

ALPHA SALAD CREAM is absolutely pure. Never separates. Never spoils. Those who like oil can add their favorite brand with perfect results. Samples not mailable.

All Grocers.

Martha Taft Wentworth Recipe Book (60 Recipes and Suggestions) sent free for grocer's name. This book includes premium list. Informs you how to secure the New Game of Diamonds free. This game sells at 50c. to \$1, according to style and quality of board.

WONDERLAND PUDDING TABLETS. One tablet makes a quart of milk into a milk jelly more delicious, refreshing and nourishing than any other desserts. Also make Delicious Ice Cream. Package of 10 Tablets by mail 10c. No samples.

THE H. J. BLODGETT CO., Inc., 67 Thayer St., Boston, Mass.



The Hawkeye REFRIGERATOR BASKET

Keeps Contents Ice Cold.

Makes an outdoor luncheon a genuine luxury because a small quantity of ice keeps everything as fresh and palatable as when prepared. Well made in different sizes, durable and nicely finished.

shed. Ask your dealer for it. Descriptive booklet giving valuable lunch recipes.

SENT FREE

BURLINGTON BASKET CO.

17 Main Street

BURLINGTON, IOWA

SOMETHING NEW UNDER THE SUN

Taxidermy by Mail!

Sportsmen, do you shoot? If you own a gun and do not know how to mount your own select specimens, you are missing half the pleasure of the field. We teach you to mount birds, animals, reptiles, fishes, etc., by the most approved methods. We make you a Taxidermist. Easy to learn, easy to pay. Tuition less than you pay for one well mounted specimen. Save money. Decorate your den or office. Enjoy yourself. Special 50 per cent. discount to all who enroll at once. Write to-day for particulars.

Northwestern School of Taxidermy, HOLSTEIN, IOWA.

The original and only school of its kind.

For Sale: Colt Frontier Six Shooter, 44 caliber, 7½-inch barrel, nickel finish, first-class condition; modified for Western shooting to manipulate with the hammer. Price, \$8. Single Shot Maynard, 32-40 caliber, plain trigger, fitted with Wind gauge rear and Globe front sights. New Stevens barrel with three dovetails for telescope mountings (disfiguring barrel somewhat). Rifle is capable of doing fine work, but stock and sights show wear. Price, \$8. Purchaser to pay transportation in both cases. A. L. A. Himmelwright, Box 162, New York, N. Y.

Fox Squirrels: Extra selected specimens. Price, \$4 a pair.

Flying Squirrels: Most beautiful little pets. Price, \$2 a pair.

Food and water furnished to last to destination, and safe delivery guaranteed to any part of United States and Canada. E. F. Pope, Colmesneil, Tex.

For Sale: A Bargain. 38-72 Box Magazine Winchester Lyman Sights; perfect condition. Reloading tools, case, fifty loaded shells, one-half box empty shells. Outfit cost \$24; used one season. Price, \$16. Dr. G. W. Henika, Readstown, Wis.

To any person sending me \$1 for a year's subscription to RECREATION, I will give free a Fountain Pen with filler or a Webster's Dictionary, indexed. C. C. Talbot, 30 Union Street, Putnam, Conn.

For Exchange: A fine Banjo, with instruction book, for a folding camera or kodak or Cyclone magazine camera. A. D. Ostrander, Franklin, N. Y.

Journalism: Story-Writing



taught by mail. MSS. sold on commission; criticised, revised and prepared for publication. Send for free booklet. "Writing for Profit;" tells how to succeed as a writer. Thornton West, Editor-in-Chief; founded 1895.



THE NATIONAL PRESS ASSOCIATION,
The Baldwin, No. 109 - - - Indianapolis, Ind.

Mothers and fathers, do you realize that in order to maintain the perfect health of your children, they must receive the proper proportions of heat, bone and muscle-making and nerve and brain-building food?

SHREDDED WHOLE WHEAT BISCUIT



contains all these food properties in correct proportion. In providing it, you are supplying a food that properly and completely nourishes the whole body and that will make men and women with sound teeth, strong bones, firm flesh, elastic muscles and good nerve and brain power.

Buy it of your Grocer. Send for "The Vital Question" (Cook Book illustrated in colors), FREE. Address

THE NATURAL FOOD COMPANY, Niagara Falls, N. Y.

KEEP YOUR BAIT ALIVE.

Every angler in the United States and Canada should read the ad of J. M. Kenyon & Co. in this issue of RECREATION, and should then straightway order one of their minnow pails. This is certainly the greatest device ever invented for keeping minnows alive. The pail is provided with an air chamber in the bottom and an air pump on the side, similar to that used for inflating bicycle tires. You pump the air chamber as full of air as you can get it, then put in the water and minnows. This air, under the heavy pressure you have put on it, escapes slowly through small holes in a hard rubber tube in bottom of pail, which keeps the water thoroughly aerated. I used one of these pails last summer and after pumping the chamber full of air in the evening, I frequently went out in the morning and found the tiny bubbles coming up through the water and the minnows lively as crickets. Every angler knows the importance of having not only live but lively minnows for bass, pickerel and muskalonge fishing, and the man equipped with a Kenyon Minnow Pail may always have the right kind of bait.

Mexican Opals Free: To any one subscribing to RECREATION through me, I will send a beautiful genuine Mexican Opal, large as a cean.
A. Thompson. Box 332. San Antonio, Tex.

AS AN AID TO DIGESTION

No seasoning can compare with
McILHENNY'S

Tabasco Sauce

It is purer and more healthful than ground pepper, and leaves no lumps or sediment.

McILHENNY'S
Tabasco Sauce

gives a delicious and spicy flavor to
**SOUPS, SALADS, OYSTERS, CLAMS, FISH,
LOBSTERS, CHOPS, ROASTS,
SAUCES, GRAVIES, Etc.**

Be sure to ask your dealer for McILHENNY'S

Tabasco Sauce.

the original and best. Once used, TABASCO SAUCE becomes a household necessity.

FREE We will gladly send, upon request, an interesting booklet with many new and unique recipes.
Address

McILHENNY'S TABASCO, NEW IBERIA, LA.

SOME RARE OPPORTUNITIES

These goods are all new, and will be shipped direct from factory. Prices named are those at which manufacturers and dealers usually sell. Here is a good chance to get

A Book, a Gun, a Camera
A Sleeping Bag, a Fishing Rod
A Reel, a Tent, } FREE OF COST

Subscriptions need not all be sent at once. They may be sent in installments as taken and credit will be given on account. When the required number is obtained the premium earned will be shipped.

These Offers are subject to change without notice.

TO ANY PERSON SENDING ME

TWO yearly subscriptions to RECREATION at \$1 each, I will send a copy of *Hunting in the Great West*, cloth; or a Zar Camera, listed at \$1; or an Ingersoll Watch or Cyclometer, listed at \$1; or a Recreation Waterproof Match Box, made by W. L. Marble and listed at \$1; or a Shakespeare Revolution Bait listed at 75 cents; or a Laughlin Fountain Pen; or a dozen Trout Flies, assorted, listed at \$1; or a pair of Attachable Eyeglass Temples, gold-plated, made by Gall & Lembke; or one Rifle Wick Plug, made by Hemm & Woodward, Sidney, Ohio, 30 caliber to 50 caliber, or Shotgun Wick Plug, 20 gauge up to 10 gauge.

THREE subscriptions at \$1 each, a safety pocket ax, made by W. L. Marble and listed at \$2.50; or a dozen Bass Flies, assorted, listed at \$2; or 4 dozen Carbutt plates, 4x5 or 5x7; or a pair of chrome tanned horsehide hunting and driving gloves, listed at \$1.50, made by J. P. Luther Glove Co.; or a pair of Shotgun Wick Plugs made by Hemm & Woodward, Sidney, Ohio, 20 gauge to 10 gauge.

FOUR subscriptions at \$1 each, an Ideal Hunting Knife, made by W. L. Marble and listed at \$2.50; or a .32 caliber Automatic Forehand Revolver, made by the Hopkins & Allen Arms Co.; or a No. 822 Rifle made by the Hopkins & Allen Arms Co., listed at \$4.50.

FIVE subscriptions at \$1 each, a copy of *Cruisings in the Cascades*, cloth; or a set of Nehring's Convertible Ampliscopes, listed at \$5.00; or an Ideal Hunting Knife made by W. L. Marble, and listed at \$3; or a polished Buffalo Horn Gun Rack, made by E. W. Stiles; or a Forehand Gun, made by the Hopkins & Allen Arms Co., listed at \$6; or a pair of lock lever skates, made by Barney & Berry, listed at \$4.50; or a pair of gauntlets, for hunting and driving, ladies' size, listed at \$2.50, made by J. P. Luther Glove Co., or a J C Hand trap made by the Mitchell Mfg. Co., listed at \$4.

SIX subscriptions at \$1 each, a Hawkeye Refrigerating Basket made by the Burlington Basket Co., or one dozen Eureka golf balls listed at \$4; or a Forehand Gun made by the Hopkins & Allen Arms Co., listed at \$9; or a Pocket Poco B 3¼x4¼, made by the Rochester Optical & Camera Co. listed at \$9.

SEVEN subscriptions at \$1 each, a copy of *The Big Game of North America*, or of *The American Book of the Dog*, cloth, or one set Lakewood golf clubs, 5 in number, listing at \$5; or a series IIB or IID Korona Camera, made

by the Gundlach Optical Co., listed at \$10. EIGHT subscriptions at \$1 each, a 4x5 Weno Hawk-Eye Camera, made by the Blair Camera Co., and listed at \$8; or a series I, 4x5, Korona Camera, made by the Gundlach Optical Co., listed at \$12; or a pair of horsehide Hunting shoes, made by T. H. Guthrie, Newark, N. J., and listed at \$8.

NINE subscriptions at \$1 each, an Acme single shot gun, made by the Davenport Arms Co., and listed at \$8.

TEN subscriptions at \$1 each, a Cut-Glass Salad Bowl, made by Higgins & Seiter, and listed at \$4.50; or a Yawman & Erbe Automatic Reel, listed at \$6 to \$9; or a Bristol Steel Fishing Rod, listed at \$6, or less; or a Waterproof Wall Tent 7x7, made by Abercrombie & Fitch, and listed at \$8; or a pair of horsehide Hunting Boots, made by T. H. Guthrie, Newark, N. J., and listed at \$10; or a Rough Rider rifle telescope, made by The Malcolm Rifle Sight Mfg. Co., and listed at \$12.

TWELVE subscriptions at \$1 each, a Peabody Carbine valued at \$12; or a Davenport Ejector Gun; listed at \$10., or a Cycle Poco No. 3, 4x5, made by the Rochester Optical and Camera Co., listed at \$15.

FIFTEEN subscriptions at \$1 each, a Shakespeare Reel, Silver Plated, listed at \$15; or a set of rabbit plates made by Higgins & Seiter, and listed at \$8, or a Field Glass made by Gall & Lembke; or a Kenwood Sleeping Bag, complete, with canvas cover, listed at \$16; or a Bulls-Eye rifle telescope, made by The Malcolm Rifle Sight Mfg. Co., and listed at \$16.

TWENTY subscriptions at \$1 each, a 14-karat Gold Hunting-case Watch, with Waltham Movement, listed at \$20; or an Elita single shot gun, made by the Davenport Arms Co., and listed at \$18., or an Acme Folding Canvas Boat, No. 1, Grade B, listed at \$20; or a Mullins Duck Boat, listed at \$20; or a Shattuck double hammerless shot gun listed at \$25; or a Pneumatic Camp Mattress, with pillow listed at \$20.

TWENTY-FIVE subscriptions at \$1 each, an 11-foot King Folding Canvas Boat, listed at \$38; or a 4x5 Planatic lens, made by the Rochester Lens Co., and listed at \$25; or a Syracuse Grade OO, double hammerless Gun, made by the Syracuse Arms Co., and listed at \$30.

THIRTY subscriptions at \$1 each, a Waterproof Tent, 14½ x 17, made by Abercrombie & Fitch, and listed at \$25; or an Ithaca, quality No. 1, plain, double barrel, hammerless breech loading shot gun, listed at \$40.; or a Field Glass, made by C. P. Goerz.

THIRTY-FIVE subscriptions at \$1 each, a 14-foot King Folding Canvas boat, listed at \$48.

FORTY subscriptions at \$1 each, a Savage .303 Repeating Rifle; or a No. 10 Gun Cabinet, made by the West End Furniture Co., and listed at \$32.

FORTY-FIVE subscriptions at \$1 each, a Royal Anastigmat Lens, 4x5, series I made by Rochester Lens Co., and listed at \$45.

FIFTY subscriptions at \$1 each, a No. 20 Gun Cabinet, made by the West End Furniture Co., and listed at \$38.

TWO HUNDRED subscriptions at \$1 each, a strictly first class upright piano, listed at \$750.

Address, **Recreation 23 West 24th St, New York**

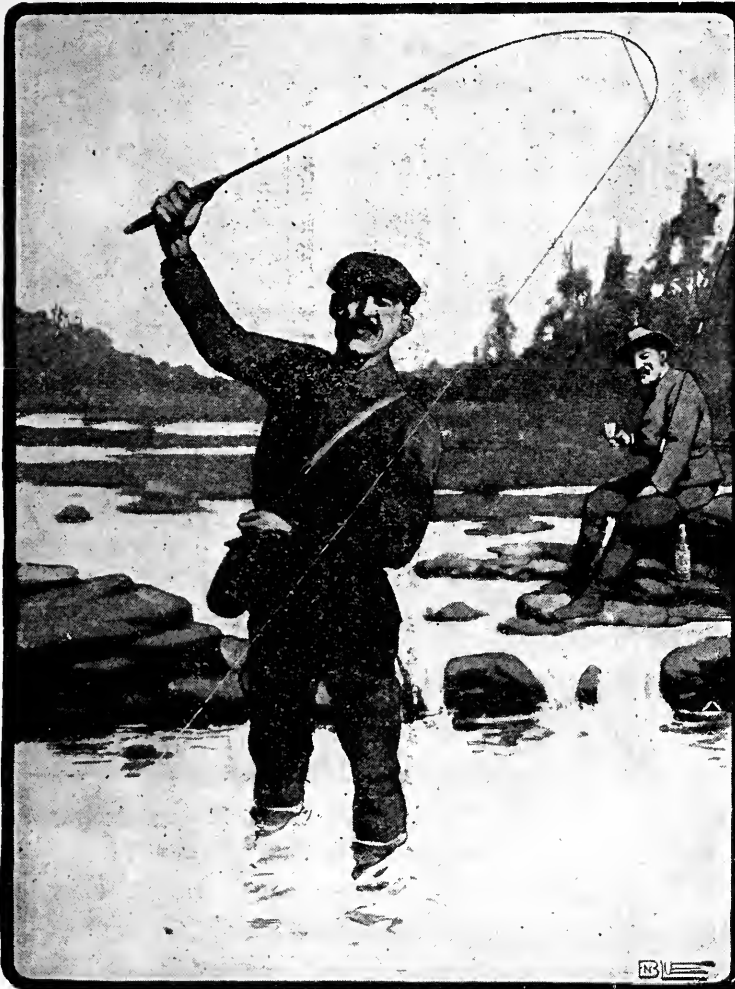

FISHERMAN'S LUCK

often includes a combination of wet feet, hunger, a light creel and a plentiful supply of hard luck stories. The truly lucky fisherman is the one who provides himself beforehand with the consoling companionship of

Dewar's Scotch

It is bottled where distilled, from the largest reserve stock of old Scotch Whisky in the world.

AN ANGLER'S POSTER

"Fisherman's Luck" (copyright, 1903, by Frederick Glassup), is the original drawing by E. N. Blue, shown herewith. It has been printed in four colors on heavy plate paper, 9 x 12, without advertisement of any kind, and will be sent to any address on receipt of 10 cents in silver. Suitable for framing in clubhouse or home. Next month, "In Camp," a picture of outdoor life by Dan Smith.

FREDERICK GLASSUP

Sole Agent for John Dewar & Sons, Ltd.

126 Bleecker Street, New York

Do you want
A Folding Canvas Boat?

IF SO, SEND ME

35 yearly subscriptions
to RECREATION

AND I WILL SEND YOU

A 14 ft. King folding canvas
boat listed at \$48

capable of carrying 2 men
and an ordinary camp outfit.
There are thousands of these
boats in use, and nearly every
man who is using one of
them praises it on every occasion.

Sample copies of RECREATION
for use in canvassing
will be furnished on application.

Address 23 W. 24th St., N. Y.



UNDERWOOD'S ORIGINAL DEVILED HAM

The pure and delicate Deviled Ham which has been on the market for years. Sugar-cured ham and fine, pure spices is all that we use. It is delicious for sandwiches, at lunch, picnic, or tea, and in the chafing-dish. It may be bought at any good grocers, but be sure you see on the can THE LITTLE RED DEVIL. There is only ONE Deviled Ham - Underwood's Red Devil Brand. All others are imitations, but imitations in name only, as the goods commonly labeled and sold as potted or deviled ham, made as they are from the odds and ends of the packing house, are no more like Underwood's Original Ham than chalk is like cheese. Our Book contains a lot of unique and practical receipts. We will send it FREE. WM. UNDERWOOD CO., Boston, Mass., U. S. A.

HOTEL AYERS

LAKE DUANE

Adirondacks Franklin County

DO YOU KNOW THE BEAUTIES
OF THE GREAT NORTH WOODS?

Here are some of the things you can find at Ayers:

- Deer, trout, and cedar boats.
- 1,000 acres of primeval forest.
- Seven beautiful lakes and four miles of shore line.
- 2,000 feet elevation; magnificent mountain scenery.
- Balsam-scented air; water from mountain springs.
- Tennis, billiards and bowling.
- Splendid fishing, hunting, boating, and bathing.
- EXCELLENT CUISINE and GOOD BEDS.
- Wide verandas, open fires, telephone and telegraph.
- Miles of picturesque trails; an ideal forest home.
- Consumptives not received.
- Write for booklet, itinerary; terms and references.

W. J. AYERS & SON

Ayers, Franklin County, N. Y.

BARRETT'S

Bald Mountain House

Third Lake, Fulton Chain

Adirondack Mountains Herkimer County, N. Y.

Situated on Third Lake and at the foot of Bald Mountain, from which the hotel takes its name.

Choice Fishing and Hunting in Every
Direction.

Pure Air — Pure Water
Inspiring Scenery

Address

C. M. BARRETT

Old Forge P. O.

Herkimer County, N. Y.

BEST FISHING

AND

FINE HUNTING

Earliest and latest Moosehead lake fishing is had here; also plenty of big game. House has been entirely refurnished; rooms have hot and cold water and baths. Grounds nicely graded, tennis court, croquet grounds and many fine woods roads laid out. Fishermen can avoid expense of guide by coming here, although we furnish guides, boats and canoes when desired. Several camps in our "string," all snug and attractive. Rates \$2.00 to \$2.50 per day. Descriptive Booklet sent free.

At OUTLET HOUSE

(Formerly Moosehead House), MOOSEHEAD, ME. 11 miles from Greenville by C. P. R. R. or by Steamer.

CHARLES. E. WILSON - Propr.

New steamboat just bought to accommodate our guests.

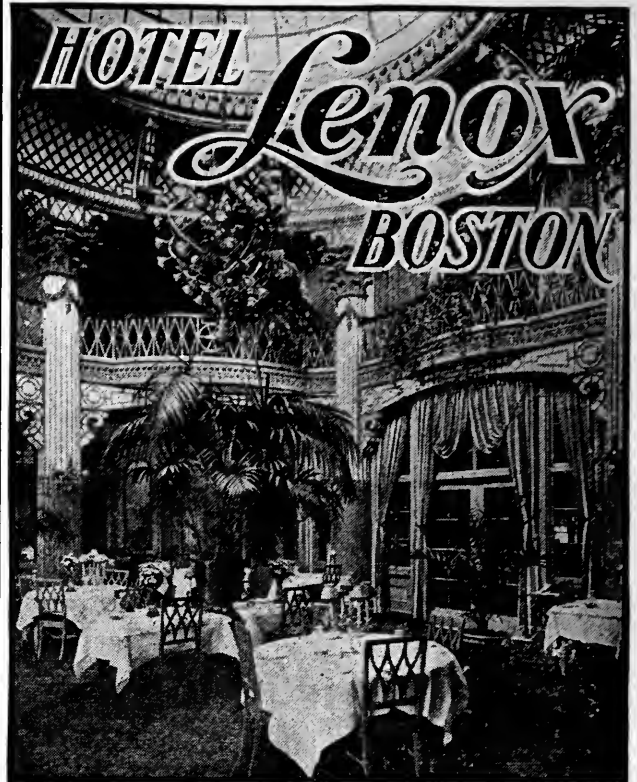

Comfort and Convenience for either
a short or long stay in Boston
Beautifully located near Back Bay
Station.

RATES ON APPLICATION

MUSKOKA LAKE, ONT., CANADA

Beaumaris Hotel

Finest situation on the Muskoka Lakes. Has been remodeled and enlarged. First class Nine-Hole Golf Links, Tennis Lawn, Bathing, Boating, Fishing. Best place in the country for hay fever people. Write for booklet.

EDWARD PROWSE
PROPRIETOR

ADIRONDACKS

CAMP MOHAWK and
COTTAGES

Fourth Lake, Fulton Chain.

Write for
booklet Mrs. H. H. Longstaff, Old Forge,
N. Y.



There is a
Guarantee of 25 years
behind every

JAS. BOSS **Stiffened GOLD Watch Case**

It's the only gold filled case that has proved its wearing quality by test of time. Made, sold and worn since 1853. Remember this when buying a watch, and insist on having a Boss case with the Keystone trade-mark—stamped inside.

Send for booklet.



THE KEYSTONE WATCH CASE COMPANY,
Philadelphia.

HOW BILL WAS CURED.

W. D. GAY.

A jeweler sat on his little, old stool,
He bored and he drilled, but couldn't keep cool;
He had sat on that stool for a number of years,
And to see his round shoulders would make you shed tears.

His name it was Bill, just simply Bill Gay,
And his friends said that he would be missing some day;
For he had been seen with some green catalogues
Of fine rods and reels and soft rubber frogs.

'Twas the time of year when the black bass bite,
And muskalonge sport in the waters bright;
Bill couldn't sit still, let him try as he would,
His folks said he "had 'em," and had 'em right good.

He was absent minded and dreamed all day
Of a Wisconsin lake, and a season of play;
Of a birch bark canoe and a light rod of steel,
Of a blueberry patch and a well filled creel.

Two chums he selected, trusted and true,
He filled them both up with old stories and new;
Then together they went, with their new rods and flies,
To the land of big fishes and blueberry pies.

Four weeks they put in 'mid the pine-clad hills,
Where nature in splendor a sportsman's heart thrills;
Then they all returned home, and now Bill can keep cool,
As he sits all day long on his little, old stool.

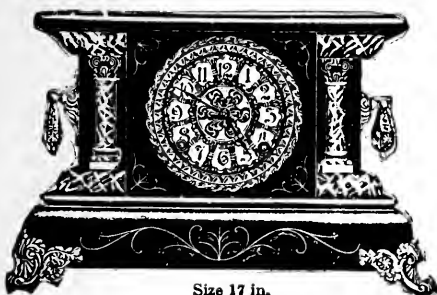

Size 17 in.

A skilled mechanic has invented lately a **Musical Clock** which, besides keeping perfect time, running 8 days with one winding, striking the hours and halves, will also **play favorite airs every half hour.** As the cost is very low, many prefer buying the clock with the musical attachment. Ask your jeweler for it or send to **E. L. CUENDET, Mfr., 7 Barclay Street, New York**

SQUIRES' SIBERIAN MOOSE HUNTING BOOTS & SHOES

Made only by **HENRY C. SQUIRES & SON**
20 Cortlandt St., New York

The **leather** is waterproof, fine grained, tough and pliable. The **linings** are russet calfskin. The **soles** are best waterproof anhydrous oak leather, **stitching** of silk, English back stays, bulldog toes, extra heavy **eyelets, Pratt fasteners** and **hand made throughout**. Price **\$7.50** net. Short Boots **\$8.50**, Knee Boots **\$10**, Cavalry Style Boots **\$12**. Special circular giving detailed information free for the asking.



Mention RECREATION.

Wanted.—A lady and daughter, in a country village, are desirous of furnishing a home for the summer for 4 or 5 girls between the ages of 8 and 14. Close care and attention will be given them. The locality is healthful, and particularly adapted for mountain walks, wheeling, and delightful drives. A fine opportunity is offered for the study of nature.

The best references given and required. Inquire of Editor.

Wanted—Salesman.—A practical, all round, experienced salesman in the Gun, Gun Material, Fishing Tackle, and general sporting goods line. State age, where last employed, salary expected, references etc. Communications strictly confidential. Address, Salesman, care "RECREATION," New York, N. Y.

For Sale:—One Chesapeake Bay dog, 11 months old. Also young Chesapeake Bay puppies. They all are eligible to register.

Maurice Schindler, Sisseton, S. D.

For Sale: New Winchester Repeater, model '92, 25-20 caliber. Price, \$10. Chester Deysher, 414 Spruce Street, Reading, Pa.

Wanted: Colt's Rifle, 32-20. Al. Kennedy, Post Falls, Idaho.

RELICS OF A DISAPPEARING RACE

Buffalo Skulls

WITH POLISHED OR UNPOLISHED HORNS

Also polished or unpolished horns in pairs or single. Polished horns tipped with incandescent electric lights; polished hunting horns; mirrors hung in polished horns, etc. These are decided novelties and are in great demand for sportsmen's dens, offices, club-rooms, halls, etc. Send for illustrated catalog. Mention RECREATION.

E. W. STILES

141 Washington St.

Hartford, Conn.

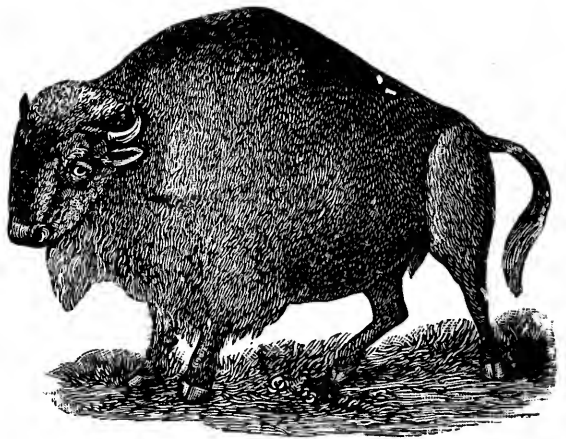

IT DOES GOOD WORK *for a longer time*
IT DOES MORE WORK *all the time*



The Densmore Does More

Densmore Typewriter Company
309 Broadway New York

YOUR CIGARS FREE FOR A YEAR

A simple business proposition. What you ordinarily spend over the retail counter for cigars in one year will, if spent with us, the manufacturers, furnish you with another year's smoking **FREE**.

A cigar as good as the one you smoke—perhaps even better—for **ONE-HALF** what you ordinarily pay at retail.

We have turned our backs on the wholesaler, to whom for years we have been selling millions of our celebrated brands, and now go to you **DIRECT**, offering them by the box at precisely the same prices.

This means one-half the price you have been paying at retail.

Your taste exactly suited, our statements positively guaranteed, or

YOUR MONEY BACK



"Turning our backs upon well-beaten paths."

Send for our illustrated Catalogue explaining everything, or for **\$1.00** we will send a trial package of twenty-five assorted sizes and blends, or for **75 cents** twelve **10 cent** and two for a **quarter** value; or **50 cents** for twelve **5 and 10 cent** values, each separately wrapped and described, showing how **two** for a **quarter** and **10 cent** cigars can be bought in boxes of **25, 50 and 100** for from **4 to 6 cents** each; others from **2 to 3 cents** each. **TRANSPORTATION ALWAYS PREPAID.**

REFERENCES—Any bank, any agency, or our customers in every portion of the United States.

JOHN B. ROGERS & CO.

"THE PIONEERS"

91 Jarvis St., Binghamton, N. Y.

This is the time of year when cold drinks are in order, whether soft or hard, and persons who go into the woods fishing, picnicking or camping, and who wish to carry ice with them should have a Hawk Eye Refrigerator Basket, made by the Burlington Basket Co., Burlington, Ia. This is a good, big, roomy basket, lined with zinc and padded with asbestos so that you may fill it with ice, set it out in the sun the hottest morning in summer, and there will be ice in at night. The basket is divided into compartments, so that you may put your liquid groceries in one end and your ice in the other, thus keeping the former cool and relishable without mixing. Write for an illustrated circular and do not forget to mention RECREATION.

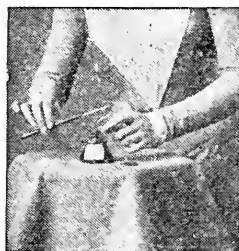

The Puritan Fountain Pen Filler

Fills the pen with ink in 1 the world with joy.

Push the pen barrel on arm of filler and withdraw, and your pen is filled. No staining or bubbling. Desk form: 5 cents. Pocket form: 20 cents. Order of your dealer or by mail. Give inside diameter of pen barrel.

Beekman Novelty Co.,
317 Broadway, New York City

IN THE ADIRONDACKS

Indian Lake House

Mountain View, N. Y.

C.C. Morgan, Prop.

ALL THE YEAR

All passenger trains on A. & S. L. R. R. will be met by boat and bus. Passengers conveyed directly to the house.

Rates. \$2 per Day.

Special Rates to Parties

Best DEER HUNTING and TROUT FISHING to be found in the Adirondacks

The Celebrated

THOMPSON-QUIMBY

THOMPSON



Hunting Boots, Shoes and Moccasins

SON

I have on file measurements of all who bought Boots and Shoes of the W. Fred Quimby Co., of New York for the past 20 years, and I make the same grade of sportsmen's footwear as they made. I was superintendent of the shoe department of that firm and bought the right to make these boots and shoes. Get a pair now. They will last years and are the cheapest in the end. I refer by permission to the Editor of RECREATION.

Measurement blanks and prices on application. Mention RECREATION.

T. H. CUTHRIE

33 William Street, NEWARK, N. J.

Ali Work Guaranteed

WEBBER'S Jersey Coat

Costs no more than old-fashioned blouse to pull over the head. Designed for trap shooting in hot weather, but suitable for any purpose. Good thing for fishing, chicken shooting or office coat. Very light weight but strong and made to fit. Ask your dealer for it. If he does not have them, send me your size and price, \$2, and I will send you one to fit, charges prepaid.

GEO. F. WEBBER, MFR.

Station A, Detroit, Mich.

PAGE POULTRY FENCE HEAVIEST AND STRONGEST MADE

20 Horizontal Wires, 48 Inches High, and 23 Horizontal Wires, 58 Inches High. Bottom wires only 1½ inches apart. Fences poultry IN, and stock OUT. Dealers don't keep it. See our agent, or write us.

PAGE WOVEN WIRE FENCE CO.
BOX 39
ADRIAN, MICHIGAN

Squab Book Free



Squabs are raised in 1 month, bring big prices. Eager market. Astonishing profits. Easy for women and invalids. Use your spare time profitably. Small space and capital. Here is something worth looking into. Facts given in our FREE BOOK, "How to make money with Squabs." PLYMOUTH ROCK

SQUAB CO., 11 Friend St., Boston, Mass.

All kinds of **PHEASANT EGGS** for setting at a low price. My stock was all imported by me, "**None Better.**" Eggs from W. P. Rocks and W. Leghorn \$2 for 13. Stock scores go to 95½

Do you want to "**get rich quick?**" Send me 2 stamps and get my book telling how to make lots of money breeding squabs. Imported Homers, Mated, \$1.50 pair. 3 pair White Swans, \$27 a pair. 5 pair two pound Runts, \$10 a pair. My booklet tells how to raise lots of Pheasants. **GENE DEGUARDINER**
R. F. D. NATICK, MASS.

Valley Farm Kennels, Simsbury (Hartford Co.) Conn.

Russian Wolfhounds

The Most Magnificent Dogs That Live

Pups and full grown dogs from our champions for sale. Also Bull, Boston, Irish and Black-and-Tan Terriers, Cocker Spaniels, Bulldogs and American Foxhounds. Thoroughbred Poultry. New establishments stocked. Experienced attendants recommended, etc. Catalogues.

FLORIDA BIRDS.

I have on hand a fair assortment of our Native Bird Skins, suitable for schools, museums or private collections.

During the season of 1903 I will collect any birds or mammals to order.

Finest mounted work a specialty.

R. D. HOYT, Taxidermist,
SEVEN OAKS, FLA.

Taxidermists' Glass Eyes for Stuffed Birds and Animals

Oologists' and Entomologists' Supplies

Materials

Send 5c. in stamps for catalogue

FRED. KAEMPFER, 88 STATE ST., Chicago, Ill.

Taxidermy work done in all its branches
Mention RECREATION

For Sale. The largest collection of Game Heads, Horns, and Antlers in America. A total of TWO HUNDRED AND FIFTY SPECIMENS, including many record heads and exceptional freaks and rarities. Full information and catalogue on application.

A. E. COLBURN,

Bond Building, Washington, D. C.

Joker A highly bred pointer, well broken. For photograph, pedigree, etc., address

P. O. Box 571, Alliance, Ohio

FINE MOUNTED GAME HEADS, BIRDS, ETC., for sale at unheard-of prices. Send 10 cents for photos.

JOHN CLAYTON, Taxidermist, Lincoln, Maine

Bargains in fine modern and old-fashioned rifles, shotguns and pistols from my collection. Send stamp for price list

Chas. Winthrop Sawyer,

41 Humphreys Street,

Boston, Mass.



GREAT DANE OR SPANIEL

and all intermediate species of dogs can be put in the best physical shape by

SERGEANT'S CONDITION PILLS

For the field—bench—companionship or stud a dog is not fit unless in true condition.

Like people he must have health or his efforts become—nil.

Probably no better formula for curing Dog ailments can ever be compounded than that of the veteran sportsman, POLK MILLER, Virginia's foremost sportsman, who has had 40 years practical experience in treating dogs and is possibly more familiar with their ailments than any veterinarian in this country.

SERGEANT'S CONDITION PILLS will improve a dog's appetite by curing disordered digestion, which, if allowed to develop into chronic dyspepsia allows of no peace to the best dog alive.

If a dog is attuned physically to all the requirements intended by nature, he doesn't need condition pills and he is better off without them, but dogs as a rule are subject to the same ailments that man is and are not immune any more than people; therefore, when your dog is suffering from **Distemper, Mange, Fever, Colds, Coughs, Constipation, Stomach Trouble, Indigestion, General Debility and Nervousness**, give him the best dog alterative and the only remedy for dogs that is standard wherever you may go.

SERGEANT'S CONDITION PILLS cost 50c. and \$1.00 per box at Druggists or by mail (prepaid) from

POLK MILLER DRUG CO.,
RICHMOND, VIRGINIA, BOX 217.

There isn't anywhere a dog lover or owner who wouldn't like to have our 48 page Treatise on Dogs. We will send it and a Pedigree Blank to any address for 3 cents in stamps which go to pay the postage.



Established 1840

GEO. B. CARPENTER & CO.
MAKERS OF HIGH GRADE
**TENTS, SAILS
CAMP FURNITURE**

Folding Cots
Tables and Chairs

Oars, Paddles
Marine Hardware

The Largest and Most Complete Stock in the U. S.

Send 4c. in stamps for Tent and Camp Catalogue, or 6c. in stamps for Marine Hardware Catalogue.

200, 202, 204, 206, 208 S. Water St.
CHICAGO, ILL.

Copyright 1899 Geo. B. Carpenter & Co.

NO. 1. HAS THREE COMPARTMENTS AND FLOATS.

HALL'S TELESCOPIC BUCKETS AND FLOATS

MINNOWS
GRABBA

PAT. AUG. 5TH 1902. CANADA PENDING PATENTS.

\$10000 WILL BE PAID ANY PURCHASER OF THIS BUCKET WHO WILL SUGGEST AN EFFECTIVE IMPROVEMENT.

HALL MFG. CO. CLEVELAND O.
BRIGHT & FOUNTAIN, STS.

PATENTS

Quickly secured. **OUR FEE DUE WHEN PATENT OBTAINED.** Send model, sketch or photo. with description for free report as to patentability. **48-PAGE HAND-BOOK FREE.** Contains references and full information. **WRITE FOR COPY OF OUR SPECIAL OFFER.** It is the most liberal proposition ever made by a patent attorney, and **EVERY INVENTOR SHOULD READ IT** before applying for patent. Address:

H. B. WILLSON & CO.
PATENT LAWYERS,
Le Droit Bldg., WASHINGTON, D. C.

No Other Reel Will Give

Satisfaction after you have seen the

"TALBOT"

A thing more perfect was never wrought in metal. In tournaments always a victor. Among fishermen's treasures, the chief.

Send for Booklet F:

W. H. TALBOT, Nevada, Mo

PAROID ROOFING

"IT LASTS"

If you are looking for a roofing that is better than shingles for your camp, you will find **Paroid** does the work. Each roll a complete roofing kit, and anyone can apply it.

F. W. BIRD & SON

Mills and Main Office

East Walpole, Mass., U.S.A.

New York Chicago

NAVIGATION

**A Course of Especial Interest
to Yachtsmen**

TAKES up the subjects of Boxing the Compass, Magnetism, Dip of Needle, Deviation, Correction of Course, Charts, the Sailings, Latitude, Longitude, Nautical Astronomy, etc.

*Instruction under the direction of
members of the faculty of Armour
Institute of Technology.*

Other courses in Electrical, Mechanical, Civil, Locomotive, Stationary, Marine, and Sanitary Engineering; Architecture, Navigation, Refrigeration, Mechanical and Perspective Drawing, Sheet Metal Work, Telegraphy and Telephony, Textile Manufacturing—also 40 short Engineering Courses.

AMERICAN SCHOOL OF CORRESPONDENCE

AT

Armour Institute of Technology
CHICAGO, ILL.

MARINE GAS ENGINES

Experts for years have ranked our engines with the highest grade, and it is now being copied by other builders. We always endeavor to be on top and for 1903 offer an engine built from brand new patterns, with **NEW** and **ORIGINAL** features—just what other engines will have five years hence.

If you want to be in the lead send for catalog fully describing all parts, and then buy a "Rochester".

ROCHESTER GAS ENGINE CO.

700 Driving Park Ave. Rochester, N. Y., U. S. A.

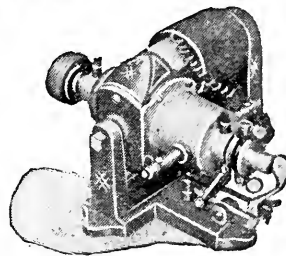

**To Owners of Gasoline
Engines, Automobiles,
Launches, Etc.**

The AUTO-SPARKER

does away entirely with all starting and running batteries, their annoyance and expense. No belt—no switch—no batteries. Can be attached to any engine now using batteries fully guaranteed; write for descriptive catalog.

Motsinger Device Mfg. Co.
75 Main Street, Pendleton, Ind.

Patent Independent Level Winding Device

Patented Jan. 13, 1903.

Below we quote the following delivered price on guaranteed strictly high-grade quadruple casting reels, with even spooler attached. They are strong cut gear, light running, and as fine outside and in as a watch, and should last a lifetime.

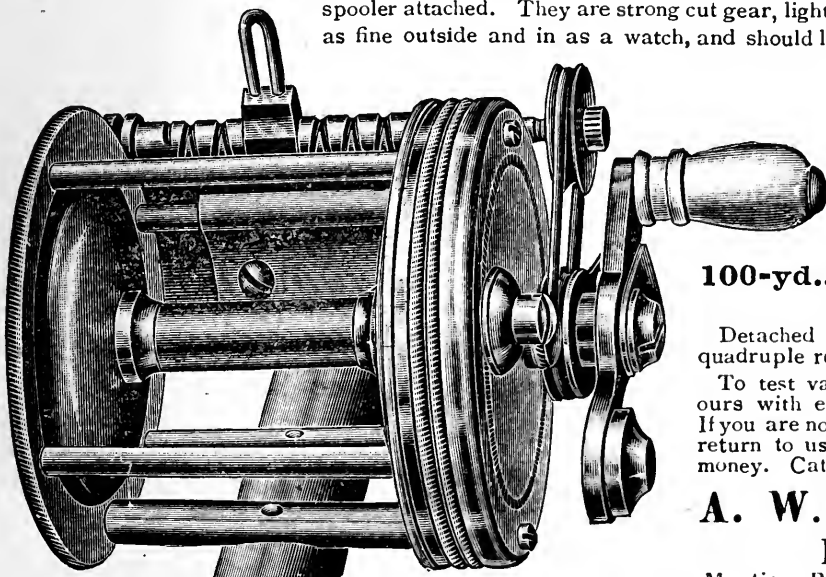

Jeweled Bearing:

100-yd., \$6.75

80-yd., 6.50

60-yd., 6.00

**Stubs Steel Pivot
Bearing:**

100-yd., \$5.75. 80-yd., \$5.50

60-yd., \$5.00

Detached even spooler for such old or new quadruple reels as they will fit, . . . \$2 50

To test values try to buy as good reels as ours with even spooler at double our prices. If you are not perfectly satisfied after inspection, return to us and we will promptly return your money. Catalogs free.

**A. W. BISHOP & SON,
RACINE, WIS.**

Mention RECREATION.



Fine Fishing Tackle Free.

The Famous Shakespeare Reels and Baits
That Catch Fish, Free to Any
Enthusiastic Angler Who Sends
Name and Address.

Who Will Catch the \$100.00 Prize Large or Small Mouth Black Bass This Year?

I want every enthusiastic fisherman, whether amateur, beginner or professional to, have a personal knowledge of the fine points of the Shakespeare Reels and the marvelous catching qualities of the Shakespeare Baits—and to do this I propose to send to every man or woman who fishes for the real sport there is in it, one of my reels and baits for free trial on their next fishing trip. Write to-day. Send your name and address and the name and address of the leading sporting goods dealer of your city to Wm. Shakespeare, Jr., 278 Shakespeare Bldg., Kalamazoo, Mich. The Shakespeare Reel is specially designed for accurate and long-distance casting, and it is without doubt the best reel in the world, and you will say so when you see it. The metal used in the manufacture of the Shakespeare Reel is hard-drawn brass and the finest English Stubbs steel—the best obtainable. Painstaking care is used to secure perfect accuracy in every detail. In beauty of design, and simplicity of construction it is unequalled. Its easy, silent running suggests perpetual motion and it is fitted with the most perfect drag and click ever invented. Words will not describe its beauty, its usefulness and its many advantages over all other reels. My reels and baits are for sale by all first-class dealers, but I want you to see them and try them for yourself and I will send them to you direct, express prepaid, for a free trial on your next fishing trip. The Shakespeare Baits are really marvelous. With them the fisherman is sure of a good catch, no matter where the fish are, in the lake or stream. If they are in deep water, Shakespeare makes the bait that attracts them. If they are in shallow water, Shakespeare makes the bait that catches them. If they are hidden in the lily pads or moss, Shakespeare makes the bait that makes them strike. And Shakespeare offers \$100 in prizes for the photograph and authentic dimensions of the biggest large or small mouth bass caught this year. Write to-day for particulars. His little booklets, "How to Catch Bass," "Fine Points About Tackle" and "The Art of Bait Casting" are free to every angler. Write to-day and send your name and address.



Camp Bristol

One enthusiastic sportsman—a constant user and admirer of the

“BRISTOL” STEEL RODS

has his occasional *habitat* in the camp above pictured. He writes:—

“I have discarded my split bamboo and my wood rods I formerly ‘swore by,’ and am ‘in love with’ the ‘BRISTOLS’ you sent me. Tell the boys to throw away all nonsensical prejudice, and hasten to form the acquaintance of a ‘Bristol’ Rod—for there’s millions (of fish) in it.”

We will send you our free catalogue if you like—then you can do as you choose.

The Horton Manufacturing Company
No. 73 Horton Street, Bristol, Conn.



EITHER AUTOMATIC OR FREE-RUNNING

—You simply press a slide and instantly your "Y and E" Automatic-Combination Reel is either free-running or automatic.

—Do you see the point? You make your cast free-running. Then you flip the little slide, and your reel is instantly automatic. If you want to re-wind you simply press the lever with your little finger—and you're ready for another cast immediately. If, instead, you get a strike, the pressure of the lever by your little finger puts a tension on your line, and Mr. Fish can't possibly get slack enough to drop your hook. Beats winding like fury with an ordinary crank reel, doesn't it?



"The little finger does it."

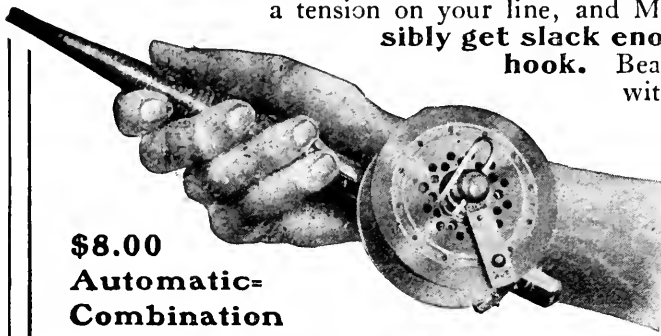

\$8.00
Automatic-Combination

Style B.

1903
MONEY
PRIZES

The only perfect reel for fly- and bait-casting. Either free or automatic instantly, by the slipping of a catch. Diameter, 3 3/8 in. Weight, 11 oz. Carries 300 feet. Winds 90 feet automatically, without re-winding.

Buy from your hardware or sporting goods dealer. If he can't supply you, we'll mail to you **prepaid** on receipt of price anywhere in U. S. or Canada.

4 Other Styles.

—5 of them: 3 for Grown Ups; 2 for Young People not over 16— for best catches made with "Y and E" Reels. **Write to-day** for free contest blank and handsome catalogue No. "299-R."

Yawman & Erbe Mfg. Co.
ROCHESTER, N. Y.

WHITESTONE HOLLOW SPAR AND BOAT CO.

Successors to The Spalding St. Lawrence Boat Co..

Builders of the FAMOUS St. Lawrence River Skiffs; Cedar Canoes; Canvas Covered Cedar Canoes; Speed Launches; Yachts' DAVIT BOATS and Hollow Spars.

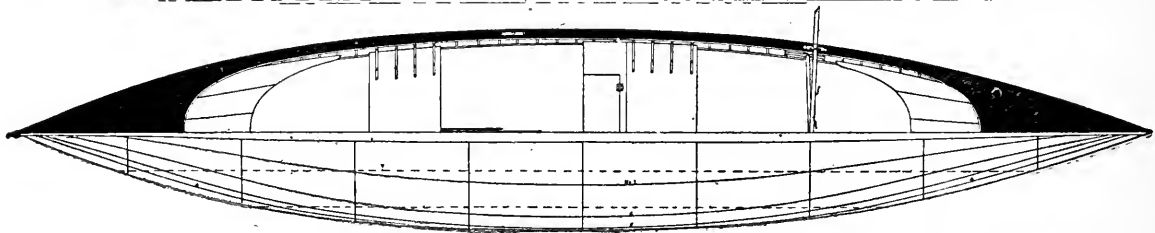
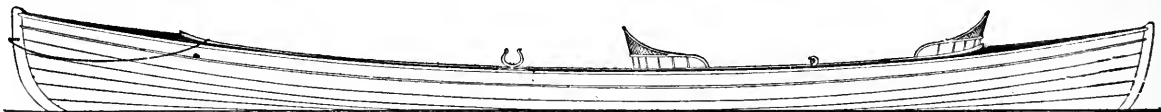

The Famous St. Lawrence River Skiff. Catalogue No. 5



Canvas Covered Cedar Canoe. Catalogue No. 6. High Grade \$30



We believe our CANVAS COVERED CEDAR CANOES to be UNEQUALED AT ANY PRICE. In this exceedingly popular little craft, we have accomplished a happy combination of FORM; EASE OF PADDLING; APPEARANCE; STAUNCHNESS, MINIMUM WEIGHT WITH MAXIMUM STRENGTH. We were the first in New York State to make this type, viz., the Canvas Covered Cedar Paddling Canoe, and have made same so exceedingly popular throughout the canoeing world as to incite imitators. If your canoe has our trade mark shield on her bow deck, you can rest safely assured it is THE STANDARD OF EXCELLENCE.

WHITESTONE HOLLOW SPAR AND BOAT CO.,
J. G. FRASER, Manager
Whitestone Landing, Long Island, N. Y.

Trade Mark

LOZIER

GAS ENGINES and LAUNCHES

The LOZIER MOTOR CO.
 PLATTSBURG, N.Y.

BRANCHES:
 NEW YORK, 1 BROADWAY.
 BOSTON, 185 SUMNER ST.
 PHILADELPHIA, THE BOURSE.



U. S. Government who prefer our boats. Received medal and award at Chicago World's Fair. If you investigate we will get your order.

Send for catalogue of our full line of Folding Canvas Boats and Canoes, which have been adopted by Governments of United States, Canada and England. Just filled an order for. Mention RECREATION.

Acme Folding Boat Company, Miamisburg, O.



Points on Angling

More complete than ever before

The Habits and Haunts of GAME FISH

and How to Catch Them

Mailed free on application

THE SPECIALTY MFG. COMPANY
 Box 62a, Goshen, Indiana

GUNNERS AND ANGLERS



Here is what you need. A powerful, compact **Electric Flashlight** to carry in the pocket. The hardest storm cannot blow out this light, nor can your fingers become too cold to operate it. A brilliant light instantly, without noise or delay, just press the button. Safe in the stable or hay loft where lamp or candle would be dangerous. Price, \$2.00. Good for 5,000 flashes; then a new battery for 30 cents. *Send for Catalogue.*

American Electrical Novelty and Mfg. Co.
 Dept. A—Hudson & Spring Sts., NEW YORK
 Dept. H—Masonic Temple, CHICAGO

Small Profits—Quick Sales

TROUT FLIES

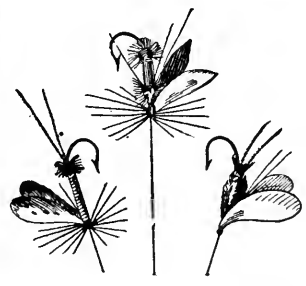

for trial—send us

- 15c for an assorted sample doz. Regular price, 24 cents. **Quality A Flies**
- 30c for an assorted sample doz. Regular price, 60 cents. **Quality B Flies**
- 60c for an assorted sample doz. Regular price, 84 cents. **Quality C Flies**
- 60c for an assorted dozen Regular price 84 cents. **Bass Flies**

SPLIT BAMBOO RODS

Fly Rods 10 feet, 6 ounces **57 cents** Bait Rods 9 feet, 8 ounces

With cork grip and extra tip, in wood form

Try our new Braided Silk Enameled Waterproof

METAL CENTER LINE

Size No. 5, 4½ cents per yard. Size No. 4, 5½ cents per yard Put up in 10-yard lengths connected.

THE H. H. KIFFE CO.
 523 Broadway, New York City
 Catalogs of any of above goods free on application.
 Mention RECREATION.

IT NEVER FAILS

The S. & W. Artificial Bait

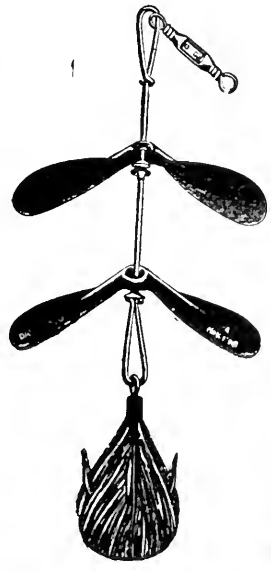

Is the most successful bait made.

When in motion it resembles a minnow so closely that it never fails to delude the fish.

Its construction makes it almost impossible for a fish to strike and not get caught.

A GREAT SELLER

Do you fish? Buy one. You will never be without one afterward. Why? It will catch fish. Can be used with rod or hand line.

Dealers send for illustrated booklet and get our prices.

If your dealer cannot supply you, send 50c. at once for one (post paid) to

STARK & WECKESSER
 57 S. Main St. DAYTON, OHIO, U. S. A.

Latest patent and Improved Canvas Folding Boat on the Market.



Puncture proof. Tempered steel frame. No bolts to remove. Folds most compact of any boat made.

THE
Latest, Safest,
AND
Best Canvas Boat

Is what we offer you. A Boat built on modern lines that will prove a pleasure to own and use. Selected materials used throughout, and it comes to you **guaranteed** the best. A handy and safe boat for fishing and shooting. Write for descriptive circular and catalog.

Mention RECREATION.

**LIFE SAVING
FOLDING CANVAS BOAT
COMPANY**

Kalamazoo, Michigan

MULLINS' GALVANIZED
STEEL PLEASURE **Boats**

New designs. Low in price. No Caulking. Durable, Clean, Safe

THE BEST FAMILY and LIVERY BOAT MADE

W. H. MULLINS

228 Depot Street,

Salem, Ohio



15 foot Boat as shown, crated.
Price, \$29.00

Send for our
New Catalogue

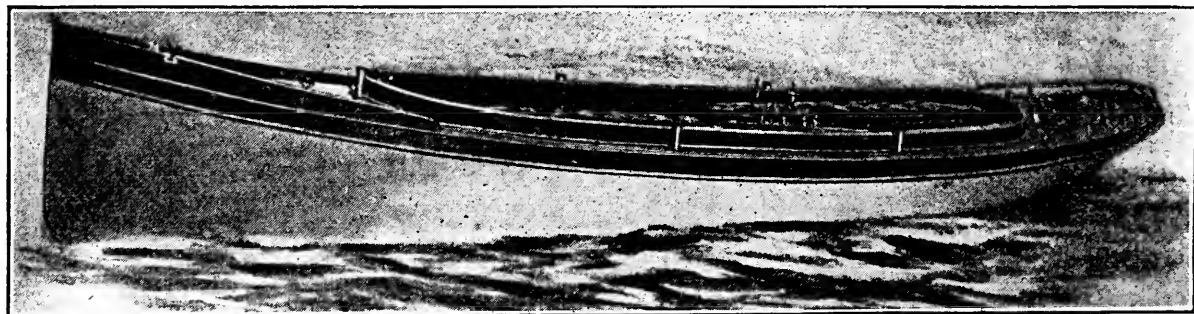

LEAMAN BOAT COMPANY
WINNECONNE, WIS.

Manufacturers of Gasoline Launches, Sail, Row and Hunting Boats. Our prices are low, our work guaranteed. Launches, \$150 up. Row Boats, \$22 up. Hunting Skiffs, \$20 up. The oldest Boat Company in the State. Write for Wants. Mention RECREATION.

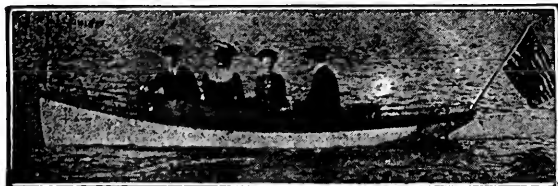

**Truscott Yachts, Launches, Tenders,
Row Boats and Canoes.**

Marine Motors, both two and four cycle, 1 to 40 H. P. Send stamps for complete illustrated catalog and tell us your wants.

TRUSCOTT BOAT MFG. CO., St. Joseph, Mich.

AGENCIES IN ALL PRINCIPAL CITIES.

ATTENTION BASS FISHERMEN!!

What It Is. A Bass lure combining all the good points of the old fashioned spinner baits with the construction of the modern wooden minnow.

What It Will Do. This lure is constructed in a new manner with a new feature and will catch more bass than any other artificial lure.

How To Get It. Send one dollar to Recreation for a year's subscription to be credited to my account and I will mail you one postpaid. **W. B. HAYNES, 374 Park Street, Akron, Ohio,**

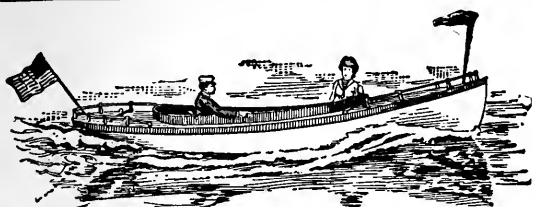

BULLARD STEEL LAUNCHES, ROW AND PLEASURE BOATS, ARE EVERLASTING!

Safer than wood; have greater carrying capacity; always dry; no bolts or nails to rust.

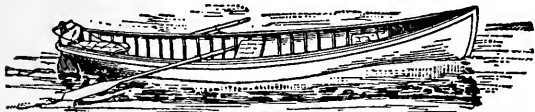

Boat Liveries equipped with the Bullard Steel Boats. Always have dry boats, that last a lifetime.

STEEL BOATS CHEAPER THAN WOOD.

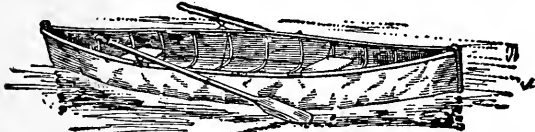

THE OSGOOD FOLDING CANVAS BOATS

Original Canvas Boat; made for 30 years. Sold all over the world; used by U. S. Government; best Fishing and Hunting is where there are no boats, take one with you in trunk or bag. Non-puncturable. Folded or extended in one minute.

Send for catalogue illustrating all improved popular designs of Steel, Wood, and Canvas Boats, and Marine Engines.

MICHIGAN CONSOLIDATED BOAT CO., LTD.
505 Main St., Battle Creek, Mich.

WANT A REEL?

You can get one for nothing.
Or at least for a few hours' work.

Send me

15 Yearly Subscriptions

to

RECREATION

and I will send you

A TALBOT REEL

Listed at \$20.00

Made by W. H. Talbot, Nevada, Mo.

This is one of the finest pieces of fishing tackle ever made. It is built like a gold watch. Equal to any Kentucky reel you ever saw.

**In Tournaments, Always a Victor
Among the Angler's Treasures, Always the Chief**

I have but a few of these reels in stock and this offer will be withdrawn as soon as the present supply is exhausted.

Sample copies of RECREATION for use in canvassing furnished on application.

RUSHTON CANOES

Best for the Money.

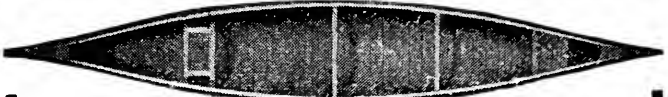

Indian Girl
Model



15, 16, 17, 18
Feet

Northern White Cedar, Canvas Covered \$30 to \$43

My canvas-covered canoes have clear white cedar ribs and planking; elm stems, inwales, gunwales, decks, thwarts, seat frames and gratings are of selected ash, oak or cherry. The canvas is covered with two coats of special filling, two of color and one of varnish.

The "Indian Girl" is beyond a doubt the most attractive canoe model ever offered.

29 years' experience and a world-wide reputation guarantee quality.

Write for my complete catalogue of pleasure boats, canoes and fittings—sent FREE.

J. H. RUSHTON, 817 Water St., Canton, N. Y.

FAY & BOWEN

Motors & Launches

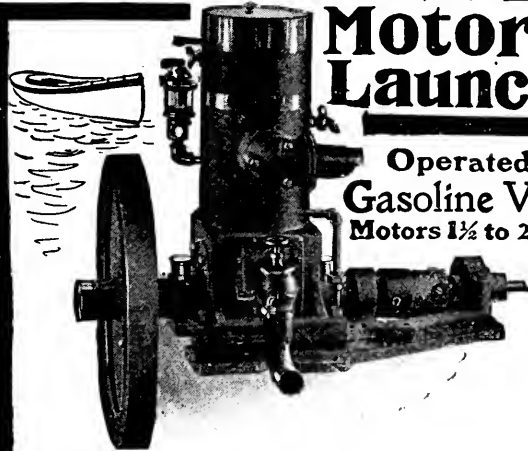

Operated by
Gasoline Vapor
Motors 1½ to 25 H.P.

THE Fay & Bowen Marine Motor is a revelation to those who have used others. Reliable, safe, durable and easy to operate. Remarkable speed control. Best of all, it starts when you start it. No handle or crank is used. Our patent igniter is absolutely unique and always instant and positive in action. It is really the only perfect and satisfactory igniter.

Motors complete from 1½ to 25 H. P. ready for installation. We also build handsome launches with motors installed and ready to run.

Send for Catalogue.

Fay & Bowen,

28 Mill Street,

Auburn, N. Y.

Fisk's Aerating Minnow Pail



The only Minnow Pail in which Minnows can be kept alive indefinitely.

Has an air chamber at the bottom holding 260 cubic inches of condensed air forced in by the Air Pump attached, and by a simple rubber attachment the air is allowed to escape into the water gradually, supplying the fish

with the oxygen consumed by them. One pumping is sufficient for ten hours.

Height, 1 foot; diameter, 10 inches; weight, 7½ lbs.; water, 2½ gallons; keeps 50 to 150 minnows, according to their size.

**IT KEEPS THEM ALIVE
Price, \$5 Net—Sold Direct**

Send for circular Mention RECREATION

J. M. KENYON & CO.
214 Twelfth St., Toledo, Ohio, U. S. A.

\$1,000.00

Worth of Enjoyment

For \$1.00

We offer you the following

High Grade Fishing Outfit

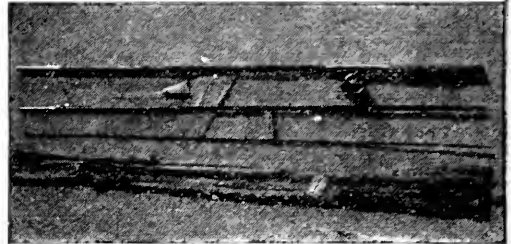

composed as follows:

- 1 3-joint split bamboo (fly or bait) rod with cork butt, wound with silk, solid metal reel base and nicked trimmings.
- 1 reel holding 75 feet of line.
- ½ dozen assorted snelled hooks for trout or bass,
- 1 dozen assorted flies for trout fishing,
- 1 3-foot gut leader,
- 2 dozen split shot for sinkers, and
- 1 canvas carrying case for rod.

Ready to ship for **\$1.00**. Cannot be purchased elsewhere for less than **three times the amount**. The use of this will give you more **HEALTHFUL ENJOYMENT** than you could purchase for **\$1,000.00**. Don't DELAY; SEND for an outfit TO-DAY. Write for our catalogues of Photo Goods and Specialties.

NATIONAL SPECIALTY CO.
13 West 27th St., New York

Looking for

Fishing Tackle?

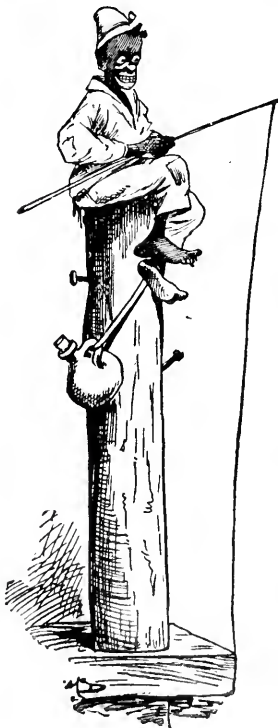

If so, write us for catalogue and price list. We publish the most complete book of this kind ever put out. We list and illustrate in it about everything that an angler ever needs on a fishing trip.

And we sell the goods as low as high quality goods can possibly be sold.

Every angler in the United States should have a copy of this book for ready reference.

Write for it. We will do the rest.

WM. MILLS & SON
21 Park Place, New York

THE HILDEBRANDT SPINNER

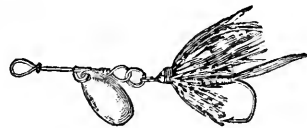

For Fly Fishermen. A spinner which spins, and also catches fish. Strictly hand-made and of the best material. No swivel required. Made with all kinds of Feather and

Buck-tail flies. For sale by dealers. Sent on receipt of 25c.

J. J. HILDEBRANDT, Logansport, Ind.

FREE To each person sending me \$1 (P.O. Money order) for one year's subscription to RECREATION, I will send his choice of the following.

A Genuine Briar Pipe with Genuine Amber Bit, or a Braided Leather Dog Whip with snap on end, or a Polished Steel Dog Chain with swivels, snaps, etc., or a MacMillan Shell Extractor for any size of shell from 8 gauge to 22 caliber, or a Pocket Compass, 1 in. dial open face, watch shape, with ring handle, bevel crystal.
EDWARD S. ADAMS, Box 536, Manchester, N.H.

Do you enjoy big game hunting?

Or Trout Fishing?

Or Mountain Climbing?

If so, write us and we can accommodate you.

We keep 65 head of horses. We employ a full corps of experienced guides, packers, and cooks.

We have a complete outfit of riding saddles, pack saddles, tents, stoves, cooking utensils, tableware, and everything necessary for touring and camping in the Mountains.

We live at Banff. The Eastern gateway of the Canadian Rockies.

And can send you anywhere you may wish to go from this point

North, East, South or West.

Address: BREWSTER BROS.
Banff, Alberta, Canada.

FOLDING CANVAS BOATS were not satisfactory until the

KING

was produced. It's a revelation in boat construction, nothing like it ever



11-foot Special

made. *Nonsinkable. Can't tip over. Puncture Proof*, wear longer than a wooden boat. No repairs. No cost for storage, always ready, folds into a small neat package, carry by hand, used by the U. S. Navy. They are simple, wonderful. A thoroughly patented article. Beware of imitations. Made only by ourselves. *A catalog of 70 engravings and 350 testimonials sent on receipt of 6 cents.*

Bottom Boards rest on the frame not on the canvas, ribbed, longitudinally and diagonally. They are *stiffer and safer* than

a Wooden Boat because the lines are fuller, and are much easier to row or paddle.

KING FOLDING CANVAS BOAT CO.

Mention RECREATION.

KALAMAZOO, MICH., U. S. A.

D.M. TUTTLE CO. 10 PINE STREET CANASTOTA, N.Y. **CATALOGUE FREE.**
BREAK SPARK. GASOLINE ENGINES & LAUNCHES. JUMP SPARK.

OST—\$10,000 Is YOUR Bank Account Safe ?

By a New York Business Man on Raised Checks.

Our booklet, "THE SEAL OF SECURITY," is full of things you ought to know about check raising and check protection. A postal card brings it—why not send for it to-day—this minute?

Not unless your checks are stamped by the PROTECTOGRAPH, which impresses lines like this
NOT OVER FIVE DOLLARS \$5\$
 indelibly and unalterably. This is the machine used by the U. S. Government and by 10,000 bankers and others to protect their checks.

G. W. TODD & COMPANY, Manufacturers, 19 Exchange Street, ROCHESTER, N. Y.

PALMER

Gasoline Engines and Launches

LAUNCHES IN STOCK

17 ft. 1½-H. P. Engine \$195 20 ft. 3-H. P. Engine \$300
 25 ft. 5-H. P. Engine \$500

These boats are built of the best cedar and oak obtainable, and are copper fastened throughout.

Manufactured by

PALMER BROS., - Cos Cob, Conn.
 NEW YORK OFFICE 136 Liberty Street

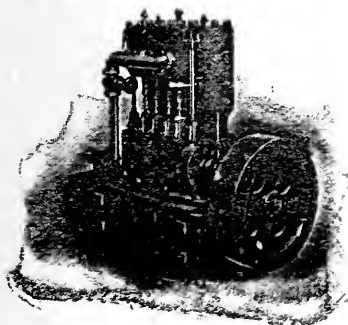

NO SOOT, SMOKE, SMELL OR TROUBLE ABOUT THE KHOTAL BLUE-FLAME KEROSENE OIL STOVE

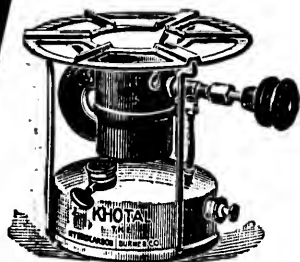

The **KHOTAL** requires no wick, is absolutely safe, light and portable. The flame is always under control and can be made to produce as much heat as gas. So simple in construction, it can be operated by a child. Never gets out of order, and is unequalled for heating or cooking. **Positively Non-Explosive.** Can be used under cover or in the open air.

MADE IN DIFFERENT SIZES

SUITABLE FOR CAMP, CANOE, YACHT OR COUNTRY HOME

Our new illustrated catalogue mailed free to any address upon request.

KHOTAL BURNER COMPANY
197 FULTON STREET, NEW YORK CITY

No. 200-a
Weight 4 lbs. Price, \$3.75



Music Boxes

For the Home, it is company at all times, will cheer you when you are sad; a veritable need when you are lonely; an accompaniment to your song, and play **Dance** music in **perfect time**. A boon to all music lovers. Our variety is great; prices to suit all. Our No. 20 costs only \$2.50, while our No. 191 runs in the hundreds. Complete Catalogues FREE.

E. L. CUENDET, 7 Barclay St., New York

FISHING. — Black Bass and Salmon.

Illustrated Guide with Maps of the

RIDEAU, BEVERLEY & CHARLESTON LAKES, free

Apply to E. A. GEIGER, Sup't
Brockville, Westport & S. Ste. M. Ry., Brockville, Ont.

S L E E P

IS TIRED NATURE'S
SWEET RESTORER

After a hard day's tramp, you
must have

A GOOD NIGHT'S REST

in order to fit you for the next
day's work.

Better to sleep on a good bed
without your dinner, than sip at
a banquet and then sleep on the
cold, hard, wet ground.

You can get

A Recreation Camp Mattress

of rubber, with valve for inflating,
made by the Pneumatic
Mattress Co. and listed at \$20

For 20 Yearly Subscriptions
to **RECREATION**

Send for Sample Copies

Address **RECREATION, 22 W. 24th Street, New York**

Polo and Saddle Ponies

Thoroughbred Dogs and Poultry

VALLEY FARMS - - SIMSBURY, CONN.

To **RECREATION** Readers: I am organizing a club of subscribers for **RECREATION**, with a view to securing a premium, and I submit this offer; to each person sending me \$1 for yearly subscription to **RECREATION**, I will send a 25c. Dominion of Canada bank note. There are but a few of these in circulation and I have succeeded in collecting a number of them. These are interesting souvenirs and are especially valuable to persons who are making collections of coins or other curios. Walter Legare, 518 John St., Quebec, Can.

Sportsmen Wishing to Hunt in Mexico are requested to communicate with me. Am located in the heart of the great mountain region of Chihuahua, Mexico, where bear, deer, mountain lions, jaguars, lynx, etc., are plentiful. Quails, turkeys and ducks abundant. Am prepared to outfit and guide hunting parties. Have plenty of horses, buckboards and wagons. Have a comfortable lodge where sportsmen, ladies and gentlemen may be provided with all the comforts of camp and ranch life. Satisfactory references given. Address J. H. Uhle, Colonia Pacheco, Chihuahua, Mexico.

Wanted:—Position as game keeper or manager of game preserve. Am a special game protector for St. Lawrence Co., appointed by the Board of Supervisors, and have had 15 years' experience in the Adirondacks as guide, hunter, etc. Address, S. G. B., Richville, St. Lawrence Co., N. Y. Box 83.

SOLAR LAMPS

"SHOW THE WAY"

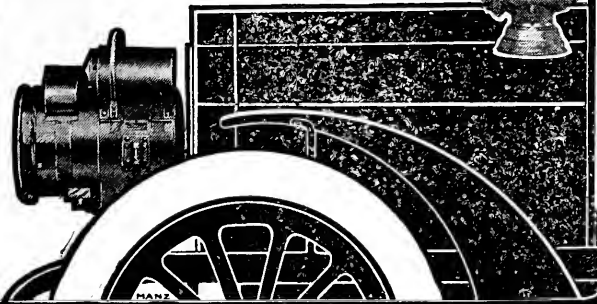

WE make a score of styles and models of GAS and OIL SIDE LAMPS, HEAD-LIGHTS and TAIL-LAMPS which are scientifically and substantially constructed, in operation simple, safe and satisfactory, and suitable for all styles and makes of motor cars.

Write for new catalogue.

BADGER BRASS MFG. CO.
KENOSHA, WIS.

Eastern Branch { No. 11 WARREN ST.
NEW YORK CITY.

\$26⁵⁰



With top \$33.50

BUYS
A
BUGGY

SAVE DEALERS PROFITS

The immense volume of our business and the vast number of satisfied customers on our books prove we can serve your interests best.

We manufacture a full line of Buggies, Carriages, Wagons and Harness of very superior

**Quality—Style—
Durability and Finish**

These four essentials are to be found in every vehicle and set of harness sent out by us. We employ only skilled mechanics in all departments and furnish them with the very best materials. This fact together with our plan, which unites the interests of the consumer and the manufacturer, enable us to give you the greatest value for your money.

With the entire output of two enormous modern factories and superb shipping facilities at our disposal, we are able to furnish high-grade vehicles at prices that—quality considered

Positively Defy Competition.

All goods guaranteed and shipped on approval. Money back if you are not satisfied.

Write at once for our catalogue and special inducement, it will interest you.

UNION BUGGY COMPANY,
1495 Saginaw Street, Pontiac, Mich.

The CADILLAC

Up the
Steps of the
National Capitol

The Cadillac is a wonderful hill climber, taking grades with high gears that some machines of twice the horsepower can not negotiate even at low speed. The feat of climbing the steps of the Capitol at Washington—an almost prohibitive grade—is evidence of not only great power, but indicates a marvelous control.



The Cadillac is the automobile that solves the problem of safe, rapid and agreeable motor travel under all conditions of road and weather. Most powerful engine; most sensitive steering device; most reliable brakes; most flexible running gear—strong and graceful body.

Runabout \$750.

**With tonneau seating four,
ALL FACING FORWARD,
\$850. Buggy top, \$30.**

Our free illustrated booklet K gives address of agency nearest your home where the Cadillac may be seen and tried.

CADILLAC AUTOMOBILE COMPANY,
Detroit, Mich.

Newhouse Traps

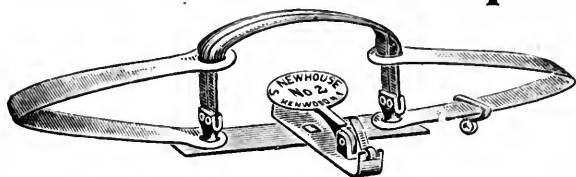

THE STANDARD FOR OVER FIFTY YEARS

Used by all professional hunters and trappers,
who find that

The Best Trap is the Cheapest

Complete illustrated catalogue on
application.

ONEIDA COMMUNITY, LTD., Kenwood, N. Y.



“Collan-Oil”
preserves leather and
renders shoes and
harness positively.

WATERPROOF
Used by the U. S.
the Army and Navy,
and National Guard.
Send 25c. for trial can.
AGENTS WANTED

Write for terms and circulars
J. R. BUCKELEW
Dept. A. 111 Chambers St., N. Y.

AN IMPORTANT OFFER

For 2 Yearly Subscriptions to RECREATION

I will send you

A RIFLE WICK PLUG

Made by HEMM & WOODWARD, Sidney, Ohio, 30 caliber
up to 50 caliber.

OR

A SHOT GUN WICK PLUG

20 gauge up to 10 gauge

For 3 Yearly Subscriptions to RECREATION

A Pair of Shot Gun Wick Plugs

20 to 10 gauge.

Sample copies for use in canvassing furnished on
application.

Address RECREATION, 23W. 24th St., N. Y. City

SIT RIGHT DOWN and WRITE

For the Beautiful Book

“BRUSH, STUBBLE & MARSH”

just issued by

E. I. DUPONT De NEMOURS & CO.

WILMINGTON DEL.

It will cost you but three two-cent
stamps and the name of the POWDER
you use. If it's DUPONT, it will please
us. If some other kind, then the
book may help you.

SOME GOOD GUIDES.

Following are names and addresses of guides
who have been recommended to me, by men
who have employed them; together with data
as to the species of game and fish which these
guides undertake to find for sportsmen.

If anyone who may employ one of these
guides should find him incompetent or un-
satisfactory, I will be grateful if he will report
the fact to me.

ALASKA.

Edwin Edelman, Kenai, Cook's Inlet, moose,
bear, caribou, mountain sheep, ducks, grouse
and trout.

FLORIDA.

Carson Bros., Frostproof, bear, deer, turkeys, quail,
snipe.

C. H. Stokes, Mohawk, deer, alligators, turkey,
quail, and snipe.

IDAHO.

John Ching, Kilgore, elk, bear, deer, antelope,
mountain sheep, trout and grouse.

Chas. Petty's, Kilgore, ditto.

MAINE.

H. R. Horton, Flagstaff, deer, bear, moose, cari-
bou, fox, grouse and trout.

W. C. Holt, Hanover, moose, caribou, deer, grouse and
trout.

MONTANA.

A. R. Hague, Fridley, elk, deer, mountain sheep,
bear, grouse and trout.

NEW YORK.

Le Roy Still, Bayport, Long Island, ducks, quails,
rabbits and grouse.

WYOMING.

S. N. Leek, Jackson, elk, bear, deer, mountain
sheep, antelope, grouse and trout.

James L. McLaughlin, Valley, elk, bear, deer,
mountain sheep, antelope, grouse and trout.

CANADA.

Wm. S. Andrews, Lillooet, B. C., deer, bear,
mountain sheep, goats, grouse and trout.

B. Norrad, Boiestown, N. B., moose, caribou,
grouse and trout.

Carl Bersing, Newcastle, N. B., moose, caribou,
deer, bear and grouse.

Big Game Hunters

FISHING AND OUTING PARTIES

Before planning trips other than in New Brunswick,
should apply to

The New Brunswick Guides Association

Fredericton, New Brunswick, Canada,

for information. The Association comprises the leading
and most reliable guides in the Province.

Hunting Map of New Brunswick

Showing rivers, lakes, portage roads, car-
ries, etc. Scale, $4\frac{1}{2}$ miles to the inch, and
folded to suit pocket. Mailed to any address
on receipt of price, \$1.50. Checks accepted.

FRANK WHITEHEAD,

Fredericton, New Brunswick,

P.O. Box 303

Canada.



INDIAN CURIOS

WHOLESALE & RETAIL
CURIO DEALERS'
SUPPLY DEPOT.

Bead Work, Baskets, Elk Teeth, Mexican
Goods, Fossils, Minerals, Arrow-Heads,
Pottery, Alaska Ivories, Shells, Agates,
Photos, Great stock, Big Cata. 5c., stamps.
Mention RECREATION. If a dealer, say so.

L. W. STILWELL

DEADWOOD SO. DAKOTA



10c.

SEND
FOR
IT**"Haunts of the Hunted"**

Published by the

Bangor & Aroostook R. R.

*Entirely new Guide book for 1903,
descriptive of Northern Maine.
Book of 200 pages, finely illust-
rated by more than 100 half-tone
cuts and with two full pages
in colors. Write to Dept. H
and enclose 10 cents in stamps.*

GEO. M. HOUGHTON,
Traffic Manager
BANGOR, ME.

"A sublime spectacle"

NIAGARA
FALLS

One of the natural wonders of the world. A charming place at any season of the year, reached from every direction by the

NEW YORK CENTRAL LINES

A visit to the Falls is an object lesson in geography: an exhibition of landscapes that no painter can equal, and a glimpse of the latest developments of the industrial world.

A copy of Four-Track Series No. 9, "Two-Days at Niagara Falls," will be sent free, postpaid, to any address on receipt of a two-cent postage stamp, by George H. Daniels, General Passenger Agent, New York Central & Hudson River Railroad, Grand Central Station, New York.

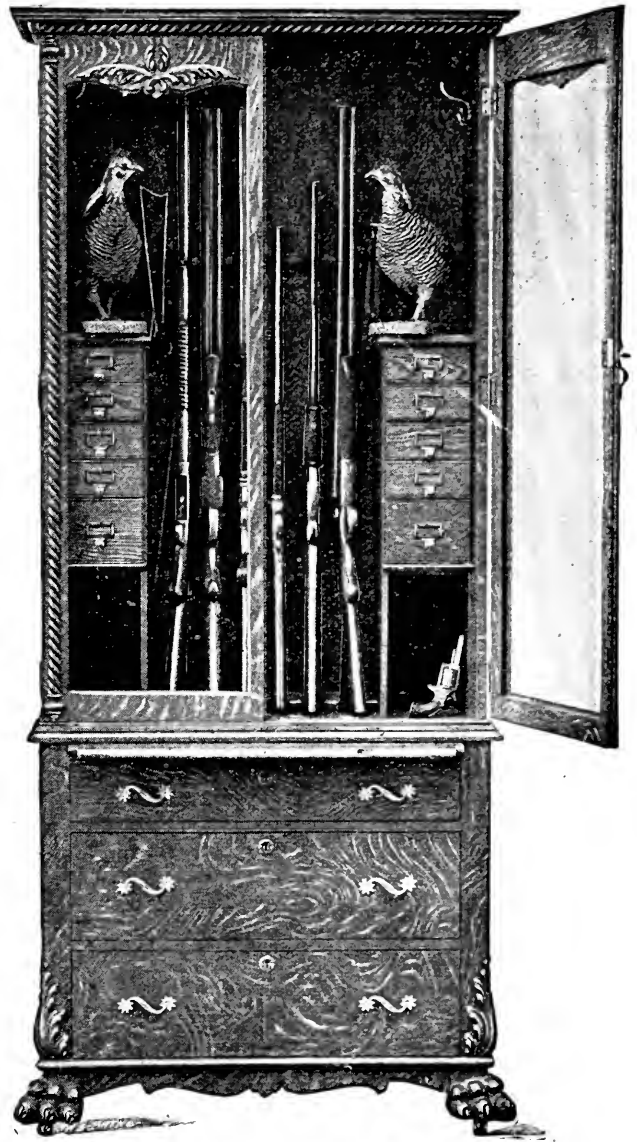
You Need This**If you see one, you'll buy it.**

To fully appreciate the convenience of a sportsman's cabinet, you must have one in your home. Up-to-date sportsmen want their guns, ammunition, etc., handy. You wouldn't believe how ornamental a cabinet is till you see one with your outfit nicely arranged in it. We are selling them to the most noted sportsmen in every state and territory in the United States and you should be on our list too.

We make cabinets from \$17.50 to \$48.00.
Send stamp for descriptive catalog.

West End Furniture Co.,

SOLE MFRS. AND PATENTEES®

WILLIAMSPORT, PA.

"NOTHING SO RARE AS RESTING ON AIR."



TAKING MINE EASE.

The only article in your outing outfit that you can use during the whole year is a

Pneumatic Mattress

OR CUSHION

THE EVER PRESENT ROOT

in the bed of boughs is a thing of the past if you use a Pneumatic Mattress. A mattress for home use that you can deflate, pack in your grip and take with you into camp.

SPRUCE BOUGHS

may make a fine bed. But the genuine Sportsman prefers a Pneumatic Mattress because he knows he can do three times the tramping the day following a night's good sleep.

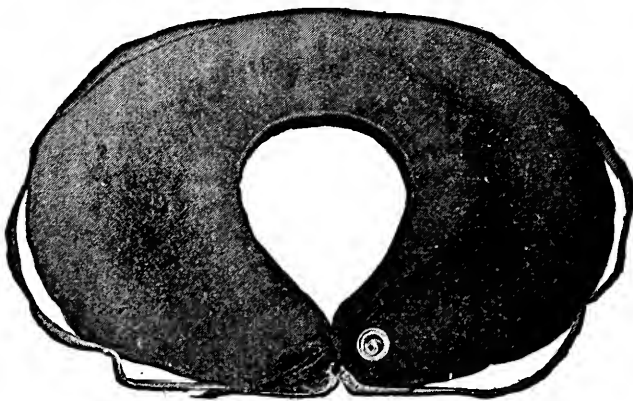

PRICE \$2.00

Carry it in your Pocket, it weighs just One Pound.

Swimming Collar.

Worn around the neck, leaving the arms free for action. Will support a full-grown man. Just the thing when learning to swim.

Price, Small Size, \$1.50 Large Size, \$2.00

Sportsman's Cushion

A Yoke to save your shoulders

A Swimming Collar for those who can't swim.

A Life Preserver in case of accident.

A Cushion while waiting for Moose.

A Cushion or Head Rest while waiting for Duck.

A Protection for your shoulder if the gun is heavy.

A Cushion for CAMP, BOAT, OFFICE or HOME.

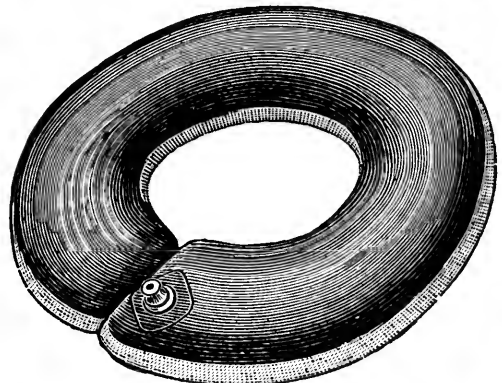

Swimming Collar.

Pneumatic Mattress & Cushion Company,

2 R South Street, New York City.

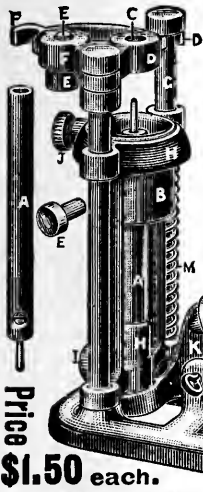

THE IDEAL "STRAIGHT LINE" RE & DE CAPPER

is the **only one** that will de-cap and re-cap properly, **all** Shot Gun Shells with a central fire hole, Brass or Paper, Domestic or Foreign make, whatever the inside shape may be, **high or low base**. It will seat any and all sizes and shapes of primers, **straight** in the pocket of the shell, **positively all the same depth**, without concaving the head, or disturbing the fulminate which causes misfires. Send us six cents in stamps for **HAND BOOK No. 15**, giving full information of New Goods and much new matter of interest to shooters. Address,

IDEAL MANUF'G CO., 12 U St., New Haven, Conn., U. S. A.

THE PHIL. B. BEKEART CO., of San Francisco, Cal., Agents for Pacific Coast.

When you write please mention Recreation.

THE "BROWNIE" RIFLE

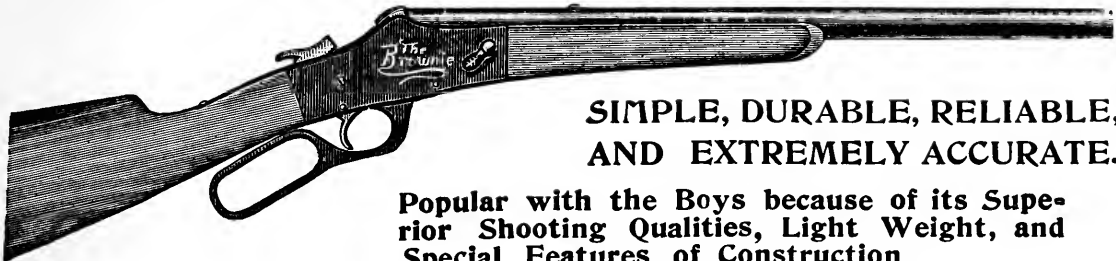

SIMPLE, DURABLE, RELIABLE, AND EXTREMELY ACCURATE.

Popular with the Boys because of its Superior Shooting Qualities, Light Weight, and Special Features of Construction

Furnished in .22 caliber only. Weight $4\frac{1}{4}$ to $4\frac{1}{2}$ pounds. It is supplied by RECREATION as a Premium. Write for Catalogue

The W. H. Davenport Fire Arms Co., Norwich, Conn.

KOENIG'S SHELL EXTRACTOR.



Every shooter should have one—carry it in a vest pocket. Fits any gauge shell. Koenig's Gun Catalogue, Free.

10 Cts. Postpaid.
E.G. KOENIG, NEW JERSEY'S LARGEST GUN HOUSE
SOUTH BROAD ST., NEWARK, N. J.

THE BRADLEY SHOT GUN SIGHT

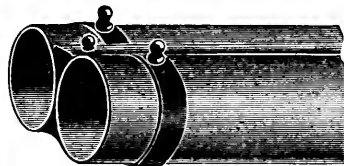

Wing Shooting is made easy and certain by using this gun sight. Scores at trap and in field greatly increased by its use. Right and left birds are bagged as easily

as straight-away birds. Price 50 Cents, Postpaid.

C. L. BRADLEY, Inventor, Clarksville, Tenn.



START the season right by owning a J. C. Hand Trap. Most convenient little trap ever made. NO need of Gun Club grounds—any vacant field will do. No pit to dig, no stakes to drive. It is always ready and does not get out of order. Weighs but 6 lbs. and is handsomely finished. Sent by prepaid express on receipt of price, \$4.



*"Ever been there
friend?"* 

**MARBLE'S
Pocket AXE**
*is the way out of
difficulties.*

*Large enough to fell
a Tree, build a Camp or to
quarter a Deer, and small
enough to go in the Pocket.*

Sold by dealers or direct from the
MARBLE SAFETY AXE CO
Gladstone, Mich., U.S.A.
Send for Catalogue 

To Sportsmen and Campers Out FREE!

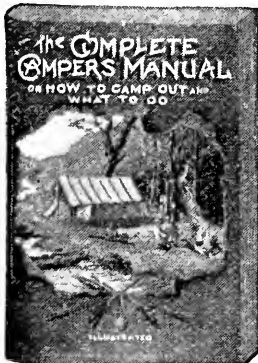

A COMPLETE up-to-date volume completely covering the subject of Camping Out and Outfits. Most interesting and useful. **124 pages, 200 illustrations.** Considered by best authorities the most practical work ever published—it covers the many subjects completely from A to Z—full of genuine facts from cover to cover. **Free to you** on receipt of 10c. coin or stamps to cover cost of mailing only—**Write at once** if you desire to secure a copy—and mention RECREATION.

"BUZZACOTT"

Complete Camp Outfitter

Dept. "A"

Racine Jct., Wis. and Chicago, Ill.

The Best is None Too Good

SHOOT

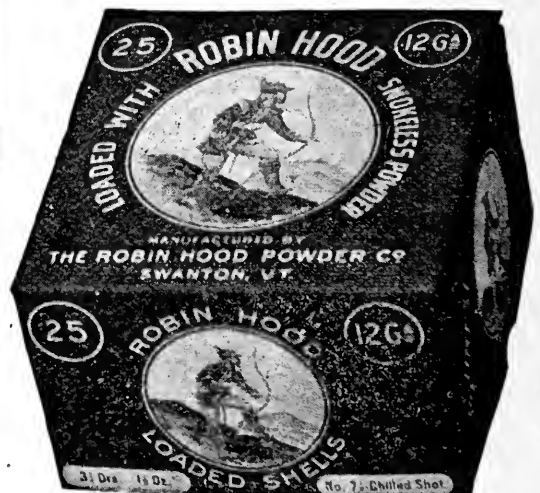

ROBIN HOOD POWDER
IN
ROBIN HOOD SHELLS

Manufactured by
The Robin Hood Powder Co.
SWANTON, VERMONT
Mention RECREATION

H. & R.
**"Bicycle
 Hammerless"
 Revolver**

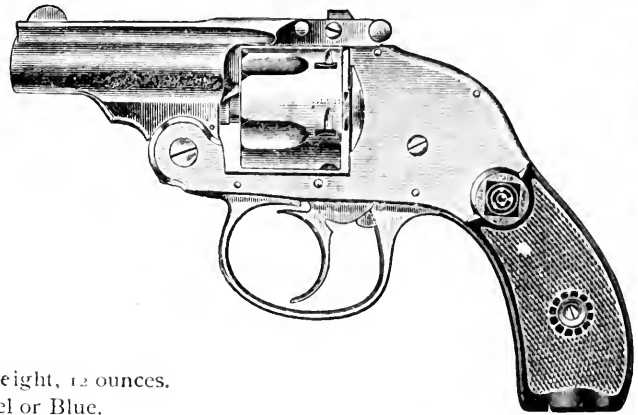

Description

32 Caliber, 5 shot. 2 Inch Barrel. Weight, 12 ounces.
 C. F., S & W. Cartridge. Finish, Nickel or Blue.

IMPOSSIBLE TO CATCH on the pocket and discharge accidentally. **ABSOLUTELY SAFE.** Although designed for cyclists, this revolver is equally adapted to all cases where a small, light weight, effective and handy pocket weapon is desired. It has small frame and automatic ejector. Sold direct where dealers will not supply.

HARRINGTON & RICHARDSON ARMS CO.

Makers of H. & R. SINGLE GUNS

Catalog for Postal
 Dept. R.

WORCESTER, MASS.

Practical Common Sense
 in 6 Sizes.

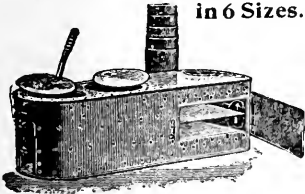

**CAMP
 STOVE**

Either with or without oven. The lightest, strongest, most compact, practical stove made. Cast combination sheet steel top, smooth outside, heavy lining in fire

box and around oven, holds its shape, telescopic pipe carried inside the stove. Burns larger wood and keeps fire longer than any other. Used by over 9,000 campers and only one stove returned.

For catalogue giving full particulars, mention RECREATION and address,
D. W. CREE, Manufacturer, Griggsville, Ill.

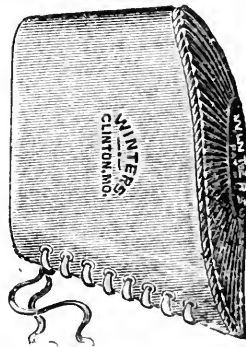

**THE
 1902 Model**

LEATHER-COVERED Pneumatic Recoil Pad is now perfect. No pump, no valve, no recoil, no flinch, no headache, no bruised shoulders, no money if not satisfactory and returned at once. **PRICE \$2.**

**J. R. WINTERS
 Clinton, Mo.**

**THE PARKER
 AUTOMATIC
 EJECTOR**

The Latest attachment to
 The **"OLD
 RELIABLE"**



New York Salesroom, Send for Catalogue. **PARKER BROS.,**
 32 WARREN ST. Mention RECREATION. Meriden, Conn.

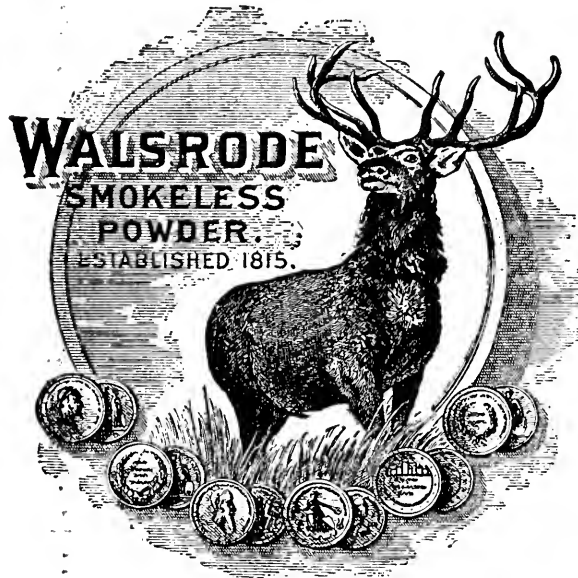

INSIST

upon your shells
being loaded with

**WALSRODE
POWDER**

the PIONEER dense
smokeless powder

Schoverling, Daly & Gales

SOLE AGENTS

302 BROADWAY, NEW YORK

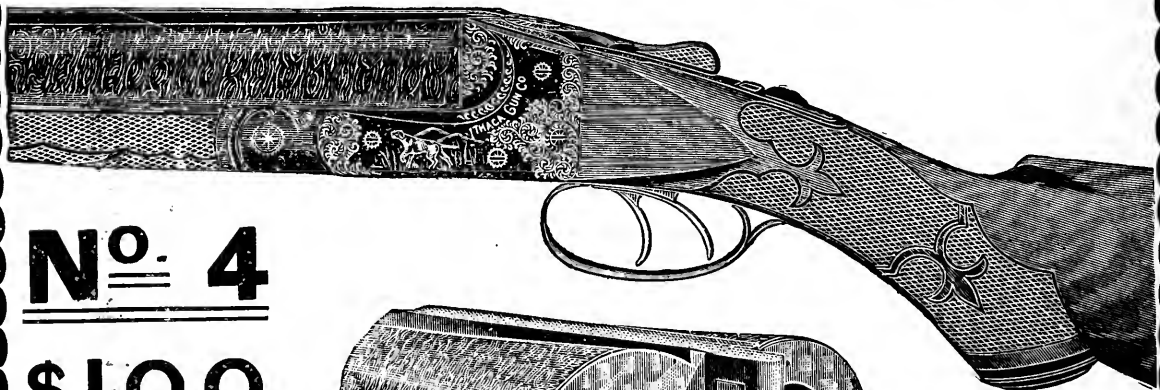

No. 4

\$100

LIST

ITHACA

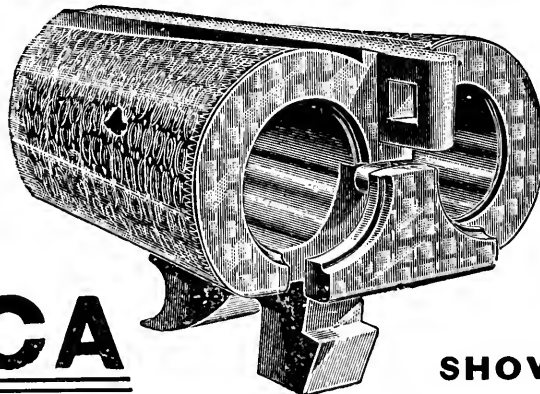

THE
**NITRO
BREECH**

SHOWING NEW
CROSS BOLT

GUARANTEED to be worth \$25.00
more than any other make
of Gun at Same Cost.

Send for Catalogue Describing Sixteen
Different Grades of Guns, Ranging in
Price from \$19.50 to \$300.

ITHACA GUN CO., Ithaca, N. Y.

Mention RECREATION.

"HOPKINS & ALLEN" Single Barrel Shot Guns

(Made for any powder and good for any shot.)

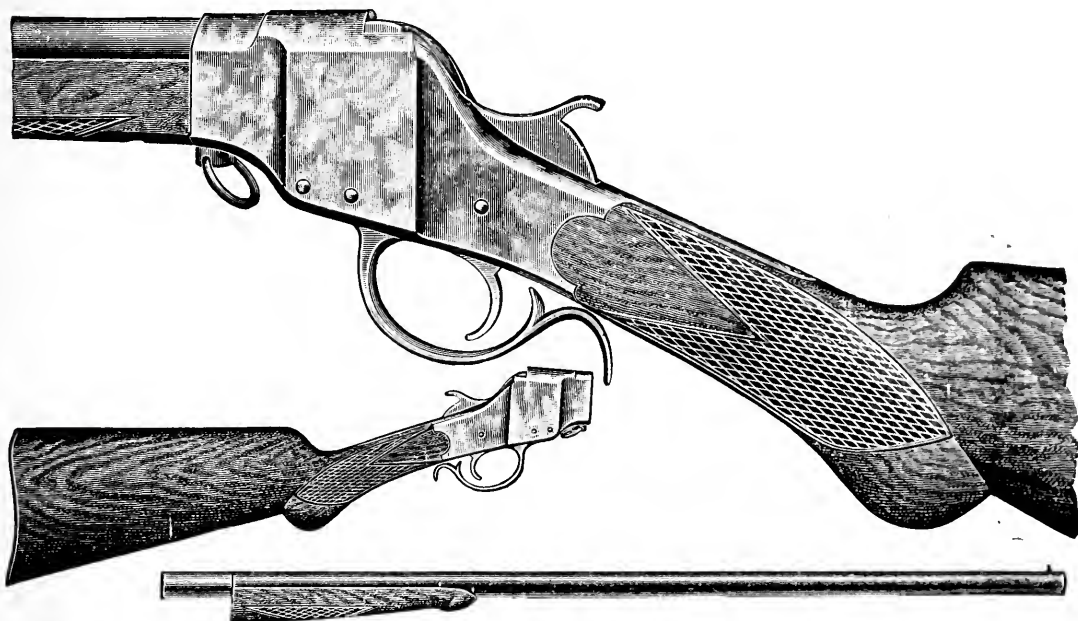

Our "Lever Action" has more friends than any single gun made, has stood the test of fifteen years' continued approval. Simple, durable and reliable, 12 and 16 gauge blued steel barrel..... **\$8.00**

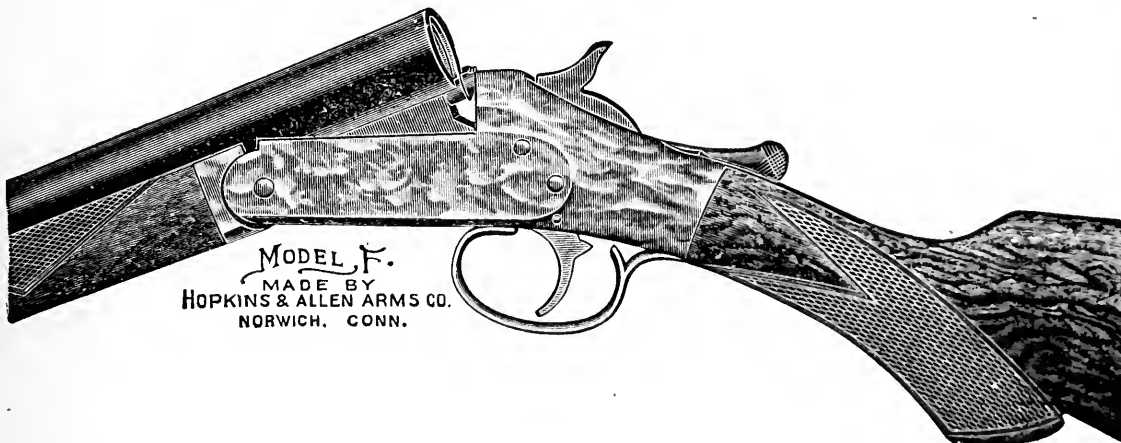

MODEL F.
MADE BY
HOPKINS & ALLEN ARMS CO.
NORWICH, CONN.

Our new model top snap action, combining all up-to-date features of a modern gun, including patent compensating snap fore end. Automatic shell ejector, **Full Choke Bored.** 12, 16 and 20 gauge decarbonized steel barrel..... **\$9.00**
12 and 16 gauge Stubbs twist steel barrel..... **\$10.00**

We will ship, all charges prepaid, on receipt of remittance with order, to any express office in the U. S. A.

The Hopkins & Allen Arms Co.,
NORWICH, CONN., U. S. A.

FINE GUNS

OUR SPECIALTY

SCOTT'S MONTE CARLO

Automatic Ejector Hammerless,

Established
1826

All the Prominent
English and
American Makes.

Also Westley Richards,
Greener, Purdy Lang, Parker,
L. C. Smith, J. P. Clabrough
& Johnstone, Ithaca, Baltimore
Arms Co, Forehand, etc

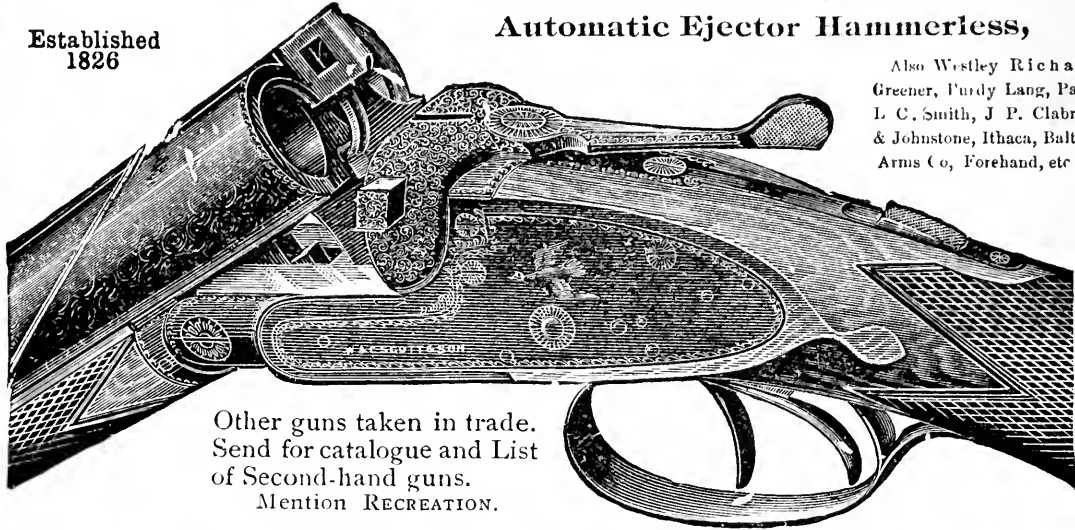

Other guns taken in trade.
Send for catalogue and List
of Second-hand guns.
Mention RECREATION.

SWEDISH LEATHER JACKETS

For Duck Shooting. Soft as Kid. Finest Quality, \$18.00

We take the entire product of the manufacturers of above Finest Jackets and this make cannot be obtained elsewhere in the United States

Gun Repairing BY FIRST-CLASS GUN REPAIRERS
RESTOCKING, BROWNING, Etc., Etc.

Send for Catalogues

WM. READ & SONS, 107 Washington Street, BOSTON, MASS.
The Old Gun House, Established 1826

We make a specialty of Featherweights
and Trap Guns with our new
SINGLE TRIGGER



Guaranteed
Perfect

Our New
Perfect
Gun Cleaner
By Mail,
30 Cents

Send stamp
for 1903 Catalogue
Mention RECREATION

D. M. LEFEVER SONS & CO.,

Manufacturers of the "NEW LEFEVER"

Not connected with Lefever Arms Co.

SYRACUSE, N. Y.

THE BAKER

THE GUN
THAT'S SAFE

SO DURABLE TOO
IT LASTS A
LIFETIME



If you want to be right up in the front rank of style and efficiency shoot one of our Special Paragons with Whitworth or Krupp fluid steel barrels. We have other patterns also that would please you. Our "Quarterly" tells about them and other matters that would interest you. We will send it to you free a year if you want it.

BAKER GUN & FORGING CO., 42 Liberty Street, Batavia, N. Y.

Guaranteed NOT to Shoot Loose.

Any
One of the **9**

“SYRACUSE”

Built for Business.

Whether Grade “OO” listing at \$30.00
or Grade “D” listing at \$475.00.

Made in
10-12-16 and 20 Gauge



HAVE the STRONG shooting qualities that has brought
the “SYRACUSE” into such PROMINENCE.

The careful INSPECTION and ATTENTION to detail
that has gained for the “SYRACUSE” the name of the
“THOROUGH-BRED”

The EXQUISITE lines The SUPERB balance
that denotes the work of the Master Crafts-man.

BUILT BY

SYRACUSE ARMS CO.,

SYRACUSE, N. Y.

“SYRACUSE CATS” are TAME CATS and yours for the asking.

Mention RECREATION.



THEY'RE MADE TO MEASURE

Putman Boots.

Go on like a glove *and* fit all over.

For a **Quarter of a Century** Putman Boots have been the Standard among Western Hunters, Prospectors, Ranchmen and Engineers (who demand the best) and we have learned through our personal contact with them **how** to make a perfect boot.

Putman Boots are in use in nearly every civilized country in the World. They are Genuine Hand Sewed, Water proof, Made to measure, Delivery charges prepaid, and cost no more than others. Send for Catalogue of over **30 different styles** of boots. Also **Indian Tanned Moosehide Moccasins**. We send with catalogue Order Blanks showing how to measure your foot.

We have in our files thousands of letters similar to the following.

GENTLEMEN:—Please send me another catalogue. We are all wearing Putman Boots and find them far superior to any other boot. I have ordered about 20 pairs for friends here during the past three years, and every pair has given perfect satisfaction, and I feel that I have done a man a favor when I have recommended your goods to him. Respectfully,

W. H. FLUKER, Gen. Mgr,
(Columbia Mining Co.)
Tatham, Ga.

GENTLEMEN:—I have just returned from a duck hunt in Colleton Co. this state, and though I tramped through the marshes for six days and a part of the nights, sinking in mud and water nearly to the tops of the shoes I got from you, my feet kept dry throughout the trip and the shoes were as soft at the wind-up as at the beginning. I can cheerfully recommend your shoes to all sportsmen. Yours respectfully,

C. F. DILL,
Greenville, S. C.

GENTLEMEN:—Was fishing through the ice on the Flathead River this week standing for hours in wet snow and slush and tramping through the mountains, and I found the boots you built for me in December to be thoroughly water and snow proof, and quite warm. Yours truly,

L. R. FOGLE, Great falls, Mont.

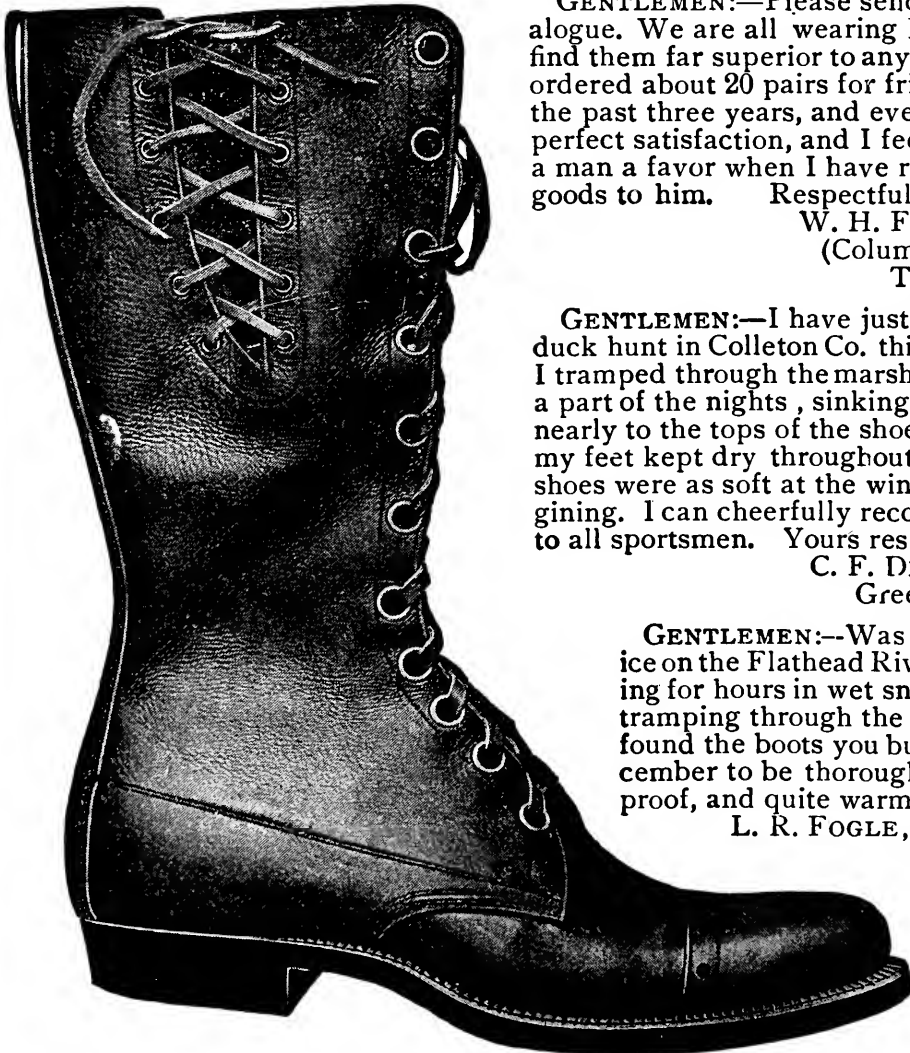

Illustration shows No. 900, 14 inch Boot, made to measure and delivered in U. S. for

\$7.50.

H. J. PUTMAN & CO.,

30 HENNEPIN
AVE.

Minneapolis. Minn.

Everybody's

1927

Blue

bears the

"Pabst"

a red

making

The

The

The

The

that

always

SAVAGE AMMUNITION



That poorly loaded ammunition will cause the most accurate rifle barrel to shoot irregularly is self evident. When you want 30-30 or .303 loads that will bring out the finest shooting qualities of your rifle ask for Savage Factory Loaded Cartridges. Each shell is stamped "S. A. Co." and stands for a close hard shooting load with slight recoil and uniform pressure. If your dealer cannot supply you, write us. Remember that a Savage Hammerless Repeating Rifle with Savage Factory Loaded Ammunition is a hard combination to beat.



Our new catalogue (G) is full of interest to sportsmen. Mailed on request.

Savage Arms Company, UTICA, N. Y.
 BAKER & HAMILTON, Pacific Coast Agents U. S. A.
 San Francisco and Sacramento, California.

OUR NATIONAL COFFEE

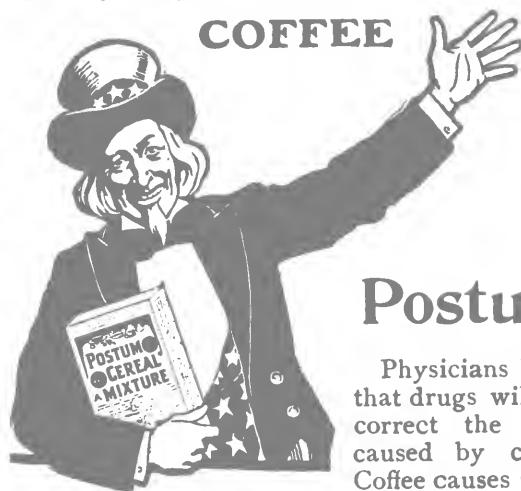

Postum

Physicians know that drugs will not correct the evils caused by coffee. Coffee causes "Our

National Disease—Dyspepsia."

The only remedy is to stop short on the coffee and use Postum Cereal Coffee in its place. A physician of Heber, Ark., says: "I have been a coffee drinker for 50 years and have often thought that I could not live without it. After many years of suffering from our national malady, dyspepsia, I finally attributed it to the drinking of coffee, and after some thought determined to use Postum Food Coffee. I soon found myself so much better I used it at all meals and I am pleased to say it has entirely cured me of indigestion.

"I gained 19 pounds in 4 months, and my general health is greatly improved." Name given by Postum Cereal Co., Battle Creek, Mich.

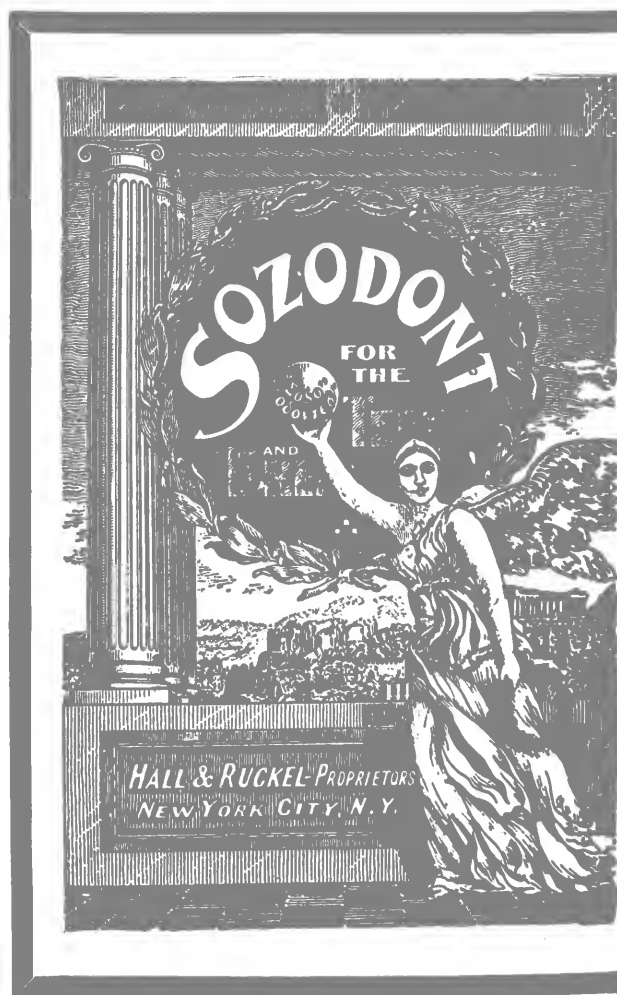

VOSE

PIANOS

have been established over 50 YEARS. By a system of payments every family in moderate circumstances can own a VOSE piano. We take old pianos in exchange and deliver the new piano in your home free of charge. Write for catalogue D and explanations.

VOSE & SONS PIANO CO., 160 Boylston St., Boston, Mass.

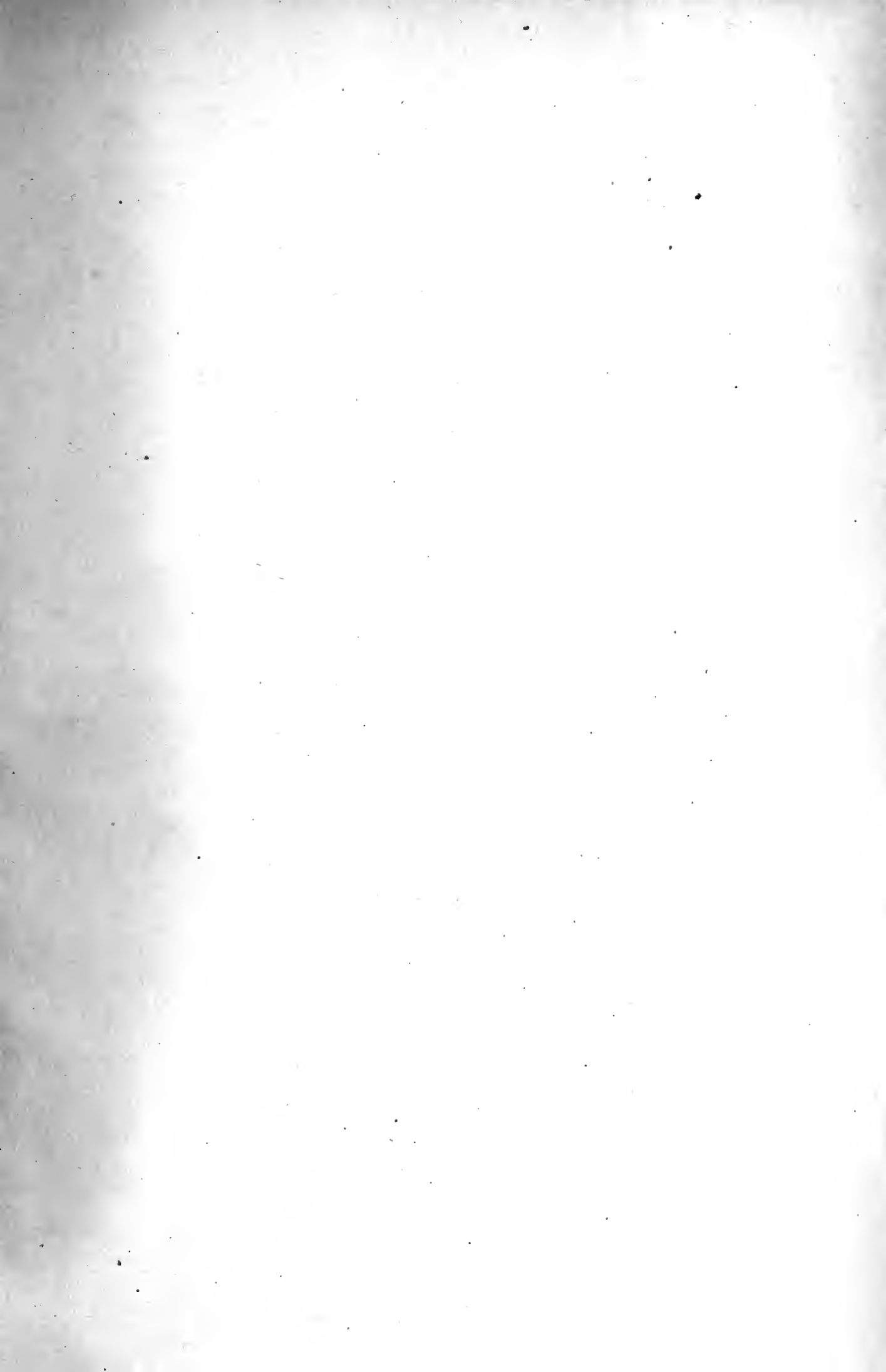



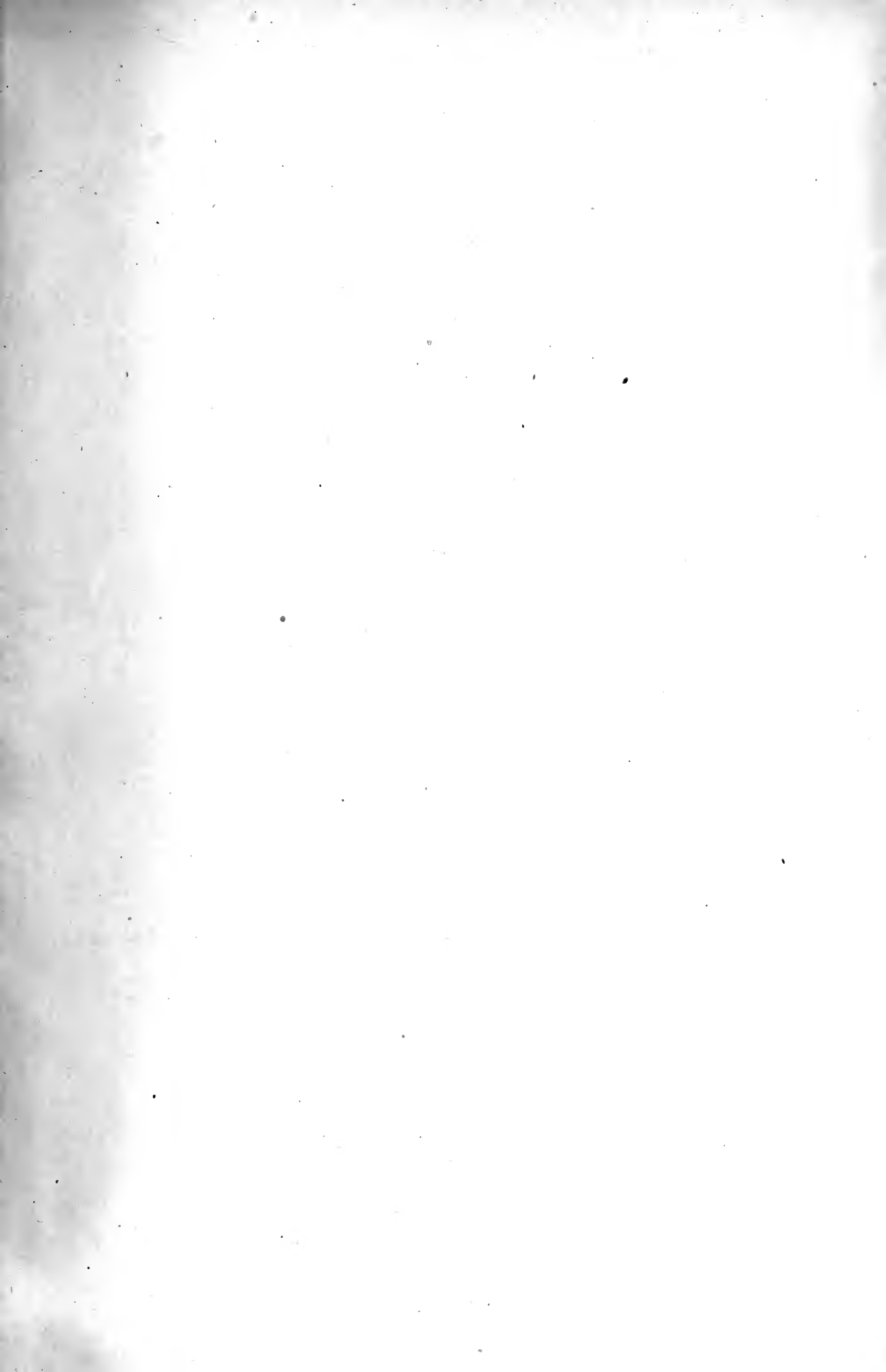



3 2044 106 226 434

